

## **Year 1**

### **Week 1**

#### **Creation**

**Scriptures: Genesis 1, 2:1-3; John 1:1-5**

#### **Key Verse:**

**Genesis 1:31 "And God saw everything He had made and behold it was good."**

#### **Key Points:**

1. God was before all and Jesus was with Him.
2. God created the world in an orderly and purposeful fashion.
3. In the first three days, God shaped the creation, and in the second three days He populated the creation.
4. Discuss the days of creation:
  - Day 1 - Day and night
  - Day 2 - Firmament - what it is, sky, divided the waters
  - Day 3 - Dry land and vegetable kingdom
  - Day 4 - Sun, moon, and stars
  - Day 5 - Fish and fowl
  - Day 6 - Beast and man
  - Day 7 - God rested
5. God very early set aside one day to rest.
6. God saw all that He had made and it was very good.



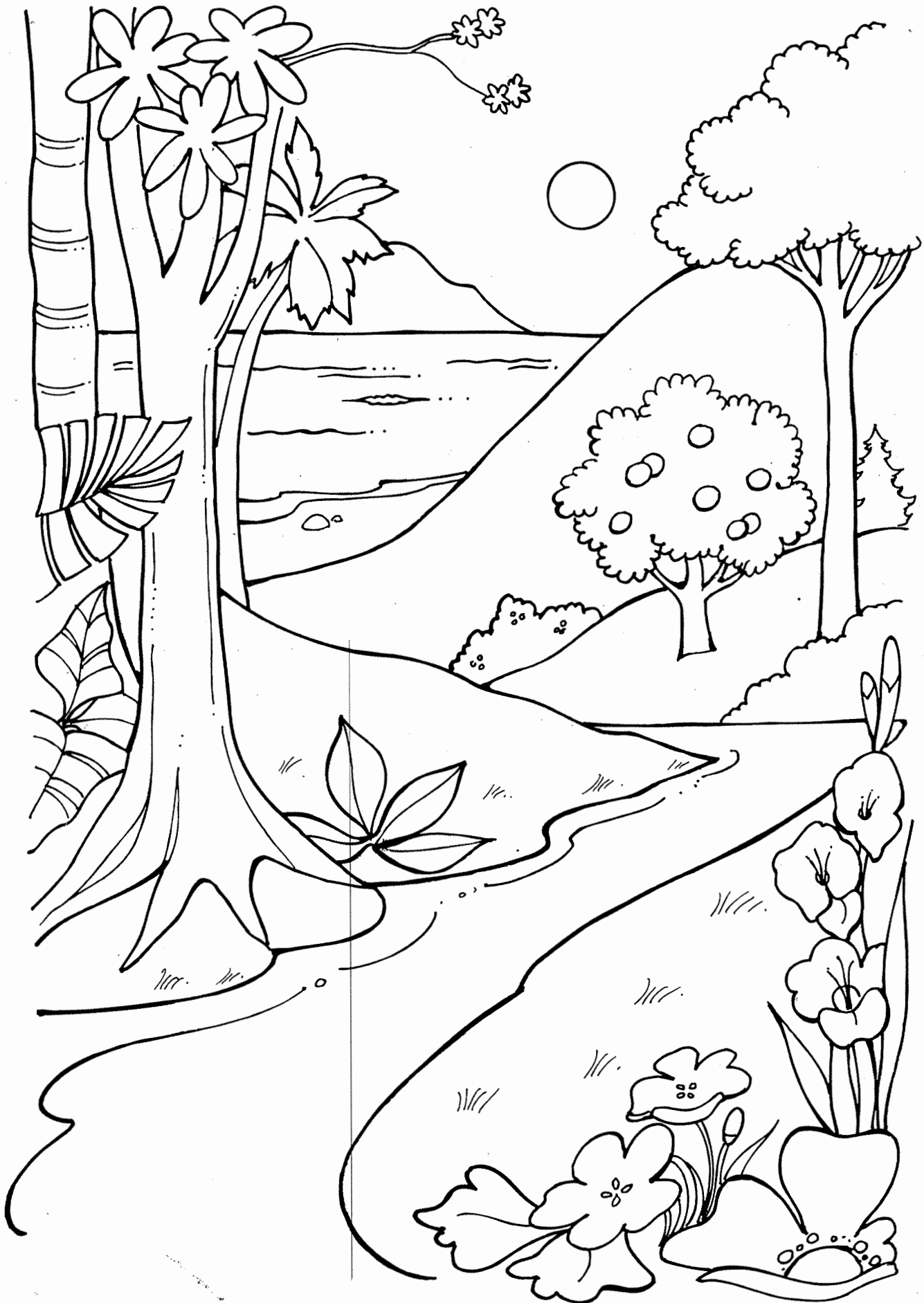

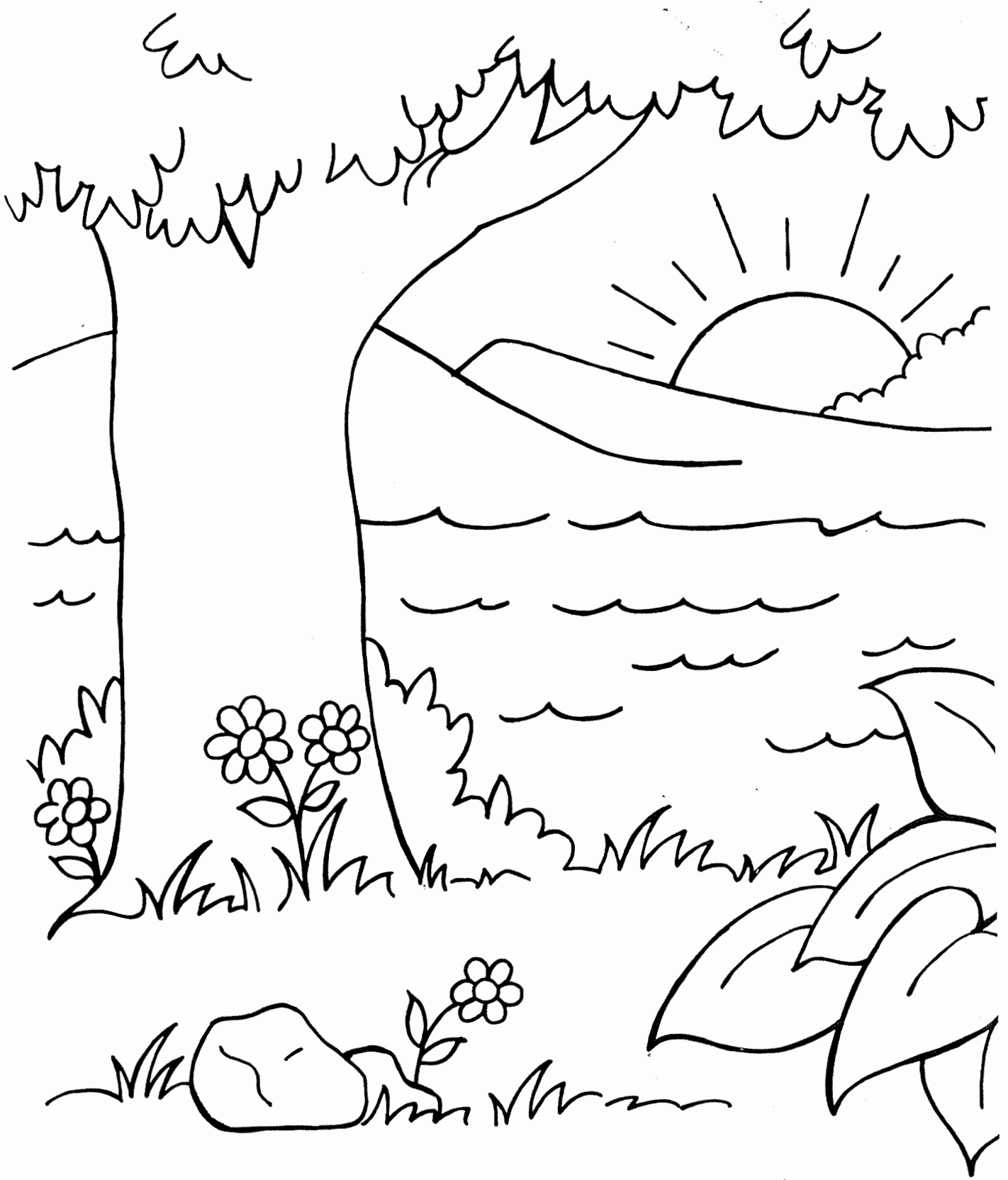

God Makes the World  
Genesis 1

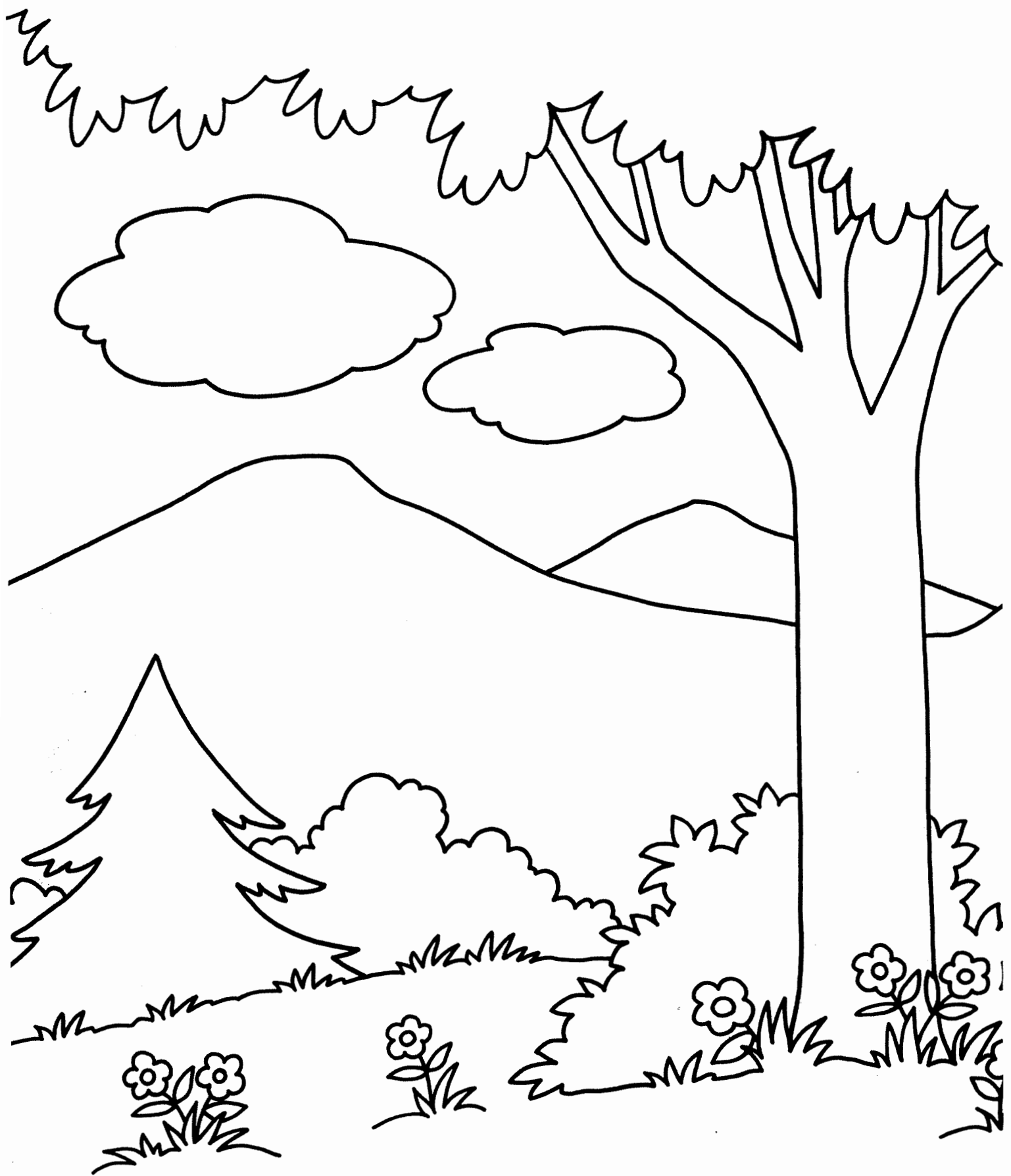

In the beginning God made the heavens and the earth. Grass and trees and flowers began to grow on the earth.

*Genesis 1:1-12*

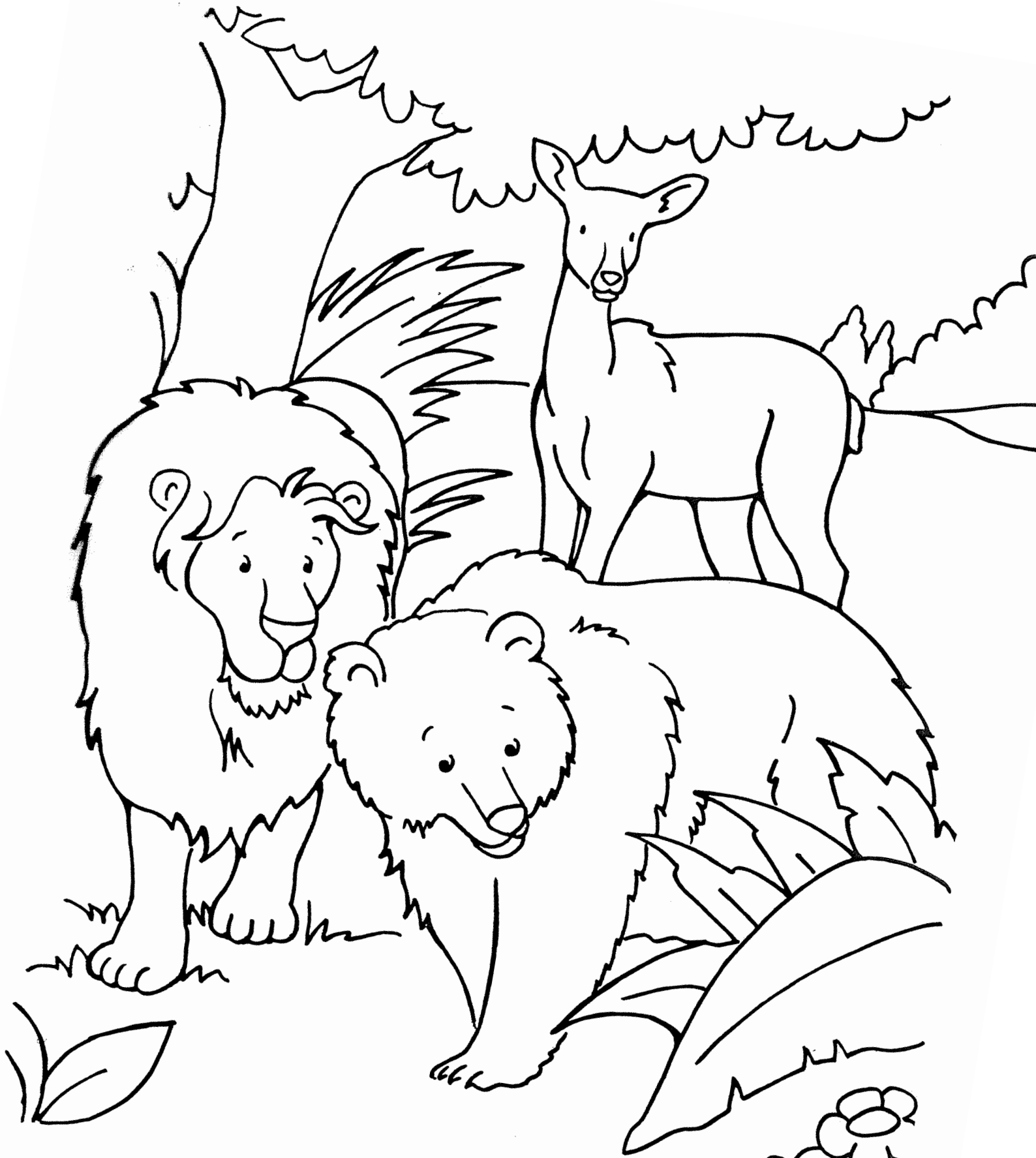

God Makes the Animals  
Genesis 1

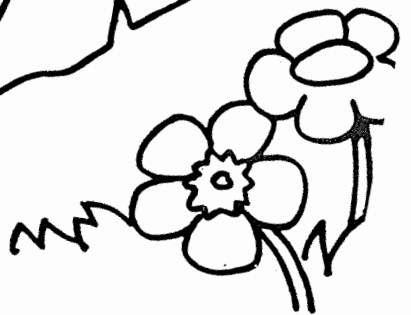



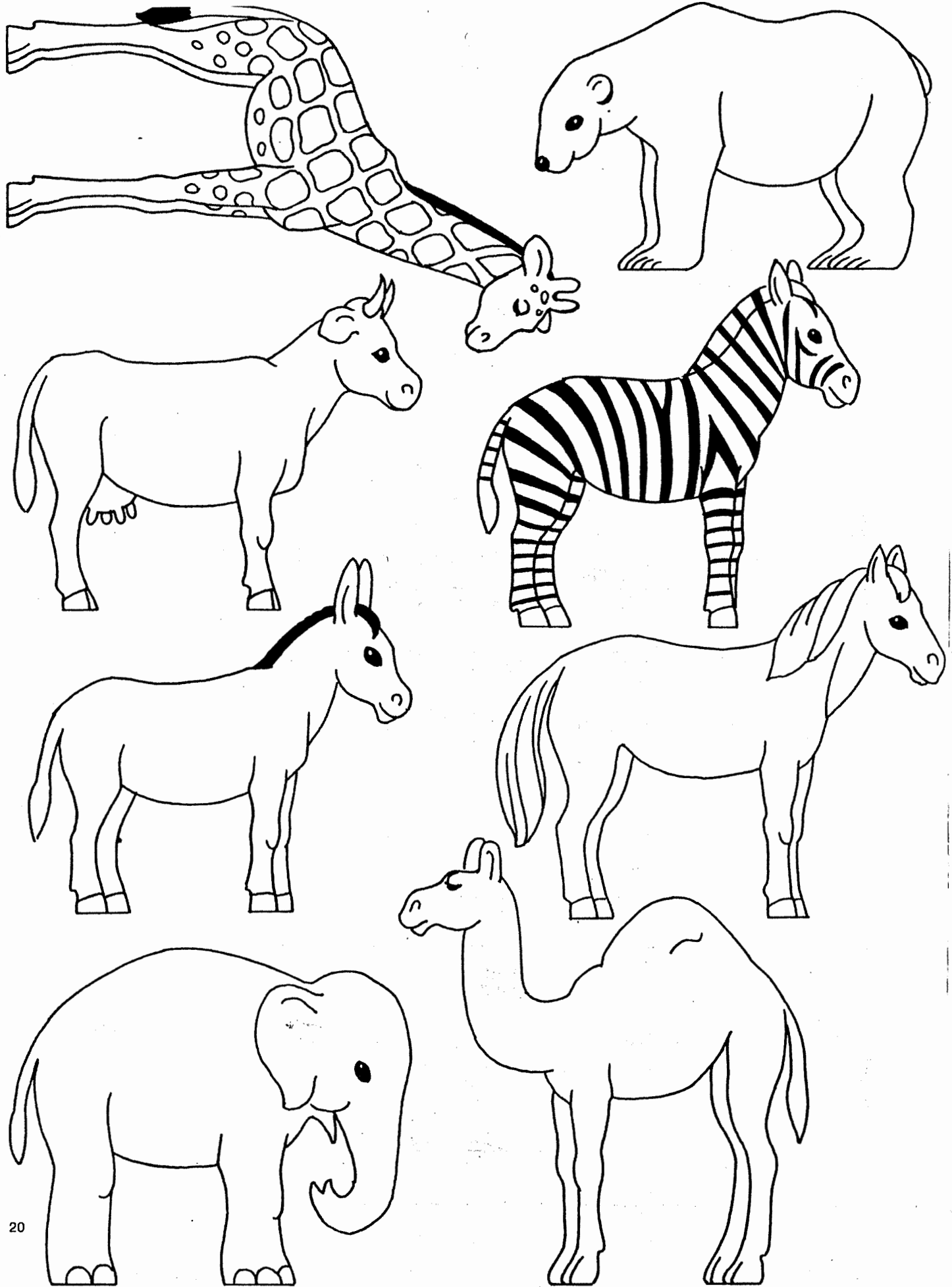

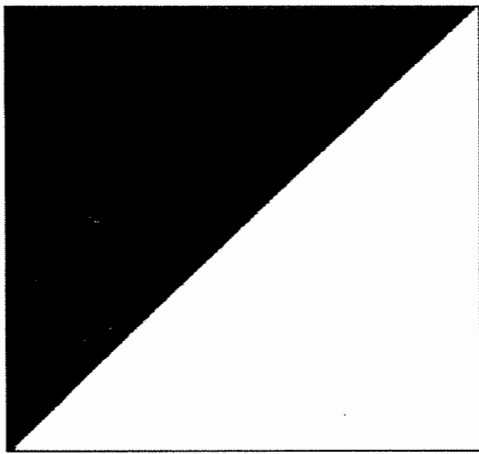

1

darkness and light

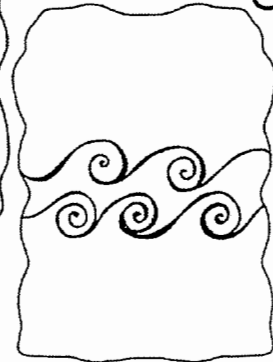
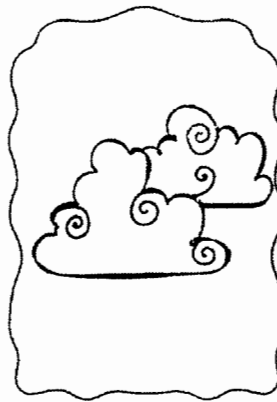

2

sky and water

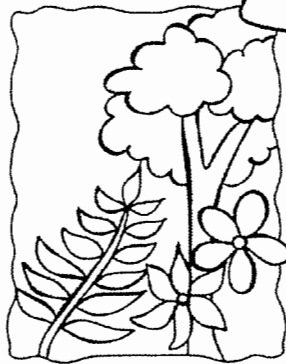
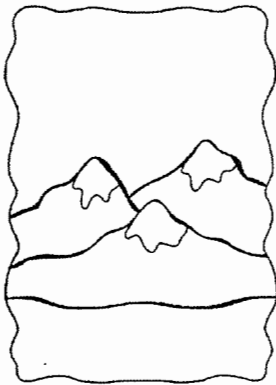

3

land and plants



4

sun, moon, stars

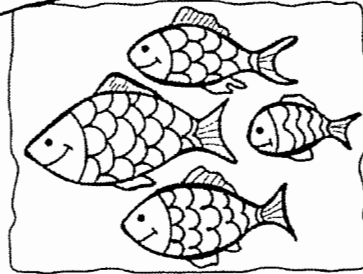
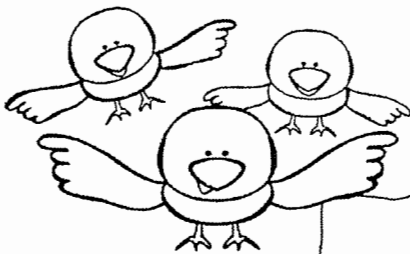
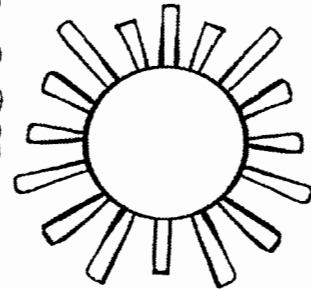

5

birds and fish

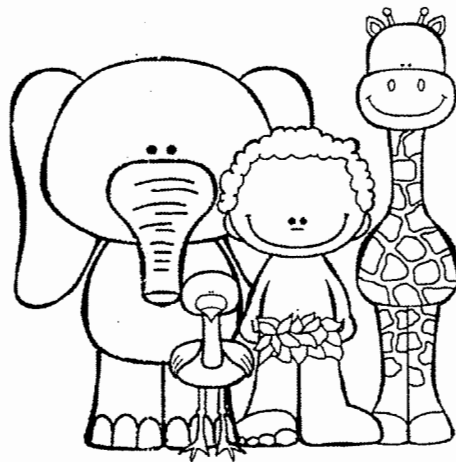

6

animals and people

## Animal Mobile

### Supplies

copies of the Animal Mobile (preferably on white card stock) for each child  
crayons or markers  
scissors  
hole punch  
varying lengths of yarn (5 per student, any color)

### Directions

Color the word strip and the three mobile pieces that show animal pictures. On the fourth mobile piece, draw and color your favorite animal. Cut out all of the mobile pieces. Punch five holes in the word strip where the small circles are shown. Punch one hole at the top of each of the mobile pieces. Using varying lengths of yarn, tie each mobile piece to the word strip. Tie the fifth piece of yarn to the top center hole of the word strip and loop it at the top so the mobile can be hung. Use the mobile to tell about what God made on days 5 and 6 of creation.

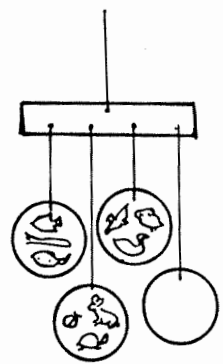

# God Makes the Animals

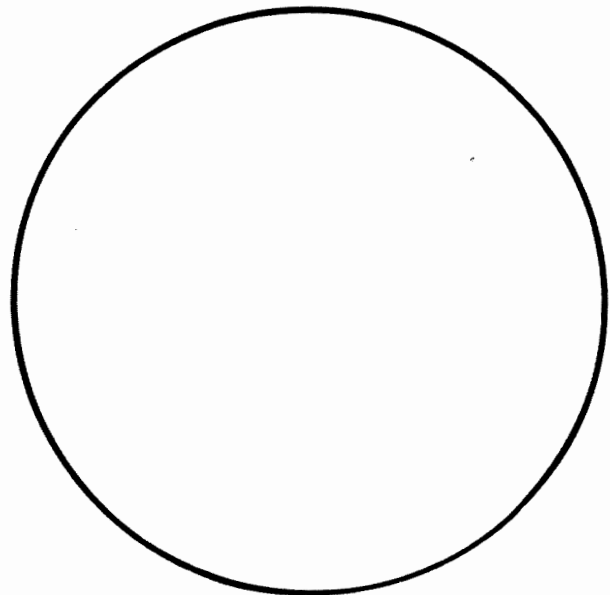
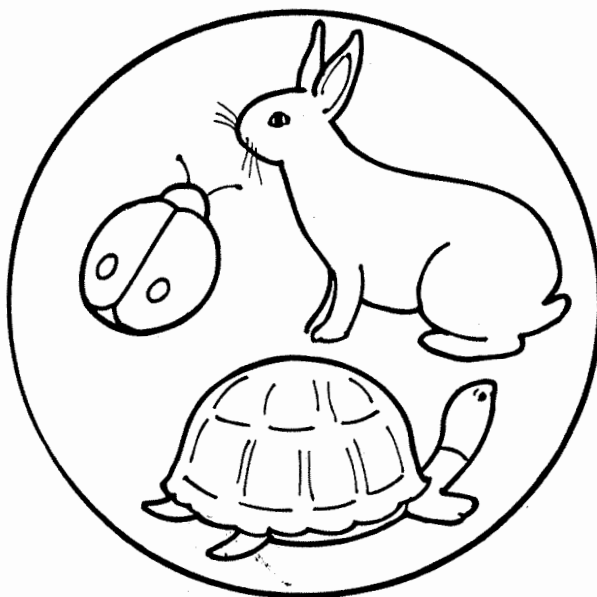
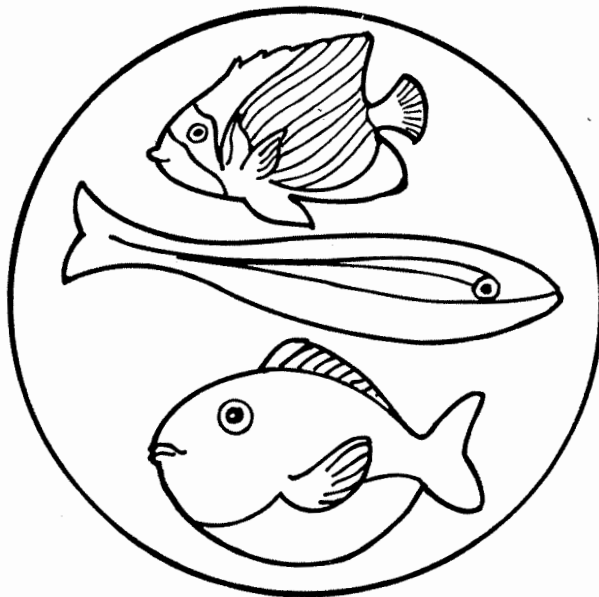



"Out of the ground made the Lord God to grow every tree  
that is pleasant to the sight, and good for food."

—Genesis 2:9

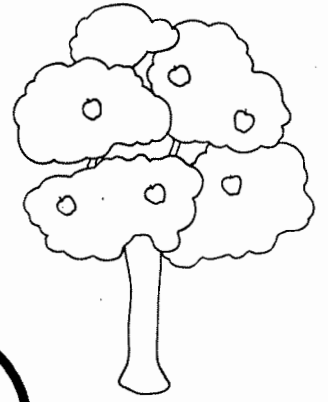
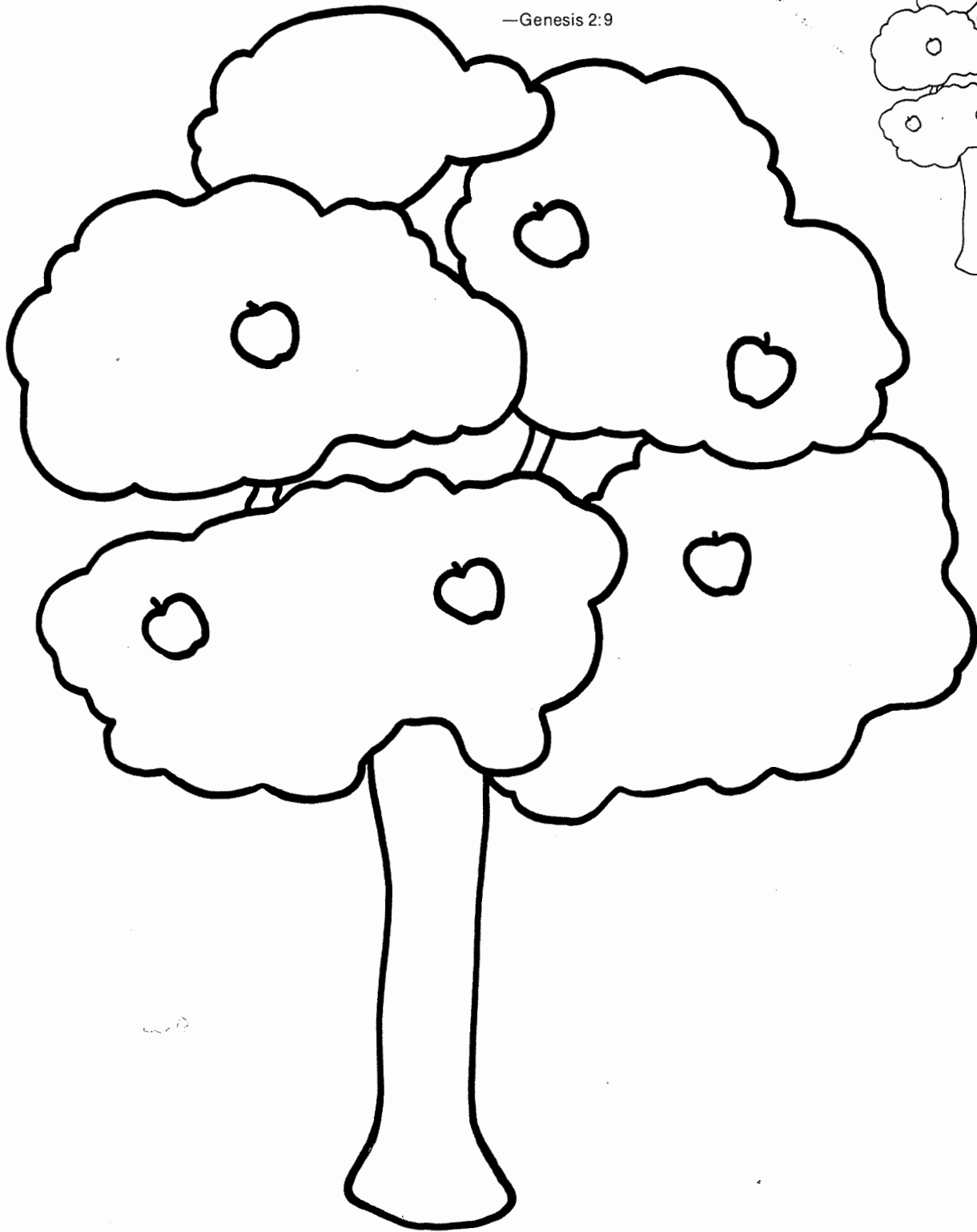

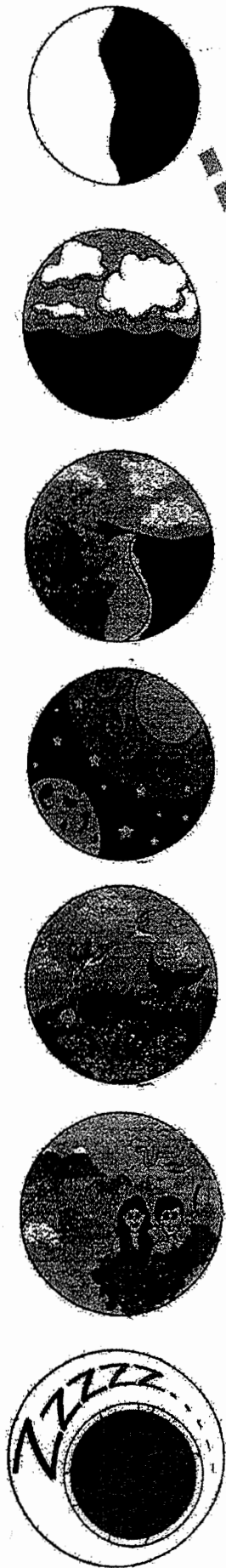

Day 4

Day 6

Day 5

Day 2

Day 3

Day 7

Day 1

Creation  
Genesis 1:20-25

# God Made Them All

God made the animals of the sea and sky and earth.  
To find out what God thought of all he had done,  
write the first letter of each animal in the box next to it.

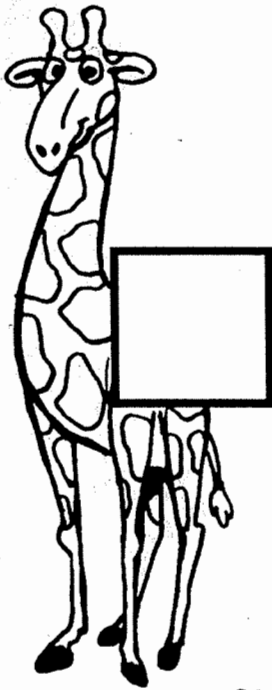

looked at everything  
he had made,  
and it was very

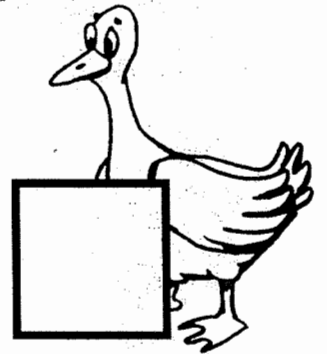
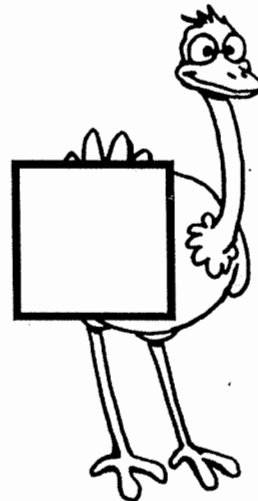
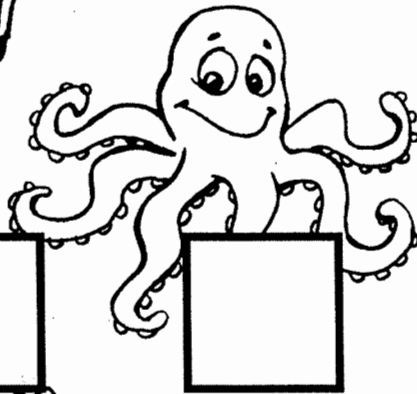
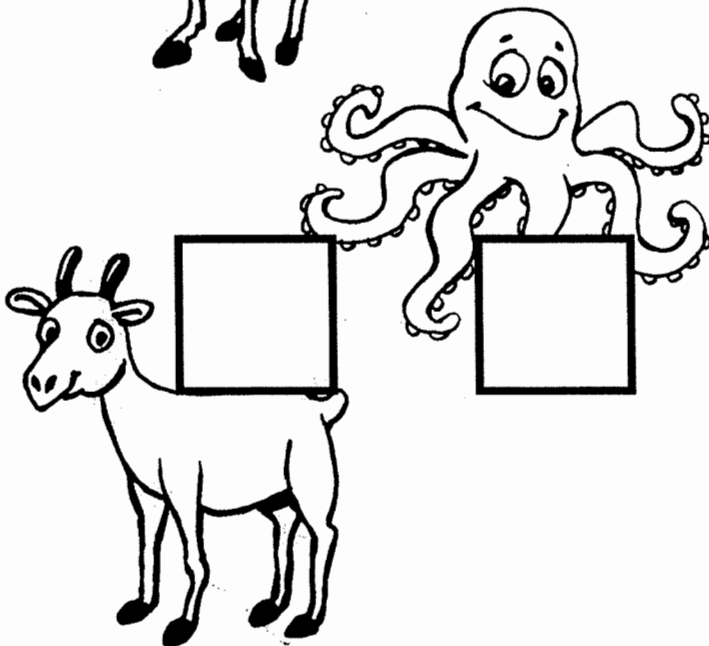

## FLYING BIRDS

### Materials:

Construction paper—many colors  
Yarn  
White glue  
Paper punch  
Branch from a tree (optional)  
Patterns—bird and wings (page 38)

### Directions:

Before class cut out one bird and one pair of wings per child. Punch a hole near the center of the bird and slits where indicated on pattern. Cut yarn into 15" lengths. Give each child a bird, a pair of wings, and one piece of yarn. Show how to insert the wings in the slits in the body of the bird. Assist the children in securing the yarn in the hole in the birds' bodies. Allow the children to "fly" their birds inside, or, if space is limited, take them outside for a walk.

If you wish, bring in a tree branch and set it upright in a coffee can filled with gravel or dirt. After the children "fly" their birds, let them nest their birds in the tree branch for the rest of the classtime.

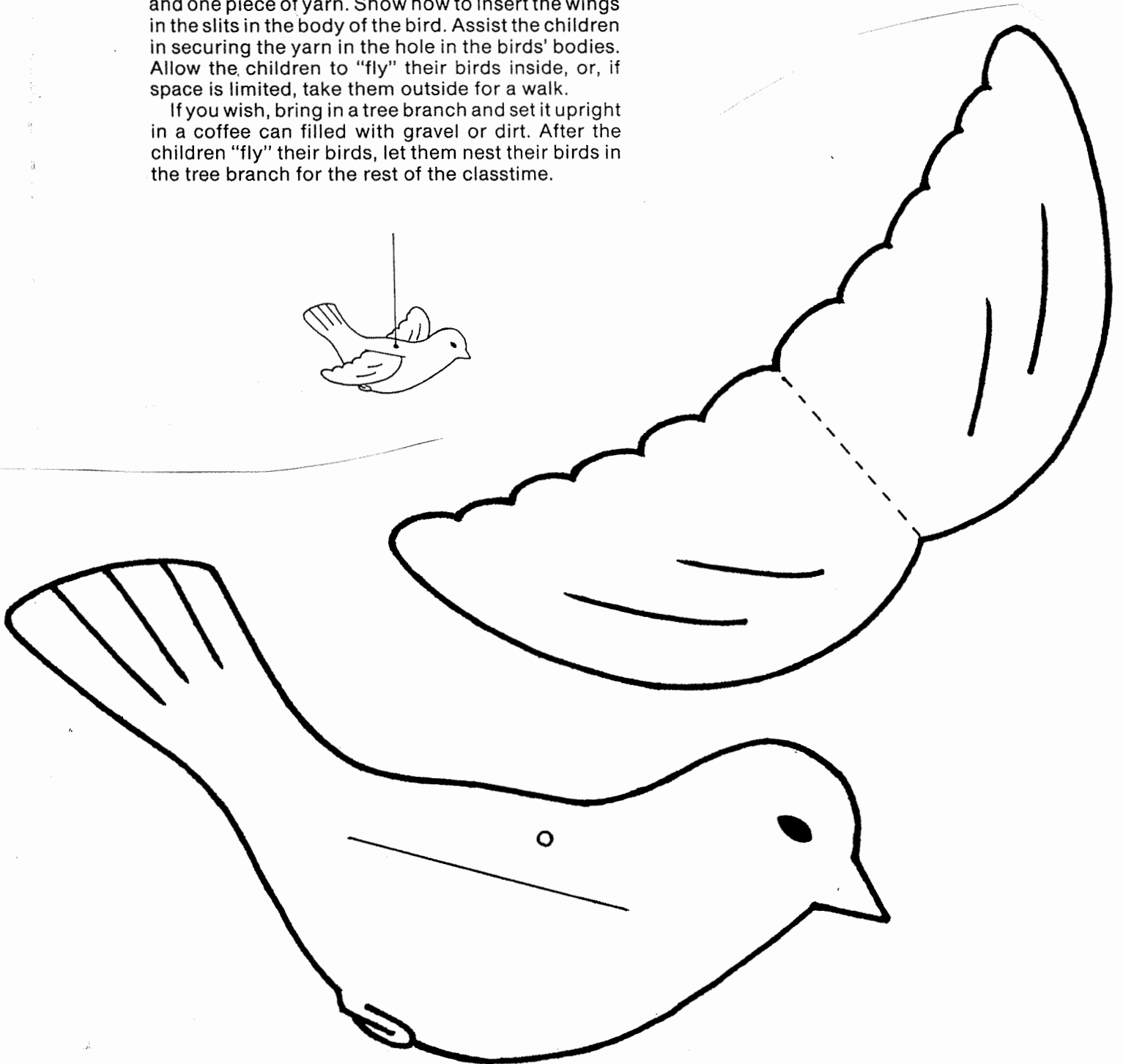
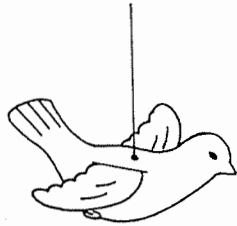

1. Light

2. Space

3. Earth,  
Vegetation

4. Sun, Moon  
Stars

5. Fish, Fowl

6. Beast, Man

7. GOD RESTED.

Use these clipart to glue on for the days of creation.

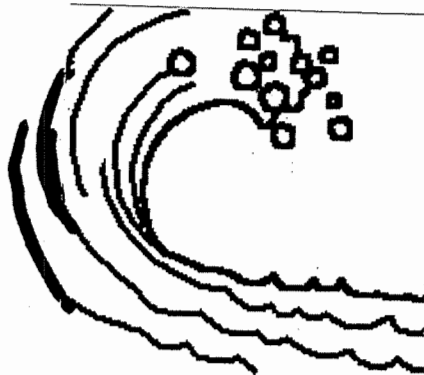
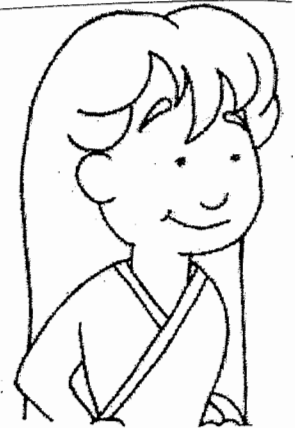
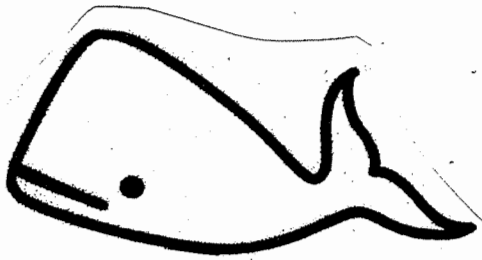
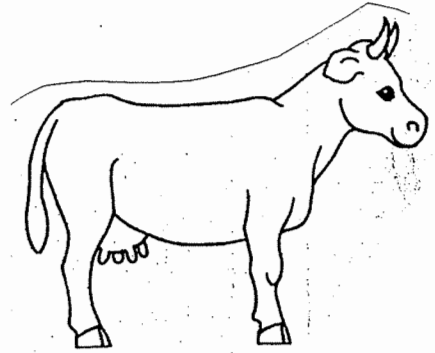
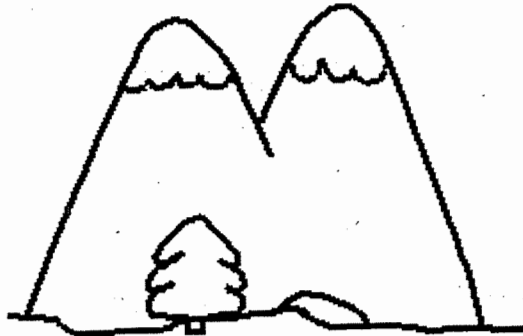
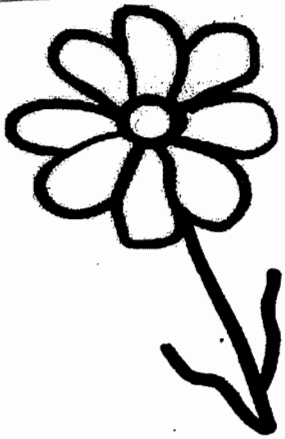
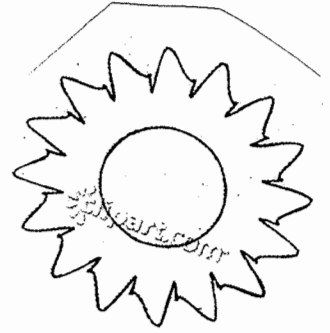
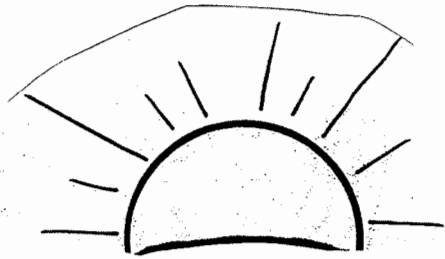
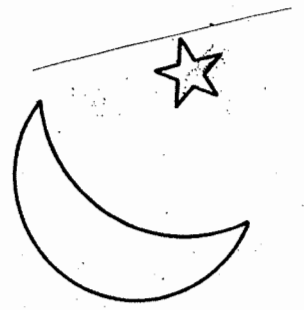
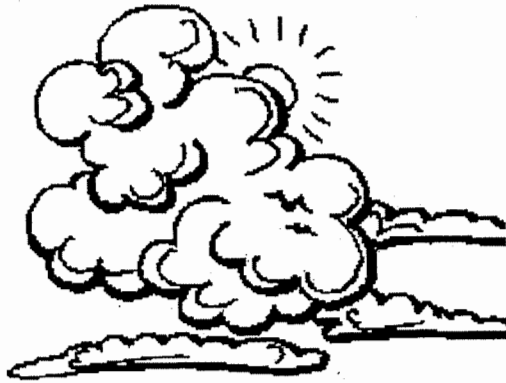

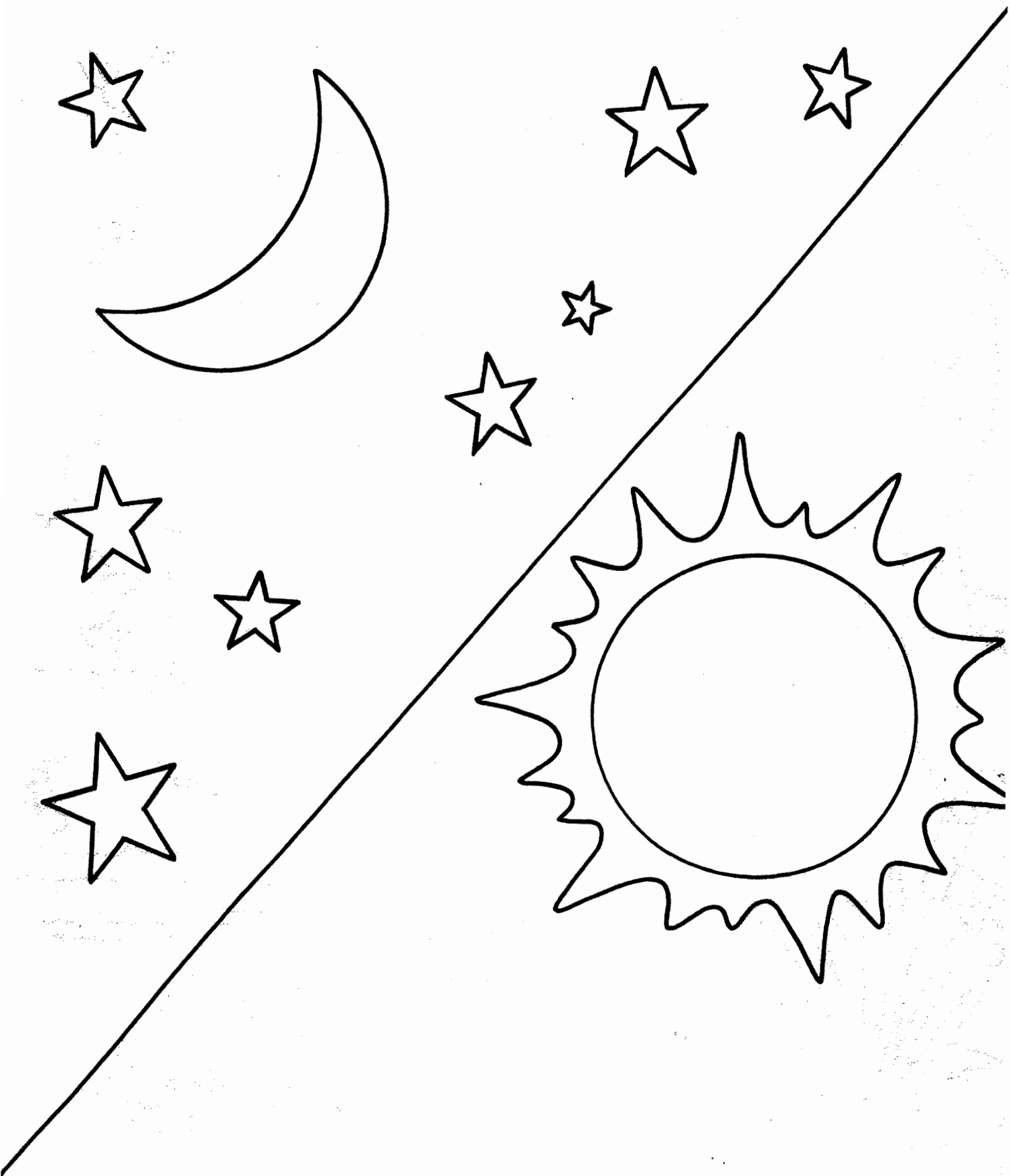

God made the stars and moon to shine at night. He made the sun to shine in the daytime.

*Genesis 1:14-18*



God  
Created...

Color the days of creation, then cut out circles and connect them with a brad. Construction paper can be added to the back for strength.





# Creation Crossword

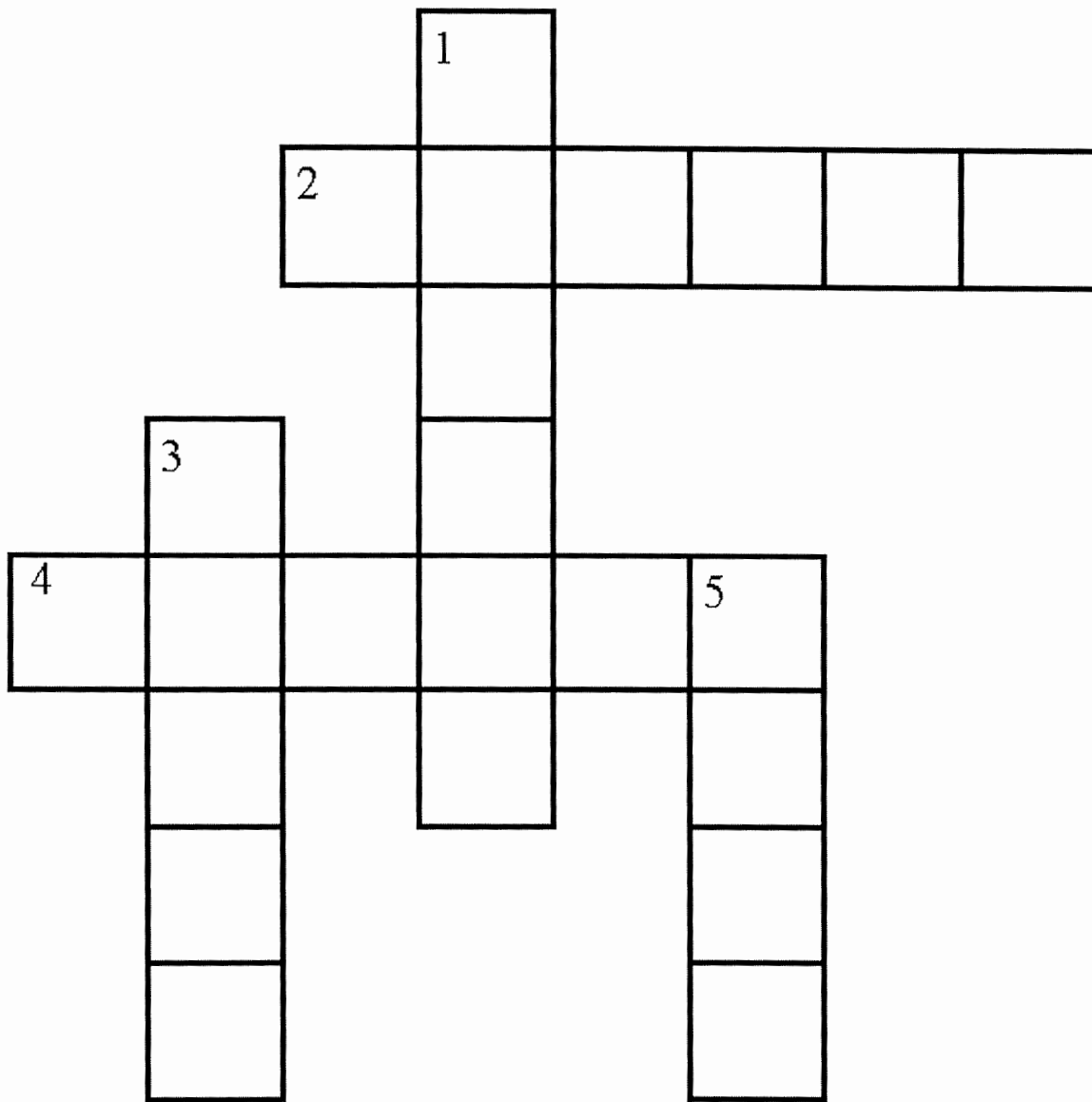

## ACROSS

2. On the \_\_\_\_\_ day God made the sky.
4. God separated the \_\_\_\_\_ from the sky.

## DOWN

1. He called the sky \_\_\_\_\_
3. He called the land \_\_\_\_\_
5. He called the waters \_\_\_\_\_



# In the beginning...

G S D F T H H D U T  
S N N A H S T E L H  
W U I A Y I R T L G  
I E N N E F A A I I  
N O O M N C E E G N  
B I R D S I O R H M  
R E S T E D G C T G  
S N E V A E H E O Y  
A N I M A L S D B P  
W D Y M A N K I N D

ANIMALS  
CREATED  
FISH  
LIGHT  
NIGHT  
SUN

BEGINNING  
DAY  
GOD  
MANKIND  
OCEANS

BIRDS  
EARTH  
HEAVENS  
MOON  
RESTED



# 1. CREATION

## (GENESIS 1:1-2:25)

### MEMORY VERSE:

***"In the beginning was the Word, and the Word was with God, and the Word was God. He was in the beginning with God. All things were made through Him, and without Him nothing was made that was made." JOHN 1:1-3***

### TRUE OR FALSE:

1. "In the beginning God created the heavens and the earth." **GENESIS 1:1**  
**TRUE OR FALSE**
2. "The earth was without form, and void; and darkness was on the face of the deep. And the Spirit of God was hovering over the face of the waters." **GENESIS 1:2**  
**TRUE OR FALSE**
3. "Then God said, 'Let there be light'; and there was light." **GENESIS 1:3**  
**TRUE OR FALSE**

### CIRCLE THE CORRECT WORDS:

4. "God called the light (**BRIGHT, DAY**), and the darkness He called (**NIGHT, SPACE**). So the evening and the morning were the first day." **GENESIS 1:5**
5. "And God called the firmament (**HEAVEN, EARTH**). So the evening and the morning were the second day." **GENESIS 1:8**
6. "And God called the dry land (**DIRT, EARTH**), and the gathering together of the waters He called (**SEAS, PUDDLES**). And God saw that it was good." **GENESIS 1:10**

### TRUE OR FALSE:

7. Then God said, "Let the earth bring forth grass, the herb that yields seed, and the fruit tree that yields fruit according to its kind, whose seed is in itself, on the earth"; but it did not happen. **GENESIS 1:11**  
**TRUE OR FALSE**
8. "Then God made two great lights: the greater light to rule the day, and the lesser light to rule the night. He made the stars also." **GENESIS 1:16**  
**TRUE OR FALSE**
9. "So God created great sea creatures and every living thing that moves, with which the waters abounded, according to their kind, and every winged bird according to its kind. And God saw that it was good." **GENESIS 1:21**  
**TRUE OR FALSE**

### FILL IN THE BLANKS:

10. "Then God said, 'Let the earth bring forth the living creature according to \_\_\_\_\_, cattle and creeping thing and beast of the earth, each according to \_\_\_\_\_'; and it was so." **GENESIS 1:24**
11. "Then God said, 'Let \_\_\_\_\_ make man in \_\_\_\_\_ image, according to \_\_\_\_\_ likeness.'" **GENESIS 1:26**

# The Creation

Genesis 1, 2

In the beginning God created the heavens and the earth (1:1).

Day 1: God said, "Let there be \_\_\_\_\_," and there was light. God ... \_\_\_\_\_ the light from the \_\_\_\_\_ (1:3, 4).

Day 2: God made the \_\_\_\_\_ and separated the \_\_\_\_\_ under the expanse from the water \_\_\_\_\_ it (1:7).

Day 3: God said, "Let the water under the \_\_\_\_\_ be gathered to one place, and let dry \_\_\_\_\_ appear." ... "Let the \_\_\_\_\_ produce \_\_\_\_\_ and trees on the land that bear seed-bearing \_\_\_\_\_ with seed in it" (1:9, 11).

Day 4: God made two great \_\_\_\_\_—the \_\_\_\_\_ light to govern the day and the \_\_\_\_\_ light to govern the night. He also made the \_\_\_\_\_ (1:16).

Day 5: So God \_\_\_\_\_ the great creatures of the \_\_\_\_\_ and every \_\_\_\_\_ and \_\_\_\_\_ thing with which the water teems ... and every winged \_\_\_\_\_ (1:21).

Day 6: God made the wild \_\_\_\_\_ according to their kinds, the \_\_\_\_\_ according to their kinds, and all the \_\_\_\_\_ that move along the ground \_\_\_\_\_ to their kinds.... Then ... God created \_\_\_\_\_ in his own \_\_\_\_\_, in the image of God he created him; \_\_\_\_\_ and \_\_\_\_\_ he created them (1:25-27).

Day 7: And God \_\_\_\_\_ the \_\_\_\_\_ day and made it \_\_\_\_\_, because on it he \_\_\_\_\_ from all the \_\_\_\_\_ of creating that he had done (2:3).

D Q V P S L A M I N A S L  
 E A G U E O B L E S S E D  
 L B R T V L I G H T S S P N  
 A O E K E S R A T S S A K  
 M V A R N M D R E E M R C  
 E E T O T E Q R K A P A O  
 F H E W H P S S L I G H T T  
 S M R I H N H S D E L E S  
 E A C C O R D I N G I D E  
 R L M G L P D F A A V L V  
 U E Q K Y E L D L M I D I  
 T T W A T E R A E I N J L  
 A I C A I M A H S T G B G  
 E U E X P A N S E T S K Y  
 R R Z F Y N E X D W S E C  
 C F N O I T A T E G E V R  
 B M O V I N G R O U N D A



# 1. Creation

Find as many words as you can in the letters below. Go from left to right. The first one is done for you.

**G**ODDAYSEEDENSEASONSFWOLAIRBEAST

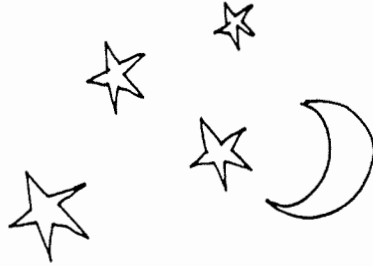

- 1. **GOD** \_\_\_\_\_
- 2. \_\_\_\_\_
- 3. \_\_\_\_\_
- 4. \_\_\_\_\_
- 5. \_\_\_\_\_
- 6. \_\_\_\_\_
- 7. \_\_\_\_\_
- 8. \_\_\_\_\_
- 9. \_\_\_\_\_
- 10. \_\_\_\_\_
- 11. \_\_\_\_\_
- 12. \_\_\_\_\_
- 13. \_\_\_\_\_

- 14. \_\_\_\_\_
- 15. \_\_\_\_\_
- 16. \_\_\_\_\_
- 17. \_\_\_\_\_
- 18. \_\_\_\_\_
- 19. \_\_\_\_\_
- 20. \_\_\_\_\_

## Super Word Finder!

- 21. \_\_\_\_\_
- 22. \_\_\_\_\_
- 23. \_\_\_\_\_
- 24. \_\_\_\_\_
- 25. \_\_\_\_\_



Use the code to write the message.

<b>a=26</b>	<b>b=25</b>	<b>c=24</b>	<b>d=23</b>	<b>e=22</b>
<b>f=21</b>	<b>g=20</b>	<b>h=19</b>	<b>i=18</b>	<b>j=17</b>
<b>k=16</b>	<b>l=15</b>	<b>m=14</b>	<b>n=13</b>	<b>o=12</b>
<b>p=11</b>	<b>q=10</b>	<b>r=9</b>	<b>s=8</b>	<b>t=7</b>
<b>u=6</b>	<b>v=5</b>	<b>w=4</b>	<b>x=3</b>	<b>y=2</b>
		<b>z=1</b>		

20,12,23    7,12,15,23    26,25,9,26,14    7,12,    20,22,7    9,22,26,23,2

21,12,9    26    15,12,13,20    17,12,6,9,13,22,2.    20,12,23

11,9,12,14,18,8,22,23    7,12    14,26,16,22    26,25,9,26,14

7,19,22    25,22,20,18,13,13,18,13,20    12,21    26    20,9,22,26,7

13,26,7,18,12,13.    26,25,9,26,14    26,13,23    19,18,8

21,26,14,18,15,2    23,18,23    13,12,7    16,13,12,4    4,19,22,9,22

20,12,23    4,12,6,15,23    8,22,13,23    7,19,22,14,    25,6,7    7,19,22,2

11,26,24,16,22,23    26,13,23    8,7,26,9,7,22,23    12,13    7,19,22

17,12,6,9,13,22,2.



**Year 1**

**Week 2**

## **God Makes Man and the Garden of Eden**

**Scriptures: Genesis 2:3-25**

**Key Verse:**

**Genesis 2:7 And the Lord God formed man of the dust of the ground and breathed into his nostrils the breath of life; and man became a living being.**

**Key Points:**

- 1.** God made man of the dust of the ground. He made him in His image.
- 2.** God made a beautiful garden for man to live in and planted it with everything he needed.
- 3.** Adam was to keep and tend the garden.
- 4.** God told Adam not to eat of the tree of the knowledge of good and evil. This was the first commandment of God to man. If Adam disobeyed he could die.
- 5.** God brought the animals to Adam for Adam to name.
- 6.** God made a helper for Adam, and gave him Eve as his wife.



God Makes People  
Genesis 1, 2

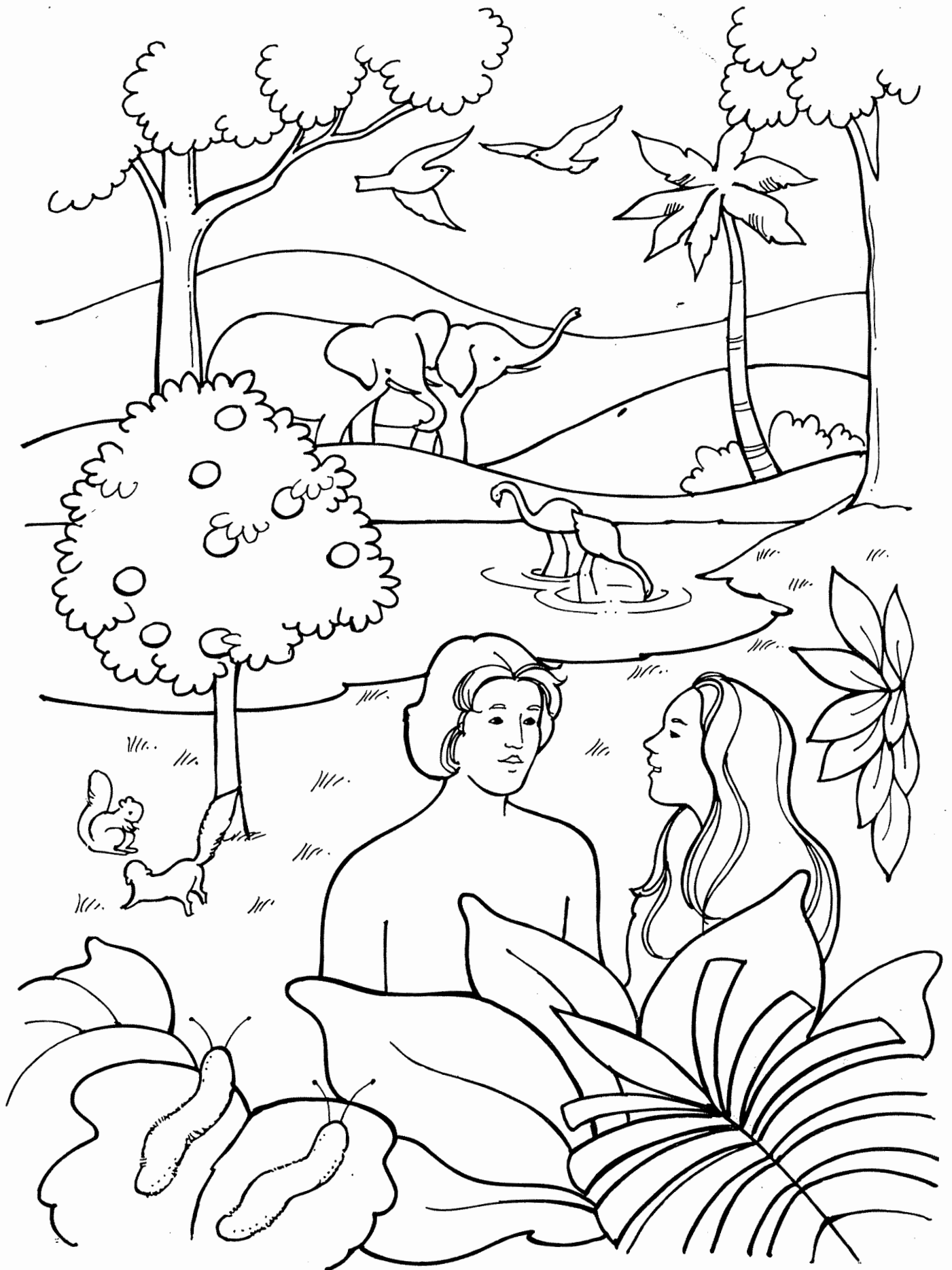



Adam and Eve lived in a beautiful garden that God had made for them. There were animals, fruits, flowers -- all sorts of wonderful things for Adam and Eve to enjoy.

**A**

is for Adam,  
The very first man.  
God made him and Eve  
As a part of His plan.

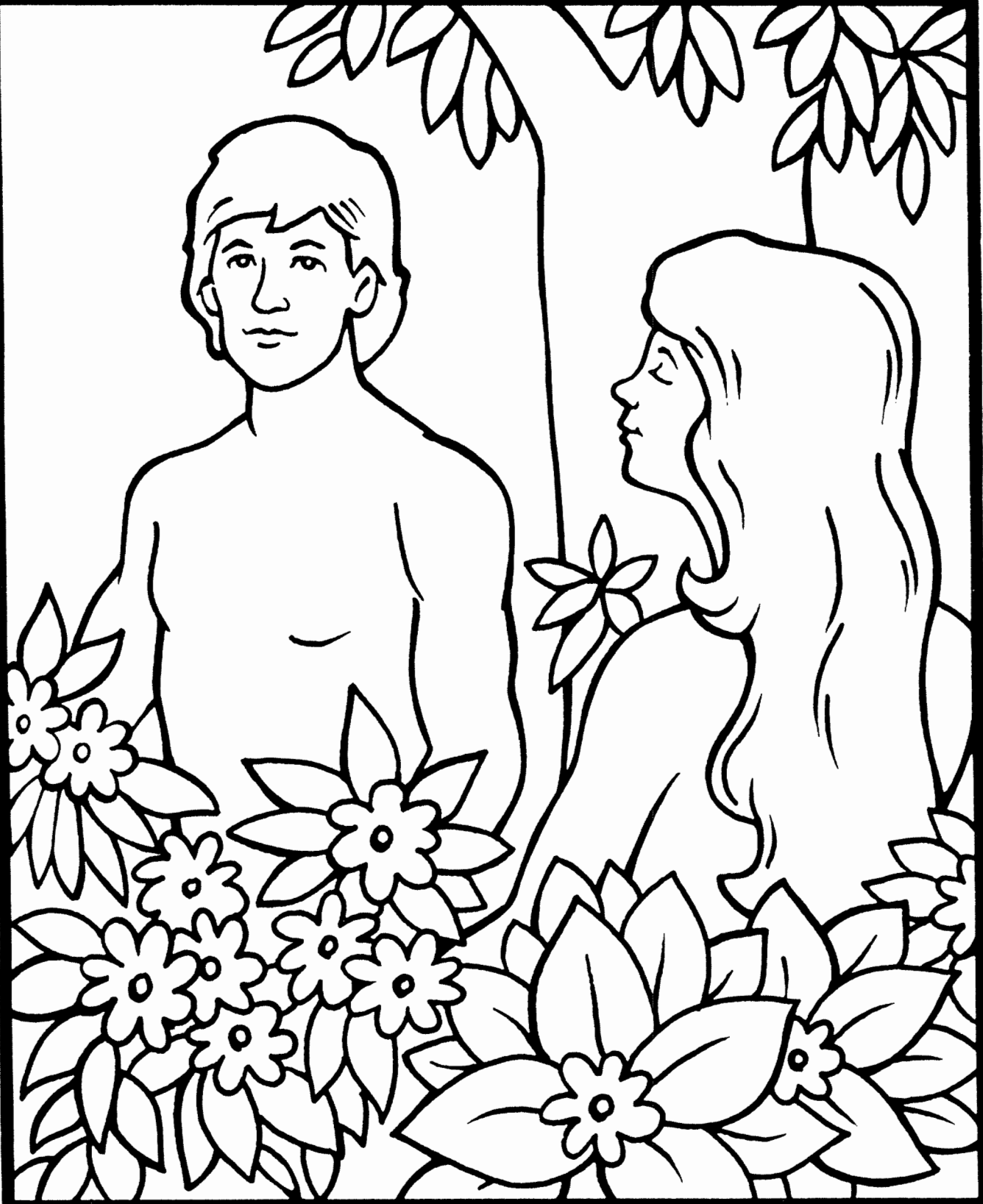

*Handwritten signature*



Last of all, God made a man, Adam, and a woman, Eve. God looked at all He had made and saw that it was very good.

*Genesis 1:26-31*



Adam and Eve lived in the garden. Adam gave names to all the animals.

*Genesis 2:19*

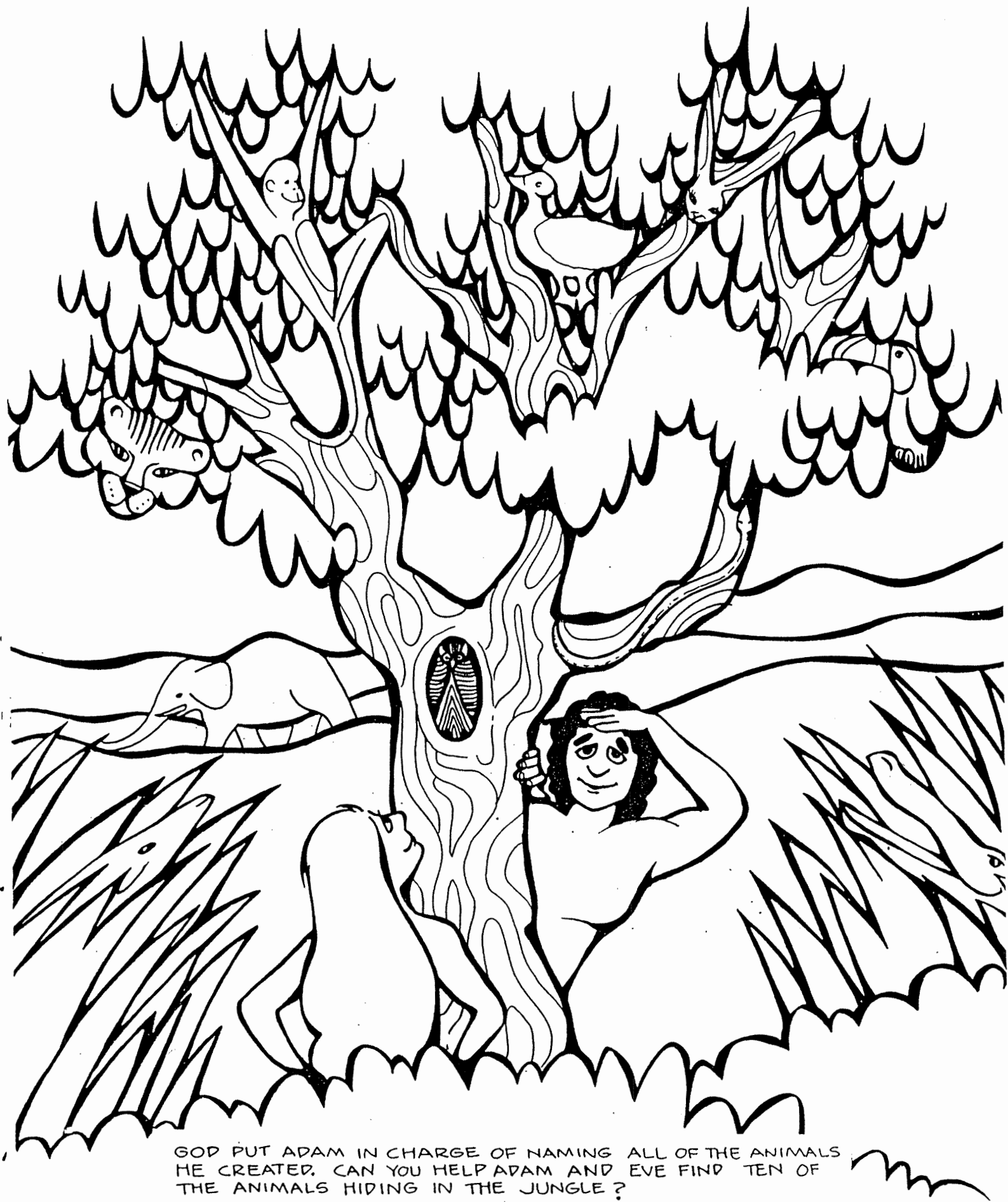

GOD PUT ADAM IN CHARGE OF NAMING ALL OF THE ANIMALS HE CREATED. CAN YOU HELP ADAM AND EVE FIND TEN OF THE ANIMALS HIDING IN THE JUNGLE?



# Trees God Made

## Adam and Eve

Genesis 1:26 — 2:25

In the beautiful garden God made for Adam and Eve, He put trees with delicious fruit growing on them.

Color the picture. Then paste the fruit-flavored cereal circles your teacher gives you on the trees as fruit.

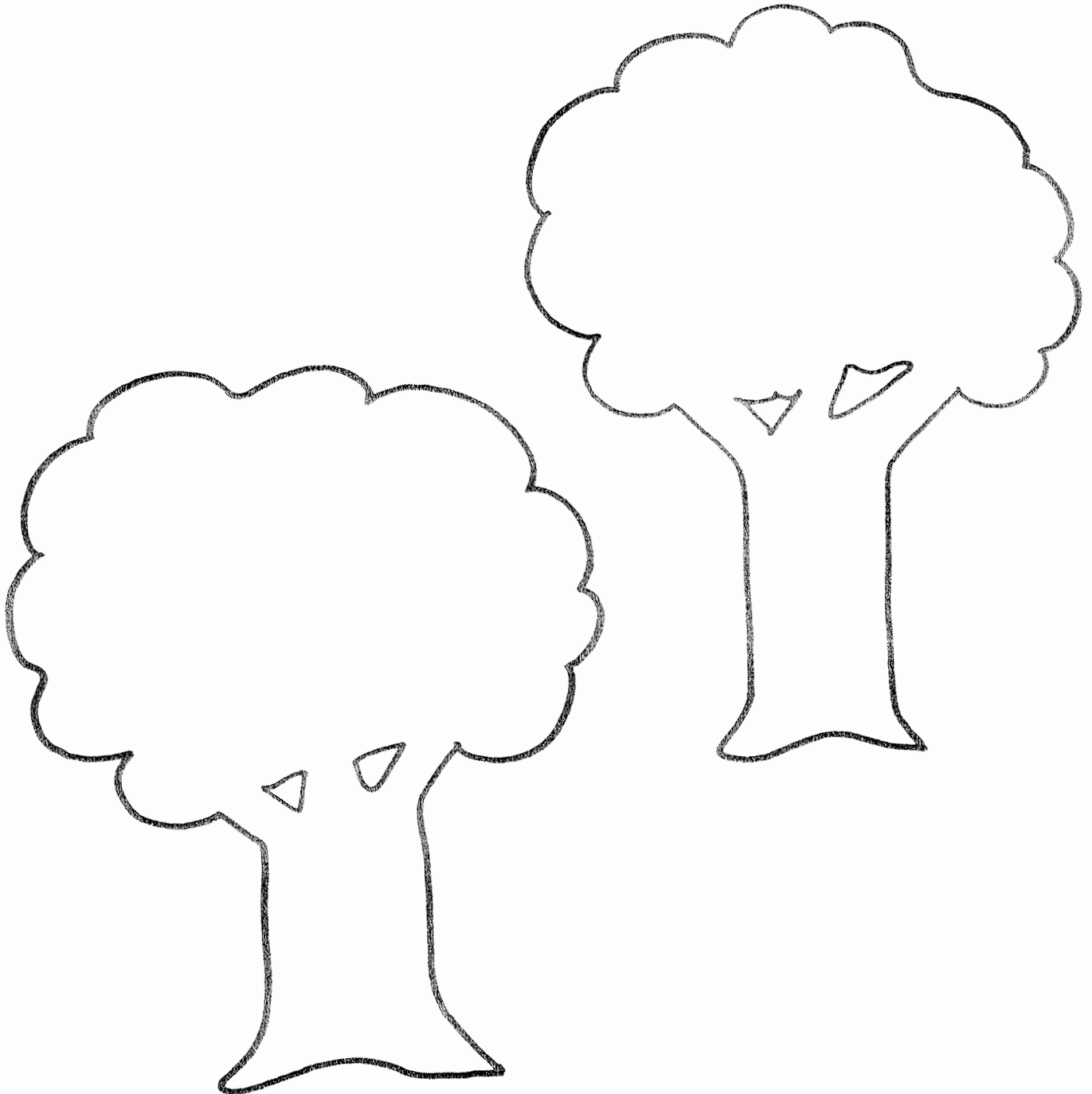

*For the Teacher:* Provide colorful fruit-flavored cereal circles to paste on the trees. As the children paste and color, talk about other wonderful foods God made. Help the children to thank God for good food.

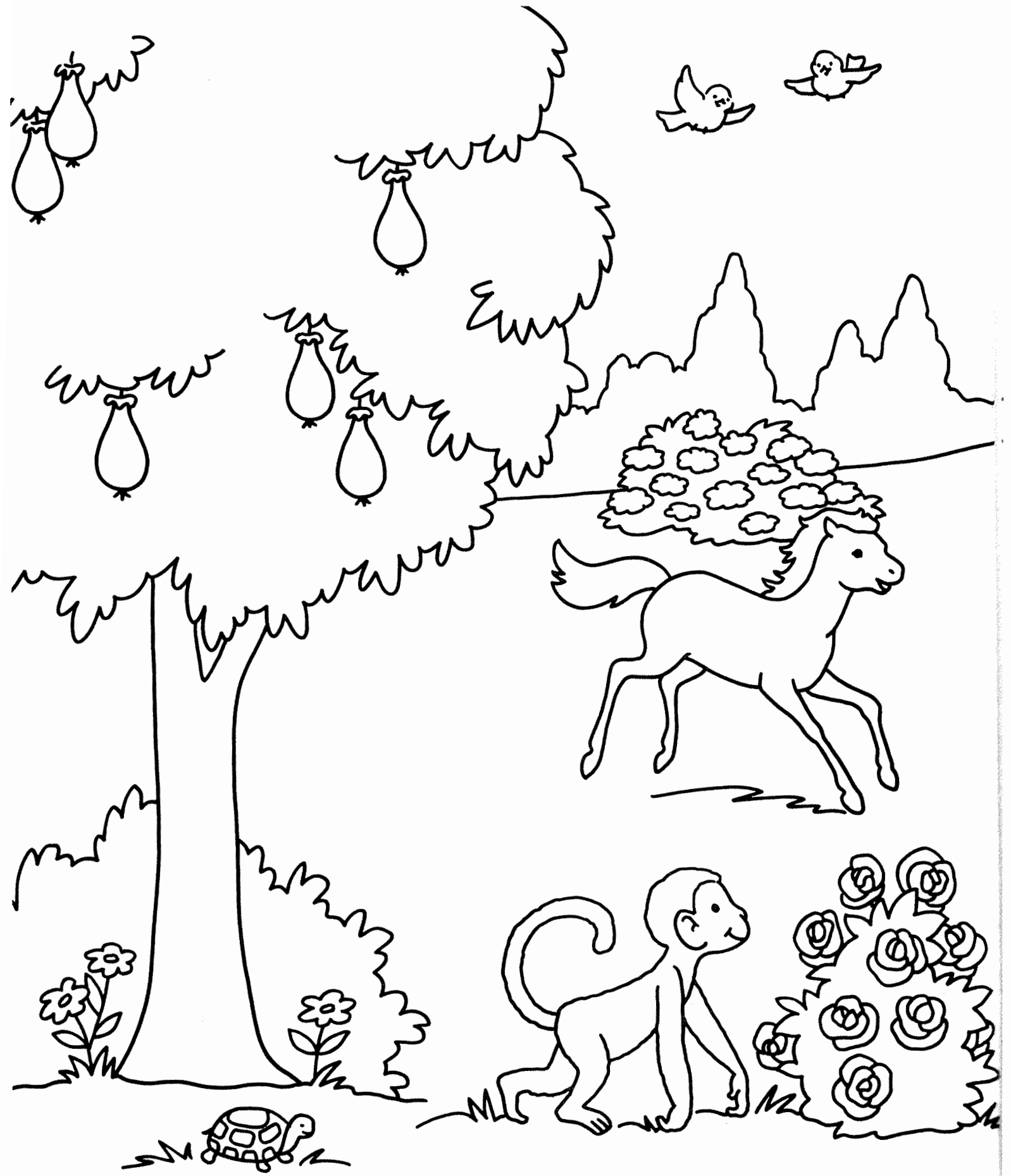

When God was creating He made a special garden which was called the Garden of Eden.

*Genesis 2:8-10*



Color a picture of the first family that God made. Then draw a picture of your own family.

The Lord God  
made a woman...

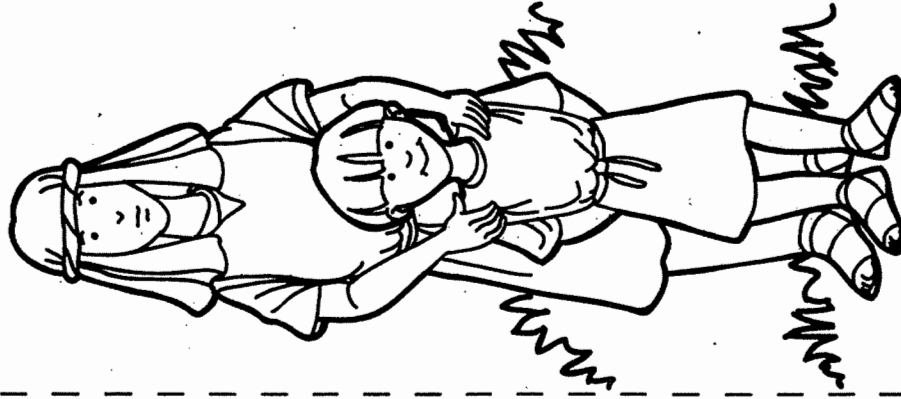

...and brought  
her to the man.  
Genesis 2:22

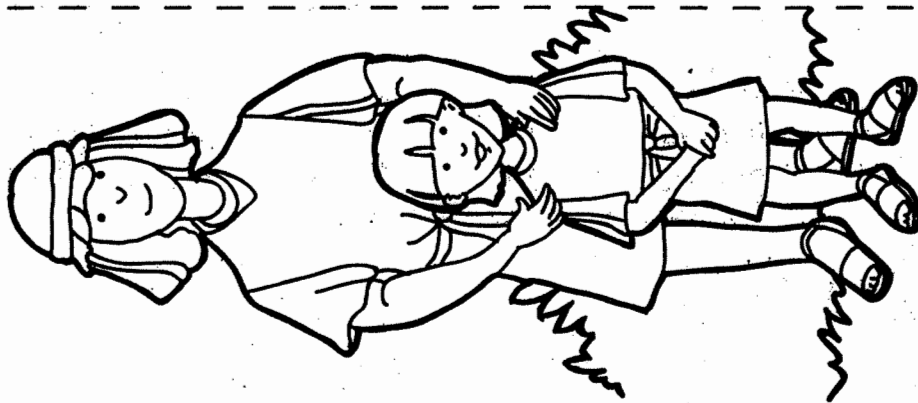



## 2. The Garden of Eden

Use the code to find the names of two special trees in the Garden of Eden.

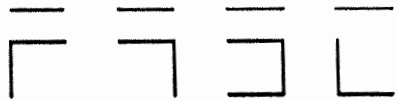

A	D	E
F	G	H
I	K	L

N	O
R	T
V	W



Which tree did God tell Adam and Eve not to eat from?

# GARDEN OF EDEN DIRT SOUFFLÉ

*"Then the Lord God planted a garden in the east, in a place called Eden" (Genesis 2:8a).*

More fun than mud pies! Kids will delight in customizing their own mini-gardens.

1. Form groups of four to six. Give each group a quart jar with a lid, pudding mix, two cups of milk, chocolate sandwich cookies in a strong resealable plastic bag, a rolling pin, plastic spoons, and a clay pot. Set the animal crackers, gummy worms, and jelly beans on a table where all the groups will have access to them.
2. Have each group choose people to be Pudding Shakers and Cookie Crushers. Instruct the Pudding Shakers to pour the milk and pudding mix into the quart jar, tightly screw on the lid, and shake the jars for three minutes.
3. Meanwhile, have the Cookie Crushers roll the rolling pins over the sealed bags to make cookie-crumb "dirt."
4. When the pudding is made and the cookies are crushed, gather kids and do the Faith Booster below.
5. Invite each group to create a "Garden of Eden" in their clay pot. Let them layer the pudding and cookie dirt, help themselves to crackers and worms, and use the jelly beans as flowers.
6. When the gardens are complete, let kids admire each other's work. Then let each child "dig in" to the gardens, scoop a generous helping into a paper cup, and gobble!

## FAITH BOOSTER

Ask:

- What do you know about the Garden of Eden?

Read aloud Genesis 2:4-9. Ask:

- What do you think it would have been like to live in that garden?
- What's the most beautiful garden you've ever seen?

Let volunteers tell why Adam and Eve had to leave the garden. Explain that many people have looked for the Garden of Eden, but no one knows exactly where it was. Tell kids we can imagine what the Garden of Eden was like and we'll have some creative fun making Garden of Eden Dirt Soufflés.

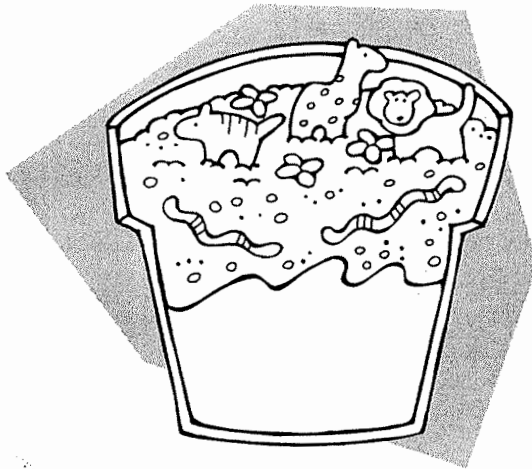

## SUPPLIES

- quart jars with lids
- instant chocolate pudding mix
- milk
- chocolate sandwich cookies
- strong resealable plastic bags
- rolling pins
- plastic spoons
- new, small clay pots
- animal crackers
- gummy worms
- small jelly beans
- paper cups

## PRO POINTER

You may want to let kids spoon the leftovers into resealable bags and take the bags home.

# God Makes Families

Genesis 2:20-24 and 4:1-2

## MEMORY VERSE

*The Lord God made a woman...and brought her to the man.*  
~ Genesis 2:22

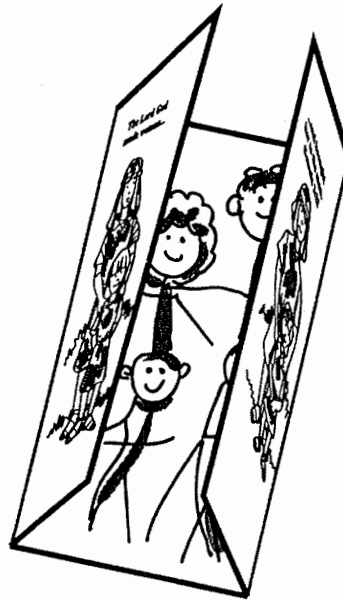

## WHAT YOU NEED

- page 12, duplicated
- crayons



## BEFORE CLASS

Duplicate the pattern page for each child. For younger children, fold the pages on the broken lines. Make a sample to show the children.



## WHAT TO DO

1. Introduce the lesson by telling the story found in Genesis 2:20-24 and 4:1-2. Say, **God made a man and called him "Adam." He made a woman who was named Eve. Then Adam and Eve had a son named Cain and another son named Abel. They were the very first family in the world. God makes families.**
2. Show the children the sample.
3. Distribute a pattern page to each child.
4. Say the memory verse.
5. Have the children fold the page on the broken lines and color the pictures on the flaps. Say, **Adam and Eve were the first people God made. They had two sons. They were the first family.**
6. Have the children open the flaps and draw a picture of their own families inside.
7. When the pictures are finished, have the children show the pictures of their families. Practice the memory verse together. Ask, **Can you point to Adam and Eve? Where are their sons? This is the first family God made.**



## EXTRA TIME

Provide magazine cut-outs of families. Have the children glue one or more of the cut-outs inside the folding picture.

# THE CREATION GENESIS 1-2:3

## Across

5. There was evening and there was \_\_\_\_\_. v. 8
6. God created the great \_\_\_\_\_ of the sea. v. 21
8. God made all the creatures that \_\_\_\_\_ along the ground. v. 25
9. God made two \_\_\_\_\_ lights. v. 16
12. God \_\_\_\_\_ the seventh day. v. 2:3
14. God created \_\_\_\_\_ in His own image. v. 27
15. God created man to rule over the fish of the \_\_\_\_\_. v. 26
16. In the beginning God created the \_\_\_\_\_ and the earth. v. 1

## Down

1. The land produced plants and trees bearing \_\_\_\_\_. v. 12
2. God gave man and woman every \_\_\_\_\_ and tree. v. 29
3. God created man to rule over the \_\_\_\_\_ of the air. v. 26
4. God called the dry \_\_\_\_\_ land. v. 10
7. God created livestock and wild \_\_\_\_\_. v. 24
10. God saw all he had made and it was \_\_\_\_\_. v. 31
11. By the \_\_\_\_\_ day God had finished his work. v. 2:2
13. God separated the \_\_\_\_\_ from the darkness. v. 4
17. God told them to fill the \_\_\_\_\_ and subdue it. v. 28

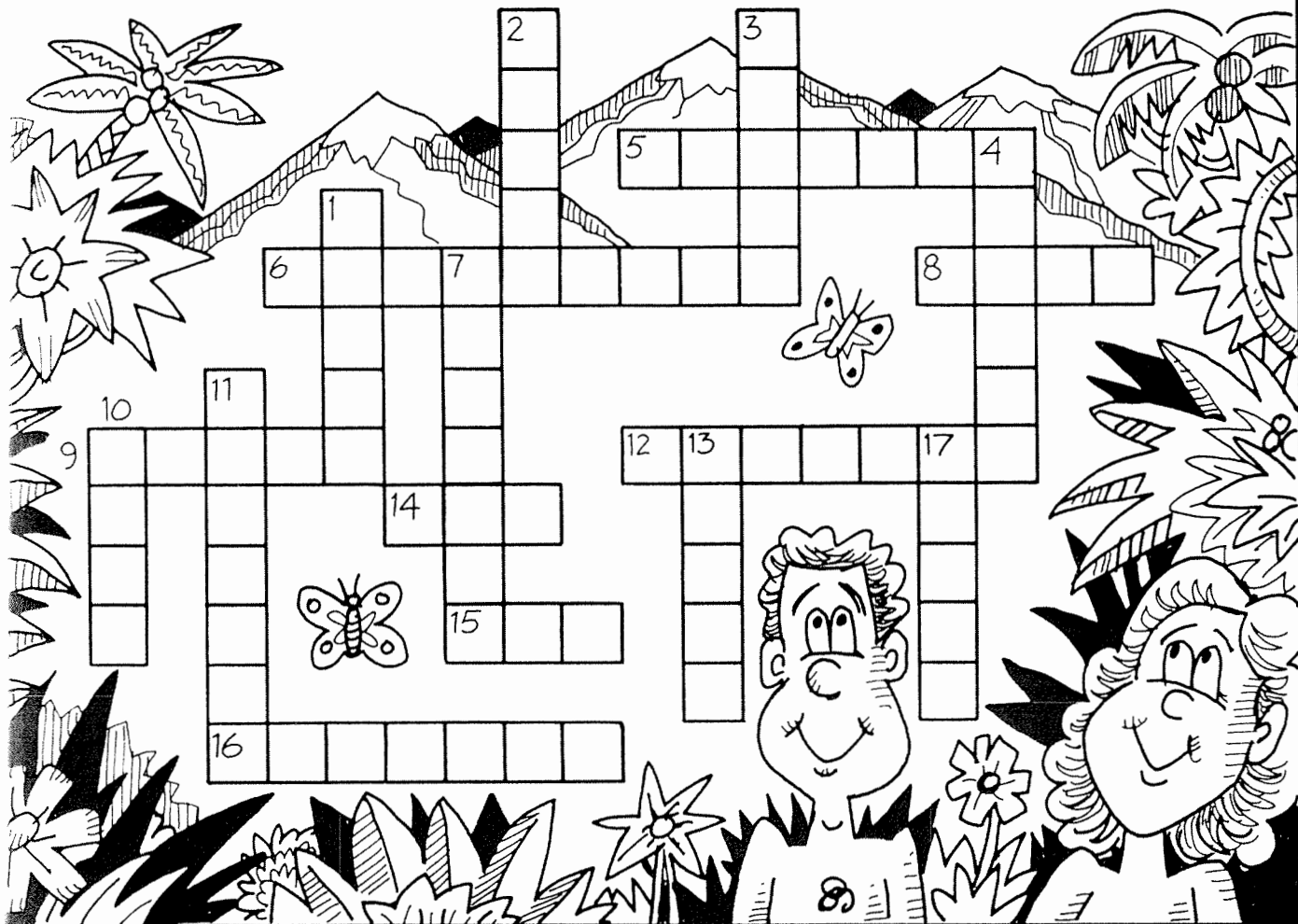



# Adam

Genesis 2:15-22

The Lord God took the \_\_\_\_\_ and put him in the Garden of \_\_\_\_\_ to work it and take care of it. And the Lord God \_\_\_\_\_ the man, "You are free to \_\_\_\_\_ from any \_\_\_\_\_ in the \_\_\_\_\_; but you must not eat from the tree of the \_\_\_\_\_ of good and \_\_\_\_\_, for when you eat of it you will \_\_\_\_\_ die."

The Lord God said, "It is not \_\_\_\_\_ for the man to be alone. I will make a \_\_\_\_\_ suitable for him."

Now the Lord God had \_\_\_\_\_ out of the ground all the \_\_\_\_\_ of the field and all the \_\_\_\_\_ of the air. He brought them to the man to see what he would \_\_\_\_\_ them; and whatever the man called each \_\_\_\_\_ creature, that was its name. So the man \_\_\_\_\_ names to all the \_\_\_\_\_, the \_\_\_\_\_ birds of the \_\_\_\_\_ and all the beasts of the \_\_\_\_\_.

But for \_\_\_\_\_ no suitable helper was \_\_\_\_\_. So the Lord God \_\_\_\_\_ the man to fall into a \_\_\_\_\_ sleep; and while he was \_\_\_\_\_, he took one of the man's \_\_\_\_\_ and closed up the place with \_\_\_\_\_. Then the Lord God made a \_\_\_\_\_ from the rib he had \_\_\_\_\_ out of the man, and he \_\_\_\_\_ her to the man.

G N D R O S Q N R I B S P D  
E A N C T M E J N K B L N A S E E  
K M R S Z D E P O M E U L S X M  
H E A D F E U E D L C T A V D F  
G B F O Y R X Q E W P V E A O  
T Z S O M A N D E D B N M T  
U C S L S R K G Q H R P J O  
M R E U G L I V E M F L D U K C I  
E P R F L E S H T J B G I V I  
L T A H P L Z A G A H O Y I  
E S D R I B Y K V F T O X N G  
H E U D N F I E L D V D C G  
A I R T G S B N W O M A N A

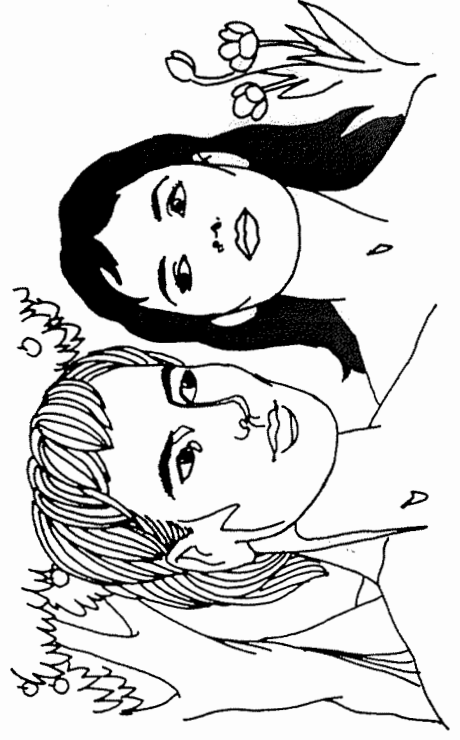

# GOD MAKES ADAM AND EVE

(GENESIS 1:26-4:1)

V Y L P I T L U M W O M A N L  
 H E L P E R G A T E I E V O T  
 W U U E M A N A H I V E R I N  
 Z C R E A T E D R E U D I M E  
 D V D E V I E C E D G R F N P  
 F O S G N M A N W O E P F M R  
 I Y M R T Q J G D Y O N R C E  
 Z Y S I Q T E Q E F I W N D S  
 T S S E N E K I L R U O D N M  
 M R F A C I A D A M W N Y O C  
 G E G A M I O F U B A Q T T U  
 G T J S D B F N I B A H S Y A  
 F R U I T F U L S T E U M J U  
 R E S F Y B S U B R D T Z D T  
 H R I B R I H T R E E F U V E

ADAM  
 CREATED  
 DECEIVED  
 DOMINION  
 DUST  
 EVE

FRUITFUL  
 FRUIT  
 GARDEN  
 HELPER  
 HUSBAND  
 IMAGE

LORD GOD  
 MAN  
 MOTHER  
 MULTIPLY  
 NAME  
 OUR LIKENESS

RIB  
 SERPENT  
 TREE  
 WIFE  
 WOMAN

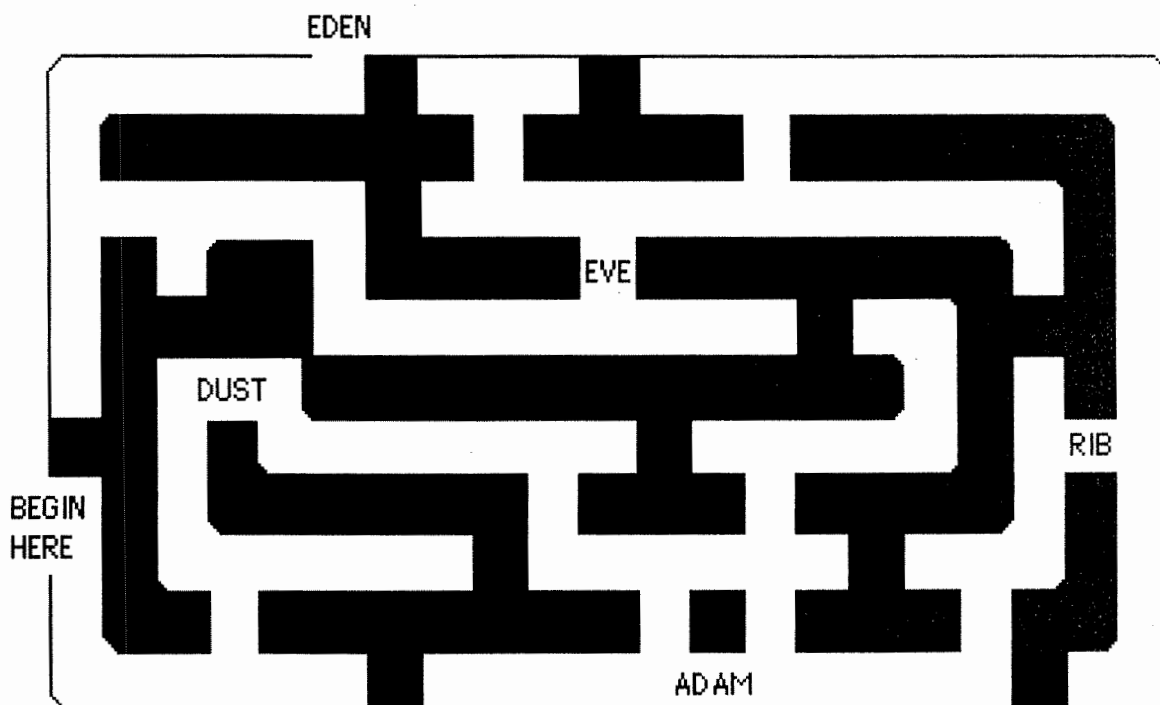

God created our world and everything in it. He also made people to live in the world. Complete this crossword about the first man and woman. Look up the Bible verses if you need help.

### ACROSS

1. Kind of leaves Adam and Eve used to make coverings. (3:7)
2. God said: "And I will put enmity between thee and the woman, and between thy \_\_\_\_\_ and her \_\_\_\_\_ ." (3:15)
5. Adam's bone God used to make Eve. (2:22)
7. What Adam and Eve did after they disobeyed God. (3:8)
10. To use shoestrings; Michaela \_\_\_\_\_ up his shoes.
13. First woman.
14. \_\_\_\_\_ apple; \_\_\_\_\_ egg; \_\_\_\_\_ elephant.
15. \_\_\_\_\_ of life; \_\_\_\_\_ of the knowledge of good and evil. (2:9, 17)
17. Cursed because of Adam's sin; another word for ground.
18. To liquefy.
19. Number of ribs God used to make Eve. (2:21)
20. Adam was the first. (2:7)
21. God did this on the seventh day. (2:2)
26. Abbreviation for road.
27. To listen to and obey; Adam and Eve did not \_\_\_\_\_ God's warning.
29. Old-fashioned, slang word for mother.
30. Eve did this before Adam; present tense verb. (3:6)
31. First man. (2:19)
33. God \_\_\_\_\_ ed Adam and Eve of the consequences if they ate of the tree.
35. Eve was the first of this sex.
36. Serpent; Satan disguised himself as this.
37. "And the \_\_\_\_\_ of them both were opened, and they knew that they *were* naked." (3:7)

### DOWN

2. Where Adam's bone was removed to make Eve.
3. Abbreviation of editor.
4. Another name for Satan.
6. Adam said, "This is now \_\_\_\_\_ of my \_\_\_\_\_ s, and flesh of my flesh." (2:23)
7. Part of foot that would be bruised. (3:15)

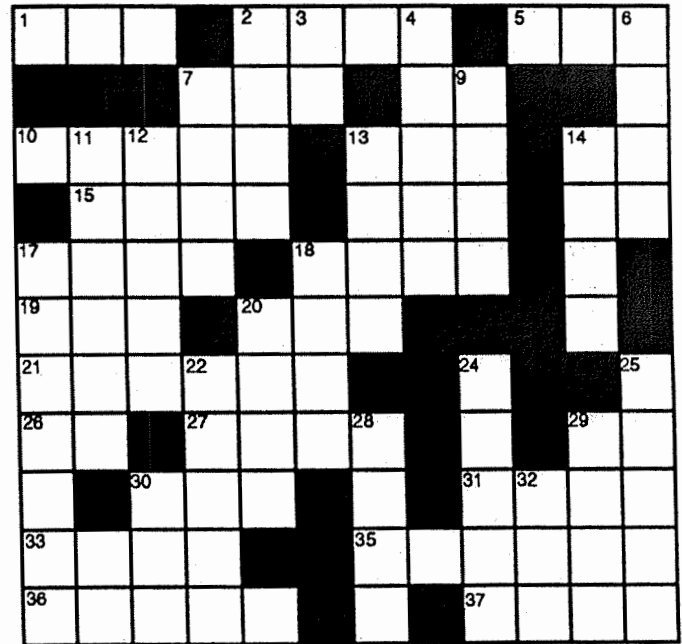

9. God said, "Now, \_\_\_\_\_ he put forth his hand, and take also of the tree of life," (3:22)
11. Christ's blood \_\_\_\_\_ for everyone's sins.
12. The way a baby communicates.
13. First home of Adam and Eve. (2:15)
14. Cain killed \_\_\_\_\_. (4:8)
17. God said to Eve, "In \_\_\_\_\_ (plural) thou shalt bring forth children" (3:16)
18. God \_\_\_\_\_ the world and everything in it.
20. God said, "*It* is not good that the man should be alone; I will make him an help \_\_\_\_\_ for him." (2:18)
22. To express appreciation.
24. What was on the sword that kept Adam and Eve from the tree of life. (3:24)
25. Adam gave these to all the animals. (2:19)
28. To disobey or ignore rules; Adam and Eve did this.
29. Sex of first human. (1:27)
30. A period of time.
32. Man was made on the sixth \_\_\_\_\_ .

**Year 1**

**Week 3**

## **The Temptation and Fall of Man**

**Scriptures: Genesis 3**

**Key Verse:**

**Genesis 3:8 "And they heard the sound of the Lord God walking in the garden in the cool of the day, and Adam and his wife hid themselves from the presence of the Lord God among the trees of the garden."**

**Key Points:**

- 1.** God gave Adam and Eve only one rule in the garden - not to eat of the tree in the middle of the garden.
- 2.** Satan deceived Eve and she disobeyed by eating of the tree. She encouraged Adam and he ate also. Both having their eyes opened, they knew they had sinned and tried to hide from God.
- 3.** God confronted Adam and Eve about their sin and made clothes for them of animal skins.
- 4.** The serpent, the man and the woman were to suffer the consequences of God's judgement because of their sin.
- 5.** The tree of knowledge changed the way man would live and die, and led to the need for Jesus as a sacrifice for our sins.

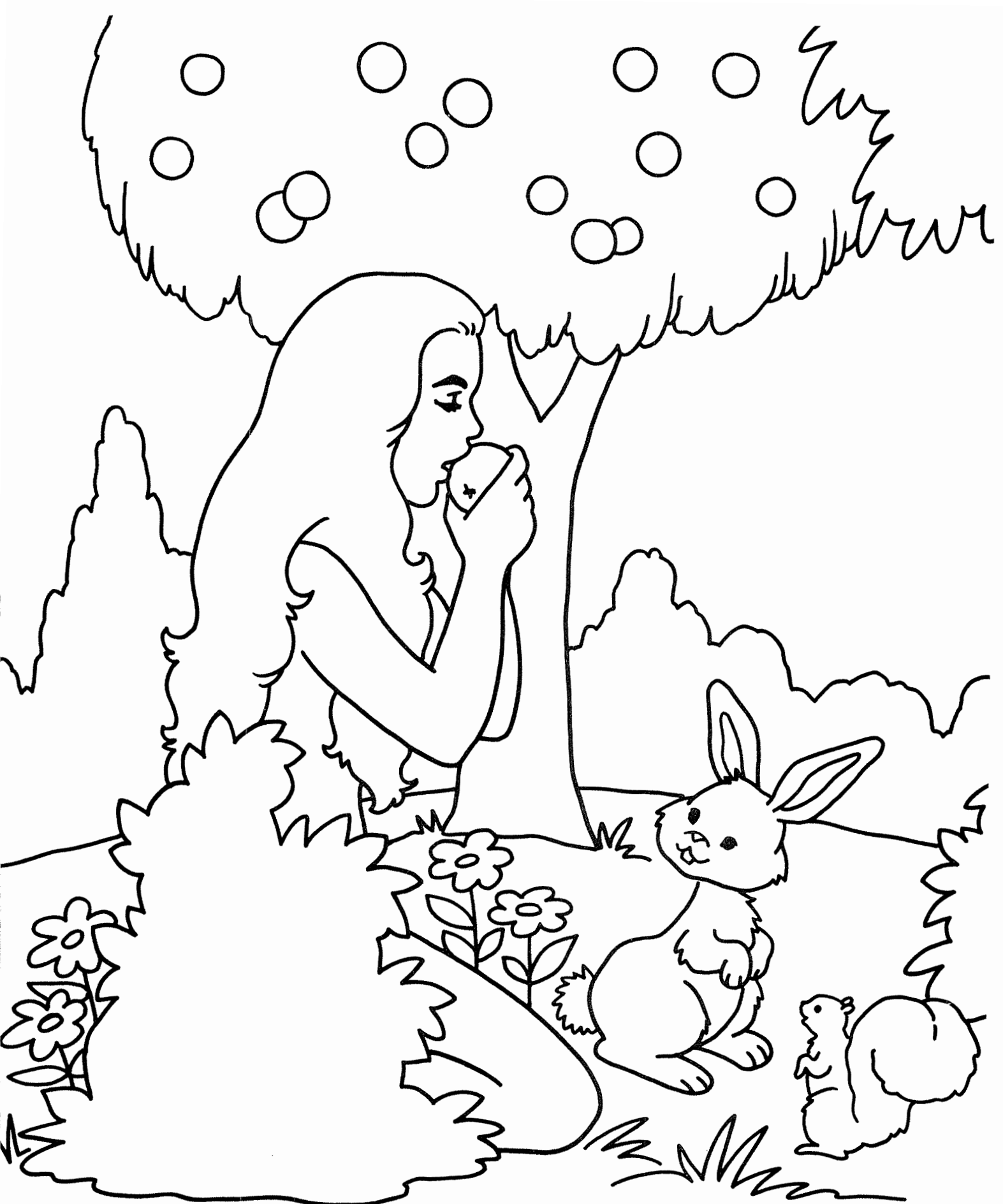

God told Adam and Eve they could eat any fruit in the garden except for one kind. One day, the devil tempted Eve to eat that fruit.

*Genesis 2:16, 17; 3:1-6*

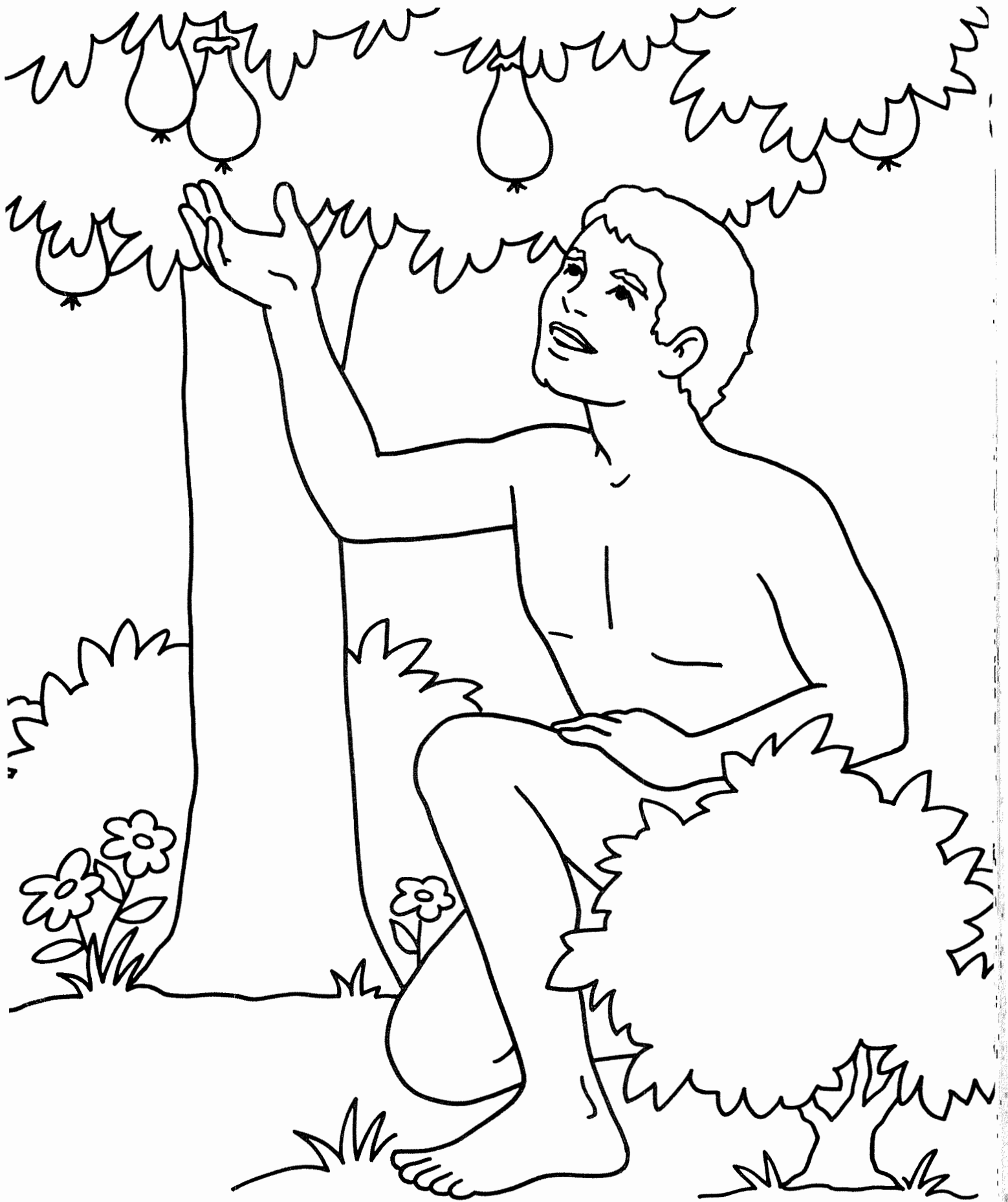

Adam also ate the fruit. Then Adam and Eve were ashamed, and tried to hide from God. But no one can hide from God.

*Genesis 3:6-8*

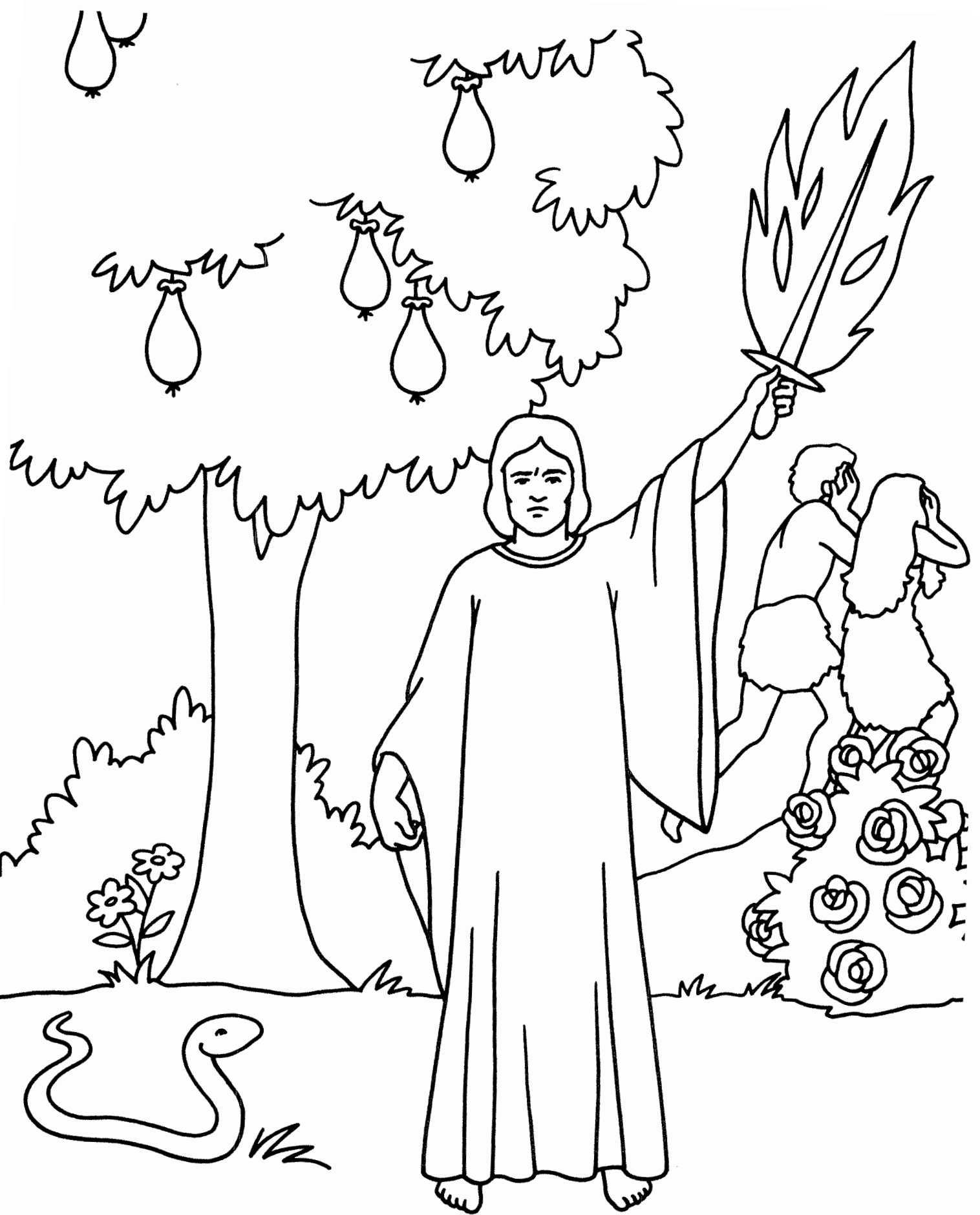

Because they disobeyed Him, God sent Adam and Eve out of the beautiful Garden of Eden.

*Genesis 3:22-24*

# THE FIRST SIN

Genesis 3

Connect  
the dots  
to see how  
Adam and  
Eve  
sinned.

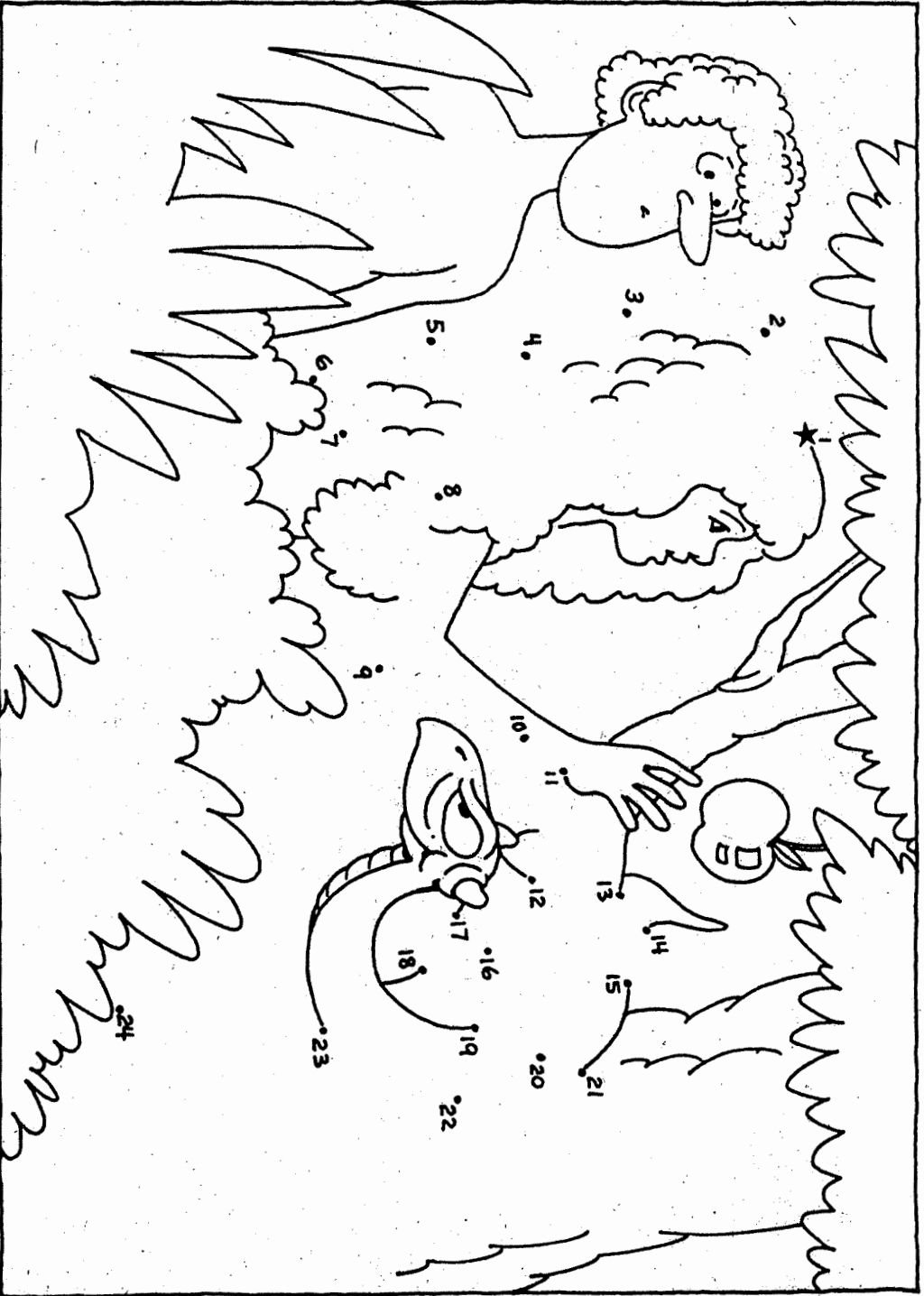

Adam and Eve could have stayed in the beautiful garden forever if they had obeyed God. But they ate fruit from the one tree God told them not to touch. That was the first sin. After that God made them leave the Garden of Eden.





## Word List

- Adam
- apple
- Eden
- Eve
- love
- snake
- tree

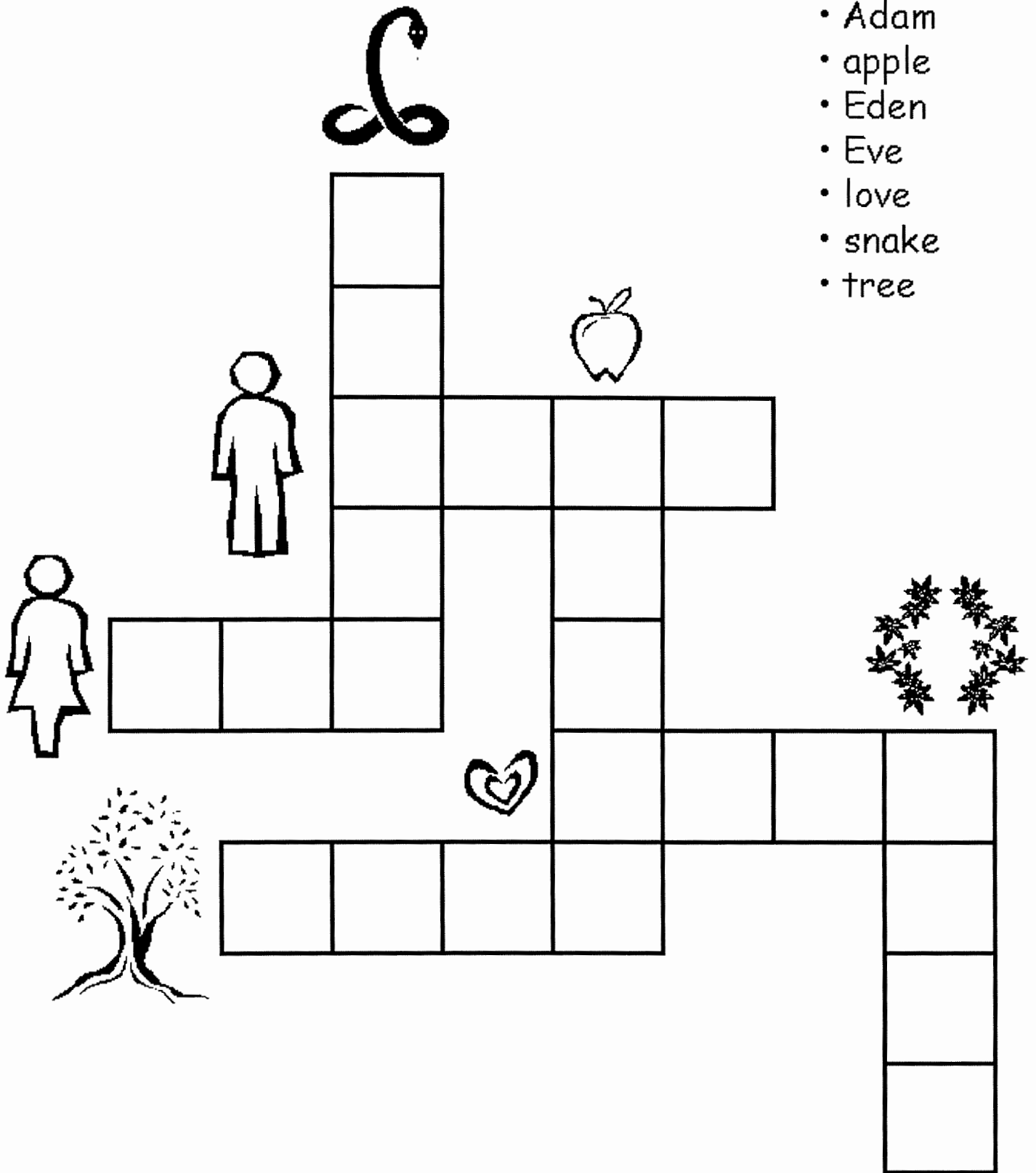

So he drove out the man; and he placed at the east of the garden of Eden Cherubims, and a flaming sword which turned every way, to keep the way of the tree of life.

*Genesis 3:24*

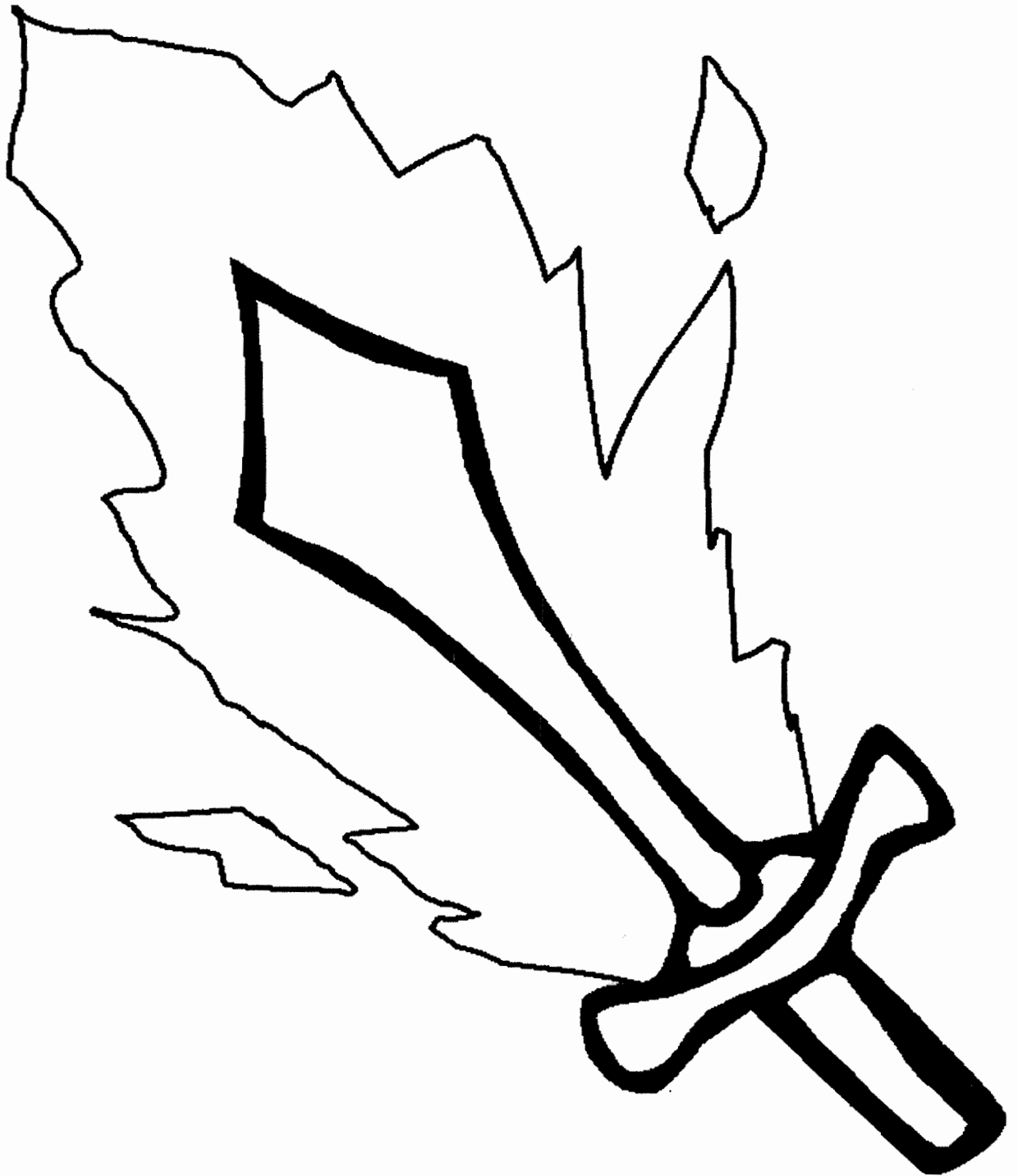

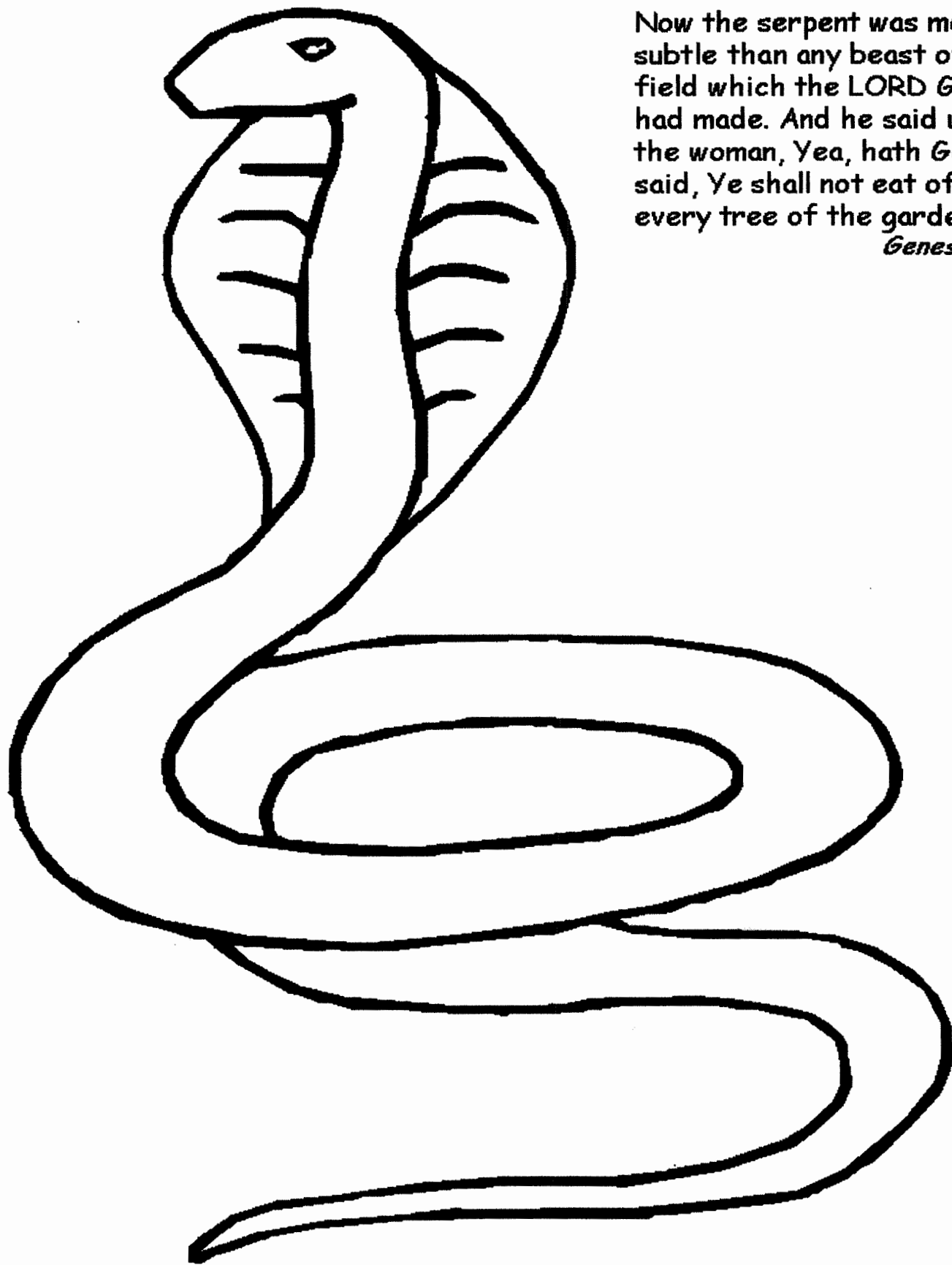

Now the serpent was more subtle than any beast of field which the LORD God had made. And he said unto the woman, Yea, hath God said, Ye shall not eat of every tree of the garden

*Genesis*

**Year 1**

**Week 4**

## **The First Brothers**

**Scriptures: Genesis 4:1-26**

**Key Verse:**

**Gen. 4:9 "Then the LORD said to Cain, Where is Abel thy brother? And he said, I know not: am I my brother's keeper?"**

**Key Points:**

- 1.** Adam and Eve had two sons-Cain and Abel.  
Abel was a shepherd; Cain tilled the ground.
- 2.** By faith, Abel brought sheep to sacrifice to God, but Cain brought offerings from his crops. God respected Abel's offering. Cain became very angry.
- 3.** God asked Cain why he was angry, and encouraged him to do the right thing and not sin. Cain made the wrong choice and killed Abel.
- 4.** God punished Cain, but put a mark on Cain to protect him from others.

# CAIN AND ABEL (GENESIS 4:1-17)

- 8 ACROSS "If you do well, will you not be accepted? And if you do not do well, sin lies at the door. And its desire is for you, but you should \_\_\_\_\_ over it." *GENESIS 4:7*
- 2 ACROSS "It came to pass that Cain brought an \_\_\_\_\_ of the fruit of the ground to the LORD." *GENESIS 4:3*
- 6 DOWN "\_\_\_\_\_ also brought of the firstlings of his flock and of their fat." *GENESIS 4:4*
- 5 DOWN "And \_\_\_\_\_ was very angry, and his countenance fell." *GENESIS 4:5*
- 6 ACROSS "So the LORD said to Cain, 'Why are you so \_\_\_\_\_?' " *GENESIS 4:6*
- 1 DOWN "Now Cain talked with Abel his brother; and it came to pass, when they were in the field, that Cain rose against Abel his brother and \_\_\_\_\_ him." *GENESIS 4:8*
- 3 DOWN The LORD said to Cain, "What have you done? The voice of your brother's blood cries out to Me from the \_\_\_\_\_." *GENESIS 4:10*
- 5 ACROSS "So now you are \_\_\_\_\_ from the earth, which has opened its mouth to receive your brother's blood from your hand." *GENESIS 4:11*
- 7 DOWN "And Cain said to the LORD, 'My \_\_\_\_\_ is greater than I can bear!' " *GENESIS 4:13*
- 4 DOWN "Then Cain went out from the presence of the \_\_\_\_\_ and dwelt in the land of Nod on the east of Eden." *GENESIS 4:16*

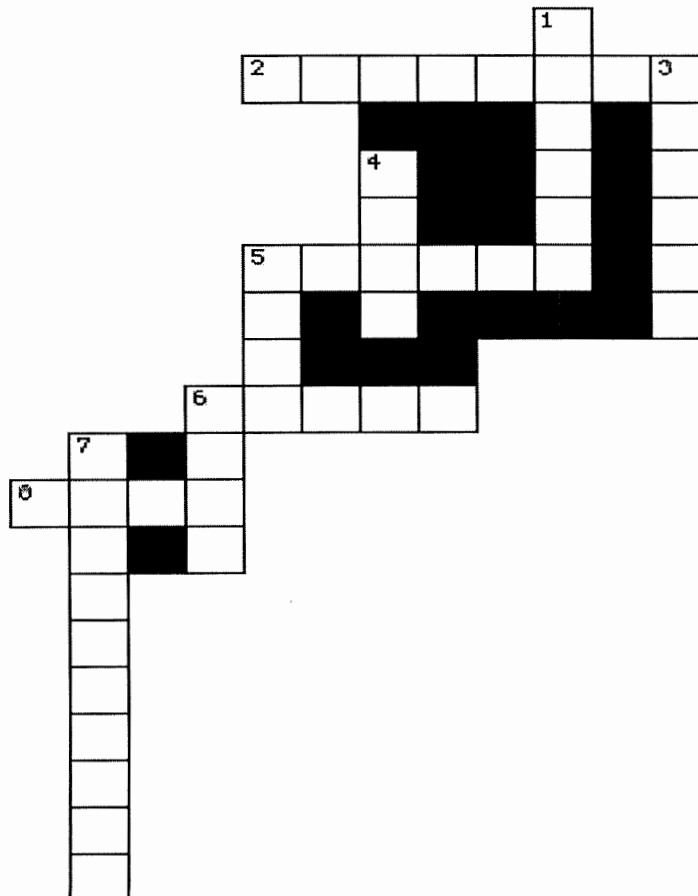

# Cain and Abel

Genesis 4:1-13

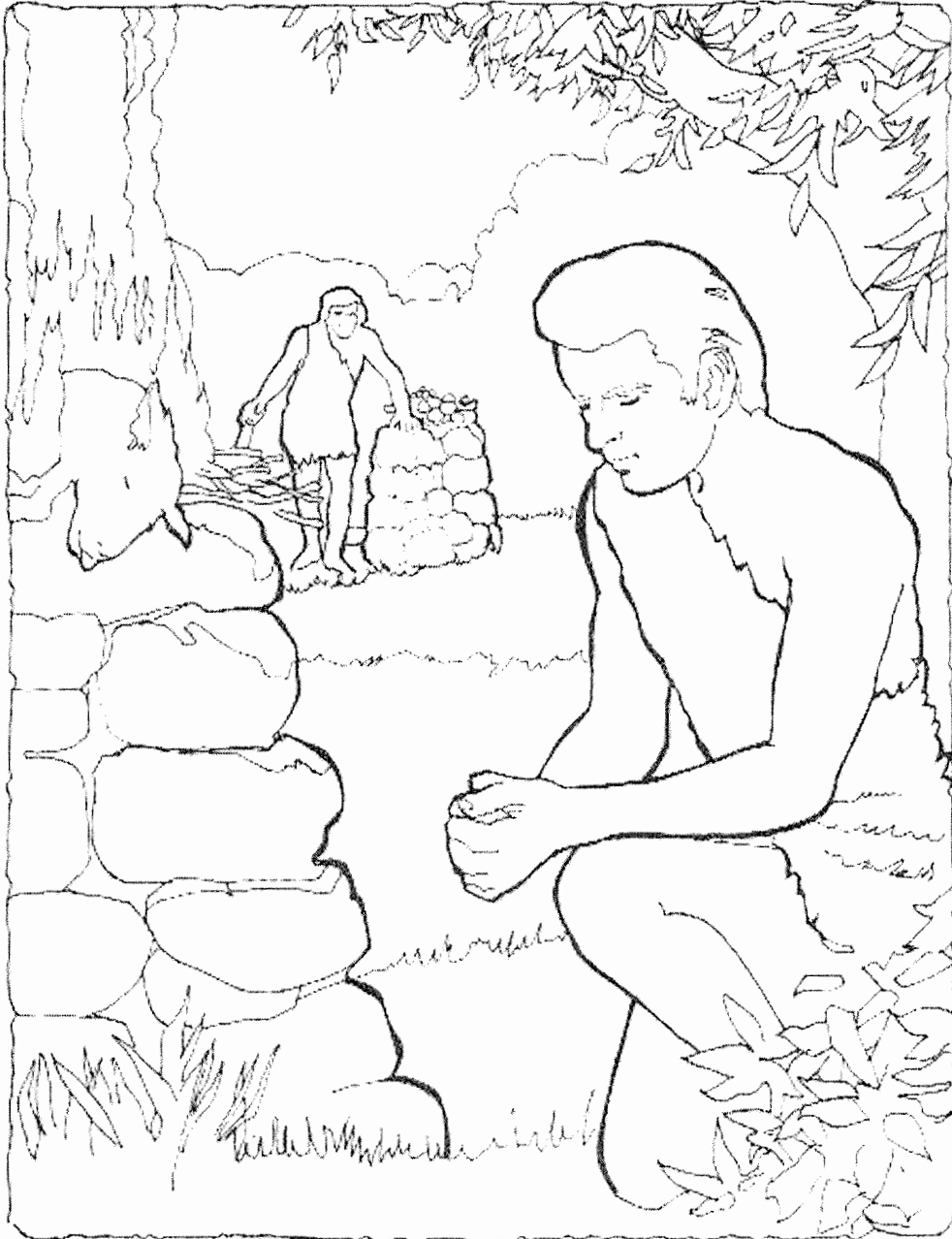

***If you do well, will you not be accepted? And if you do not do well, sin is at the door. And it's desire is for you, but you must master it.***

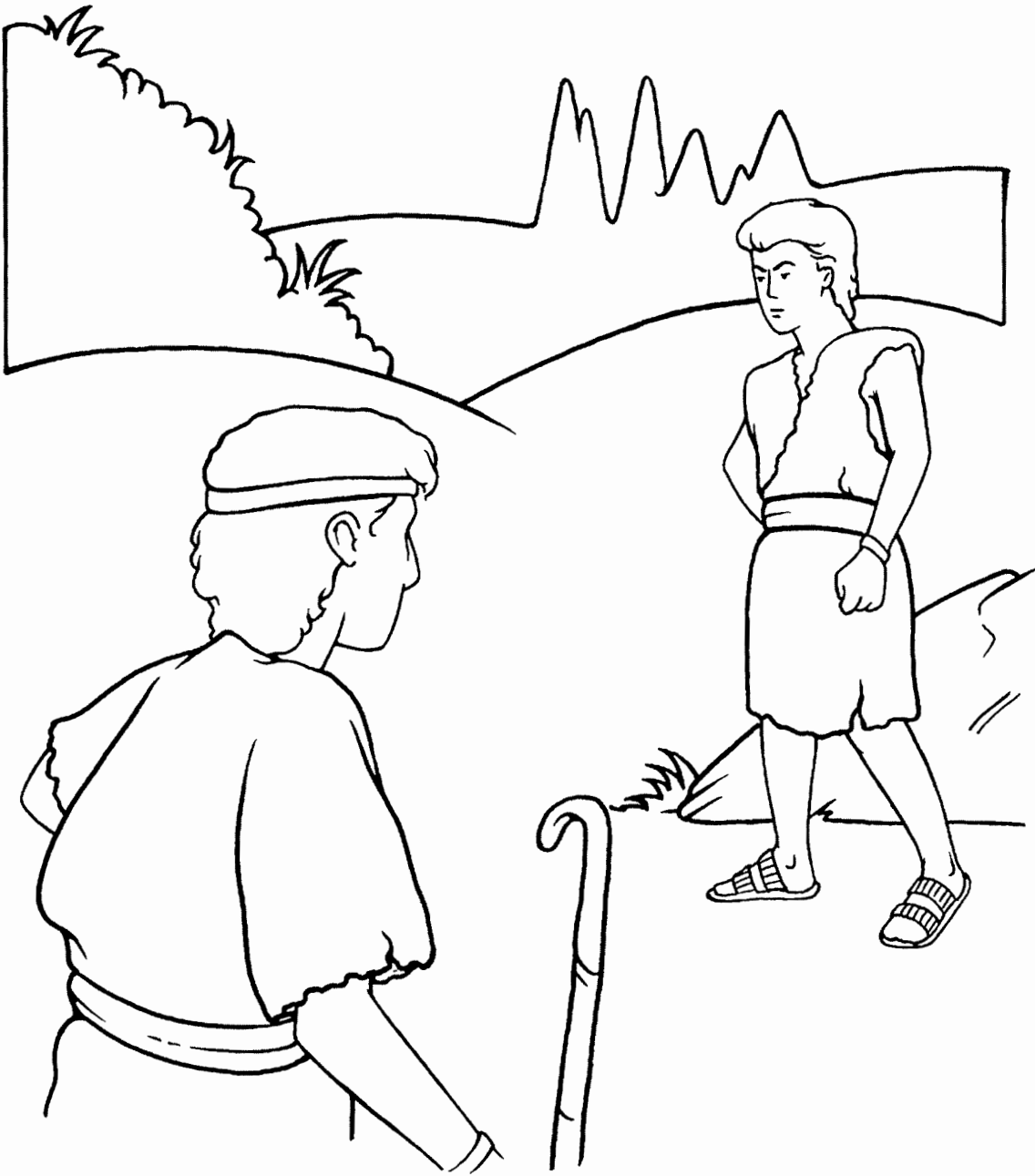

"Now Cain talked with Abel his brother; and it came to pass, when they were in the field, that Cain rose against Abel his brother and killed him."

**GENESIS 4:8**





Asfahar

Asfahar

Asfahar



Asfahar

Asfahar

Asfahar

Choose the correct face and place below each scripture.

Genesis 4:3

Abel also brought of the firstlings of his flock and of their fat. And the Lord respected Abel and his offering.

---

Genesis 4:5

But the Lord did not respect Cain and his offering. And Cain was very angry and his countenance fell.

---

# Cain and Abel

GENESIS 4:1, 2

Complete each word by adding a letter.  
The Scriptures will help you spell each  
word. Then read down to discover the  
secret word.

SECRET WORD: \_\_\_\_\_

	—	a	r	e		
g	—	o	u	n	d	
G	—	d				
	—	i	l	l	e	r
s	—	e	e	p		
A	b	—	l			
f	—	o	m			
	—	h	e			



# The First Brothers – Cain and Abel

P Z L D I C H S O S

D U S E A J S W R T

E F N I B H A E S C

S I N I E A H Q N E

R E V E S T J S K P

U L P X O H Z L Q S

C D K R H Q M F N E

N S B E B V H E F R

S H E P H E R D N G

R E M R A F L D U T

ABEL      BROTHERS      CAIN

CURSED      FARMER      FIELDS

PUNISHMENT      RESPECT      SHEEP      SHEPHERD

# CAIN AND ABEL

(GENESIS 4:1-17)

P	K	M	A	R	K	R	N	F	R	A	H	I	T	L
U	H	I	Z	X	E	T	I	E	I	B	C	L	O	Y
N	C	Z	L	L	H	R	S	K	L	E	C	R	P	F
I	O	X	L	L	S	P	D	E	R	L	D	E	S	R
S	V	I	U	T	E	E	Z	E	Q	S	N	R	K	U
H	T	Y	B	C	S	D	F	P	I	F	E	I	Z	I
M	N	O	T	R	M	Q	N	E	J	H	U	E	O	T
E	R	E	U	A	X	V	X	R	T	Q	K	V	V	Y
N	D	C	I	D	I	U	A	O	L	V	S	E	L	P
T	J	A	J	A	V	G	R	F	J	M	U	A	C	D
P	L	E	L	M	N	B	D	S	V	R	N	K	F	D
O	F	F	E	R	I	N	G	H	R	B	E	Q	I	A
H	D	M	M	E	A	B	P	E	R	I	S	Y	E	W
A	N	G	R	Y	C	D	U	E	K	U	N	R	L	Z
K	R	X	P	C	M	O	K	P	J	Q	T	M	D	C

ABEL  
ADAM  
ANGRY  
BROTHERS  
CAIN  
CURSED

EVE  
FIELD  
FIRSTBORN  
FRUIT  
KEEPER OF SHEEP  
KILLED

LORD  
MARK  
OFFERING  
PUNISHMENT  
RESPECTED  
TILLER



# Cain and Abel Crossword

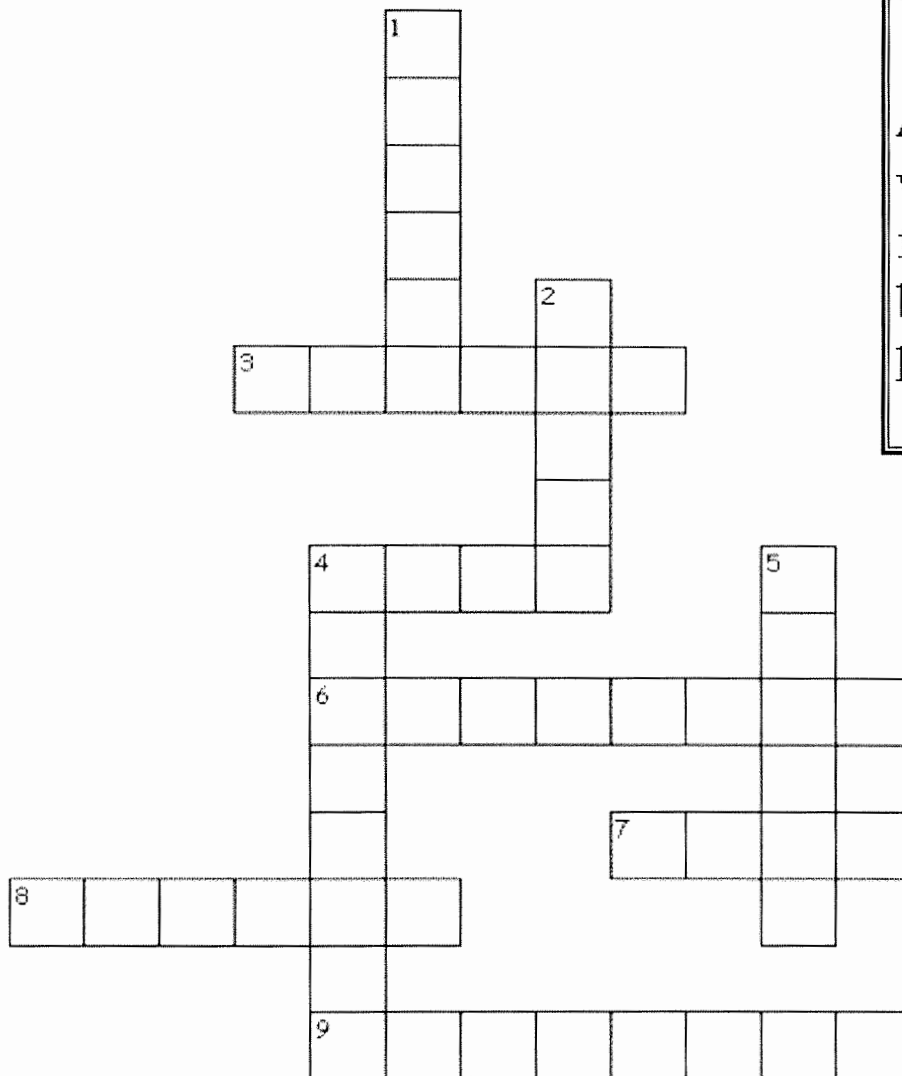

Word List	
Abel	brothers
wander	sinned
farmer	shepherd
best	offering
heart	keeper

## Across

3. Cain worked the soil, he was a \_\_\_\_\_.
4. God wants our \_\_\_\_\_ when we give to Him.
6. Abel knew this was important to God.
7. His offering was pleasing to God.
8. Cain did this when he killed his brother.
9. Abel watched the animals, he was this.

## Down

1. Are you your brother's \_\_\_\_\_?
2. God didn't like Cain's attitude in his \_\_\_\_\_.
4. How were Cain and Abel related?
5. Part of Cain's punishment was that he would \_\_\_\_\_ the earth.

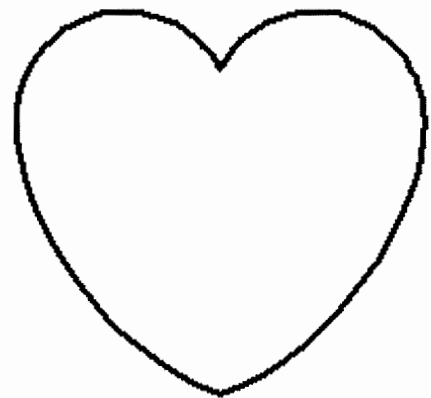

# CAIN AND ABEL

## (GENESIS 4:1-17)

### MEMORY VERSE:

*"If you do well, will you not be accepted? And if you do not do well, sin lies at the door. And its desire is for you, but you should rule over it." Genesis 4:7*

### FILL IN THE BLANKS:

1. "It came to pass that \_\_\_\_\_ brought an offering of the fruit of the ground to the LORD." **GENESIS 4:3**
2. "\_\_\_\_\_ also brought of the \_\_\_\_\_ of his flock and of their fat." **GENESIS 4:4**

### CIRCLE THE CORRECT ANSWER:

3. Whose offering did the Lord respect? **GENESIS 4:4-5**  
**CAIN'S                      ABEL'S                      NO ONE'S**
4. "So the LORD said to Cain, 'Why are you so ( HAPPY, ANGRY )?' " **GENESIS 4:6**

### TRUE OR FALSE:

5. "Now Cain talked with Abel his brother; and it came to pass, when they were in the field, that Cain rose against Abel his brother and killed him." **GENESIS 4:8**  
**TRUE OR FALSE**
6. The LORD said to Cain, "What have you done? The voice of your brother's blood cries out to Me from the ground." **GENESIS 4:10**  
**TRUE OR FALSE**

### FILL IN THE BLANK:

7. "So now you are \_\_\_\_\_ from the earth, which has opened its mouth to receive your brother's blood from your hand." **GENESIS 4:11**

### CIRCLE THE CORRECT WORD:

8. "And Cain said to the LORD, 'My punishment is ( GREATER, SMALLER ) than I can bear!' " **GENESIS 4:13**

### TRUE OR FALSE:

9. "Then Cain went out from the presence of the LORD and dwelt in the land of Nod on the east of Eden." **GENESIS 4:16**  
**TRUE OR FALSE**

# CAIN AND ABEL

**(GENESIS 4:1-17)**

## ***FILL IN THE BLANK***

1. "It came to pass that \_\_\_\_\_ brought an offering of the fruit of the ground to the LORD." **GENESIS 4:3**
2. " \_\_\_\_\_ also brought of the \_\_\_\_\_ of his flock and of their fat." **GENESIS 4:4**
3. "And the LORD respected \_\_\_\_\_ and his offering." **GENESIS 4:4**
4. "But He did not respect \_\_\_\_\_ and his offering." **GENESIS 4:5**
5. "So the LORD said to Cain, 'Why are you so \_\_\_\_\_ ?' " **GENESIS 4:6**

## ***TRUE OR FALSE:***

6. "Now Cain talked with Abel his brother; and it came to pass, when they were in the field, that Cain rose against Abel his brother and killed him." **GENESIS 4:8**

**TRUE OR FALSE**

7. The LORD said to Cain, "What have you done? The voice of your brother's blood cries out to Me from the ground." **GENESIS 4:10**

**TRUE OR FALSE**

## ***FILL IN THE BLANKS:***

8. "So now you are \_\_\_\_\_ from the earth, which has opened its mouth to receive your brother's blood from your hand." **GENESIS 4:11**
9. "And Cain said to the LORD, 'My punishment is \_\_\_\_\_ than I can bear!' " **GENESIS 4:13**
10. "Then Cain went out from the \_\_\_\_\_ of the LORD and dwelt in the land of Nod on the east of Eden." **GENESIS 4:16**



**Year 1**

**Week 5**

## **Noah**

**Scriptures: Genesis 6 & 7**

**Key Verse:**

**Genesis 6:22 "Thus Noah did; according to all that God commanded him, so he did."**

**Key Points:**

- 1.** God saw how wicked people had become, and He was sorry He had made them.
- 2.** Noah found grace in the eyes of the Lord. He walked with God in all his ways and built an ark according to God's instructions.
- 3.** He gathered clean and unclean animals into the ark with his family as God commanded.
- 4.** God shut the door of the ark and it rained 40 days and nights.
- 5.** Because of Noah's obedience, he and his family were the only ones saved on the earth.





God Saves Noah  
*Genesis 6, 7*

DLTK's Mini Books

# Noah and His Ark



Helping Children Grow



Free printables from <http://www.dltk-teach.com>

Created by: Leanne Guenther



God saw that the  
people on His earth  
were mean.

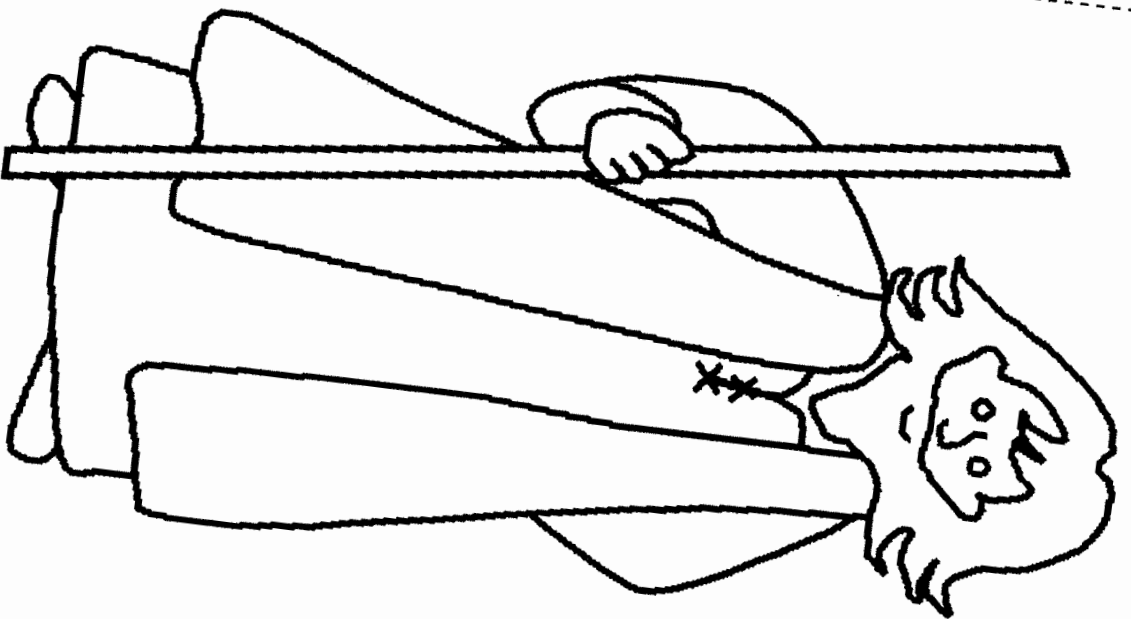

Except for one man,  
named Noah.

1

2

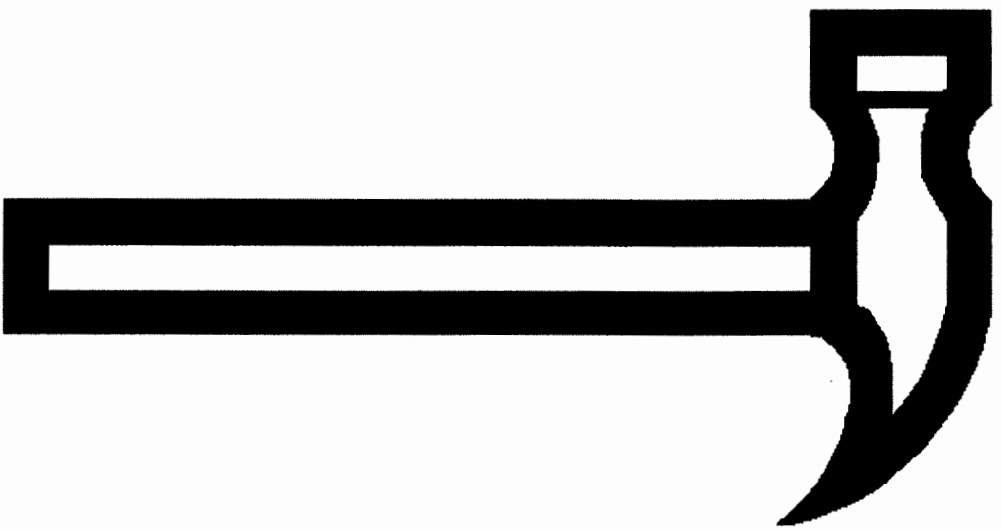

**God told Noah to  
build a boat.**

3

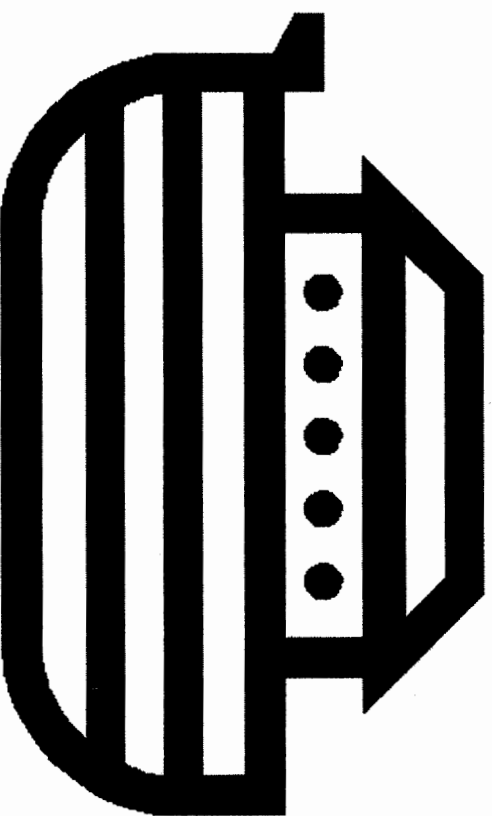

**Noah obeyed. He  
built an ark.**

4

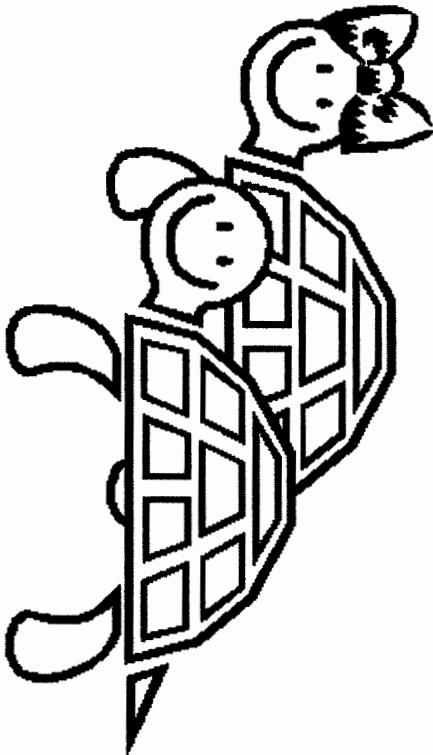

God sent two of each  
kind of animal to  
board the ark.

5

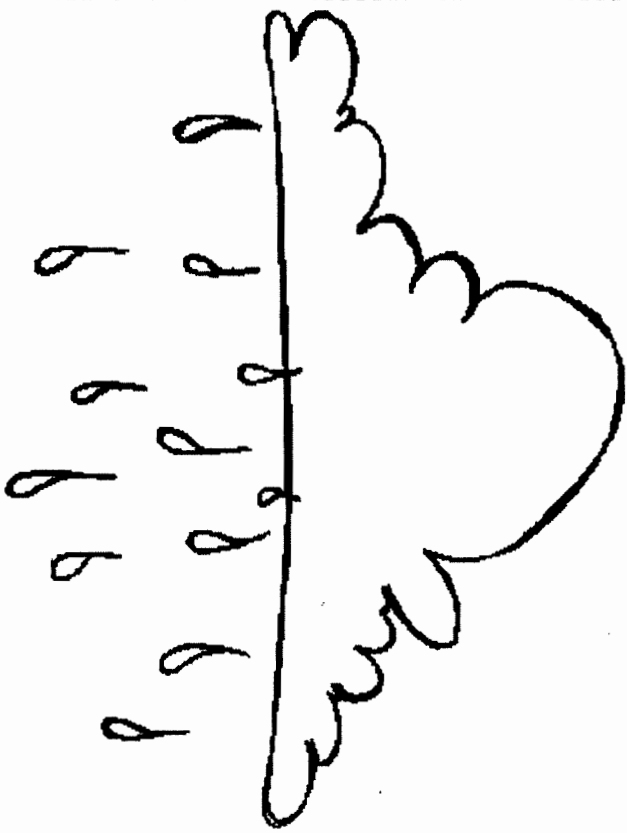

The rain came down.  
It washed away the  
mean people.

6



**Noah sent a dove to  
find dry land. The  
dove brought back an  
olive branch.**

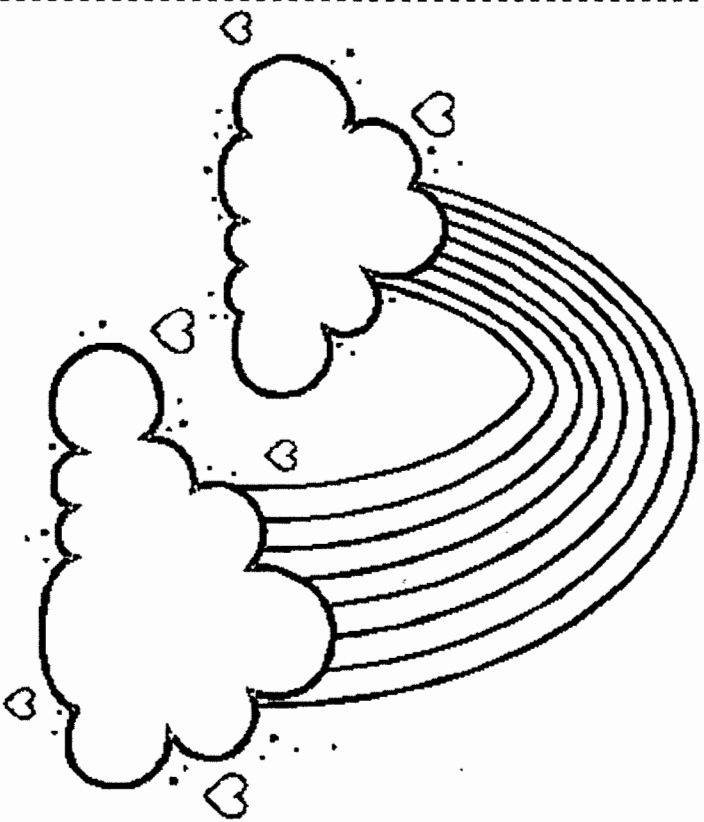

**God sent a rainbow  
as a promise never  
to send such a flood  
again.**



N

is for Noah  
Who built a great ark.  
He floated around 'til  
He found where to park.



Make ark using cardstock for extra strength.

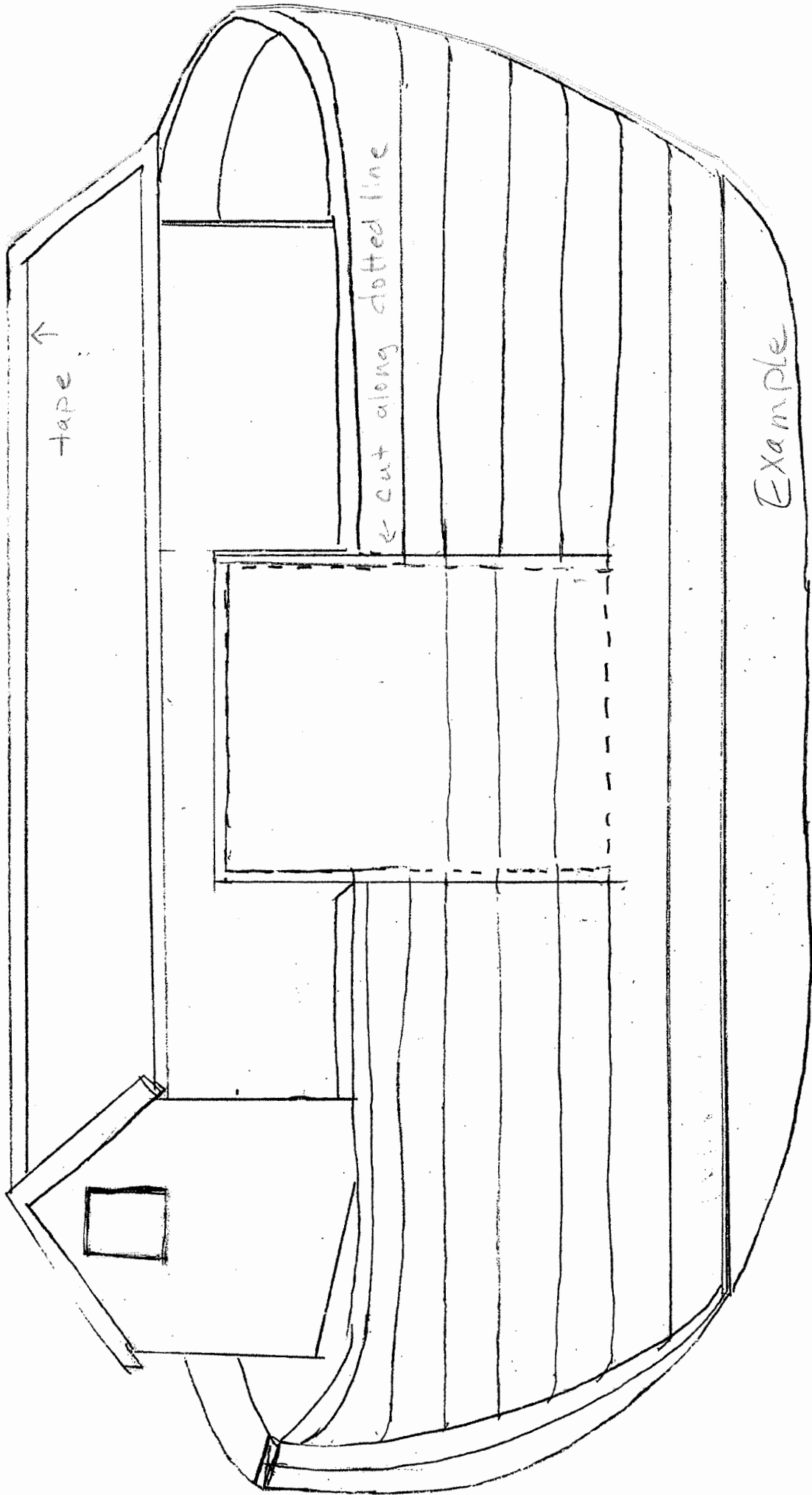



Make ark using cardstock for extra strength.  
(Back)

Make ark using cardstock for extra strength.

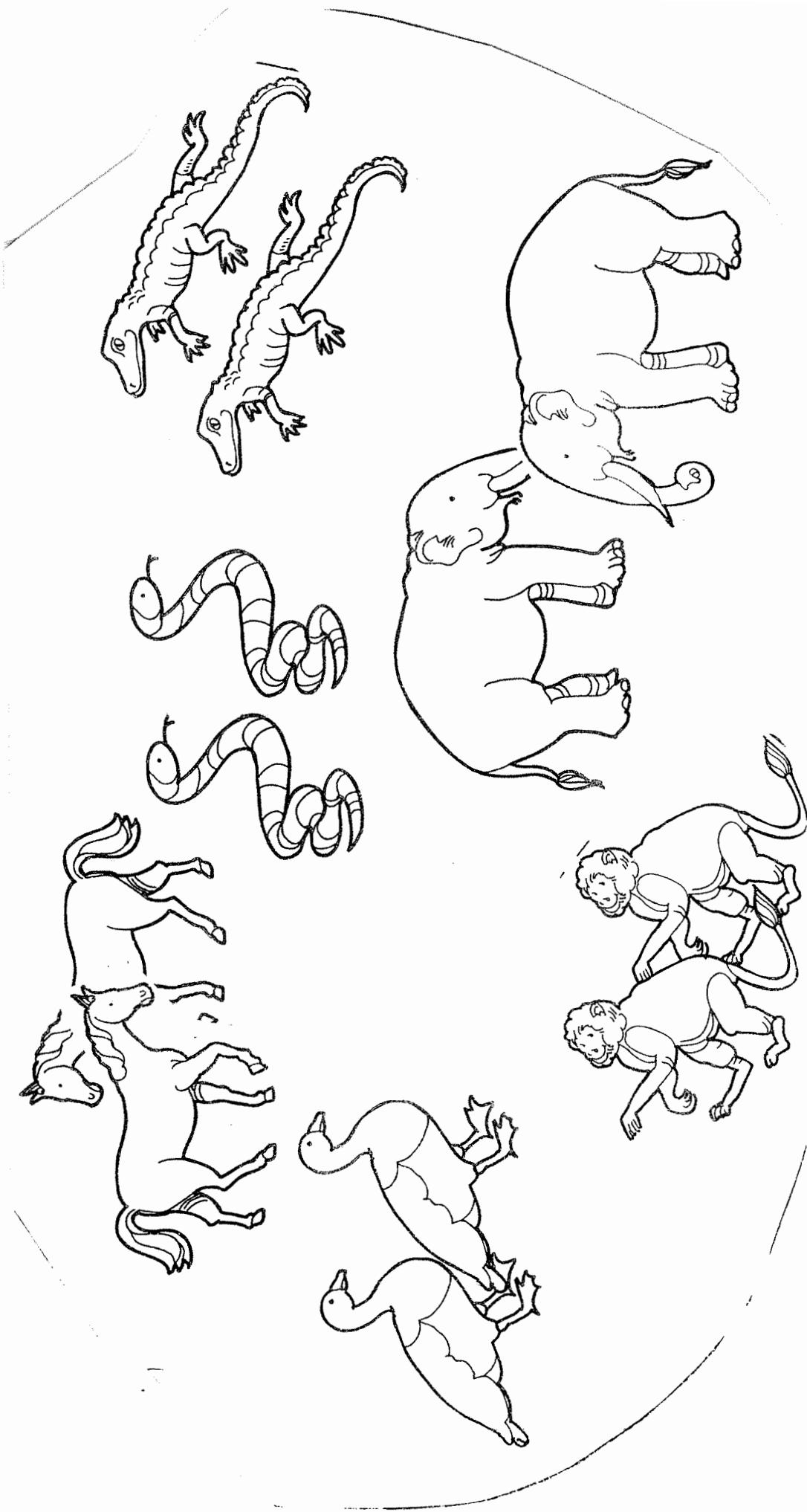

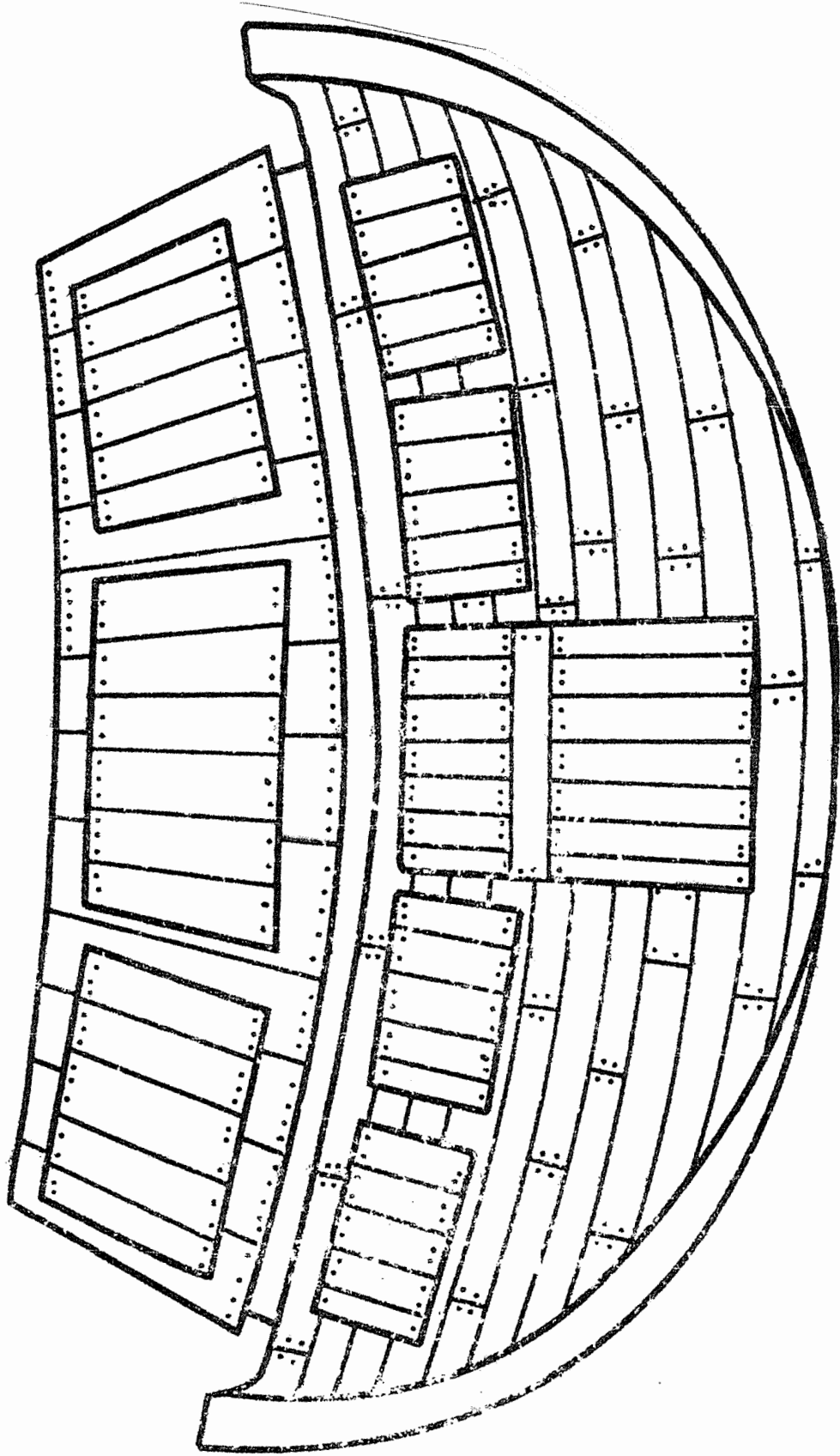

The Flood  
Genesis 6,7

# On the Ark

God told Noah to build a very big boat for his family and two each of all the animals. Noah obeyed God. What happened next? Fill in the letter missing from each animal pictured. Copy the missing letters in order onto the lines at the bottom of the page. These letters will spell the answer.



P I



M  O S E



O L P H I N



N A K E



B E  R



A A R D  A R K



L I O



T I G  R



B I R



C  W



C  T

O R S E



— — —  
— — — — —  
— — — — —

# Noah's Ark Crossword

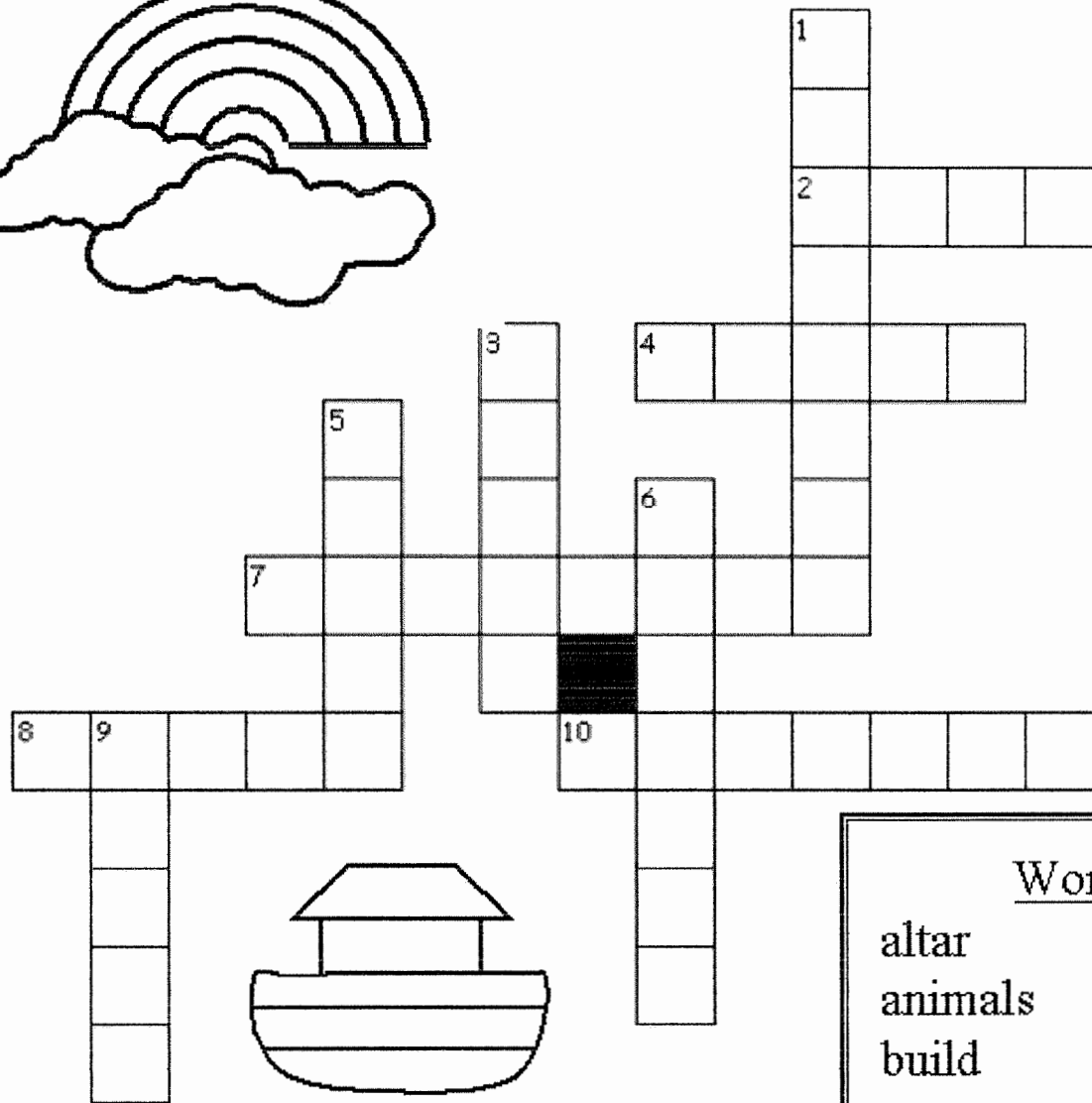

<u>Word list</u>	
altar	flood
animals	obedient
build	rainbow
covenant	raven
evil	saved

## Across

- Every man on earth was \_\_\_\_\_ except for Noah and his sons.
- God gave Noah instructions so he could \_\_\_\_\_ the ark.
- This is another word for a promise that God made about the flood.
- Noah was \_\_\_\_\_ because he was a righteous man and he walked with God.
- The ark was full of lots of pairs of these.

## Down

- Noah was very \_\_\_\_\_ and listened to God.
- Noah sent this type of bird first to see if there was land outside the ark.
- God washed the earth from all the evil by sending this.
- This is a sign that God will never flood the earth again.
- Noah and his family made this as soon as they got off the ark.

# Noah's Ark Crossword

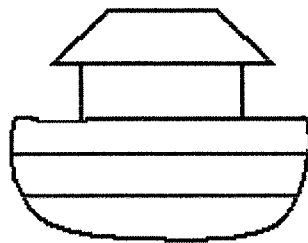
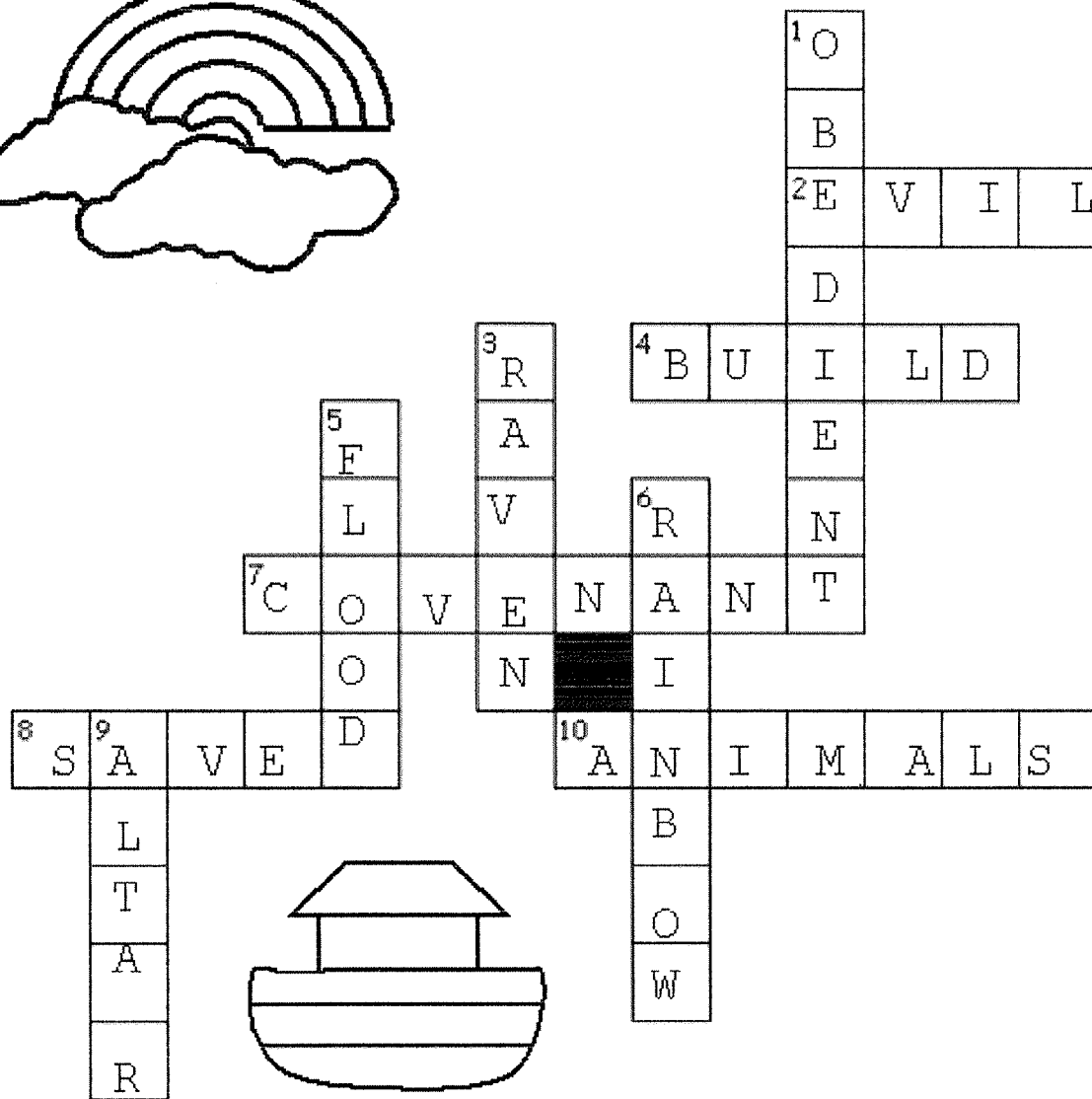

## Across

2. Every man on earth was \_\_\_\_\_ except for Noah and his sons.
4. God gave Noah instructions so he could \_\_\_\_\_ the ark.
7. This is another word for a promise that God made about the flood.
8. Noah was \_\_\_\_\_ because he was a righteous man and he walked with God.
10. The ark was full of lots of pairs of these.

## Down

1. Noah was very \_\_\_\_\_ and listened to God.
3. Noah sent this type of bird first to see if there was land outside the ark.
5. God washed the earth from all the evil by sending this.
6. This is a sign that God will never flood the earth again.
9. Noah and his family made this as soon as they got off the ark.



# GOD SENDS A GREAT FLOOD

## (GENESIS 7:1-8:19)

### FILL IN THE BLANK:

1. "The LORD said to Noah, 'Come into the ark, you and all your household, because I have seen that you are \_\_\_\_\_ before Me in this generation.'" GENESIS 7:1

### UNDERLINE THE CORRECT ANSWER:

2. The LORD said, 'You shall take with you...'" GENESIS 7:2-3
- a. seven each of every clean animal, a male and his female
  - b. two each of animals that are unclean, a male and his female
  - c. seven each of birds of the air, male and female
  - d. all of the above

### TRUE OR FALSE:

3. "And Noah did according to all that the LORD commanded him." GENESIS 7:5  
TRUE OR FALSE

### FILL IN THE BLANKS:

4. "So Noah, with his sons, his wife, and his sons' wives, went into the ark because of the waters of the \_\_\_\_\_. Of the clean beasts, of beasts that are unclean, of birds, and of everything that creeps on the earth, \_\_\_\_\_ they went into the ark to Noah, male and female, as God had commanded Noah." GENESIS 7:7-9

### TRUE OR FALSE:

5. "So those that entered, male and female of all flesh, went in as God had commanded him; and the LORD shut him in." GENESIS 7:16

TRUE OR FALSE

### FILL IN THE BLANKS:

6. "Now the flood was on the earth \_\_\_\_\_ days. The waters increased and lifted up the ark, and it rose high above the earth." GENESIS 7:17

7. "And the waters prevailed exceedingly on the earth, and all the high hills under the whole heaven were \_\_\_\_\_." GENESIS 7:19

8. " \_\_\_\_\_ in whose nostrils was the breath of the spirit of life, \_\_\_\_\_ that was on dry land, \_\_\_\_\_." GENESIS 7:22

9. "And the waters prevailed on the earth one hundred and fifty days. Then God \_\_\_\_\_ Noah, and every living thing, and all the animals that were in the ark. And God made a wind to pass over the earth, and the waters subsided. GENESIS 7:24-8:1

10. "God spoke to Noah, saying, ' \_\_\_\_\_ the ark, you and your wife, and your sons' wives with you.'" GENESIS 8:15-16

# GOD SENDS A GREAT FLOOD

## (GENESIS 7:1-8:19)

### TRUE OR FALSE:

1. "The LORD said to Noah, 'Come into the ark, you and all your household, because I have seen that you are righteous before Me in this generation.' " GENESIS 7:1

TRUE OR FALSE

### UNDERLINE THE CORRECT ANSWER:

2. The LORD said, 'You shall take with you...' " GENESIS 7:2-3
- a. seven each of every clean animal, a male and his female
  - b. two each of animals that are unclean, a male and his female
  - c. seven each of birds of the air, male and female
  - d. all of the above

### TRUE OR FALSE:

3. "And Noah did according to all that the LORD commanded him." GENESIS 7:5

TRUE OR FALSE

### CIRCLE THE CORRECT WORDS:

4. "So Noah, with his sons, his wife, and his sons' wives, went into the ark because of the waters of the (RIVERS, FLOOD). Of the clean beasts, of beasts that are unclean, of birds, and of everything that creeps on the earth, (TWO BY TWO, THREE BY THREE) they went into the ark to Noah, male and female, as God had commanded Noah." GENESIS 7:7-9

### TRUE OR FALSE:

5. "So those that entered, male and female of all flesh, went in as God had commanded him; and the LORD shut him in." GENESIS 7:16

TRUE OR FALSE

6. "Now the flood was on the earth forty days. The waters increased and lifted up the ark, and it rose high above the earth." GENESIS 7:17

TRUE OR FALSE

### FILL IN THE BLANKS:

7. "And the waters prevailed exceedingly on the earth, and all the high hills under the whole heaven were \_\_\_\_\_." GENESIS 7:19

8. " \_\_\_\_\_ in whose nostrils was the breath of the spirit of life, \_\_\_\_\_ that was on dry land, \_\_\_\_\_." GENESIS 7:22

### CIRCLE THE CORRECT WORDS:

9. "And the waters prevailed on the earth one hundred and fifty days. Then God (FORGOT, REMEMBERED) Noah, and every living thing, and all the animals that were in the ark. And God made a wind to pass over the earth, and the waters subsided. GENESIS 7:24-8:1

10. "God spoke to Noah, saying, '(GO OUT OF, STAY IN) the ark, you and your wife, and your sons' wives with you.' " GENESIS 8:15-16

# GOD SENDS A GREAT FLOOD

## (GENESIS 7:1-8:19)

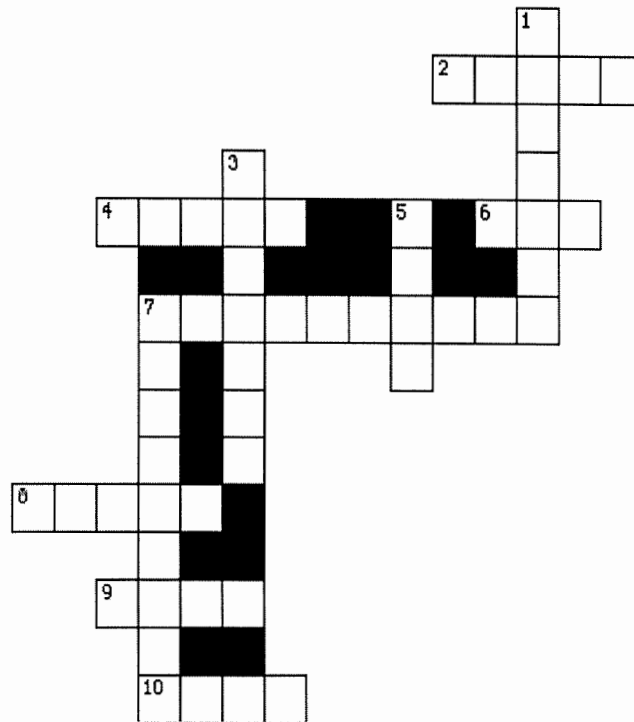

- 3 DOWN "The Lord is not slack concerning His \_\_\_\_\_ as some count slackness, but is longsuffering toward us, not willing that any should perish but that all should come to repentance." 2 PETER 3:9
- 7 DOWN "The LORD said to Noah, 'Come into the ark, you and all your household, because I have seen that you are \_\_\_\_\_ before Me in this generation.'" GENESIS 7:1
- 4 ACROSS The LORD said, "You shall take with you seven each of \_\_\_\_\_ clean animal, a male and his female." GENESIS 7:2
- 9 ACROSS "And \_\_\_\_\_ did according to all that the LORD commanded him." GENESIS 7:5
- 6 ACROSS "So Noah, with his sons, his wife, and his sons' wives, went into the \_\_\_\_\_ because of the waters of the flood." GENESIS 7:7
- 10 ACROSS "So those that entered, male and female of all flesh, went in as God had commanded him; and the LORD \_\_\_\_\_ him in." GENESIS 7:16
- 8 ACROSS "Now the flood was on the earth \_\_\_\_\_ days. The waters increased and lifted up the ark, and it rose high above the earth." GENESIS 7:17
- 1 DOWN "And the waters prevailed exceedingly on the earth, and all the high hills under the whole heaven were \_\_\_\_\_." GENESIS 7:19
- 5 DOWN "All in whose nostrils was the breath of the spirit of life, all that was on dry land, \_\_\_\_\_." GENESIS 7:22
- 7 ACROSS "And the waters prevailed on the earth one hundred and fifty days. Then God \_\_\_\_\_ Noah, and every living thing, and all the animals that were in the ark. And God made a wind to pass over the earth, and the waters subsided. GENESIS 7:24-8:1
- 2 ACROSS "God \_\_\_\_\_ to Noah, saying, 'Go out of the ark, you and your wife, and your sons' wives with you.'" GENESIS 8:15-16

# GOD SENDS A GREAT FLOOD

(GENESIS 7:1-8:19)

R C L E A N K A D T T K X L V  
I R A I N X V R R O N E V E S  
G S H H A O N K L A O D T S L  
H O D R A V E N C L R L L Y A  
T N F A E L E V I L O A F A M  
E S S E V I W F Y V J A T D I  
O K F T N T W I N D O W S Y N  
U O W E L O E G E V O D A T A  
S S T H G I N Y T R O F B R U  
U O Y F M O W T Y B O W T O V  
A P S N I A T N U O F L H F P  
U R E S T E D S D P I Y O R I  
R E M E M B E R E D P S P R R  
T F S Y A N S D R I B G U R D  
E D K R H C A E O W T M V E F

ANIMALS  
ARARAT  
ARK  
BIRDS  
CLEAN  
DOVE

FLOOD  
FORTY DAYS  
FORTY NIGHTS  
FOUNTAINS  
LORD RESTED  
NOAH

OLIVE  
RAIN  
RAVEN  
REMEMBERED  
WINDOWS  
RIGHTEOUS

LEAF  
SONS  
TWO BY TWO  
TWO EACH  
SEVEN  
WIVES

# GOD SENDS A GREAT FLOOD

## (GENESIS 7:1-8:19)

A S K F J P S A H M V K R T U X U A Q B S Q R F G A V Q L I  
 M G S N I A T N U O F D R W L X V Y X Y F F N D S B K H Y S  
 X D C V H Y Z C Z F A A Y L P G Z U Q K J H K R A H R U J C  
 T E T X G B F W Y S I D Y A M E A T F K S W Y H L P W N H T  
 Y P I S E D P J N N R O D P C I U W G F G U M D C U Y H W E  
 L Z O V U R G U J W L K J P C K E O A J A I Z F Y V B P Z K  
 I C R A V E N K T U W Q I A V X F B M M R E U W D L G U A E  
 O C T M W C K O P D J K P X Z P P Y M V A K L Y T R P Y P O  
 V Q A A S U O E T H G I R V K P T T A W S E I E L R F N X E  
 Q I N Z D G B I L S U L T Q F U O W O Z F Y K S V E Q M I N  
 Z W R S W R U T J J O W V D K Z N O K F N B N K V I K H C S  
 U Z P H W I K E C H E K R V S V I H C I T I M T P V L B N M  
 A K I M Y D N J V R P I F S M F J A Y Z Q R C E T U G O Z J  
 A K Q X R G C D T Q E J E M O F J E U T C D D F J V X Y F D  
 N Q D O P N U K O O T S J C A R O C D M D S N Y I P Q A N H  
 I J L S Z G M K W W C S T Z T K Y R Y G Y B Y R P I L O F R  
 M B D E R E B M E M E R O E M K T N T G R T J N K R J M P T  
 A B J V S Z D P H E S U U L D Y H A G Y Q I D L D F V B G K  
 L R Q O W E L Z H A O N G U Z R G I T R N O V M D V U H G R  
 S B R J B J V Y P W C E F T J G F Z I H T I C A W O X N Z X  
 N K I J M P S E J E H A K M S I Y S I U B W G X A I V X A W  
 M E L E W N V Y N B H V D O M C Q N P V K A U H Y Q V E B U  
 G F S A U U R O H E U C B E L K D C G Y N E A T T X E E K E  
 F J T W F O C J Q K A D A E X U C Z C A I P U O S S A V S E  
 H F O R T Y D A Y S E C A E P A M X E Y J Q T N G I F I O O  
 A T F L I F M F O S N N H M O V P L J R E T E D O O L F M Z  
 W E A Z X L L A A U C O K X C W C R N T F F K K M P I U Y N  
 X J Y X G L B H W H N Q S N D N T P H E S V O V X O M S S K  
 P Z Y T A R A R A P Q E K O U X O J E U A I O E T R I S G K  
 E Z O P Y M X A V E L N A B T O E P D S G F P F L A O A U J

ANIMALS  
 ARARAT  
 ARK  
 BIRDS  
 CLEAN  
 DOVE  
 FLOOD

FORTY DAYS  
 FORTY NIGHTS  
 FOUNTAINS  
 LORD RESTED  
 NOAH  
 OLIVE

RAIN  
 RAVEN  
 REMEMBERED  
 UNCLEAN  
 RIGHTEOUS  
 LEAF

SONS  
 TWO BY TWO  
 TWO EACH  
 SEVEN EACH  
 WINDOW  
 WIVES

# Noah's Ark

Genesis 6 — 9:15-16

Noah was a man who did good even when the people around him did bad. God had Noah build a big boat in which to protect Noah's family and the animals from a great flood. If you need help finding the correct words for the puzzle, look up the Scripture references from the story of Noah in Genesis.

## ACROSS

1. Water does this to whatever it touches.
4. God promised this would not cease as long as the earth remained. (8:22)
9. They went into the ark with Noah and his three sons. (7:7)
10. A son of Noah: \_\_\_\_\_ m. (6:10)
11. A large animal from the cat family that went into the ark.
12. Kind of offering Noah made after the flood. (8:20)
14. Sign of God's promise to never again destroy the earth with a flood. (9:15-16)
16. In the direction of; he went \_\_\_\_\_ school.
17. Built by Noah. (6:14)
22. Son of Noah. (6:10)
24. God is the \_\_\_\_\_ or Maker of all things.
27. To lift or raise with effort.
31. God saw the thoughts of man's heart were "only \_\_\_\_\_ continually." (6:5)
33. A region; she lives in the Chicago \_\_\_\_\_.
35. To be sorry for wrong-doing; people of Noah's time lacked this quality.
36. "For the \_\_\_\_\_ of God is revealed . . . against all ungodliness" (Romans 1:18)
38. "And the Lord shut him \_\_\_\_\_." (7:16)
39. A fierce member of the dog family that went into the ark.
40. Was upon the earth for forty days and nights. (7:12)
43. To allow; Mother \_\_\_\_\_ Carrie have a snack.

## DOWN

1. "Noah \_\_\_\_\_ with God." (6:9)
2. The unclean animals came into the ark by \_\_\_\_\_. (7:2)

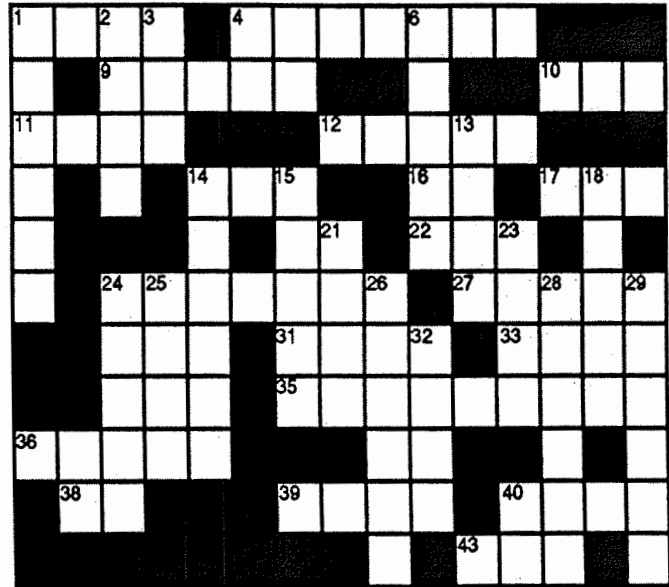

3. To do wrong.
4. "Thus did Noah; according to all that God commanded him, so did \_\_\_\_\_." (6:22)
6. All of this was covered with water. (7:19)
13. Built the ark. (6:13-14)
14. Everything that had the "\_\_\_\_\_ of life" was destroyed. (6:17)
15. Covered the hills. (7:19)
18. First bird Noah released. (8:7)
21. Bird that brought an olive leaf to Noah. (8:11)
23. Food which comes from animals.
24. Seven of this type of animal entered the ark. (7:2)
25. "The dove found no \_\_\_\_\_ for the sole of her foot," (8:9)
26. A small wave on water.
28. The mountains on which the ark came to rest. (8:4)
29. Noah took food into the ark to provide for this.
32. The dove carried this back to the ark. (8:11)

# Noah

Genesis 6:9-11, 13, 14, 17-22

Noah was a \_\_\_\_\_ man, blameless among the people of his time, and he \_\_\_\_\_ with God. Noah had three sons: \_\_\_\_\_, \_\_\_\_\_ and \_\_\_\_\_.

Now the earth was \_\_\_\_\_ in God's sight and was full of \_\_\_\_\_ . . . . God said to Noah, "I am going to put an end to all \_\_\_\_\_, for the earth is \_\_\_\_\_ with violence because of them. I am surely

going to \_\_\_\_\_ both them and the earth. So make yourself an ark of \_\_\_\_\_ wood. . . . I am going to bring \_\_\_\_\_ on the earth to destroy all \_\_\_\_\_ under the heavens, every \_\_\_\_\_ that has the breath of life in it. Everything on \_\_\_\_\_ will perish. But I will establish my \_\_\_\_\_ with you, and you will enter the \_\_\_\_\_ you and your sons and your \_\_\_\_\_ and your sons' \_\_\_\_\_ with you. You are to bring into the ark \_\_\_\_\_ of all living creatures, \_\_\_\_\_ and female, to keep them alive with you. Two of \_\_\_\_\_ kind of bird, of every \_\_\_\_\_ of animal and of every kind of creature that \_\_\_\_\_ along the \_\_\_\_\_ will come to you to be kept \_\_\_\_\_.

You are to take every kind of food that is to be \_\_\_\_\_ and store it away as \_\_\_\_\_ for you and for them." \_\_\_\_\_ did everything just as God \_\_\_\_\_ him.

L H A M H F K E V E R Y C F  
 C E S D A J E L A M I O C L  
 O R S C O R R U P T M R H O  
 V B E G N A F Z E M Y T D O  
 E Q R A X N E T A E C S W D  
 N K P B T S V N M O V E S W  
 A I Y A E U D U S Z T D H A  
 N N C V Y E R U W S P X E T  
 T D I W D Q O E I V E P M E  
 U W A L K E D O F F O O D R  
 O T N S T M R L E I P Q K S  
 W A P H T E H P A J L J L O  
 T L G R O U N D I N E L I H  
 M I G E F I L L E L A M E E J  
 R V E A R T H Q A R K I E D  
 C E H V I O L E N C E B G A

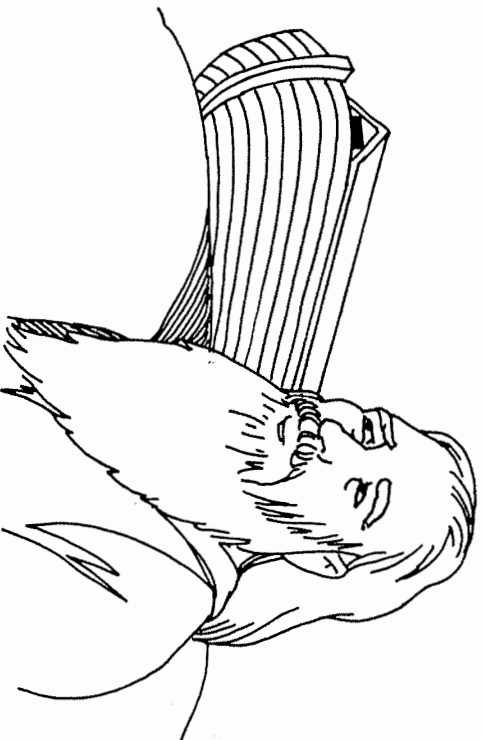

# Animals in the Ark

Noah obeyed God and built a big boat, called an ark, to protect his family and at least two of every animal from the great flood God sent.

Write the animals' names in the right places in the crisscross puzzle. Some of the animals' names have been put in to help you. Each word builds on an existing word. How many more animals can you think of?

DEER  
RABBIT  
HORSE  
SHEEP  
ANTEATER  
RAT  
CHIPMUNK  
BEAR  
OPOSSUM  
BUTTERFLY  
BOBCAT  
GIRAFFE  
LEOPARD

ANTELOPE  
KANGAROO  
APE  
GOAT  
CAT  
YAK  
IBEX  
CAMEL  
RACCOON  
COW  
MOOSE  
MONKEY

KOALA  
JAGUAR  
SQUIRREL  
CHICKEN  
SKUNK  
LYNX  
LION  
FROG  
FOX  
OX  
GORILLA  
OWL  
LLAMAS

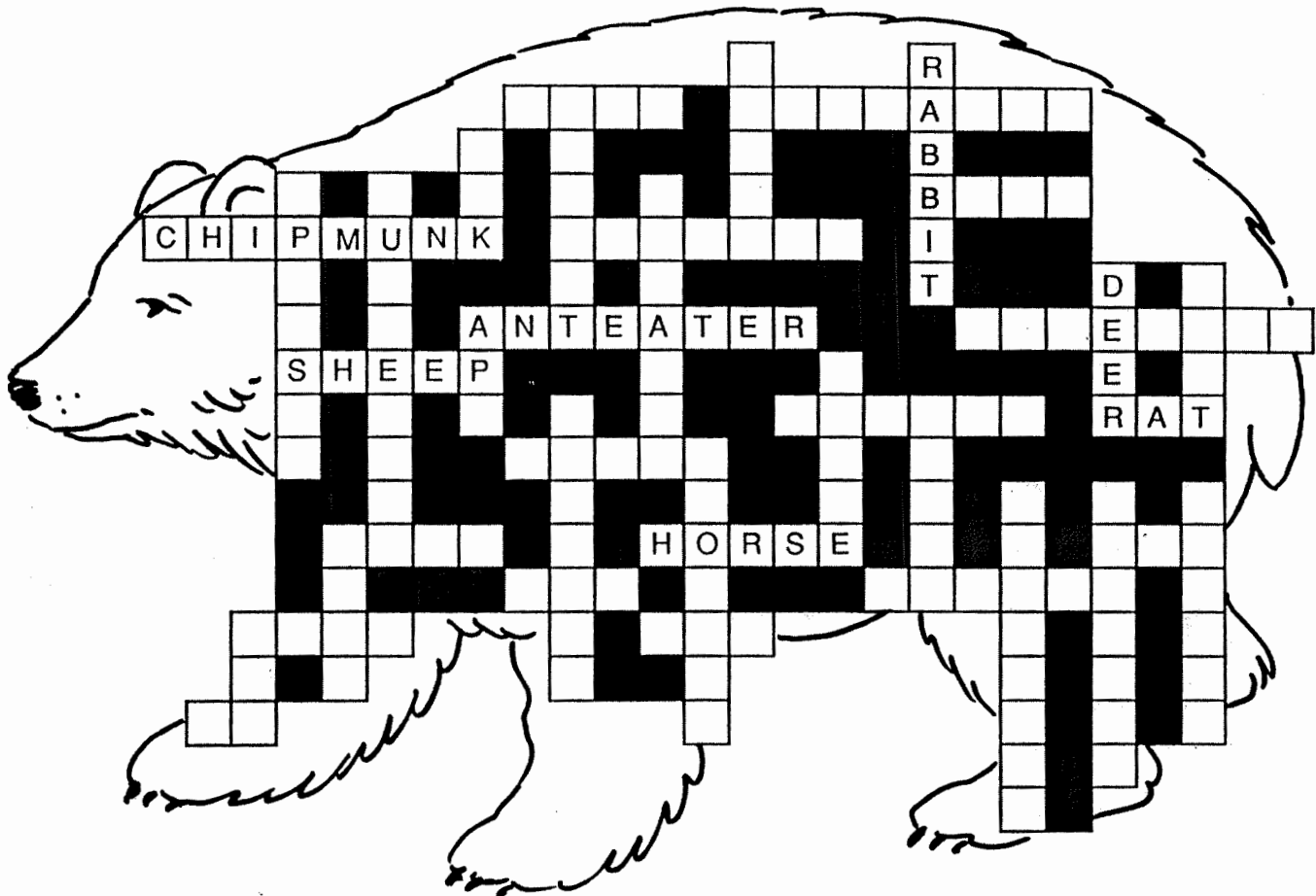



**Year 1**

**Week 6**

## **Rainbow of Promise**

**Scriptures: Genesis 8 & 9**

**Key Verse:**

**Genesis 9:13 "I set My rainbow in the cloud, and it shall be for the sign of the covenant between Me and the earth."**

**Key Points:**

- 1.** The waters totally covered the earth but God remembered Noah and sent a wind to dry the waters. The waters were on the earth many months before they began recede.
- 2.** Noah sent a raven and a dove to see if the earth was dry.
- 3.** After about a year, God commanded Noah, his family and animals to leave the ark. Noah immediately built an altar and worshiped God for His saving protection.
- 4.** God set up seasons that He promised would not cease. Animals would be given to man to eat.
- 5.** God made a covenant (promise) to never again destroy the earth by water. He put a rainbow in the sky as a symbol to remind man of His promises.

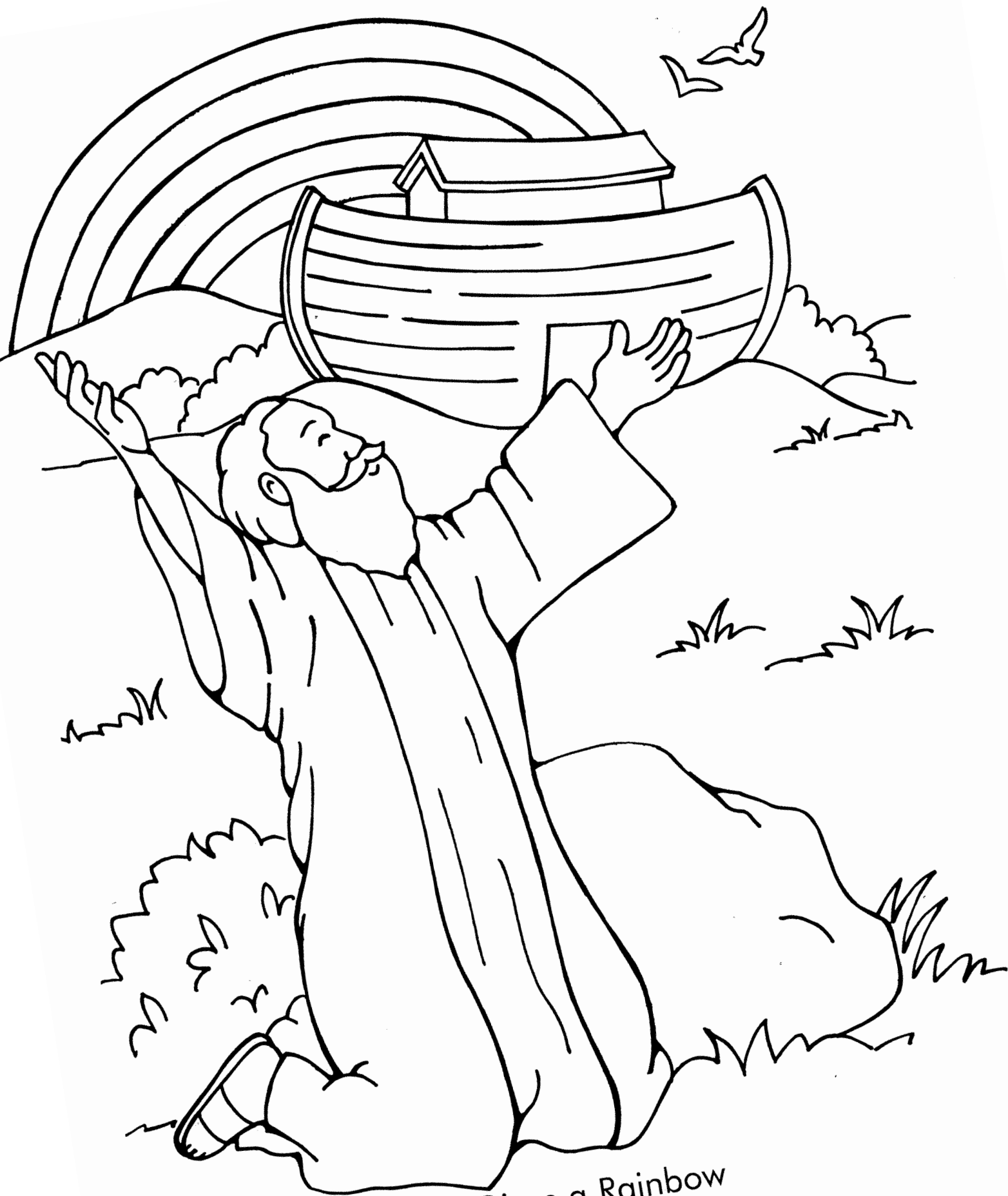

God Gives a Rainbow  
Genesis 8, 9

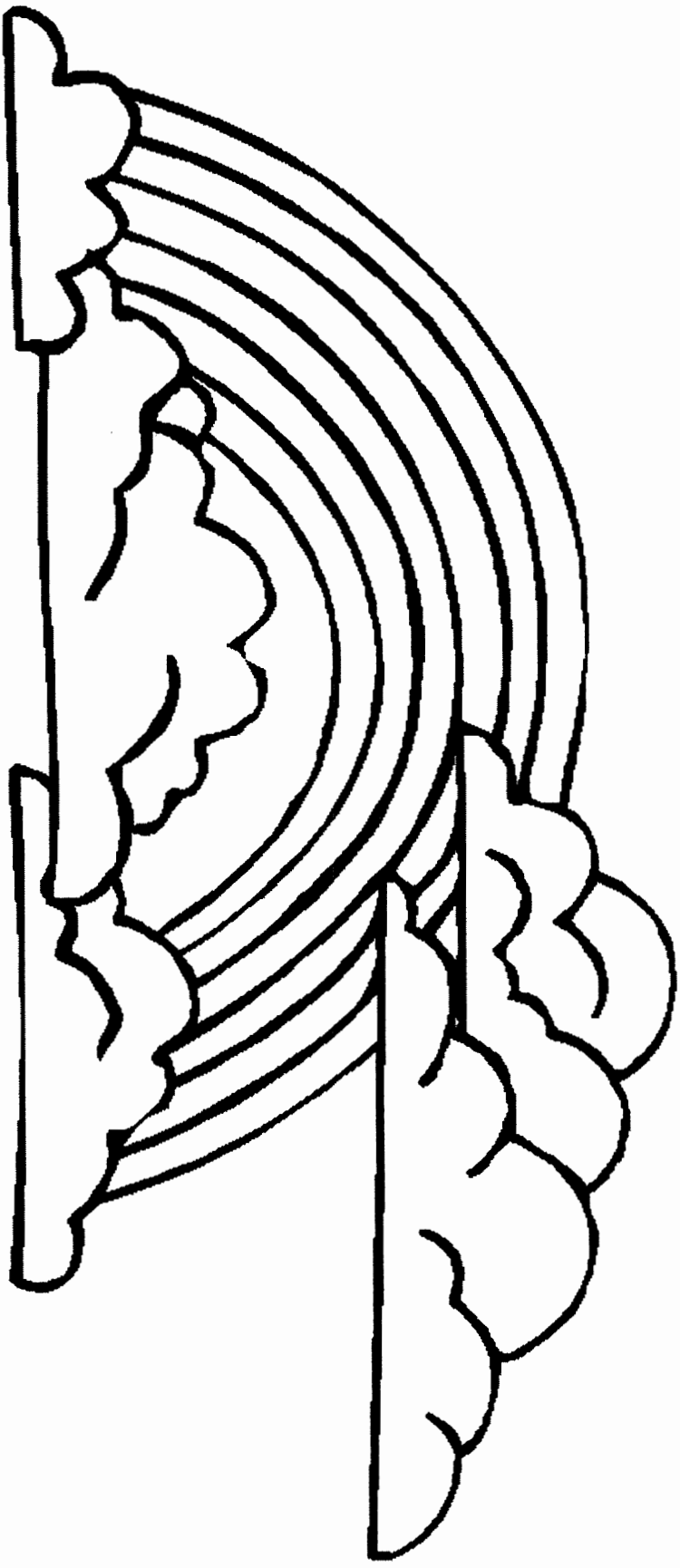

**I do set my bow in the clouds, and it shall be for a token of a covenant between me and the earth.**



Stories to Color & Tell

God Keeps His P

The Rainbow  
Promise  
Genesis 9:12-17

# A Sign From God

Cross out the letters C, J, K, Q, and Z every time you see them in the puzzle.

Copy the leftover letters in each row to create a sentence  
about God's special sign.

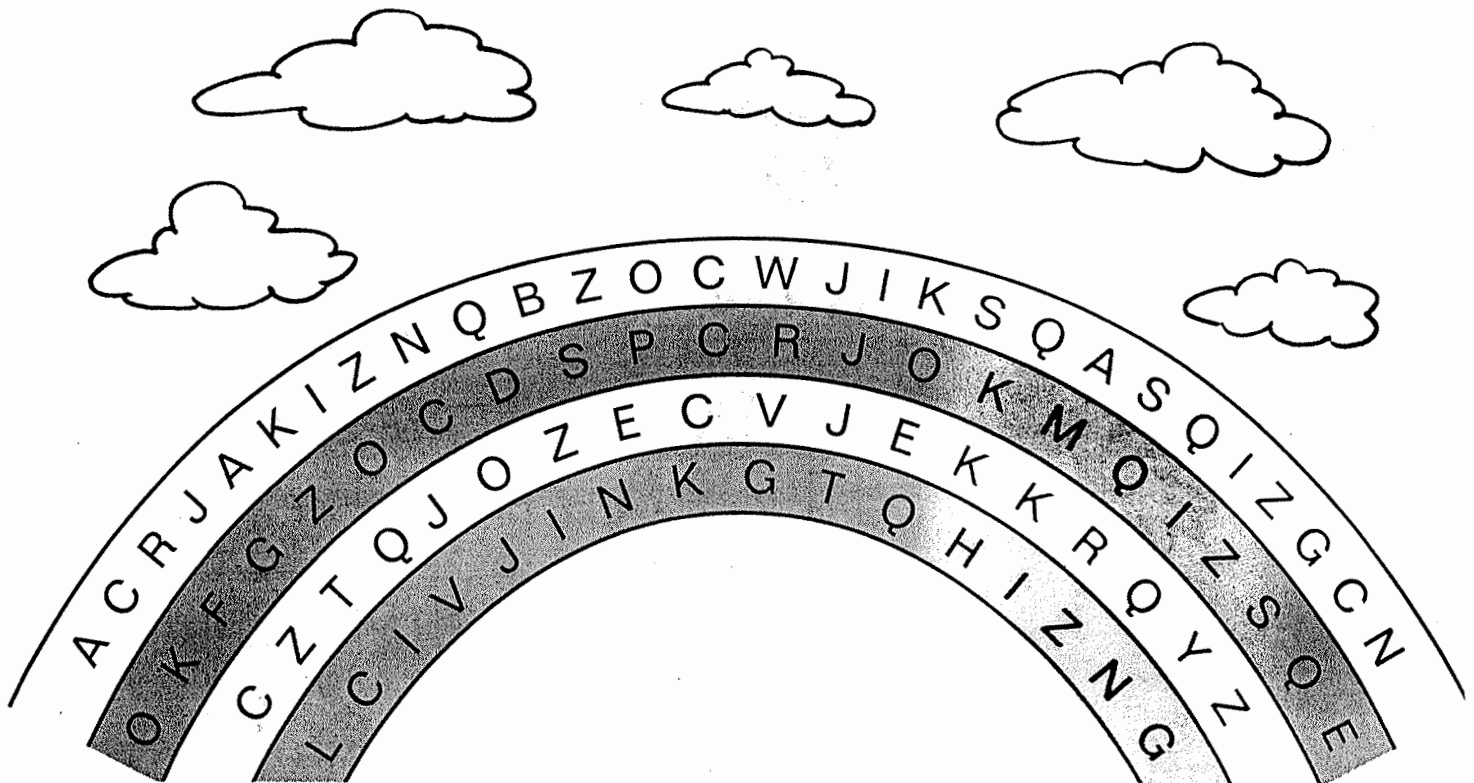

-----

-----

-----

-----

**Year 1**

**Week 7**

## **The Tower of Babel**

**Scriptures: Genesis 11**

**Key Verse:**

**Genesis 11:9 "Therefore its name is Babel, because there the Lord confused the language of all the earth; and from there the LORD scattered them abroad over the face of all the earth."**

**Key Points:**

- 1.** Hundreds of years after the flood the people wanted to build a tower and a city.
- 2.** They wanted to build it high into the heavens to gain recognition of others around them and so it could be seen if they were scattered around the earth.
- 3.** They were all of the same language, but the Lord came down and saw what they had done.
- 4.** He confused their language to keep them from becoming too prideful and to remind them that He is God.
- 5.** God deliberately scattered the people so that many languages and nations began.

**B**

is for Babel,  
The tower up high.  
It taught us to reach for GOD,  
Not for the sky!

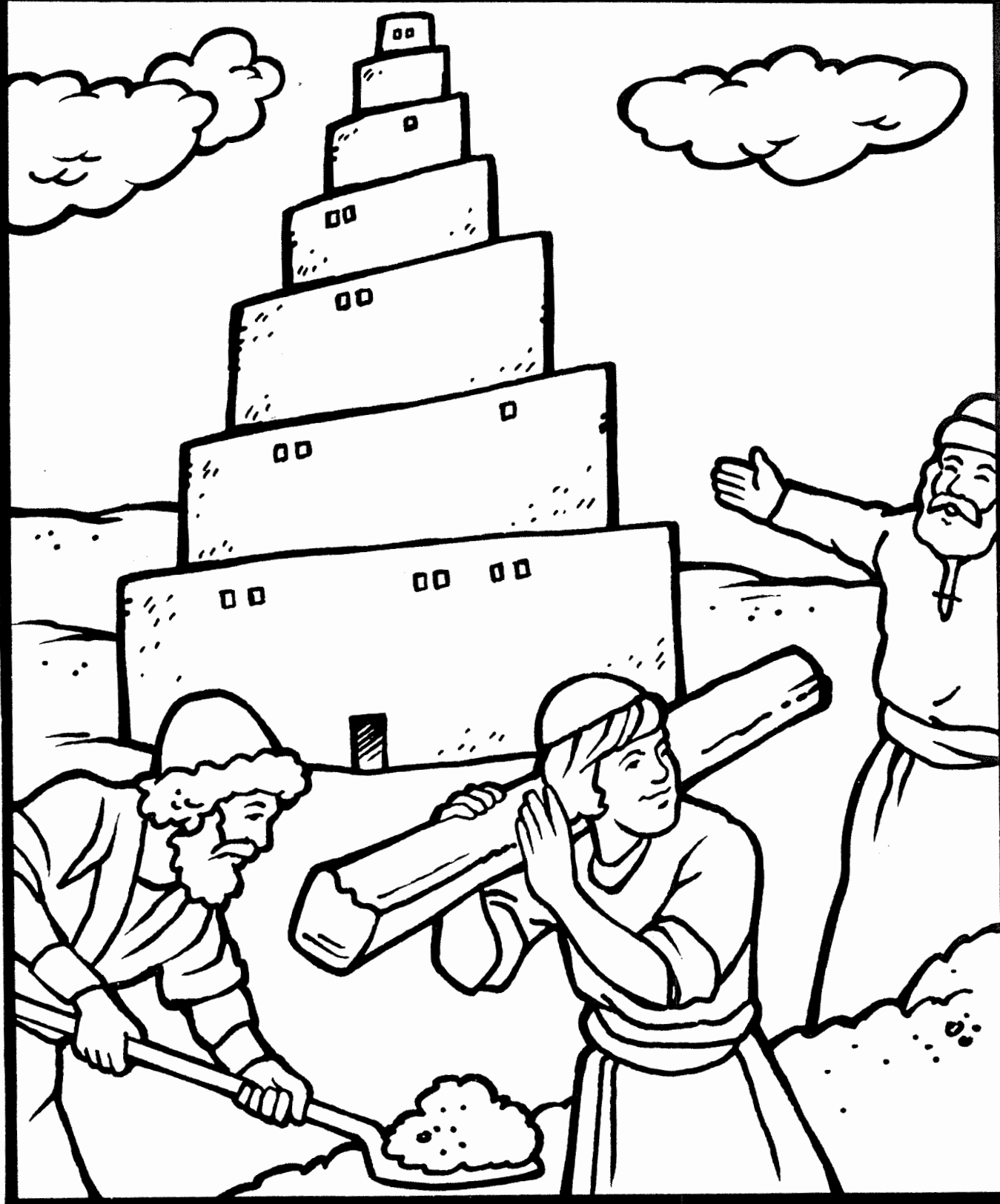

# THE TOWER OF BABEL

(GENESIS 10:8-10; 11:1-9)

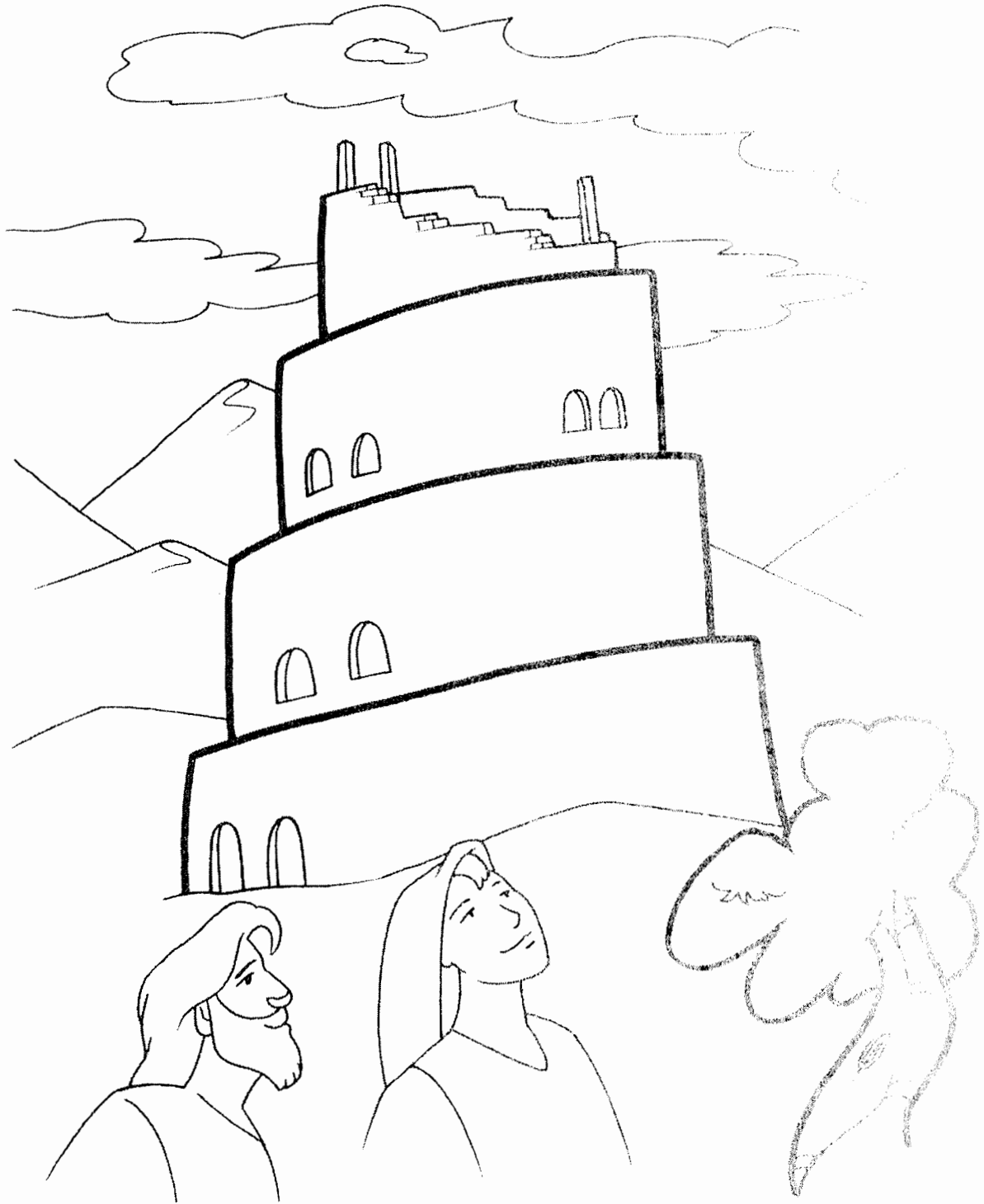

"And they said, Go to, let us build us a city and a tower, whose top *may reach* unto heaven; and let us make us a name, lest we be scattered abroad upon the face of the whole earth."

**GENESIS 11:4**



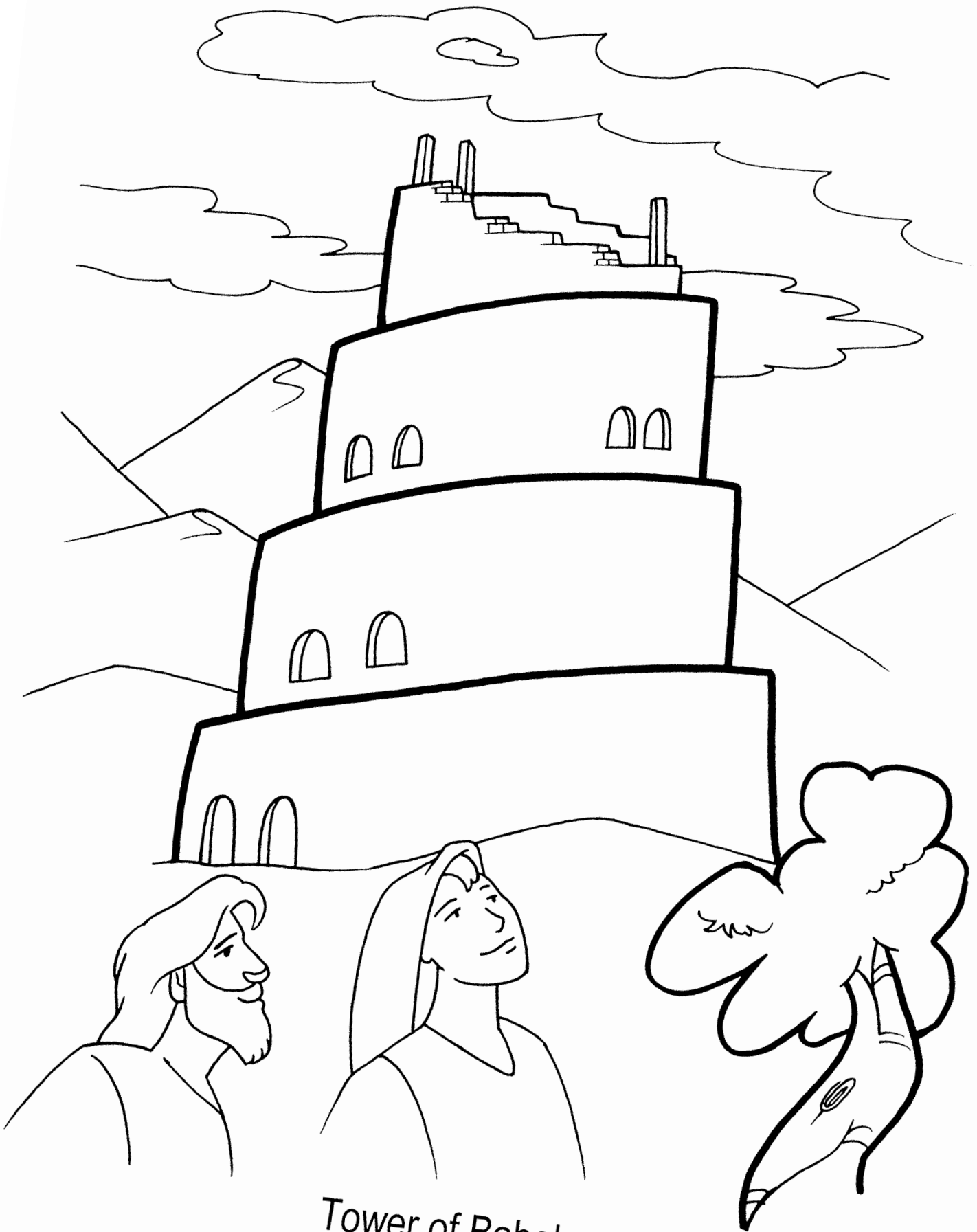

Tower of Babel

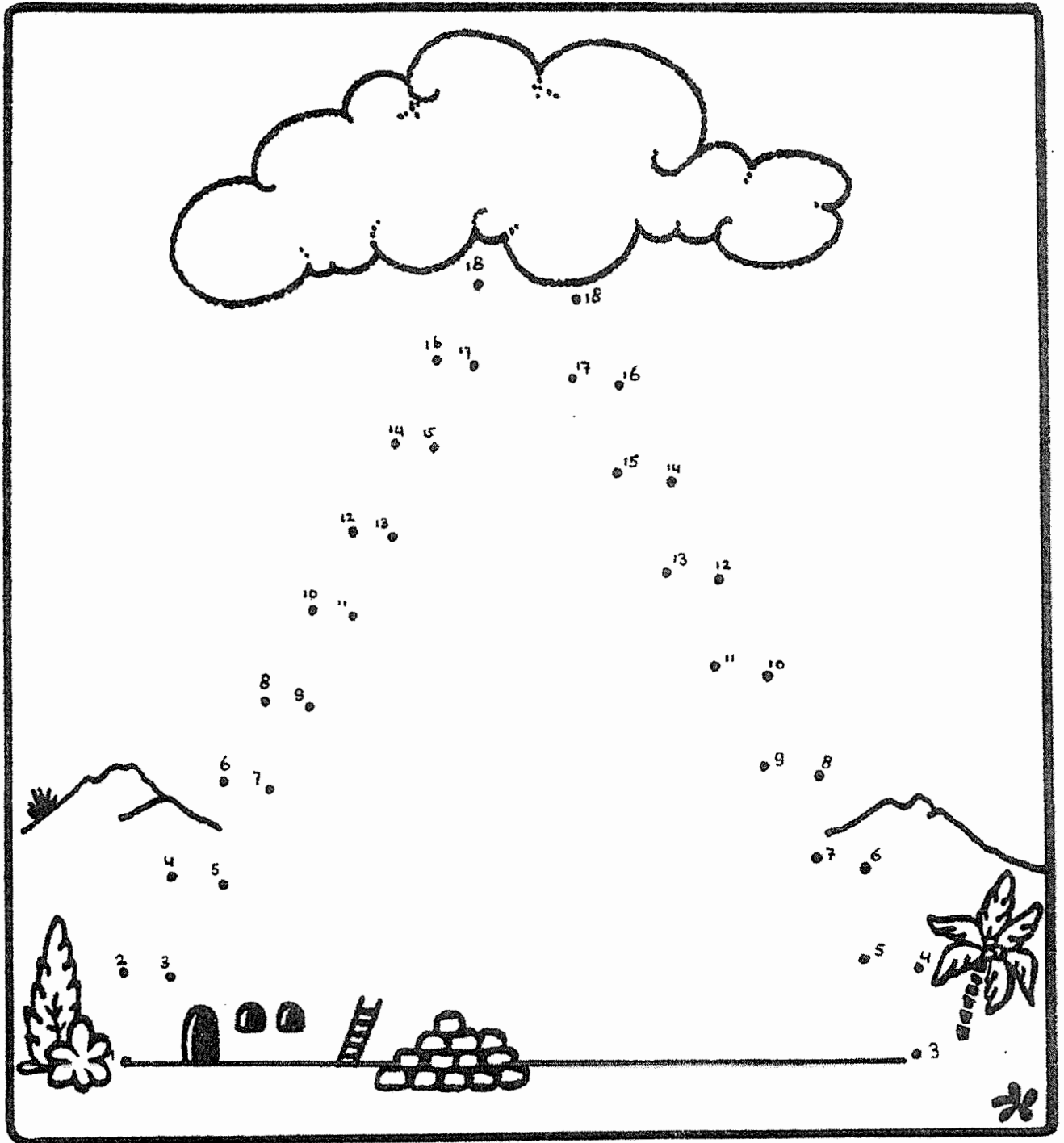



# TOOTHPICK TOWERS

"Then they said to each other, 'Let's build a city and a tower for ourselves, whose top will reach high into the sky. We will become famous. Then we will not be scattered over all the earth'" (Genesis 11:4).

## SUPPLIES

- miniature marshmallows
- round toothpicks
- cookie sheets

Tower building is fun for everyone. Do this craft as an individual or group project. Turn it into a game by seeing which group can build the highest tower in three minutes.

1. Form groups of four to six. Give each group a cookie sheet, a box of toothpicks, and a bag of miniature marshmallows.
2. Encourage each group to decide what kind of tower they'd like to build—a tall one, a skinny one, a fancy one, a round one, or a square one.
3. Give kids several minutes to work on their towers. Call time when all the marshmallows are used up!
4. Let kids display their towers and explain their special features.

## FAITH BOOSTER

Ask:

- What would you do if you wanted to show someone how great and talented and marvelous and awesome you are?

Read Genesis 11:1-9. Ask:

- Why did God stop the people from building their tower?
- When is it good to be proud of what we can do? When is it bad?

Explain that God gives each person talents and abilities and that God is glad when we use those abilities to bring honor to him. Close by having kids use toothpicks and marshmallows to make letters that spell out, "God is great!"

## PRO POINTER

Multicolored toothpicks and marshmallows make this project look even more impressive. For individual towers, use a paper plate rather than a cookie sheet to form the base.

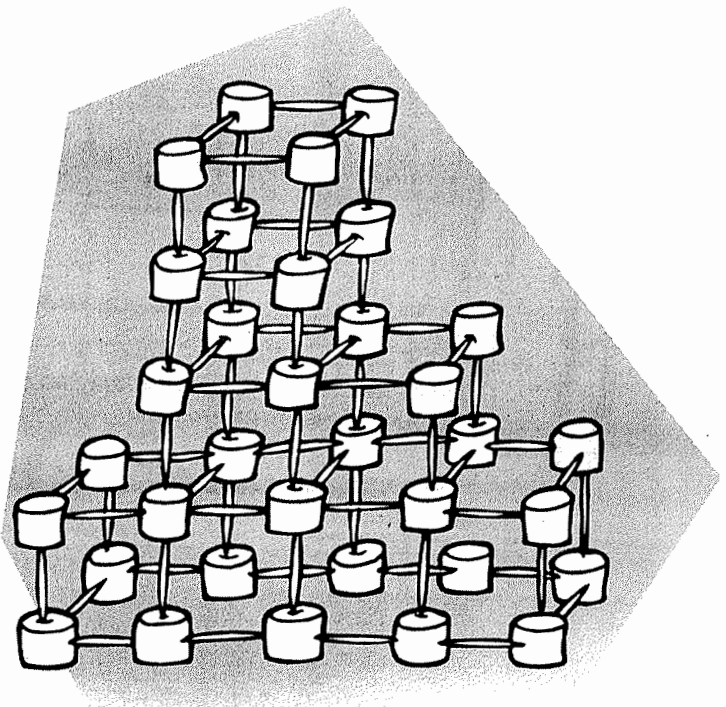

# Tower of Babel

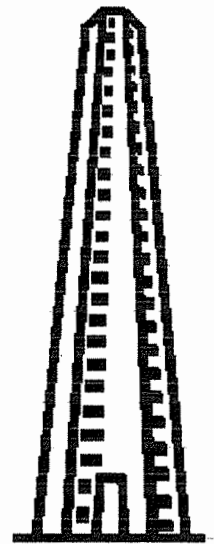
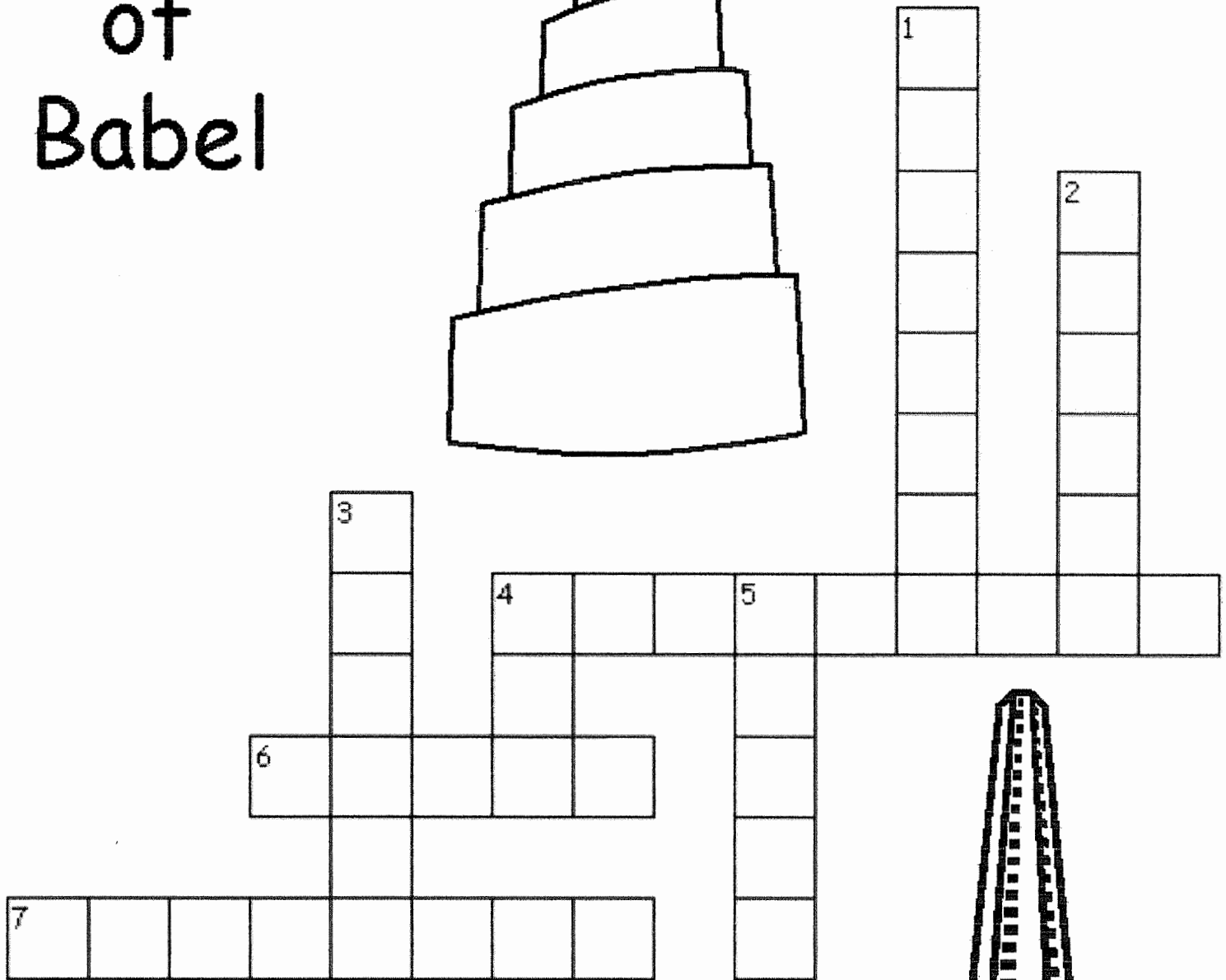
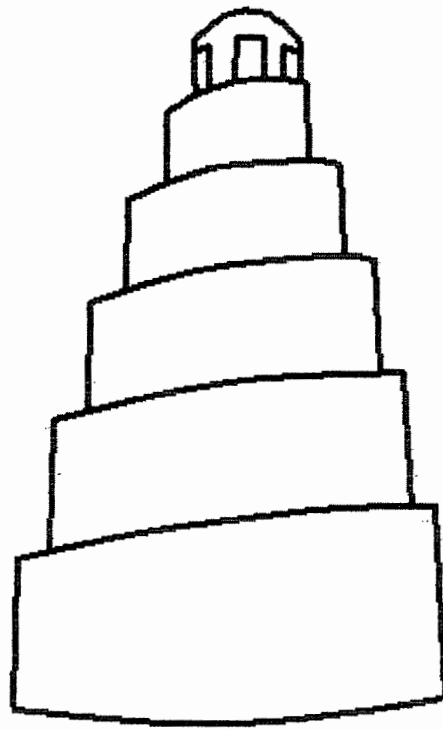

## Across

4. After, the people were \_\_\_\_\_ over the earth.
6. God hates this.
7. What did God do to their language to stop the people from building?

## Down

1. What all the people had in common.
2. By putting others before ourselves we are being \_\_\_\_\_.
3. This was the name of the king who wanted to make a name for himself.
4. How God felt when the people forgot about Him?
5. What did the people want to build to make themselves great.

# Tower of Babel

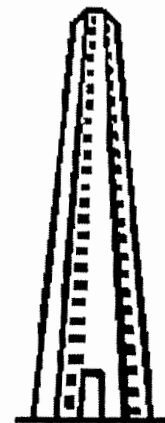
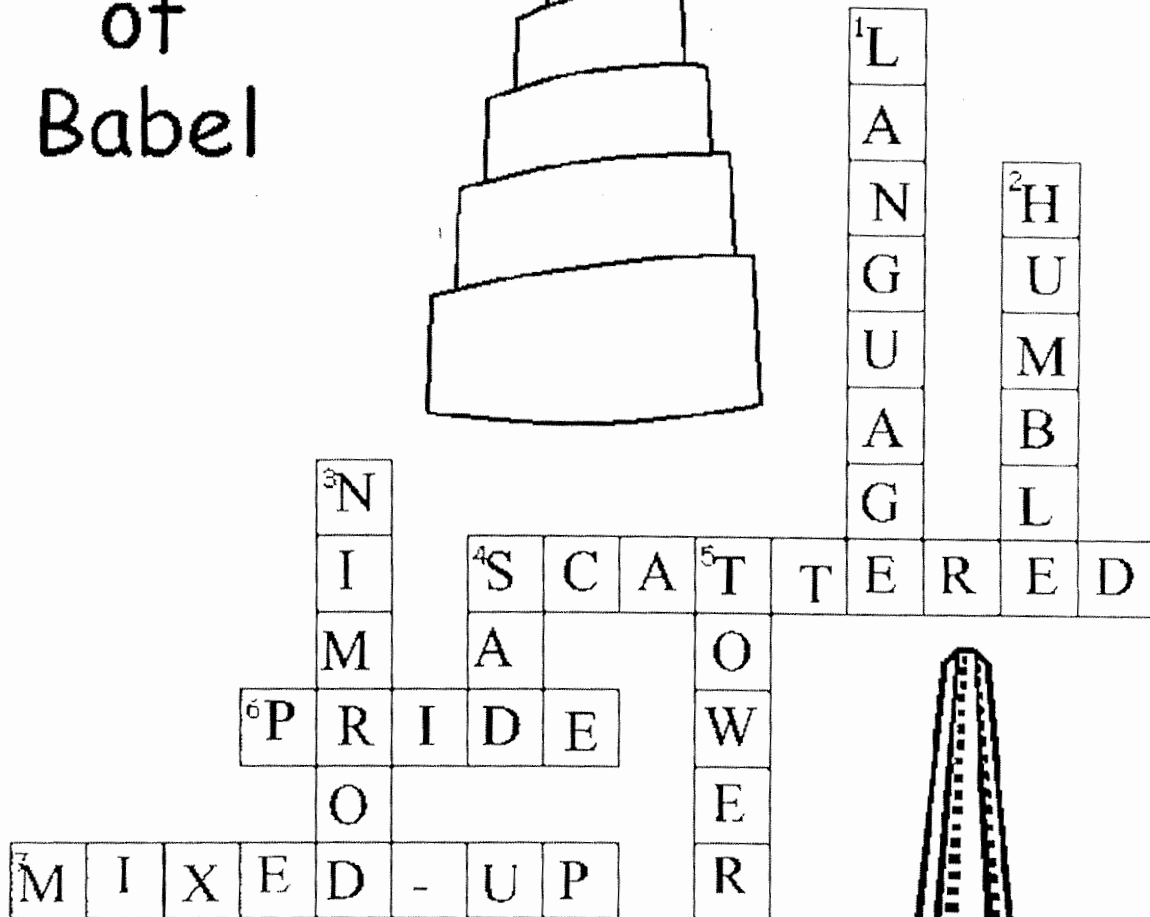

## Across

4. After, the people were \_\_\_\_\_ over the earth.
6. God hates this.
7. What did God do to their language to stop the people from building?

## Down

1. What all the people had in common.
2. By putting others before ourselves we are being \_\_\_\_\_.
3. This was the name of the king who wanted to make a name for himself.
4. How God felt when the people forgot about Him?
5. What did the people want to build to make themselves great.

# THE TOWER OF BABEL

(GENESIS 10:8-10; 11:1-9)

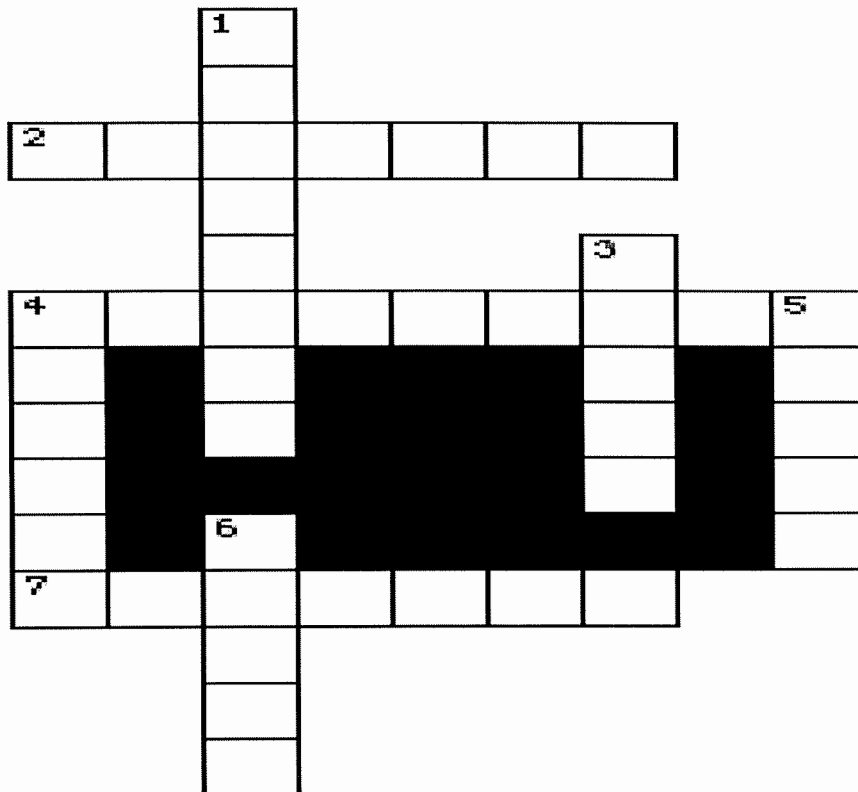

- 3 DOWN "And He will bring down their \_\_\_\_\_ together with the trickery of their hands." **ISAIAH 25:11**
- 4 DOWN "Now the whole earth had one language and one \_\_\_\_\_." **GENESIS 11:1**
- 5 DOWN "And it came to pass, as they journeyed from the east, that they found a plain in the land of Shinar, and they \_\_\_\_\_ there." **GENESIS 11:2**
- 7 ACROSS "And they said, 'Come, let us build ourselves a city, and a tower whose top is in the \_\_\_\_\_ let us make a name for ourselves, lest we be scattered abroad over the face of the whole earth.'" **GENESIS 11:4**
- 1 DOWN "And the LORD said, 'Indeed the people are one and they all have one \_\_\_\_\_, and this is what they begin to do; now nothing that they propose to do will be withheld from them.'" **GENESIS 11:6**
- 2 ACROSS The LORD said, "Come, let Us go down and there \_\_\_\_\_ their language, that they may not understand one another's speech." **GENESIS 11:7**
- 4 ACROSS "So the LORD \_\_\_\_\_ them abroad from there over the face of all the earth, and they ceased from building the city." **GENESIS 11:8**
- 6 DOWN "Therefore its name is called \_\_\_\_\_, because there the LORD confused the language of all the earth; and from there the LORD scattered them abroad over the face of all the earth." **GENESIS 11:9**

# THE TOWER OF BABEL

(GENESIS 10:8-10; 11:1-9)

## TRUE OR FALSE:

1. "Now the whole earth had one language and one speech." GENESIS 11:1

TRUE OR FALSE

2. And it came to pass, as they journeyed from the east, that they found a plain in the land of Shinsplints, and they dwelt there. GENESIS 11:2

TRUE OR FALSE

## FILL IN THE BLANKS:

3. "And they said, 'Come, let \_\_\_\_ build \_\_\_\_\_ a city, and a tower whose top is in the heavens; let \_\_\_\_ make a name for \_\_\_\_\_, lest \_\_\_\_ be scattered abroad over the face of the whole earth.'" GENESIS 11:4

## CIRCLE THE CORRECT WORDS:

4. "And the LORD said, 'Indeed the people are one and they all have one (LANGUAGE, HAIRDO), and this is what they begin to do; now (EVERYTHING, NOTHING) that they propose to do will be withheld from them.'" GENESIS 11:6

## TRUE OR FALSE:

5. The LORD said, "Come, let Us go down and there confuse their language, that they may not understand one another's speech." GENESIS 11:7

TRUE OR FALSE

6. "So the LORD scattered them abroad from there over the face of all the earth, and they ceased from building the city." GENESIS 11:8

TRUE OR FALSE

## CIRCLE THE CORRECT WORDS:

7. "Therefore its name is called (BABY, BABEL), because there the LORD confused the language of all the earth; and from there the LORD (SCARED, SCATTERED) them abroad over the face of all the earth." GENESIS 11:9

# THE TOWER OF BABEL

(GENESIS 10:8-10; 11:1-9)

## TRUE OR FALSE:

1. "Now the whole earth had one language and one speech." GENESIS 11:1  
TRUE OR FALSE

2. And it came to pass, as they journeyed from the east, that they found a plain in the land of Shinsplints, and they dwelt there. GENESIS 11:2  
TRUE OR FALSE

## FILL IN THE BLANKS:

3. "And they said, 'Come, let \_\_\_\_ build \_\_\_\_\_ a city, and a tower whose top is in the heavens; let \_\_\_\_ make a name for \_\_\_\_\_, lest \_\_\_\_ be scattered abroad over the face of the whole earth.'" GENESIS 11:4

4. "And the LORD said, 'Indeed the people are one and they all have one \_\_\_\_\_, and this is what they begin to do; now \_\_\_\_\_ that they propose to do will be withheld from them.' " GENESIS 11:6

## TRUE OR FALSE:

5. The LORD said, "Come, let Us go down and there confuse their language, that they may not understand one another's speech." GENESIS 11:7  
TRUE OR FALSE

## FILL IN THE BLANKS:

6. "So the LORD scattered them abroad from there over the face of all the earth, and they \_\_\_\_\_ from building the city." GENESIS 11:8

7. "Therefore its name is called \_\_\_\_\_, because there the LORD confused the language of all the earth; and from there the LORD \_\_\_\_\_ them abroad over the face of \_\_\_\_\_ the earth." GENESIS 11:9



THE TOWER OF BABEL  
(GENESIS 10:8-10; 11:1-9)

A L A N G U A G E S H I N A R  
D L O R D S Q I B E N O Y O O  
N O Y Y M J S A J V E N S E M  
A Y T I C C B B W B N W F K S  
T O G J U E A U C Z O Z M A H  
S C V S L K N E S Y T S Y E U  
R O H G E T I P C T S J Z G N  
E N W R S N E V A E H N D W T  
D F S D F F E N T F A I T P E  
N U X S C H S Z T M A M T V R  
U S A K H S P E E C H R E J R  
R E S C Y U R F R I J O U E P  
Y I E I U T P H E B Z D W C H  
K K W R I T X F D Z G O L F D  
I H Y B F A I M D W T M F H A

BABEL HUNTER SCATTERED BAKE  
LANGUAGE SHINAR BRICKS LORD  
SPEECH CITY NAME STONE  
CONFUSE NIMROD TOWER CUSH  
ONE UNDERSTAND HEAVENS

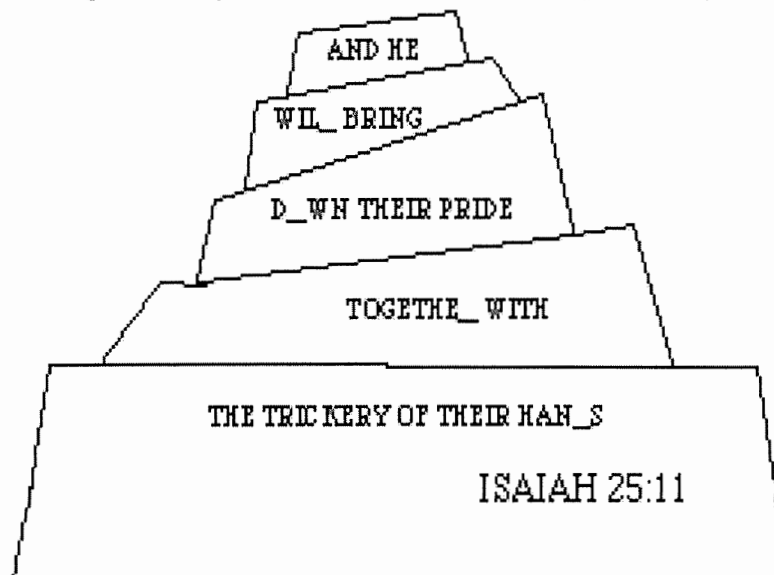

# THE TOWER OF BABEL

(GENESIS 10:8-10; 11:1-9)

V Z M X F B P I S P K L U O W L I D U Q I H R J N  
O R I Y Z L Z F C R P K V W Y O V S W A F N A I M  
B D O L A O V B N Y Z I F J U B E U K E J Y M K H  
Y Y X N N U U L P R S Q I V K A M J Y G Q R U Z L  
D Q K D S S D A C E T S U H Y K N L Y A O W V W A  
G Q E C P P W E S N E V A E H E L J E D S C W W Z  
C H Y E H W E Z X C I T Y Y H A B T H T H N A V Y  
X F E V U C E D C X V S H G N P L B L N I R T H E  
E C T O R P B C E V G O I G F O A V B B N G Z W K  
H O O N E R D L H R W E U M R D S Q R K A I V S G  
K I E S T F V W S T E A P D Q Q P O O L R K K R Z  
Y H Z K N M N C U O G T K X X J W V W D E F B V S  
B H Q L U E P A C E D Z T U H J J Y H O P T M B B  
Z Q V D H T Y Z X J K P R A M C H X J H G S S K E  
U U L F B A B E L Q A E E V C X N C S Y G T H G W  
F F S A S L G S P L G D N E G S F J R Q L O J P G  
T O W E R M E D R P S N A Z Q V G C O N F U S E B  
J U R B Y M N G E V A A I U W D I N V K Y Y L E T  
U M S R A E W P E N O T S U G I E B J G T T X I D  
S N B N J Z Y C M G U S P I X M G L D O P T B N P  
X K B X N I Z V H Y K R Q X W O W L U J V G K A T  
K V C E D I U U Y Q S E F Q D O K D V M E F N V C  
B S Z I Y D G I Y D Y D R B I F O N C N N I P I P  
D L F W R Z F P M O X N C V C U I K G R J Y F W N  
C B W G I B Y N B O F U G B P D L A O M A M H A B

BABEL HUNTER SCATTERED BAKE LANGUAGE

SHINAR BRICKS LORD SPEECH CITY

NAME STONE CONFUSE NIMROD TOWER

CUSH ONE UNDERSTAND HEAVENS

**Year 1**

**Week 8**

## **The Call of Abram**

**Scriptures: Genesis 12**

**Key Verse:**

**Genesis 12:2 "I will make you a great nation; I will bless you and make your name great; and you will be a blessing."**

**Key Points:**

- 1.** When God commanded Abram to leave his country and his family and go to Canaan, Abram listened and obeyed.
- 2.** God made Abram three promises:
  - 1)** He would father a nation
  - 2)** His name would be great
  - 3)** God would bless those who blessed Abram
- 3.** God promised the land of Canaan to Abram's descendants.
- 3.** During a famine, Abram and Sarai traveled to Egypt, where Sarai posed as Abram's sister.
- 4.** Because of Abram's lie, God plagued Pharaoh and his household until Pharaoh discovered the lie and sent Abram and Sarai away.

# GOD CALLS ABRAM

(GENESIS 11:26-12:9)

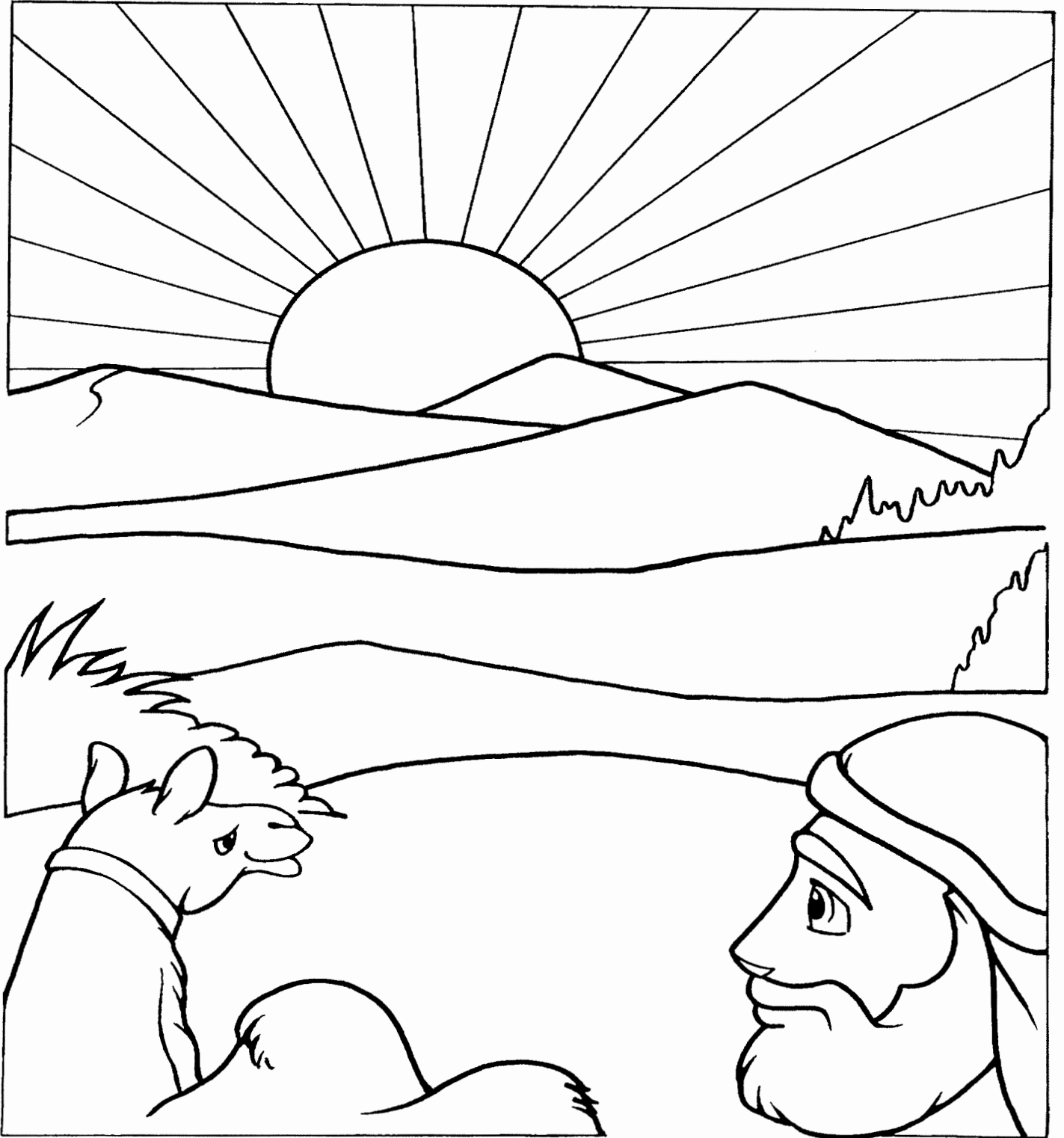



**Genesis 15:5**

"Then He brought him outside and said, 'Look now toward heaven, and count the stars if you are able to number them.' And He said to him, 'So shall your descendants be.'"

## GOD MAKES A GREAT NATION



At God's command, Abraham left his home in Ur of Chaldea and set out with his family to found a new nation.

*Coloring & Activity Pages by: Bible-Printables.com*



Abraham went, as the Lord told him.

Genesis 12:4

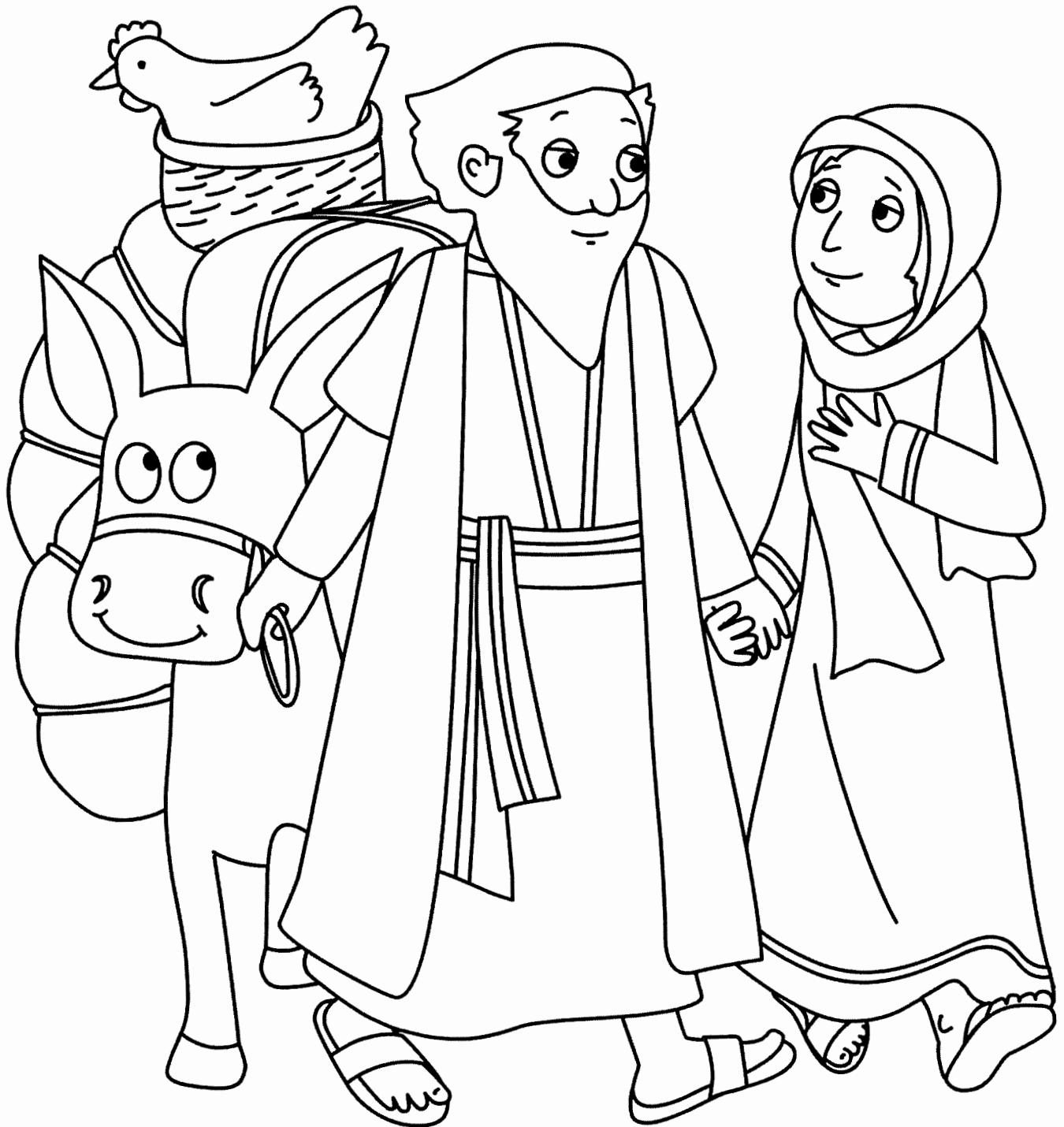







Abraham's New Home  
*Genesis 12, 13*

HELP  
Apply Now  
Find His  
HOME

START  
↓

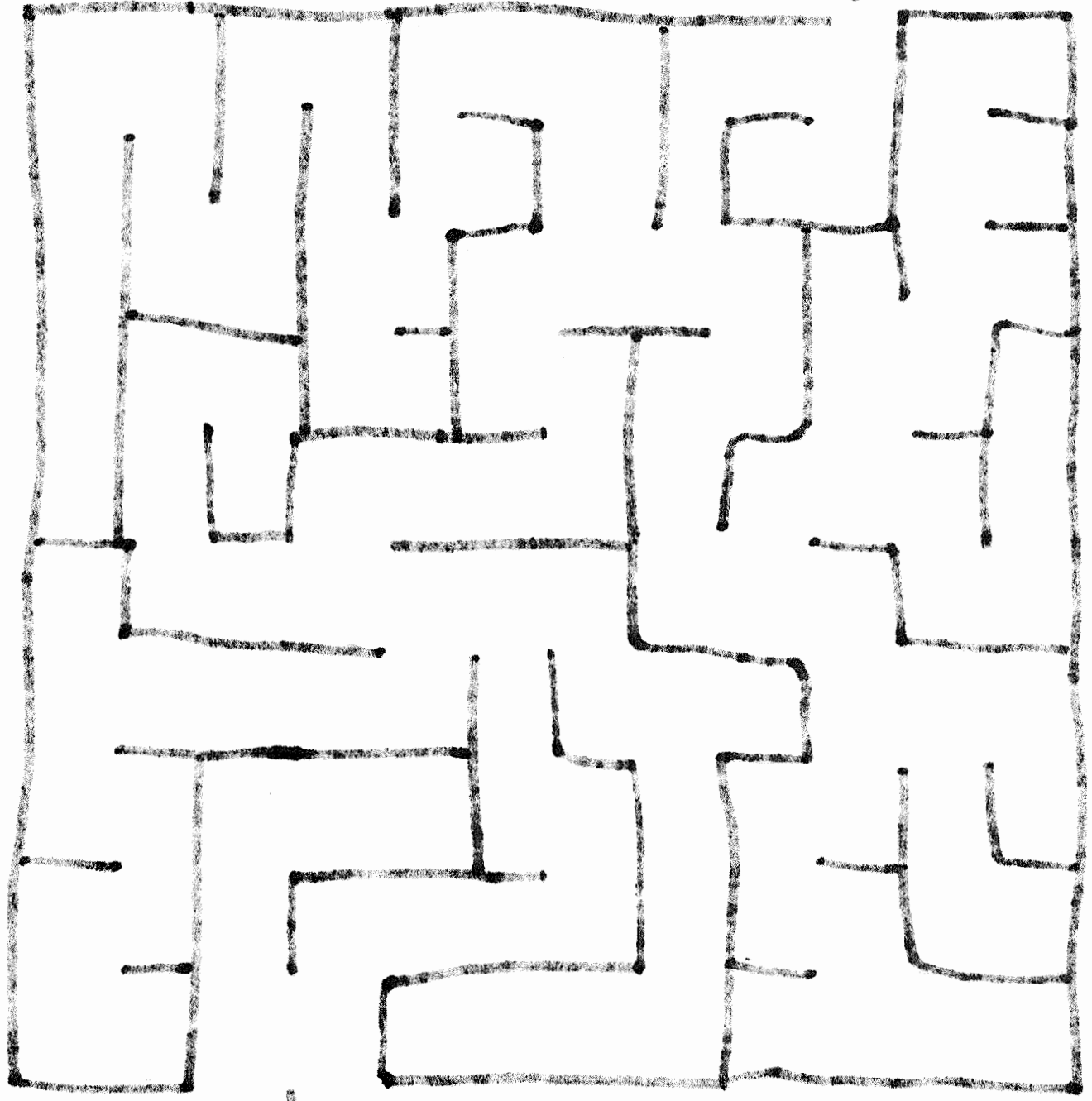

FINISH  
↓



# Look Around, Abram

Unscramble the letters on the points of the compass to make the four words missing from Genesis 13:14, 15.

The Lord said to Abram, "Look all around you.

Look <sup>1</sup> \_\_\_\_\_ and <sup>2</sup> \_\_\_\_\_  
and <sup>3</sup> \_\_\_\_\_ and <sup>4</sup> \_\_\_\_\_.

All this land that you see  
I will give to you and  
your descendants  
forever."

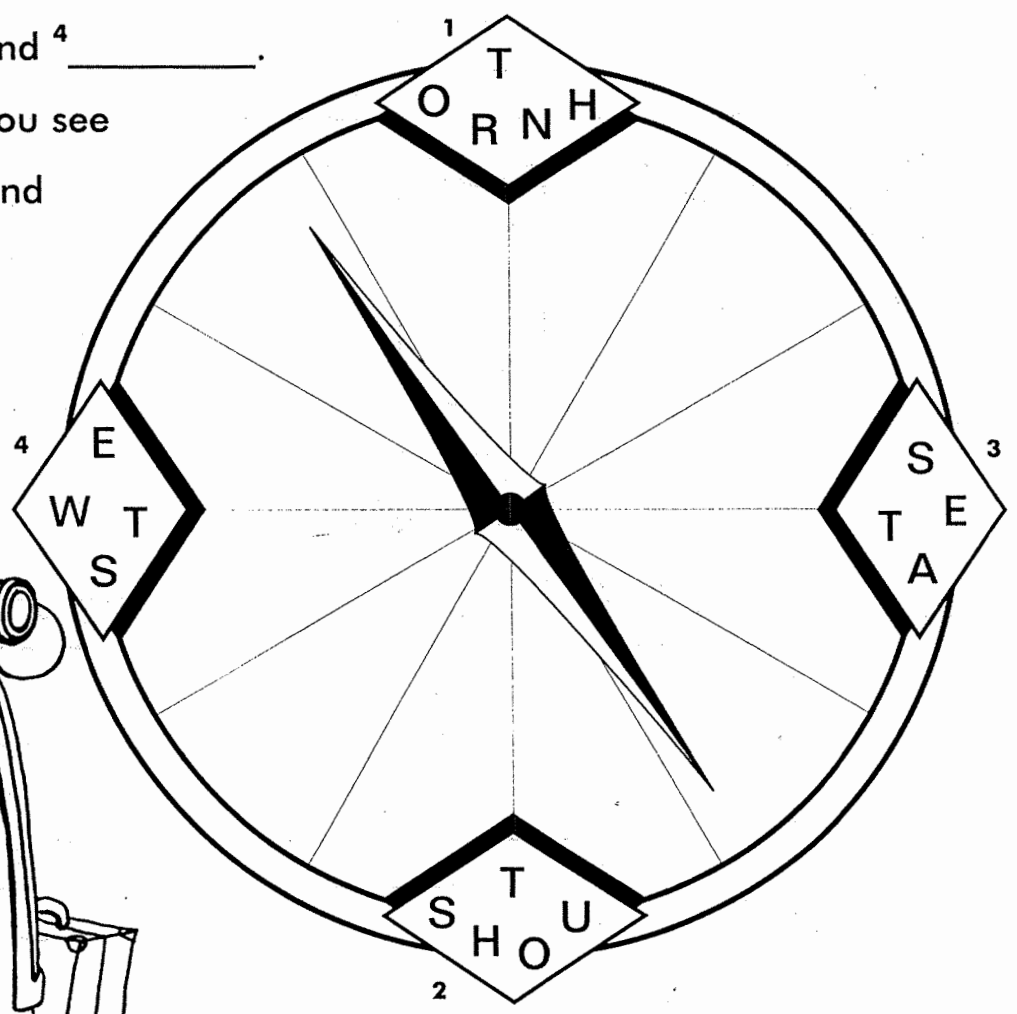
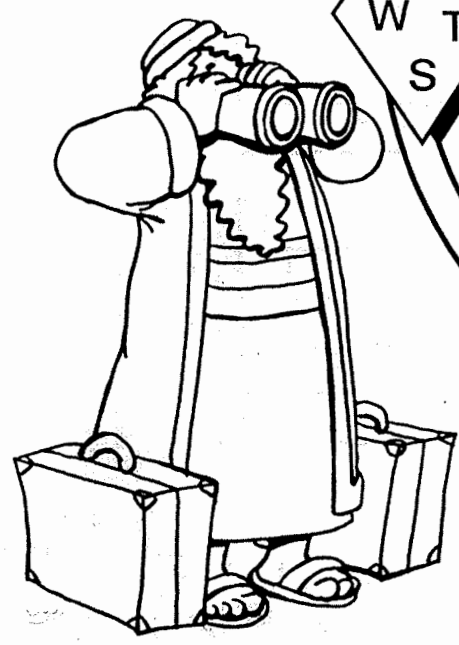

# GOD CALLS ABRAM

## (GENESIS 11:26-12:9)

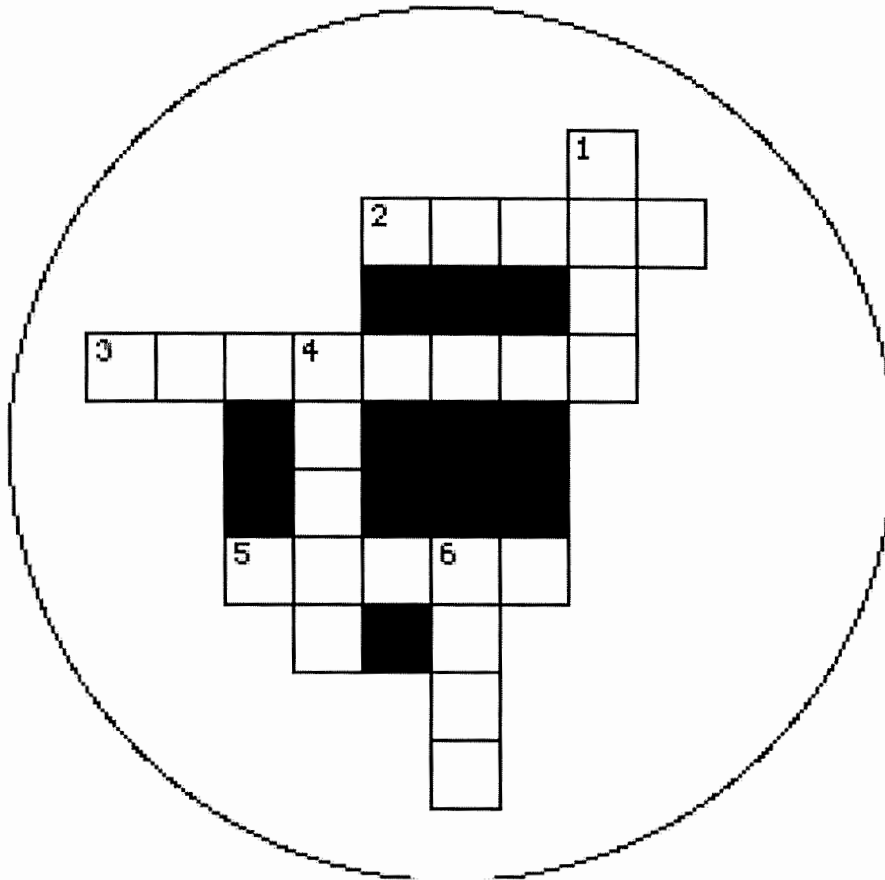

- 5 ACROSS "By \_\_\_\_\_ Abraham obeyed when he was called to go out to the place which he would afterward receive as an inheritance." **HEBREWS 11:8**
- 4 DOWN "Now the LORD had said to \_\_\_\_\_ 'Get out of your country, from your kindred and from your father's house, to a land that I will show you.'" **GENESIS 12:1**
- 3 ACROSS "Then Abram took Sarai his wife and Lot his brother's son, and all their possessions that they had gathered, and the people whom they had acquired in Haran, and they \_\_\_\_\_ to go to the land of Canaan." **GENESIS 12:5**
- 6 DOWN "Abram passed through the land to the place of Shechem, as far as the terebinth \_\_\_\_\_ of Moreh. And the Canaanites were then in the land." **GENESIS 12:6**
- 1 DOWN "Then the LORD appeared to Abram and said, 'To your descendants I will give this \_\_\_\_\_'" **GENESIS 12:7**
- 2 ACROSS "And there he built an \_\_\_\_\_ to the LORD, who had appeared to him. And he moved from there to the mountain east of Bethel, and he pitched his tent with Bethel on the west and Ai on the east; there he built an altar to the LORD and called on the name of the LORD." **GENESIS 12:7-8**

# GOD CALLS ABRAM

## (GENESIS 11:26-12:9)

### **MEMORY VERSE:**

*"By faith Abraham obeyed when he was called to go out to the place which he would afterward receive as an inheritance. And he went out, not knowing where he was going."* HEBREWS 11:8

### **FILL IN THE BLANKS:**

1. "Now the LORD had said to Abram..." **GENESIS 12:1-3**

'Get out of your country,

from your kindred and from your father's house,

to a land that \_\_\_\_\_ will show you.

\_\_\_\_\_ will make you a great nation;

\_\_\_\_\_ will bless you and make your name great;

and you shall be a blessing.

\_\_\_\_\_ will bless those who bless you,

and \_\_\_\_\_ will curse him who curses you;

and in you all the families of the earth shall be blessed.'

2. "Then Abram took \_\_\_\_\_ his wife and \_\_\_\_\_ his brother's son, and all their possessions that they had gathered, and the people whom they had acquired in \_\_\_\_\_, and they departed to go to the land of \_\_\_\_\_." **GENESIS 12:5**

### **TRUE OR FALSE:**

3. "Abram passed through the land to the place of Shechem, as far as the terebinth tree of Moreh. And the Canaanites were then in the land." **GENESIS 12:6**

**TRUE OR FALSE**

4. "Then the LORD appeared to Abram and said, 'To your descendants I will give this land.'" **GENESIS 12:7**

**TRUE OR FALSE**

### **FILL IN THE BLANKS:**

5. "And there he built an \_\_\_\_\_ to the LORD, who had appeared to him. And he moved from there to the mountain east of Bethel, and he pitched his tent with Bethel on the west and Ai on the east; there he built an \_\_\_\_\_ to the LORD and called on the name of the LORD."

**GENESIS 12:7-8**

# GOD CALLS ABRAM

## (GENESIS 11:26-12:9)

### CIRCLE THE CORRECT WORDS:

1. "Now the LORD had said to Abram..." **GENESIS 12:1-3**

'Get out of your country, from your kindred and from your father's house, to a land that (I, YOU) will show you.

(I, YOU) will make you a great nation;

(I, YOU) will bless you and make your name great; and you shall be a blessing.

(I, YOU) will bless those who bless you and (I, YOU) will curse him who curses you; and in you all the families of the earth shall be blessed.'

2. "Then Abram took (**SANDRA, SARAI**) his wife and (**LOT, LOOT**) his brother's son, and all their possessions that they had gathered, and the people whom they had acquired in (**HAIRLAND, HARAN**), and they departed to go to the land of (**CANDY, CANAAN**)." **GENESIS 12:5**

### TRUE OR FALSE:

3. "Abram passed through the land to the place of Shechem, as far as the terebinth tree of Moreh. And the Canaanites were then in the land." **GENESIS 12:6**

TRUE OR FALSE

4. "Then the LORD appeared to Abram and said, 'To your descendants I will give this land.'" **GENESIS 12:7**

TRUE OR FALSE

### FILL IN THE BLANKS:

5. "And there he built an \_\_\_\_\_ to the LORD, who had appeared to him. And he moved from there to the mountain east of Bethel, and he pitched his tent with Bethel on the west and Ai on the east; there he built an \_\_\_\_\_ to the LORD and called on the name of the LORD." **GENESIS 12:7-8**

# GOD CALLS ABRAM

(GENESIS 11:26-12:9)

A M A R B A Z P F Z E E W Y N  
M V H D W B Z I A B A R U P G  
X Q A E Z K K Q Y N E U B Y Z  
T T E R A H C D Y S O T M B J  
C Z G N I S S E L B W I H D P  
Y A W P K E T O O H L W T E N  
A U N Z K F T J F M Z D W A L  
L A X A Q J I Q V M M W U R N  
T S T N A D N E C S E D F C U  
A N P C J N O R M S D R O L O  
R M E C B T T I S V P Y I G F  
L G S Q B E A L V N E R R A B  
C H A L D E A N S O J W O H S  
I F G I R J N S M J H P X R L  
O I A R A S R T A J G Z G G L

ABRAM CANAAN NATION ALTAR  
CHALDEANS SARAI BARREN DESCENDANTS  
SHOW BETHEL LORD TERAH  
BLESSING LOT UR

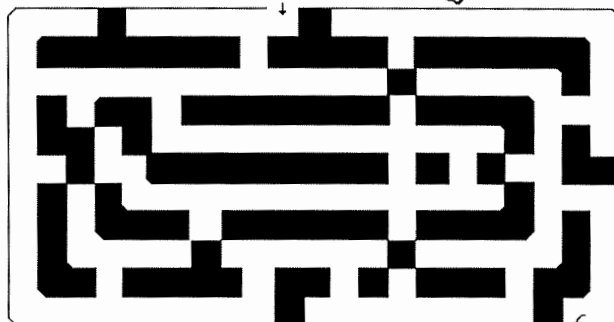
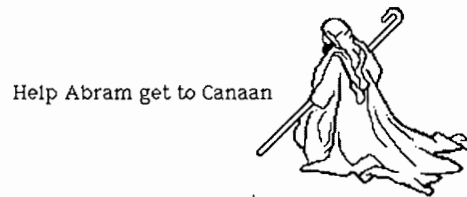

Welcome to the land of Canaan



# GOD CALLS ABRAM

(GENESIS 11:26-12:9)

R G H W O S Z U A E U N L R U M I B S M H X V R P  
F E S E Z L N T Y P T C W F A G H R U J X D F U M  
H Y S L M P K T N I O V W Y D O J W X Q A K H K L  
E G R D F D O D S A M B E T H E L G H L U X N B C  
L M R V M U E H Q Y A C Z X D V D T U J V U E I S  
M O V D Q T O S U B J N O D W S U K Q T A Y E F G  
L Q N D S W B D C I A R A S T P O W N E R R A B E  
G H G Z Q N H Q Q E K C A C L T L I T W E E M W Y  
M V D Z V D F C T B N H K F A W B U P K I E J L U  
B V P O P R V U H P G D U B O B L M L N S J Q J W  
P G K W B A I J T P R R A E A H E F J O G A V B I  
M S S H Q Z O K T Y H A N N P J S O B I J V E B A  
W N P Q J E N S R F G E T H T Y S E J T P K L O T  
N B T I I M H M R O D M U L A S I P H A Z U V K C  
G K P E C D I C W J V Q D T A K N K T N F O V J L  
K K R L R W U J H W B N L L D P G J J M B Z L K P  
B O X H T A A T P A G Y U U Y G O F Y L X X A U A  
Y J O T C Q H A N S L M F W S K M Y R U K A I M I  
K Q S Y J X F A K S C D L Q M G A T D G M M L X E  
P S L O W I F U B I Z A E N U P R W C C Z Z R Y Y  
U P K A Y T T E C A H S Y A X S B U G V X B U R A  
Y M W V J A Q N D G K V H I N O A G S U I T U T Q  
F B V C T L H Q W W K Y X S S S U H Q B Z P C T A  
K B J A N B A X K A R K O V E T I X U U F Z Q C O  
T O X L A Z U N I F E W I U J W I V R N Z F N M Y

**ABRAM CANAAN NATION ALTAR**  
**CHALDEANS SARAI BARREN DESCENDANTS**  
**SHOW BETHEL LORD TERAH**  
**BLESSING LOT UR**

# Abraham

Genesis 12:1-7

The Lord had said to Abram, "Leave your

\_\_\_\_\_, your people and your father's \_\_\_\_\_, and go to the land I will show you.

"I will make you into a great \_\_\_\_\_ and I will bless you; I will make your \_\_\_\_\_ great, and you will be a

\_\_\_\_\_. I will bless those who \_\_\_\_\_ you, and whoever curses you I will \_\_\_\_\_; and all peoples on earth will be \_\_\_\_\_ through you."

So \_\_\_\_\_ left, as the Lord had told him; and \_\_\_\_\_ went with him. Abram was seventy-five \_\_\_\_\_ old when he set out from \_\_\_\_\_. He took his wife \_\_\_\_\_, his \_\_\_\_\_ Lot, all the possessions they had \_\_\_\_\_, and the people they had \_\_\_\_\_

\_\_\_\_\_ in Haran, and they set out for the land of \_\_\_\_\_, and they arrived there.

Abram \_\_\_\_\_ through the land as far as the \_\_\_\_\_ of the great tree of \_\_\_\_\_ at Shechem. The \_\_\_\_\_ were then in the land, but the Lord \_\_\_\_\_ to Abram and said, "To your \_\_\_\_\_ I will give this land." So he built an \_\_\_\_\_ there to the Lord, who had appeared to him.

Q O B N H A R A N S S E L B  
 Z N M Z O L Y K A O W J E X  
 A I A C U R S E A F V T H U  
 C G T M S F S E N F I R S A  
 Q R D Q E C P B A S S O A R C  
 U N E P H E W A C P N V A C  
 I M Z L O Y B Y K R X E E U  
 R N G J L W L R I I V L Y M  
 E A N H D I E T U N G E T U  
 D T I F S A S N E G R D D L  
 Q I S C P R S U M A R B A  
 O O S Q A A E O N O A M Z T  
 T N E T L S D C Y K R X I E  
 O J L W H A P P E A R E D D  
 L A B V G U F T E S D R H C  
 Q B C A N A A N I T E S Q A

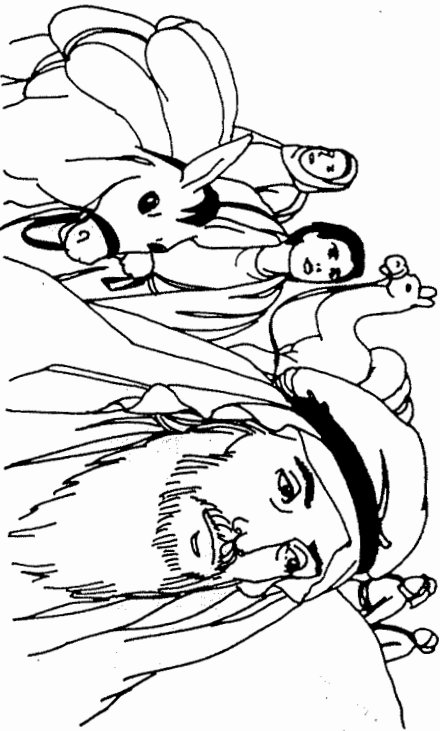

# The Story of Abraham

Abraham was a great man who served God. His descendants became the Jewish nation of Israel from which Jesus was born. First match each person or item on the left by writing the correct number beside the description on the right. Then find each word from the left in the grid below.

- |               |       |                                                               |
|---------------|-------|---------------------------------------------------------------|
| 1. TERAH      | _____ | What God provided to replace Isaac as a sacrifice (22:13)     |
| 2. NATION     | _____ | Abraham's wife's name before God changed it (11:29)           |
| 3. SARAI      | _____ | Abram's nephew (12:5)                                         |
| 4. ANGEL      | _____ | Abraham and Sarah's son (17:19)                               |
| 5. CANAAN     | _____ | What God promised to make of Abram (12:2)                     |
| 6. ABRAHAM    | _____ | Where Abram lived in Canaan (13:18)                           |
| 7. RAM        | _____ | The land where Abraham went to offer Isaac (22:2)             |
| 8. MORIAH     | _____ | Who told Abraham not to kill his son, Isaac (22:11-12)        |
| 9. PROMISE    | _____ | Where Abram lived first (11:31)                               |
| 10. UR        | _____ | The land to which Abram was led (12:5)                        |
| 11. FAITH     | _____ | Abram's father (11:31)                                        |
| 12. LOT       | _____ | The city Lot chose to pitch his tent toward (13:12)           |
| 13. ISAAC     | _____ | What Abraham was willing to do with Isaac; an offering (22:2) |
| 14. HEBRON    | _____ | What God made to Abram; covenant (15:18)                      |
| 15. SODOM     | _____ | Abram was this person's name before God changed it (17:5)     |
| 16. SACRIFICE | _____ | What Abraham showed by following God (Hebrews 11:17)          |

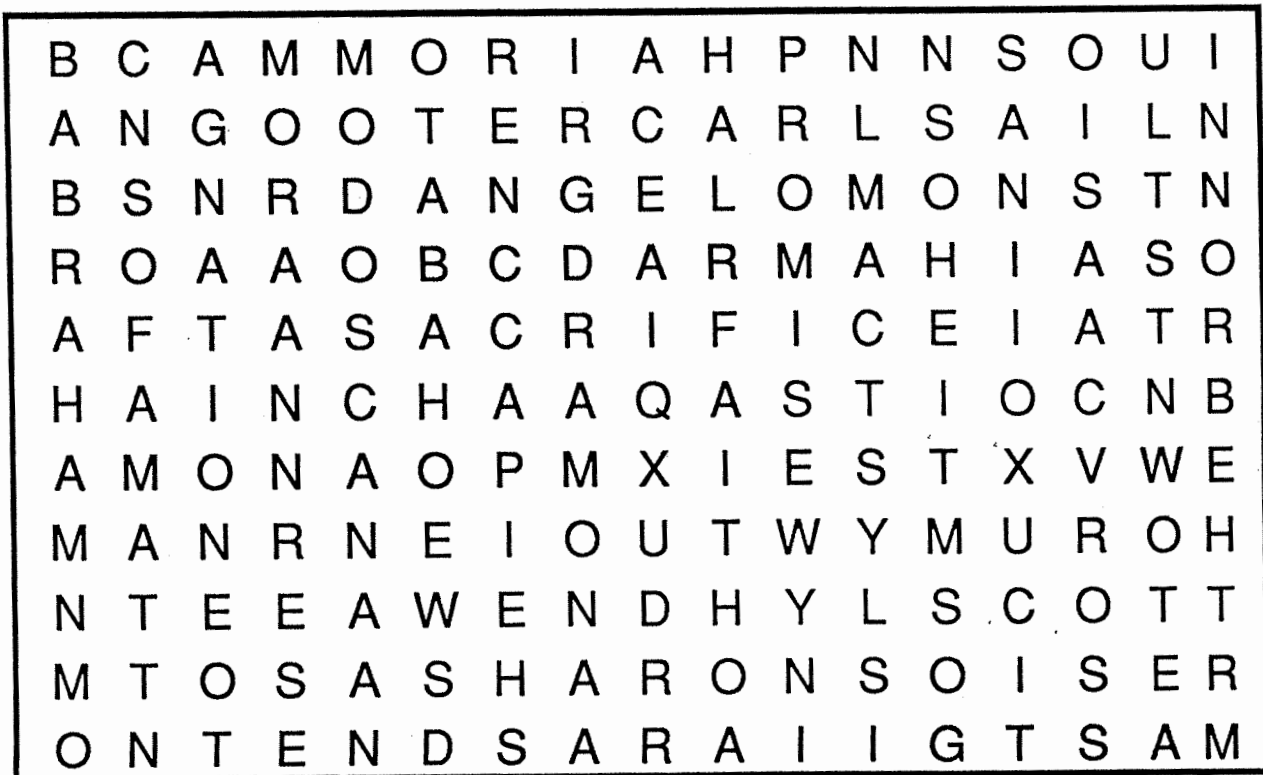

**Year 1**  
**Week 9**

## **Lot's Choice**

**Scriptures: Genesis 13**

**Key Verse: Genesis 13:15 "... for all the land which you see I give to you and your descendants forever."**

### **Key Points:**

1. Abram and Lot lived in Canaan and discovered that their possessions were so great that they could not live together.
2. To avoid conflict, Abram offered Lot first choice of the land before them.
3. Lot chose the best land for himself, although it was near to the wicked city of Sodom.
4. God assured Abram that all the land that he could see would be his, reaffirming His promise.

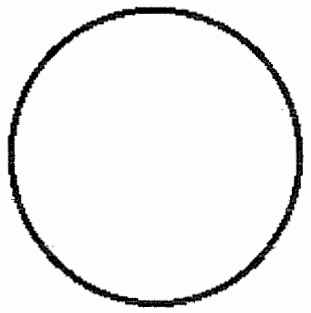

And Abram said unto Lot,  
Let there be no strife, I  
pray thee, between me  
and thee, and between my  
herdmen and thy  
herdmen; for we be  
brethren.

*Genesis 13:8*

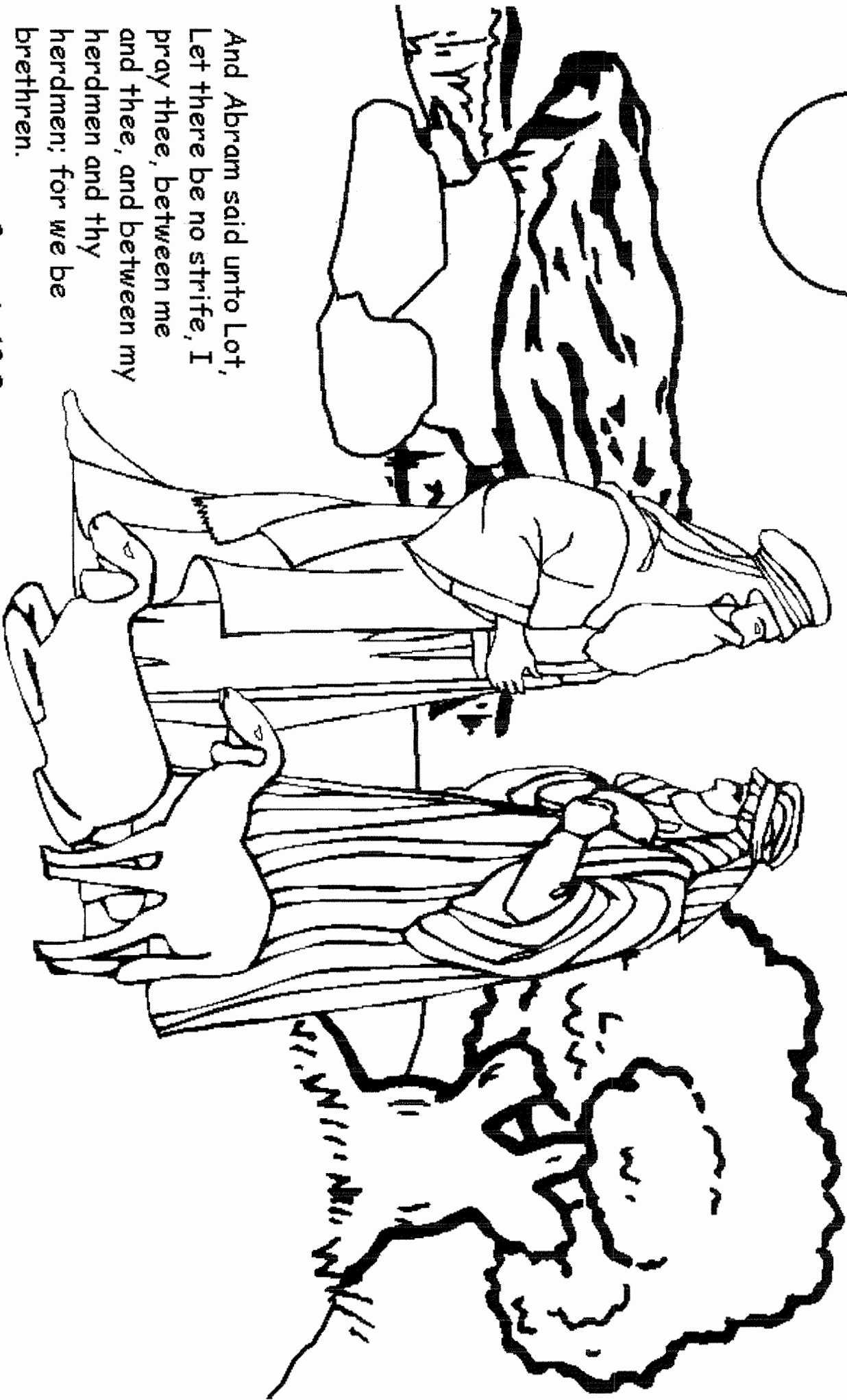



"Is not the whole land before thee? separate thyself, I pray thee, from me: if *thou wilt take* the left hand, then I will go to the right; or if *thou depart* to the right hand, then I will go to the left."

**GENESIS 13:9**

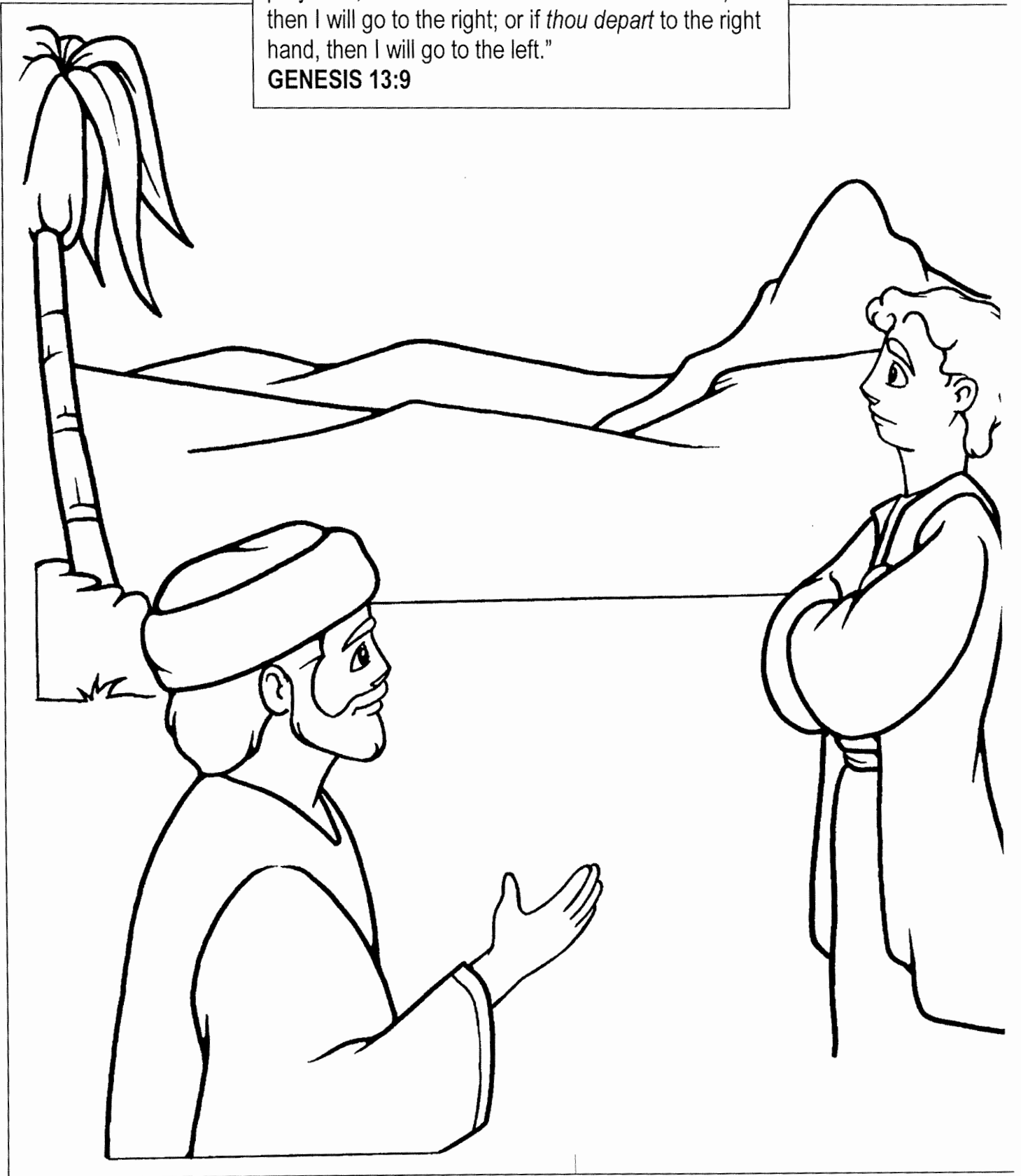

**LOT LEAVES ABRAM  
(GENESIS 13:6-18)**

The  
Covenant  
Genesis 13, 14

# Lot Needs Help!

Lot went east to live near the evil people in Sodom. Abram lived in the land of Canaan. When enemies captured Lot and his family, Abram went to rescue them. Can you help Abram reach his nephew Lot by drawing a line from Abram to Lot?



Abram

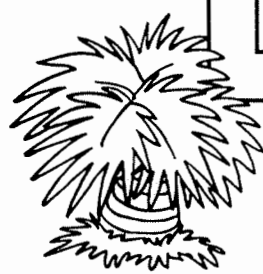
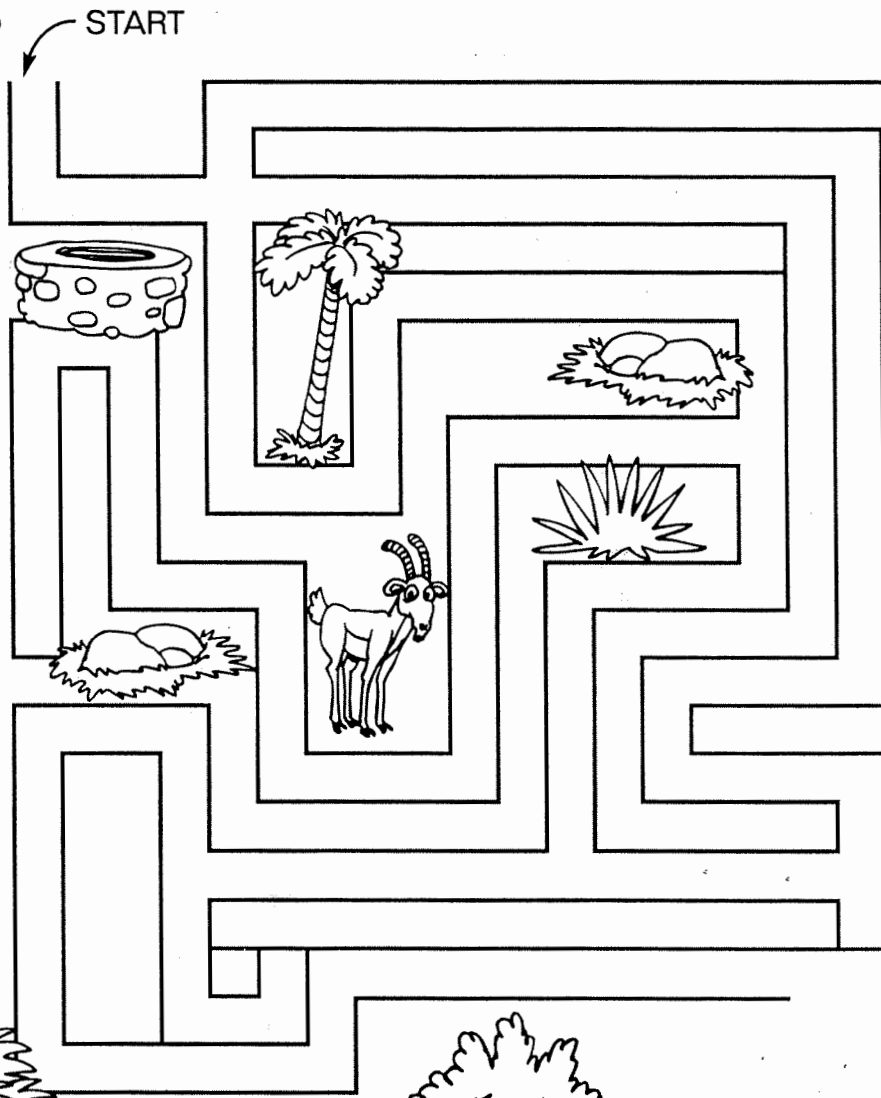

Lot



# Abram & Lot Word Search

E L C N U I D Y

F A M I L Y L B

T E N T S V O H

P E E H S C G U

family  
gold  
sheep  
tents  
uncle

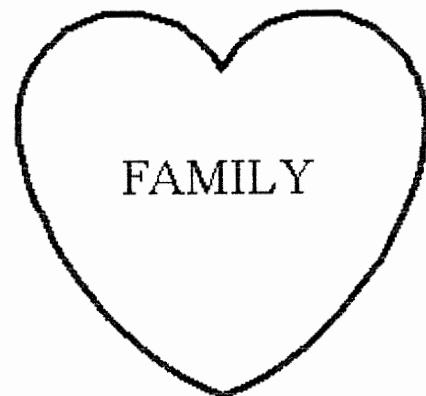

# Abram & Lot Word Search

R A S B F R E L C N U T G S Q  
N P T S Z N E N I V E E N U K  
S N O I S S E S S O P N I P R  
P F L X U M C R C D Q T T P I  
E R E R S A Z V H U W S H O W  
E C N D N V C D T T E L G R E  
H Y R A N I M A L S E D I T H  
S E A Y L I M A F O L R F V P  
H N H L S I L V E R G D B J E  
S O D O M V L E C A E P J I N

animals  
brethren  
Canaan  
family  
fighting  
gold  
herdsmen  
nephew  
peace

possessions  
rescued  
sheep  
silver  
Sodom  
stolen  
support  
tents  
uncle



# Abram and Lot Crossword

Word List	
Canaan	fighting
tents	nephew
Brethren	silver
Possessions	Sodom
Rescued	support

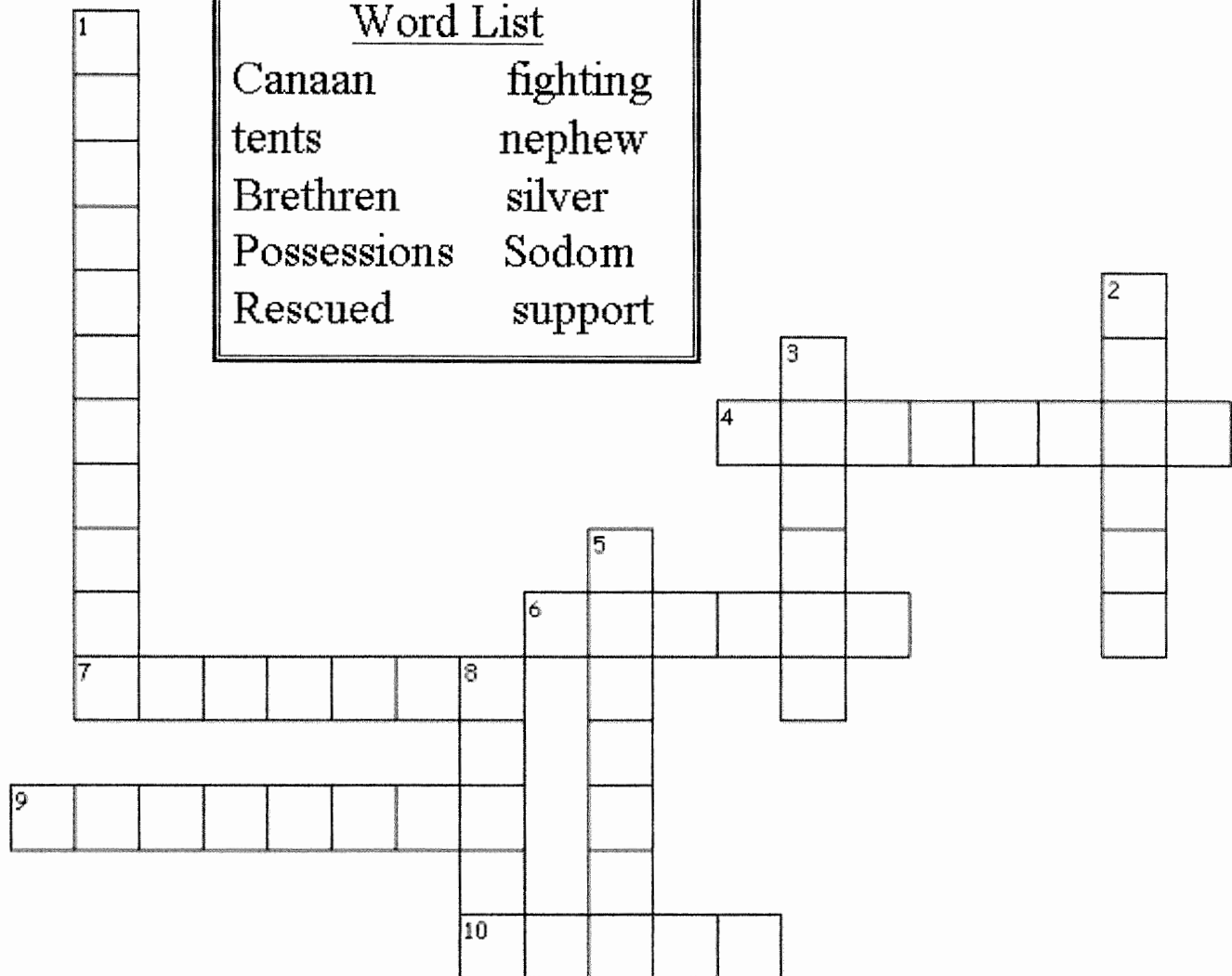

## Across

- Abram and Lot moved apart so there wouldn't be anymore \_\_\_\_.
- Lot was Abram's \_\_\_\_.
- God has given us families to \_\_\_\_ us, guide us and help us in times of trouble.
- This is another word for family.
- The four kings took Lot from this place.

## Down

- Abram and Lot had a lot of these.
- This is the place where Abram went to live.
- Abram was rich in animals, gold and this.
- Lot had to be \_\_\_\_ by his uncle.
- The families could move around faster because they lived in these.





# LOT LEAVES ABRAM

(GENESIS 13:6-18)

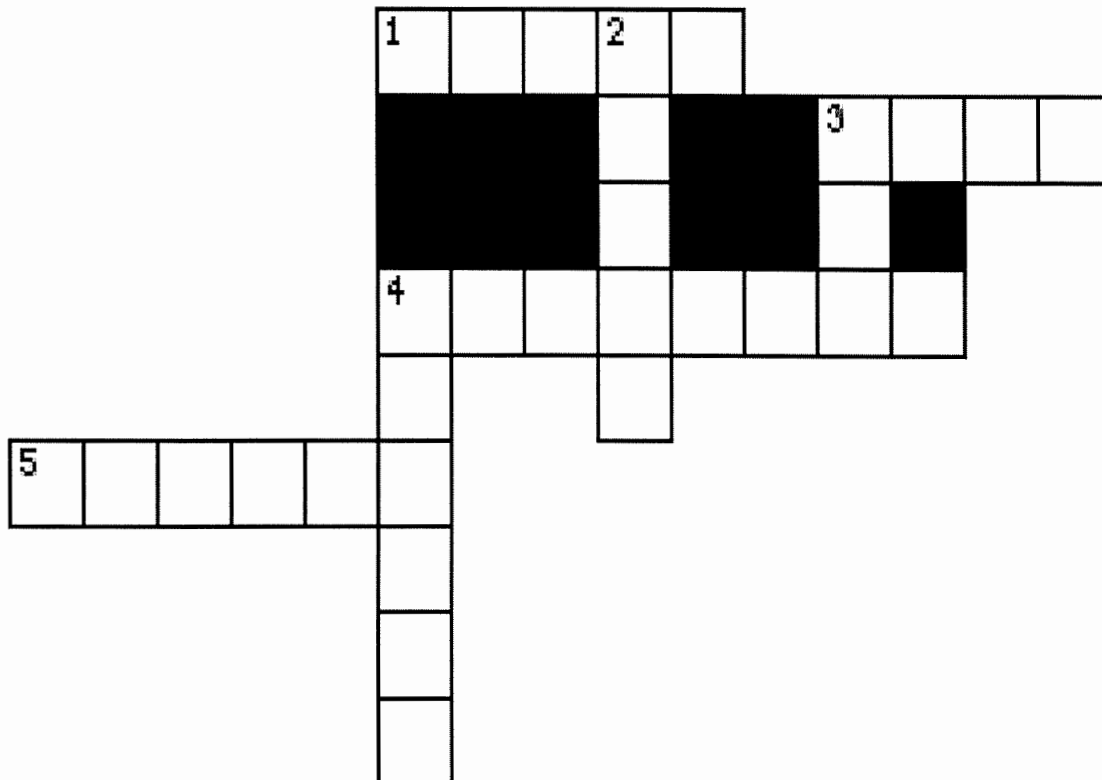

- 5 ACROSS "I will make your descendants as the dust of the earth; so that if a man could \_\_\_\_\_ the dust of the earth, then your descendants also could be numbered." **GENESIS 13:16**
- 1 ACROSS As for Abram and Lot, "the land was not able to support them, that they may dwell together, for their possessions were so \_\_\_\_\_ that they could not dwell together." **GENESIS 13:6**
- 4 DOWN "So Abram said to Lot, 'Please let there be no \_\_\_\_\_ between you and me, and between my herdsmen and your herdsmen; for we are brethren.'" **GENESIS 13:8**
- 4 ACROSS Abram said to Lot, "Is not the whole land before you? Please \_\_\_\_\_ from me." **GENESIS 13:9**
- 3 DOWN "Then \_\_\_\_\_ chose for himself all the plain of Jordan, and Lot journeyed east. And they separated from each other." **GENESIS 13:11**
- 2 DOWN "\_\_\_\_\_ dwelt in the land of Canaan, and Lot dwelt in the cities of the plain and pitched his tent even as far as Sodom." **GENESIS 13:12**
- 3 ACROSS "And the LORD said to Abram, after Lot had separated from him: 'Lift your eyes now and look from the place where you are- northward, southward, eastward, and westward; for all the \_\_\_\_\_ which you see I give to you and your descendants forever.'" **GENESIS 13:14-15**

# LOT LEAVES ABRAM

## (GENESIS 13:6-18)

### **MEMORY VERSE:**

*"I will make your descendants as the dust of the earth; so that if a man could number the dust of the earth, then your descendants also could be numbered."*

**GENESIS 13:16**

### **FILL IN THE BLANKS:**

1. As for Abram and Lot, "the land was not able to support them, that they may dwell together, for their possessions were so \_\_\_\_\_ that they could not dwell together."

**GENESIS 13:6**

2. "So Abram said to Lot, 'Please let there be no \_\_\_\_\_ between you and me, and between my herdsmen and your herdsmen; for we are \_\_\_\_\_.'"

**GENESIS 13:8**

### **MATCHING:**

**FINISH THE VERSE BY DRAWING A LINE CONNECTING ABRAM'S RESPONSE FROM THE COLUMN ON THE RIGHT:**

3. Abram said to Lot, "Is not the whole land before you? Please separate from me..."

**GENESIS 13:9**

**IF YOU TAKE THE LEFT THEN I WILL GO TO THE LEFT  
IF YOU GO TO THE RIGHT THEN I WILL GO TO THE RIGHT**

### **TRUE OR FALSE:**

4. "Then Lot chose for himself all the plain of Jordan, and Lot journeyed east. And they separated from each other." **GENESIS 13:11**

**TRUE OR FALSE**

### **FILL IN THE BLANKS:**

5. "Abram dwelt in the land of \_\_\_\_\_, and Lot dwelt in the cities of the plain and pitched his tent even as far as \_\_\_\_\_." **GENESIS 13:12**

6. "And the LORD said to Abram, after Lot had separated from him: 'Lift your eyes now and look from the place where you are- \_\_\_\_\_, \_\_\_\_\_, \_\_\_\_\_, and \_\_\_\_\_; for all the land which you see I give to you and your descendants forever.'" **GENESIS 13:14-15**

7. "Then Abram moved his tent, and went and dwelt by the \_\_\_\_\_ of Mamre, which are in Hebron, and built an \_\_\_\_\_ there to the LORD." **GENESIS 13:18**

# LOT LEAVES ABRAM

(GENESIS 13:6-18)

E G X V A O J W G V U I O L W C U F F W E E S M M M U I A H  
L S O C S B K P W C D S V O U G V Z H L Y Q Z J C K X J D C  
M N S A L H S N A C L V S U G S A X N J U U P L U I W L P C  
G B L L T F M K F E A U P H E R D S M E N T J P R R V M U N  
M K K F P V D B U B F U T I H Q J D E B W V H O S K K P K U  
B K E E U I J E R H U I W I X U O K E B I S D L J Q G X I K  
P L W O V O T A S R F A R B V M R X M K T O L T L Y P E X S  
M O V Z T I M C T C L D B T S J D U J J A E C P S E Y E R U  
W J J M N N G D O E E D H R S Q A Y Q K C E T A R A P E S N  
N Q X F D H A W M M Y N J W U L N E V U L T U N P C H C Q E  
G S W M R I A K J Q H W D G X J E E E M B K U R B Z K H I S  
K P E Q A U U I K N X T Y A H T I J V X R N S D N A H M J X  
B M L S Z A E E G Y O L M T N W S A V Y E B Y E S K C X L T  
Y B V Q E F N P H M I A K O U T G V L R T Y J R L R O I J I  
K B D V M F Q I G A R O P K D K S K A T H Z G E P V W A L K  
P O D P D T X Y D S F A G W Q O J U I T R A A B H Z V V V L  
U H D B W Q N B P V Y P K I T M S O L C E X K M L Y N M R E  
Y S Z W Q H A B V O X A G U P L P Z R M N U R U Q E J T R I  
F S Z Q E A Y P B Y S D P M L U Z X U P P E B N U H L Q K A  
K R O J X L Q P G K D S S F J G F A U M A D N A I Z D V J K  
T V W I I U L Y C W F Y E T H G I R C N I K Y P C C R U S Q  
G N H C T U U F Z L B S O S B C B M Q A E G N L C S Z G F Y  
E G Q T A T Q O H W E M T O S V X Z N A Y C M Y M G X B Q R  
Y D I C L T T J K W H U W E J I K B R N A M Q M R I Y D V X  
G P L J B D H W K Z T X I P H U O T U A Q N P T X F A O X T  
M K H W Z D T S R O L S H K T B M N K C A Q L F G L E N R P  
Q S T Y Z Q T A R A U E J J J N Z P S L O R J H B B M Z B K  
H P Y J N C T S E K W J D F Y H X Z B C Y U D D I K X F I Z  
V P O T K L R I N U Q M U Y R X I F I S E M D R V M Z N U O  
V R A N A U R A C N N G O T D A Z V F G A E R S S I U X Q V

ABRAM GIVE POSSESSIONS ALTAR  
HERDSMEN RIGHT BRETHREN JORDAN  
SEPARATE CANAAN LEFT SODOM  
DESCENDANTS LOT STRIFE DWELL  
NUMBERED WALK EYES

# LOT LEAVES ABRAM

## (GENESIS 13:6-18)

### **MEMORY VERSE:**

*"I will make your descendants as the dust of the earth; so that if a man could number the dust of the earth, then your descendants also could be numbered."*

**GENESIS 13:16**

### **CIRCLE THE CORRECT WORDS:**

1. As for Abram and Lot, "the land was not able to support them, that they may dwell together, for their possessions were so (**GREAT, SMALL**) that they could not dwell together."

**GENESIS 13:6**

2. "So Abram said to Lot, 'Please let there be no (**FRIENDSHIP, STRIFE**) between you and me, and between my herdsmen and your herdsmen; for we are brethren.' " **GENESIS 13:8**

### **MATCHING:**

**FINISH THE VERSE BY DRAWING A LINE CONNECTING ABRAM'S RESPONSE FROM THE COLUMN ON THE RIGHT:**

3. Abram said to Lot, "Is not the whole land before you? Please separate from me..."

**GENESIS 13:9**

**IF YOU TAKE THE LEFT THEN I WILL GO TO THE LEFT  
IF YOU GO TO THE RIGHT THEN I WILL GO TO THE RIGHT**

### **TRUE OR FALSE:**

4. "Then Lot chose for himself all the plain of Jordan, and Lot journeyed east. And they separated from each other." **GENESIS 13:11**

**TRUE OR FALSE**

### **FILL IN THE BLANKS:**

5. "Abram dwelt in the land of \_\_\_\_\_, and Lot dwelt in the cities of the plain and pitched his tent even as far as \_\_\_\_\_." **GENESIS 13:12**

### **UNDERLINE THE CORRECT WORDS:**

6. "And the LORD said to Abram, after Lot had separated from him:

'Lift your eyes now and look from the place where you are-

**(NORTHWARD, SOUTHWARD, UPWARD, DOWNWARD, EASTWARD, BACKWARD, & WESTWARD);**

for all the land which you see I give to you and your

descendants forever." **GENESIS 13:14-15**





**Year 1**

**Week 10**

## **God's Promises to Abram**

**Scriptures: Genesis 15**

**Key Verse: Gen. 15:6 Abram believed God and it was credited to him as righteousness.**

### **Key Points:**

- 1. Abram believed God and traveled to a new land.**
- 2. God visited Abram and reaffirmed his promise of a son to encourage Abram's faith.**
- 3. Abram followed God's instructions to offer a sacrifice.**
- 4. The smoking pot and blazing torch passed between the animals to show God's presence.**
- 5. God repeated His promise to give the land to Abram's descendants.**
- 6. God will always keep His promises on His own time schedule.**

**Year 1**

**Week 10**

**Middle School**

**God's Promises to Abram**

**Scriptures: Genesis 15, Acts 7:5, Romans 4:1-5, 16-21**

**Key Verse:**

**Gen. 15:6** Abram believed God and it was credited to him as righteousness.

**Key Points:**

1. How did God choose to communicate with Abram? According to what we know, has He ever communicated with Abram in this way before?
2. Why was Eliezer of Damascus considered the heir of Abram during this time?
3. According to verse 6, what was the characteristic that made Abram righteous in the eyes of God?
4. According to Acts 7:5, why is Abram's faith so remarkable?
5. Consider Romans 4:1-5. Did Abram earn God's grace? According to Paul, what made Abram righteous in the eyes of God?
6. According to Romans 4:16, what will we become if we have faith like Abram?
7. How strong was Abram's faith according to Romans 4:20-21?
8. Returning to Genesis 15, how did God communicate with Abram the second time in verse 12?
9. What nation would keep Abram's descendants in bondage? What sort of conditions would they live under?
10. What would God do to that nation? How would Abram's descendants benefit?
11. What does God mean in verse 16 by, "the iniquity of the Amorites is not yet complete"? (compare Deut. 7:1-5)

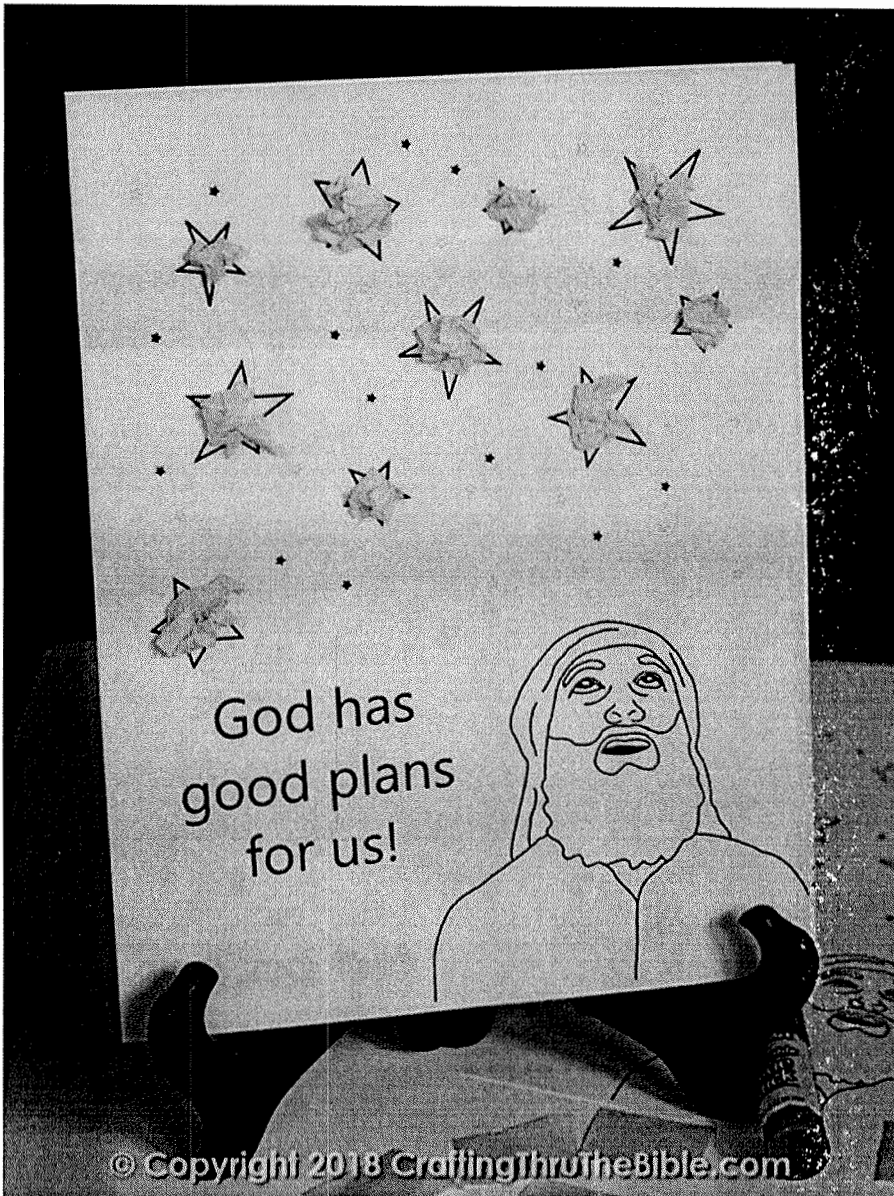

## Abram star craft

1. Print out template on craft paper
2. Let the children color the picture
3. Use small pieces of tissue paper to crumble up and glue on stars

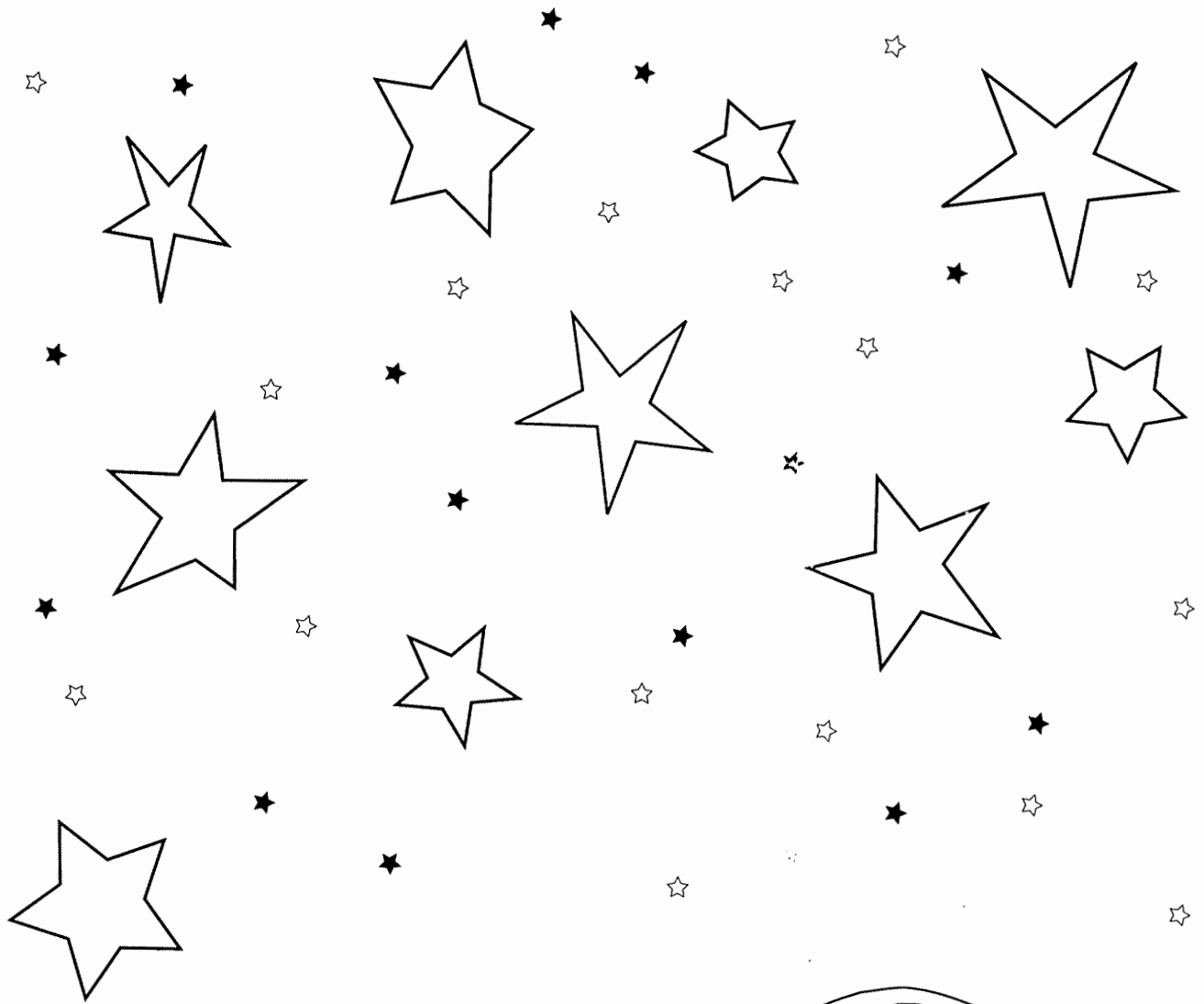

## Star Garland (Toddlers)

Cut several stars out of card stock.

Punch two holes in each star.

Have kids thread several stars through string to make garland.

(Scriptures could be printed on stars if desired)

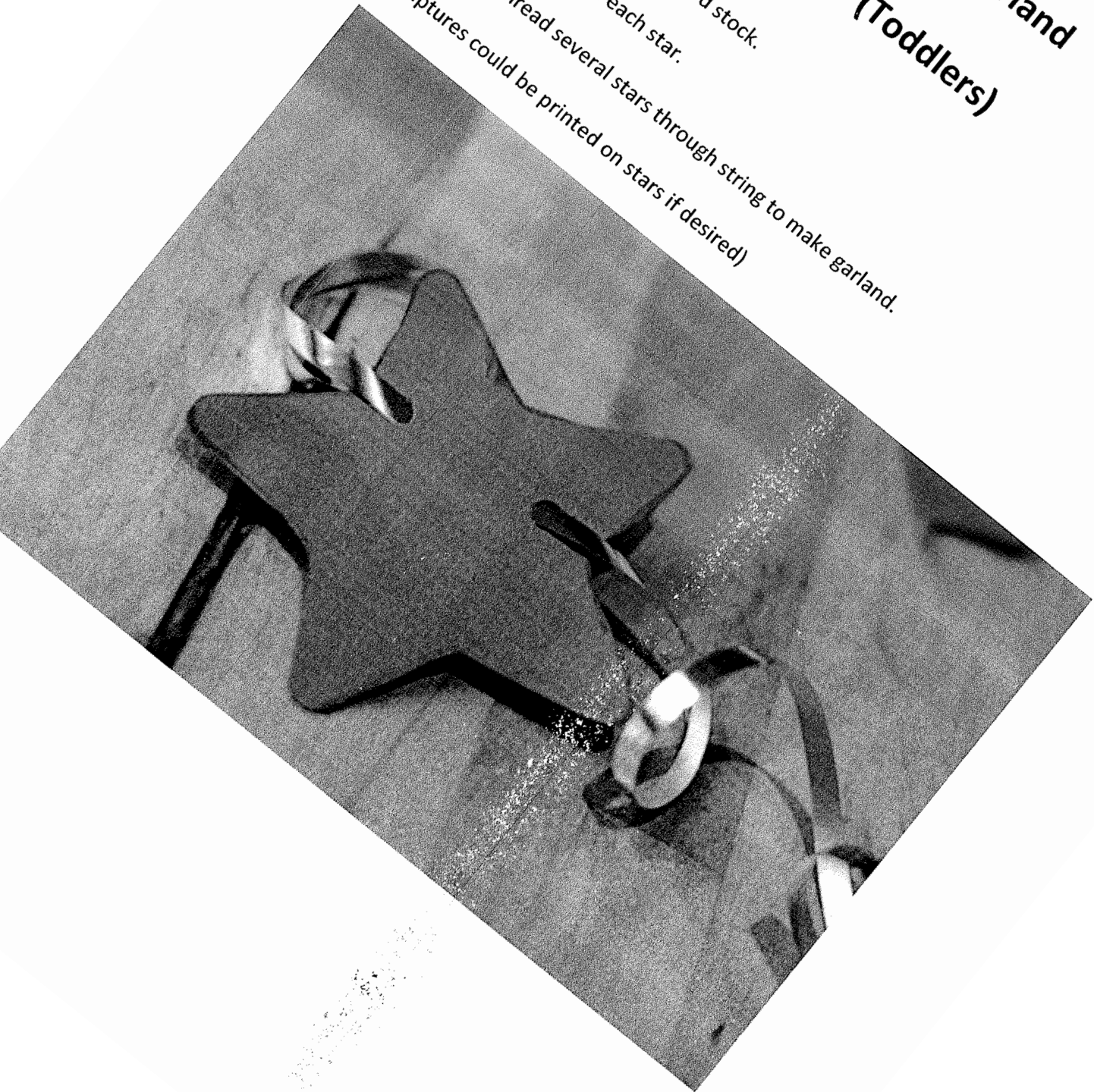

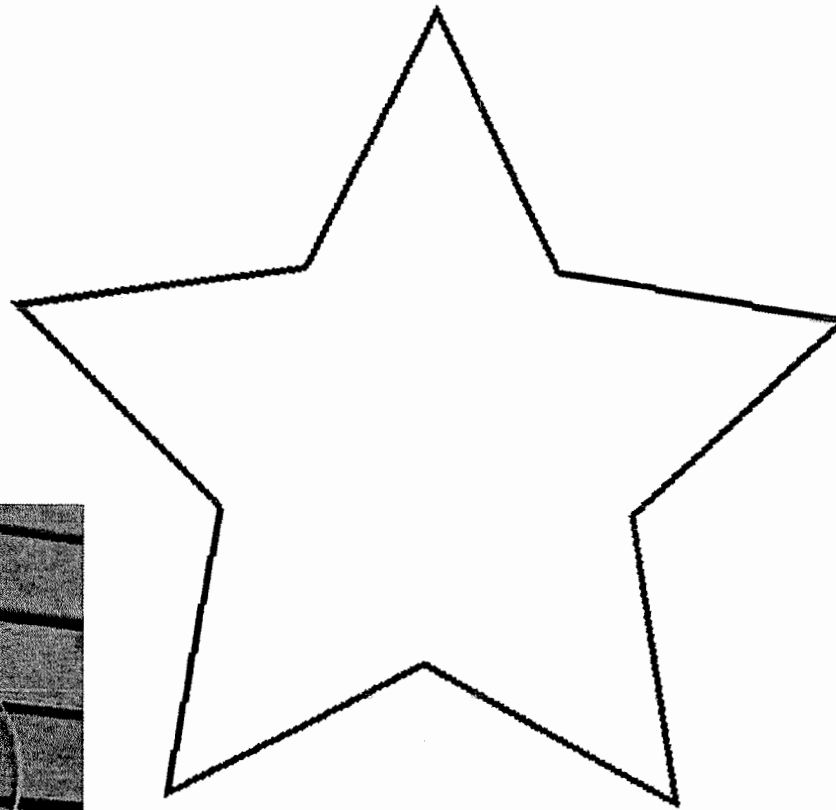
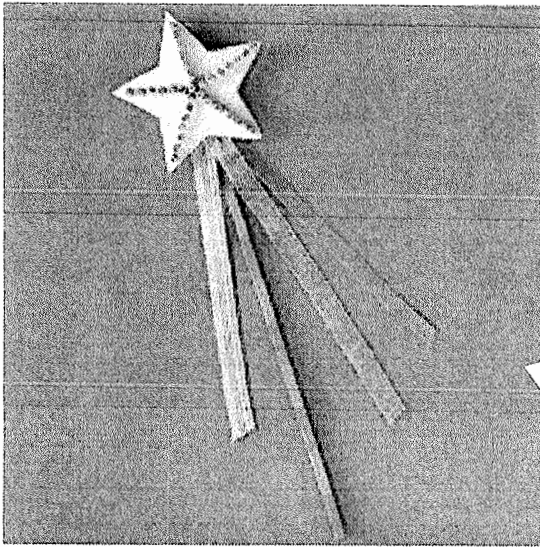

## **Star Activity**

Have children color and cut out star. From there they can make a headband with elastic or place on dowel or popsicle stick to make wand, color several and place on dowel with string to make mobile, make a magnet. Lots of options!

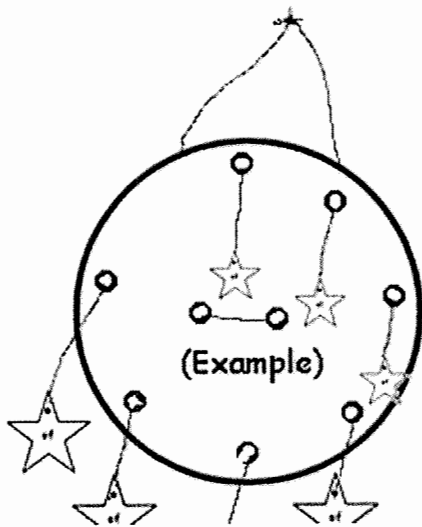
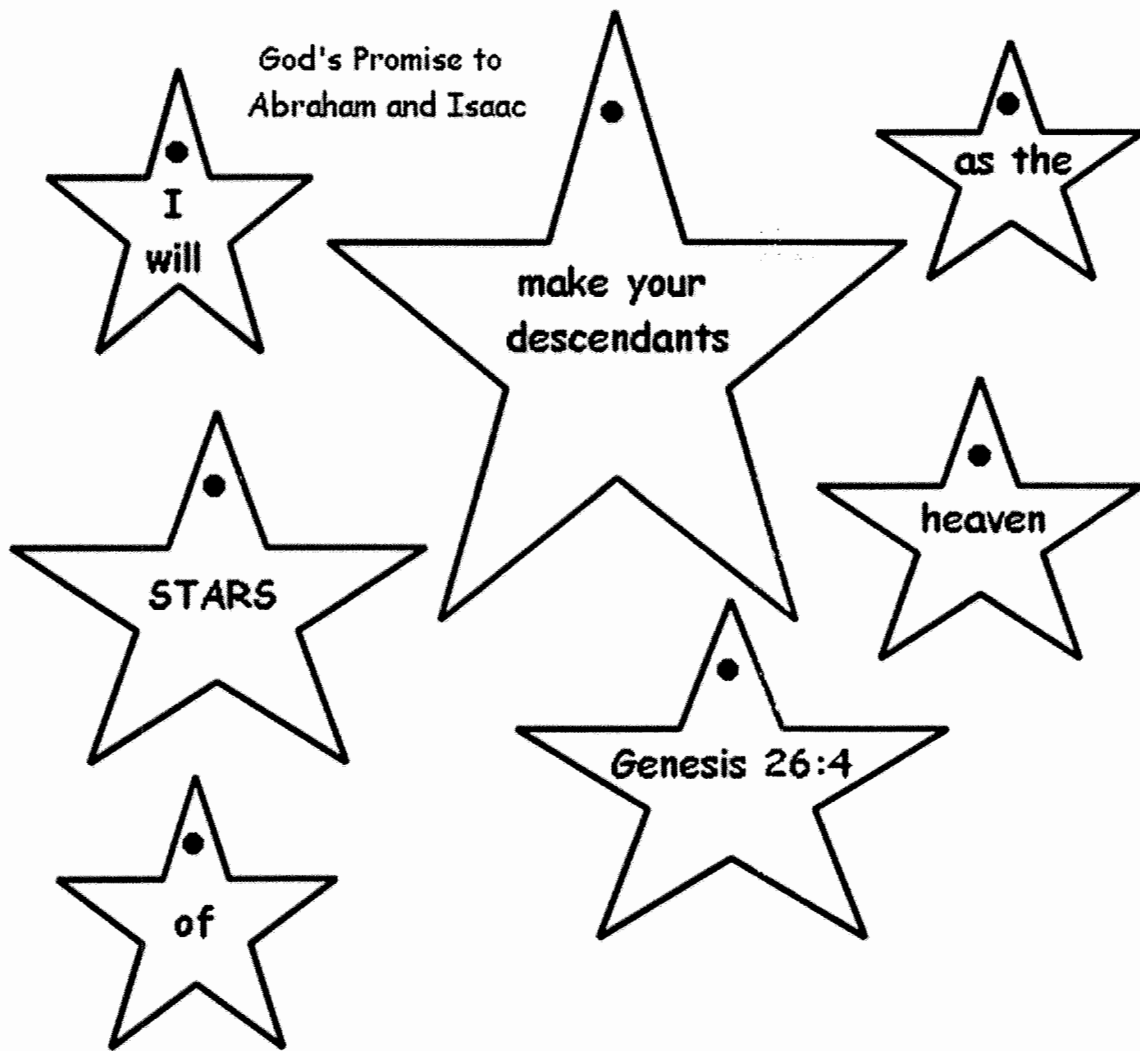

You will need paper plates and string.

Let the child color the stars.

Cut them out.

Use something sharp to punch holes.

Attach string to the stars.

Attach other end of string to a paper plate.

Attach another string through both holes

in the middle of the plate and tie to make a hanger.

(Holes could be punched in paper plates ahead of time)

# Paper Plate Craft





Father Abraham  
Bible Song

Chorus:

Father Abraham,  
had many sons.  
Many sons  
had father Abraham.  
I am one of them,  
And so are you.  
So let's all praise the Lord!

Add a movement between each chorus round:

Right Arm, Left Arm, Right Leg, Left Leg,  
Nod Your Head, Turn Around, Sit Down!

Abraham

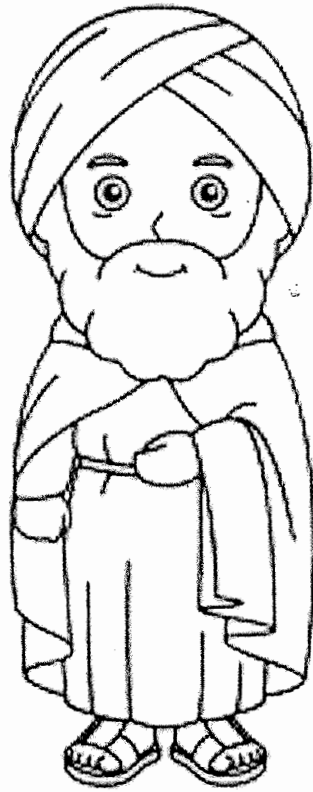

No longer will you be called Abram, your name will be Abraham, for I have made you a father of many nations. – Genesis 17.5 (NIV)

## GOD MAKES A GREAT NATION



At God's command, Abraham left his home in Ur of Chaldea and set out with his family to found a new nation.

# "God Made a Covenant with Abram"

**Genesis 15:1-6, 17-21**

Fill in the blanks with the missing words from the memory verse.

"In the same day the  
Lord made a \_\_\_\_\_  
with \_\_\_\_\_, saying, Unto  
thy seed have I given this  
" \_\_\_\_\_"  
Genesis 15:18

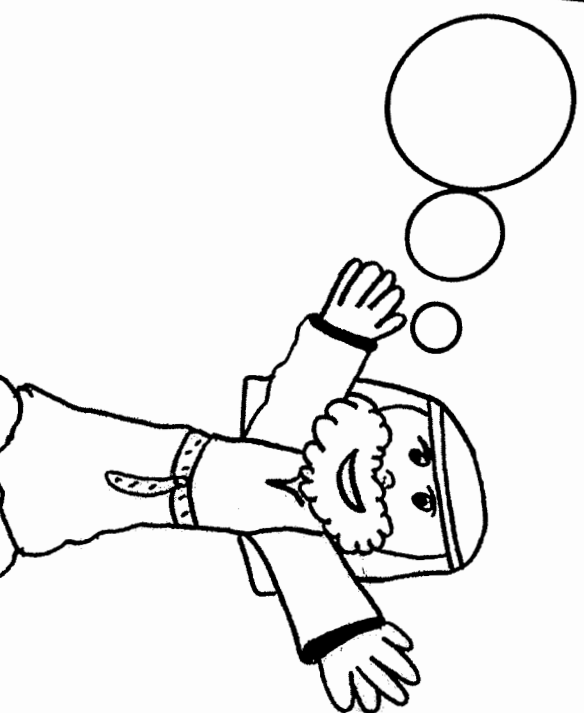

# THE NEW BEGINNING

Help Abram and his family find their way to the new land.

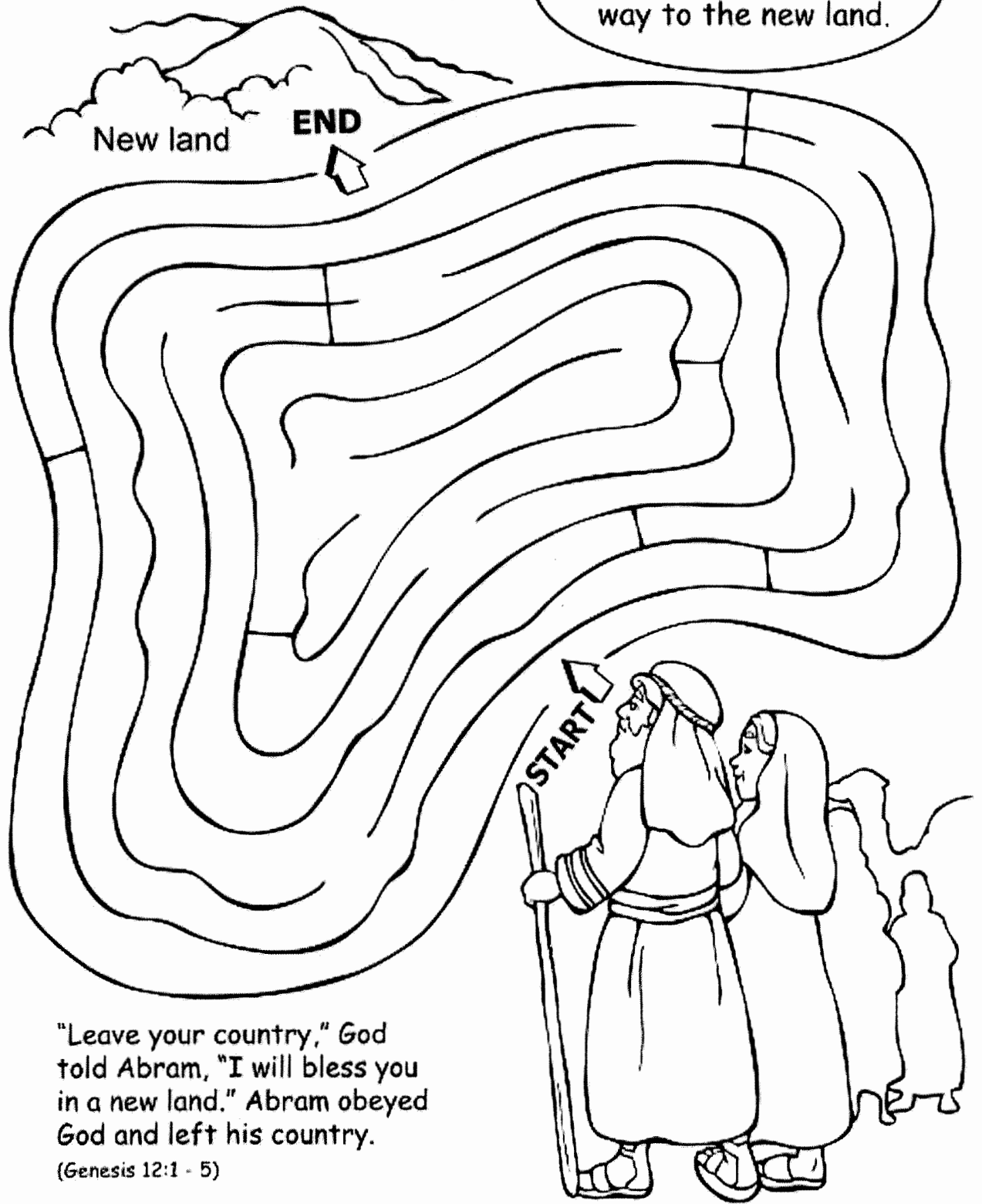

"Leave your country," God told Abram, "I will bless you in a new land." Abram obeyed God and left his country.  
(Genesis 12:1 - 5)

# ▶ ABRAHAM

## PROMISED MANY DESCENDANTS

### MEMORY VERSE

Genesis 15:2-6

*He who promised is faithful. ~ Hebrews 10:23 NIV*

**INTRODUCTION** Abraham felt sad. He did not have any children. One day, God took Abraham outside his tent and told him to look up into the night sky. Abraham looked up and saw millions of twinkling stars. Then God promised that Abraham would have as many children, grandchildren and great-grandchildren as there were stars. Even though it seemed impossible, Abraham believed in God's promise.

**FINGERPRINT STARS** Dip your pointer finger into yellow paint. Carefully paint yellow dots to fill up the sky with stars. When you're finished, try to count how many stars you made. Are there too many to count? Now you know how Abraham felt when God told him how many relatives he would have.

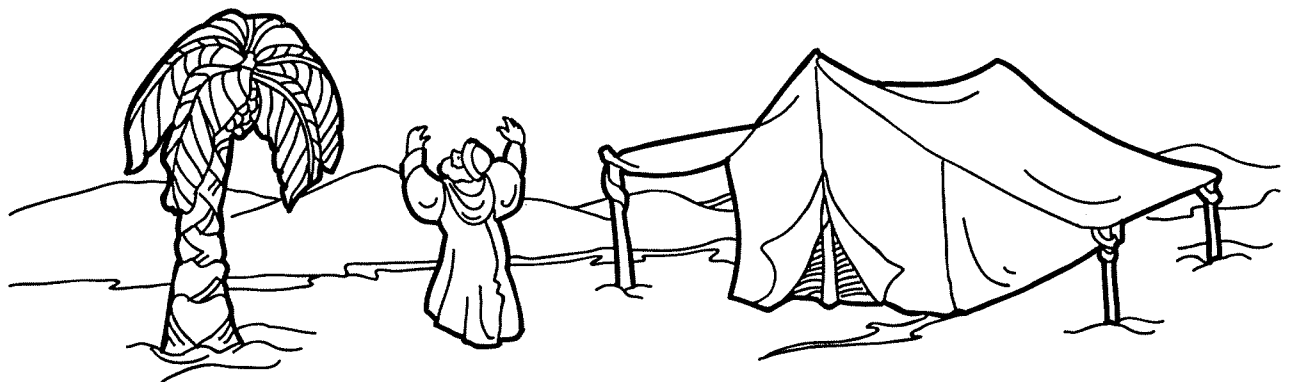

**He who promised is faithful. ~ Hebrews 10:23 NIV**

**FOR THE TEACHER** Duplicate a picture for each child. Help the children into paint smocks to protect their clothing. Provide yellow tempera paints in shallow dishes. Demonstrate how to dip one finger into the paint and make yellow dots in the sky. Explain that God gave Abraham a promise that seemed impossible. Nevertheless, God always keeps His promises.

# Abraham and Sarah Move to a New Land

God told Abraham and Sarah to move to a new land. He promised to make Abraham's sons and daughters into a great nation. God said that one day the whole world would be blessed through a child born from Abraham's family.

God kept His promises when He sent Jesus to be our Savior. Jesus was a great-great-great ... grandson of Abraham and Sarah. Help Abraham and Sarah find their new home.

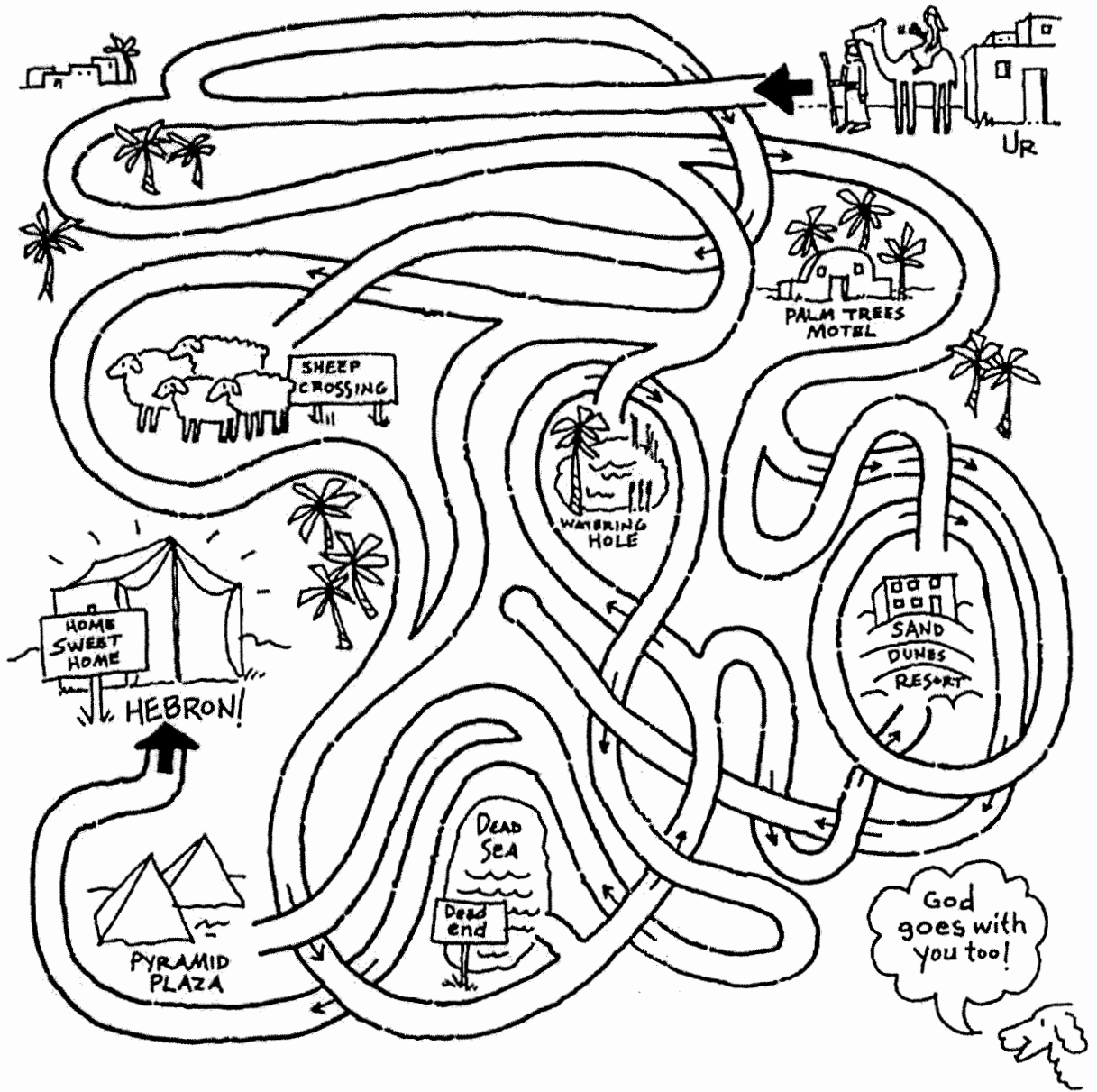

# Bible Pathway Adventures

ABRAHAM WORKSHEET

## ABRAHAM OBEYS GOD

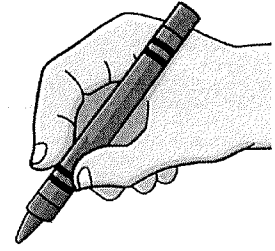

Fill in the blanks. Color the picture.

“Leave your \_\_\_\_\_, your relatives, and your \_\_\_\_\_ house, and go to the \_\_\_\_\_ that I will show you. I will make of you a great \_\_\_\_\_. I will \_\_\_\_\_ you and make your \_\_\_\_\_ great.”

(Genesis 12:1-2)

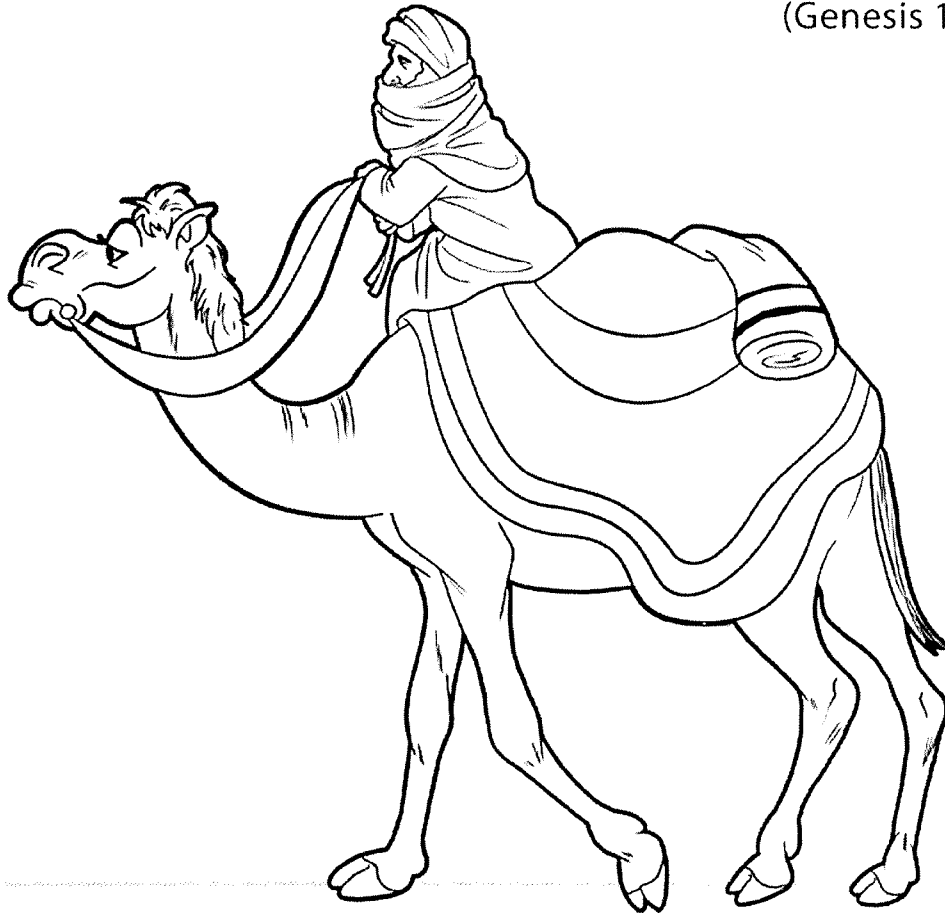

For more free Bible resources and Teacher Packs including coloring pages, worksheets, quizzes and more visit our website at: [www.biblepathwayadventures.com](http://www.biblepathwayadventures.com)





## **Abraham Father of Many Nations Portrait Craft**

### Materials:

- Construction paper
- Abraham clip-art
- Star stickers
- Sand

Copy Abraham. Have kids glue on blue construction paper, place stars in sky, and sand on the bottom. Add scripture if desired:

Genesis 17:4

“Behold, my covenant is with you, and you shall be the father of a multitude of nations.”

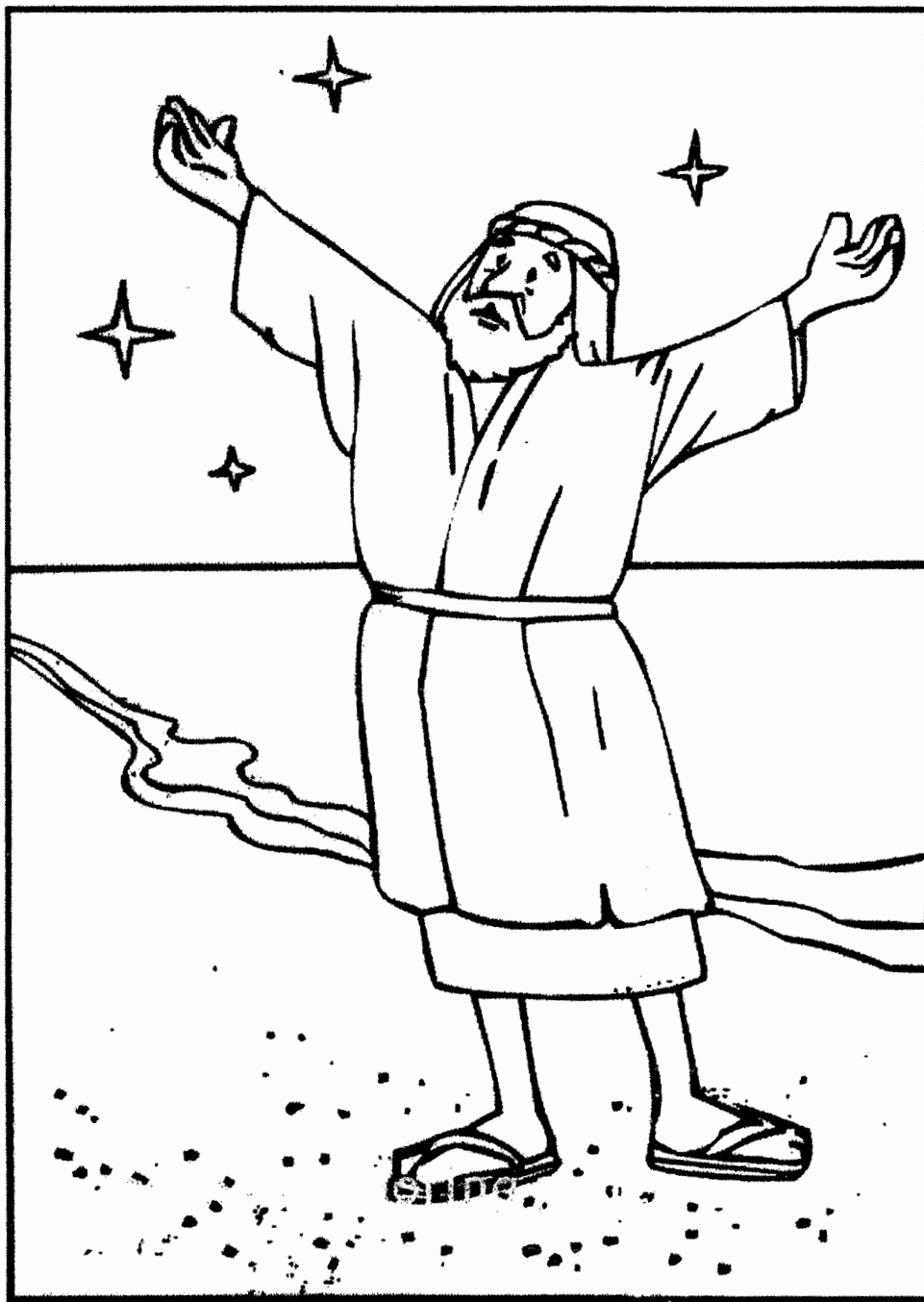

*Genesis 15:5 (NKJV)*  
*Then He brought him outside and said,*  
*"Look now toward heaven, and count the stars*  
*if you are able to number them." And He said to him,*  
*"So shall your descendants be."*

# God's Promise to Abraham

Abraham believed in the word of ..... and prayed to Him. Because of this God promised to make Abraham the ..... of a great people. He told him and his wife ..... to leave his country and go to a land that God would show them. They did exactly as God told them to do. God promised to give the land called ..... to him and his descendants. He also promised Abraham a ..... who would inherit everything he owned and he would have as many descendants as there are ..... in the sky. God told Abraham to offer some animals. They should be killed and he should ..... them in two parts. But he did not divide all of the animals. The God said Abraham's descendants would be ..... in a foreign land before they could return

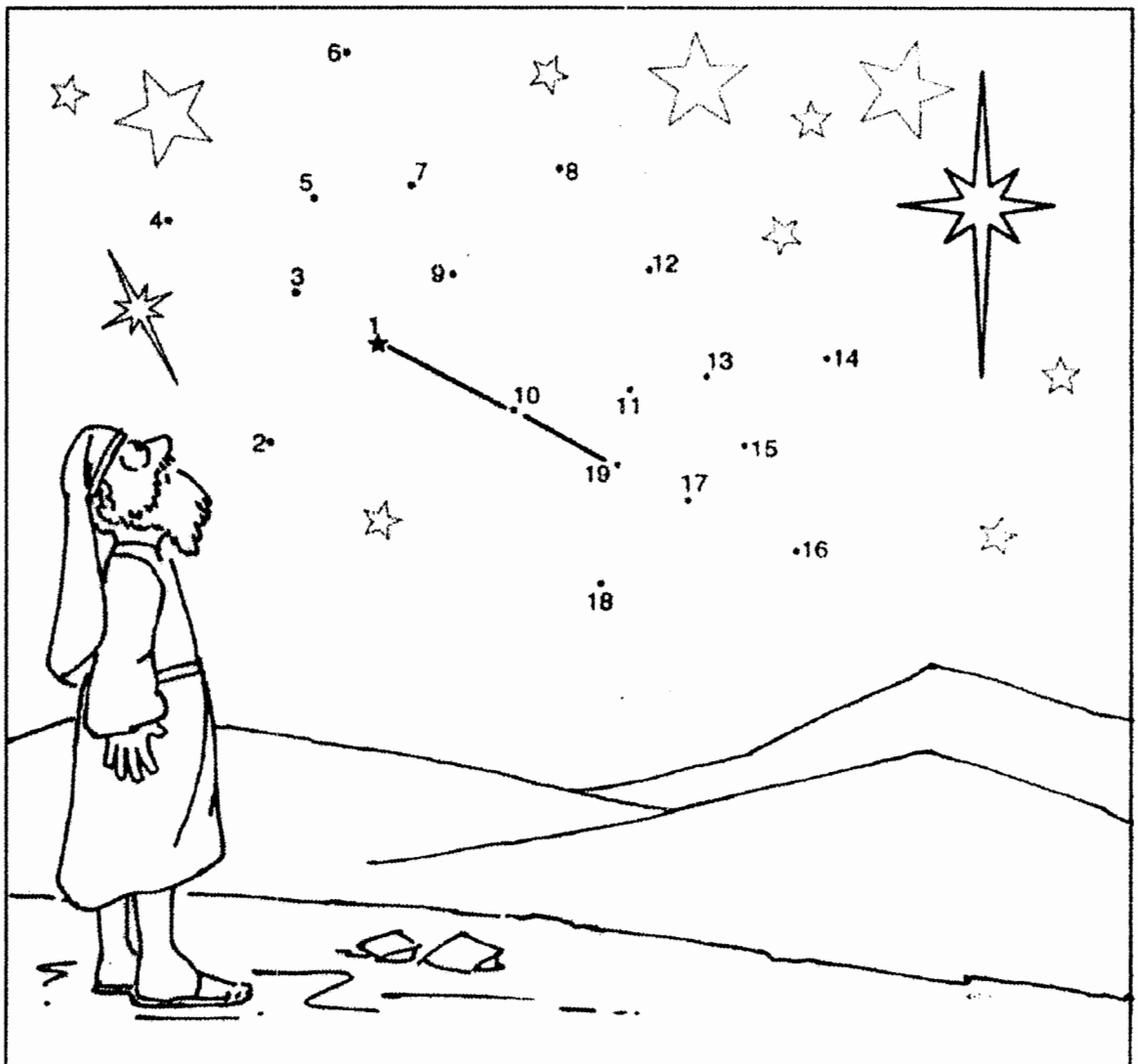

# Abraham & Sarah Word Search

S T A R S N B D

Y A R P Q J A L

R E H T A F B O

F A M I L Y Y K

BABY  
FAMILY  
FATHER  
OLD  
PRAY  
STARS

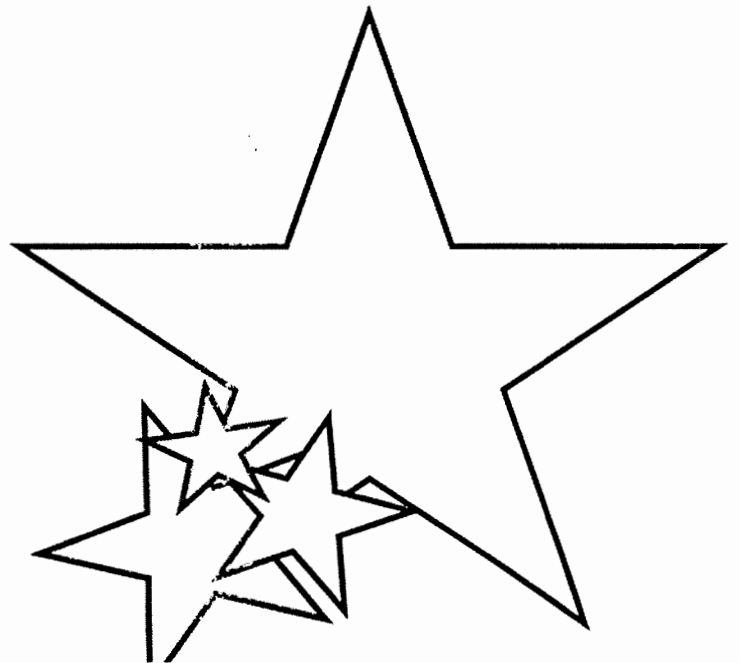

# Abraham & Sarah Word Search

R J F S O S L C C F L N Y P H  
A I C A R L O Q H A R U R E A  
S N G A M V D D I T A A X M R  
V R T H E I E F L H Y S G A A  
R S O N T H L A D E K Q I H S  
U A A T G E N Y R R H T I A F  
Z N R U I S O S E S I M O R P  
T W A B L S Q U N M E B A B Y  
L L Z U T M I F S W D X I A O  
M I R A C L E V F O B Q T D D

ABRAHAM  
BABY  
CHILDREN  
COVENANT  
FAMILY  
FAITH  
FATER  
ISAAC  
LAUGHED

OLD  
PRAYER  
PROMISES  
MIRACLE  
RIGHTEOUS  
SARAH  
STARS  
VISITORS

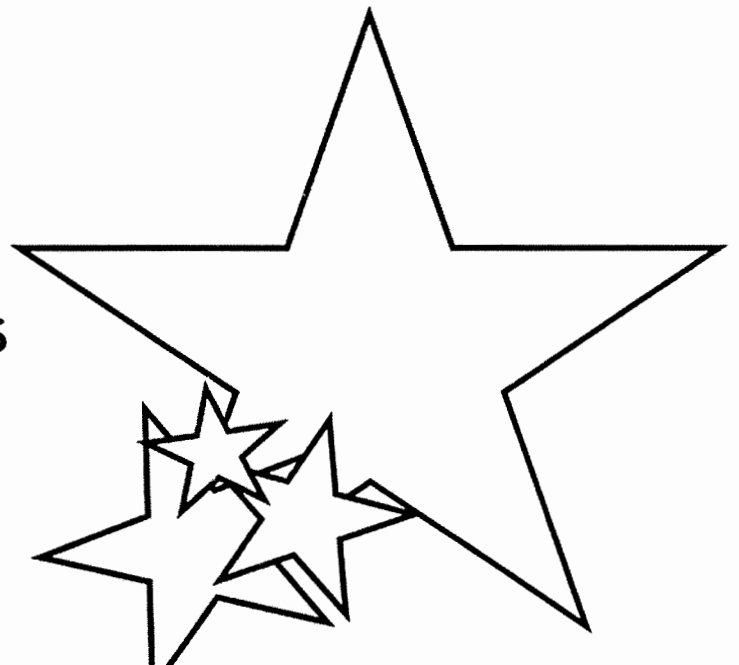

# Bible Hero

## Sarah and Abraham

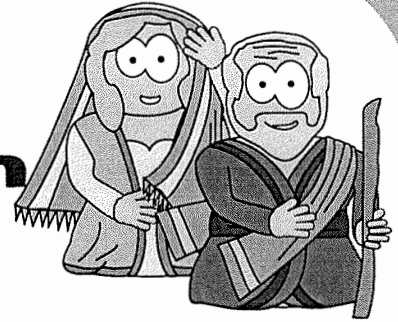

### A covenant promise

God made a special promise called a covenant. A covenant is an agreement between God and his people. What other covenants are these pictures are showing...

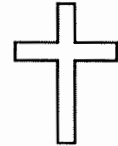
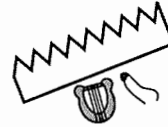
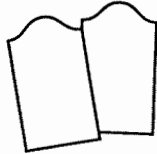
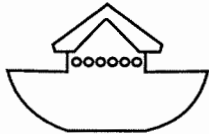

.....

.....

The messiah will come  
from David's family

.....

As part of the promise God gave Abram and Sarai new names Abraham and Sarah. Why do you think God chose these names - use the names meaning to help you out

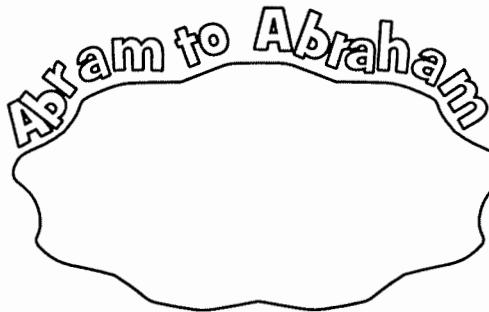

What the Names stand for:

- Abram = high father
- Abraham = father to many
- Sarai = quarrelsome
- Sarah = princess to the many
- Isaac = he laughs



Sarah's Promise from God

What can Sarah and Abraham see in the stars?  
Join up the stars to reveal the image.

Look back at the 4 covenants at the top of the page. Each time God made a promise he kept his word, each promise adding to the last. Through Jesus, we are all now children of Abraham, part of God's chosen people. Write your name below.

God chose

to be part of his family



# Abraham

I will make you into a great nation and I will bless you; I will make your name great, and you will be a blessing(Genesis 12,2).



Find the hidden words

O P E U  
 R T R A D R I  
 T C A N A A N A N  
 U O N O Z E I O R U N B I  
 N H L R V V O G A F A I T H H B B  
 D F A A O B E G Y D N R H T A A G E  
 B E G N H H N A P E I S A A C R K T  
 C D A R A F A I T L L E R N Z A L H  
 A E R R N D N V I S H M A E L N D E  
 L P E O M E T S A Q U T S F D O P L  
 L T M E L C H I Z E D E K C G Z A Z



[www.biblekids.eu](http://www.biblekids.eu)

- Hagar
- Melchizedek
- Ishmael
- Covenant
- Sarah
- God
- Isaac
- Nahor
- Ur
- Terah
- Haran
- Call
- Lot
- Canaan
- Bethel
- Egypt
- Faith



# Bible Pathway Adventures

BIBLE QUIZ

## ABRAHAM

Match the question with the  
answer on the right.

### QUESTIONS

- \_\_\_ Where was Abram born?
- \_\_\_ Who was Abram's father?
- \_\_\_ Who did Abram marry?
- \_\_\_ Which land did God promise to Abram?
- \_\_\_ What did Abram do after Lot was taken prisoner?
- \_\_\_ What did Melchizedek give to Abram?
- \_\_\_ What did Yah's new name for Abraham mean?
- \_\_\_ How old was Abraham when he became a father?
- \_\_\_ What was the name of Abraham's special son?
- \_\_\_ What did his special son carry to the sacrifice?
- \_\_\_ How old was Abraham's wife when she died?

### ANSWERS

1. 100 years
2. Isaac
3. Fought to save him
4. Canaan
5. Haran
6. Terah
7. Father of the multitude
8. Sarai (Sarah)
9. Wood
10. 127 years
11. Bread and wine



Name: \_\_\_\_\_ Date: \_\_\_\_\_

## Genesis - Abraham



sweetpublishing.com (CC BY-SA 3.0)

1. \_\_\_\_\_ the king of Salem (Genesis 14)
2. \_\_\_\_\_ Abraham believed God and he credited it to him as \_\_\_\_
3. \_\_\_\_\_ Abraham's nephew
4. \_\_\_\_\_ the animal God provided for a sacrifice instead of Isaac
5. \_\_\_\_\_ Abraham and Sarah's son
6. \_\_\_\_\_ Abraham had many \_\_\_\_ and herds
7. \_\_\_\_\_ the land God told Abraham to go to
8. \_\_\_\_\_ God promised Abraham his offspring would be as numerous as the \_\_\_\_
9. \_\_\_\_\_ Abraham's original name
10. \_\_\_\_\_ Sarah's original name
11. \_\_\_\_\_ Abraham's father
12. \_\_\_\_\_ Abraham's first son by Sarah's maid, Hagar
13. \_\_\_\_\_ the land Lot chose
14. \_\_\_\_\_ Abraham's wife

1. Terah	5. Lot	9. Melchizedek	13. righteousness
2. Abram	6. Canaan	10. Ishmael	14. ram
3. Sarah	7. flocks	11. Isaac	
4. Sarai	8. Jordan	12. stars	

# Abraham Obey's God

maxiPraise  
© 2005



**THE  
Promised  
Land**

**God said:**  
"Leave your country  
your family and  
your father's house  
for a land which I will show you."



❖ Help Abraham travel to the promised land.

• Use the symbols along the way to find from the list below what else Abraham was promised.

• Then using those promises find the answer to this question:

**What was the name of the promised land?**

- \* • have many desendants (C)
- ⊗ • live in a castle (O)
- \* • be blessed (A)
- \* • have great peace (U)
- \* • be famous (N)
- \* • be a king (H)
- \* • have total happiness (I)
- ⊙ • be a blessing (A)
- \* • be wealthy (D)
- + • have many cattle (K)
- ⊙ • be protected (N)

# The Covenant with Abraham

- A. **Genesis 13v14-17.** Use these verses to show: 1. That the promises were made personally to Abraham (Find at least 4 phrases) a. \_\_\_\_\_ b. \_\_\_\_\_  
 c. \_\_\_\_\_ d. \_\_\_\_\_ (e.) \_\_\_\_\_  
 2. That the promises to Abraham concerned the actual land of Israel, not heaven: (Find at least two phrases) a. \_\_\_\_\_  
 b. \_\_\_\_\_  
 (c.) \_\_\_\_\_  
 3. Who else was promised the land? \_\_\_\_\_ 4. Who is this? \_\_\_\_\_  
 Extra Credit: Prove this point. 5. How long would they have the land? \_\_\_\_\_



- B. **Genesis 17v15-22** 1. What does Sarai's new name mean? \_\_\_\_\_ 2. Why did God give her this new name? \_\_\_\_\_  
 3. What promises did God give Abraham and Sarah? a. \_\_\_\_\_  
 b. \_\_\_\_\_ c. \_\_\_\_\_  
 d. \_\_\_\_\_ 4. How did these promises change Abraham's family? \_\_\_\_\_  
 5. What did God promise He would do for Isaac? a. \_\_\_\_\_  
 b. \_\_\_\_\_ 6. Who else were these promises made to? \_\_\_\_\_  
 7. What did God promise Ishmael? \_\_\_\_\_

- C. **Gen 26v1-5.** 1. Who did God appear to? \_\_\_\_\_ What did God promise him?  
 a. \_\_\_\_\_ b. \_\_\_\_\_ c. \_\_\_\_\_  
 d. \_\_\_\_\_ e. \_\_\_\_\_ f. \_\_\_\_\_  
 2. Who else received promises here? \_\_\_\_\_ 3. What promises were given him? a. \_\_\_\_\_ b. \_\_\_\_\_ c. \_\_\_\_\_  
 4. How does this verse show Issac was not the "seed" promised to Abraham?  
 \_\_\_\_\_

- D. **Genesis 28v13-15.** 1. Who is the "thee" in verse 13? \_\_\_\_\_ 2. To whom else were these promises made? \_\_\_\_\_ 3. Who is this? \_\_\_\_\_ 4. How do we know what "land" God was referring to? \_\_\_\_\_  
 5. What promises did God give? (v.13-15) a. \_\_\_\_\_  
 b. \_\_\_\_\_ c. \_\_\_\_\_  
 d. \_\_\_\_\_ e. \_\_\_\_\_  
 f. \_\_\_\_\_ g. \_\_\_\_\_  
 (h) \_\_\_\_\_ (i) \_\_\_\_\_  
 6. Where is "in thy seed shall all nations of the earth be blessed" quoted from? \_\_\_\_\_ What does it mean? \_\_\_\_\_



# GOD MAKES A PROMISE TO ABRAM

(GENESIS 15:1-17:19; 18:1-16)

## MEMORY VERSE:

*"For the promise that he would be the heir of the world was not to Abraham or to his seed through the law, but through the righteousness of faith." ROMANS 4:13*

## CIRCLE THE CORRECT WORDS:

1. "Abram said, 'Lord GOD, what will You give me, seeing I go (CHILDLESS, SMILELESS), and the heir of my house is Eliezer of Damascus?' " GENESIS 15:2
2. "And behold, the word of the LORD came to him, saying, 'This one shall not be your heir, but one who will come from your own body shall be your (HAIR, HEIR).' " GENESIS 15:4

## TRUE OR FALSE:

3. "Then He brought him outside and said, 'Look now toward heaven, and count the stars if you are able to number them.' And He said to him, 'So shall your descendants be.' " GENESIS 15:5  
TRUE OR FALSE
4. "And he believed in the LORD, and He accounted it to him for righteousness." GENESIS 15:6  
TRUE OR FALSE

## FILL IN THE BLANKS:

5. "On the same day the LORD made a covenant with Abram, saying: 'To your descendants \_\_\_\_\_  
\_\_\_\_\_ this land, from the river of Egypt to the great river, the River Euphrates.'" GENESIS 15:18-19

## TRUE OR FALSE

6. "When Abram was ninety-nine years old, the LORD appeared to Abram and said to him, 'I am Almighty God; walk before Me and be blameless.' " GENESIS 17:1  
TRUE OR FALSE

## CIRCLE THE CORRECT WORDS:

7. "As for Me, behold, My covenant is with you, and you shall be a (FATHER, BROTHER) of many nations. No longer shall your name be called Abram, but your name shall be called (ABE, ABRAHAM); for I have made you a father of (FEW, MANY) nations.' " GENESIS 17:4-5
8. "Also I give to you and your descendants after you the (OCEAN, LAND) in which you are a stranger, all the land of Canaan, as an everlasting possession; and I will be their God." GENESIS 17:8  
  
"THEN THE LORD APPEARED TO HIM BY THE TEREBINTH TREES OF MAMRE, AS HE WAS SITTING IN THE TENT DOOR IN THE HEAT OF THE DAY." GENESIS 18:1
9. "And He said, 'I will certainly return to you according to the time of life, and behold, Sarah your wife shall have a (HEADACHE, SON).' " GENESIS 18:10
10. "And the LORD said to Abraham, 'Why did Sarah (LAUGH, CRY), saying, "Shall I surely bear a child, since I am (YOUNG, OLD)' Is there anything too (HARD, EASY) for the LORD? At the appointed time I will return to you, according to the time of life, and Sarah shall have a son.' "  
GENESIS 18:13-14

# GOD MAKES A PROMISE TO ABRAM

(GENESIS 15:1-17:19; 18:1-16)

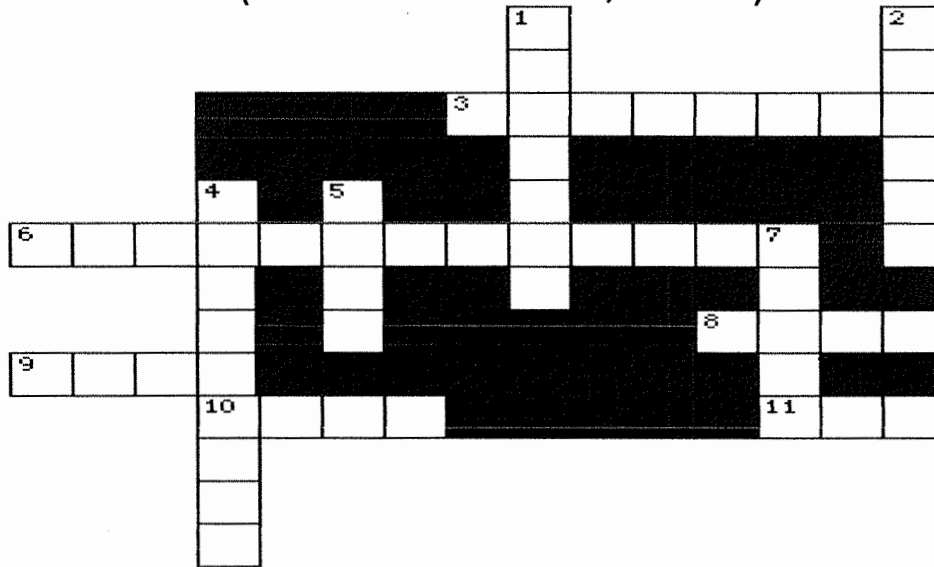

- 1 DOWN "For the \_\_\_\_\_ that he would be the heir of the world was not to Abraham or to his seed through the law, but through the righteousness of faith." **ROMANS 4:13**
- 4 DOWN "Abram said, 'Lord GOD, what will You give me, seeing I go \_\_\_\_\_, and the heir of my house is Eliezer of Damascus?'" **GENESIS 15:2**
- 5 DOWN "And behold, the word of the LORD came to him, saying, 'This one shall not be your heir, but one who will come from your own body shall be your \_\_\_\_\_'" **GENESIS 15:4**
- 7 DOWN "Then He brought him outside and said, 'Look now toward heaven, and count the \_\_\_\_\_ if you are able to number them.' And He said to him, 'So shall your descendants be.'" **GENESIS 15:5**
- 6 ACROSS "And he believed in the LORD, and He accounted it to him for \_\_\_\_\_" **GENESIS 15:6**
- 3 ACROSS "On the same day the LORD made a \_\_\_\_\_ with Abram, saying: 'To your descendants I have given this land, from the river of Egypt to the great river, the River Euphrates.'" **GENESIS 15:18-19**
- 8 ACROSS "When Abram was ninety-nine years old, the LORD appeared to Abram and said to him, 'I am Almighty God; \_\_\_\_\_ before Me and be blameless.'" **GENESIS 17:1**
- 2 DOWN "As for Me, behold, My covenant is with you, and you shall be a \_\_\_\_\_ of many nations. No longer shall your name be called Abram, but your name shall be called Abraham; for I have made you a father of many nations.'" **GENESIS 17:4-5**
- 10 ACROSS "Also I give to you and your descendants after you the \_\_\_\_\_ in which you are a stranger, all the land of Canaan, as an everlasting possession; and I will be their God." **GENESIS 17:8**
- 11 ACROSS "And He said, 'I will certainly return to you according to the time of life, and behold, Sarah your wife shall have a \_\_\_\_\_.'" **GENESIS 18:10**
- 9 ACROSS "And the LORD said to Abraham, 'Why did Sarah laugh, saying, 'Shall I surely bear a child, since I am old' Is there anything too \_\_\_\_\_ for the LORD?'" **GENESIS 18:13-14**

# GOD MAKES A PROMISE TO ABRAM

(GENESIS 15:1-17:19; 18:1-16)

C O V E N A N T S T A R S H D  
 T Y M H Z K W H B N I E E E F  
 O M S J W G A L O B V A S L P  
 Y S S E L D L I H C V C B F T  
 T R S L W P S A W E E S U W D  
 T A M X V I M O N N G G R U R  
 R U O B V E R Z D T U Y N U A  
 E V K K H D I A E D K M I Y W  
 B W I N W I N Y W P J A N O E  
 M A N P S T H E P T W R G L R  
 U T G F S N E H E I R B T P S  
 N Z O L R A R K E C S A O Z A  
 G V V H O V I G L P F M R P W  
 F K E J V R T Z S N Z X C Z I  
 I B N K B I D S G B Z O H X L

ABRAM	HEIR	SLEEP	BURNING TORCH
INHERIT	SMOKING OVEN	CHILDLESS	LORD
STARS	COVENANT	NUMBER	VISION
DESCENDANTS	REWARD	WORD	HEAVEN



*"Then He brought him outside and said, 'Look now toward heaven, and count the stars if you are able to number them.' And He said to him, 'So shall your descendants be.'"*  
 GENESIS 15:5

## Word Search Puzzle about Abraham

Match the correct answer on the left with the statement on the right. Search for the words on the left in the puzzle grid. Words run up, down, forward, backward and diagonally upward.

### ANSWER

### STATEMENT

- |                |                                                                       |
|----------------|-----------------------------------------------------------------------|
| A. Abraham     | 1. Lot moved here after he left his Uncle. (Gen. 13:12)               |
| B. Egypt       | 2. Abraham healed this King's wife of barrenness. (Gen. 20:17)        |
| C. Sarah       | 3. Hagar was this person's handmaid. (Gen. 16:1)                      |
| D. Lot         | 4. Abraham gave Hagar and Ishmael bread and _____. (Gen. 21:14)       |
| E. Thicket     | 5. He was Abram's father. (Gen. 11:26)                                |
| F. Hagar       | 6. His name was changed from Abram. (Gen. 17:5)                       |
| G. Terah       | 7. This is another name for burnt offering.                           |
| H. Ishmael     | 8. A ram was caught in this. (Gen. 22:13)                             |
| I. Sodom       | 9. He is one of Abram's brothers. (Gen. 11:27)                        |
| J. Angel       | 10. This word means "covenant" or "agreement."                        |
| K. Isaac       | 11. Isaac's name means _____.                                         |
| L. Sacrifice   | 12. During the famine Abram journeyed to this place. (Gen. 12:10)     |
| M. Canaan      | 13. Abram's home town is _____. (Gen. 11:31)                          |
| N. Ur          | 14. He was born to Abraham and Sarah. (Gen. 21:3)                     |
| O. Sarai       | 15. Lot's wife turned into a pillar of _____. (Gen. 19:26)            |
| P. Faith       | 16. Abram needed _____ to follow God's command. (Heb. 11:8)           |
| Q. Promise     | 17. She is the mother of Ishmael. (Gen. 16:15)                        |
| R. Ram         | 18. An _____ called to Hagar out of heaven. (Gen. 21:17)              |
| S. Salt        | 19. Here is where Abraham was to sacrifice his son. (Gen. 22:2)       |
| T. Nahor       | 20. Abram was to leave Ur and go into the land of _____. (Gen. 11:31) |
| U. Abimelech   | 21. She cast out Hagar and Ishmael. (Gen. 21:9,10)                    |
| V. Melchizedek | 22. This person chose to live in Sodom. (Gen. 13:12)                  |
| W. Moriah      | 23. This person is Isaac's half-brother.                              |
| X. Water       | 24. This replaced Isaac as a burnt offering. (Gen. 22:13)             |
| Y. One laughs  | 25. He was the King of Salem who blessed Abraham. (Gen. 14:18, 19)    |

A	G	M	A	H	A	R	B	A	E	G	Y	P	T
N	A	O	R	A	U	C	A	N	A	A	N	C	T
G	T	R	M	G	T	H	I	C	K	E	T	H	S
E	H	I	S	A	L	T	T	O	L	E	T	D	S
L	C	A	O	R	P	E	T	F	E	I	G	H	H
E	E	H	D	V	W	R	M	I	A	J	K	N	G
S	L	W	O	C	X	A	Z	F	M	Q	P	O	U
I	E	A	M	A	R	H	N	A	H	O	R	S	A
M	M	T	Z	A	H	A	R	A	S	L	T	M	L
O	I	E	Q	S	S	A	C	R	I	F	I	C	E
R	B	R	L	I	A	R	A	S	W	X	O	K	N
P	A	M	E	L	C	H	I	Z	A	D	E	K	O

**Year 1**

**Week 11**

## **Hagar**

**Scriptures: Genesis 16**

**Key Verse: Gen. 16:11 “And you shall bear a son and shall call his name Ishmael.”**

### **Key Points:**

1. Abram and Sarah did not understand how God would fulfill His promise
2. Sarah wanted to help Abram become a father. Because she had not conceived, she convinced Abram to take another wife, Hagar
3. Hagar became proud and Sarah became jealous when Hagar became pregnant
4. The two wives mistreated each other and Hagar ran away
5. Hagar obeyed God and returned to Abram and Sarah



## **Year 1**

### **Week 11**

#### **Middle School**

### **Hagar**

#### **Scriptures: Genesis 16**

#### **Key Verse:**

**Gen. 16:11**      And you shall bear a son and shall call his name Ishmael.

#### **Key Points:**

1. When would Abram and Sarai have hired an Egyptian maidservant?
2. Do you think Sarai's decision was tied to the Lord's promise in chapter 15? Why or why not?
3. What did Hagar become when Sarai turned her over to Abram? (see verse 3)
4. What did Hagar think of Sarai once she had conceived Ishmael?
5. Why did Hagar leave the presence of Sarai this time?
6. Who was wrong in this set of circumstances? Sarai? Hagar? Abram?
7. According to the angel's command, how should Hagar return to Sarai? (see verse 9)
8. Would Ishmael be a man of peace?



The Angel of the Lord found Hagar near a  
spring of water and said to her:

“Hagar, Sarai’s maid, where have you come from, and where are  
you going?”



**Genesis 16:8 (NKJV)**

**Fill in the blank**

**And the Angel of the Lord said to her:**

\_\_\_\_\_ **Sarai's maid,** \_\_\_\_\_,

**where** \_\_\_\_\_

**and where are** \_\_\_\_\_?

## ***Hagar and the Angel of the Lord Picture Scene***

- ***Copy Hagar, the angel and the well of spring scene on following page.***
- ***Have children color/cut out.***
- ***Children can glue on scene and images.***

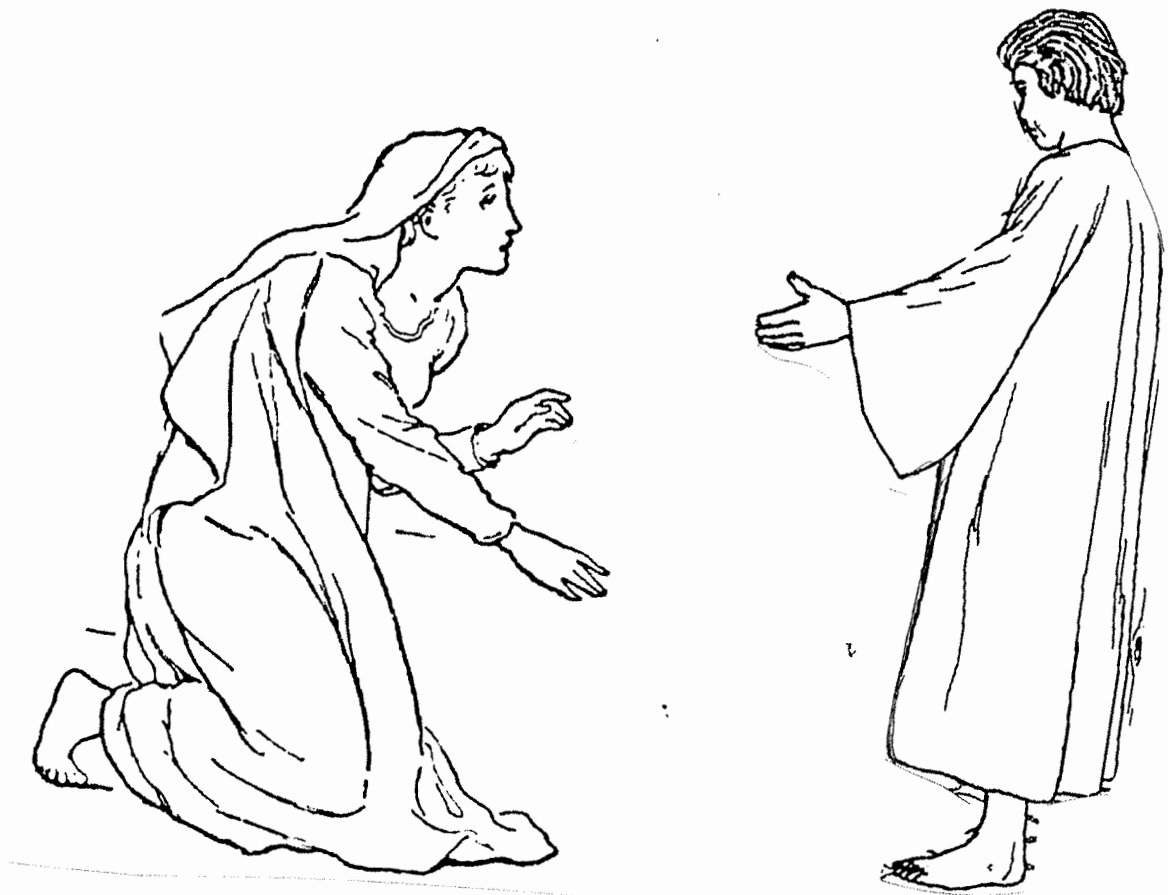



# ABRAHAM SENDS HAGAR AND ISHMAEL AWAY

Genesis 21:14

So \_\_\_\_\_ rose early in the \_\_\_\_\_

And took \_\_\_\_\_ and a skin of \_\_\_\_\_

Putting it on her shoulder, he gave it and the \_\_\_\_\_ to \_\_\_\_\_

\_\_\_\_\_, and sent her away. She then departed and \_\_\_\_\_

wandered in the \_\_\_\_\_ of Beersheba.



"Stickers" for  
fill in the blank  
→

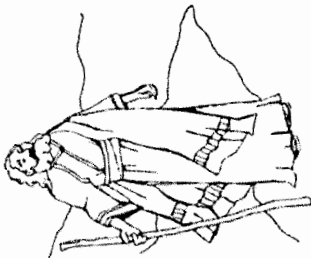
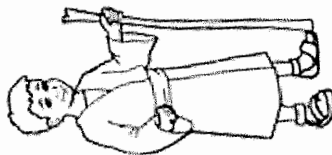
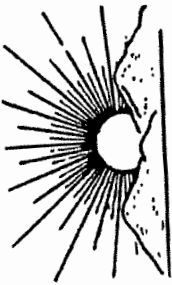
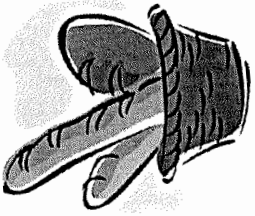
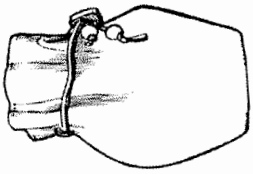

## HAGAR AND SARAI in CONFLICT

1. Why is Hagar running away?
2. Where did Hagar run to?
3. Who came to see Hagar while she was fleeing?
4. Where was Hagar when the Angel found her?
5. What did the Angel of the Lord tell Hagar to do?
6. What promise did the Angel make with Hagar?
7. How old was Abram when Ismael was born?





## Hagar Flees from Sarai

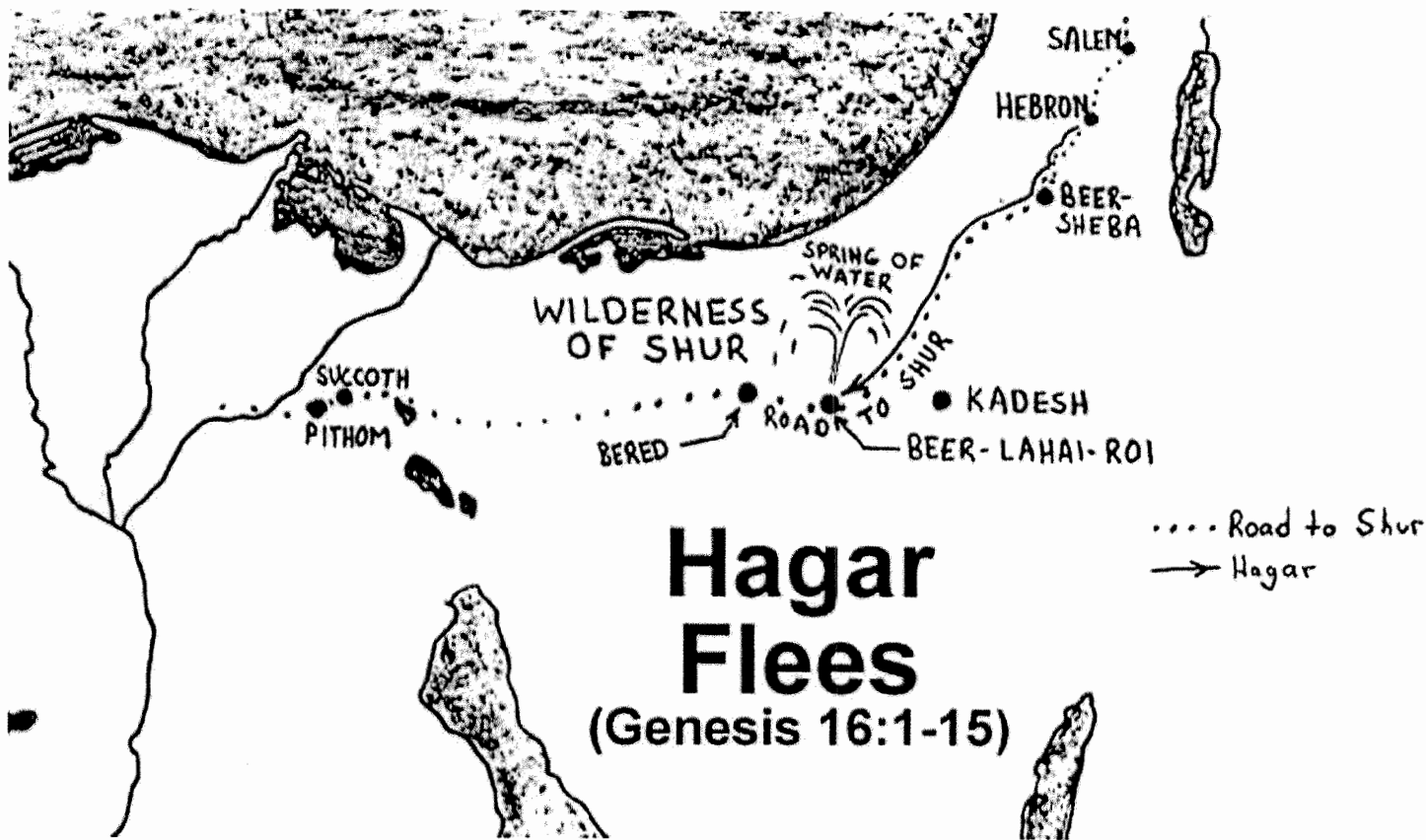

Hagar was from the nation of \_\_\_\_\_.

She fled from \_\_\_\_\_ where Sarai and Abraham lived in a tent.

She fled towards the area of Wilderness of \_\_\_\_\_.

The Angel of the Lord found her near a spring of \_\_\_\_\_.

The Angel named the well of the spring \_\_\_\_\_.

The spring was between \_\_\_\_\_ and \_\_\_\_\_.

# Two Flights of Hagar Ishmael: Gen 16; Gen 21 Hebron

Both flights of Hagar  
ran south and east  
towards Shur and  
Paran, to the  
Beer-lahai-roi spring.

○ **Kadesh Barnea (Petra)**

## Wilderness of Paran

"Ishmael will live east  
of his brothers... in the  
wilderness of Paran"  
Gen 16:12; 21:21  
(Egypt and Sinai are  
west of his brothers)

[www.bible.ca](http://www.bible.ca)

70 km

© 2006 Microsoft Corporation Image courtesy of

NASA

Beer-lahai-roi  
"the spring in the  
wilderness on the  
way to "Shur" Gen 16:7  
"the well was called  
Beer-lahai-roi, it is  
between Kadesh and  
Bered." Gen 16:14

**Wilderness  
of Shur**

way to Shur

Flight #12  
Gen 16:7

Flight #13  
Gen 21:12

Beersheba  
Gerar

Dug Well  
Gen 21

Wilderness  
of Beersheba

## Hagar

ETI SHMAELLRM  
GEASWINLLCGA  
YINEDIAMDNAH  
PCGNRLRLRARHA  
TAERGTSDCDNR  
NALELUSHPTRB  
SEAD OPEI AUBA  
LNTLRRC SMAEM  
NNAII ANATION  
NENWHEIRAGAH  
JGELAPRAPSNL  
PEEA SHPHITIR

Sarah	jealous	Ishmael
angel	handmaiden	spring
wilderness	Abraham	archer
heir	nation	great
mistreat	Egypt	princes
Isaac	Hagar	wild

# Hagar

					1		2		3					
								4						
	5		6											
												7		
			8											
9														
				10					11					

### Across

- 2. son of Sarah
- 4. one who shoots arrows
- 6. \_\_\_\_\_ talked to Hagar in the wilderness.
- 8. a person who shoots well
- 9. Ishmael sons were \_\_\_\_\_.
- 10. took Joseph into Egypt

### Down

- 1. Hagar fled into the \_\_\_\_\_.
- 3. father of Ishmael
- 5. servant of Sarah
- 7. son of Hagar
- 11. homeland of Hagar

WORD BANK: WILDERNESS, EGYPT, ISAAC, ISHMAELITES, ABRAHAM, ISHMAEL, HAGAR, ARCHER, PRINCES, GOD, MARKSMAN

Name \_\_\_\_\_ Date \_\_\_\_\_

Lesson 79 Hagar  
Genesis 16

1. Why did Hagar run away from her mistress?

\_\_\_\_\_

2. What message did God have for Hagar when he spoke to her by the spring of water?

\_\_\_\_\_

\_\_\_\_\_

3. By what name did Hagar call the Lord?

\_\_\_\_\_

4. Whose voice did God hear the second time Hagar left home?

\_\_\_\_\_

5. Write three facts about Ishmael.

\_\_\_\_\_

\_\_\_\_\_

\_\_\_\_\_

6. In what way is Hagar to be admired? \_\_\_\_\_

\_\_\_\_\_

7. What lesson can you learn from the story of Hagar? \_\_\_\_\_

\_\_\_\_\_

\_\_\_\_\_

Read the Bible story at [//gardenofpraise.com/bibl79s.htm](http://gardenofpraise.com/bibl79s.htm)

## HAGAR FLEES

N A N D Y D A J O U S H S I A  
L U L B E I E B E A R A A S S  
O N R Y Y A O U R S R H A H L  
L C E A L M L L H A I S N M A  
M B L O R D E I H S H H M A A  
O R U H S N E L D B S A J E K  
R S O N E A K E H A G U M L L  
Y L R N O H S N G N I P R S D  
A O N D R P D U O R P B P D K  
N G I A I U M Y S T T V F G Q  
G O I S J N T Q E U H G R I U  
E S E O B R W E W F N W Q V B  
L D F X D W A Z R R D O R G U  
W F N T A A I N F E B C H O G  
A Q H A G A R S K O Z X J N X

ABRAHAM  
HAGAR  
JEALOUS  
PROUD  
SARAH  
SRPING

ANGEL  
HANDMAID  
LORD  
RETURN  
SHUR

DESPISED  
ISHMAEL  
OBEYED  
RUN  
SON

# HAGAR RETURNS

Help Hagar return to Abraham and Sarah



FINISH

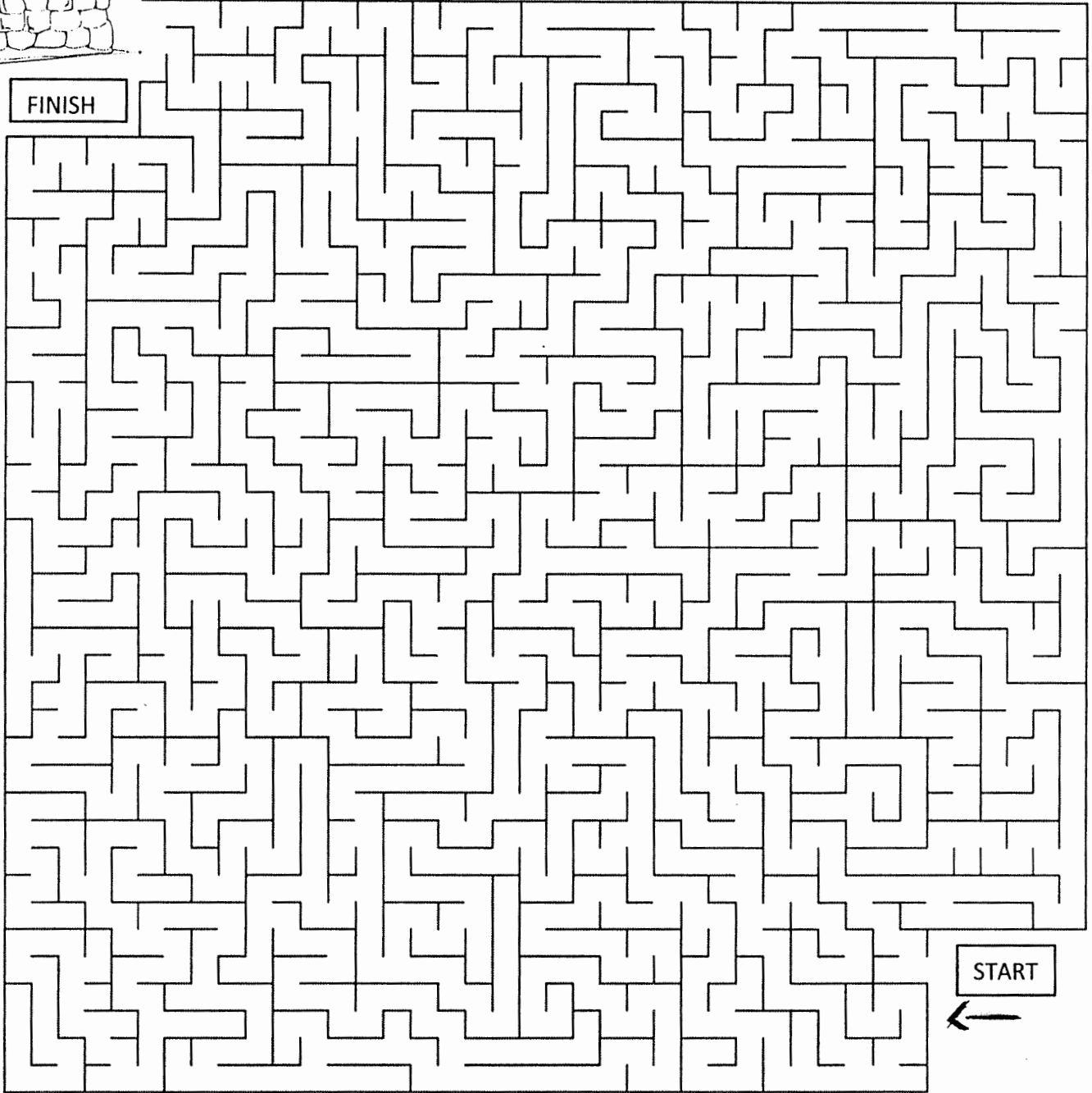

START



# HAGAR AND ISHMAEL

## (GENESIS 16)

### MEMORY VERSE:

"Then she called the name of the LORD who spoke to her, *You-Are-the-God-Who-Sees*; for she said, 'Have I also here seen Him who sees me?' " **GENESIS 16:13**

### FILL IN THE BLANKS:

1. "Now Sarai, Abram's wife, had borne him no children. And she had an Egyptian maidservant whose name was \_\_\_\_\_." **GENESIS 16:1**
2. "Sarai said to Abram, 'My \_\_\_\_\_ be upon you! I gave my maid into your embrace; and when she saw that she conceived, I became \_\_\_\_\_ in her eyes.' " **GENESIS 16:5**
3. "So Abram said to Sarai, 'Indeed your maid is in your hand; do to her as you please.' And when Sarai dealt harshly with her, she \_\_\_\_\_ from her presence." **GENESIS 16:6**

### UNDERLINE THE ALL THE CORRECT ANSWERS:

4. "Now the Angel of the LORD found her..." **GENESIS 16:7**

**BY A SPRING OF WATER IN THE WILDERNESS  
UNDERNEATH A TREE  
BY THE SPRING ON THE WAY TO SHUR**

### TRUE OR FALSE:

5. "The Angel of the LORD said to her, 'Return to your mistress, and submit yourself under her hand.' " **GENESIS 16:9**  
**TRUE OR FALSE**
6. "Then the Angel of the LORD said to her, 'I will multiply your descendants exceedingly, so that they shall not be counted for multitude.' " **GENESIS 16:10**  
**TRUE OR FALSE**

### FILL IN THE BLANKS:

7. "And the Angel of the LORD said to her:..." **GENESIS 16:11-12**
  - \* Behold, you are with \_\_\_\_\_
  - \* And you shall bear a \_\_\_\_\_
  - \* You shall call his name \_\_\_\_\_
  - \* The LORD has heard your \_\_\_\_\_
  - \* He shall be a \_\_\_\_\_ man
  - \* His hand shall be \_\_\_\_\_ every man and every man's hand \_\_\_\_\_ him
  - \* He shall \_\_\_\_\_ in the presence of all his brethren



# HAGAR AND ISHMAEL

## (GENESIS 16)

D N F F J N O E W P L K C H E I T X I P K Z E R P  
 E G H H B R F A U N S P V Q P J V V B S X A A P G  
 S X P A B P V W F U V Z T O T S R Q U C H U Y J C  
 C G J W R I X L I O R Y W E C U F D L D P M N P J  
 E R T X B Q S Z X F C Y H W S E E V P T P E A Q N  
 N Q B P K D V X G L M T I M B U S S M X U F I E H  
 D I I E E J M P Y L L O P E C A J M C D Z P T X L  
 A P A T N A V R E S D I A M H V O C C E V T P Q E  
 N H M S F Q A J P M B J J B U D U Z V S F O Y F D  
 T Z X G J R Z H Y S X F H K E Q G L Z P R N G G B  
 S I T D T D S G B Z A A Q S C E F U K I K I E A Y  
 R V Y E E L O E D F C H O U N N K T F S K J U M K  
 E V L P J I N U R P W A A H Q R D M K E Y J H M K  
 U B I Z Z W S W C G J H W P L Y B O S D R Y A A J  
 W Q S E E S O H W D O G E H T E R A U O Y T E O M  
 J Y O C Z I H D G K U Z V E K Y K E M G G H C K V  
 N E V C K L M W D E L F M V D D K M O N I G N C W  
 S L Q Q M A R B A B K Y F A D J A X A I K F A Y Z  
 Z N Z I C S X Y R U O N S R O R T I T R U Y I U W  
 K V U W T T S P G K I J W L K A W A M P A Q Z D E  
 A N G E L O F T H E L O R D Q G L R Z S V D S Y L  
 B Q A Z I F V Z N C T T U W K A A A J X X C N G L  
 Z T N K O A O W G U E P D J L H P S S G O M C T F  
 F A M K T Y J B Z M J L S U W I P N M E U P Z I I  
 H Q G Q A Y J M J D K J J O K P A O X I V O X I Z

- |                                                                  |                                                                |                                                                    |                                                                                                  |
|------------------------------------------------------------------|----------------------------------------------------------------|--------------------------------------------------------------------|--------------------------------------------------------------------------------------------------|
| <b>ABRAM</b><br><b>ISHMAEL</b><br><b>WELL</b><br><b>EGYPTIAN</b> | <b>HAGAR</b><br><b>SUBMIT</b><br><b>DESPISED</b><br><b>SON</b> | <b>SPRING</b><br><b>DESCENDANTS</b><br><b>SARAI</b><br><b>FLED</b> | <b>ANGEL OF THE LORD</b><br><b>MAIDSERVANT</b><br><b>WILD</b><br><b>YOU ARE THE GOD WHO SEES</b> |
|------------------------------------------------------------------|----------------------------------------------------------------|--------------------------------------------------------------------|--------------------------------------------------------------------------------------------------|

WRITE DOWN THE LETTERS AS YOU COME TO THEM ON THE LINES BELOW

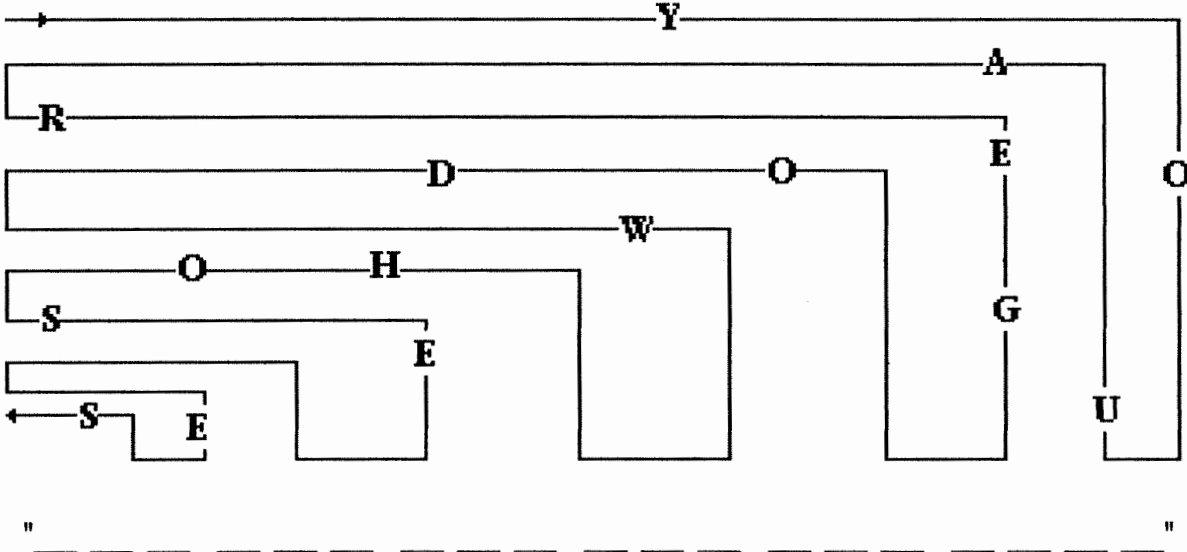

**Year 1**

**Week 12**

## **Abraham's Visitors**

**Scriptures: Genesis 17 & 18**

**Key Verse: Gen 17:19 Then God said, "Yes, but your wife Sarah will bear you a son, and you will call him Isaac."**

### **Key Points:**

1. Although 15 years had passed, God had not forgotten His promise that Abram and Sarah would have a son.
2. Both Abram and Sarah had laughed about the promise and doubted they would have a son.
3. God changed Abram and Sarah's names.
4. Abram was kind and generous to strangers.
5. God knew that Sarah laughed even though she did it in private.
6. God listened to Abraham's petition and showed mercy to Lot.

**Year 1**

**Week 12**

**Middle School**

### **Abraham's Visitors**

**Scriptures: Genesis 17 and 18; Rom. 2:28-29; Col. 2:11-12; Mt. 11:23-24**

**Key Verse:**

**Gen. 17:19**      Then God said, “Yes but your wife Sarah will bear you a son, and you will call him Isaac.”

**Key Points:**

#### **Chapter 17**

1. How old was Ishmael when God appears to Abram this time?
2. Why does God change his name from “Abram” to “Abraham”?
3. According to Paul in Romans 4, who are Abraham's descendants?
4. What was the penalty for not circumcising a child?
5. According to Romans 2:28-29 and Colossians 2:11-12, what circumcision do you and I go through?
6. Why did God not accept Ishmael as Abraham suggested?
7. Who would the covenant go through?

#### **Chapter 18**

8. According to 19:1, two of the men in this passage were what? Who was the other man?
9. In the ancient world, why did people wash the feet of their guests?
10. Were there enough righteous men to spare the cities of Sodom and Gomorrah?
11. Read Jesus' statement in Matthew 11:23-24. Why would the city of Sodom find the judgment day more tolerable than those who rejected Jesus?

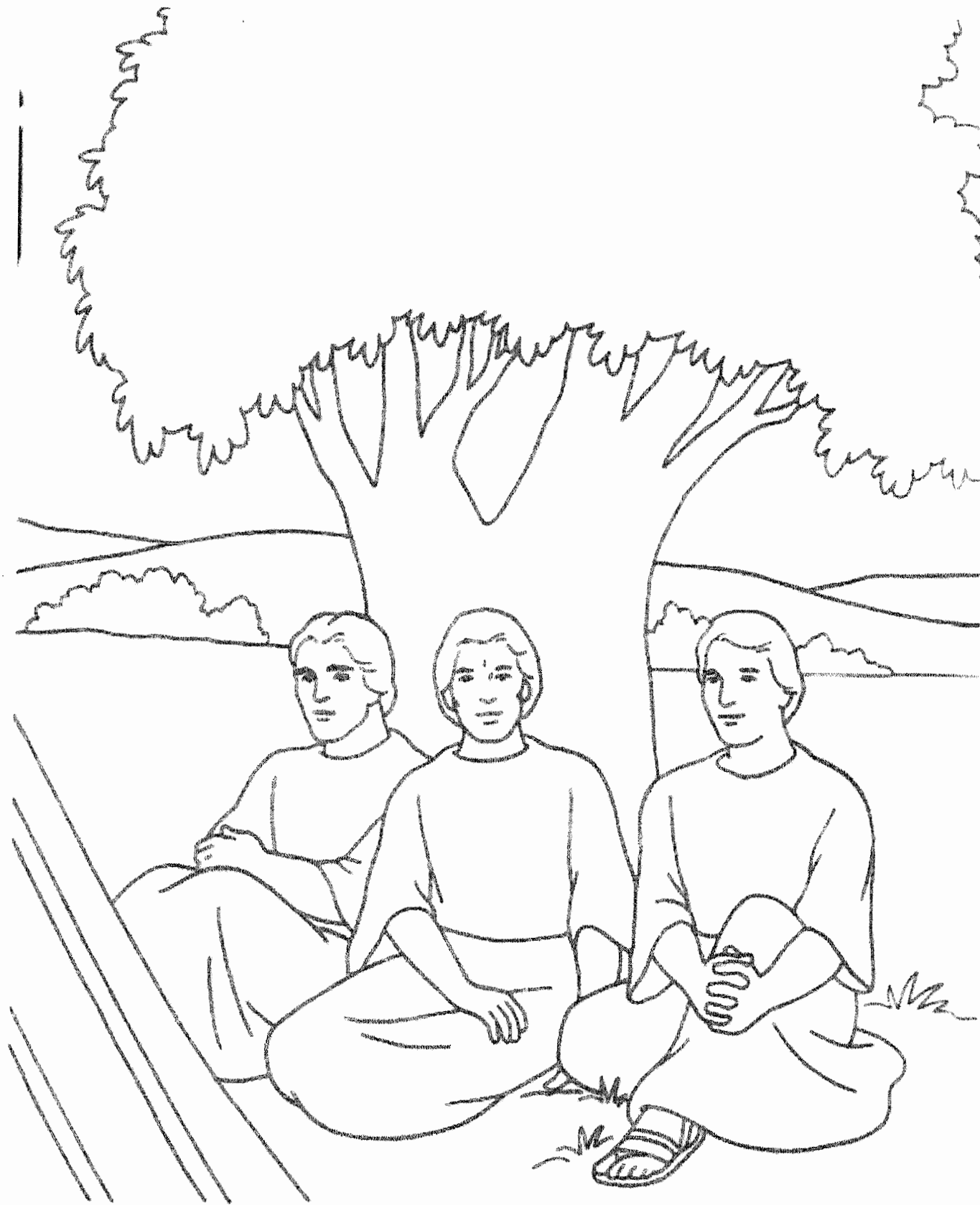

# Three Visitors



**The Lord visited Abraham and Sarah**

He took butter and milk, took the veal and set everything to his guests. - Genesis 18: 8

Look for more coloring on [www.gkvapeldoornzuid.nl](http://www.gkvapeldoornzuid.nl)

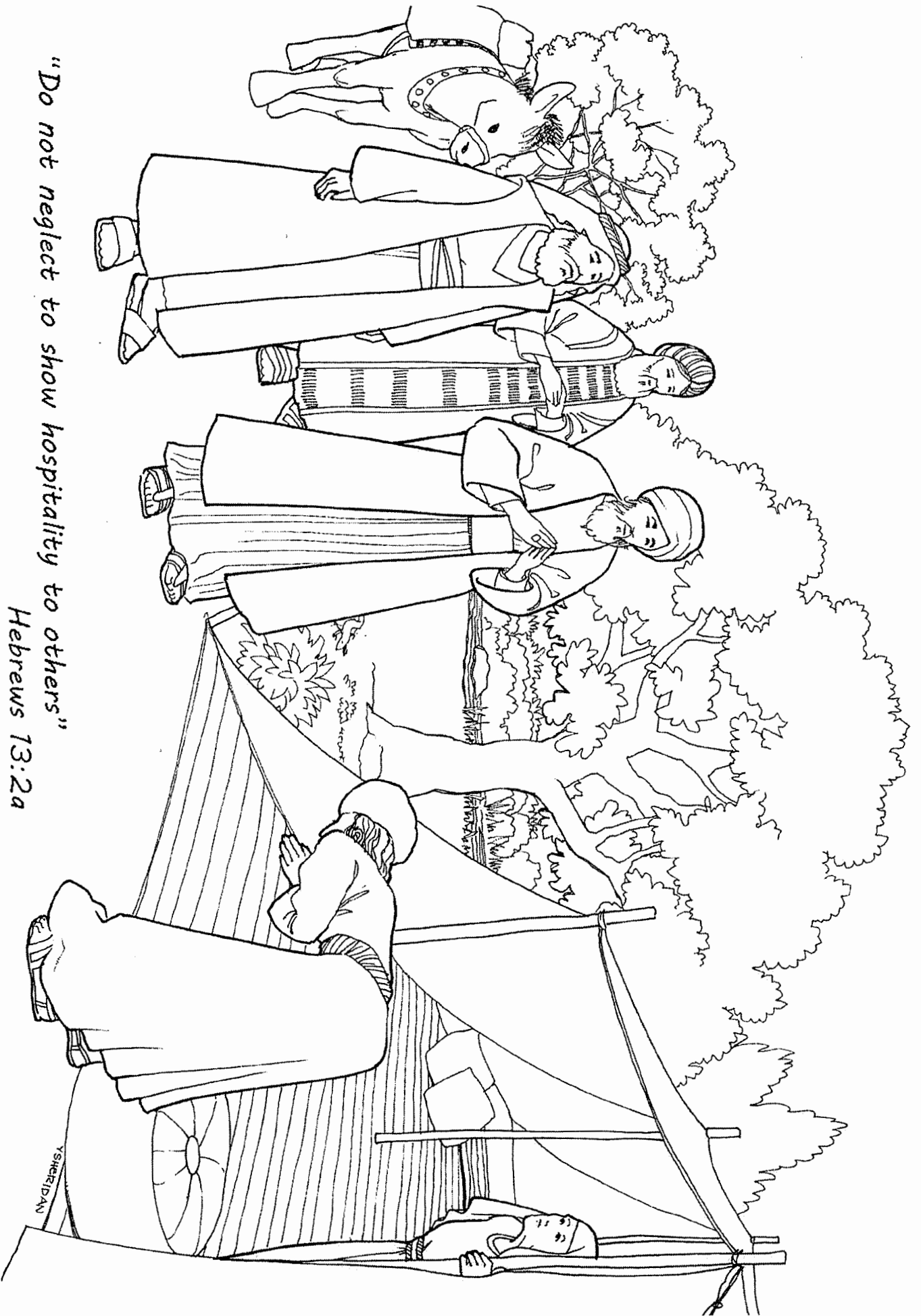

*"Do not neglect to show hospitality to others"*

*Hebrews 13:2a*



Abraham, Sara, and the visitors Craft

Cut tent from cardstock.

Copy Abraham, Sarah and the terabinth tree.

Have children color and cut out.

Cut slit in the tent, fold back.

Glue Abraham and Sarah inside, tree on the outside.

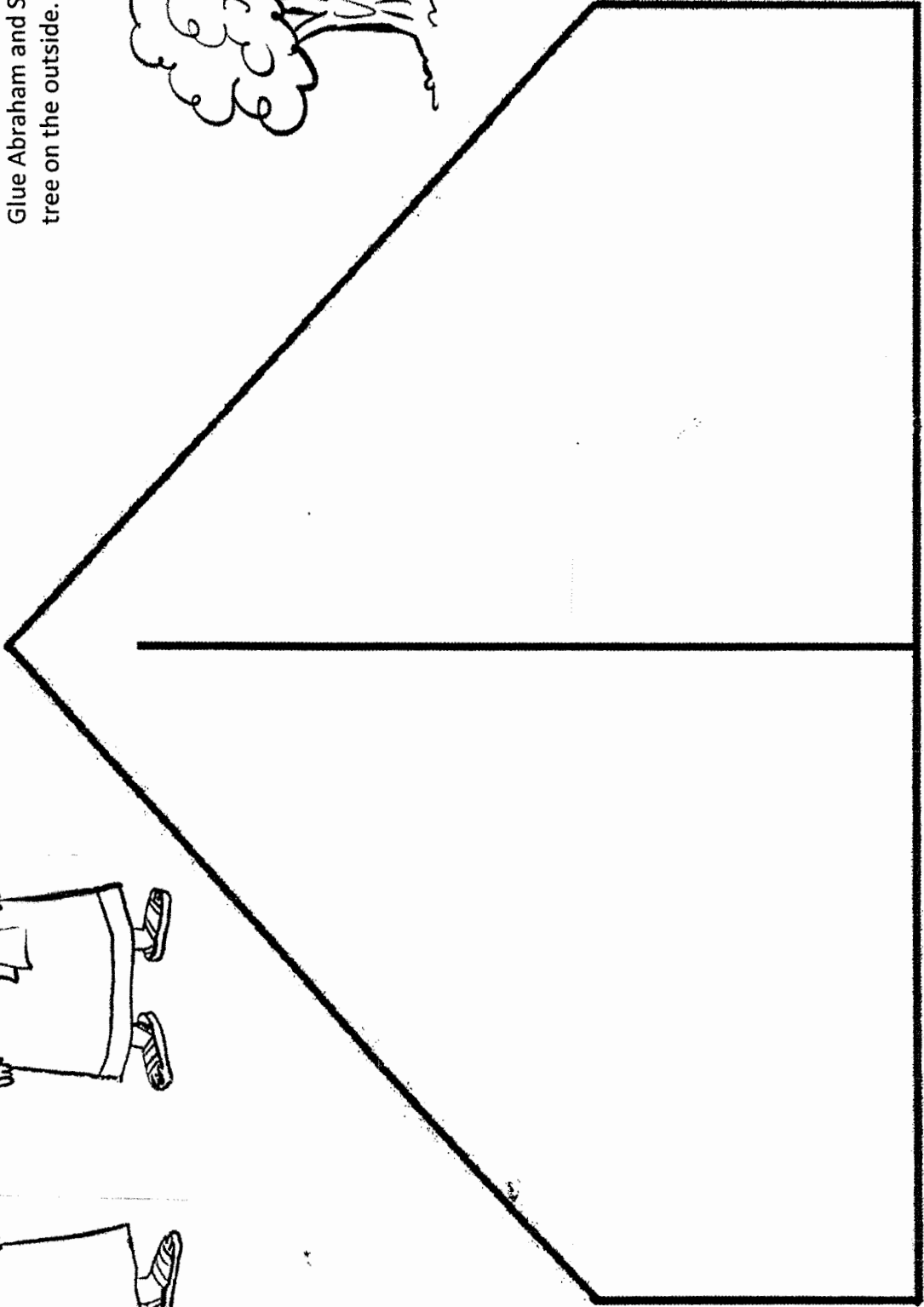
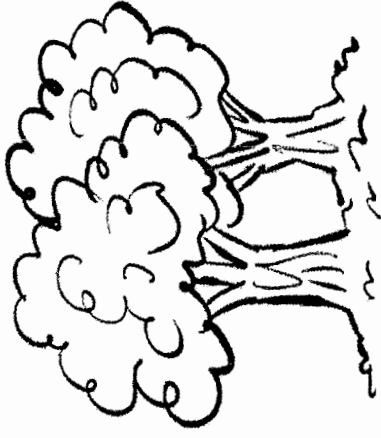
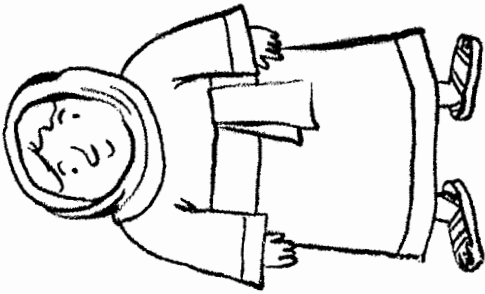
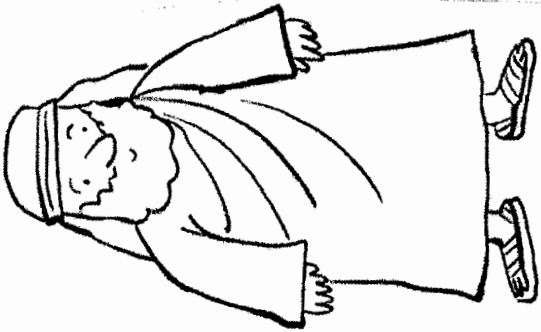



# Abraham and Sarah Maze

Help the angel find Abraham and Sarah to tell them that they will have a baby!

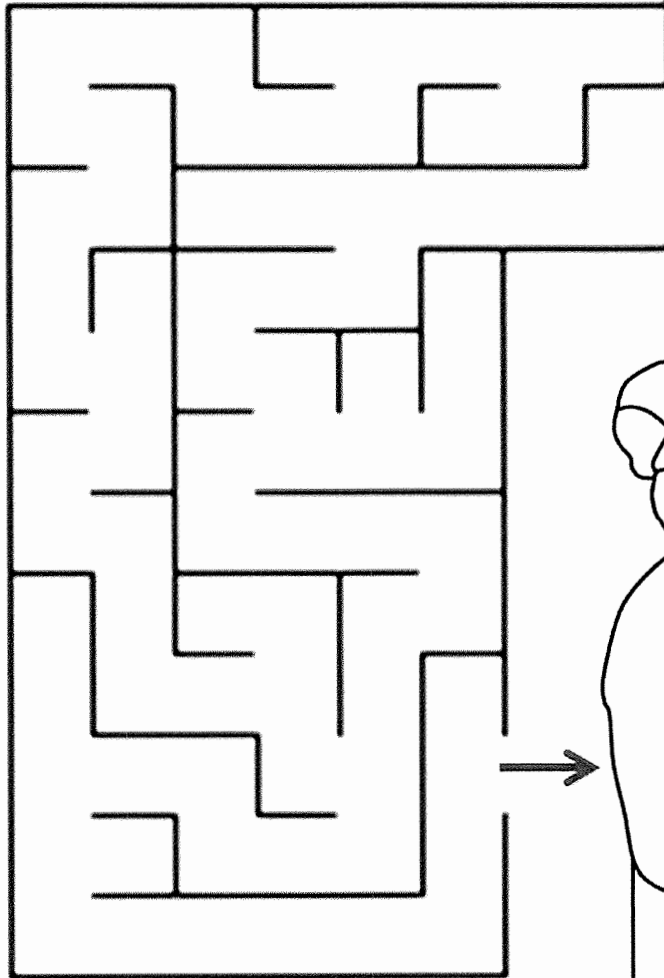
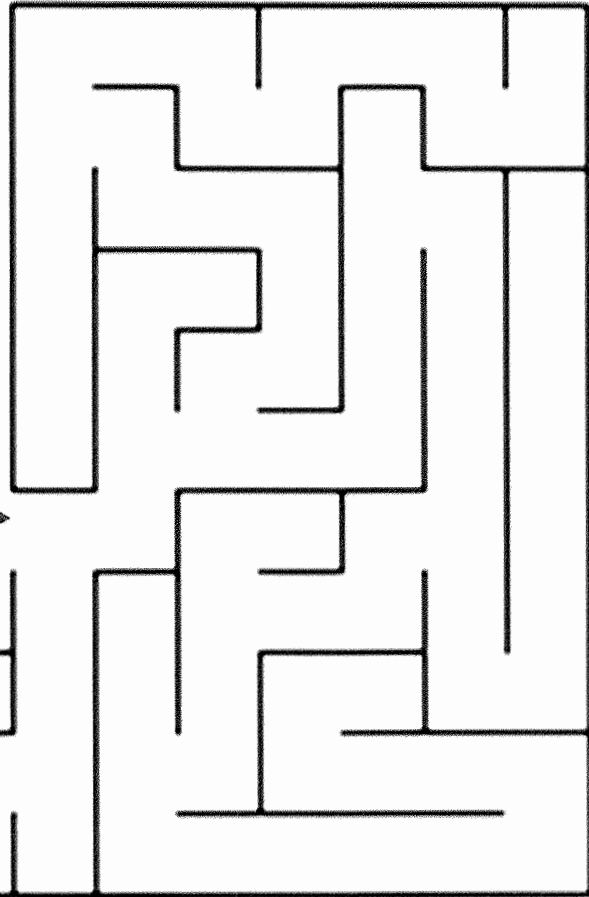

# ▶ ABRAHAM

## FATHER OF MANY NATIONS

### MEMORY VERSE

Genesis 17:1-10

*Thou shalt be a father of many nations. ~ Genesis 17:4*

**INTRODUCTION** Abraham's name used to be "Abram." One day, God changed it! God told Abram that his new name would be "Abraham" because that meant "father of many nations." This was a very special honor God gave to Abraham. The Israelite nation was formed through this one man and his family.

**FATHER ABRAHAM** Color the picture of Abraham. Your teacher will give you a staff for Abraham. You can give this picture as a present to your father or mother. Remember that God is your heavenly Father. He watches you grow, protects you and gives you the things you need.



### Abraham, the father of many nations

**FOR THE TEACHER** Duplicate a picture for each child. Cut two slits in each paper. Help the children slide large candy canes or bent chenille wires through the slits to make staffs. Tape the backs to hold the staffs in place. Discuss positive attributes of parents as the children work.

Unscramble the letters to find the words in our

# Abraham & Sarah Anagram

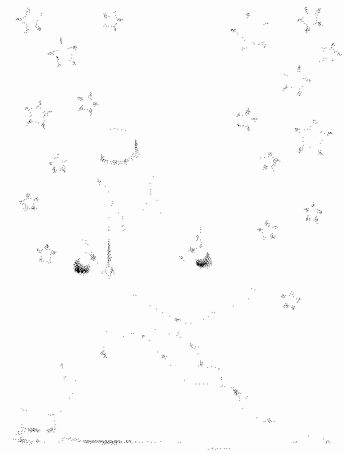

arsst \_\_\_\_\_

cdehilnr \_\_\_\_\_

aacis \_\_\_\_\_

agghilnu \_\_\_\_\_

iorsstv \_\_\_\_\_

aceilmr \_\_\_\_\_

aaabhmr \_\_\_\_\_

aahrs \_\_\_\_\_

aeprry \_\_\_\_\_

afilmy \_\_\_\_\_

Unscramble the letters to find the words in our

# Abraham & Sarah Anagram



arsst      stars

cdehilnr      children

aacis      Isaac

agghilnu      laughing

iorsstv      visitors

aceilmr      miracle

aaabhmr      Abraham

aahrs      Sarah

aeprry      prayer

afilmy      family

# Who's Who?

Read Genesis 18:1-14. Use the clues below to fill in the answer boxes on the right. If some of the letters appear in the next answer, the arrows will show you where to place them.

1. Man near the great trees of Mamre (v. 1).

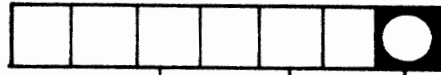

2. The visitors (v. 2).



3. The visitors asked about whom (v. 9)?

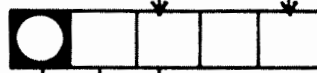

4. The one who prepared the meal (v. 7).



5. The visitor who spoke (v. 10).



6. "Will I really have a \_\_\_\_\_ now that I am old" (v. 13)?



Unscramble the circled letters to solve the puzzle below.

The three visitors came to give Abraham and Sarah a

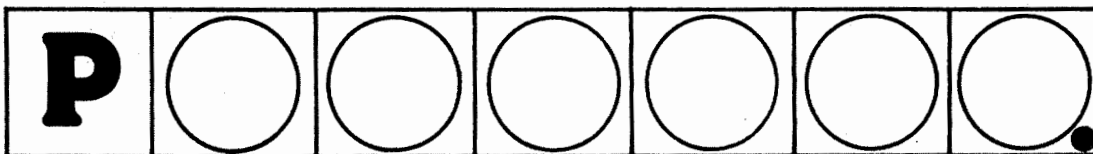

## Sarah

HLREGNESSEM  
AHDTDTOERGA  
GBATENTA EYS  
ABRAHAMITPT  
RRGAGNLRSTE  
CGR AUENISR  
AATNAVRESOB  
SRKMLOBEYED  
GRHII CAASH  
OSSHNSAAMEE  
IDIRGGIYNGT

Abraham	Hagar	Egypt
lie	silver	messenger
son	obeyed	Ishmael
laughed	Isaac	servant
sister	king	master
covenant	Sarah	tent

Name \_\_\_\_\_ Date \_\_\_\_\_

Lesson 78 Sarah  
Genesis 21

1. What were the names of Sarah and her husband before God changed their names?

\_\_\_\_\_

2. What lie did Abraham want Sarah to tell the Egyptians?

\_\_\_\_\_

3. Why did he want her to lie? \_\_\_\_\_

\_\_\_\_\_

4. To which king did they tell the lie? \_\_\_\_\_

5. What was the message of the three men who came to Abraham?

\_\_\_\_\_

6. Why did Sarah laugh when she heard the message?

\_\_\_\_\_

7. Who were the two sons of Abraham? \_\_\_\_\_

8. What do we learn about Sarah in the New Testament in the book of 1 Peter?

\_\_\_\_\_

\_\_\_\_\_

9. What lessons do you learn from the story of Sarah?

\_\_\_\_\_

\_\_\_\_\_

\_\_\_\_\_

Read the Bible story at [//gardenofpraise.com/bibl78s.htm](http://gardenofpraise.com/bibl78s.htm)

## The Three Visitors

Genesis 18 NIV

Abraham was visited by 3 strangers and he treated them to the best he had.

While he was entertaining them he realized that they were angels.

They brought him some IMPORTANT NEWS.

They told him that by this time next year Sarah would have a son. When Sarah heard this she \_\_\_\_\_ (Gen.18:12) to herself because she thought she was too old to have a baby.

Now the LORD knew her thoughts and said "Is \_\_\_\_\_ too \_\_\_\_\_ for the LORD?" (Gen. 18:14)

They also told him that the cities of Sodom and Gomorrah were so sinful that they needed to be destroyed. Abraham was concerned about Lot, who lived there, and asked the LORD:

"Will you sweep away the \_\_\_\_\_ with the \_\_\_\_\_?" (Gen 18:23).

The LORD agreed that if he found 10 righteous people there he would not destroy it.



Uncramble the Letters below to fill in the answers above:

GULDAHE ▯ TAYNGIHN ▯ RADH ▯ TROESGHUI KWIDCE

copyright 1997 Sharon Whittaker  
<http://sewhttkr.home.comcast.net>



## *The Visit*

Genesis 18:1-15

Page 1

Fill in the blanks. (Note, use NRSV text)

1. The Lord appeared to Abraham by the o\_\_\_\_\_ of M\_\_\_\_\_, as he sat at the entrance of his t\_\_\_\_\_ in the heat of the day. 2. He looked up and saw \_\_\_\_\_ men standing near him. When he saw them, he ran from the tent entrance to meet them, and bowed down to the ground. 3. He said, "My lord, if I find favor with you, do not pass by your servant. 4. Let a little w\_\_\_\_\_ be brought, and w\_\_\_\_\_ your f\_\_\_\_\_, and r\_\_\_\_\_ yourselves under the tree. 5. Let me bring a little b\_\_\_\_\_, that you may refresh yourselves, and after that you may pass on—since you have come to your servant." So they said, "Do as you have said."

6. And Abraham hastened into the tent to Sarah, and said, "Make ready quickly three m\_\_\_\_\_ of choice f\_\_\_\_\_, knead it, and make c\_\_\_\_\_."

7. Abraham ran to the herd, and took a calf, tender and good, and gave it to the servant, who hastened to prepare it. 8. Then he took c\_\_\_\_\_ and m\_\_\_\_\_ and the calf that he had prepared, and set it before them; and he stood by them under the tree while they ate.

9. They said to him, "Where is your wife Sarah?" And he said, "There, in the tent." 10. Then one said, "I will surely return to you in due season, and your wife Sarah shall have a s\_\_\_\_\_." And Sarah was l\_\_\_\_\_ at the t\_\_\_\_\_ e\_\_\_\_\_ behind him. 11. Now Abraham and Sarah were o\_\_\_\_\_, advanced in age; it had ceased to be with Sarah after the manner of women. 12. So Sarah l\_\_\_\_\_ to herself, saying, "After I have grown old, and my husband is old, shall I have p\_\_\_\_\_?" 13. The Lord said to A\_\_\_\_\_, "Why did Sarah laugh, and say, "Shall I in- deed bear a child, now that I am old?" 14. Is anything too w\_\_\_\_\_ for the Lord? At the set time I will return to you, in due season, and S\_\_\_\_\_ shall have a son." 15. But Sarah denied, saying, "I did not laugh"; for she was a\_\_\_\_\_. He said, "Oh yes, you did laugh."

**Year 1**

**Week 13**

## **Sodom and Gomorrah**

**Scriptures: Genesis 19**

**Key Verse: Gen. 19:29** When God destroyed the cities of the plain, He remembered Abraham, and brought Lot out of the catastrophe that overthrew the cities.

### **Key Points:**

1. God sent angels to verify the wickedness of the cities.
2. Lot took the men (angels) into his home to protect them.
3. God saved Lot and his family. They were given instructions to not look back. Lot's wife disobeyed and became a pillar of salt.
4. God's power is shown in love toward the righteous and in destruction toward the wicked.

## **Year 1**

### **Week 13**

#### **Middle School**

### **Sodom and Gomorrah**

**Scriptures: Genesis 19, II Pet. 2:6-9, Luke 17:28-32**

#### **Key Verse:**

**Gen. 19:29**      When God destroyed the cities of the plain, He remembered Abraham, and brought Lot out of the catastrophe that overthrew the cities.

#### **Key Points:**

#### **Gen. 19**

1. Why was Lot living in such a wicked city? What does this tell us about our choices?
2. Do you think Lot knew what would take place if these men chose to stay elsewhere?
3. According to verse 9, was this the first time Lot had warned these people about their wicked activities?
4. Besides the destruction of the city, why else were these angels sent to Sodom? Compare II Peter 2:6-9. What does this story teach us?
5. In Lot's family, who was left behind? Why?
6. Why did God remember Abraham in His destruction of Sodom and Gomorrah?

#### **Luke 17:28-32**

1. How will people act before the destruction of the world? According to this, will there be anything unusual taking place?
2. To avoid this punishment, what do you and I need to do?
3. What is the lesson Lot's wife teaches us?
4. What does Jesus mean by, "whoever seeks to save his life will lose it"?
5. On the flip side, what does He mean by "whoever loses his life will preserve it"?
6. How do you and I "lose our lives"?

# SODOM & GOMORRAH

(GENESIS 19:1-30)



"And it came to pass, when they had brought them forth abroad, that he said, Escape for thy life; look not behind thee, neither stay thou in all the plain; escape to the mountain, lest thou be consumed."

**GENESIS 19:17**

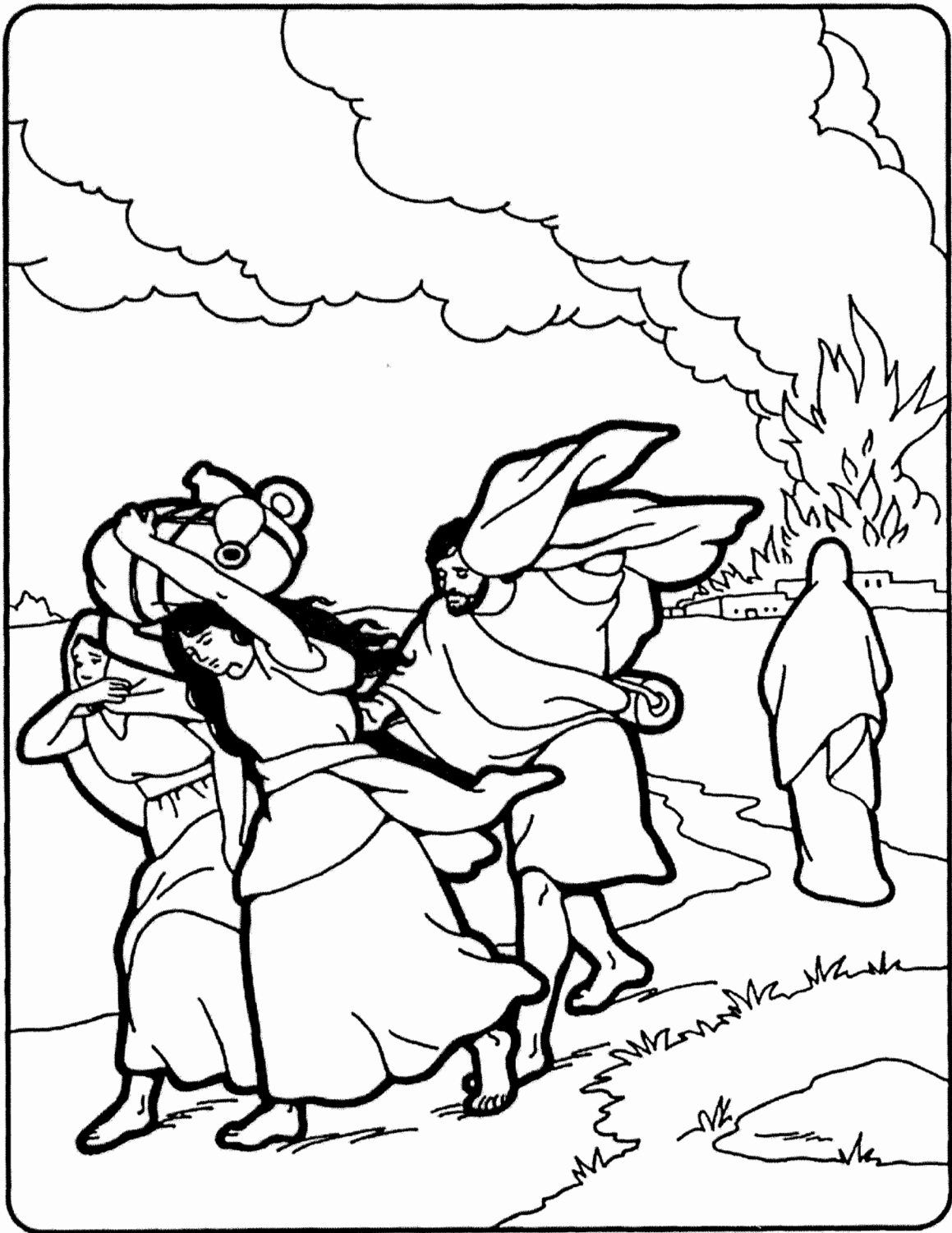

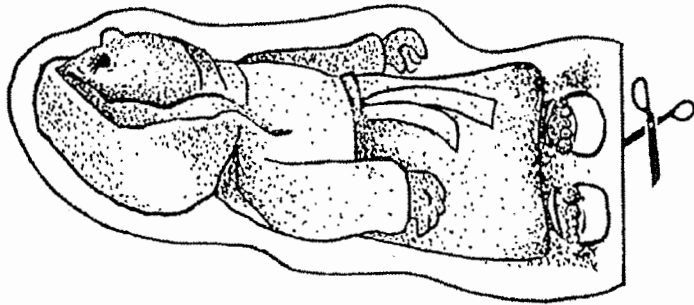

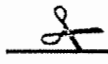
 cortar

**Draw what you think it looked like when Sodom was being destroyed.**

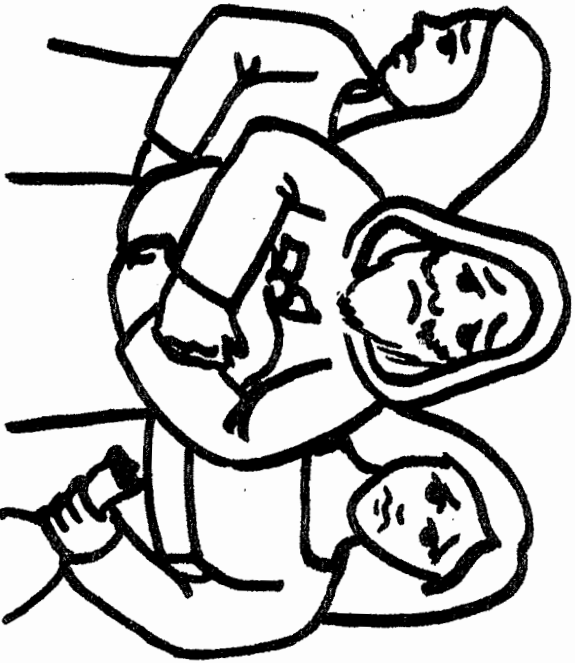





Lot and his two daughters escaping from the  
cities of Sodom and Gomorrah.  
Genesis 18:16 - 19:30

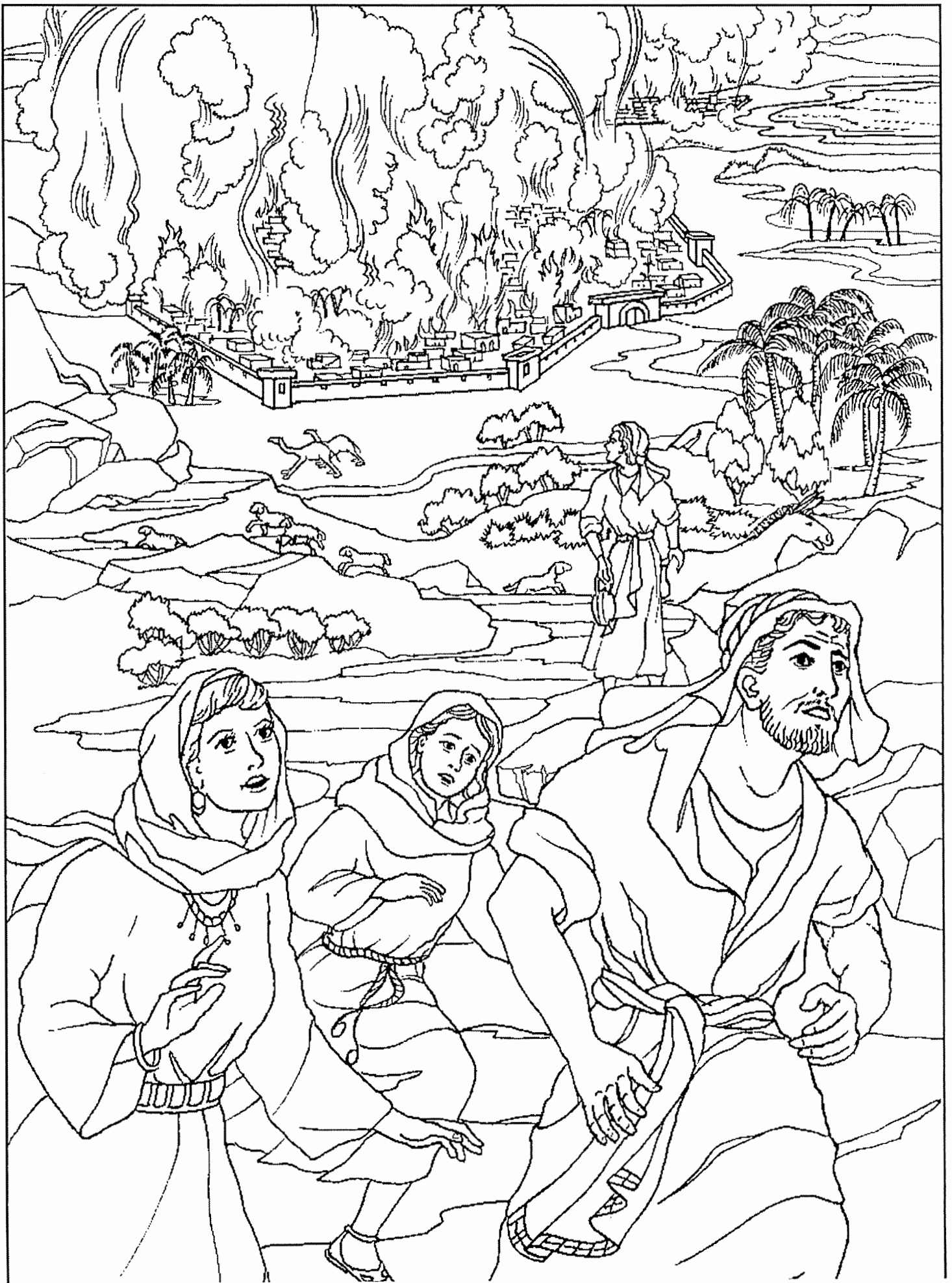



**L**ot took his wife and fled. But his wife looked back  
and was turned into a pillar of salt.

# Lot's Wife

Genesis 19:26- But his wife looked back from behind him, and she became a pillar of salt.



## Lot Crossword Puzzle

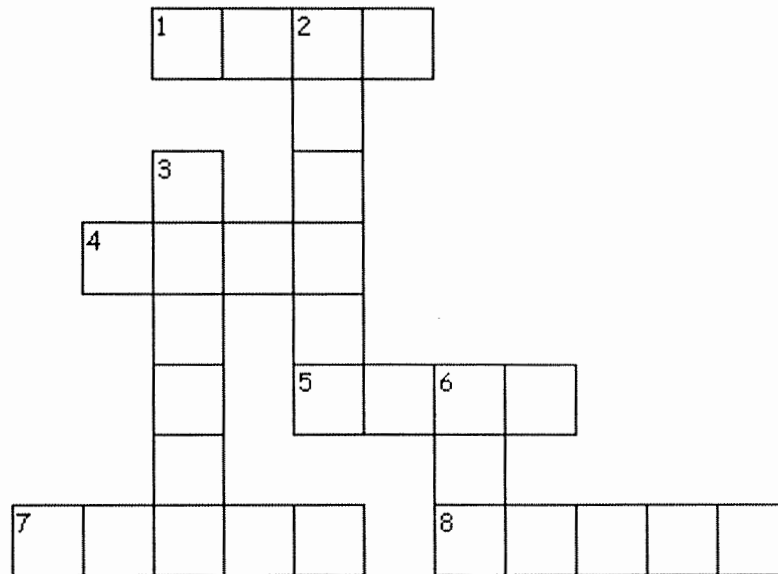

### Across

1. Little town nephew and daughters escaped to.
4. Cities were destroyed by this.
5. Wife turned into this.
7. Where Abraham's nephew lived.
8. Number of people who escaped safely.

### Down

2. Led Abraham's nephew and family out of the city.
3. Cities were destroyed because they were \_\_\_\_
6. Abraham's nephew

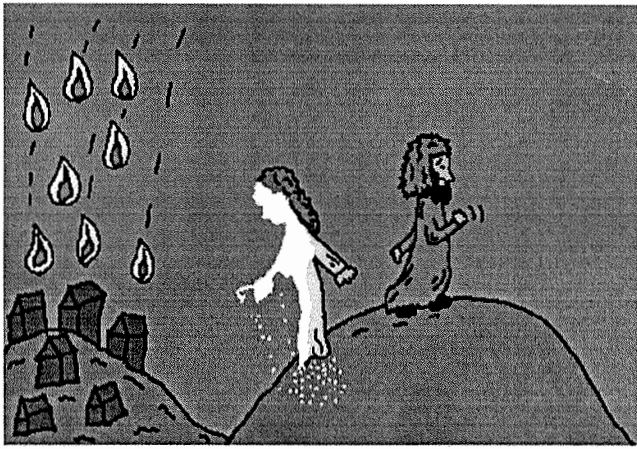

# Lot's Wife Turned Into A Pillar Of Salt Maze

Genesis 19:26 But his wife looked back from behind him, and she became a pillar of salt.

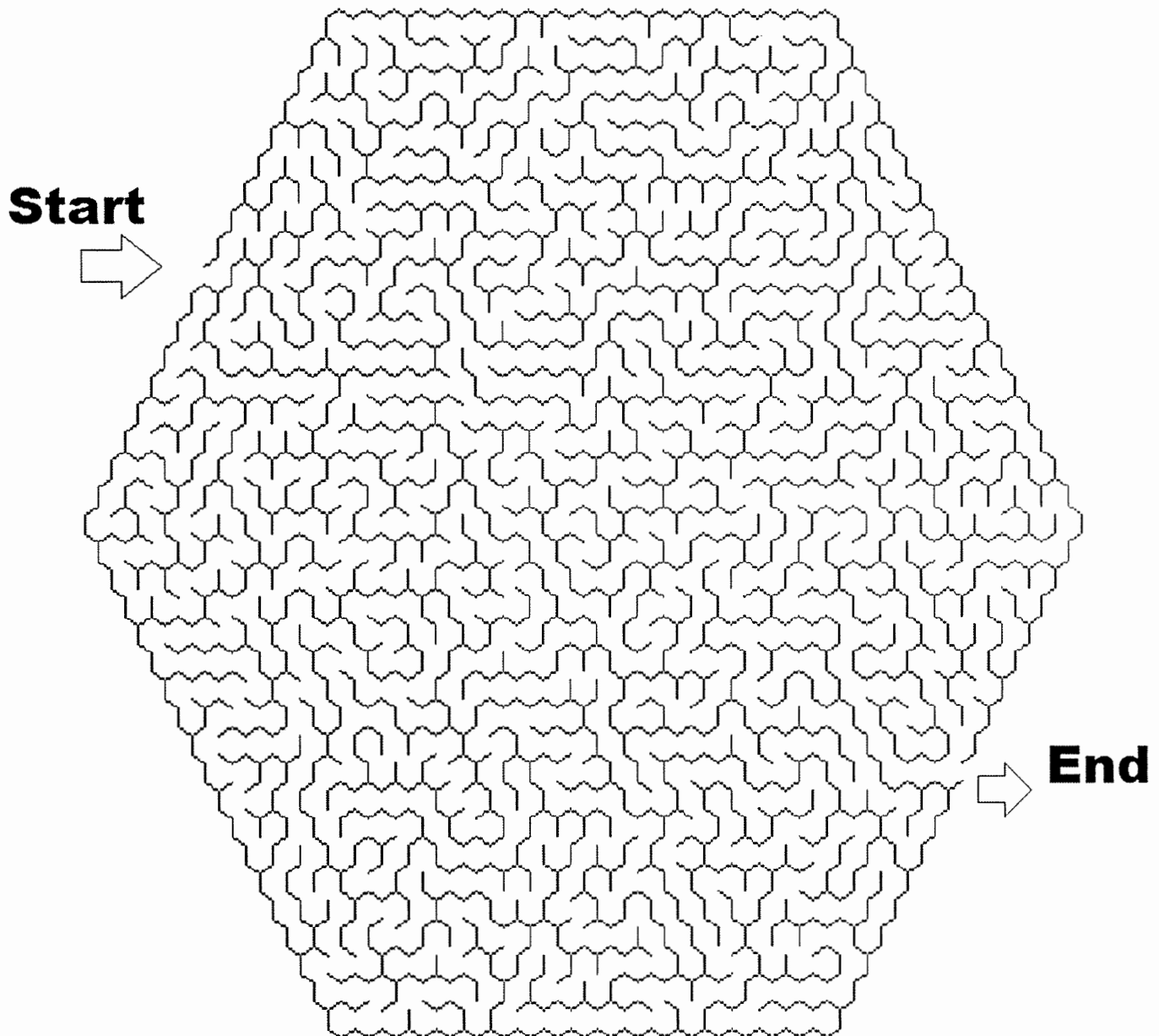



# Bible Pathway Adventures

WORD SEARCH

## SODOM & GOMORRAH

O C Y G A X H L L T M Z Y H F B U M H D  
U G I H T N P K Z H X L X N N R N I I F  
Q J O T M J G F H O H Q L Z X I L K W A  
K Z S M Y T R E I U A Z T K P M E R B T  
P T C M O G G Q L R O R D O N S A U N O  
A E Y I R R A B V S E J E I P T V V C J  
Y L J W T Q R T I P Y C Q E C O E T D D  
R Y X L V I S A E L I F M Z S N N Q G O  
D K G O N B E C H Z J C K H M E E C X U  
Q J L K B K U S N S S V T Y O J D K X Q  
K K D J P I L L A R J N O G K B B J L V  
E M H Y W F T A M I E V R M E D R D Z G  
N Q D A U G H T E R S Z P H E G E M N E  
Y A S M U V J K I D S C Y R V E A H I N  
Q A J W I E M Y B U F A H D C P D D T E  
Y S H D Y V W V S A I F L C T K N C I S  
N B Z W F N Q U T N F R S T D Y I A L I  
I G B L E E E R A B R A H A M I R V W S  
L U W W Y H L O T S W E O W Z M T E W T  
L P T Z R X S O D O M C F U Q D T U E H

CITY GATE  
SODOM  
ABRAHAM  
GENESIS  
ANGELS  
UNLEAVENED BREAD

FIRE  
BRIMSTONE  
GOMORRAH  
DAUGHTERS  
SMOKE  
PILLAR

YAHWEH  
LOT  
CAVE  
ZOAR  
CITIES  
SALT

# The Destruction of Sodom and Gomorrah

Genesis 19 NIV

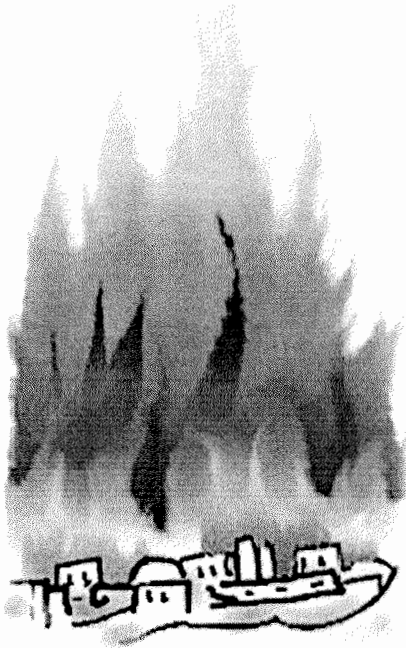

When the two angels arrived at Sodom Lot invited them to spend the night at his home. The Angels saw a lot of wickedness in Sodom and found that there were not even 10 righteous people living there. Read Genesis 19:12-29 (NIV) to see what happened and fill in the crossword puzzle below.

## Across:

1. The Angels told Lot to flee with his \_\_\_\_\_ and daughters. (vs 15)
3. The LORD rained down burning \_\_\_\_\_ on Sodom and Gomorrah. (vs 24)
4. Lot's wife looked back and she became a pillar of \_\_\_\_\_. (vs 26)
5. Lot and his daughters fled to a city called \_\_\_\_\_. (vs 22)
6. \_\_\_\_\_ asked the angels to spend the night at his home. (vs 1,2).

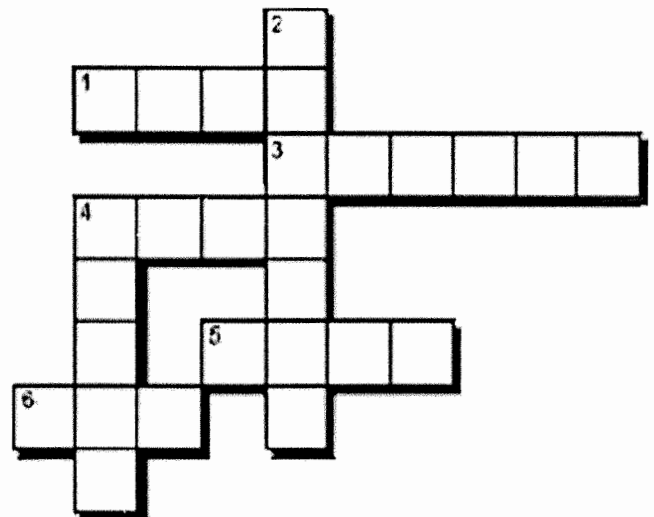

## Down:

2. The angels told Lot that they were going to \_\_\_\_\_ Sodom. (vs 14)
4. The two angels went to the city of \_\_\_\_\_. (vs 1)



# A Lot to Learn

Fill in the missing words in each sentence below from Genesis 19. Place an X through the letters that spell the missing words in each line of the box below.

Then write the remaining letters from left to right, line by line, in the blanks at the bottom.

These letters will spell out an important lesson from Genesis 19.

1.	S	S	O	I	D	N	O	M
2.	B	R	L	I	N	O	T	G
3.	D	E	S	S	T	R	O	Y
4.	P	W	I	U	F	N	E	I
5.	S	U	S	L	F	U	H	R
6.	M	P	I	L	E	L	A	R
7.	R	I	N	S	T	I	N	G

- The two angels arrived at \_\_\_\_\_ (v. 1).
- The angels spoke to \_\_\_\_\_ (v. 12).
- They told him the Lord was about to \_\_\_\_\_ the city (v. 14).
- They told him to flee with his \_\_\_\_\_ and daughters to the mountains (v. 16, 17).
- Then the Lord rained down burning \_\_\_\_\_ on Sodom and Gomorrah (v. 24).
- But Lot's wife looked back and became a \_\_\_\_\_ of salt (v. 26).
- The next morning Abraham looked toward Sodom and Gomorrah and saw dense smoke \_\_\_\_\_ from the land (v. 28).

# St

Abrah:  
Write 1  
Abrah:

"C N

S G

C N

J M

A D

V H

X N

# A Lot to Learn

Fill in the missing words in each sentence below from Genesis 19. Place an "x" through the letters that spell the missing words in each line of the box below.

Then write the remaining letters from left to right, line by line, in the blanks at the bottom. These letters will spell out an important lesson from Genesis 19.

1. The two angels arrived at \_\_\_\_\_ (v. 1).
2. The angels spoke to \_\_\_\_\_ (v. 12).
3. They told him the Lord was about to \_\_\_\_\_ the city (v. 14).
4. They told him to flee with his \_\_\_\_\_ and daughters to the mountains (v. 16, 17).
5. Then the Lord rained down burning \_\_\_\_\_ on Sodom and Gomorrah (v. 24).
6. But Lot's wife looked back and became a \_\_\_\_\_ of salt (v. 26).
7. The next morning Abraham looked toward Sodom and Gomorrah and saw dense smoke \_\_\_\_\_ from the land (v. 28).



1.	S	S	O	I	D	N	O	M
2.	B	R	L	I	N	O	T	G
3.	D	E	S	S	T	R	O	Y
4.	P	W	I	U	F	N	E	I
5.	S	U	S	L	F	U	H	R
6.	M	P	I	L	E	L	A	R
7.	R	I	N	S	T	I	N	G



\_\_\_\_\_

\_\_\_\_\_

# SODOM & GOMORRAH

## (GENESIS 19:1-30)

### MEMORY VERSE:

*"The Lord knows how to deliver the godly out of temptations and to reserve the unjust under punishment for the day of judgment." 2 PETER 2:9*

### UNDERLINE THE CORRECT ANSWER:

1. "Now the two angels came to Sodom in the evening, and..." **GENESIS 19:1**
  - a. Lot was sitting in the gate of Sodom
  - b. when Lot saw them, he rose to meet them
  - c. he bowed himself with his face toward the ground
  - d. all of the above

### TRUE OR FALSE:

2. "And he said, 'Here now, my lords, please turn in to your servant's house and spend the night, and wash your feet; then you may rise early and go on your way.' And they said, 'No, but we will spend the night in the open square.'" **GENESIS 19:2**

TRUE OR FALSE

3. So the two angels spent the night in the open square. **GENESIS 19:3**

TRUE OR FALSE

### CIRCLE THE CORRECT WORDS:

4. "Now before they lay down, the men of the city, the men of Sodom, both old and young, all the people from every quarter, (**BUILT, SURROUNDED**) the house." **GENESIS 19:4**
5. "The men reached out their hands and pulled Lot into the house with them, and shut the (**WINDOWS, DOOR**)." **GENESIS 19:10**
6. "And they struck the men who were at the doorway of the house with (**BLINDNESS, DEAFNESS**), both small and great, so that they became weary trying to find the door." **GENESIS 19:11**

### FILL IN THE BLANK:

7. "When the morning dawned, the angels urged Lot to \_\_\_\_\_, saying, 'Arise, take your wife and your two daughters who are here, lest you be consumed in the punishment of the city.'" **GENESIS 19:15**

### TRUE OR FALSE:

8. "So it came to pass, when they had brought them outside, that he said, 'Escape for your life! Do not look behind you nor stay anywhere in the plain. Escape to the mountains, lest you be destroyed.'" **GENESIS 19:17**

TRUE OR FALSE

9. "Then the LORD rained brimstone and fire on Sodom and Gomorrah, from the LORD out of the heavens." **GENESIS 19:24**

TRUE OR FALSE

10. But Lot's wife looked back behind him, and she became a pillar of sand. **GENESIS 19:26**

TRUE OR FALSE

# SODOM & GOMORRAH

## (GENESIS 19:1-30)

### MEMORY VERSE:

*"The Lord knows how to deliver the godly out of temptations and to reserve the unjust under punishment for the day of judgment." 2 PETER 2:9*

### UNDERLINE THE CORRECT ANSWER:

1. "Now the two angels came to Sodom in the evening, and..." GENESIS 19:1
  - a. Lot was sitting in the gate of Sodom
  - b. when Lot saw them, he rose to meet them
  - c. he bowed himself with his face toward the ground
  - d. all of the above

### TRUE OR FALSE:

2. "And he said, 'Here now, my lords, please turn in to your servant's house and spend the night, and wash your feet; then you may rise early and go on your way.' And they said, 'No, but we will spend the night in the open square.'" GENESIS 19:2  
TRUE OR FALSE
3. So the two angels spent the night in the open square. GENESIS 19:3  
TRUE OR FALSE

### FILL IN THE BLANKS:

4. "Now before they lay down, the men of the city, the men of Sodom, both old and young, all the people from every quarter, \_\_\_\_\_ the house." GENESIS 19:4
5. "The men reached out their hands and pulled Lot into the house with them, and shut the \_\_\_\_\_." GENESIS 19:10
6. "And they struck the men who were at the doorway of the house with \_\_\_\_\_, both small and great, so that they became \_\_\_\_\_ trying to find the door." GENESIS 19:11
7. "When the morning dawned, the angels urged Lot to \_\_\_\_\_, saying, 'Arise, take your wife and your two daughters who are here, lest you be \_\_\_\_\_ in the punishment of the city.'" GENESIS 19:15
8. "So it came to pass, when they had brought them outside, that he said, 'Escape for your life! \_\_\_\_\_ look behind you nor stay anywhere in the plain. Escape to the \_\_\_\_\_ mountains, lest you be destroyed.'" GENESIS 19:17
9. "Then the LORD rained \_\_\_\_\_ and \_\_\_\_\_ on Sodom and Gomorrah, from the LORD out of the heavens." GENESIS 19:24
10. But Lot's wife "looked back behind him, and she became a pillar of \_\_\_\_\_." GENESIS 19:26
11. "And it came to pass, when God destroyed the cities of the plain, that God \_\_\_\_\_, and sent Lot out of the midst of the overthrow, when He overthrew the cities in which Lot had dwelt." GENESIS 19:29

# SODOM & GOMORRAH

## (GENESIS 19:1-30)

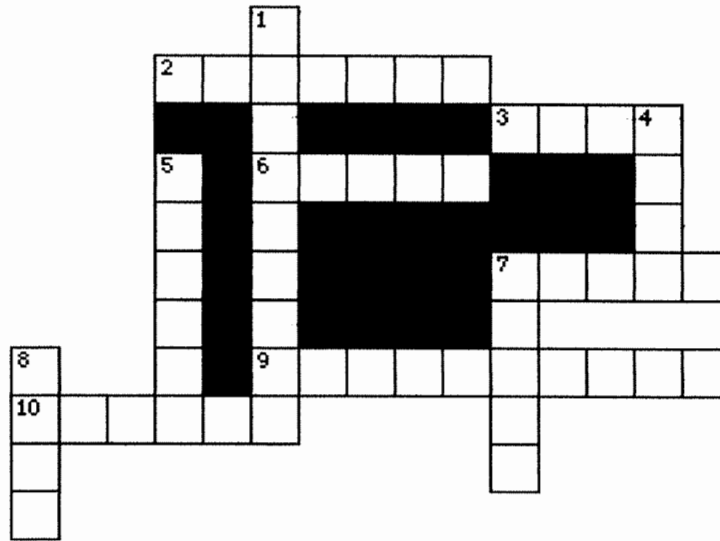

- 2 ACROSS "The Lord knows how to \_\_\_\_\_ the godly out of temptations and to reserve the unjust under punishment for the day of judgment." **2 PETER 2:9**
- 10 ACROSS "Now the two \_\_\_\_\_ came to Sodom in the evening, and Lot was sitting in the gate of Sodom. When Lot saw them, he rose to meet them, and he bowed himself with his face toward the ground." **GENESIS 19:1**
- 6 ACROSS "And he said, 'Here now, my lords, please turn in to your servant's house and spend the \_\_\_\_\_, and was your feet; then you may rise early and go on your way.' And they said, 'No, but we will spend the night in the open square.'" **GENESIS 19:2**
- 7 DOWN "But he insisted strongly; so they turned in to him and entered his \_\_\_\_\_." **GENESIS 19:3**
- 9 ACROSS "Now before they lay down, the men of the city, the men of Sodom, both old and young, all the people from every quarter, \_\_\_\_\_ the house." **GENESIS 19:4**
- 4 DOWN "The men reached out their hands and pulled Lot into the house with them, and shut the \_\_\_\_\_." **GENESIS. 19:10**
- 1 DOWN "And they struck the men who were at the doorway of the house with \_\_\_\_\_, both small and great, so that they became weary trying to find the door." **GENESIS 19:11**
- 7 ACROSS "When the morning dawned, the angels urged Lot to \_\_\_\_\_, saying, 'Arise, take your wife and your two daughters who are here, lest you be consumed in the punishment of the city.'" **GENESIS 19:15**
- 5 DOWN "So it came to pass, when they had brought them outside, that he said, '\_\_\_\_\_ for your life! Do not look behind you nor stay anywhere in the plain. Escape to the mountains, lest you be destroyed.'" **GENESIS 19:17**
- 3 ACROSS "Then the \_\_\_\_\_ rained brimstone and fire on Sodom and Gomorrah, from the LORD out of the heavens." **GENESIS 19:24**
- 8 DOWN But Lot's wife "looked back behind him, and she became a pillar of \_\_\_\_\_." **GENESIS 19:26**

# SODOM & GOMORRAH

(GENESIS 19:1-30)

R W C I H A B D N L U O O H Q A U N F U V Q P C M S X D V R  
V H T T A Y P V Y Y U V U X U E Y E W W S R L U R G Y O X X  
N Q C A U Q P B M H A S I V M I E E L I E U J R X I A N R T  
G I J L M U Y G A L S P I T W O A N G E L S D S G F E Z B P  
D L W O U Q P C S T U T B S J S E M J A T M D J B L M F I K  
P H D E T T F I R X D F R U Q G J J B C K E R L I B X N U Z  
K O Y B K H O U L O D W I X L F I R E L T S A E F K Z X Q O  
S T J Z T O C Z V L W B W C J J A Q B P N S M P E S U O H V  
S Y T Z D K M H Y I A H G H R P V V K A B H A R R O M O G L  
P O N N D T J S K R T R T U T E K E J I Y Z J B V M U A H C  
P A A K Q T W K W F L J O Q W Z M V K E B P L N S I I D C Y  
R V S O C R S K L Y A Y K F K F U V U Y R J P S M U J P C Y  
X C L O T R S R W X O K Y T S B O L M A I H O R K X L U N P  
O A L B U D O O R D A P W O M A Z A X Q M D L E I W M K U D  
S L P H J W I R W F P G I P R X L I Y A S C T T R V P I K D  
L O U F K P A A Z B A K U L L T X T R O T U P H K K X X S A  
K Z E V S N G O B E D G M J U K S L T Y O U N G Q G E R U W  
W M T V M K W Z O L Y P F B G M A E T E N S R U Y P C Q N Z  
V F N I E B A E A H I S O J C Z M R D A E Y A A C H H I E C  
J M D O J N F N K T S N E H V X Z U C E Z J P D Z K M J S P  
X Q R N T C I C U L M O D E P A C S E E A G L S A H X L X Y  
W S A H A D U N A U U T P N U I B U M D X A Y L K C I J T E  
E Q Z I A W T V G T X W K T E Z T C P I U K M P R O V V I J  
L V E U U K O C N W E I J J B S P Q M S E R T H V V M R L R  
V P M A E I M C N Q S H F Y N F S N L T D B F L Z N T R E L  
D B D F N E J H U E E J Y R H Z Z R C U K N H Q Y J Q K I P  
D Q W F Q P K R D N M D T D X X F U S O G Y D U E L V J A P  
Z W I F E I G E L I J U W C A D V K G Q C N R I H D U S K B  
Z J Q T X Y H M U S M O U G U K F B E U M M S C Z R G F Q X  
O I X Q N B G Q F V G L G S V X H I Y T N Q M C C Z B Q Y D

- |           |          |                |            |
|-----------|----------|----------------|------------|
| ATE       | ESCAPE   | LOT            | SODOM      |
| BLINDNESS | EVENING  | MEN            | STRUCK     |
| BRIMSTONE | FEAST    | MERCIFUL       | TWO ANGELS |
| DAUGHTERS | FIRE     | OUTSIDE        | WIFE       |
| DESTROY   | GOMORRAH | PILLAR OF SALT | ZOAR       |
| HOUSE     | SMOKE    | DOOR           |            |

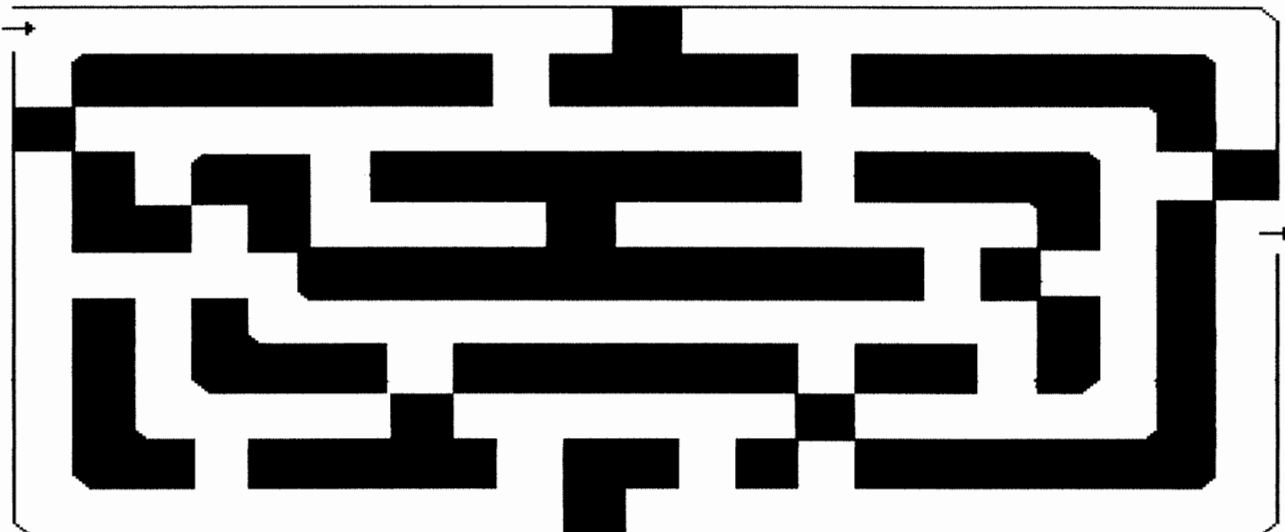

# SODOM & GOMORRAH

(GENESIS 19:1-30)

B F E A S T K E D T M X V I Q  
 L D O O R K V G S J E T L D G  
 I Z H E R I F S T C N L E E N  
 N O D S M O K E L I A S R N I  
 D A S L E G N A O W T P R O N  
 N R E S U O H L V R A O E T E  
 E K F T N T E C O P Y A L S V  
 S O W E L O F Y E F I W E M E  
 S T L A S F O R A L L I P I P  
 U O Y F M H A R R O M O G R I  
 A P L U F I C R E M S A V B P  
 U S T R A C L Y P K G B T R O  
 D A U G H T E R S D M H U E R  
 T F S Y A N M O D O S P V F A  
 E D K R E D I S T U O U P V V

ATE  
 BLINDNESS  
 BRIMSTONE  
 DAUGHTERS  
 DESTROY  
 HOUSE

ESCAPE  
 EVENING  
 FEAST  
 FIRE  
 GOMORRAH  
 SMOKE

LOT  
 MEN  
 MERCIFUL  
 OUTSIDE  
 PILLAR OF SALT

SODOM  
 ZOAR  
 TWO ANGELS  
 WIFE  
 DOOR

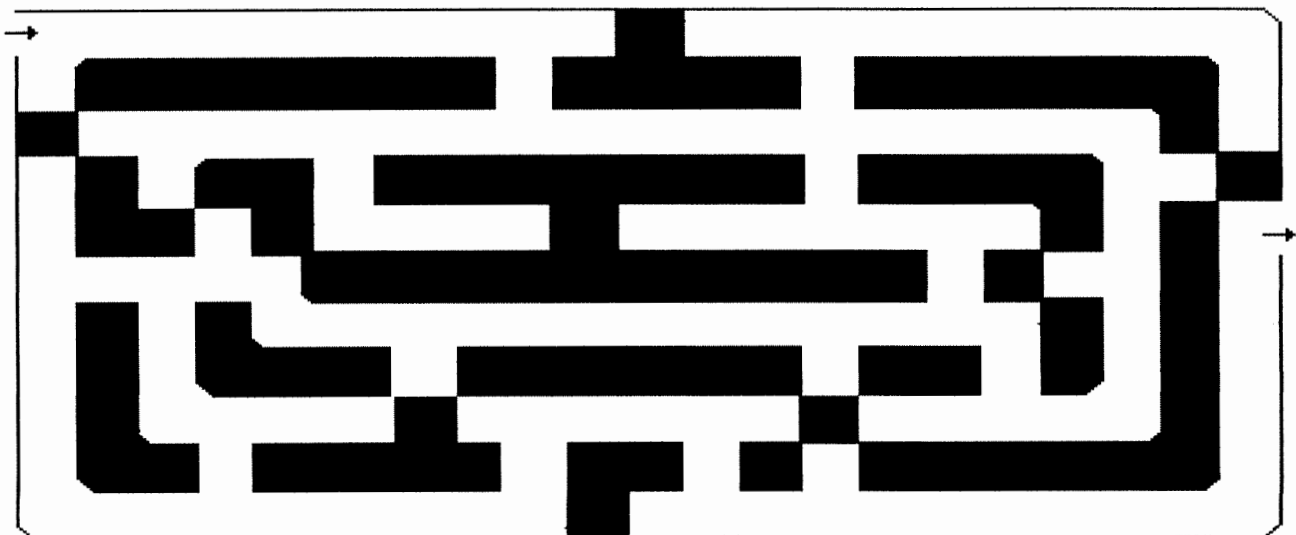

**Year 1**

**Week 14**

## **Ishmael**

**Scriptures: Genesis 21: 1-21**

**Key Verse: Gen 21:21 God was with the boy as he grew up. He lived in the desert and became an archer.**

### **Key Points:**

1. Sarah bore Isaac, which means laughter. Abraham held a great feast when Isaac was weaned. She resented Ishmael after Isaac was born, and wanted him sent away.

2. God reassured Abraham that he would make a great nation from Ishmael. Abraham loved Ishmael and provided for him and Hagar.

3. God loved Hagar and Ishmael and blessed them.

4. God was with them in the wilderness.





Sarah was the wife of Abraham, founder of the House of Israel. When Sarah was unable to bear a child, Sarah asked her servant Hagar to bear

one for her. After Hagar had given birth, however, she became arrogant and prideful. Sarah complained about her to Abraham.



Genesis 15:15

And Hagar departed and wandered in the wilderness of Beersheba.

## God is Watching Me Binoculars

- scissors
- cardboard (toilet paper) tubes
- colored tape
- crayons
- yarn or lacing
- hole punch
- clear tape

To prepare, print and cut the binocular cover graphic print out. Place two cardboard tubes side by side, wrap colored tape around the top and the bottom to connect them or use stapler, and give them a finished look. Cut yarn, or lacing, to approximately thirty -inch lengths. Hole punch in each side of binoculars and tie on yarn. Tape or glue graphic.

### Sample:

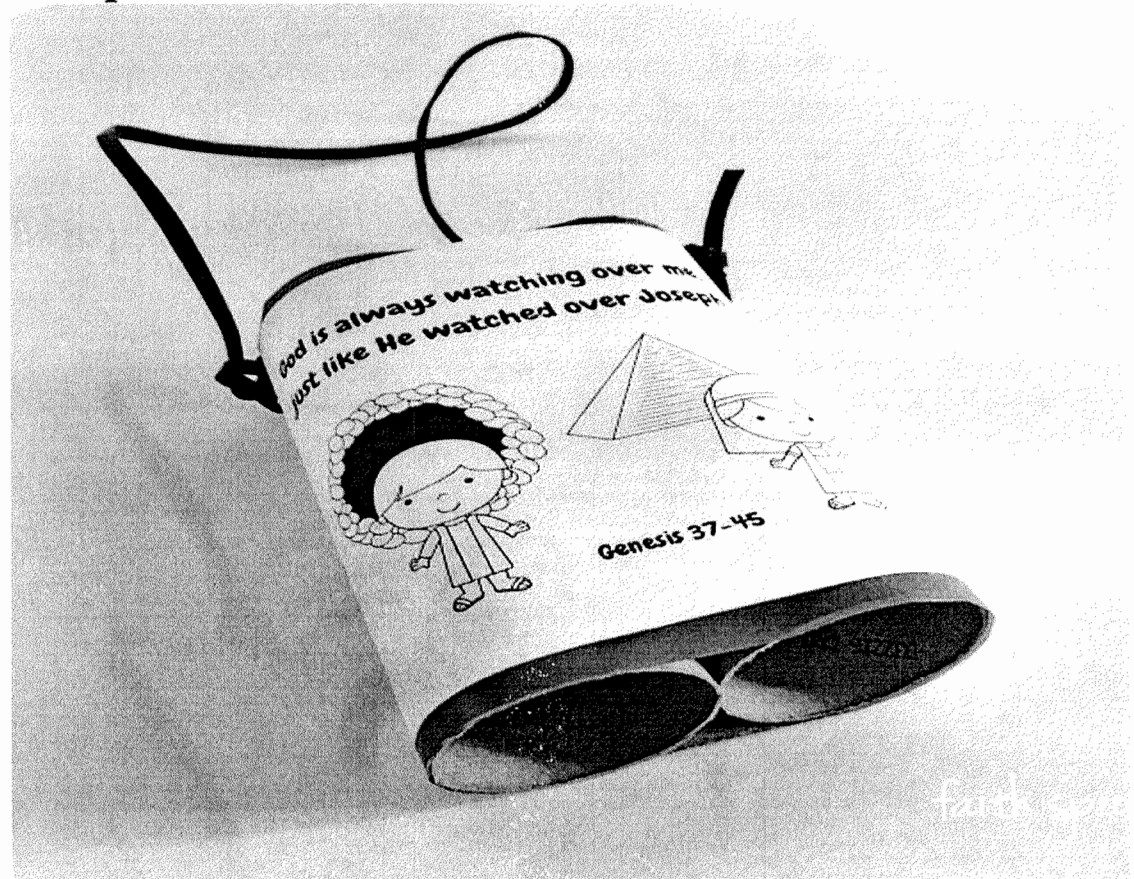

Genesis 21: 17-20  
God is always watching over me  
Just like he was watching Ishmael



Genesis 21: 17-20  
God is always watching over me  
Just like he was watching Ishmael



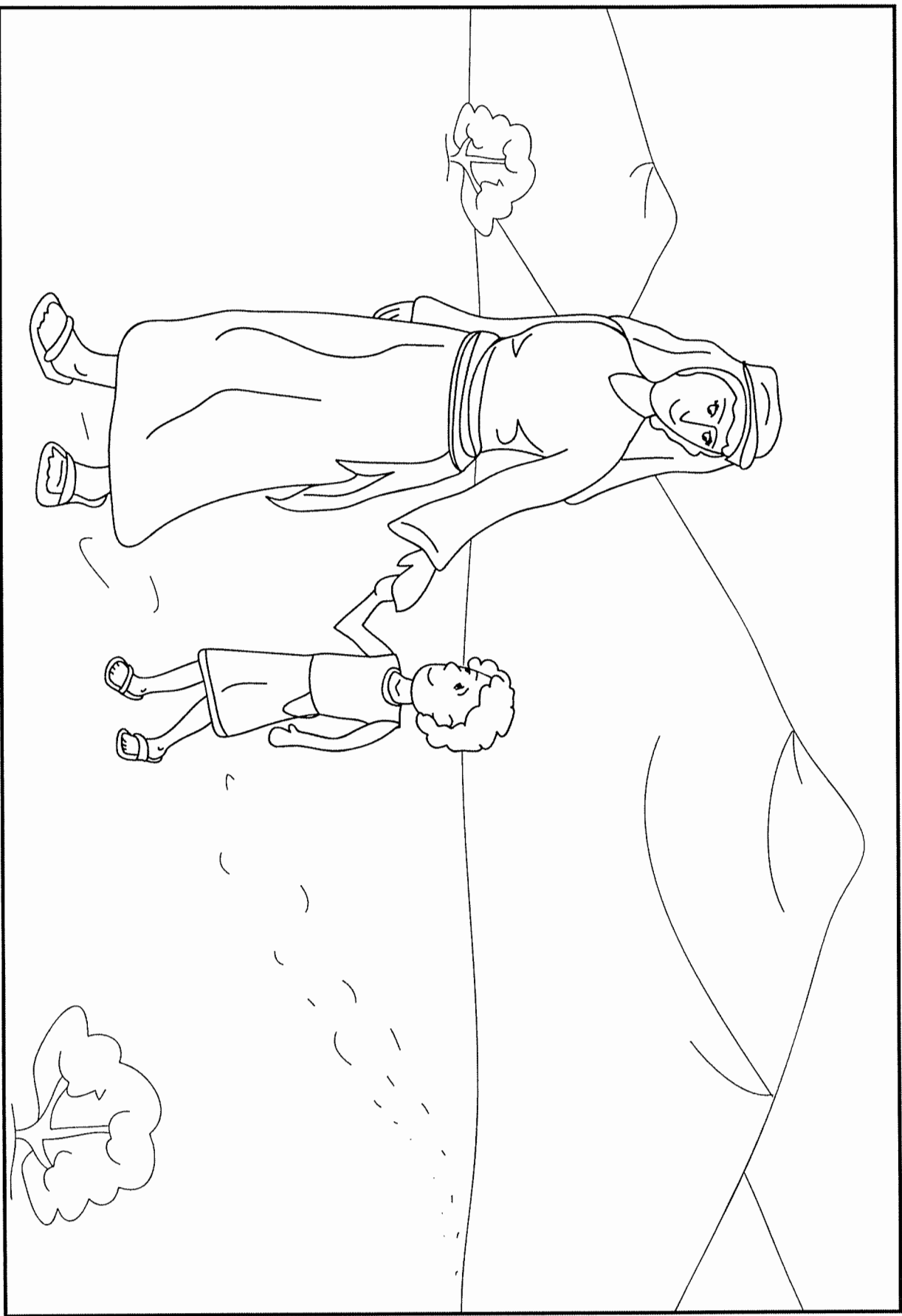

**Hagar and Ishmael**

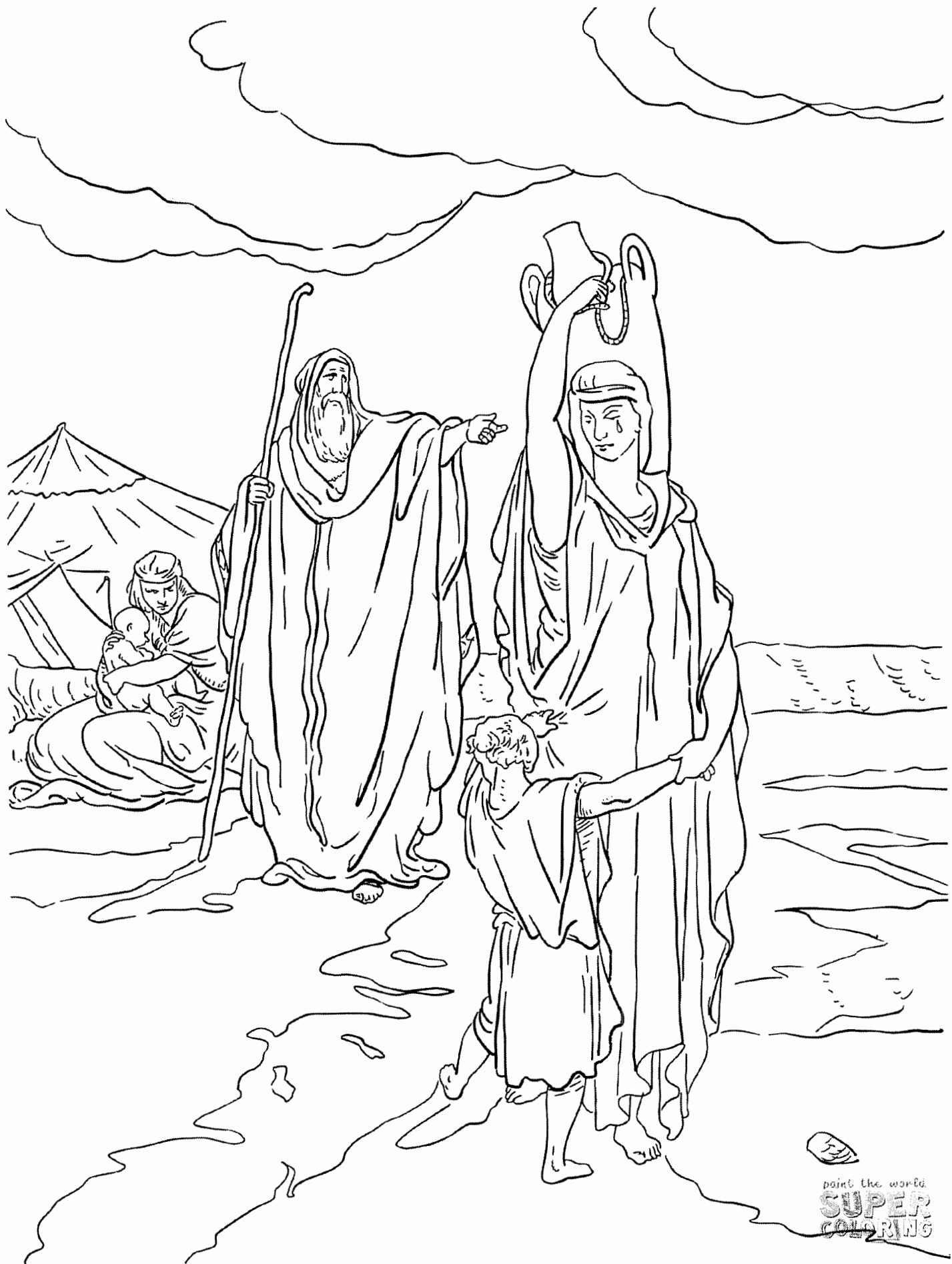



# Hagar and Ishmael in the Desert

Directions: Color in the following image using 1. White 2. Beige 3. Brown 4. Blue 5. Purple 6. Green





## Hagar and Ishmael

Fill in the blanks by unscrambling the word.

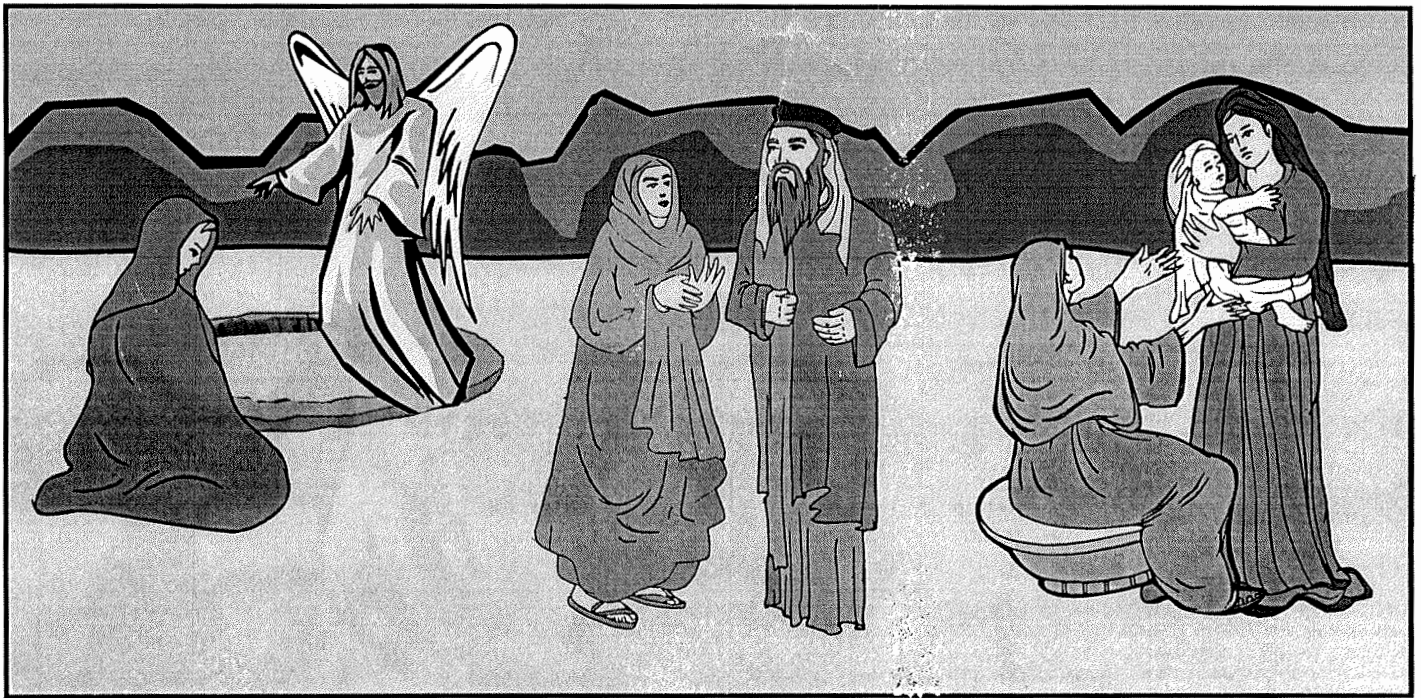

God promised \_\_\_\_\_ (AAGR H) that she was going to have many children.

Hagar's first child was \_\_\_\_\_ (MIASEHL). \_\_\_\_\_ (HSRAA) told her servant, Hagar she had to have a baby for

\_\_\_\_\_ (RASA H AND MHAARBA).

Sarah was mean to Hagar and Hagar ran away and she met one of God's \_\_\_\_\_ (SALENG) who told her to return to Sarah.

Hagar named her son Ishmael which means \_\_\_\_\_ (DGO ERHAS).

Hagar was so impressed that God talked with her that she named Him the \_\_\_\_\_ (OGD FO ISENEG).

# CRYPTOGRAM

## Genesis 21:13 (NKJV)

A	B	C	D	E	F	G	H	I	J	K	L	M	N	O	P	Q	R	S	T	U	V	W	X	Y	Z
5	6	26	16	14	2	25	7	19	13	20	12	15	22	4	8	17	9	10	11	23	1	3	21	18	24

\_\_\_\_\_  
18 14 11      19      3 19 12 12      5 12 10 4      15 5 20 14      5

\_\_\_\_\_  
22 5 11 19 4 22      4 2      11 7 14      10 4 22      4 2      11 7 14

\_\_\_\_\_  
6 4 22 16 3 4 15 5 22      6 14 26 5 23 10 14      7 14      19 10

\_\_\_\_\_  
18 4 23 9      10 14 14 16

---

### Directions:

This puzzle is called a Cryptogram. I've always loved doing them! At the top there is a KEY that lists all the letters from A thru Z with a box below. Each of the letters has a corresponding number.

The bottom part contains a secret phrase. Each of the blanks has a number underneath it. Fill in the letters that correspond to the numbers below the blanks to solve the phrase.

[www.KidZone.ws](http://www.KidZone.ws)

Cryptogram



**In their old age, a son was born to Abraham and his wife, Sarah. He was named Isaac.**

*Coloring & Activity Pages by: Bible-Printables.com*

# ISAAC IS BORN

(GENESIS 21:1-8)



“And Abraham called the name of his son that was born unto him, whom Sarah bare to him, Isaac.”

**GENESIS 21:3**





Sarah will bear you a son, and you

will call him \_\_\_\_\_.

Genesis 17:19

---



# ISAAC IS BORN

## (GENESIS 21:1-8)

### MEMORY VERSE:

*"I will sing of the mercies of the LORD forever; with my mouth will I make known Your faithfulness to all generations."* PSALM 89:1

### TRUE OR FALSE:

1. "And the LORD visited Sarah as He had said, and the LORD did for Sarah as He had spoken." **GENESIS 21:1**

TRUE OR FALSE

### FILL IN THE BLANKS:

2. "For Sarah conceived and bore Abraham a son in his \_\_\_\_\_ age, at the set time of which God had spoken to him." **GENESIS 21:2**
3. "And Abraham called the name of his son who was born to him - whom Sarah bore to him - \_\_\_\_\_." **GENESIS 21:3**

### CIRCLE THE CORRECT WORDS:

4. "Now Abraham was one (**HUNDRED, THOUSAND**) years old when his son Isaac was born to him." **GENESIS 21:5**
5. "And Sarah said, 'God has made me (**LAUGH, CRY**), so that all who hear will (**LAUGH, CRY**) with me.'" **GENESIS 21:6**

### TRUE OR FALSE:

6. "She also said, 'Who would have said to Abraham that Sarah would nurse children? For I have borne him a son in his old age.'" **GENESIS 21:7**

TRUE OR FALSE

### FILL IN THE BLANK:

7. "So the child grew and was weaned. And Abraham made a great \_\_\_\_\_ on the same day that Isaac was weaned." **GENESIS 21:8**



# ISAAC IS BORN

## (GENESIS 21:1-8)

### MEMORY VERSE:

*"I will sing of the mercies of the LORD forever; with my mouth will I make known Your faithfulness to all generations." PSALM 89:1*

### FILL IN THE BLANKS:

1. "And the LORD visited Sarah \_\_\_\_\_, and the LORD did for Sarah \_\_\_\_\_." **GENESIS 21:1**
2. "For Sarah conceived and bore Abraham a son in his \_\_\_\_\_ age, at the set time of which God had spoken to him." **GENESIS 21:2**
3. "And Abraham called the name of his son who was born to him - whom Sarah bore to him - \_\_\_\_\_." **GENESIS 21:3**
4. "Now Abraham was \_\_\_\_\_ years old when his son Isaac was born to him." **GENESIS 21:5**

### CIRCLE THE CORRECT WORDS:

5. "And Sarah said, 'God has made me (LAUGH, CRY), so that all who hear will (LAUGH, CRY) with me.'" **GENESIS 21:6**

### TRUE OR FALSE:

6. "She also said, 'Who would have said to Abraham that Sarah would nurse children? For I have borne him a son in his old age.'" **GENESIS 21:7**  
**TRUE OR FALSE**
7. "So the child grew and was weaned. And Abraham made a great feast on the same day that Isaac was weaned." **GENESIS 21:8**  
**TRUE OR FALSE**

# ISAAC IS BORN

(GENESIS 21:1-8)

W D L I H C G Q P T M S W E O  
 Q S Y F B W X Y G L G G Z F T  
 T T H F Y J G E R C A D K J A  
 A A U O N N R L E Y A U K T N  
 U Z T S A E F N W L F A G E R  
 U S Q P N S Q V J I H E S H P  
 B D S O M Z I A T O A P Q I I  
 O J S E H K P Q B V W Z J J Q  
 R N E K O P S H A R A S D Z D  
 N Q S O L B H T B Q A L B Z J  
 H I I O D Z Z A I Z O H B K Q  
 E K L C R F I Q A U D C A C R  
 W E A N E D V F M R X C R M I  
 R T S F E H V H O A P Q B T L  
 J D J K U N B L X N E I K I S

ABRAHAM  
 LAUGH  
 SPOKEN  
 GREW

ISAAC  
 SON  
 FEAST

SARAH  
 CHILD  
 OLD

BORN  
 LORD  
 WEANED

WRITE DOWN THE WORDS OF THE VERSE IN THE CORRECT ORDER ON THE LINES BELOW

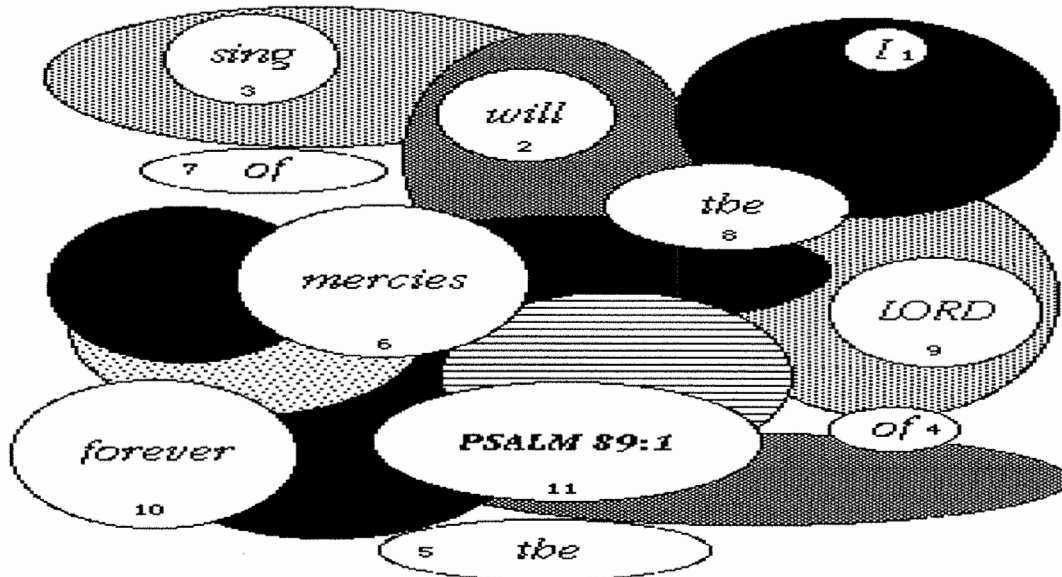

" \_\_\_\_\_ "

\_\_\_\_\_

# ISAAC IS BORN

## (GENESIS 21:1-8)

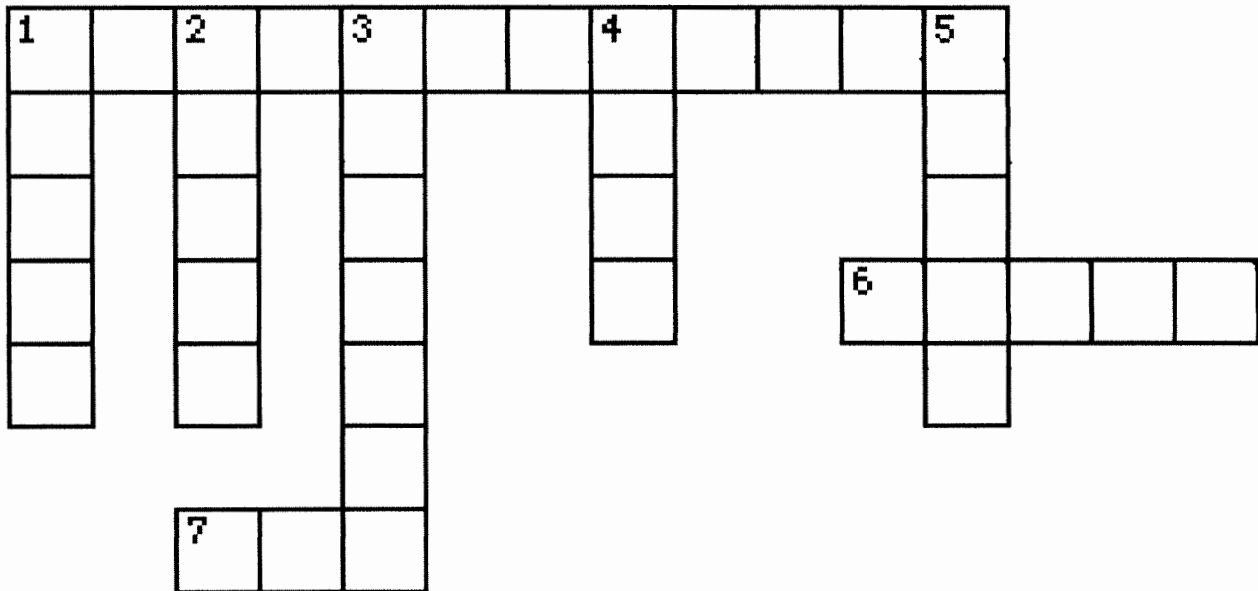

- 1 ACROSS "I will sing of the mercies of the LORD forever; with my mouth will I make known Your \_\_\_\_\_ to all generations." **PSALM 89:1**
- 4 DOWN "And the \_\_\_\_\_ visited Sarah as He had said, and the LORD did for Sarah as He had spoken." **GENESIS 21:1**
- 7 ACROSS "For Sarah conceived and bore Abraham a son in his \_\_\_\_\_ age, at the set time of which God had spoken to him." **GENESIS 21:2**
- 2 DOWN "And Abraham called the name of his son who was born to him - whom Sarah bore to him - \_\_\_\_\_." **GENESIS 21:3**
- 3 DOWN "Now Abraham was one \_\_\_\_\_ years old when his son Isaac was born to him." **GENESIS 21:5**
- 6 ACROSS "And Sarah said, 'God has made me \_\_\_\_\_, so that all who hear will laugh with me.' "**GENESIS 21:6**
- 5 DOWN "She also said, 'Who would have said to Abraham that \_\_\_\_\_ would nurse children? For I have borne him a son in his old age.' "**GENESIS 21:7**
- 1 DOWN "So the child grew and was weaned. And Abraham made a great \_\_\_\_\_ on the same day that Isaac was weaned." **GENESIS 21:8**

# ISAAC IS BORN

## (GENESIS 21:1-8)

L Y P K D L V I D Z F U Q C P K R K H N  
 R R U K P V C C R N F J U D Y G E W X I  
 H F Y O K D H T A F E A S T F H N L O S  
 I H F J A D A G Z K T K Q W O G C W I V  
 D E K Q S B L C U O Q S T K J S V W R U  
 Y L T S P Z R J E A H M H I C A A S I U  
 E M G P P Z O A M B L J T W W D C R F A  
 D G E M R O Z W H H A T T E S D C Z A D  
 P M Y B X W M Y W A U A R A S L H O Y H  
 U B G B O H F J D E M A R N I I R A X D  
 G O M O S Q M T W F R U W E A H E K D W  
 I P L H L S Q N Q V U G P D G C M U F T  
 C M Q D K I P A X I T E N E W V Q N B L  
 E W H S W L S O I O T N N P A B N U E A  
 U N V S V H Q S K N D Q R I F G Y D H O  
 X G V R J T V L T E D X O Y U C M L T A  
 M K G V X N P P A H N N B D T Z A U L P  
 K B S N O Y B U L I Q A R B O H S F U A  
 U Y N S W O Q T B U C O K B M K V L W D  
 Y K B G E A J N Z A L Y B P J K Y Y Q Y

ABRAHAM  
 BORN  
 CHILD  
 FEAST  
 GREW

ISAAC  
 LAUGH  
 LORD  
 OLD

SARAH  
 SON  
 SPOKEN  
 WEANED

WRITE DOWN THE WORDS OF THE VERSE IN THE CORRECT ORDER ON THE LINES BELOW

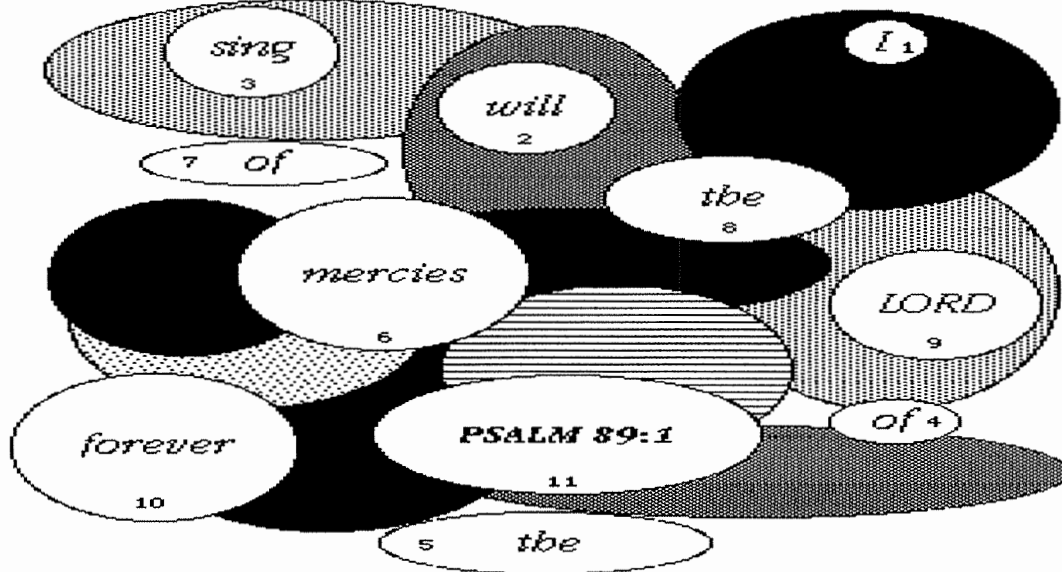

" \_\_\_\_\_ "

\_\_\_\_\_

# Abraham's Sons

## Main Points to Remember

1. God's plans will be fulfilled God's way, not ours.
2. Going outside God's ways brings strife and pain

**Vocabulary:** **handmaiden:** a female servant

**Prayer:** Father, please keep us from pursuing our plans and instead guide us through your plans

**Activity:** Make a timeline to show that God's time is larger than our time. Put Abraham and one end and Christ at the other. Talk about the promises God made to Abraham and mark their approximate completion on the timeline. Isaac was born when Abraham was 100 years old. A great people could start about the time of the captivity - 400 years after Abraham. The land would be about 50 years after that. The Messiah would come 2000 years after Abraham! Discuss how much sooner the son of promise came than the other promises. Which promises did Abraham live to see? Should we always expect to see all of God's promises fulfilled in our lifetime? No. There are some things we do that we may never see the full result of. But we must trust that the promise will be fulfilled and our efforts will be worth it all.

**Discussion:** Do the ends justify the means? Sarah felt that if she couldn't give Abraham a son, Hagar could. She failed to rely on God to give them both a son. God often asks us to participate in his plans, but that doesn't mean we can change his plans. We can't use any old means to achieve God's ends. The crusaders felt they could torture people into "converting" to Christianity. Many people today feel they can worship, or obey, in whatever fashion they desire, as long as their "goal" is to worship or obey. God wants "obedience more than sacrifice". He wants us to submit, and trust that his ways will accomplish his plans.

**Activity:** Add Ishmael and Isaac to a family tree that will develop as the lessons progress. Have the students make generic paper people (like [Bible Friends](#)). Name them and post them on a board, using yarn or dots to connect the family lines. A great source for OT family tree information is: <http://bible.ort.org/books/gened2.asp>

## True/False

1. God intended from Abraham's son to be from Hagar. F
2. Abraham and his wife were beyond child-bearing age. T
3. Sarah loved Ishmael and Hagar. F
4. Hagar was rescued by the Angel of the Lord. T
5. Ishmael was the son that God promised Abraham. F

## Memory Work

- "No longer shall your name be called Abram, but your name shall be Abraham, for I have made you a father of many nations." Genesis 17:5

Review Questions (can be used with [gameboard](#))



linguistic questions

1. Where in the Bible is this lesson found? Genesis

2. Fill in the blank: "I have made you a father of many \_\_\_\_\_." nations
3. Name the wife and sons of Abraham.



### activity questions

1. Draw a quick family tree of Abraham's family.
2. Act out Sarah being harsh to Hagar.
3. Describe what is happening in the picture of the Ishmael Bible Trading Card.



### emotion questions

1. Why did Sarah give Hagar to Abraham? She wanted a son by any means.
2. Why was Sarah harsh with Hagar? 1) because Hagar disdained Sarah, 2) she worried that Ishmael would take Isaac's place
3. How do you think Hagar felt when she was sent away? hopeless, used
4. How do you think she felt when the Angel of the Lord saved her? rescued, reborn



### application questions

1. Will altering God's plan bring joy or pain? pain
2. Can God accomplish his plans his way? always
3. It's easy to take our failures out on others? How can we avoid being like Sarah? 1) don't try to alter God's plans, 2) confess our error and take responsibility for our mistakes



### fact questions

1. Who was Hagar? Sarah's servant
2. Who was Ishmael? Hagar's son with Abraham
3. Who was the son of promise? Isaac
4. How old was Abraham when Isaac was born? 100



### review questions

1. Why was Isaac obviously a special child? only God could make a child from two people as old as Sarah and Abraham
2. Why was Ishmael promised a nation? because he was also a child of Abraham
3. Was Ishmael's life easy? no, God said "his hand shall be against every man, and every man's hand against him"

**Year 1**

**Week 15**

## **Abraham Obeys God**

**Scriptures: Genesis 22**

**Key Verse: Gen. 22:18 “In your seed all the nations of the earth shall be blessed, because you have obeyed my voice.”**

### **Key Points:**

1. God tested Abraham by asking him to sacrifice his only son.
2. Abraham was willing to give everything he had to serve the Lord, and was obedient to God.
3. Isaac was obedient to his father even though he questioned what they were about to do.
4. God will provide for those who trust Him.

BibleWise

# Abraham and Isaac Mountain Maze

Follow the maze to see the route that Abraham took Isaac up to the mountain to sacrifice the lamb.

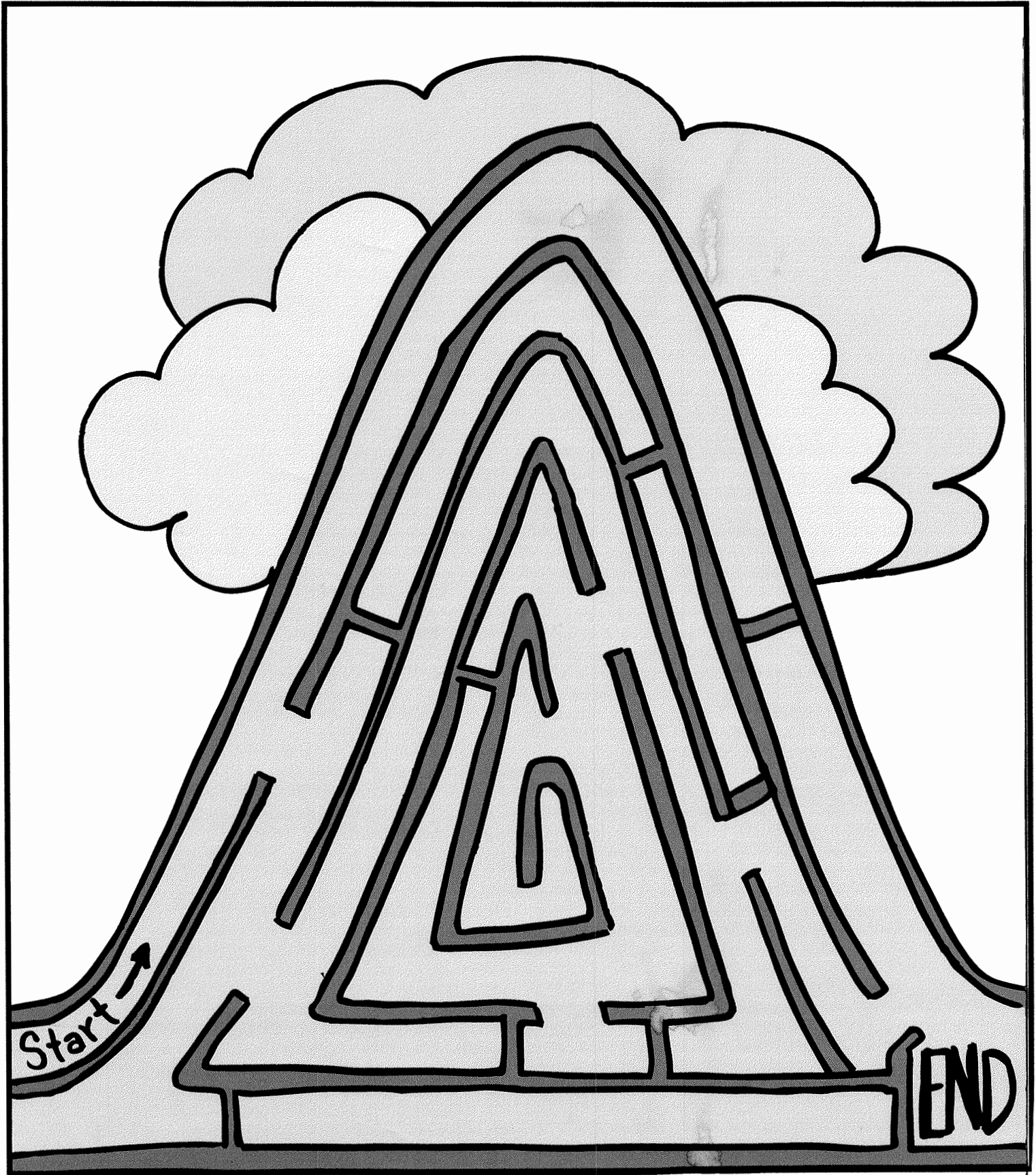



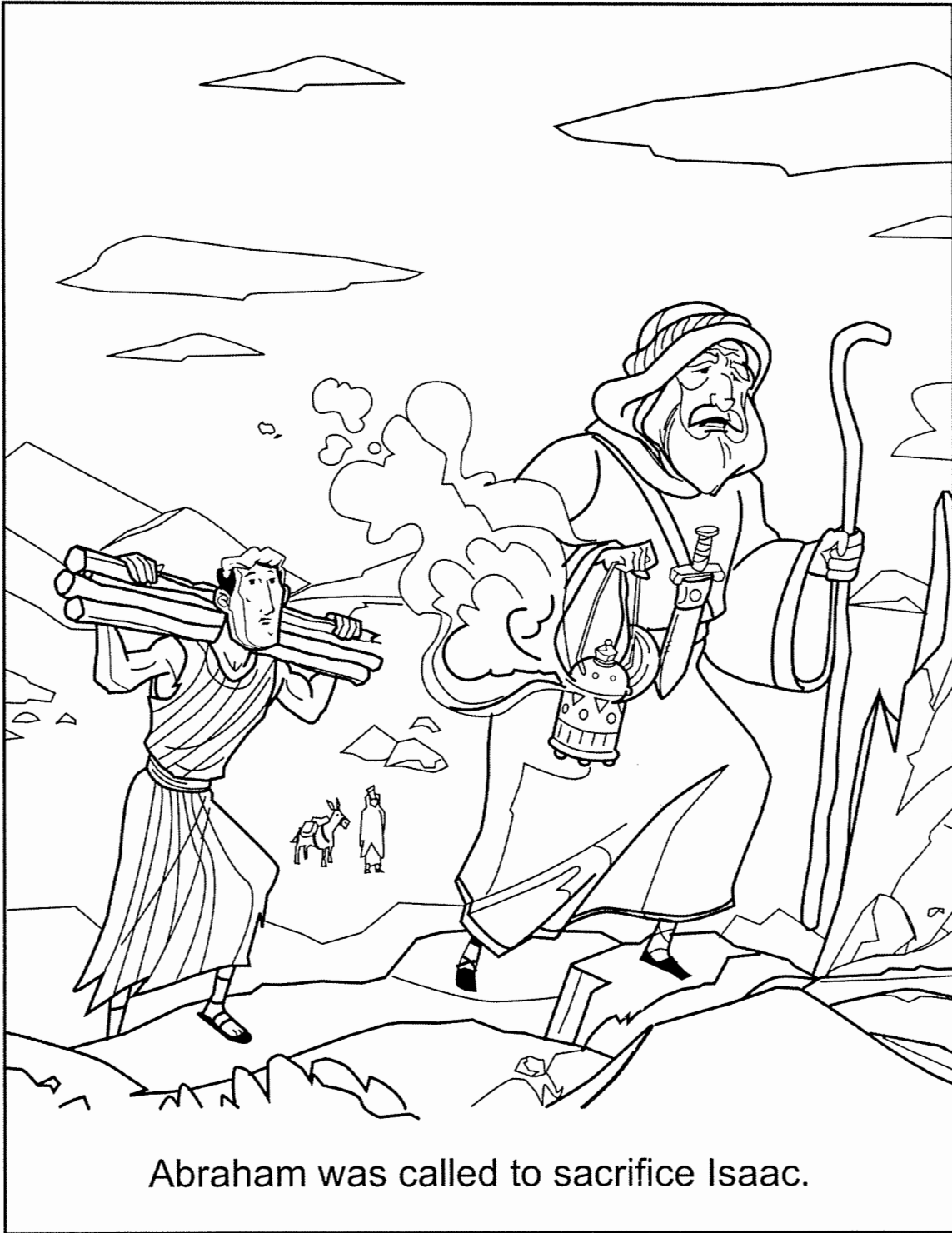

Abraham was called to sacrifice Isaac.



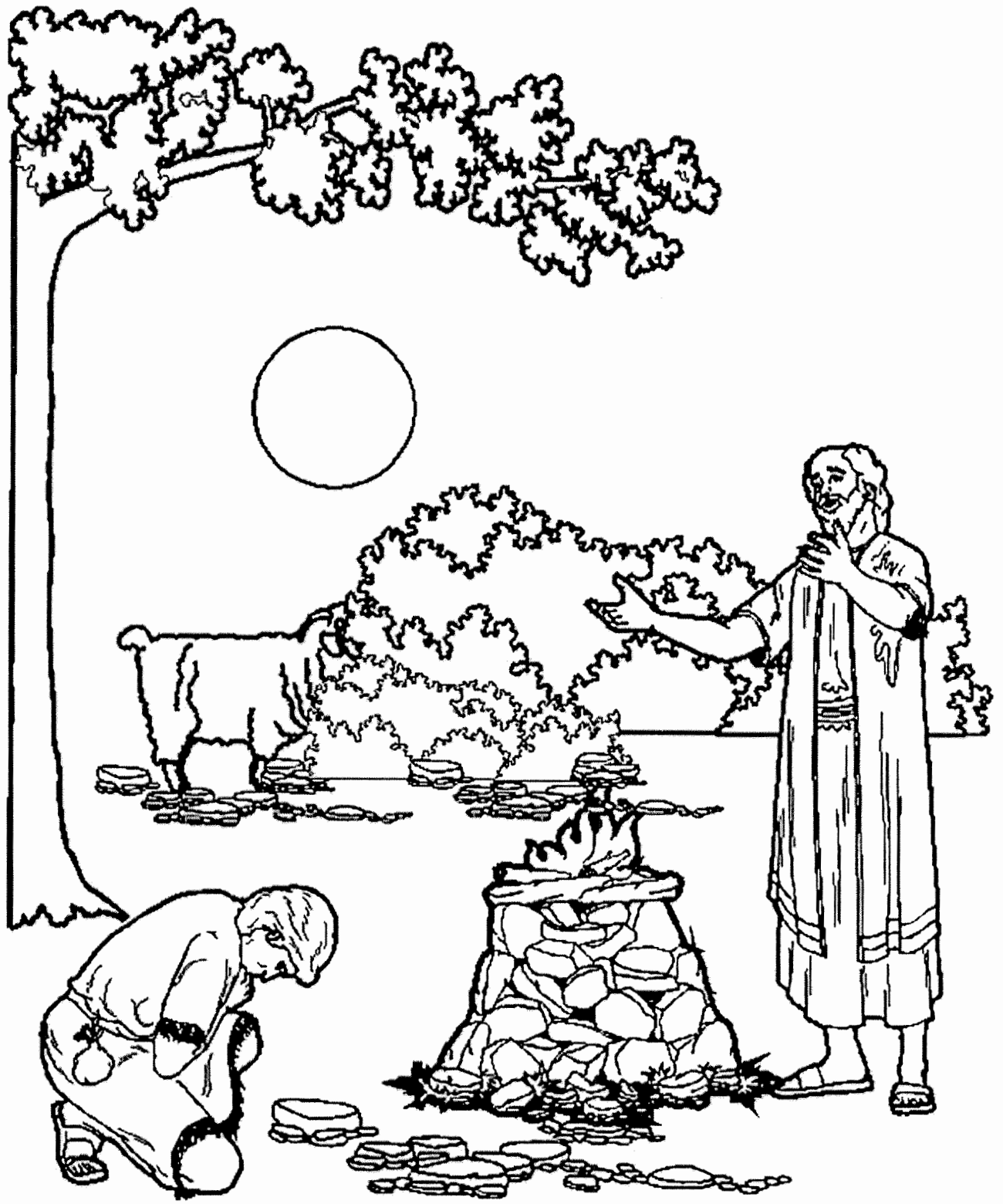



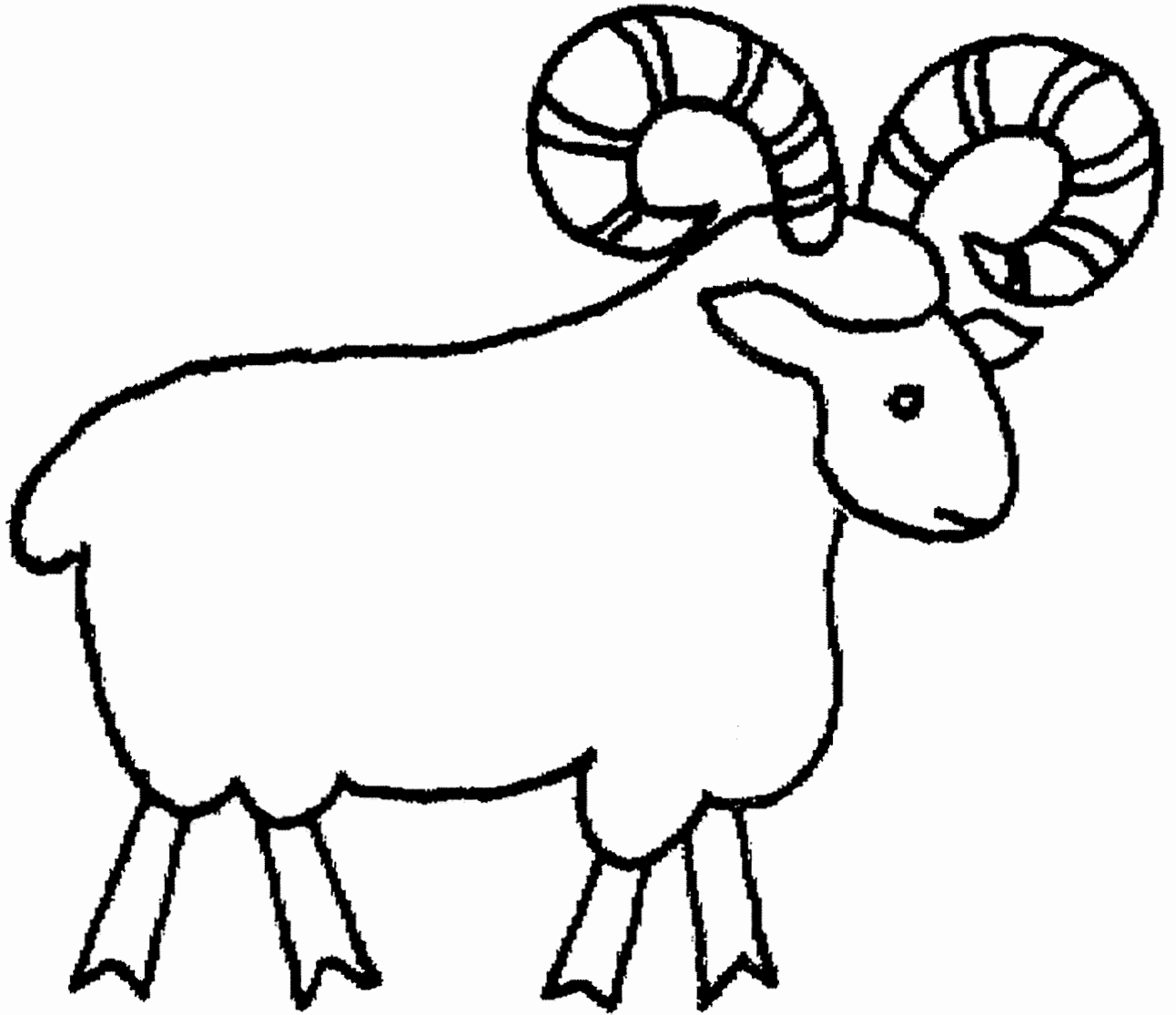

66 The LORD 77  
will provide.  
Genesis 22:14

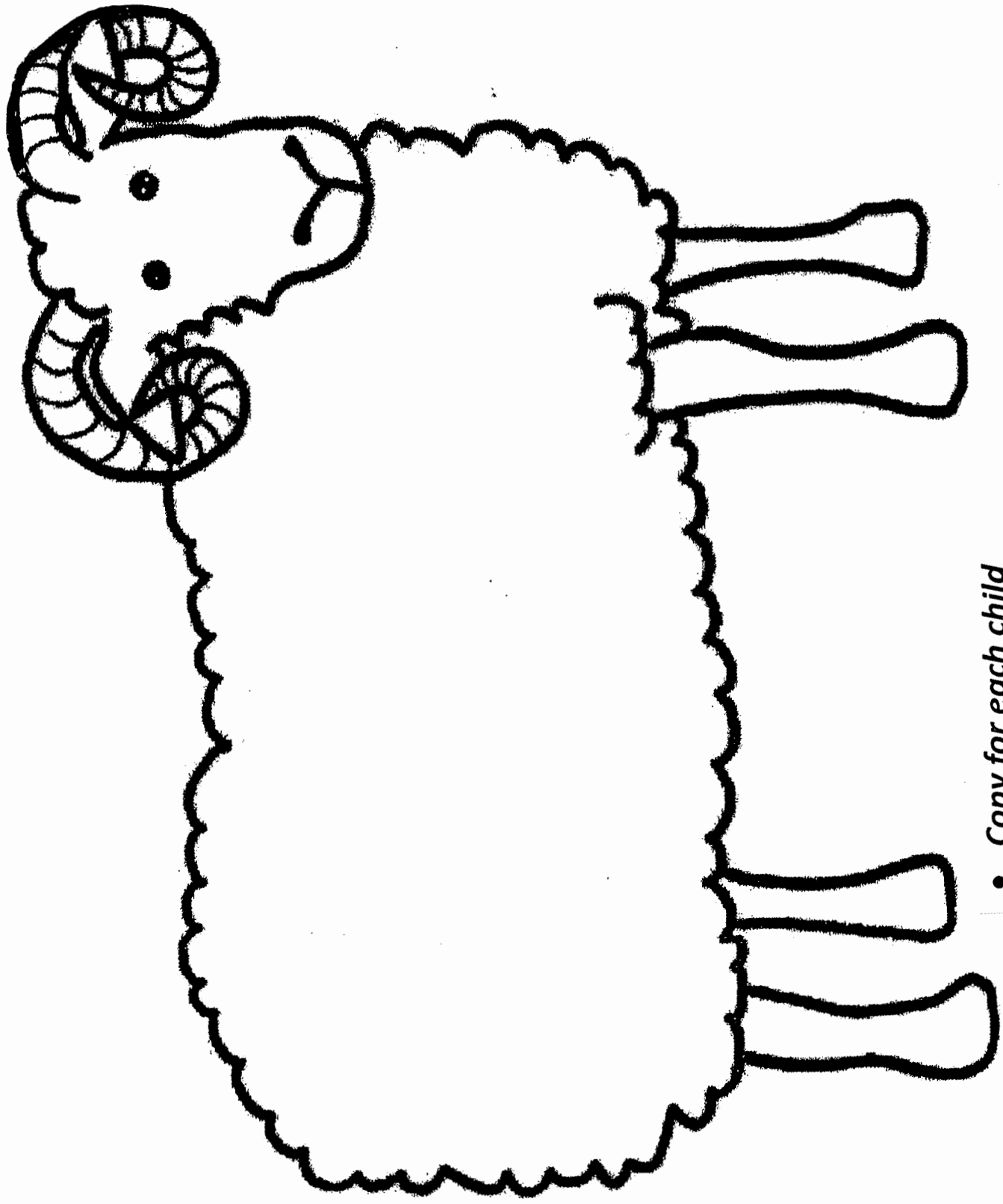

- Copy for each child
- Cut out, color and glue on cotton balls, pom poms or torn pieces of tissue paper for fur.

For "Ram in the thicket" craft.

# ABRAHAM OFFERS ISAAC

(GENESIS 22:1-18)



“And Abraham lifted up his eyes, and looked, and behold behind *him* a ram caught in a thicket by his horns: and Abraham went and took the ram, and offered him up for a burnt offering in the stead of his son.”

**GENESIS 22:13**



[www.ChristianPreschoolPrintables.com](http://www.ChristianPreschoolPrintables.com)  
Imager (c) Jupiter Co.





# ABRAHAM

## A TRUE TEST OF LOVE

### MEMORY VERSE

*We ought to obey God. ~ Acts 5:29*

Genesis 22:1-18

**INTRODUCTION** God decided to test Abraham to see if Abraham loved his son Isaac more than God. God told Abraham to bring Isaac to a mountain and sacrifice (or kill) the boy. Abraham obeyed God by bringing Isaac to the mountain. Just when he was ready to sacrifice his son, an angel told Abraham, "Stop." Abraham sacrificed a sheep instead. This story shows us that Abraham loved God most of all.

**FIND THE SHEEP** Help Abraham find the sheep in the bushes. Glue a piece of cotton on the sheep when you find it. Then color the picture. As you color, think of ways you can show God you love Him. Say, "Thank You, God, for giving me the Bible so that I can learn how to love You more."



**FOR THE TEACHER** Duplicate a picture for each child. Tell the story and help each child find the sheep (see page 95). Provide tiny bits of cotton and glue sticks. Help the children spread the glue and then add the cotton. Let them color the other hidden animals to match the bushes. Talk about the animals as the children find them.

# Abraham and Isaac Worship on the Mountain

God told Abraham to go to a mountain and offer his son Isaac as a sacrifice. Abraham obeyed, but God stopped him from hurting Isaac. Follow the maze up the mountain to find out why Isaac wasn't sacrificed.

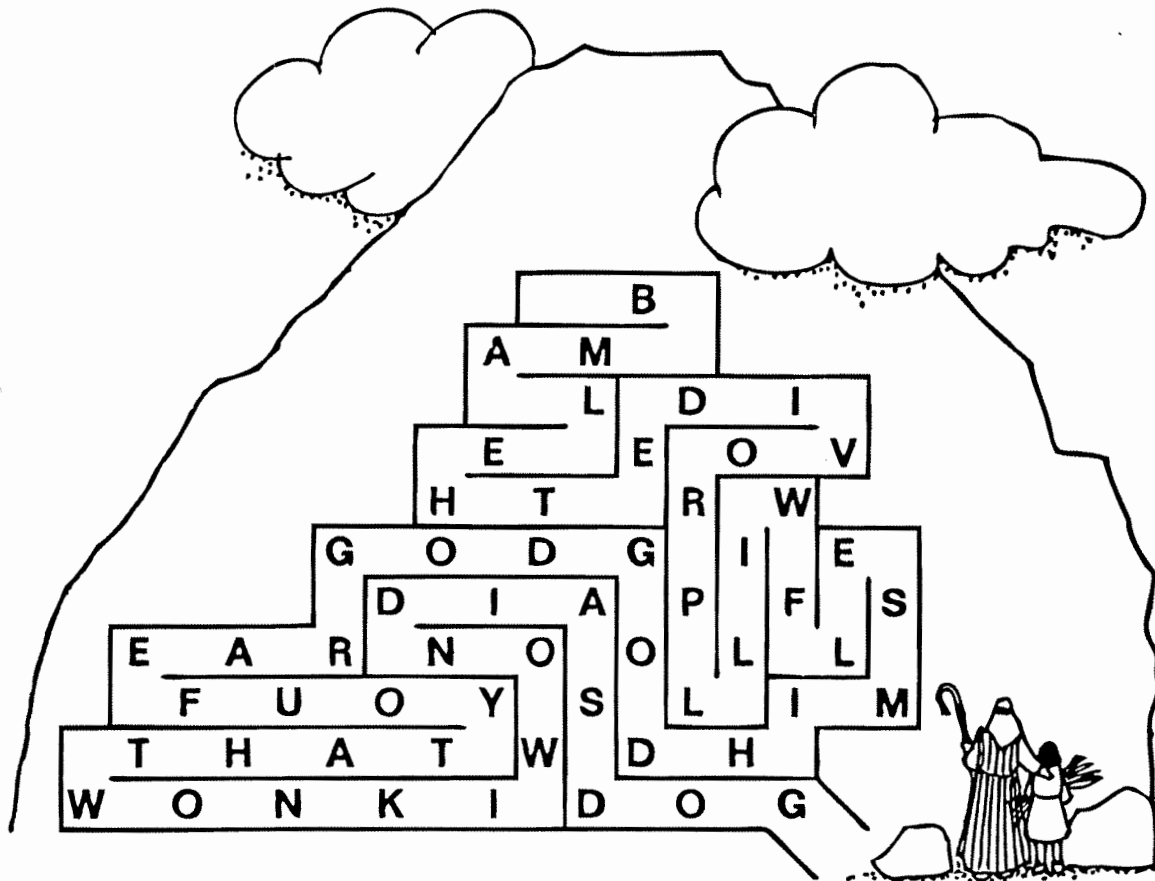

----- " -----

----- " -----

-----

-----

One night God gave  
Abraham a strange  
command. It was  
a test to see if  
Abraham loved his  
son Isaac more than  
he loved God.

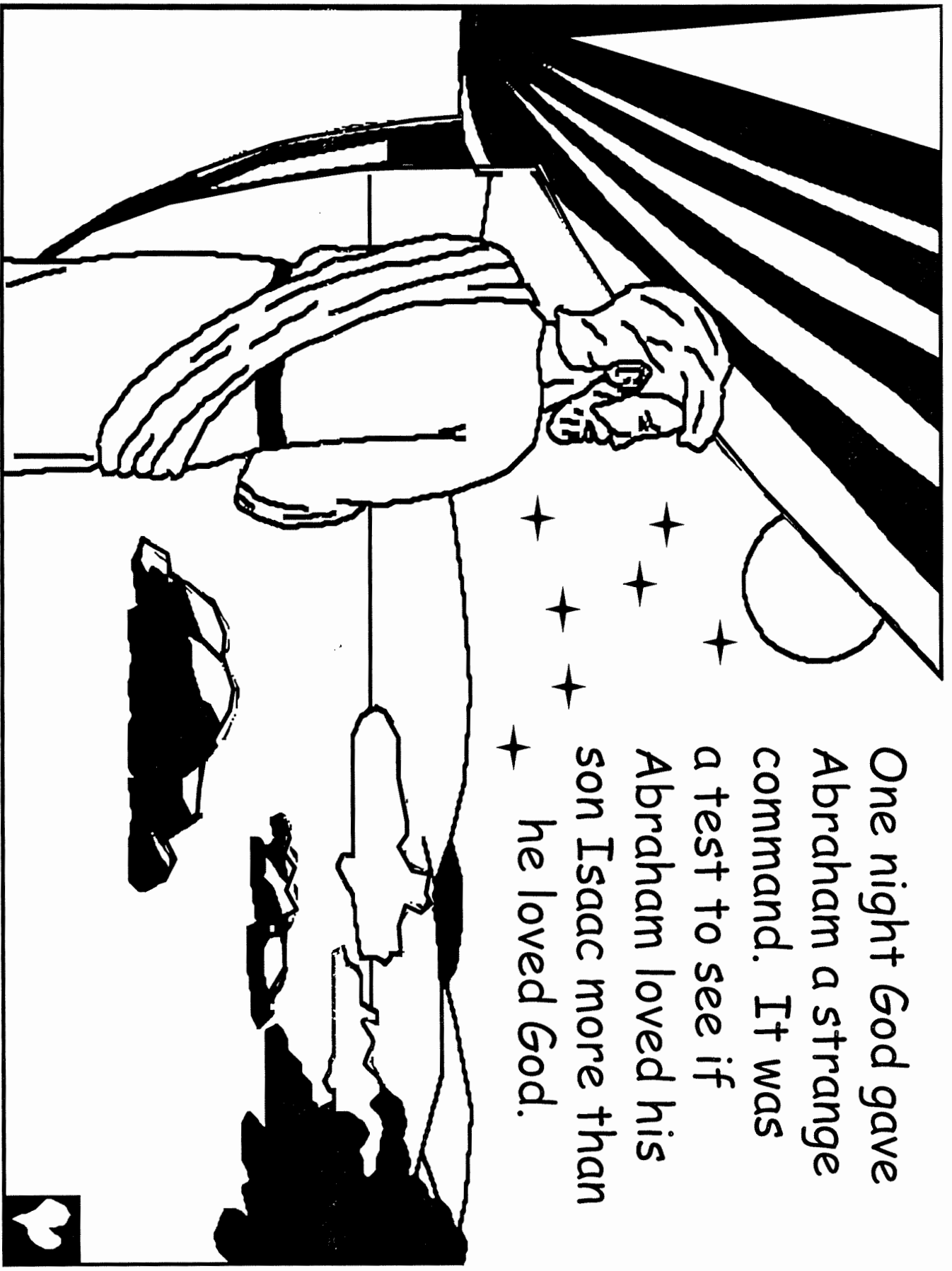

"Take your son Isaac, and offer him as a burnt offering," God commanded. Offer Isaac? Sacrifice his son? That was hard for Abraham. He loved his son very much.

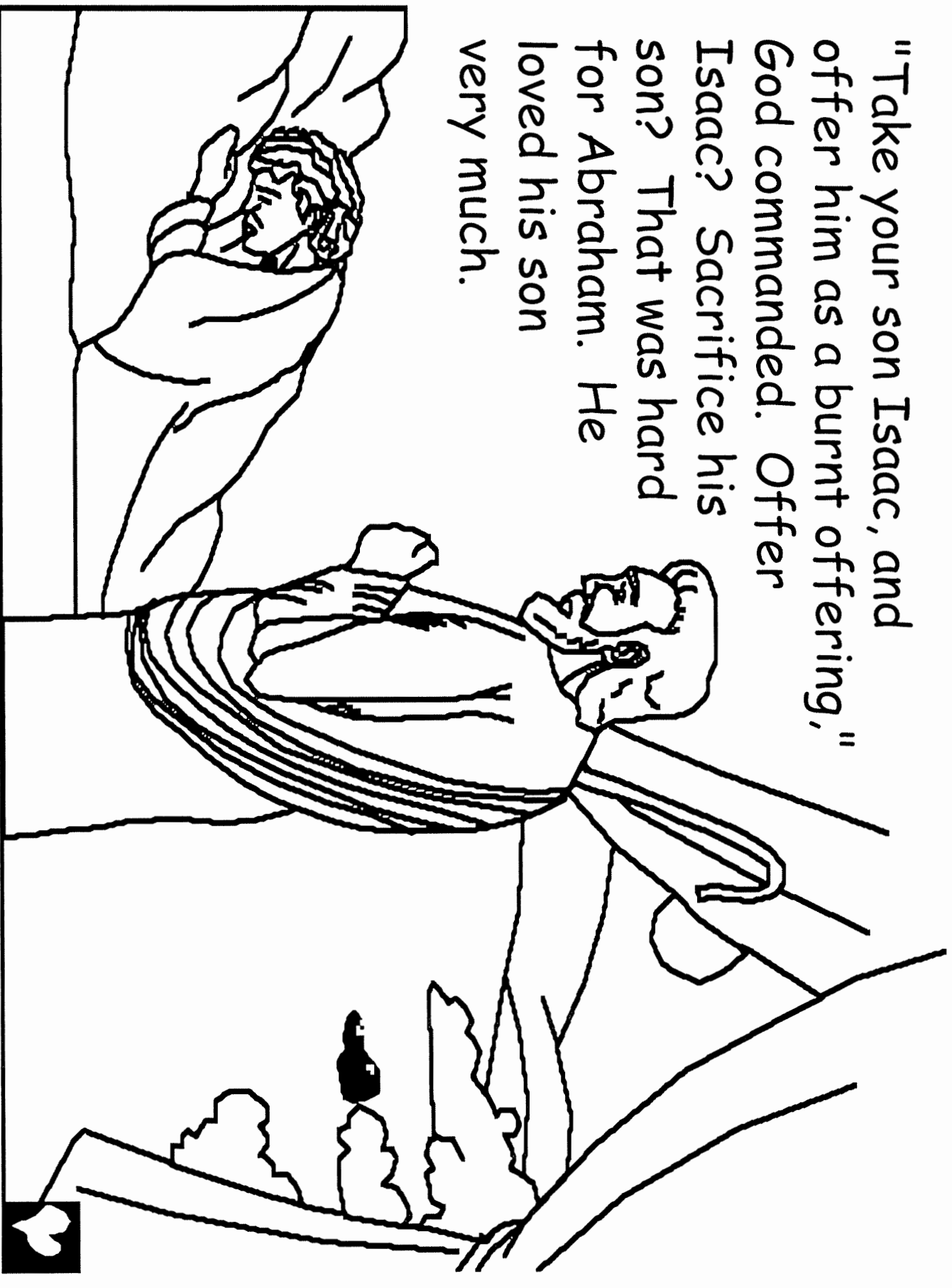

But Abraham had learned to trust  
God even when he did not understand.  
In the morning he set out  
for the mountain of sacrifice  
with Isaac and two servants.

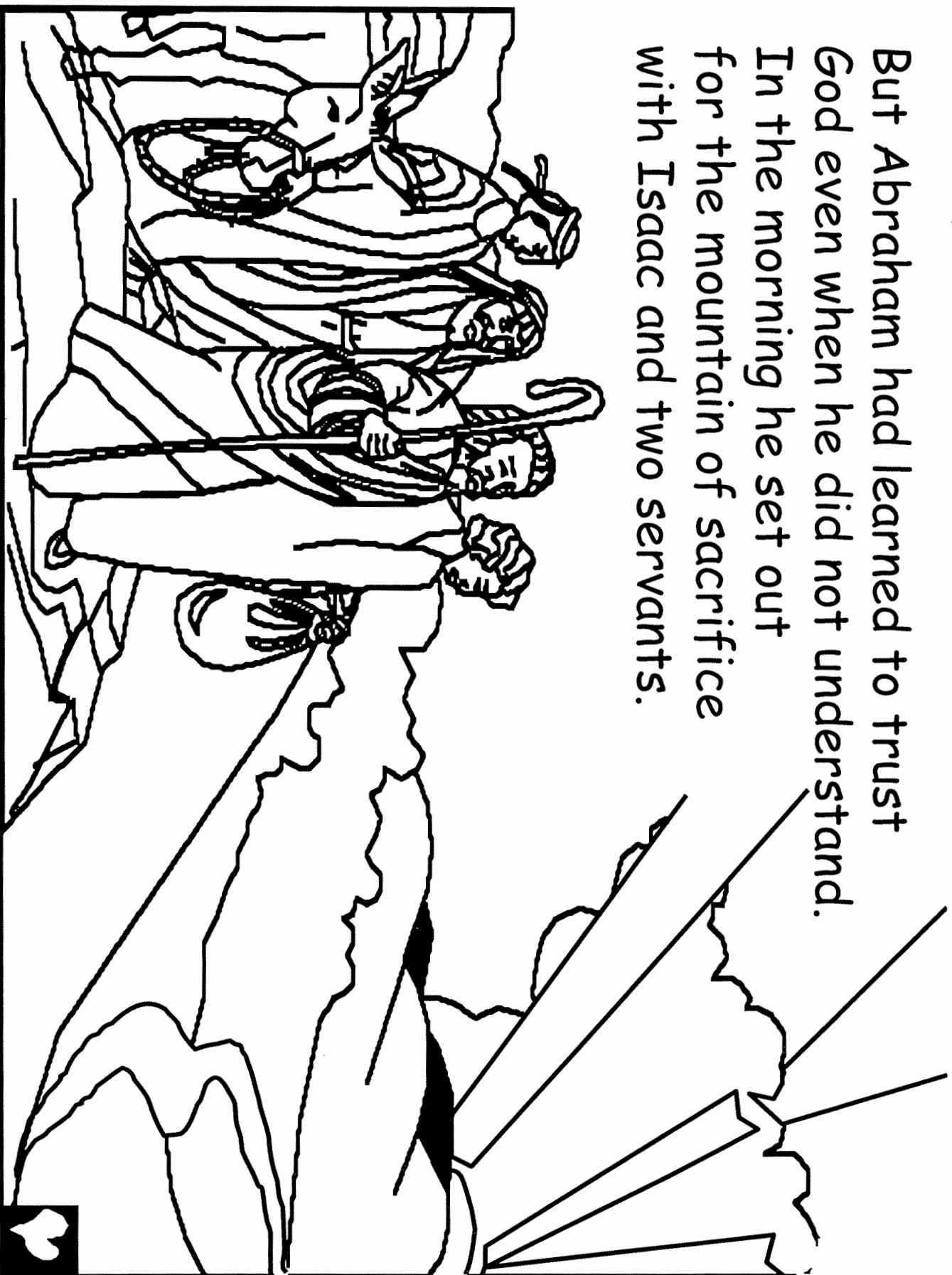

Before leaving,  
Abraham split pieces  
of wood to make a  
fire for the burnt  
offering. Abraham  
planned to obey God.



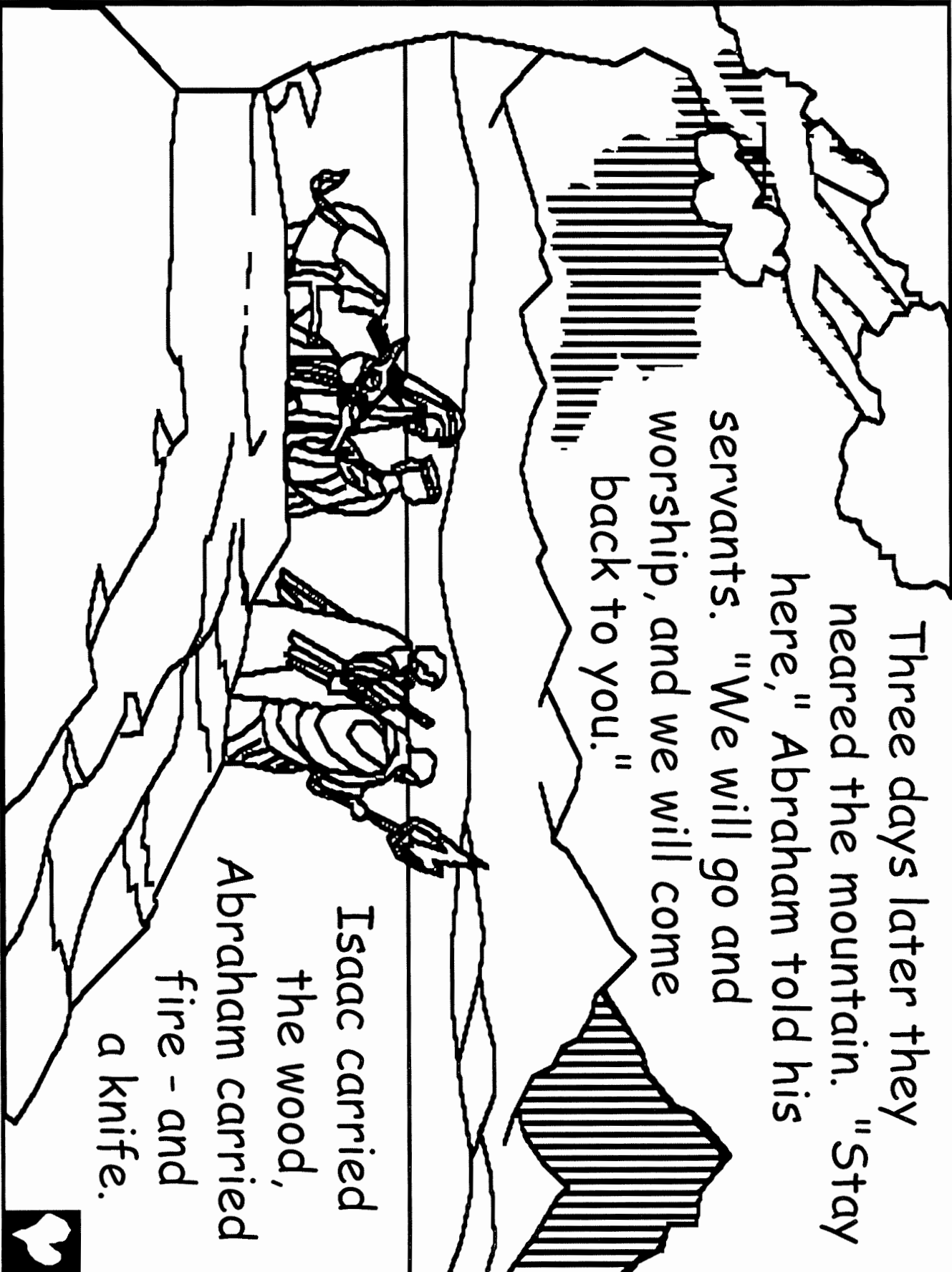

Three days later they  
neared the mountain. "Stay  
here," Abraham told his  
servants. "We will go and  
worship, and we will come  
back to you."

Isaac carried  
the wood,  
Abraham carried  
fire - and  
a knife.



"Where is the lamb for a burnt offering?" Isaac asked. "God will provide Himself a lamb," Abraham replied.

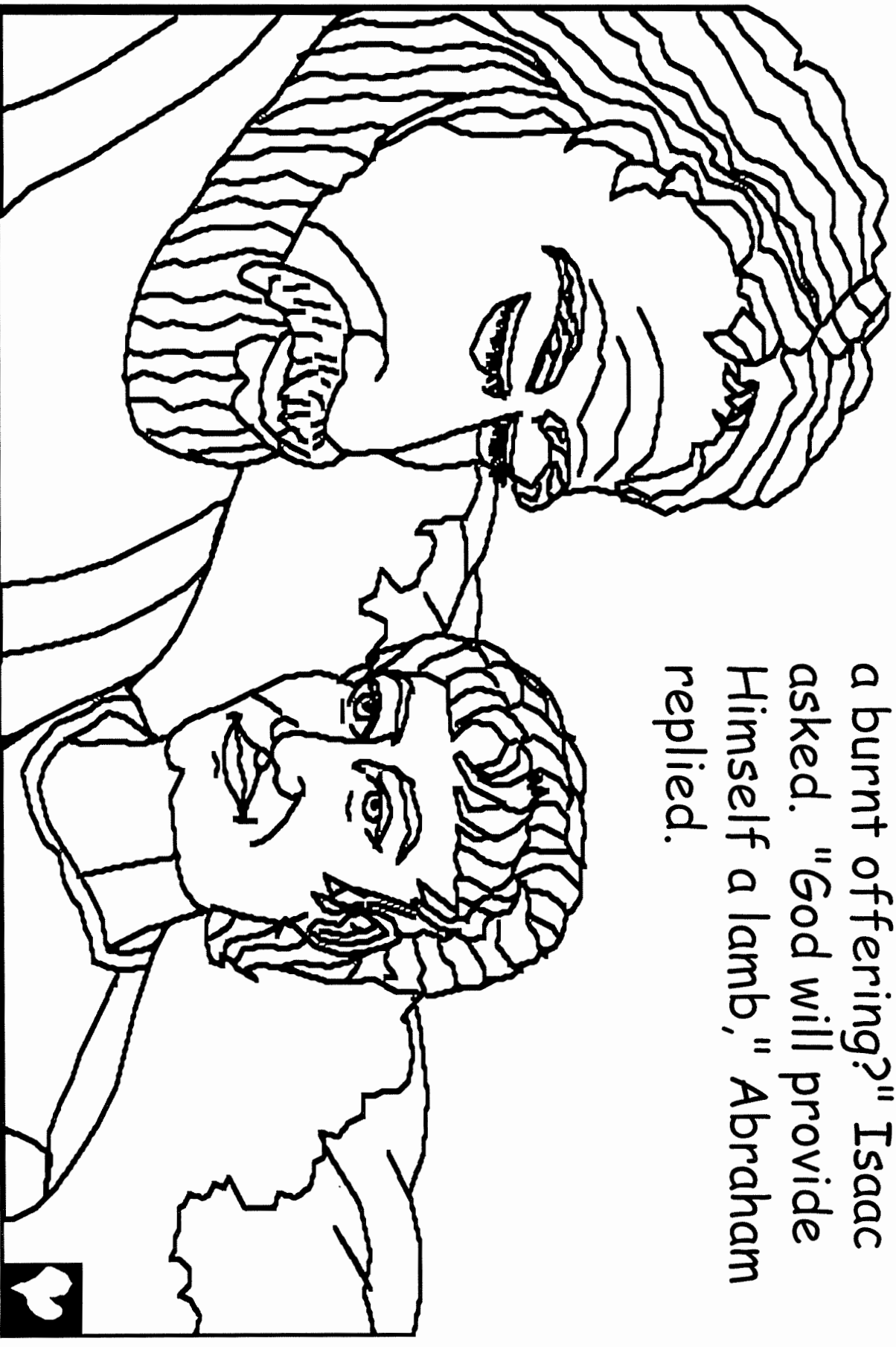



The two came to the exact place  
chosen by God. There, Abraham built  
an altar and arranged the wood to  
burn the sacrifice before God.  
Abraham had built many altars.  
Surely this one was the  
hardest ever to build.

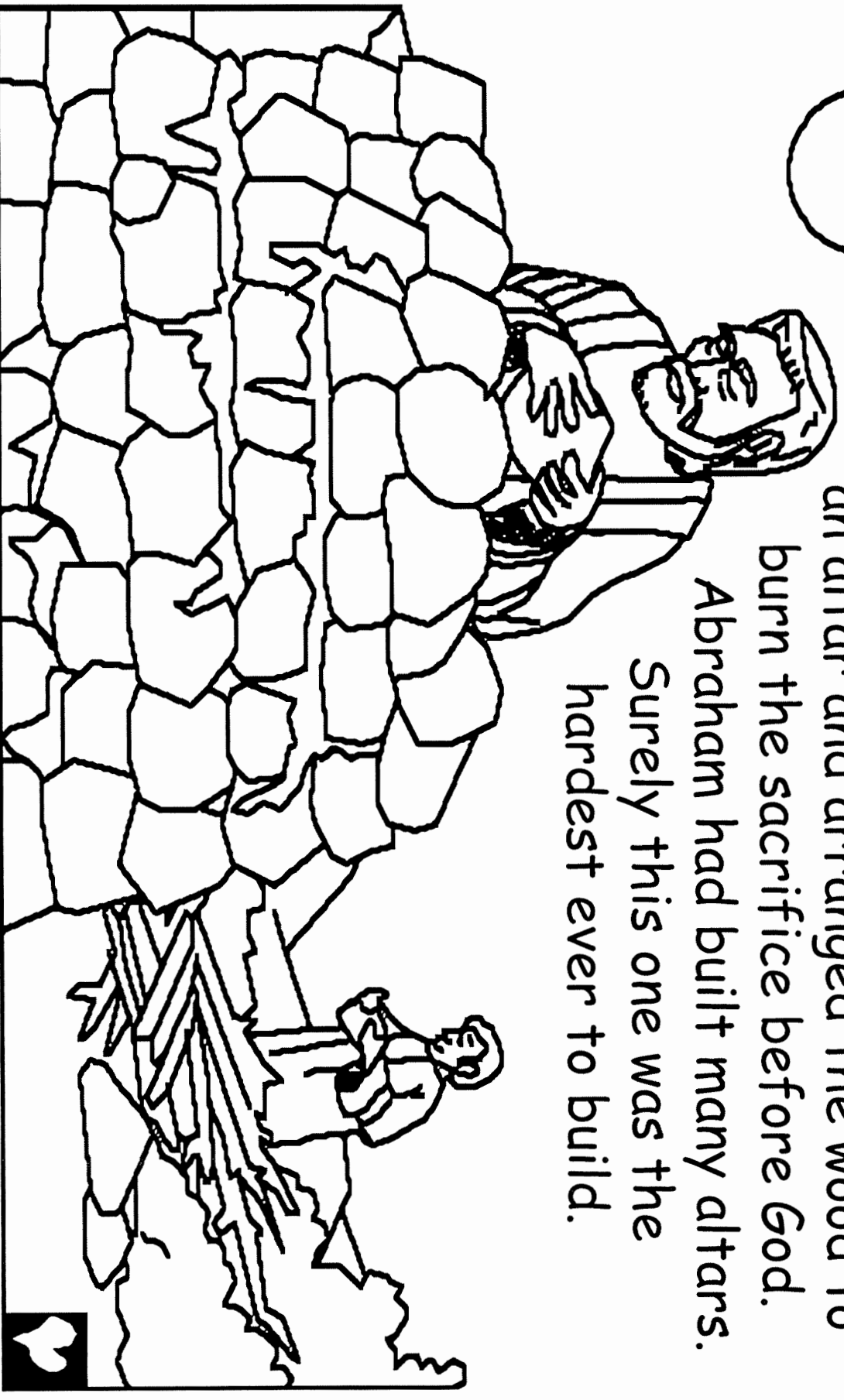
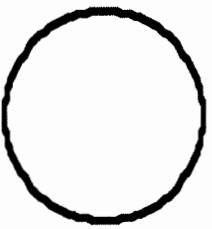

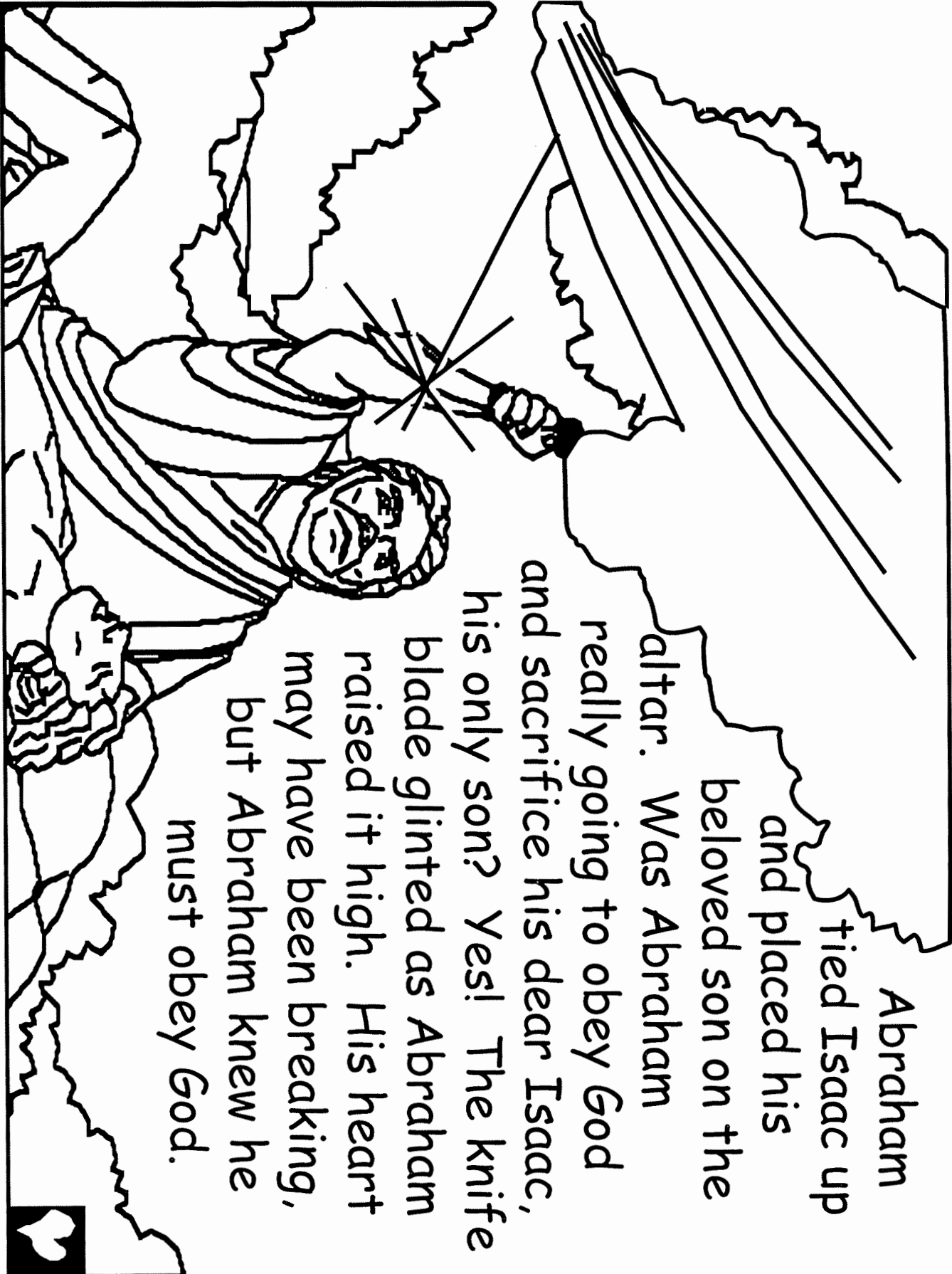

Abraham  
tied Isaac up  
and placed his  
beloved son on the  
altar. Was Abraham  
really going to obey God  
and sacrifice his dear Isaac,  
his only son? Yes! The knife  
blade glinted as Abraham  
raised it high. His heart  
may have been breaking,  
but Abraham knew he  
must obey God.



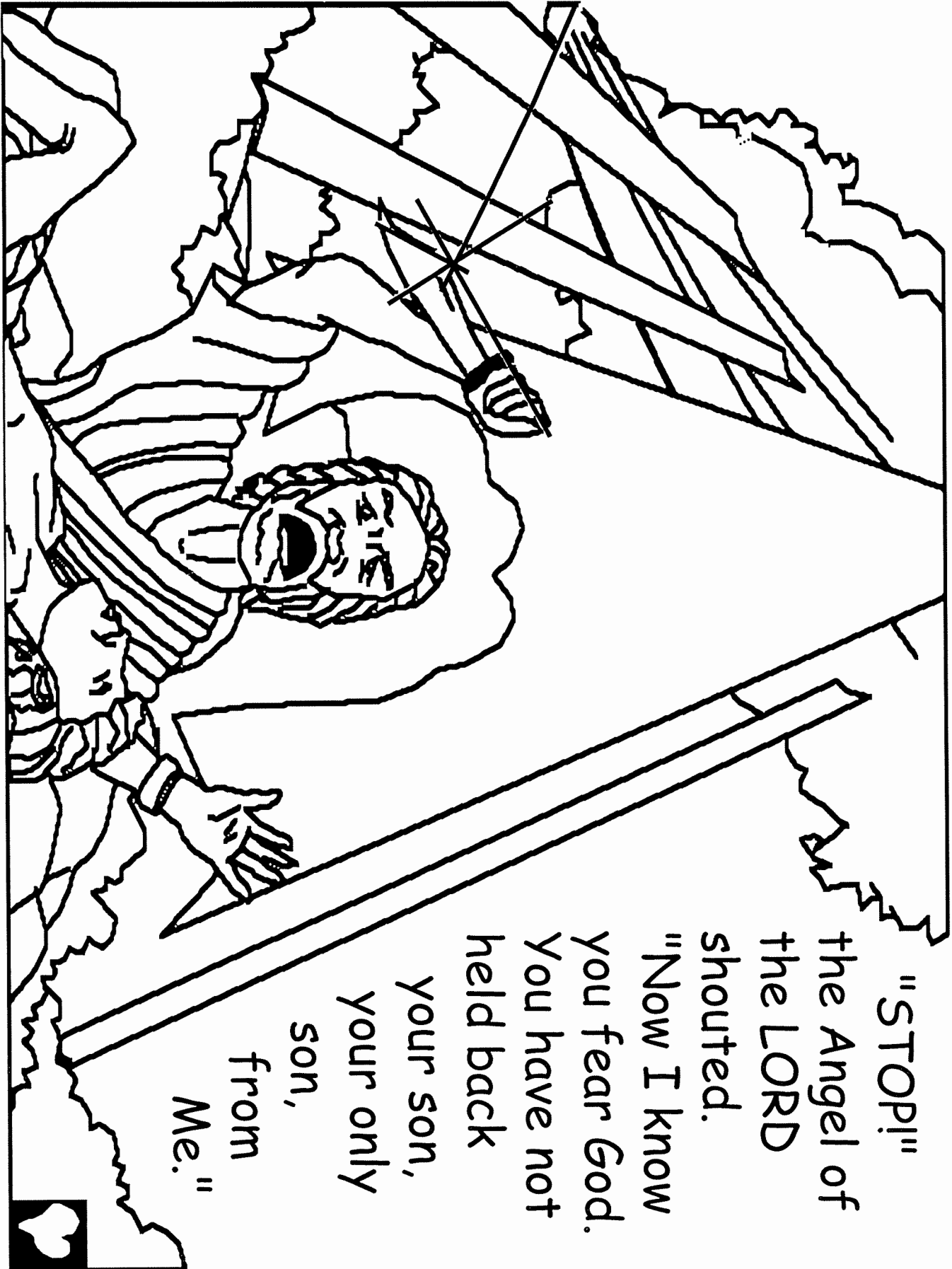

"STOP!"  
the Angel of  
the LORD  
shouted.

"Now I know  
you fear God.  
You have not  
held back  
your son,  
your only  
son,  
from  
Me."



Seeing a ram in the bushes,  
Abraham untied Isaac and  
sacrificed the ram instead.  
Perhaps Isaac thought,  
"God did provide, just  
as my father said."

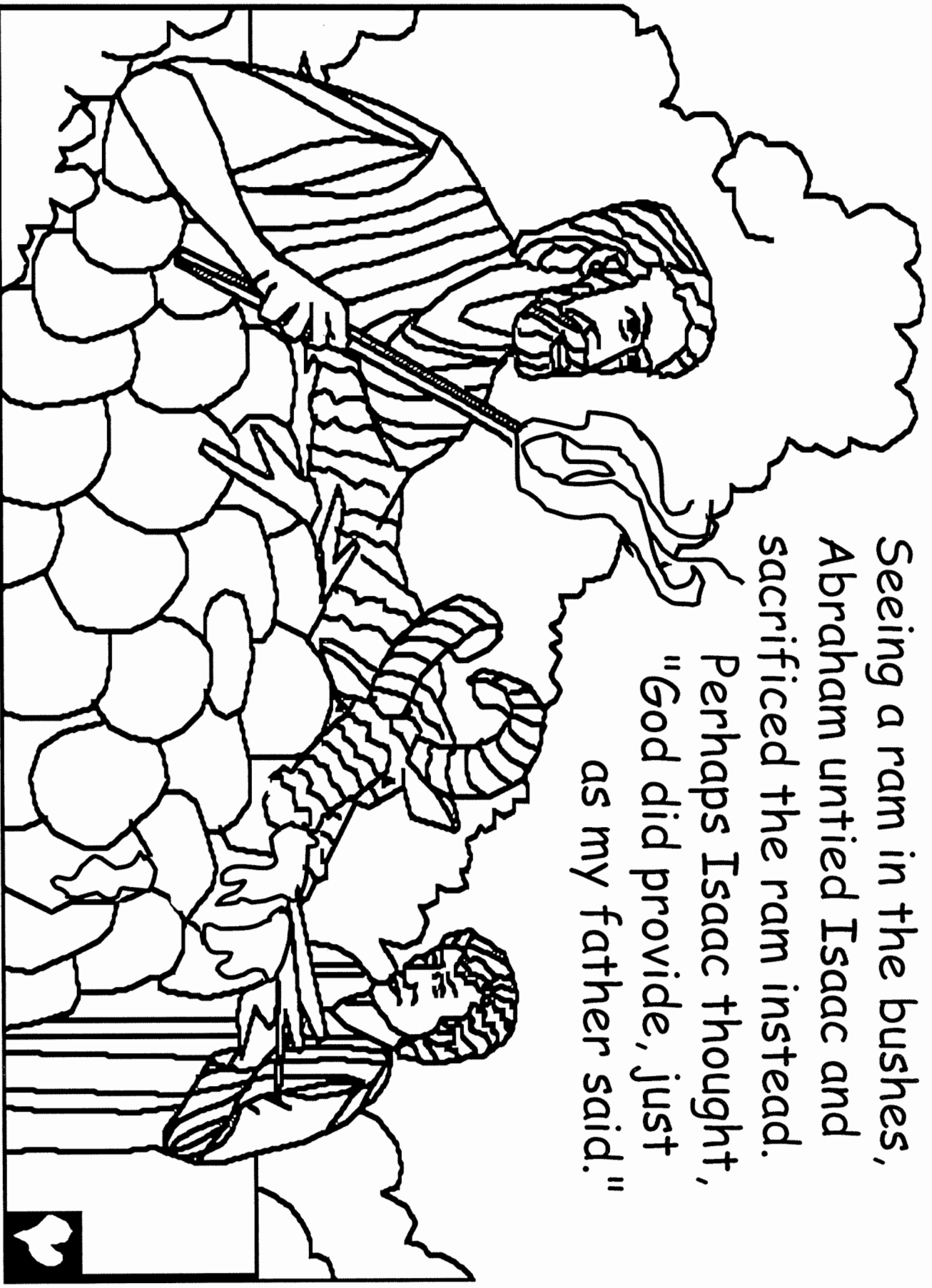

While father and son worshiped, the Angel of the LORD spoke to Abraham. "In your children, all nations shall be blessed because you obeyed." Someday, Jesus would be born through Abraham's descendants.

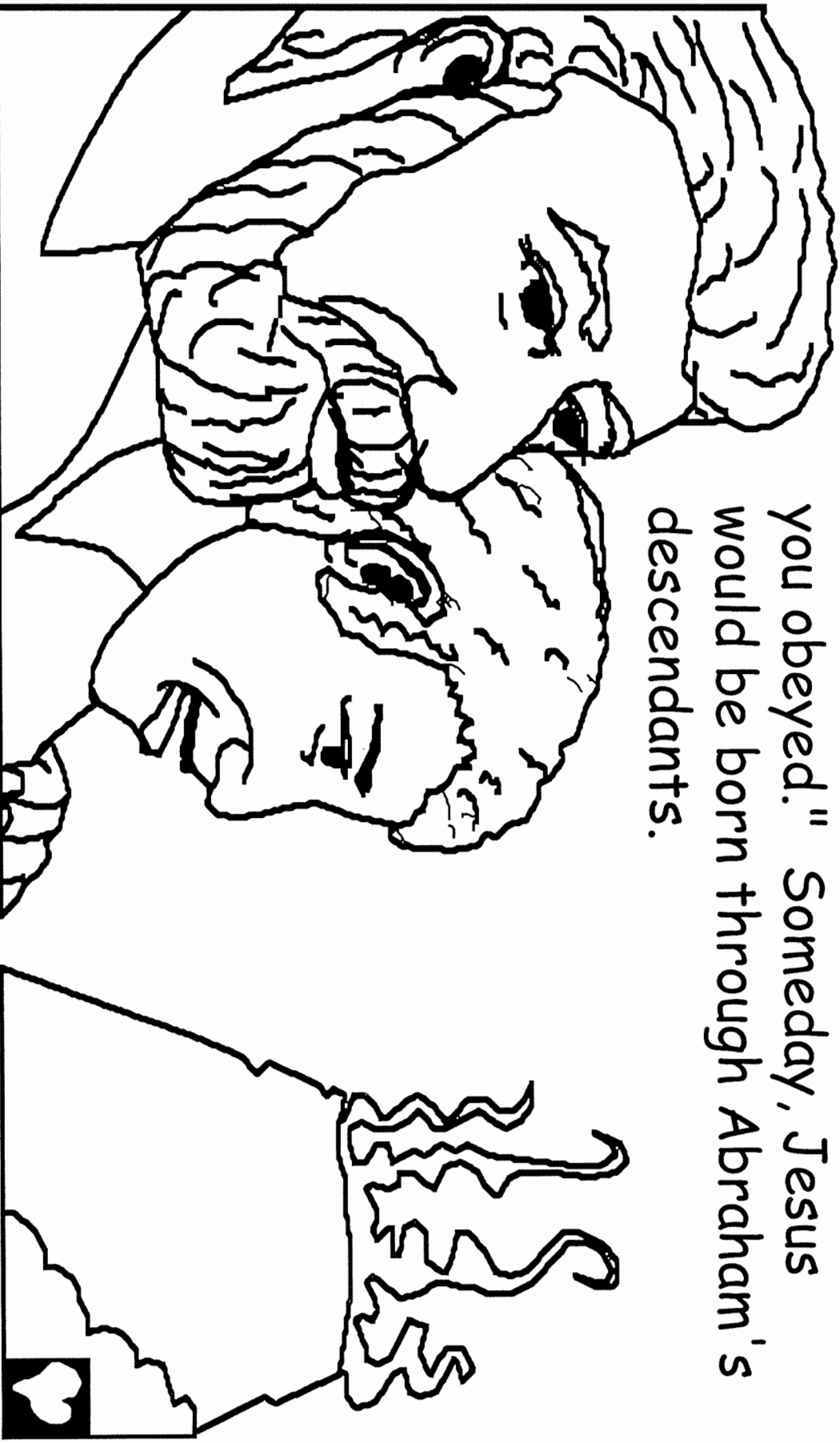

Abraham and Isaac returned home. Some time later, sadness came. Sarah died. Abraham had lost his wife, and Isaac had lost his mother.

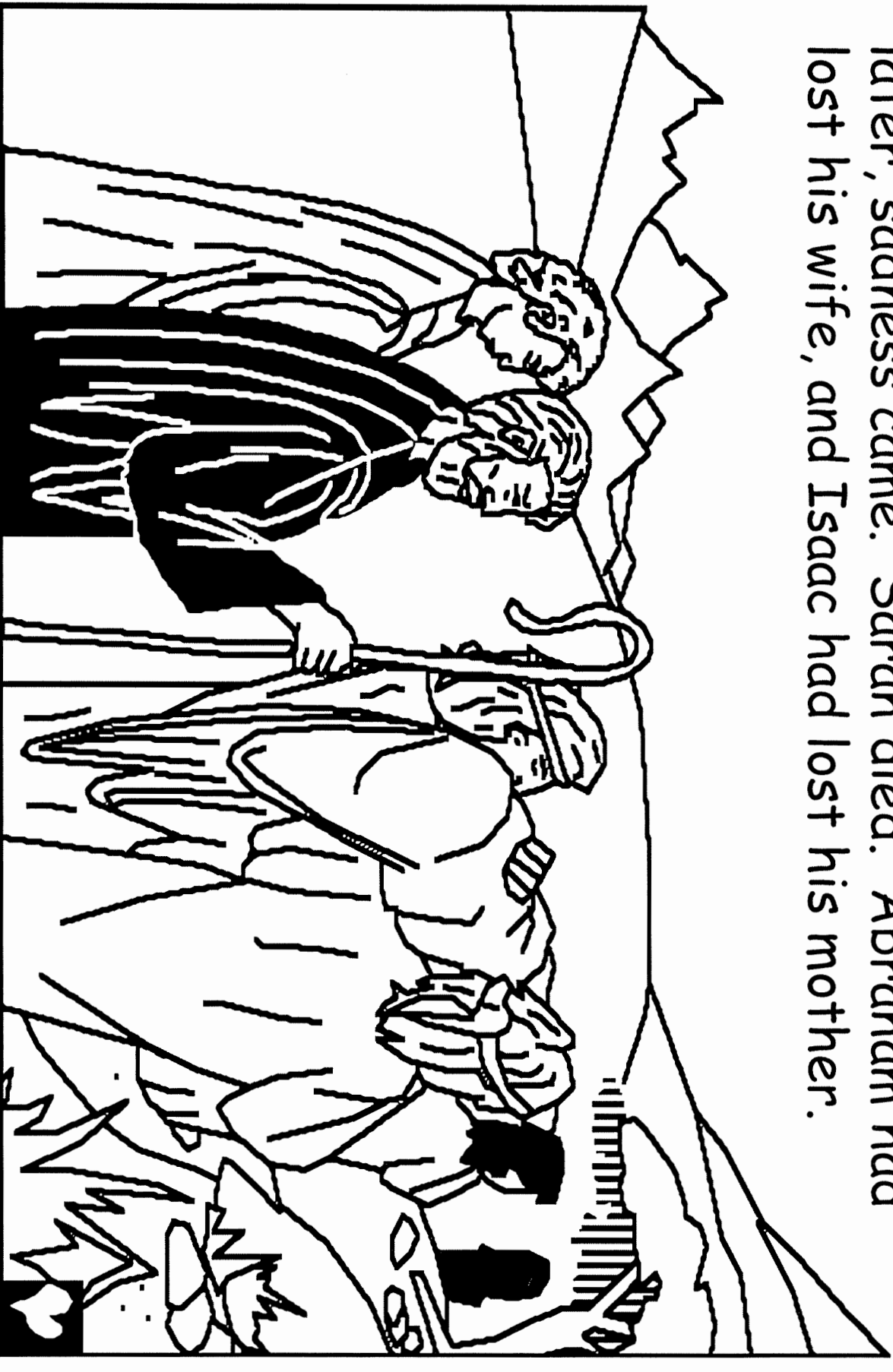

After the funeral,  
Abraham sent his chief  
servant to look for a wife  
for Isaac. The servant went to  
their old homeland to find a wife among

Abraham's relatives.

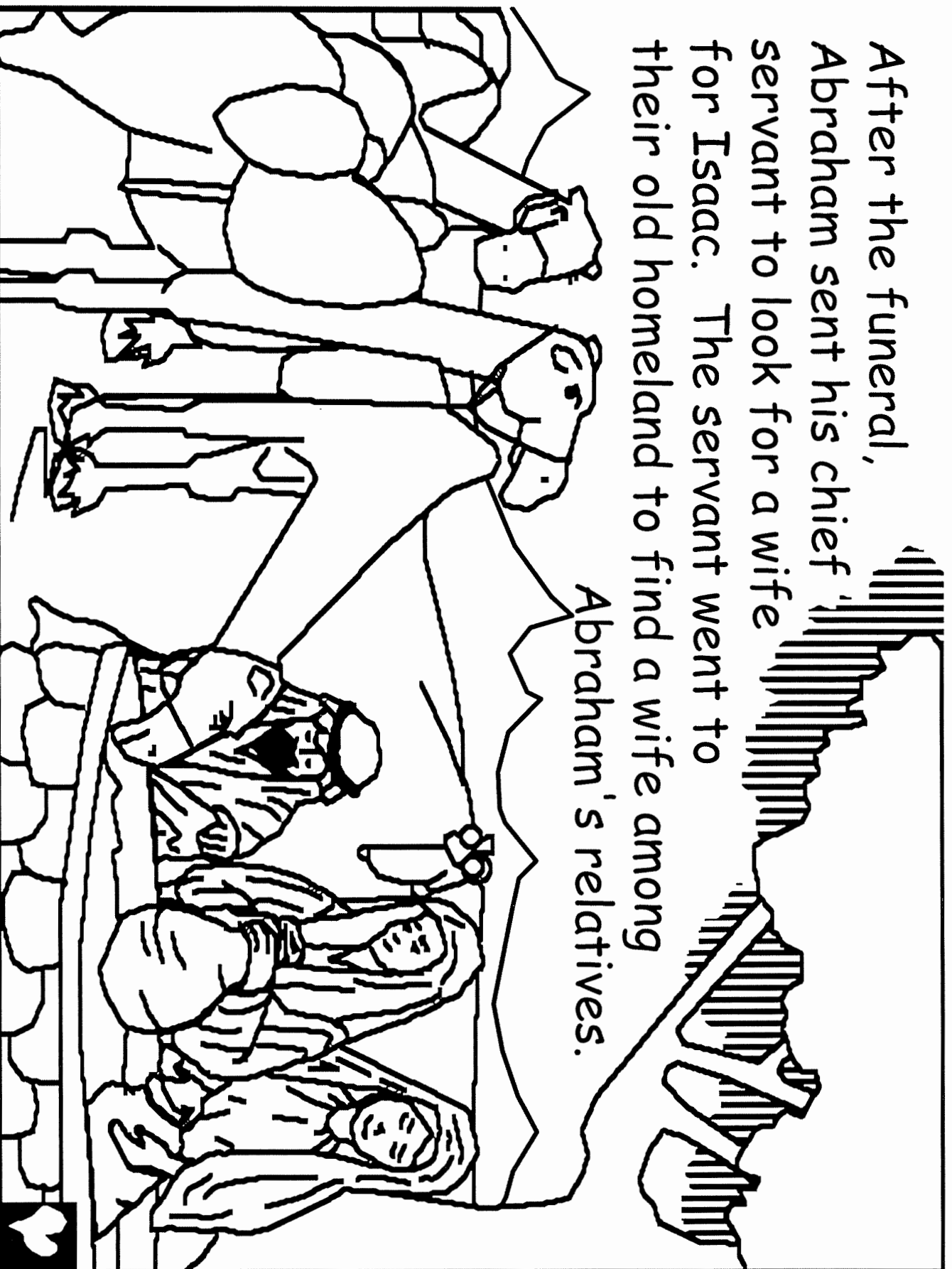

The servant asked God for a sign. "Let the girl who offers water for my camels be the right one for Isaac." Immediately Rebekah offered to give them water. She was one of Abraham's relatives. The servant knew God had answered his prayer.

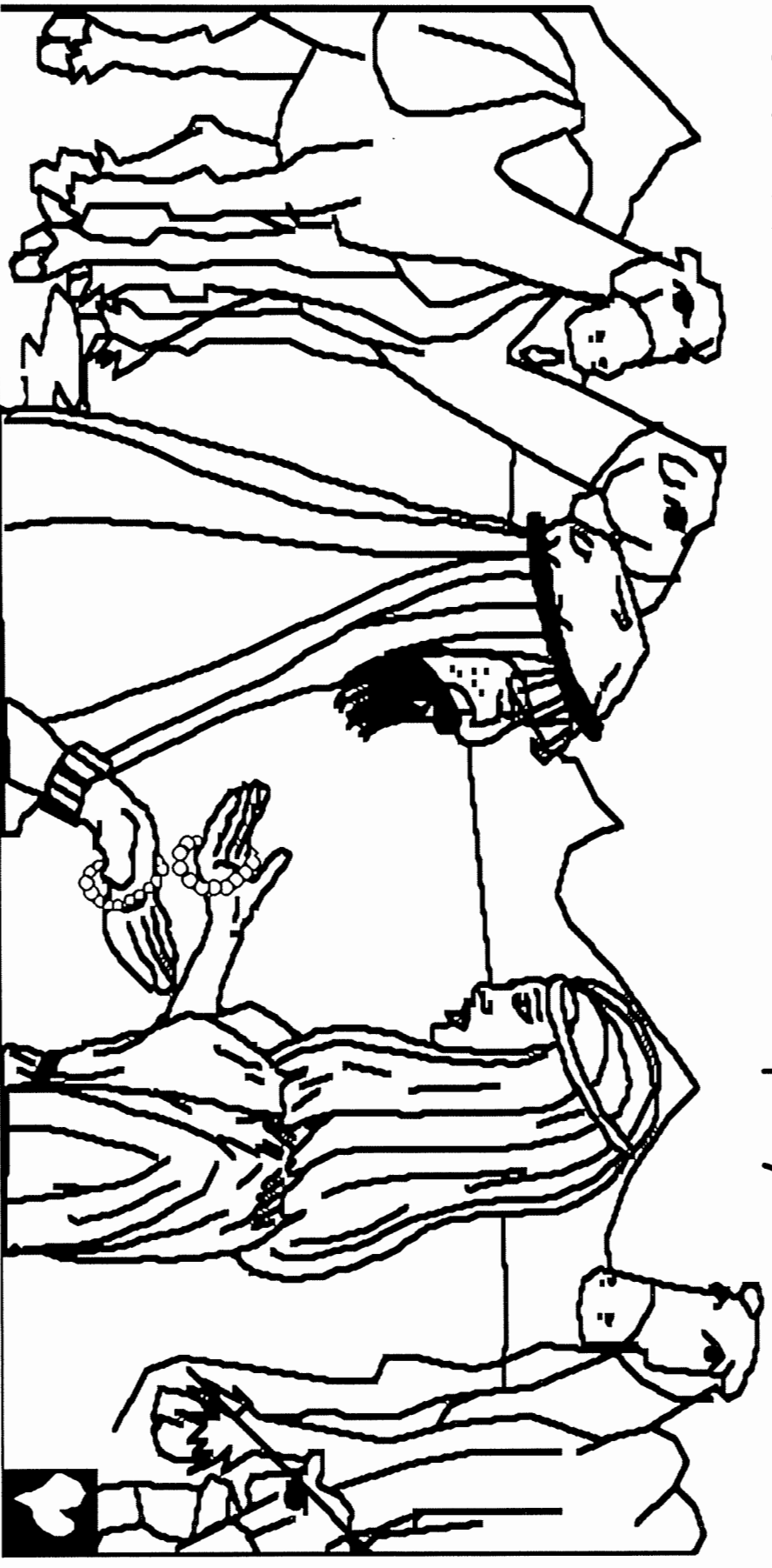



# Stop!

Abraham was going to follow God's command and offer his son, Isaac, as a burnt offering. Write the letter that comes after the letter given to see what an angel of the Lord said to Abraham. Read the story in Genesis 22:1-13.

"C N M N S K Z X Z G Z M C N M

S G D A N X," G D R Z H C. "C N M N S

C N Z M X S G H M F S N G H L. M N V H

J M N V S G Z S X N T E D Z Q F N C,

A D B Z T R D X N T G Z U D M N S

V H S G G D K C E Q N L L D X N T Q R N M,

X N T Q N M K X R N M."



**Year 1**

**Week 16**

## **A Wife for Isaac**

**Scriptures: Genesis 24**

**Key Verse: Gen. 24:67 Isaac brought her into the tent of his mother Sarah, and he married Rebekah. So she became his wife, and he loved her.**

### **Key Points:**

- 1. Abraham wanted Isaac to have a wife who also loved God.**
- 2. Abraham's servant prayed for a sign to find the right woman. He met Rebekah at the well, and the sign was fulfilled that she would also give the camels a drink.**
- 3. Rebekah was willing to leave her home to serve God. She left with her family's blessing because they recognized that this was from God.**
- 4. Isaac loved Rebekah, and was comforted after his mother's death.**



***Abraham sends his servant to meet  
Rebecca***





Rebecca draws water for the Abraham's servant and the camels



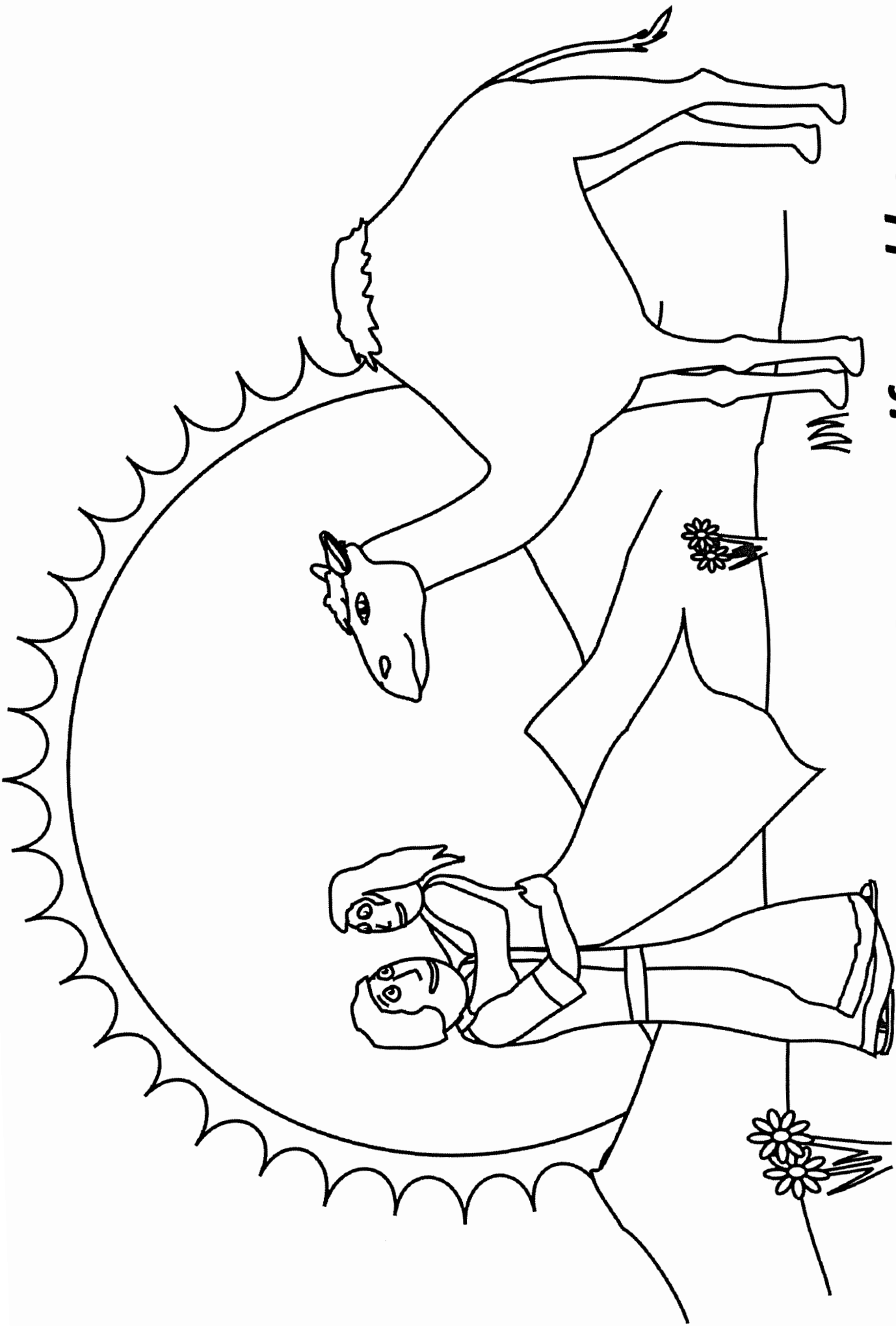

**Rebecca became Issacs wife and he  
loved her**



**Isaac Marries Rebekah**



# A BRIDE FOR ISAAC

(GENESIS 24:1-67)



“And let it come to pass, that the damsel to whom I shall say, Let down thy pitcher, I pray thee, that I may drink; and she shall say, Drink, and I will give thy camels drink also: *let the same be she that thou hast appointed for thy servant Isaac; and thereby shall I know that thou hast shewed kindness unto my master.*”

**GENESIS. 24:14**

# A Kind Girl

Who was the kind girl who gave water to Abraham's servant and his camels? Who agreed to become Isaac's wife? Use a light-colored crayon to color only the triangles. Then copy those letters into the triangles below to find her name. Then, if you have time, you may color the other shapes.

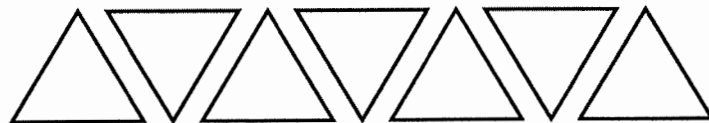
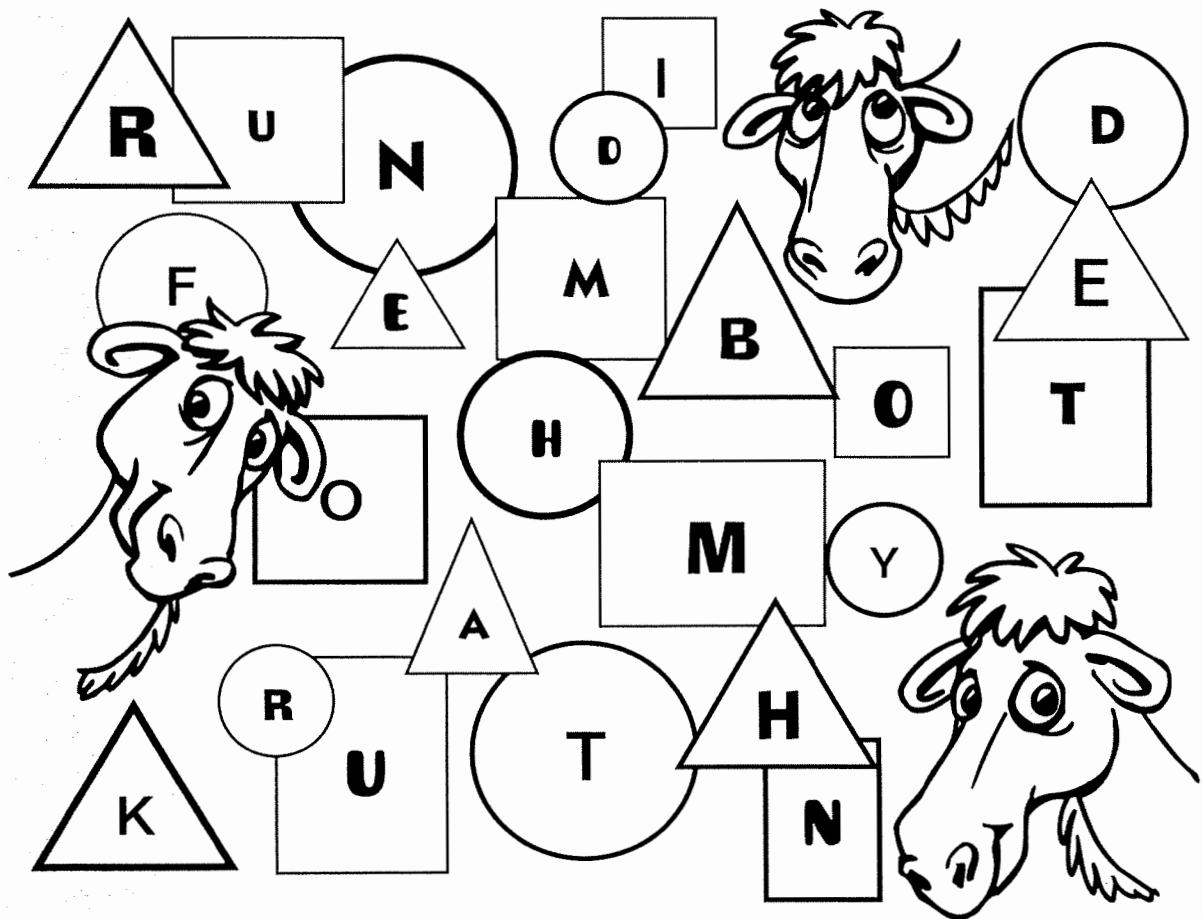

# A Wife for Isaac

Genesis 24

## Follow the Path to Find Rebekah

Abraham knew his son Isaac needed a wife. He sent his servant to find a girl to marry Isaac. Follow the path to see what happened. Then color the pictures.

Abraham asks his servant to find a wife for Isaac (1). The servant gets on his camel and rides to another country (2). The servant asks God to have the girl God wants to marry Isaac offer to water the servant's camel (3). Rebekah comes to the well and waters the camel (4). Rebekah and the servant return to their country (5) and Rebekah marries Isaac.

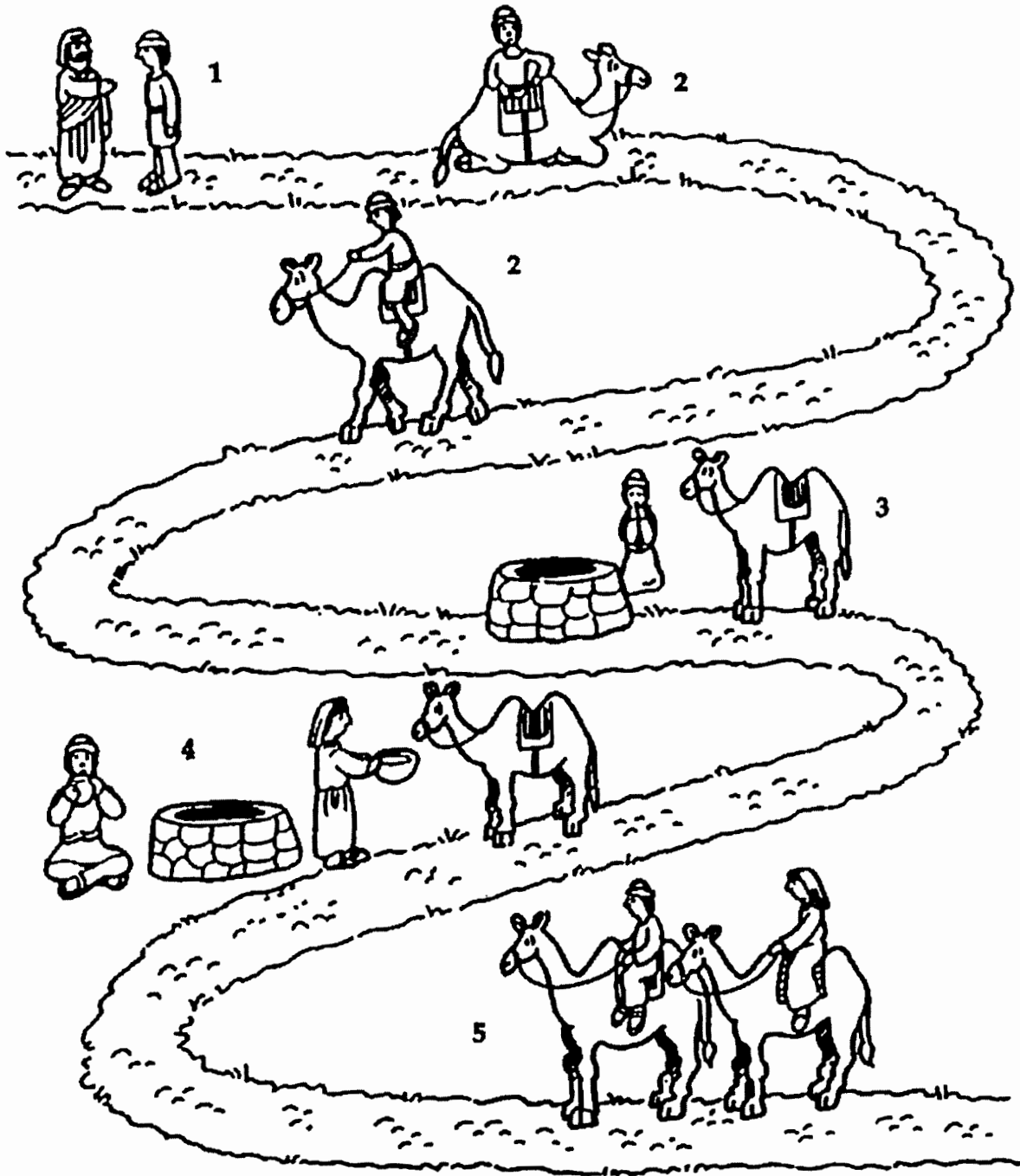

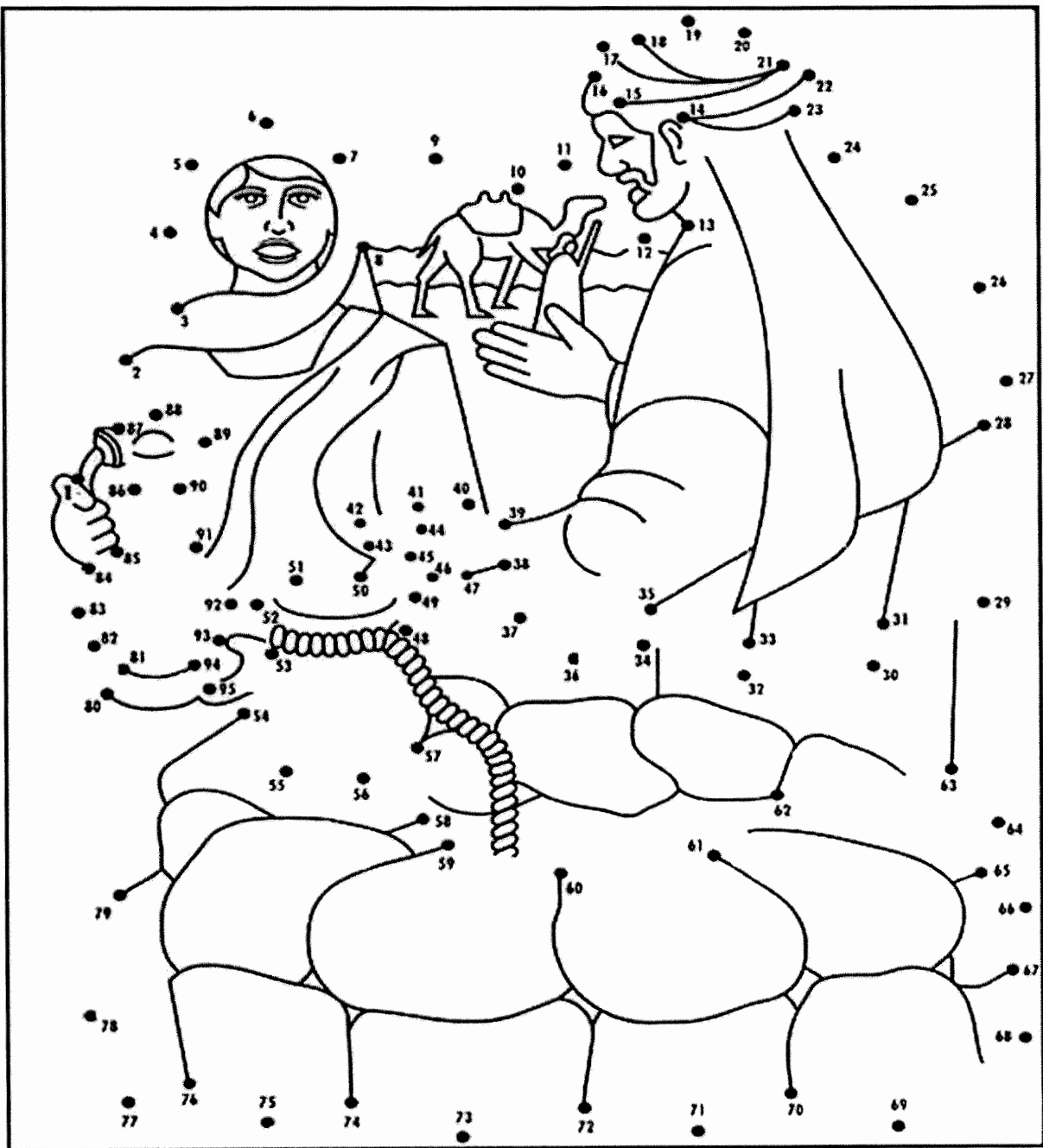

**Help  
Abraham's  
servant find  
his way to  
Abraham's  
homeland to  
find a bride  
for Isaac.**

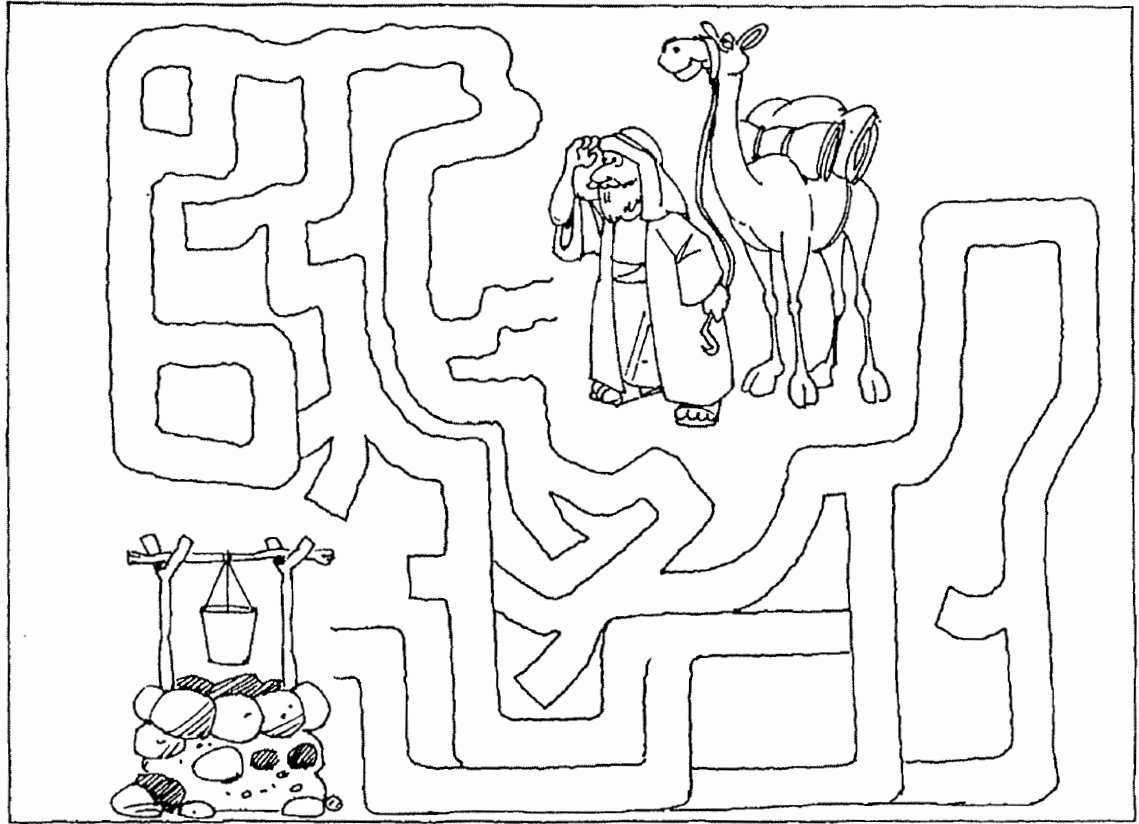

**When Isaac was old enough to get married,  
Abraham sent his servant back to his homeland to find a bride for Isaac.**

# Family Ties

Abraham's servant was sent to find a wife for Isaac. He found Rebekah, the granddaughter of Abraham's brother. Bethuel, Rebekah's father, told the servant to take Rebekah so that she could be the wife of his master's son. The last part of each word is at the top of the page. Finish each word with its correct ending to discover why Bethuel agreed to send his daughter to a strange land. Read the story in Genesis 24:32-52.



HE \_\_\_\_ I \_\_\_\_ REBE \_\_\_\_ ; TA \_\_\_\_

H \_\_\_\_ A \_\_\_\_ G \_\_\_\_, AN \_\_\_\_ L \_\_\_\_

HE \_\_\_\_ BE \_\_\_\_ T \_\_\_\_ WI \_\_\_\_

O \_\_\_\_ YO \_\_\_\_ MAS \_\_\_\_ , \_\_\_\_ S \_\_\_\_ ,

A \_\_\_\_ TH \_\_\_\_ LO \_\_\_\_ H \_\_\_\_

DIR \_\_\_\_ .



Br

Jacob  
what  
about

84-2
A
12+1
C
3X
E
4+
J
18-
:
37
+
22
(



Abraham's servant was sent to find a wife for Isaac. He found Rebekah, the granddaughter of Abraham's brother. Bethuel, Rebekah's father, told the servant to take Rebekah for the wife of his master's son. The last part of each word is at the bottom of the page. Finish each word with its correct ending to discover why Bethuel agreed to send his daughter to a strange land. Read the story in Genesis 24:32-52.

HE \_ \_ I \_ REBE \_ \_ \_ ; TA \_ \_

H \_ \_ A \_ \_ G \_ , AN \_ L \_ \_

HE \_ BE \_ \_ \_ \_ T \_ \_ WI \_ \_

O \_ YO \_ \_ MAS \_ \_ \_ ' S \_ \_ ,

A \_ TH \_ LO \_ \_ H \_ \_

DIR \_ \_ \_ \_ \_ .



## Isaac & Rebekah

1. Who did Abraham send to find a wife for Isaac?

**His oldest friend**



**His oldest servant**



**His youngest servant**



2. Who did the servant ask for a sign from?

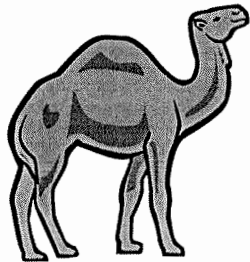

3. Who did Rebekah get the water for?

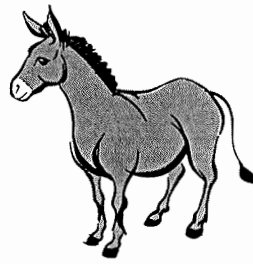
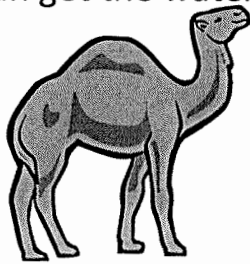

4. Where was Isaac the first time he saw Rebekah?

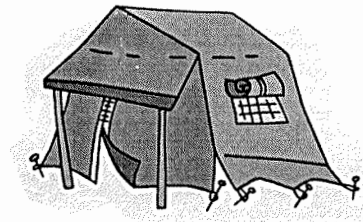
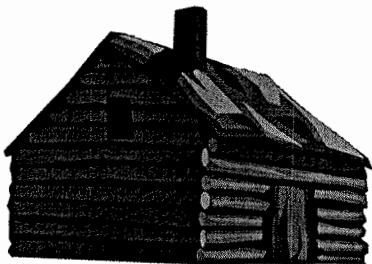

5. How did Isaac feel about Rebekah?

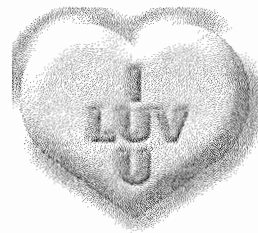





# Bible Pathway Adventures

BIBLE QUIZ

## ISAAC & REBEKAH

Match the question with the  
answer on the right.

### QUESTIONS

- \_\_\_ Who was the father of Isaac?
- \_\_\_ How old was Sarah when Isaac was born?
- \_\_\_ Where did Abraham send his servant to find a wife for Isaac?
- \_\_\_ How many camels did the servant take with him?
- \_\_\_ Where did the servant find Rebekah?
- \_\_\_ What jewelry did the servant give Rebekah?
- \_\_\_ What did Rebekah do when she first saw Isaac?
- \_\_\_ How old was Isaac when he married Rebekah?
- \_\_\_ What were the names of Isaac and Rebekah's two sons?
- \_\_\_ To which land did Yahweh send Abraham to sacrifice Isaac?

### ANSWERS

1. Mesopotamia
2. By a spring
3. A gold ring and two bracelets
4. Covered herself with a veil
5. Moriah
6. 40 years old
7. Ten
8. 90 years old
9. Abraham
10. Jacob and Esau



FOR MORE FREE BIBLE RESOURCES AND TEACHER PACKS INCLUDING COLORING PAGES,  
WORKSHEETS, QUIZZES AND MORE VISIT OUR WEBSITE AT:  
[WWW.BIBLEPATHWAYADVENTURES.COM](http://WWW.BIBLEPATHWAYADVENTURES.COM)

Abraham wanted his son, Isaac, to marry. Abraham sent his servant to his homeland to find Isaac a wife. Learn more about this story by writing the letter that follows the one given under each line. ("a" follows "z") Then go through the maze to take Rebekah to meet Isaac.

Abraham told his chief                                                 , "Go to Nahor. Get a  
r d q u z m s  
                            for Isaac. God will help you find                     ." The servant took  
v h e d n m d  
                     camels and many gifts on the long trip. He came to a                              
s d m v d k k  
at Nahor. He prayed, "Lord, show me the                             woman." Rebekah  
q h f g s  
                            along. She gave                                    to the servant and his camels.  
b z l d v z s d q  
The servant went                             with her.                      showed that Rebekah  
g n l d F n c  
should be Isaac's                                   . The servant took her to Isaac.  
a q h c d

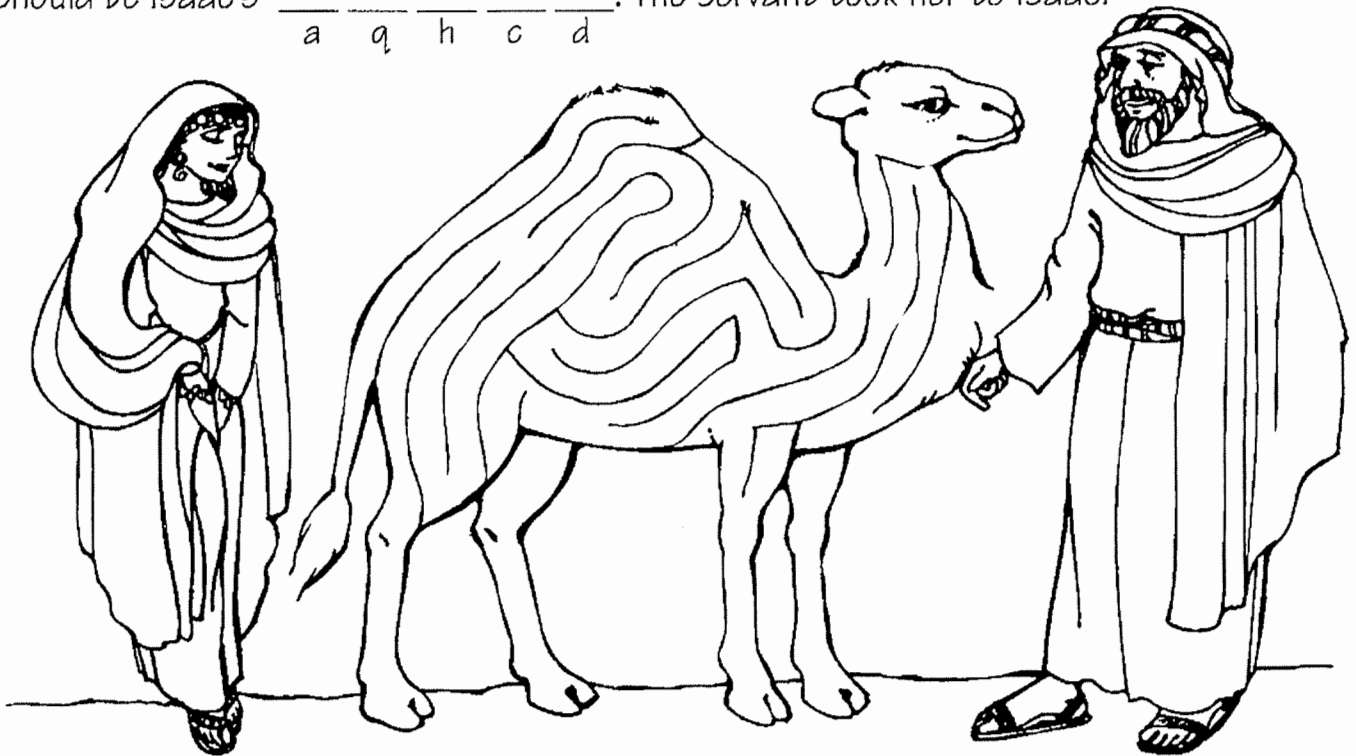

God answered the servant's prayer. He will answer your prayers in the way that is best for you. Do you pray every day?

## ISAAC AND REBEKAH

*Genesis 24:1-28*

# A Bride for Isaac

Isaac brought her into the tent of his mother Sarah, and he married Rebekah. So she became his wife, and he loved her.  
Genesis 24:67

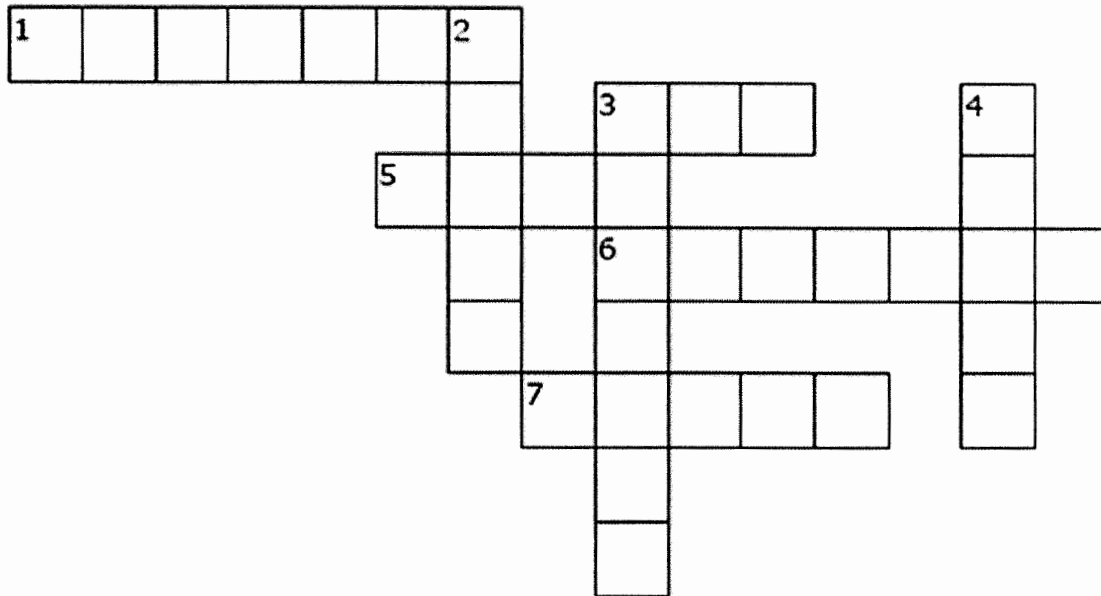

## ACROSS

1. To be united as husband and wife
3. A male human offspring
5. A man's partner in marriage
6. The wife of Isaac
7. A large animal used for transportation in the desert

## DOWN

2. To take liquid into the mouth and swallow it
3. A person who works for another person
4. The son of Abraham

REBEKAH  
DRINK

MARRIED  
SON

SERVANT  
CAMEL

ISAAC  
WIFE

# A Bride for Isaac

Isaac brought her into the tent of his mother Sarah, and he married Rebekah. So she became his wife, and he loved her.  
Genesis 24:67



L O W I S A A C F F T E S S I  
 F K Q U M A I D E N A P F H W  
 N S E C A M E L S Q N M U Z P  
 S E B D T T K U K G W W I Y X  
 I R H B L N H E N R J A K L X  
 D V B G I E K I K D W T L W Y  
 G A O R P C R N W S W E Q D M  
 K N D A N P E G I B P R E A H  
 G T Z D S S S H F E G I H A R  
 S D Y E O N T C E Z R A K P S  
 G O T H A F G E Q R R E V D O  
 M Z C K Z X H B A B B S T T N  
 X R K F F R V M A E A Y L C Y  
 L J H Q P L U F R Z L N Y K M  
 O W E A L T H Y M T O F F X P

FAMILY	WIFE	MARRIED	CAMELS	SERVANT
DRINK	ABRAHAM	WEALTHY	SPRING	MAIDEN
WATER	SON	CHOSEN	ISAAC	REBEKAH

# A BRIDE FOR ISAAC

## (GENESIS 24:1-67)

### MEMORY VERSE:

*"And as the bridegroom rejoices over the bride, so shall your God rejoice over you."*  
ISAIAH 62:5

### CIRCLE THE CORRECT WORDS:

1. "Abraham said to the oldest servant of his house, who ruled over all that he had, 'Please put your hand under my thigh, and I will make you swear by the LORD, the God of heaven and the God of the earth, that you will not take a wife for my son from the daughters of the Canaanites, among whom I dwell; but you shall go to my (COUNTRY, STORE) and to my (KINGDOM, KINDRED) and take a wife for my son Isaac.' " GENESIS 24:2-4
2. Abraham said, "The LORD God of heaven, who took me from my father's house and from the land of my kindred, and who spoke to me and swore to me, saying, 'To your descendants I give this land,' He will send His angel before you, and you shall take a (CHARIOT, WIFE) for my son from there." GENESIS 24:7
3. "The servant took ten of his master's camels and departed, for all his master's goods were in his hand. And he arose and went to (EGYPT, MESOPOTAMIA), to the city of Nahor." GENESIS 24:10
4. "And he made his camels kneel down outside the city by a (LAKE, WELL) of water at evening time, the time when women go out to draw water. Then he said, 'O LORD God of my master Abraham, please give me success this day, and show kindness to my master Abraham.'" GENESIS 24:11-12

### FILL IN THE BLANKS:

5. He also said, "Now let it be that the young woman to whom I say, 'Please let down your pitcher that I may \_\_\_\_\_,' and she says, '\_\_\_\_\_', and I will also give your camels a \_\_\_\_\_' - let her be the one whom You have appointed for Your servant Isaac." GENESIS 24:14

### CIRCLE THE CORRECT WORDS:

6. "And it happened, (BEFORE, AFTER) he had finished speaking, that behold, Rebekah, who was born to Bethuel, son of Milcah, the wife of Nahor, Abraham's brother, came out with her pitcher on her shoulder...And when she had finished giving him a drink, she said, 'I (WILL, WILL NOT) draw water for your camels also, until they have finished drinking.'" GENESIS 24:15, 19
7. "Then the man bowed down his head and (WORSHIPED, CRIED TO) the LORD." GENESIS 24:26
8. "So the young woman (WALKED, RAN) and told those of her mother's house these things." GENESIS 24:28
9. "Then they called Rebekah and said to her, 'Will you go with this man?' And she said, 'I (WILL, WILL NOT) go.'" GENESIS 24:58
10. "Now Isaac went out to meditate in the field in the evening; and he (LIFTED, RUBBED) his eyes and looked, and there, the camels were coming. Then Rebekah (LIFTED, RUBBED) her eyes, and when she saw Isaac she dismounted from her camel." GENESIS 24:63-64

THEN ISAAC "TOOK REBEKAH AND SHE BECAME HIS WIFE, AND HE LOVED HER." GENESIS 24:67

# A BRIDE FOR ISAAC

## (GENESIS 24:1-67)

### MEMORY VERSE:

*"And as the bridegroom rejoices over the bride, so shall your God rejoice over you."*  
ISAIAH 62:5

### FILL IN THE BLANKS:

1. "Abraham said to the oldest servant of his house, who ruled over all that he had, 'Please put your hand under my thigh, and I will make you swear by the LORD, the God of heaven and the God of the earth, that you will not take a wife for my son from the daughters of the Canaanites, among whom I dwell; but you shall go to my \_\_\_\_\_ and to my \_\_\_\_\_ and take a wife for my son Isaac.'" **GENESIS 24:2-4**
2. Abraham said, "The LORD God of heaven, who took me from my father's house and from the land of my kindred, and who spoke to me and swore to me, saying, 'To your descendants I give this land,' He will send His angel before you, and you shall take a \_\_\_\_\_ for my son from there." **GENESIS. 24:7**
3. "The servant took ten of his master's camels and departed, for all his master's goods were in his hand. And he arose and went to \_\_\_\_\_, to the city of Nahor." **GENESIS 24:10**
4. "And he made his camels kneel down outside the city by a \_\_\_\_\_ of water at evening time, the time when women go out to draw water. Then he said, 'O LORD God of my master Abraham, please give me success this day, and show kindness to my master Abraham.'" **GENESIS 24:11-12**
5. He also said, "Now let it be that the young woman to whom I say, 'Please let down your pitcher that I may \_\_\_\_\_,' and she says, '\_\_\_\_\_', and I will also give your camels a \_\_\_\_\_' - let her be the one whom You have appointed for Your servant Isaac." **GENESIS. 24:14**

### CIRCLE THE CORRECT WORDS:

6. "And it happened, (**BEFORE, AFTER**) he had finished speaking, that behold, Rebekah, who was born to Bethuel, son of Milcah, the wife of Nahor, Abraham's brother, came out with her pitcher on her shoulder...And when she had finished giving him a drink, she said, 'I (**WILL, WILL NOT**) draw water for your camels also, until they have finished drinking.'" **GENESIS 24:15, 19**
7. "Then the man bowed down his head and (**WORSHIPED, CRIED TO**) the LORD." **GENESIS 24:26**
8. "So the young woman (**WALKED, RAN**) and told those of her mother's house these things." **GENESIS. 24:28**

### FILL IN THE BLANKS:

9. "Then they called Rebekah and said to her, 'Will you go with this man?' And she said, 'I \_\_\_\_\_go.'" **GENESIS 24:58**
10. "Now Isaac went out to meditate in the field in the evening; and he \_\_\_\_\_ his eyes and looked, and there, the camels were coming. Then Rebekah \_\_\_\_\_ her eyes, and when she saw Isaac she dismounted from her camel." **GENESIS 24:63-64**

**THEN ISAAC "TOOK REBEKAH AND SHE BECAME HIS WIFE, AND HE LOVED HER." GENESIS 24:67**



# A BRIDE FOR ISAAC

## (GENESIS 24:1-67)

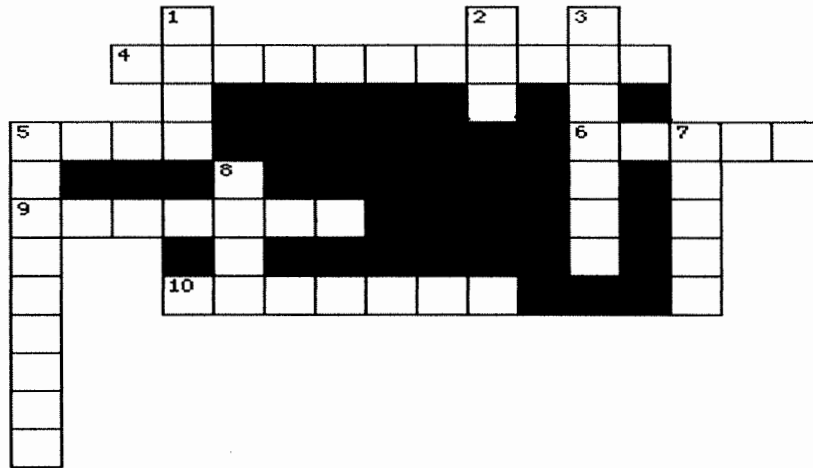

- 9 ACROSS "And as the bridegroom rejoices over the bride, so shall your God \_\_\_\_\_ over you." **ISAIAH 62:5**
- 3 DOWN "Abraham said to the oldest servant of his house, who ruled over all that he had, 'Please put your hand you will not take a wife for my son from the daughters of the Canaanites, among whom I dwell; but you shall go to my country and to my \_\_\_\_\_ and take a wife for my son Isaac.'" **GENESIS 24:2-4**
- 8 DOWN Abraham said, "The LORD God of heaven, who took me from my father's house and from the land of my kindred, and who spoke to me and swore to me, saying, 'To your descendants I give this land,' He will send His angel before you, and you shall take a \_\_\_\_\_ for my son from there." **GENESIS 24:7**
- 4 ACROSS "The servant took ten of his master's camels and departed, for all his master's goods were in his hand. And he arose and went to \_\_\_\_\_, to the city of Nahor." **GENESIS 24:10**
- 1 DOWN "And he made his camels kneel down outside the city by a \_\_\_\_\_ of water at evening time, the time when women go out to draw water. Then he said, 'O LORD God of my master Abraham, please give me success this day, and show kindness to my master Abraham.'" **GENESIS 24:11-12**
- 6 ACROSS He also said, "Now let it be that the young woman to whom I say, 'Please let down your pitcher that I may \_\_\_\_\_,' and she says, 'Drink, and I will also give your camels a drink' - let her be the one whom You have appointed for Your servant Isaac." **GENESIS 24:14**
- 5 ACROSS "And it happened, after he had finished speaking, that behold, Rebekah, who was born to Bethuel, son of Milcah, the wife of Nahor, Abraham's brother, came out with her pitcher on her shoulder...And when she had finished giving him a drink, she said, 'I \_\_\_\_\_ draw water for your camels also, until they have finished drinking.'" **GENESIS 24:15, 19**
- 5 DOWN "Then the man bowed down his head and \_\_\_\_\_ the LORD." **GENESIS 24:26**
- 2 DOWN "So the young woman \_\_\_\_\_ and told those of her mother's house these things." **GENESIS 24:28**
- 10 ACROSS "Then they called \_\_\_\_\_ and said to her, 'Will you go with this man?' And she said, 'I will go.'" **GENESIS 24:58**
- 7 DOWN "Now \_\_\_\_\_ went out to meditate in the field in the evening; and he lifted his eyes and looked, and there, the camels were coming. Then Rebekah lifted her eyes, and when she saw Isaac she dismounted from her camel." **GENESIS 24:63-64**



# A BRIDE FOR ISAAC

## (GENESIS 24:1-67)

U R Y I Q T F X B U K J E Q O O P X D X E T E I E X Y I I S  
 Q E C A A S I P D K P H V K U E C O C Q D E F F D R I N K A  
 S U E O I I V J R C Z Q A L G M D U M F B U S R K T S P M L  
 S W L V W O X H C U Y O R W F X T A P G Y S A N O O G O I Y  
 I J N Q Z T S G G M Y A L K K N X N O T K S G Y O N M R O J  
 L N V Z K A V E S D O W W I D O X G E A N F Q M P K X A Q H  
 S S Q U K N M U R W J V J J B B G E A M K A F C A M E L S W  
 J Z T A Q R A W G L E M U S K U R L Y M J J V Z F V T V H Z  
 F F A N Y R T N U O C A O U K L E E U A M S H R D E L K U A  
 F K A M J P Z D N S F F R E A P I V T O V G W U E F A R N P  
 O B Q M R I S W G V A S E A T M K Z H A W R U W H S B W H X  
 P Z F G I O H Y Z R H W P V W C X A A K W A I I A G H Y P I  
 E F H F B L O P J C A U T D L C P U E R E T S A M R P B U C  
 T H P H B Q Y M P M H D D Q A M P E C C Z S K K D S T G Y N  
 H N J A R D M Z N L Z O C E P V E F N Y F F E N F L U S N Z  
 I G T W B J X W U B G S S N P Z U S A U I N Y M W C V P M F  
 G X M A H A R B A D Y J C R A K Z P O D Z T B C Y Y L F H N  
 H G B X K Q S B R X N H H Y X F V T I P T Q T D S D R Q B F  
 O R I P E R V O O A J Q U Y V K F O Z Y O C I N K T R K Y P  
 O Q A E F I L M F C T O E D Q S R N S G M T O Y T L E G A G  
 C I M S J L O W L W P E C J D M K I N T G D A J E V V X O G  
 F P X G T S J U L J D W N I V O K J C I G Y W M F P U Q M Z  
 K H T D E T J F M U L E Q P S A Y J Z I R R A D I T V L B A  
 B Z F E J F E I S K J E E T M T R Y H A K E B E R A P J H B  
 Y P I T C H E R Z O C B L F C M G T X P H Q E V Y J I V N K  
 N I E P Z A A X F I V K K V Z Z I H R G U T P C R I R U X O  
 M V L Z Z Y W G P T T S D R L J K G P C V B Q U N P F X V M  
 H V D C K Y L Y G E W U D F U S U F J J Y K T A L K V E I Y  
 L B Y E F I W P K J H H O E T M A Y P N Y I F U M D Q A U S  
 D Q L C C O Z Y B K P P K J M X V Q Q H R J V T A A X F S G

- |         |         |             |          |       |
|---------|---------|-------------|----------|-------|
| ABRAHAM | FEED    | MESOPOTAMIA | STRAW    | ANGEL |
| FIELD   | PITCHER | SWEAR       | CAMELS   | ISAAC |
| REBEKAH | THIGH   | COUNTRY     | LORD GOD | ROOM  |
| WATER   | DRINK   | MASTER      | SERVANT  | WIFE  |
| FAMILY  |         |             |          |       |

COMPLETE THE VERSE AT THE BOTTOM OF THE PAGE BY WRITING  
DOWN THE LETTERS AS YOU COME TO THEM ON THE LINES BELOW

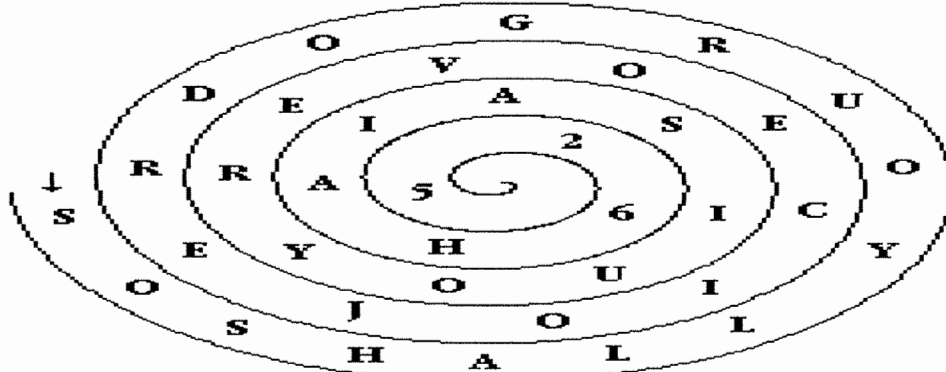

*"And as the bridegroom rejoices over the bride,*

\_\_\_\_\_  
 \_\_\_\_\_  
 \_\_\_\_\_

**Year 1**

**Week 17**

## **Jacob and Esau**

**Scriptures: Genesis 25:19-34**

**Key Verse: Gen 25:31 And Jacob said, “Sell me this day thy birthright.”**

### **Key Points:**

- 1.** After many years, Rebekah became pregnant with twins.
- 2.** God explained that the children would have very different personalities and that the one born last (Jacob) would rule over the one born first (Esau).
- 3.** Each parent had a favorite child and this caused problems.
- 4.** Esau traded his birthright for a pot of stew. He did not value his birthright, and did not put God first in his life.

**Year 1**

**Week 17**

**Middle School**

**Jacob and Esau**

**Scriptures: Genesis 25:19-34**

**Key Verse:**

**Gen 25:31** And Jacob said, “Sell me this day thy birthright.”

**Key Points:**

1. What are some examples of others who pleaded with God to become pregnant?
2. When Rebekah inquired of God, He said, “There are two nations in your womb”. To what two nations is he referring?
3. According to this prophecy, what nation would serve the other?
4. Were Jacob and Esau identical twins?
5. By tradition, who was the rightful heir of Isaac? What would he receive?
6. Why did Esau sell his birthright to Jacob? Was this a good thing or was it foolish?
7. Consider Hebrews 12:16-17. Did God look favorably upon Esau's selling of the birthright? Was he able to get the inheritance back?
8. If we are a child of God, we can receive the promise of His inheritance. How could we, as children of God, lose our birthright?
9. What would be the “one morsel of food” for a Christian?



**Rebecca is blessed with twins**

**Jacob and Esau**

---



Jacob and his brother Esau

# JACOB TRICKS ESAU

*Genesis 25:19-34*



*Esau sells his birthright to Jacob for some stew*

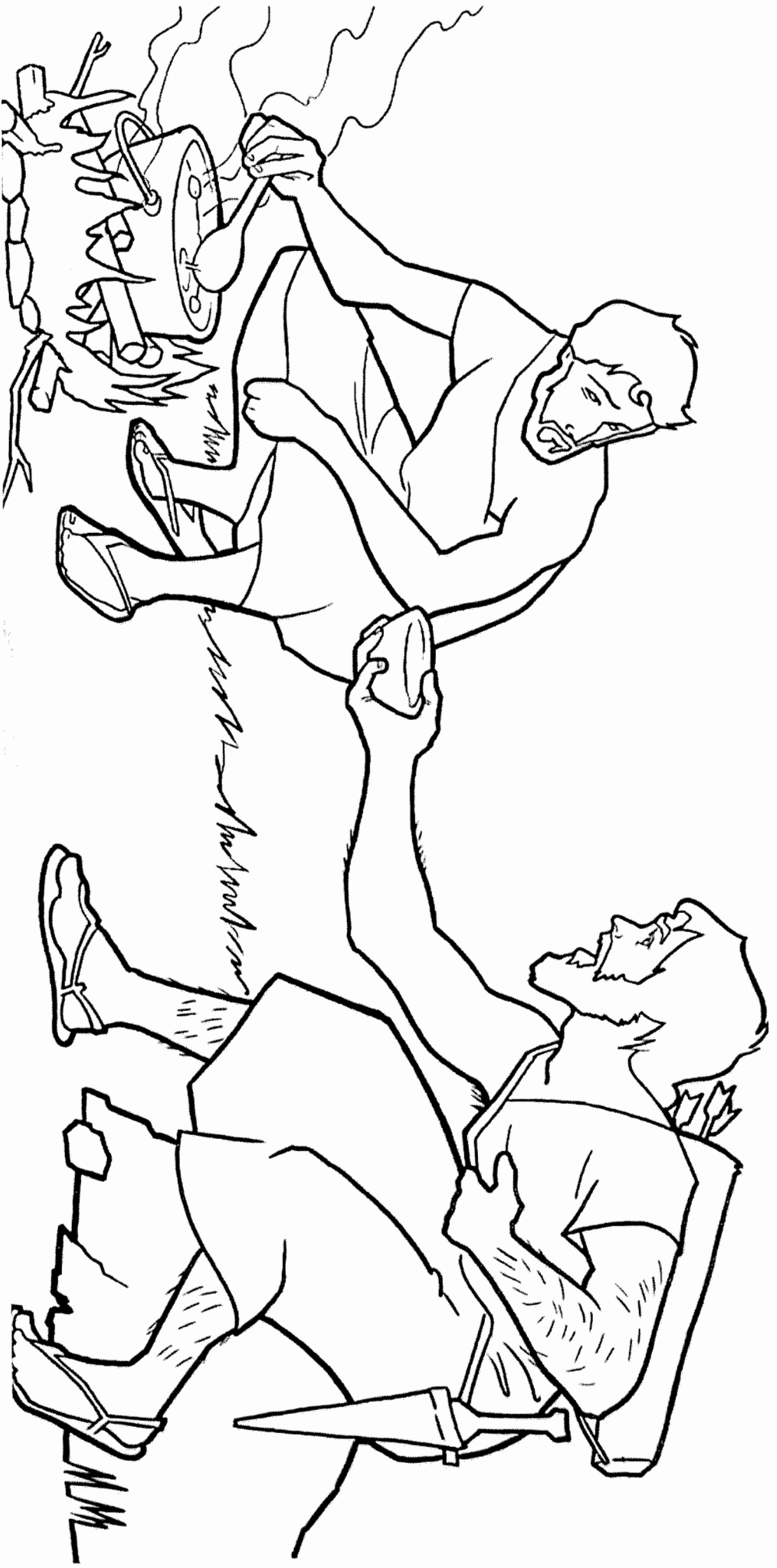

## Esau sells his birthright – Genesis 25

<sup>33</sup>Then Jacob said, <sup>[b]</sup>“Swear to me as of this day.”

So he swore to him, and sold his birthright to Jacob. <sup>34</sup>And Jacob gave Esau bread and stew of lentils; then he ate and drank, arose, and went his way. Thus Esau despised *his* birthright.



## Birthright Stew

Color and cut out vegetables for stew  
or have kids place stickers in pot, or cut of cardstock and  
have kids glue on different kinds of dry beans.



# JACOB TRICKS ESAU

*Genesis 25:19-34*

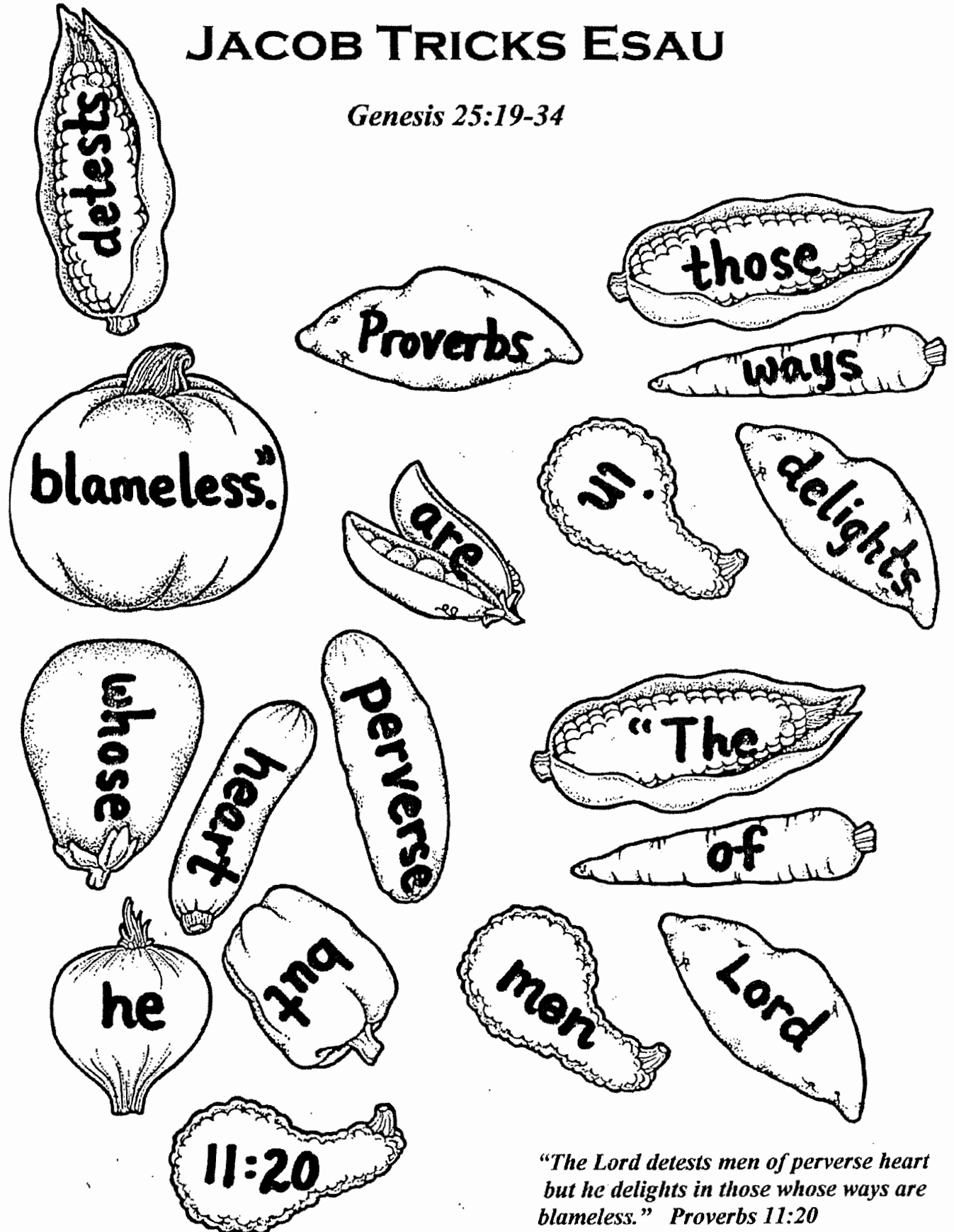

*"The Lord detests men of perverse heart but he delights in those whose ways are blameless." Proverbs 11:20*

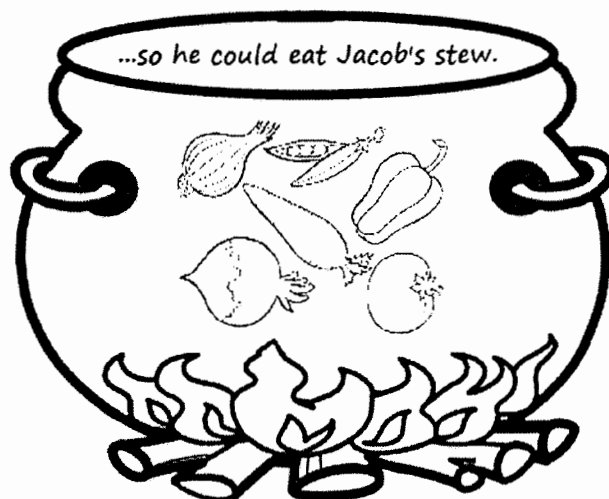
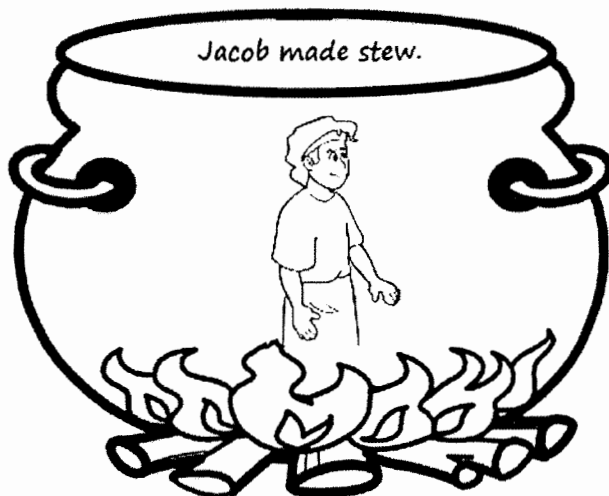
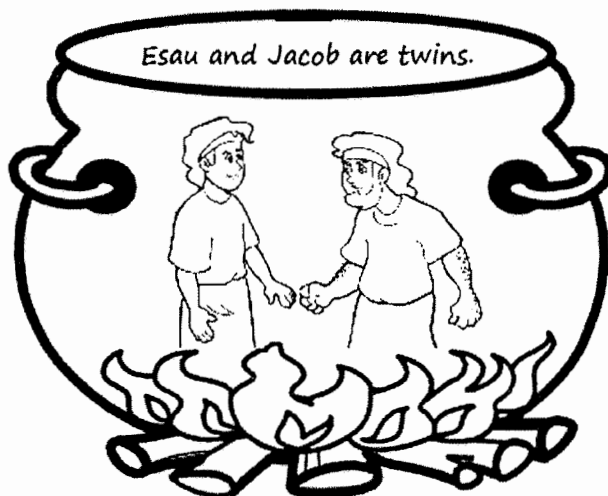

# Jacob and Esau Maze

Help Esau make the right choice when he gets home from hunting.

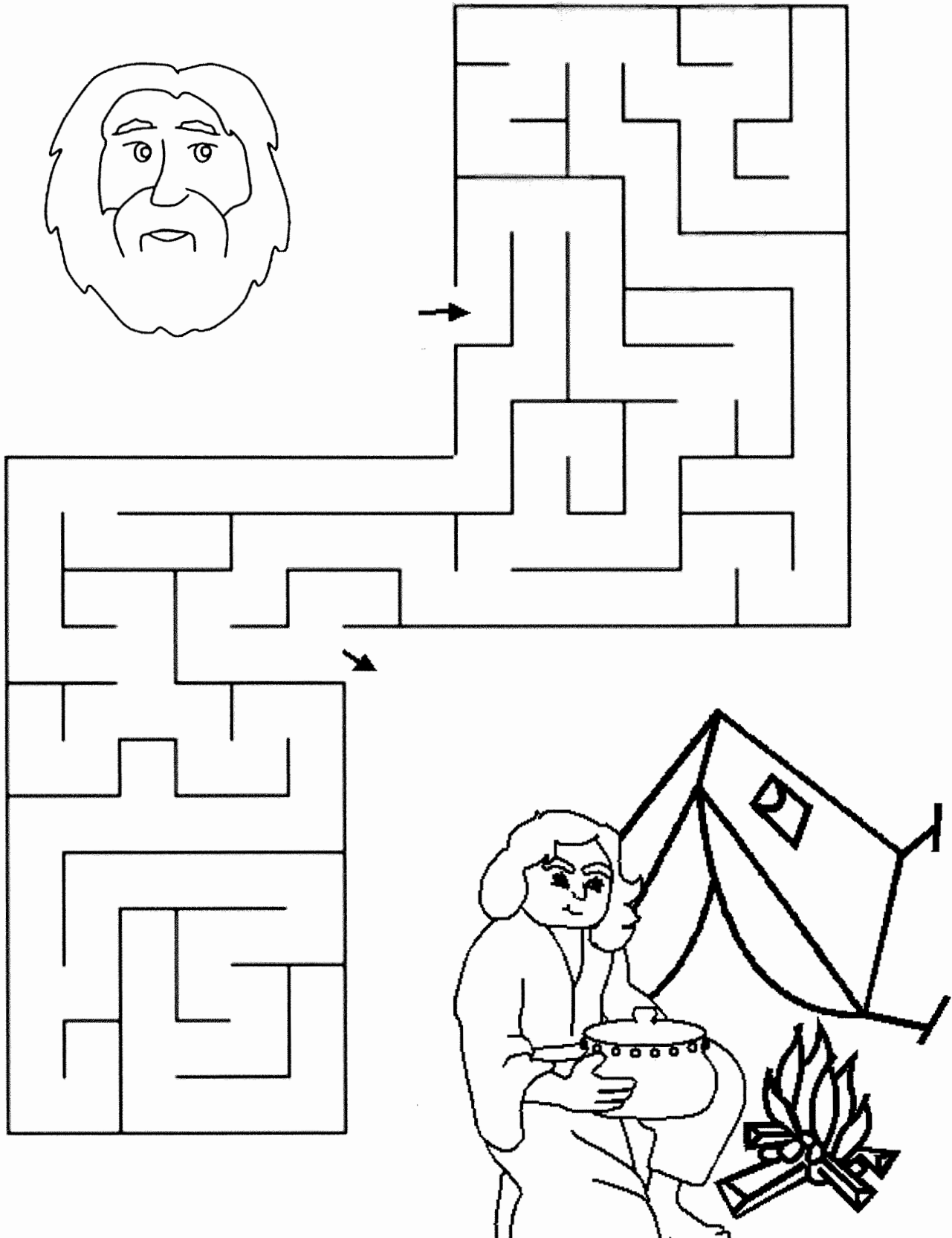

# Jacob & Esau Word Search

T R I C K Q H R

R U N S N I W T

B R O T H E R W

S S E L B F F D

**BLESS  
BROTHER  
RUN  
TRICK  
TWINS**

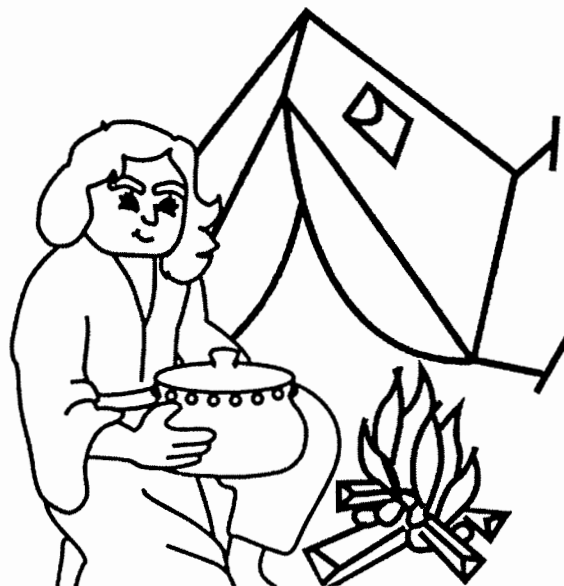

# JACOB TRICKS ESAU

*Genesis 25:19-34*



Picture from *Egermeier's Bible Story Book* by Elsie E. Egermeier. The Warner Press: Copyright © 1969.

# JACOB TRICKS ESAU

Genesis 25:19-34

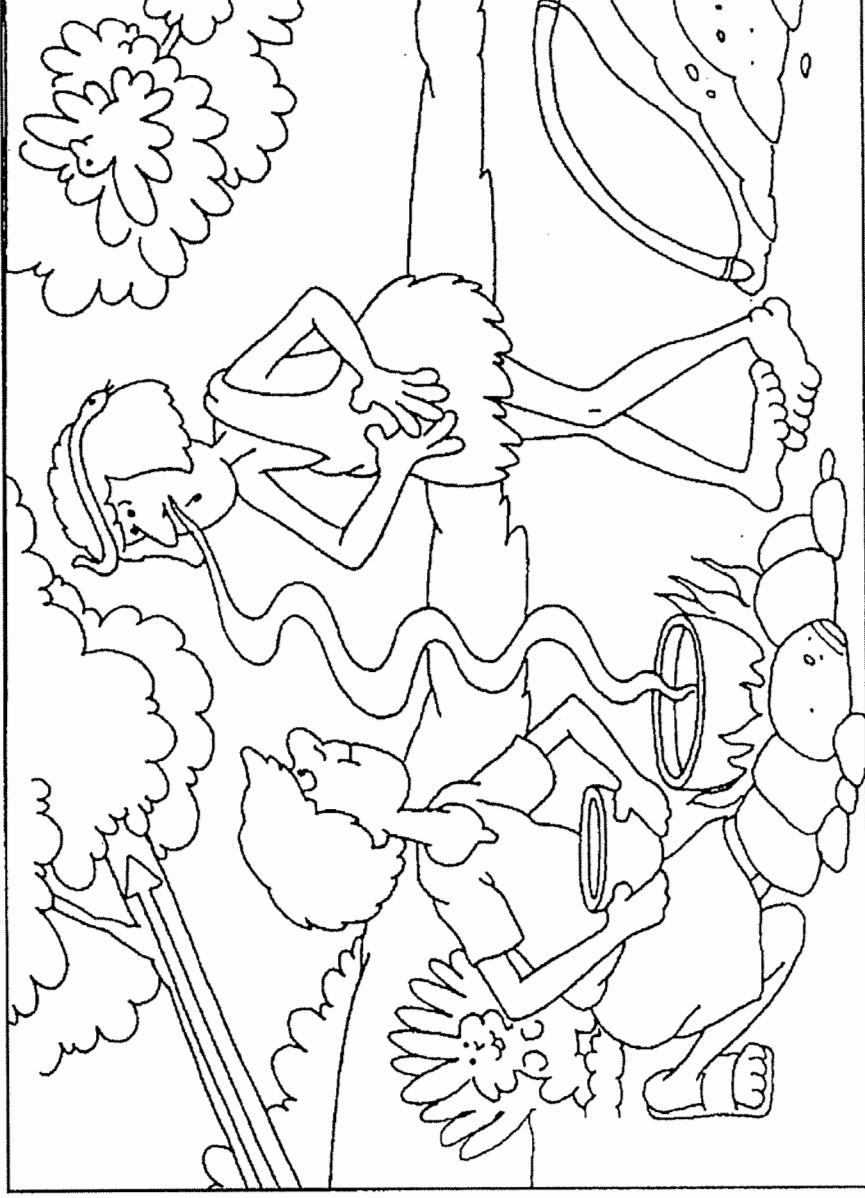

Find the hidden items in the picture.

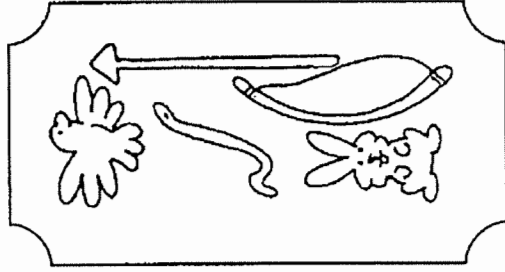

Esau was older than his twin brother, Jacob, so the family birthright belonged to him. That meant he would someday be the family leader. One day Esau was very hungry. He wanted some of the stew Jacob made, so he traded his birthright for a bowl of Jacob's stew.

Isaac could not see well

Jacob sounded like himself

Jacob smelled like Esau

Jacob felt like Esau

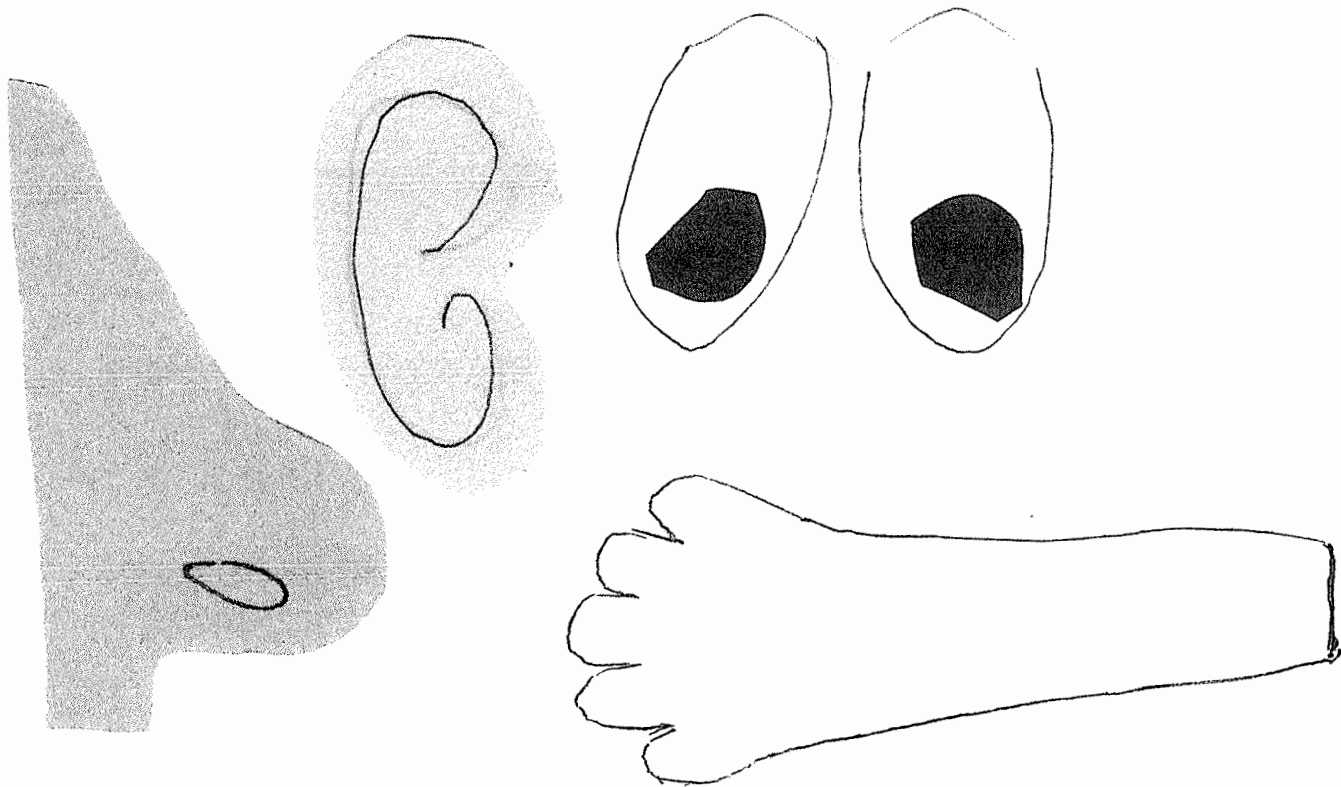

Cut out figures of eyes, ears, noses and arms from construction paper. Cut out descriptions about Jacob for each child. Glue on to construction paper. Felt or fake hair can be added to the arm if wanted.



Isaac gave his blessing to Jacob.



# JACOB TRICKS ESAU

*Genesis 25:19-34*

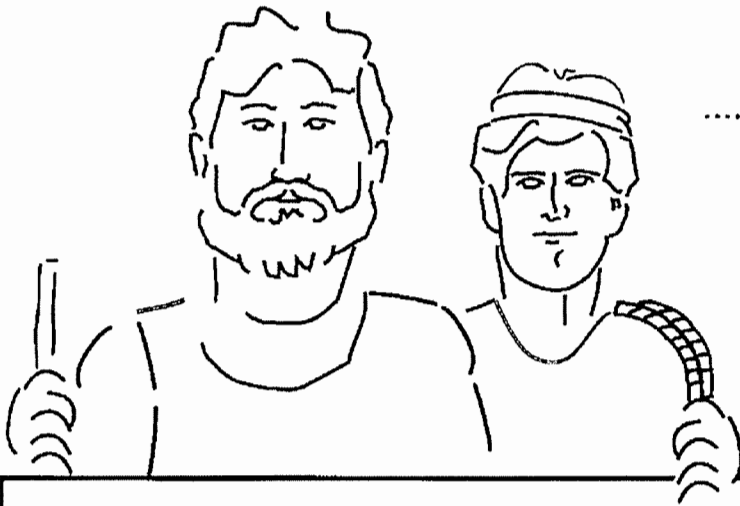

Directions: Make a code key by numbering the letters of the alphabet in sequence from 1-26. Let A = 1 and Z = 26. Then use the code key to translate the message.

Esau traded his birthright to Isaac for food. By decoding the following sequence of numbers, you will discover what a birthright meant in Old Testament times.

2 9 18 20 8 18 9 7 8 20 :

1 4 15 21 2 12 5 19 8 1 18 5

15 6 20 8 5 9 14 8 5 18 9 20 1 14 3 5

1 14 4 12 5 1 4 5 18 19 8 9 16

15 6 20 8 5 3 12 1 14

# Jacob and Esau

Isaac and Rebekah had twin boys. .... was born first.

The oldest son should have got the ..... But Esau

traded his for a bowl of ..... Because of this

..... got the oldest son's rights even though he was the

.....

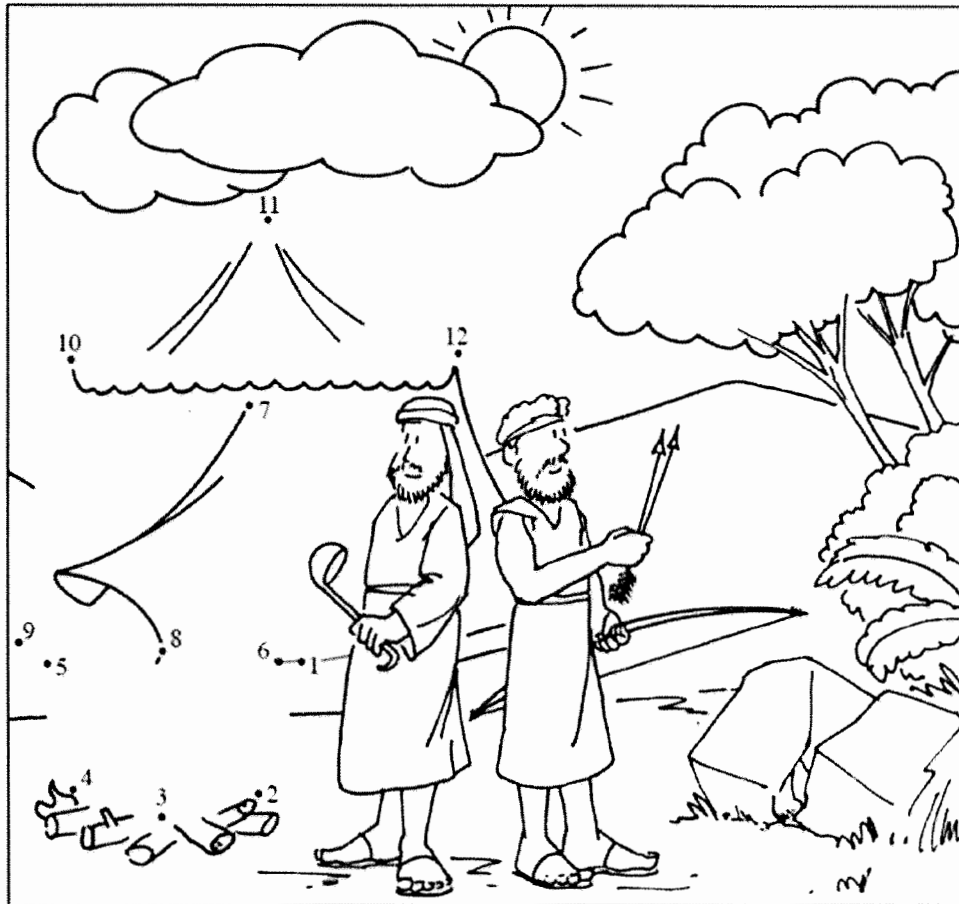

Connect the dots to complete the picture.

Jacob stew youngest Esau birthright

# Jacob & Esau Word Search

R G E N Q V B L S N E J D E S  
C G N I T N U H U S S H B B I  
T H G I R H T R I B R E O T A  
C J O V S E P U Y E E L C W Q  
F A P I V S G U S G H P A I F  
F M A R C S E A O W T I J N E  
Q I E S I E U L G S O N R S I  
C S P D I W S X B S R G D I L  
Y O U N G E S T L R B R I A H  
Z Z I L T R I C K E U V K L A

**BLESSING  
BIRTHRIGHT  
BROTHERS  
CHOICES  
DISGUISE  
ESAU  
HAIR  
HELPING  
HUNTING**

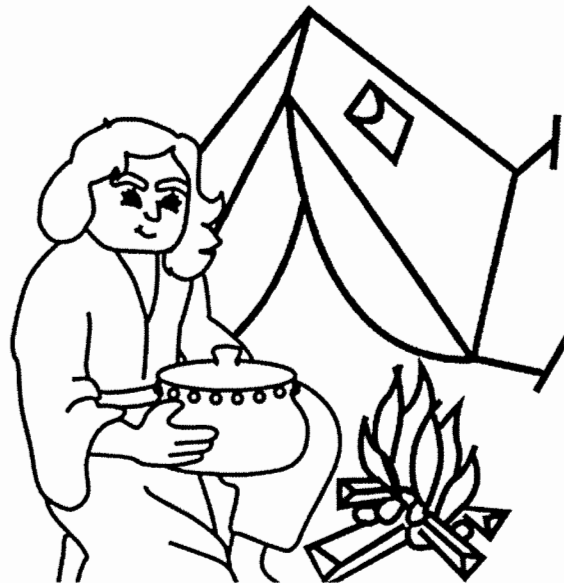

**ISAAC  
JACOB  
LIE  
RUN  
SERVE  
SOUP  
TRICK  
TWINS  
YOUNGEST**

# Esau Sells His Birthright

Then Jacob gave Esau some bread and some lentil stew. He ate and drank, and then got up and left. So Esau despised his birthright. Genesis 25:34

The puzzle is based on Genesis 25:19-34



Q B T G Y H B W R N N G O F S  
P I W O X S I S A A C C T E T  
K R O W D C O O K I N G W R A  
F T S N B U A S O J M B I N R  
W H B K O P S H Q P Y L N U V  
B R N T E J B K P L I H S R I  
O I V P R O J T K T D S E C N  
Y G G E C C D R N A K T T B G  
S H L A A U X E E H N H D P S  
K T J S M Z L R G U N F I Q C  
V A E M U Y B C H B I Z E M R  
O C E S A U V T S D A I V J J  
G H S J K Q P I F T Q K O U C  
S W I L Y Q H O M E E U Z Z W  
Q F E V R E B E K A H W E I T

JACOB	HUNTER	DIE	BREAD	ISAAC
BOYS	HOME	REBEKAH	STEW	ESAU
BIRTHRIGHT	COOKING	TWIN	STARVING	LENTIL

# Esau Sells His Birthright

Then Jacob gave Esau some bread and some lentil stew. He ate and drank, and then got up and left. So Esau despised his birthright. Genesis 25:34

Puzzle is based on Genesis 25:19-34

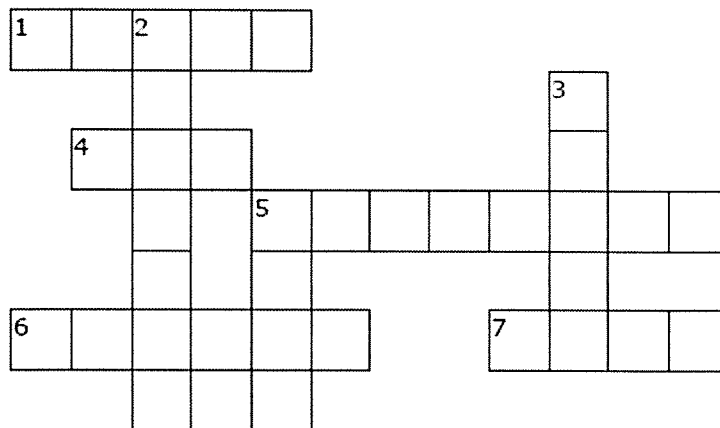

## ACROSS

1. The twin brother of Esau
4. A male child
5. Suffering from a lack of food
6. A person who likes to search for and kill wild animals
7. The oldest son of Isaac who loved to hunt

## DOWN

2. Preparing food by heating it
3. Two children born to the same mother on the same occasion
5. A dish of meat and vegetables cooked slowly in liquid

COOKING	HUNTER	TWINS	STARVING
STEW	BOY	JACOB	ESAU

# **Very Different Twins**

## **Jacob and Esau**

---

**Jacob**

**Esau**

**Have the students make a list of characteristics for Jacob and Esau separately and talk about their differences and choices they made**

# Birthright

## ACROSS

- The Bible says, Esau \_\_\_\_\_ his birthright.
- Jacob's occupation was a \_\_\_\_\_.
- Esau traded his birthright for a bowl of \_\_\_\_\_.
- Esau did not value his \_\_\_\_\_.
- Esau's inheritance included \_\_\_\_\_.
- Compared to Jacob, Esau was very \_\_\_\_\_.
- Esau was a mighty \_\_\_\_\_.
- What was the name of Jacob and Esau's father?

## DOWN

- Jacob's twin brother was \_\_\_\_\_.
- Esau's inheritance included \_\_\_\_\_.
- Esau was the \_\_\_\_\_ brother.
- In addition to items, Esau was to inherit his father's \_\_\_\_\_.
- Who tricked Esau into selling his birthright for a bowl of stew?
- Esau thought he was going to die from \_\_\_\_\_.
- Esau's face and arms were \_\_\_\_\_.

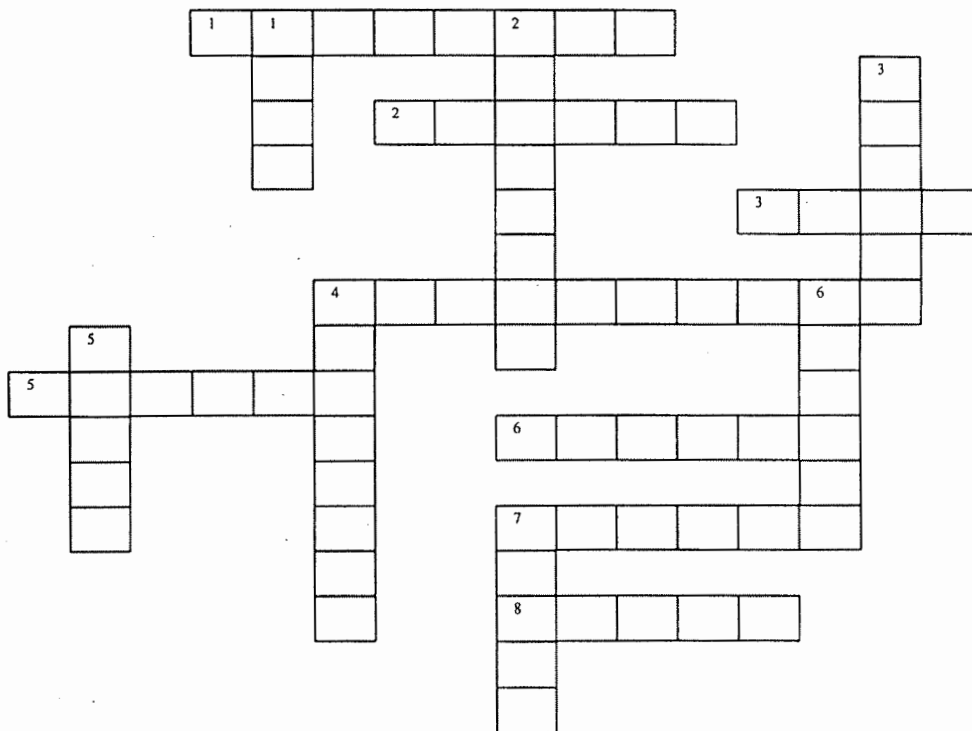

**List of Answers** - Esau, Jacob, Isaac, Hunter, Farmer, Blessing, Stew, Hunger, Hairy, Strong, Birthright, Oldest, Despise, Cattle, Servants

# Brothers



Jacob and Esau were twin sons of Isaac. One of the twins did a very foolish thing. Discover what happened by coloring in each box whose answer does not equal 24. Then read about Jacob and Esau in Genesis 25:27-34 and Genesis 27:1-44.

$84 \div 27 =$	$14 + 10 =$	$24 \times 0 =$	$8 \times 3 =$	$41 - 28 =$	$28 - 4 =$	$4 \times 6 =$	$9 + 9 =$
A	E	O	S	R	A	U	T
$12 + 12 =$	$17 + 7 =$	$20 + 14 =$	$2 \times 12 =$	$47 - 24 =$	$23 + 14 =$	$6 + 18 =$	$37 - 8 =$
S	O	A	L	E	R	D	E
$3 \times 12 =$	$42 - 22 =$	$51 - 27 =$	$35 - 11 =$	$64 - 20 =$	$19 + 5 =$	$9 + 17 =$	$24 \times 1 =$
B	E	H	I	H	S	T	B
$4 + 20 =$	$8 \times 6 =$	$55 - 31 =$	$14 + 10 =$	$81 - 55 =$	$72 \div 3 =$	$7 \times 4 =$	$11 + 16 =$
I	A	R	T	O	H	A	E
$18 - 6 =$	$9 + 15 =$	$49 - 24 =$	$9 \times 4 =$	$48 - 24 =$	$14 + 13 =$	$3 + 21 =$	$68 - 30 =$
S	R	G	O	I	D	G	R
$37 - 13 =$	$2 + 22 =$	$6 \times 7 =$	$38 - 4 =$	$48 \div 2 =$	$7 + 8 =$	$16 + 8 =$	$68 - 44 =$
H	T	I	H	T	T	O	J
$22 + 22 =$	$30 - 6 =$	$16 + 7 =$	$24 \times 1 =$	$30 - 5 =$	$25 - 1 =$	$23 + 1 =$	$3 \times 6 =$
O	A	M	C	L	O	B	Z



# JACOB & ESAU

## (GENESIS 25:19-34; 27:1-46; 33)

### MEMORY VERSE:

*Pursue peace with all men, and holiness, without which no one will see the Lord.*  
HEBREWS 12:14

### CIRCLE THE CORRECT WORDS:

1. When the first child was born, "he was like a (**HAIRY, SMOOTH**) garment all over; so they called his name Esau." GENESIS 25:25
2. When his brother was born, "his hand took hold of Esau's (**EAR, HEEL**); so his name was called Jacob." GENESIS 25:26

### FILL IN THE BLANKS:

3. "So the boys grew. And \_\_\_\_\_ was a skillful hunter, a man of the field; but \_\_\_\_\_ was a mild man, dwelling in tents." GENESIS 25:27

### CIRCLE THE CORRECT WORDS:

4. "Now Jacob cooked a (**BURGER, STEW**); and Esau came in from the field, and he was weary. And Esau said to Jacob, 'Please feed me with that same red (**BURGER, STEW**), for I am weary.' Therefore his name was (**EDOM, STEW**)." GENESIS 25:29-30
5. "But Jacob said, 'Sell me your (**BIRTHRIGHT, SHOES**) as of this day.' And Esau said, 'Look, I am about to die; so what profit shall this (**BIRTHRIGHT, SHOE**) be to me?' Then Jacob said, 'Swear to me as of this day.' So he swore to him, and sold his (**BIRTHRIGHT, SHOES**) to Jacob." GENESIS 25:31-33

### ISAAC SOUGHT TO BLESS ESAU, BUT REBEKAH SENT IN JACOB TO GET THE BLESSING FROM HIS FATHER...

6. "So he went to his father and said, 'My father'; and he said, 'Here I am. Who are you, my son?' And Jacob said to his father, 'I am Esau your firstborn; I have done just as you told me; please arise, sit and eat of my game, that your soul may (**BLESS, CURSE**) me.'" GENESIS 27:18-19
7. "Esau said, 'Is he not rightly named Jacob? For he has (**SUPPLANTED, PLANTED**) me these two times. He took away my birthright, and now look, he has taken away my blessing!' " GENESIS 27:36
8. "So Esau (**LOVED, HATED**) Jacob because of the blessing with which his father blessed him, and Esau said in his heart, 'The days of mourning for my father are at hand; then I will kill my brother Jacob.'" GENESIS 27:41
9. After Isaac blessed Jacob, he "sent Jacob away, and he went to Padan Aram, to (**LABAN, ABRAM**) the son of Bethuel the Syrian, the brother of Rebekah, the mother of Jacob and Esau." GENESIS 28:5
10. Jacob feared his brother, but when he returned to the land of Canaan, "Esau (**WALKED, RAN**) to meet him, and embraced him, and fell on his neck and kissed him, and they wept." GENESIS 33:4
11. Jacob said to Esau, 'Please, take my blessing that is brought to you, because (**GOD, LABAN**) has dealt graciously with me, and because I have enough.' And he urged him, and he took it." GENESIS. 33:11

# JACOB & ESAU

## (GENESIS 25:19-34; 27:1-46; 33)

### MEMORY VERSE:

*"Pursue peace with all men, and holiness, without which no one will see the Lord."*  
HEBREWS 12:14

### FILL IN THE BLANKS:

1. When the first child was born, "he was like a \_\_\_\_\_ garment all over; so they called his name Esau."  
GENESIS 25:25
2. When his brother was born, "his hand took hold of Esau's \_\_\_\_\_; so his name was called Jacob."  
GENESIS 25:26
3. "So the boys grew. And \_\_\_\_\_ was a skillful hunter, a man of the field; but \_\_\_\_\_ was a mild man, dwelling in tents." GENESIS 25:27

### CIRCLE THE CORRECT WORDS:

4. "Now Jacob cooked a (BURGER, STEW); and Esau came in from the field, and he was weary. And Esau said to Jacob, 'Please feed me with that same red (BURGER, STEW), for I am weary.' Therefore his name was (EDOM, STEW)." GENESIS 25:29-30
5. "But Jacob said, 'Sell me your (BIRTHRIGHT, SHOES) as of this day.' And Esau said, 'Look, I am about to die; so what profit shall this (BIRTHRIGHT, SHOE) be to me?' Then Jacob said, 'Swear to me as of this day.' So he swore to him, and sold his (BIRTHRIGHT, SHOES) to Jacob." GENESIS 25:31-33

ISAAC SOUGHT TO BLESS ESAU, BUT REBEKAH SENT IN JACOB TO GET THE BLESSING FROM HIS FATHER...

### FILL IN THE BLANKS:

6. "So he went to his father and said, 'My father'; and he said, 'Here I am. Who are you, my son?' And Jacob said to his father, 'I am Esau your firstborn; I have done just as you told me; please arise, sit and eat of my game, that your soul may \_\_\_\_\_ me.'" GENESIS 27:18-19
7. "Esau said, 'Is he not rightly named Jacob? For he has \_\_\_\_\_ me these two times. He took away my birthright, and now look, he has taken away my blessing!'" GENESIS 27:36
8. "So Esau \_\_\_\_\_ Jacob because of the blessing with which his father blessed him, and Esau said in his heart, 'The days of mourning for my father are at hand; then I will kill my brother Jacob.'" GENESIS 27:41
9. After Isaac blessed Jacob, he "sent Jacob away, and he went to Padan Aram, to \_\_\_\_\_ the son of Bethuel the Syrian, the brother of Rebekah, the mother of Jacob and Esau." GENESIS 28:5

### CIRCLE THE CORRECT WORDS:

10. Jacob feared his brother, but when he returned to the land of Canaan, "Esau (WALKED, RAN) to meet him, and embraced him, and fell on his neck and kissed him, and they wept." GENESIS 33:4
11. Jacob said to Esau, 'Please, take my blessing that is brought to you, because (GOD, LABAN) has dealt graciously with me, and because I have enough.' And he urged him, and he took it." GENESIS 33:11

# JACOB & ESAU

(GENESIS 25:19-34; 27:1-46; 33)

B	R	K	E	H	J	E	F	I	S	A	A	C	I	X
A	G	C	E	A	D	H	U	N	T	E	R	B	T	K
R	W	E	C	O	S	T	N	E	T	T	W	I	N	S
R	L	O	M	E	S	N	O	I	T	A	N	O	W	T
E	B	U	T	N	S	T	R	O	N	G	E	R	N	L
N	K	S	N	B	A	Y	R	I	A	H	E	G	B	S
E	G	E	R	W	I	A	Z	B	B	A	P	O	P	A
V	Q	L	S	E	Q	R	N	R	A	L	C	A	Y	V
R	N	P	G	A	E	M	T	A	B	O	E	T	P	O
E	G	O	Q	R	U	L	A	H	C	W	V	S	Z	R
S	H	E	A	Y	A	M	F	Z	R	R	T	Q	S	Y
N	W	P	L	O	R	D	D	F	N	I	A	X	I	W
R	Z	O	R	E	B	E	K	A	H	E	G	T	C	F
S	G	W	F	J	R	J	P	I	V	T	S	H	L	I
C	V	T	W	N	B	L	M	S	T	E	W	M	T	A

ALTAR  
BARREN  
BIRTHRIGHT  
BLESS  
EDOM  
ESAU  
FLEE

GOATS  
HAIRY  
HEEL  
HUNTER  
ISAAC  
JACOB  
CANAAN

LORD  
REBEKAH  
RED  
SAVORY  
SERVE  
STEW

STRONGER  
TENTS  
TWINS  
TWO NATIONS  
TWO PEOPLES  
WEARY



**Year 1**

**Week 18**

## **Jacob Gets Isaac's Blessing**

**Scriptures: Genesis 27**

**Key Verse: Gen. 27:38 And Esau said to his father, "Have you only one blessing? Bless me—me also, Oh my father"**

### **Key Points:**

- 1.** Isaac was old and he wanted to bless Esau before he died.
- 2.** Rebekah and Jacob tricked Isaac into giving Jacob the blessing that should have been Esau's.
- 3.** Esau was very angry and planned to kill Jacob after their father died.
- 4.** Rebekah and Isaac sent Jacob to his uncle Laban to save him from Esau and to find a wife.

Then Jacob gave Esau bread and pottage of lentiles;  
and he did eat and drink, and rose up, and went his  
way: thus Esau despised his birthright.

*Genesis 25:34*



# Stolen Blessing

Genesis 27:30 - 45



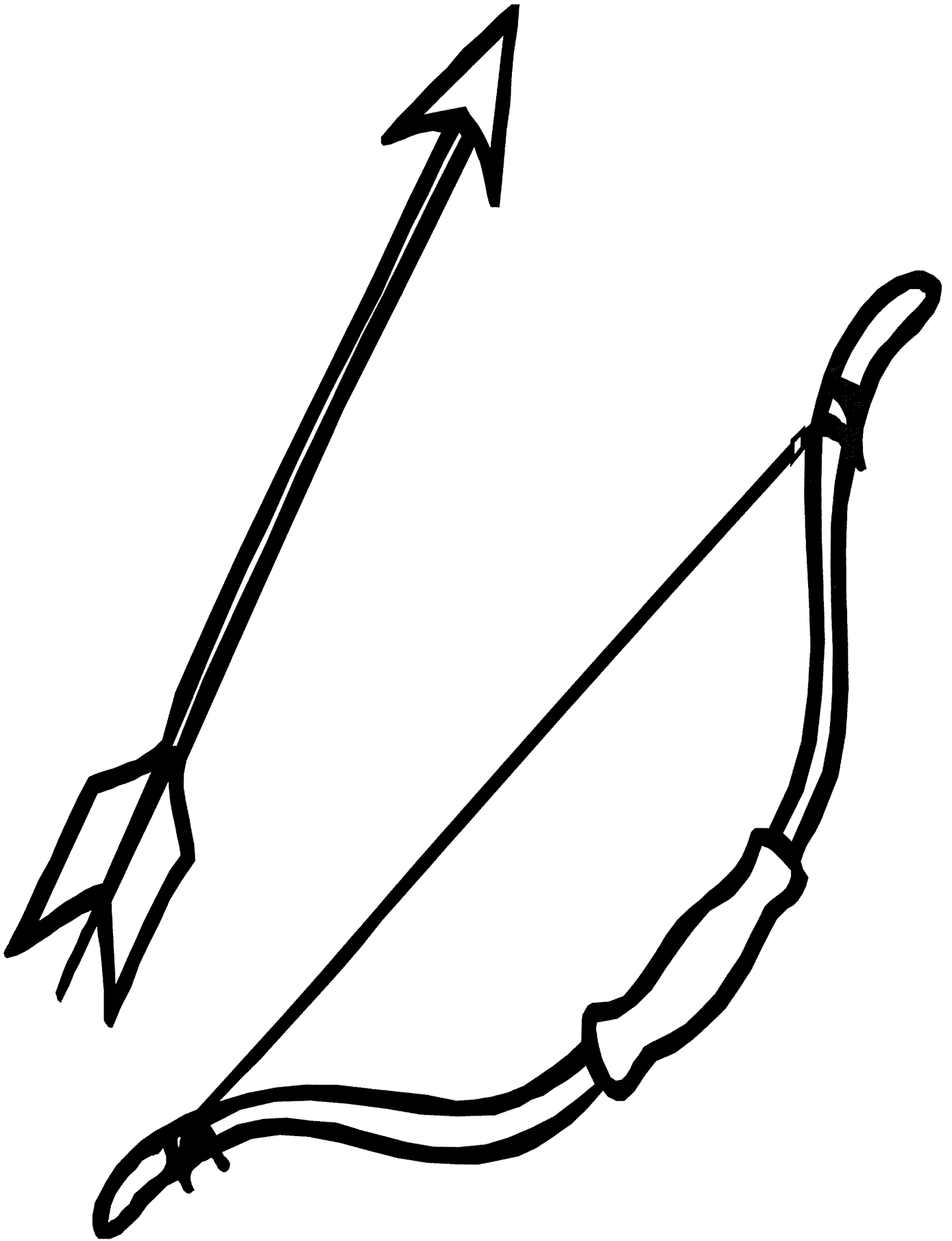







ESAU



JACOB



WHO RECEIVED  
THE BLESSING?

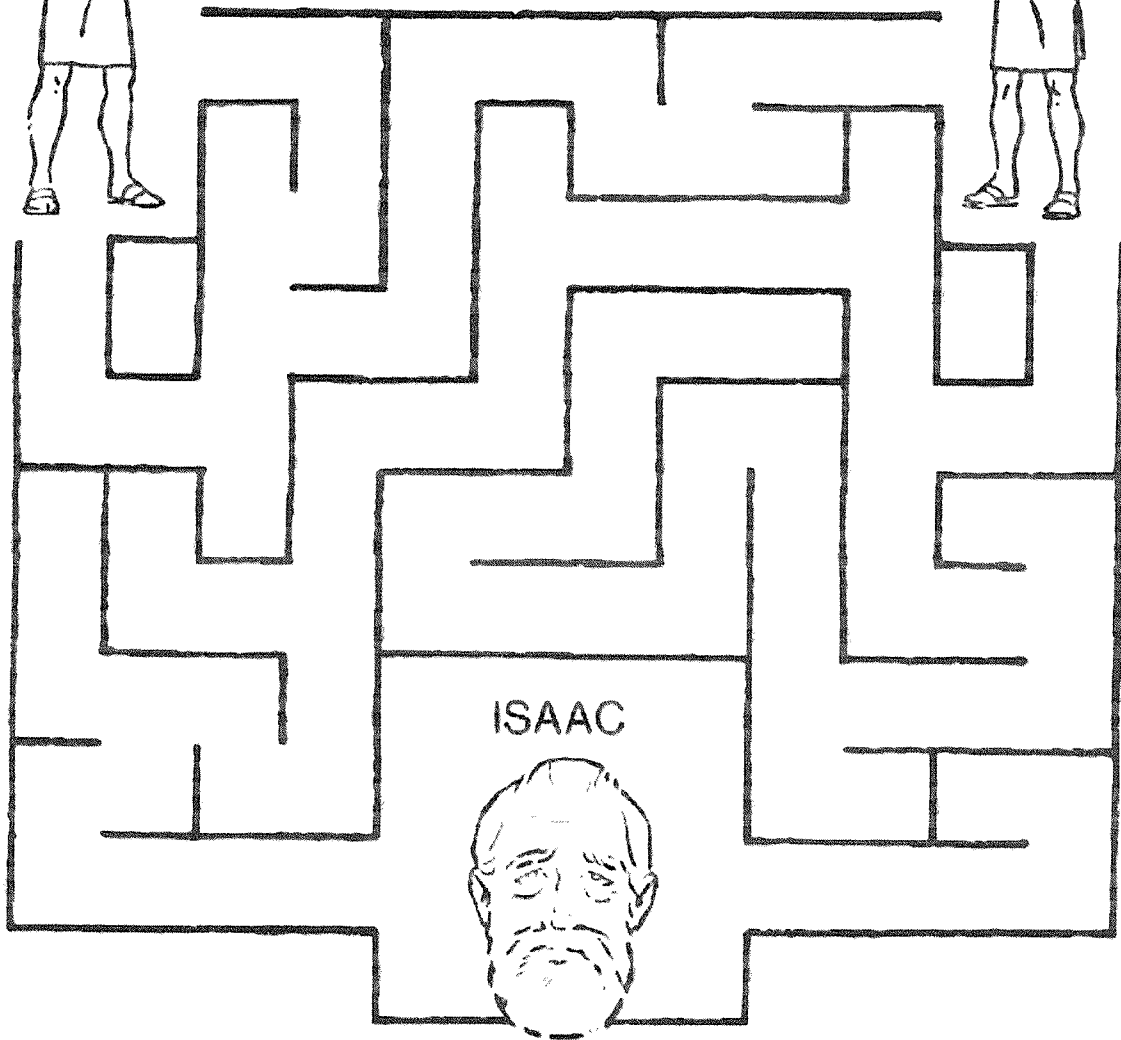

With a crayon, take the son who received the blessing through the maze to Isaac.

# Esau & Jacob

Put the events in the correct order.

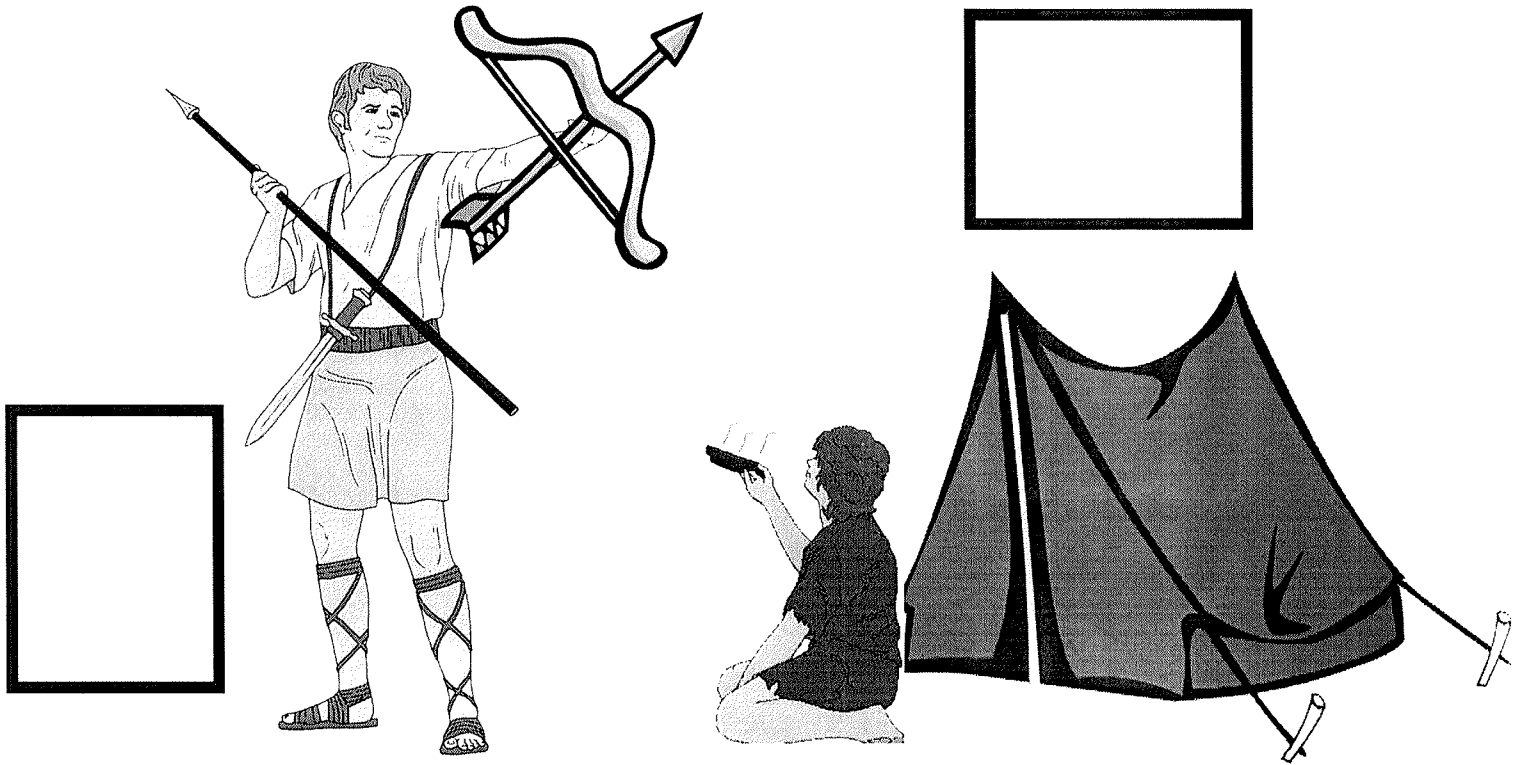

1	2	3	4
5	6	7	8

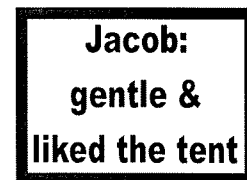
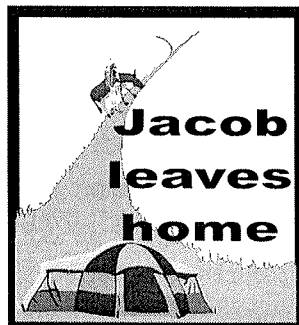
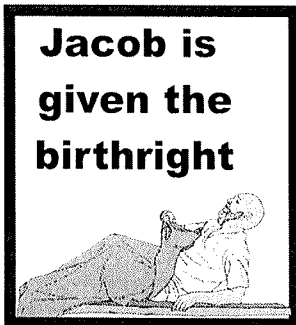
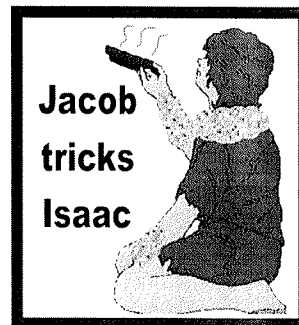
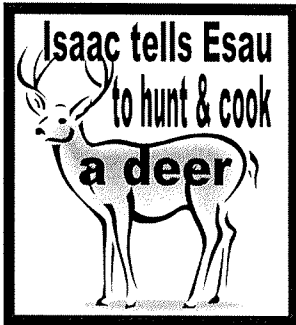
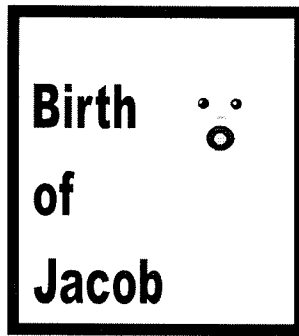
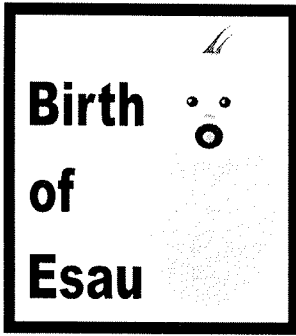

# JACOB & ESAU

(GENESIS 25:19-34; 27:1-46; 33)

B	R	K	E	H	J	E	F	I	S	A	A	C	I	X
A	G	C	E	A	D	H	U	N	T	E	R	B	T	K
R	W	E	C	O	S	T	N	E	T	T	W	I	N	S
R	L	O	M	E	S	N	O	I	T	A	N	O	W	T
E	B	U	T	N	S	T	R	O	N	G	E	R	N	L
N	K	S	N	B	A	Y	R	I	A	H	E	G	B	S
E	G	E	R	W	I	A	Z	B	B	A	P	O	P	A
V	Q	L	S	E	Q	R	N	R	A	L	C	A	Y	V
R	N	P	G	A	E	M	T	A	B	O	E	T	P	O
E	G	O	Q	R	U	L	A	H	C	W	V	S	Z	R
S	H	E	A	Y	A	M	F	Z	R	R	T	Q	S	Y
N	W	P	L	O	R	D	D	F	N	I	A	X	I	W
R	Z	O	R	E	B	E	K	A	H	E	G	T	C	F
S	G	W	F	J	R	J	P	I	V	T	S	H	L	I
C	V	T	W	N	B	L	M	S	T	E	W	M	T	A

ALTAR  
 BARREN  
 BIRTHRIGHT  
 BLESS  
 EDOM  
 ESAU  
 FLEE

GOATS  
 HAIRY  
 HEEL  
 HUNTER  
 ISAAC  
 JACOB  
 CANAAN

LORD  
 REBEKAH  
 RED  
 SAVORY  
 SERVE  
 STEW

STRONGER  
 TENTS  
 TWINS  
 TWO NATIONS  
 TWO PEOPLES  
 WEARY



# JACOB & ESAU

(GENESIS 25:19-34; 27:1-46; 33)

## MEMORY VERSE:

*Pursue peace with all men, and holiness, without which no one will see the Lord.*  
HEBREWS 12:14

## CIRCLE THE CORRECT WORDS:

1. When the first child was born, "he was like a (HAIRY, SMOOTH) garment all over; so they called his name Esau." GENESIS 25:25
2. When his brother was born, "his hand took hold of Esau's (EAR, HEEL); so his name was called Jacob." GENESIS 25:26

## FILL IN THE BLANKS:

3. "So the boys grew. And \_\_\_\_\_ was a skillful hunter, a man of the field; but \_\_\_\_\_ was a mild man, dwelling in tents." GENESIS 25:27

## CIRCLE THE CORRECT WORDS:

4. "Now Jacob cooked a (BURGER, STEW); and Esau came in from the field, and he was weary. And Esau said to Jacob, 'Please feed me with that same red (BURGER, STEW), for I am weary.' Therefore his name was (EDOM, STEW)." GENESIS 25:29-30
5. "But Jacob said, 'Sell me your (BIRTHRIGHT, SHOES) as of this day.' And Esau said, 'Look, I am about to die; so what profit shall this (BIRTHRIGHT, SHOE) be to me?' Then Jacob said, 'Swear to me as of this day.' So he swore to him, and sold his (BIRTHRIGHT, SHOES) to Jacob." GENESIS 25:31-33

## ISAAC SOUGHT TO BLESS ESAU, BUT REBEKAH SENT IN JACOB TO GET THE BLESSING FROM HIS FATHER...

6. "So he went to his father and said, 'My father'; and he said, 'Here I am. Who are you, my son?' And Jacob said to his father, 'I am Esau your firstborn; I have done just as you told me; please arise, sit and eat of my game, that your soul may (BLESS, CURSE) me.' " GENESIS 27:18-19
7. "Esau said, 'Is he not rightly named Jacob? For he has (SUPPLANTED, PLANTED) me these two times. He took away my birthright, and now look, he has taken away my blessing!' " GENESIS 27:36
8. "So Esau (LOVED, HATED) Jacob because of the blessing with which his father blessed him, and Esau said in his heart, 'The days of mourning for my father are at hand; then I will kill my brother Jacob.' " GENESIS 27:41
9. After Isaac blessed Jacob, he "sent Jacob away, and he went to Padan Aram, to (LABAN, ABRAM) the son of Bethuel the Syrian, the brother of Rebekah, the mother of Jacob and Esau." GENESIS 28:5
10. Jacob feared his brother, but when he returned to the land of Canaan, "Esau (WALKED, RAN) to meet him, and embraced him, and fell on his neck and kissed him, and they wept." GENESIS 33:4
11. Jacob said to Esau, 'Please, take my blessing that is brought to you, because (GOD, LABAN) has dealt graciously with me, and because I have enough.' And he urged him, and he took it." GENESIS. 33:11

# JACOB & ESAU

(GENESIS 25:19-34; 27:1-46; 33)

## MEMORY VERSE:

*"Pursue peace with all men, and holiness, without which no one will see the Lord."*  
HEBREWS 12:14

## FILL IN THE BLANKS:

1. When the first child was born, "he was like a \_\_\_\_\_ garment all over; so they called his name Esau."  
GENESIS 25:25
2. When his brother was born, "his hand took hold of Esau's \_\_\_\_\_; so his name was called Jacob."  
GENESIS 25:26
3. "So the boys grew. And \_\_\_\_\_ was a skillful hunter, a man of the field; but \_\_\_\_\_ was a mild man, dwelling in tents." GENESIS 25:27

## CIRCLE THE CORRECT WORDS:

4. "Now Jacob cooked a (BURGER, STEW); and Esau came in from the field, and he was weary. And Esau said to Jacob, 'Please feed me with that same red (BURGER, STEW), for I am weary.' Therefore his name was (EDOM, STEW)." GENESIS 25:29-30
5. "But Jacob said, 'Sell me your (BIRTHRIGHT, SHOES) as of this day.' And Esau said, 'Look, I am about to die; so what profit shall this (BIRTHRIGHT, SHOE) be to me?' Then Jacob said, 'Swear to me as of this day.' So he swore to him, and sold his (BIRTHRIGHT, SHOES) to Jacob." GENESIS 25:31-33

ISAAC SOUGHT TO BLESS ESAU, BUT REBEKAH SENT IN JACOB TO GET THE BLESSING FROM HIS FATHER...

## FILL IN THE BLANKS:

6. "So he went to his father and said, 'My father'; and he said, 'Here I am. Who are you, my son?' And Jacob said to his father, 'I am Esau your firstborn; I have done just as you told me; please arise, sit and eat of my game, that your soul may \_\_\_\_\_ me.'" GENESIS 27:18-19
7. "Esau said, 'Is he not rightly named Jacob? For he has \_\_\_\_\_ me these two times. He took away my birthright, and now look, he has taken away my blessing!' " GENESIS 27:36
8. "So Esau \_\_\_\_\_ Jacob because of the blessing with which his father blessed him, and Esau said in his heart, 'The days of mourning for my father are at hand; then I will kill my brother Jacob.'" GENESIS 27:41
9. After Isaac blessed Jacob, he "sent Jacob away, and he went to Padan Aram, to \_\_\_\_\_ the son of Bethuel the Syrian, the brother of Rebekah, the mother of Jacob and Esau." GENESIS 28:5

## CIRCLE THE CORRECT WORDS:

10. Jacob feared his brother, but when he returned to the land of Canaan, "Esau (WALKED, RAN) to meet him, and embraced him, and fell on his neck and kissed him, and they wept." GENESIS 33:4
11. Jacob said to Esau, 'Please, take my blessing that is brought to you, because (GOD, LABAN) has dealt graciously with me, and because I have enough.' And he urged him, and he took it." GENESIS. 33:11

# JACOB & ESAU

(GENESIS 25:19-34; 27:1-46; 33)

L V B E W M G F I B L A B Y U R N V V Z E V Z Z H H R N S Q  
 B O L B C H Y L P V O S V Y V M R K B S S U Y P G J G A K X  
 M S O D A Y Q K Q B P P H E C I G B L B G A O A Q M V V L A  
 I K U V Z Y D I F W D W E H G F I M O E Y G R K J O Q A W F  
 O L P N S M O Q R Y Q J E L O J K S R W M O C W R U A O F S  
 X D W P D B O S C U J H L B U Q Q F H D G X J C Y W N F W I Z  
 K F C Y G P E S G K R E T N U H T Y R A E W U O C N R E T K L  
 E A P G P R K S O Y J N Q R A E S J K T O D B Y A R E W E W I  
 Y B R N V R P O W H C T W I N S T L W B L E R K N S J E O Y  
 T R F E C Y Z E S F X F O O E P O O G T F Q X Z A C N P W R  
 E X M W V N S Z J N V G V W G G P X E T W W P U A R Q C F L  
 Z E E F L E E P V Q O I Y H A E Y N P D U D I M N G A V U P  
 Q W T Y U R T E H X D I S J O G T B E P U U Y P R W B T A F  
 V G L Z I R V U Y H I T T P T S T K I T Y A V E L K M S H S  
 L F M U P A G V G M A E L A N L T N N C O B B G Q G M B O T  
 S Z E G N B W F M O M E X S N Y G P A P L E N K P Q J Q D X  
 R A Z F S R D I G G S G C R B O F F V N K C W L W N L X X C  
 S N I Y C J A C O B O W J V K T W H I A P Q E W E G F M K F  
 B S I I N E K U X Q O K N T L P I T H B Z K H X T H Z I S T  
 B H D F P X A Y U W K O B H D V Y J W I P S T R O N G E R I  
 B L E S S V R H V G U I L G O E M K A V Z H Z K F W A T L N  
 Z U Z B C I G I E C A A S I H N R Z M G X C J N O Z P N Z W  
 F R P L A T S P Z X D L L R Y J A W H U P H Q I R G M B I D  
 W S A H X O A K U W I D D H Q A U W L K P L B I U V B P C E  
 X Y Z T C J E D O M S S N T K R V V A J T U M C A K R Y D S  
 Y J V A L Q U R U T V U K R G H E H Z W S A G J M C Z P C A  
 L N U E X A K E E D E J A I O N W D Y S A B B H Q U F Z Q U  
 N D D Z P L S W I I M L U B J Y A W E F W G H M P E I I U T  
 D Y W C R P Y N X C N J W J M W T S K Z I D P U B T A C W I  
 C I E L E V X A Q P B T K D N C Z R G Z L V N J T N B X X Z

ALTAR  
 REBEKAH  
 BLESS  
 SERVE  
 ESAU

FLEE  
 TENTS  
 HEEL  
 TWO PEOPLES  
 JACOB

LORD  
 BIRTHRIGHT  
 SAVORY  
 EDMOM

STRONGER  
 HAIRY  
 TWO NATIONS  
 ISAAC

BARREN  
 RED  
 CANAAN  
 STEW

GOATS  
 TWINS  
 HUNTER  
 WEARY





# JACOB & ESAU

(GENESIS 25:19-34; 27:1-46; 33)

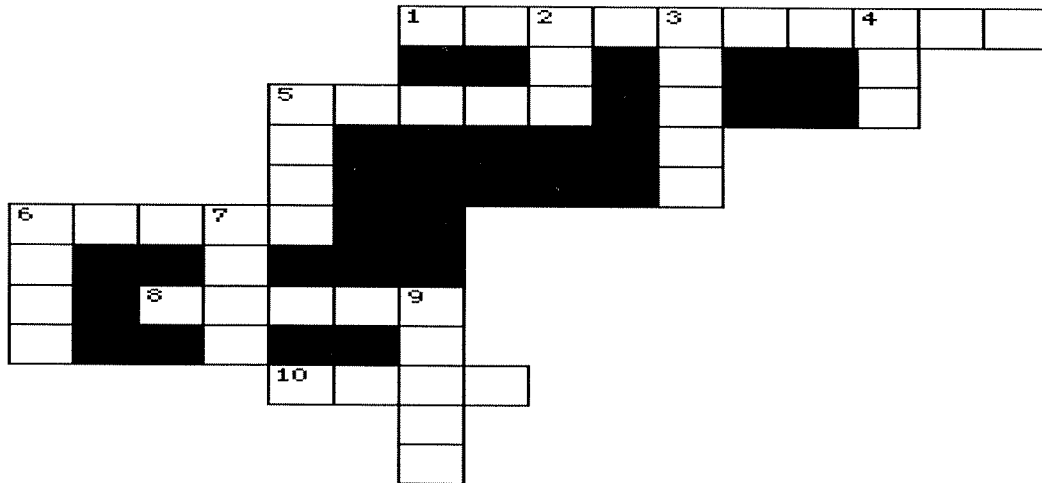

- 5 DOWN "Pursue peace with all men, and holiness, without which no one will see the \_\_\_\_\_"  
**HEBREWS 12:14**
- 3 DOWN When the first child was born, "he was like a \_\_\_\_\_ garment all over; so they called his name Esau." **GENESIS. 25:25**
- 6 DOWN When his brother was born, "his hand took hold of Esau's \_\_\_\_\_ ; so his name was called Jacob." **GENESIS. 25:26**
- 7 DOWN "So the boys grew. And \_\_\_\_\_ was a skillful hunter, a man of the field; but Jacob was a mild man, dwelling in tents." **GENESIS 25:27**
- 10 ACROSS "Now Jacob cooked a \_\_\_\_\_; and Esau came in from the field, and he was weary. And Esau said to Jacob, 'Please feed me with that same red stew, for I am weary.' Therefore his name was Edom."  
**GENESIS 25:29-30**
- 1 ACROSS "But Jacob said, 'Sell me your \_\_\_\_\_ as of this day.' And Esau said, 'Look, I am about to die; so what profit shall this birthright be to me?' Then Jacob said, 'Swear to me as of this day.' So he swore to him, and sold his birthright to Jacob." **GENESIS 25:31-33**
- 9 DOWN "So he went to his father and said, 'My father'; and he said, 'Here I am. Who are you, my son?' And Jacob said to his father, 'I am Esau your firstborn; I have done just as you told me; please arise, sit and eat of my game, that your soul may \_\_\_\_\_ me.' " **GENESIS 27:18-19**
- 8 ACROSS "Esau said, 'Is he not rightly named \_\_\_\_\_? For he has supplanted me these two times. He took away my birthright, and now look, he has taken away my blessing!' " **GENESIS 27:36**
- 6 ACROSS "So Esau \_\_\_\_\_ Jacob because of the blessing with which his father blessed him, and Esau said in his heart, 'The days of mourning for my father are at hand; then I will kill my brother Jacob.' " **GENESIS 27:41**
- 5 ACROSS After Isaac blessed Jacob, he "sent Jacob away, and he went to Padan Aram, to \_\_\_\_\_ the son of Bethuel the Syrian, the brother of Rebekah, the mother of Jacob and Esau." **GENESIS 28:5**
- 2 DOWN Jacob feared his brother, but when he returned to the land of Canaan, "Esau \_\_\_\_\_ to meet him, and embraced him, and fell on his neck and kissed him, and they wept." **GENESIS 33:4**
- 4 DOWN Jacob said to Esau, 'Please, take my blessing that is brought to you, because \_\_\_\_\_ has dealt graciously with me, and because I have enough.' And he urged him, and he took it." **GENESIS 33:11**

**Year 1**  
**Week 19**

## **Jacob's Dream**

**Scriptures: Genesis 28: 1-22**

**Key Verse: Genesis 28:15 "Behold, I am with you and will keep you wherever you go, and will bring you back to this land; for I will not leave you until I have done what I have spoken to you."**

### **Key Points:**

1. Isaac and Rebekah sent Jacob to his uncle Laban, Rebekah's brother. He was to find a wife from God's special people.
2. Jacob was obedient to his father and travels to Haran, where his mother's family lived.
3. When Esau returned, he took a wife from the Ishmaelites as an act of revenge for Jacob stealing his birthright.
4. On Jacob's journey to Haran, he came to a place and lay down to sleep for the night. He used a stone for a pillow.
5. Jacob dreamed about a ladder reaching to heaven. There were angels walking up and down on the ladder. The Lord stood above the ladder to confirm the promises that Jacob and his descendents would be a great nation. He also promised Jacob His protection and care.
6. God reassured Jacob that it is His will for Jacob to father a nation.
7. When Jacob awoke, he knew how special this place was and took the stone, poured oil upon it, and vowed that if God is with him then God will be his God. Jacob named the place Bethel.



Jacob had a dream.  
Genesis 28:10-22

**Jacob's Dream**  
**Angels Of God Ascending And Descending**  
**Genesis 28:10-22**





"I am the LORD  
God of Abraham,  
and the God of  
Isaac... behold, I am  
with you..."

"Happy is he  
that has the  
God of  
Jacob for  
his help..."

Psalm  
146:5a

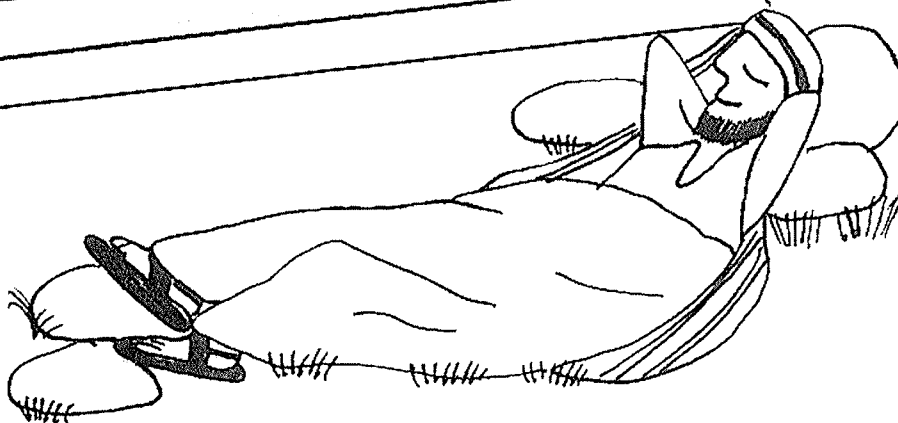

# JACOB WRESTLES AN ANGEL

Genesis 32:22-32.

Trace over the dotted line to see what Jacob and the angel were doing.

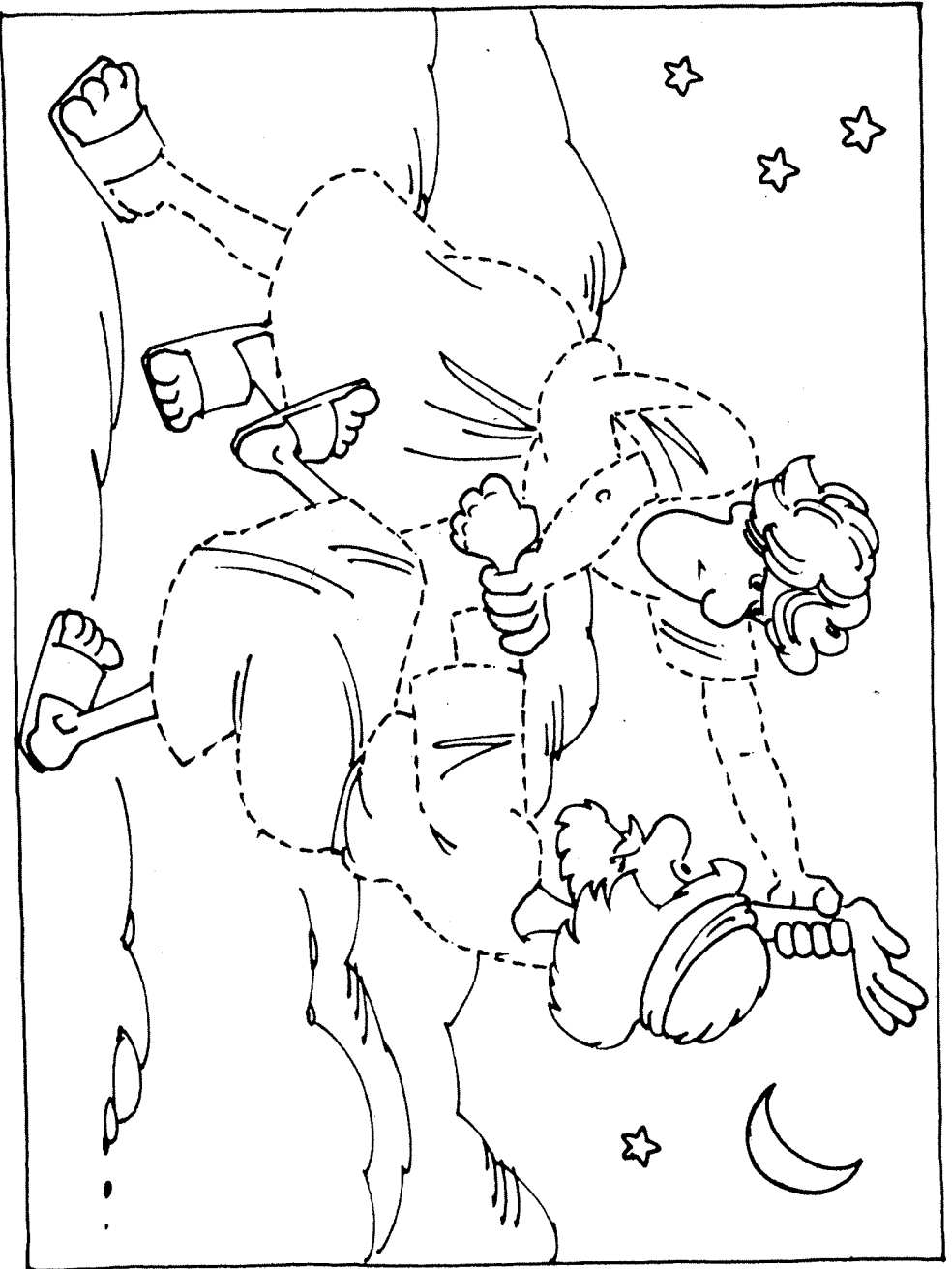

One night Jacob was sleeping on a hillside. Suddenly an angel of God came and fought with Jacob. When the angel left, he told Jacob that his name would now be Israel, which means "one who has wrestled with God."

# Jacob's Ladder Word Search

T J J G F S S N A H V O F I S  
P A P N L B T T E W T N D U W  
R C G E N E R A T I O N S K P  
O O H V K H L O I R H L E R U  
M B B A V O W E A R E O O T W  
I S L E G N A L H E W V U I C  
S Q U H W Y L C P T I A Z S H  
E N O T S I T Y H D E G Y T E  
Y N L A P A D R E A M B W S F  
W Z L A W U L N K Y I G P N P

angels  
Bethel  
dream  
generations  
Heaven  
house  
Jacob  
pillar

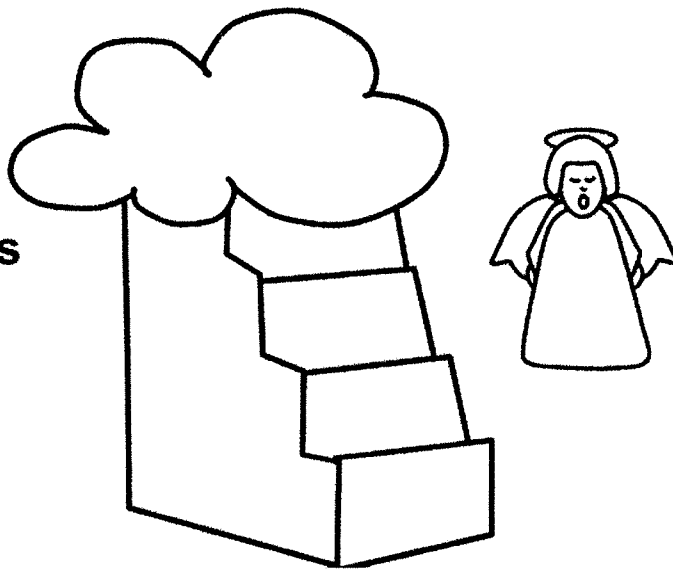

promise  
provide  
sleep  
stairway  
Stone  
tenth  
vow  
watch



# Jacob's Ladder Crossword

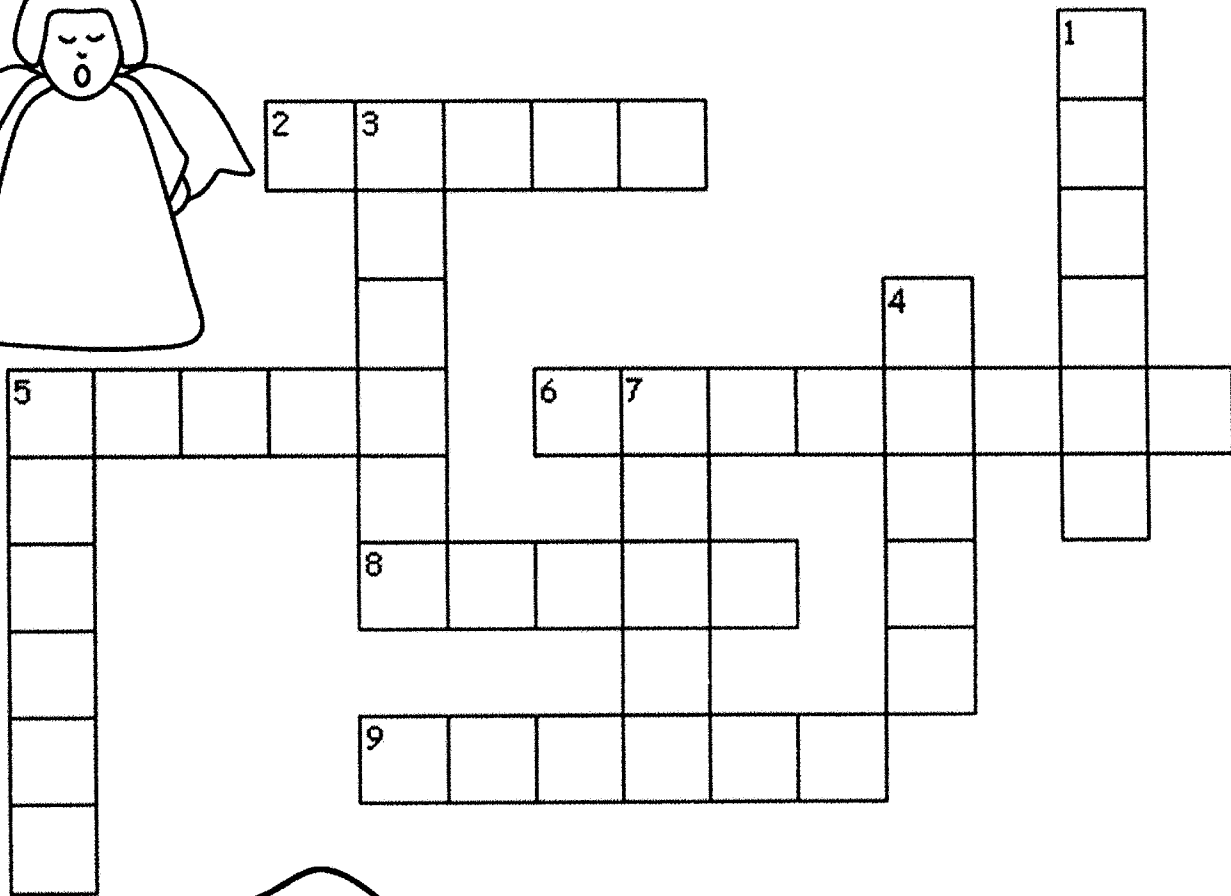

## Across

2. The Lord said he would always be with Jacob and would \_\_\_ over him.
5. The place Jacob named means \_\_\_ of God.
6. The ladder in Jacob's dream could have actually looked more like this.
8. It's amazing Jacob could sleep while resting his head on this.
9. This is what Jacob named the place he had the dream.

## Down

1. Jacob used the stone he slept on to make this, and he poured oil on it.
3. Jacob saw these moving up and down the ladder.
4. This story is all about this special way God can speak to us.
5. The ladder in the dream went from the ground to this place.
7. Jacob promised to give one \_\_\_ of all God's blessings back to Him.

# Jacob's Ladder Crossword

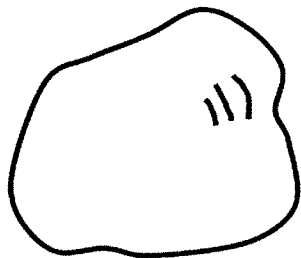
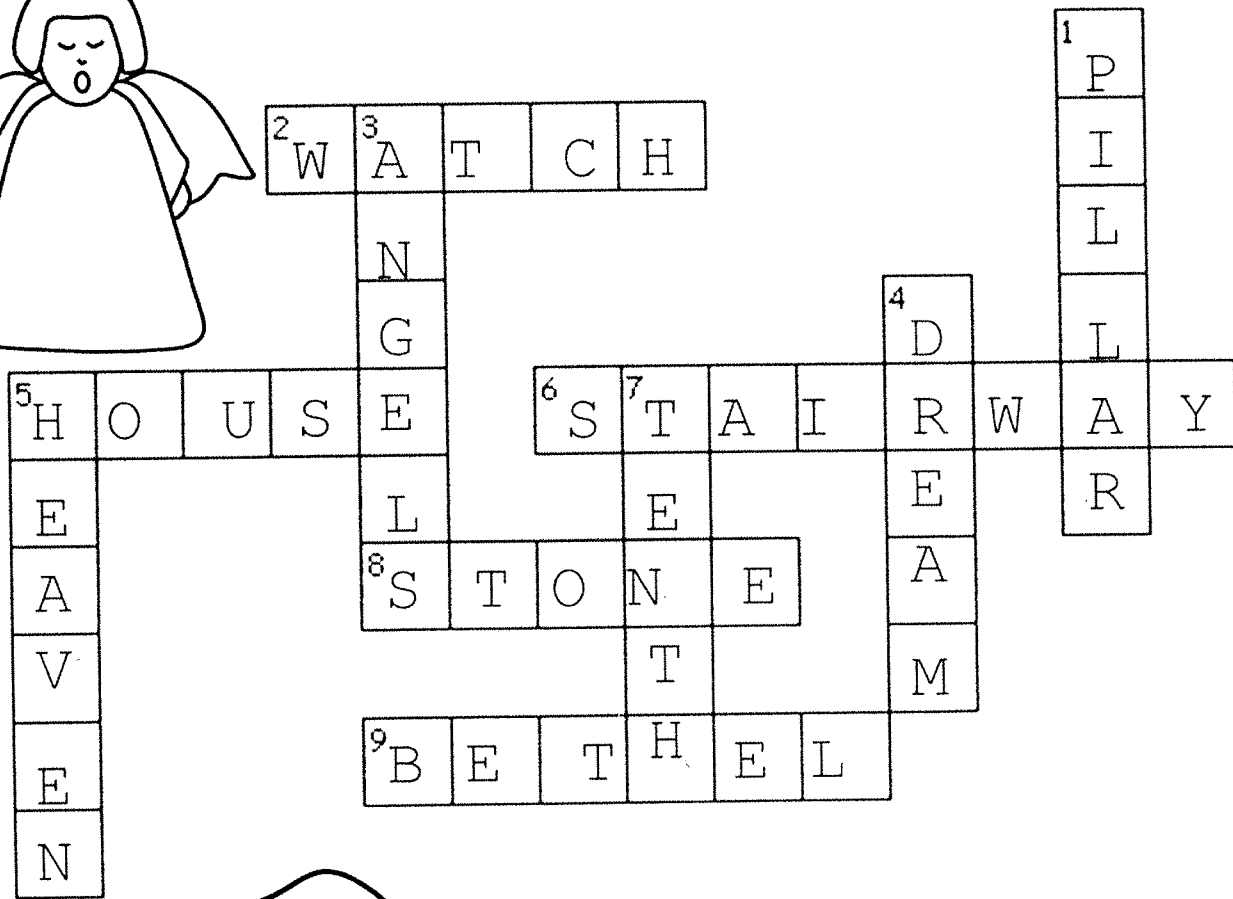

## Across

2. The Lord said he would always be with Jacob and would \_\_\_ over him.
5. The place Jacob named means \_\_\_ of God.
6. The ladder in Jacob's dream could have actually looked more like this.
8. It's amazing Jacob could sleep while resting his head on this.
9. This is what Jacob named the place he had the dream.

## Down

1. Jacob used the stone he slept on to make this, and he poured oil on it.
3. Jacob saw these moving up and down the ladder.
4. This story is all about this special way God can speak to us.
5. The ladder in the dream went from the ground to this place.
7. Jacob promised to give one \_\_\_ of all God's blessings back to Him.

# GENESIS 28:10-22

EIVG

	○	○	
--	---	---	--

ELSNAG

○	○		○		○
---	---	--	---	--	---

REAWA

	○			○
--	---	--	--	---

MAHABRA

		○	○	○	
--	--	---	---	---	--

TICY

		○	○
--	--	---	---



WHAT JACOB SAW IN HIS DREAM:

A

○	○	○	○	○	○	○	○
---	---	---	---	---	---	---	---

TO

○	○	○	○	○	○
---	---	---	---	---	---

# JACOB'S DREAM

## (GENESIS 28:10-22)

### MEMORY VERSE:

"Behold, I am with you and will keep you wherever you go." GENESIS 28:15

### CIRCLE THE CORRECT WORDS:

1. "Now Jacob went out from Beersheba and went toward Haran. So he came to a certain place and stayed there all night, because the sun had set. And he took one of the (**TREES, STONES**) of that place and put it at his (**HEAD, FEET**), and he lay down in that place to sleep." GENESIS 28:10-11
2. "Then he (**DREAMED, SNORED**), and behold, a (**LADDER, SLIDE**) was set upon the earth, and its top reached to heaven; and there the angels of God were ascending and descending on it." GENESIS 28:12

### TRUE OR FALSE:

3. "And behold, the LORD stood above it and said: 'I am the LORD God of Abraham your father and the God of Isaac; the land on which you lie I will give to you and your descendants.'" GENESIS 28:13

TRUE OR FALSE

4. The LORD also said to Jacob, "Behold, I am with you and will keep you wherever you go, and will bring you back to this land; for I will not leave you until I have done what I have spoken to you." GENESIS 28:15

TRUE OR FALSE

### FILL IN THE BLANKS:

5. "Then Jacob awoke from his sleep and said, 'Surely the \_\_\_\_\_ is in this place, and I did not know it.' And he was afraid and said, 'How \_\_\_\_\_ is this place! This is none other than the house of God, and this is the gate of heaven!' " GENESIS 28:16-17

### TRUE OR FALSE:

6. "Then Jacob rose early in the morning, and took the stone that he had put at his head, set it up as a pillar, and poured oil on top of it." GENESIS 28:18

TRUE OR FALSE

7. Jacob vowed, "This stone which I have set as a pillar shall be God's house, and of all that You give me I will surely give a tenth to You." GENESIS 28:22

TRUE OR FALSE

# JACOB'S DREAM

## (GENESIS 28:10-22)

### MEMORY VERSE:

*"Behold, I am with you and will keep you wherever you go."* GENESIS 28:15

### FILL IN THE BLANKS:

1. "Now Jacob went out from Beersheba and went toward Haran. So he came to a certain place and stayed there all night, because the sun had set. And he took one of the \_\_\_\_\_ of that place and put it at his \_\_\_\_\_, and he lay down in that place to sleep." **GENESIS 28:10-11**
2. "Then he \_\_\_\_\_, and behold, a \_\_\_\_\_ was set upon the earth, and its top reached to heaven; and there the angels of God were ascending and descending on it." **GENESIS 28:12**

### TRUE OR FALSE:

3. "And behold, the LORD stood above it and said: 'I am the LORD God of Abraham your father and the God of Isaac; the land on which you lie I will give to you and your descendants.'" **GENESIS 28:13**

TRUE OR FALSE

4. The LORD also said to Jacob, "Behold, I am with you and will keep you wherever you go, and will bring you back to this land; for I will not leave you until I have done what I have spoken to you." **GENESIS 28:15**

TRUE OR FALSE

### FILL IN THE BLANKS:

5. "Then Jacob awoke from his sleep and said, 'Surely the \_\_\_\_\_ is in this place, and I did not know it.' And he was afraid and said, 'How \_\_\_\_\_ is this place! This is none other than the house of God, and this is the gate of heaven!'" **GENESIS 28:16-17**
6. "Then Jacob rose early in the morning, and took the stone that he had put at his head, set it up as a \_\_\_\_\_, and poured \_\_\_\_\_ on top of it. And he called the name of that place \_\_\_\_\_, but the name of that city had been Luz previously." **GENESIS 28:18-19**
7. Jacob vowed, "This stone which I have set as a pillar shall be God's \_\_\_\_\_, and of all that You give me I will surely give a tenth to You." **GENESIS 28:22**

# JACOB'S DREAM

(GENESIS 28:10-22)

I G T E N T H Q B E S B O L F  
 B E V I G S C L P R E S N U W  
 F S R O V V E I M W N L I L H  
 D V J O X H L P K X O E G E P  
 U D O Q T L H W E D T E H W J  
 S F Z E A A S T D A S P T R Y  
 S M B R R L B M E K C N D E T  
 D E M A E R D I S Y V E D D P  
 I V R G C A Y Y S Q Y C O D P  
 J O N Y P O O T E R C E G A V  
 A A J M G O C O L V S F D L N  
 C T Z S A W I X B U A J R A B  
 O W T B T L K N O B H N O W A  
 B N M J E C S H M Q L O L M H  
 O F C H M Y Z Z Q E R Z W B L

ANGELS  
 JACOB  
 SLEEP  
 GATE  
 OIL

HOUSE  
 PILLAR  
 DREAMED  
 NIGHT

PEACE  
 BLESSED  
 LORD GOD  
 TENTH

BETHEL  
 LADDER  
 STONES  
 GIVE



# JACOB'S DREAM

## (GENESIS 28:10-22)

W D E Z B M X K T S G C K E J W R D R K T K I U C  
 P P E E L S R K A V E G C J C U L D Y A H O U S E  
 P J O E Q X A Q N M U R U K V B W O Y T M S K V M  
 W Q V K Y T L J R A W G M K N D E K D W O M X Z P  
 Q I O B E Y L B P Z D N D P I D E T J L E O P A O  
 G I C Z L L I B I S W G L Z G S J S H A N G E L S  
 T J F F N I P R Q H Y Z S Y H J U Q S E M A P U E  
 A K A D E M A E R D P J V Y T H O K I E L T U E A  
 U T K C V O P B D M Z P R O T Q E L P A L M Z F Y  
 U D B H O V E E J K W N C J W O P W T P X B V P U  
 H Y Y N Q B T K Q S B U M F H E R E D D A L F T H  
 T H N G T A S E R V M O D A P E T K V P N Z R O A  
 E U M X G Q G F I O W F L E N W C I R A O J K N E  
 N Q H G A Z D J L J U L B O S E S J F L B S K I C  
 T S G N I D N E C S A L T H J C C S E V U M Y J N  
 H S L R Q U E T S J F S L A H B E U J Q L X R J A  
 E I D Q F A P E T E I M A H Q K H N O D P P G Y I  
 R L R I H N Z J F A X S C Z O S U E D V M C I T Z  
 J S E P P M C Z A W G Z W Y A U E E U I C D K H S  
 S J U H J G C Z Y L Y L J N W H C A G S N T L I O  
 L O R D G O D K Y Z P P U J V A C V N M C G U G N  
 T F W Z T F Q C O X Y G K T E P N D K C V X A F C  
 A F J I B H I T F P B K O P M E Q Q D Z Z X V Y Z  
 Z O N V I A W I V J D B I P F V L E B L K G X Q X  
 S P S V A W Z O X H R U T L S A K N K U F E O D R

ANGELS  
 PEACE  
 LADDER  
 DREAMED

GIVE  
 BETHEL  
 SLEEP  
 NIGHT

OIL  
 JACOB  
 DESCENDING  
 TENTH

ASCENDING  
 PILLAR  
 LORD GOD  
 GATE

HOUSE  
 BLESSED  
 STONE



# JACOB'S DREAM

## (GENESIS 28:10-22)

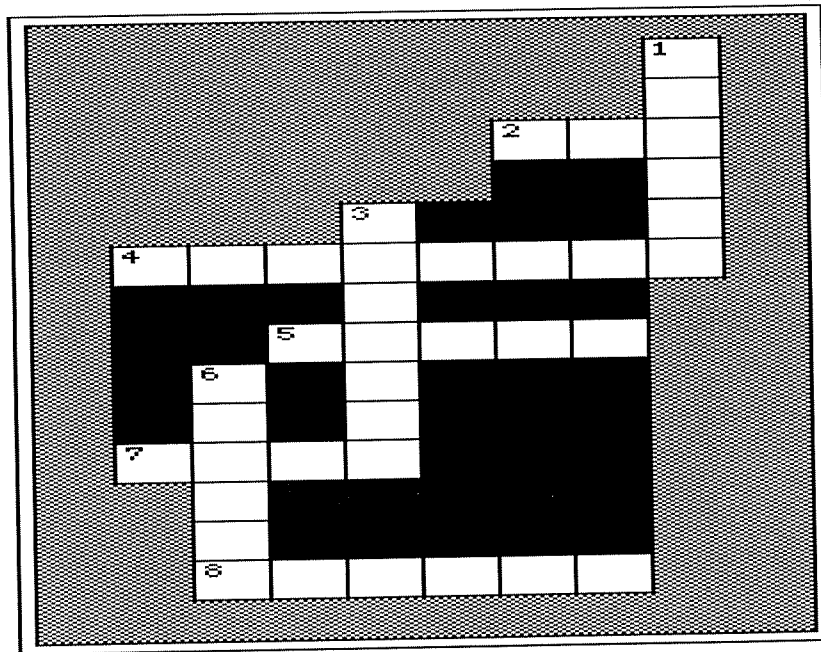

- 4 ACROSS "Behold, I am with you and will keep you \_\_\_\_\_ you go." **GENESIS 28:15**
- 6 DOWN "Now Jacob went out from Beersheba and went toward Haran. So he came to a certain place and stayed there all night, because the sun had set. And he took one of the \_\_\_\_\_ of that place and put it at his feet, and he lay down in that place to sleep." **GENESIS 28:10-11**
- 3 DOWN "Then he \_\_\_\_\_, and behold, a ladder was set upon the earth, and its top reached to heaven; and there the angels of God were ascending and descending on it." **GENESIS 28:12**
- 7 ACROSS "And behold, the \_\_\_\_\_ stood above it and said: 'I am the LORD God of Abraham your father and the God of Isaac; the land on which you lie I will give to you and your descendants.'" **GENESIS 28:13**
- 8 ACROSS The LORD also said to Jacob, "Behold, I am with you and will keep you wherever you go, and will bring you back to this land; for I will not leave you until I have done what I have \_\_\_\_\_ to you."  
**GENESIS 28:15**
- 5 ACROSS "Then \_\_\_\_\_ awoke from his sleep and said, 'Surely the LORD is in this place, and I did not know it.' And he was afraid and said, 'How awesome is this place! This is none other than the house of God, and this is the gate of heaven!'" **GENESIS 28:16-17**
- 2 ACROSS "Then Jacob rose early in the morning, and took the stone that he had put at his head, set it up as a pillar, and poured \_\_\_\_\_ on top of it." **GENESIS 28:18**
- 1 DOWN Jacob vowed, "This stone which I have set as a \_\_\_\_\_ shall be God's house, and of all that You give me I will surely give a tenth to You." **GENESIS 28:22**



## Middle School

Genesis 27:46-Genesis 28:22  
Lesson 19--Jacob's Dream

Name \_\_\_\_\_

**27:46** Then Rebekah said to Isaac, "I'm disgusted with living because of these Hittite women. If Jacob takes a wife from among the women of this land, from Hittite women like these, my life will not be worth living."

**28:1** So Isaac called for Jacob and blessed him and commanded him: "Do not marry a Canaanite woman. **2** Go at once to Paddan Aram, to the house of your mother's father Bethuel. Take a wife for yourself there, from among the daughters of Laban, your mother's brother. **3** May God Almighty bless you and make you fruitful and increase your numbers until you become a community of peoples. **4** May he give you and your descendants the blessing given to Abraham, so that you may take possession of the land where you now live as an alien, the land God gave to Abraham." **5** Then Isaac sent Jacob on his way, and he went to Paddan Aram, to Laban son of Bethuel the Aramean, the brother of Rebekah, who was the mother of Jacob and Esau.

**6** Now Esau learned that Isaac had blessed Jacob and had sent him to Paddan Aram to take a wife from there, and that when he blessed him he commanded him, "Do not marry a Canaanite woman," **7** and that Jacob had obeyed his father and mother and had gone to Paddan Aram. **8** Esau then realized how displeasing the Canaanite women were to his father Isaac; **9** so he went to Ishmael and married Mahalath, the sister of Nebaioth and daughter of Ishmael son of Abraham, in addition to the wives he already had.

**10** Jacob left Beersheba and set out for Haran. **11** When he reached a certain place, he stopped for the night because the sun had set. Taking one of the stones there, he put it under his head and lay down to sleep. **12** He had a dream in which he saw a stairway resting on the earth, with its top reaching to heaven, and the angels of God were ascending and descending on it. **13** There above it stood the Lord, and he said: "I am the Lord, the God of your father Abraham and the God of Isaac. I will give you and your descendants the land on which you are lying. **14** Your descendants will be like the dust of the earth, and you will spread out to the west and to the east, to the north and to the south. All peoples on earth will be blessed through you and your offspring. **15** I am with you and will watch over you wherever you go, and I will bring you back to this land. I will not leave you until I have done what I have promised you."

1. What is Rebekah upset about in Gen. 27:46?
2. Look at Gen. 26:34-35. What's the problem?
3. In Gen. 27, Jacob with his mother's help had deceived Isaac to get the blessing instead of Esau. Now in Gen. 28 Isaac willingly blesses Jacob. Look back at Gen. 25:23. What did God tell Rebekah before the twins were born?
4. What does Isaac command Jacob to do about finding a wife?
5. How is Jacob's experience in finding a wife different than his father's?
6. Highlight the blessing Isaac gives Jacob in verses 3 and 4. Why does this sound familiar?
7. What does Esau finally realize about his marriages?
8. What does Esau do to try to please his father?
9. Notice how important and serious it is to God that you marry the right person!
10. Think about the consequences to Jacob's actions in deceiving his father and angering his brother. What's his situation now?
11. Notice Jacob is alone and unprotected. Why is this the ideal time for God to speak to Jacob?
12. What is Jacob's dream?
13. Highlight the blessing and promise God gives to Jacob in verses 13-15. How will "all peoples on earth" be blessed through Jacob and his offspring?
14. How long will it be before God brings Jacob back to this land?

**Year 1**  
**Week 20**

## **Jacob Works for a Wife**

**Scriptures: Genesis 29, 30: 1-24**

**Key Verse: Genesis 29:20 "So Jacob served seven years for Rachel, and they seemed only a few days to him because of the love he had for her."**

### **Key Points:**

1. Jacob went on his journey to find a wife from God's special people.
2. He met Rachel at a well where she comes to water her father's sheep. He loved her at first sight.
3. Jacob agreed to work for Laban 7 years to gain Rachel for his wife.
4. Jacob served his 7 years for Rachel, but Laban tricked him after a feast and brought his daughter Leah to him instead. So Jacob agreed with Laban that he would be with Leah for 1 week, then he could have Rachel also. However, Laban required that he stay and work another 7 years for Rachel.
5. Jacob loved Rachel more than Leah, therefore there was quite a jealousy between them. God allowed Leah to bear children. Rachel was desperate for children but could not bear, so she gave some of her slaves to Jacob to have children that she could claim as hers. After a time, Leah was no longer having children, so she also gave Jacob her slave to have children.
6. God did remember Rachel and allowed her to have a son, Joseph.

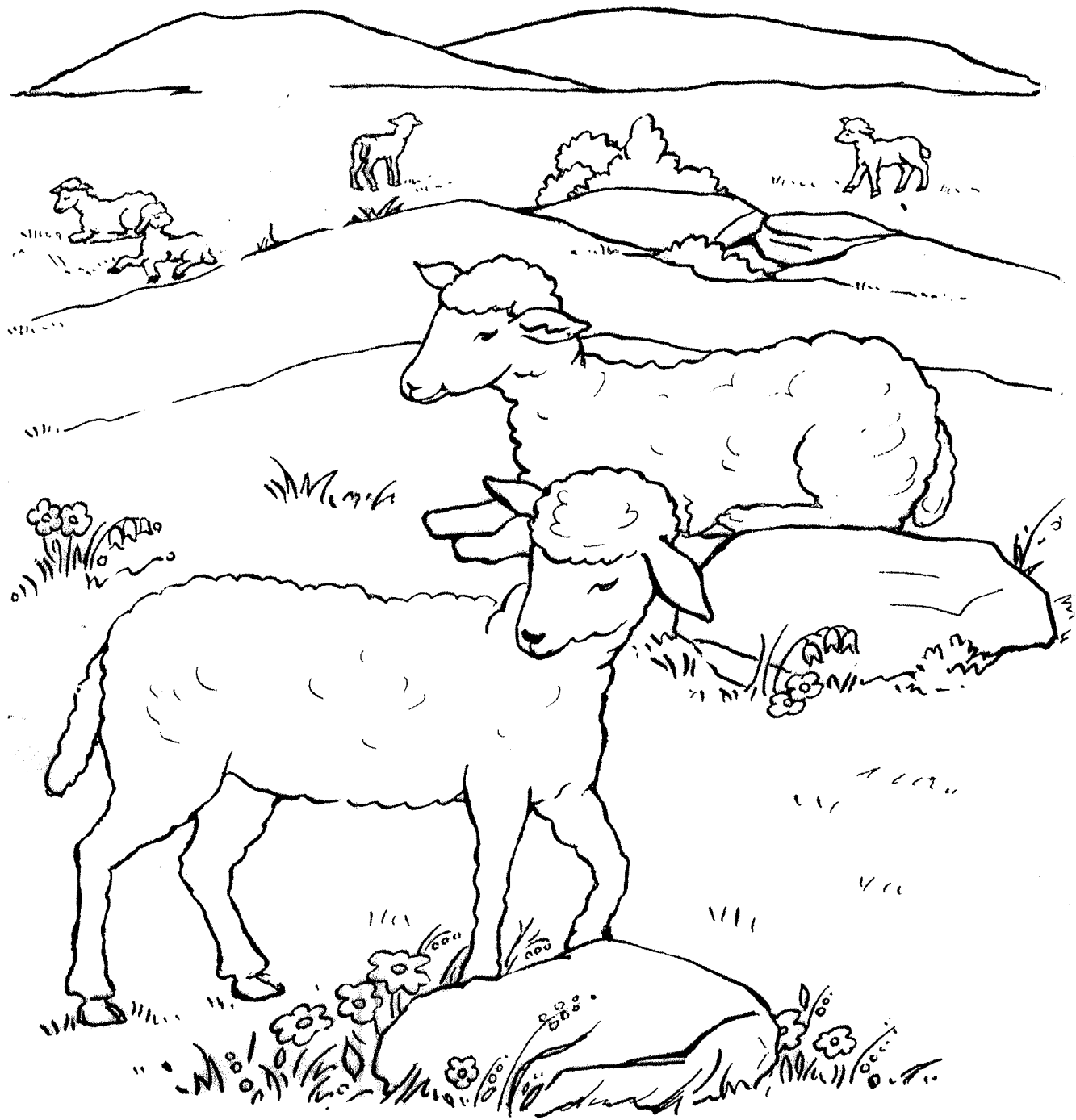

Genesis 29:9-

“... Rachel came with her father’s sheep for she was a shepherdess.”





Jacob and Rachel - Love at First Sight

BibleWise

## Rachel Fetches Water Maze

Start at the beginning and find your way through Rachel's water jug.

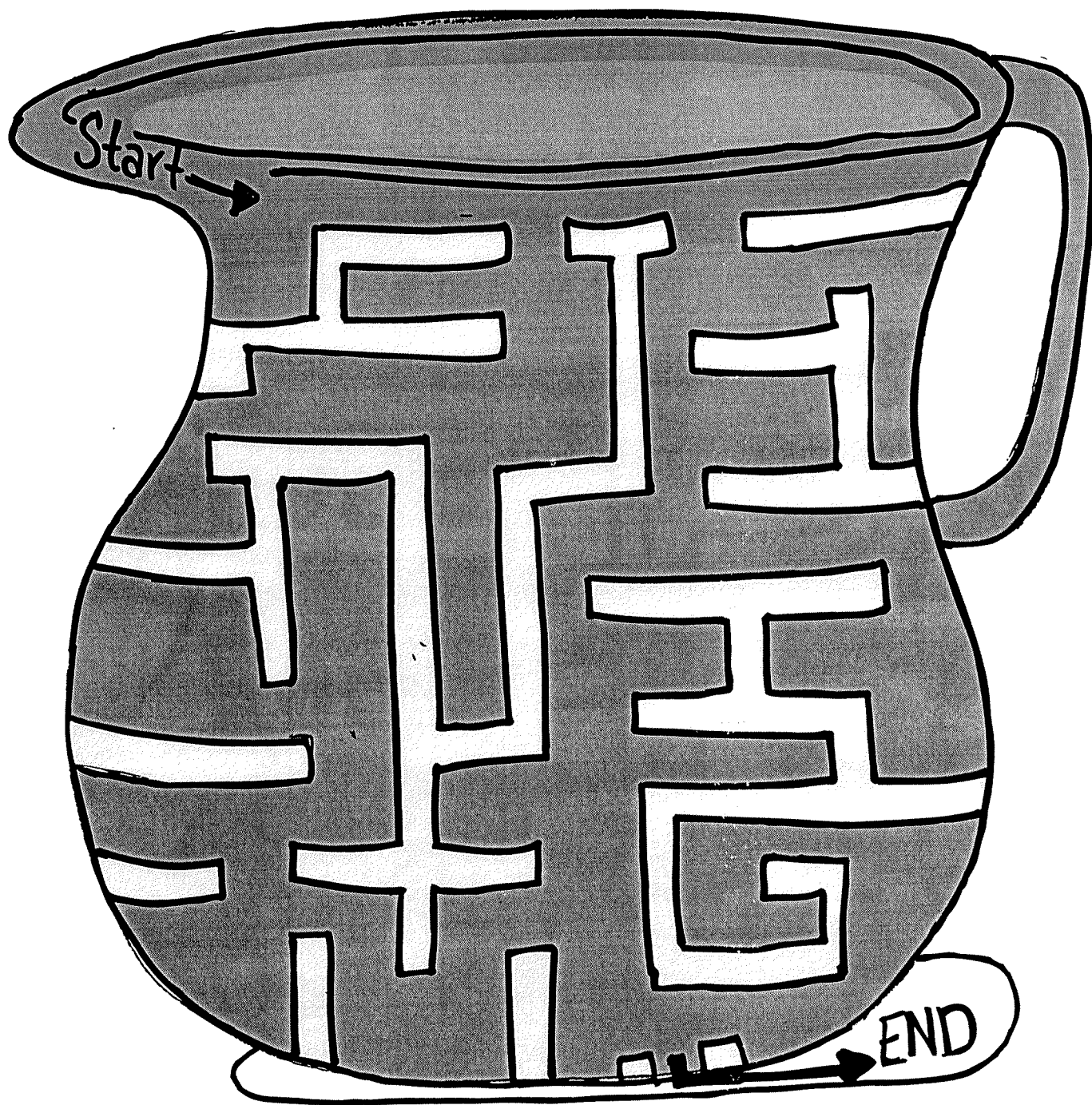

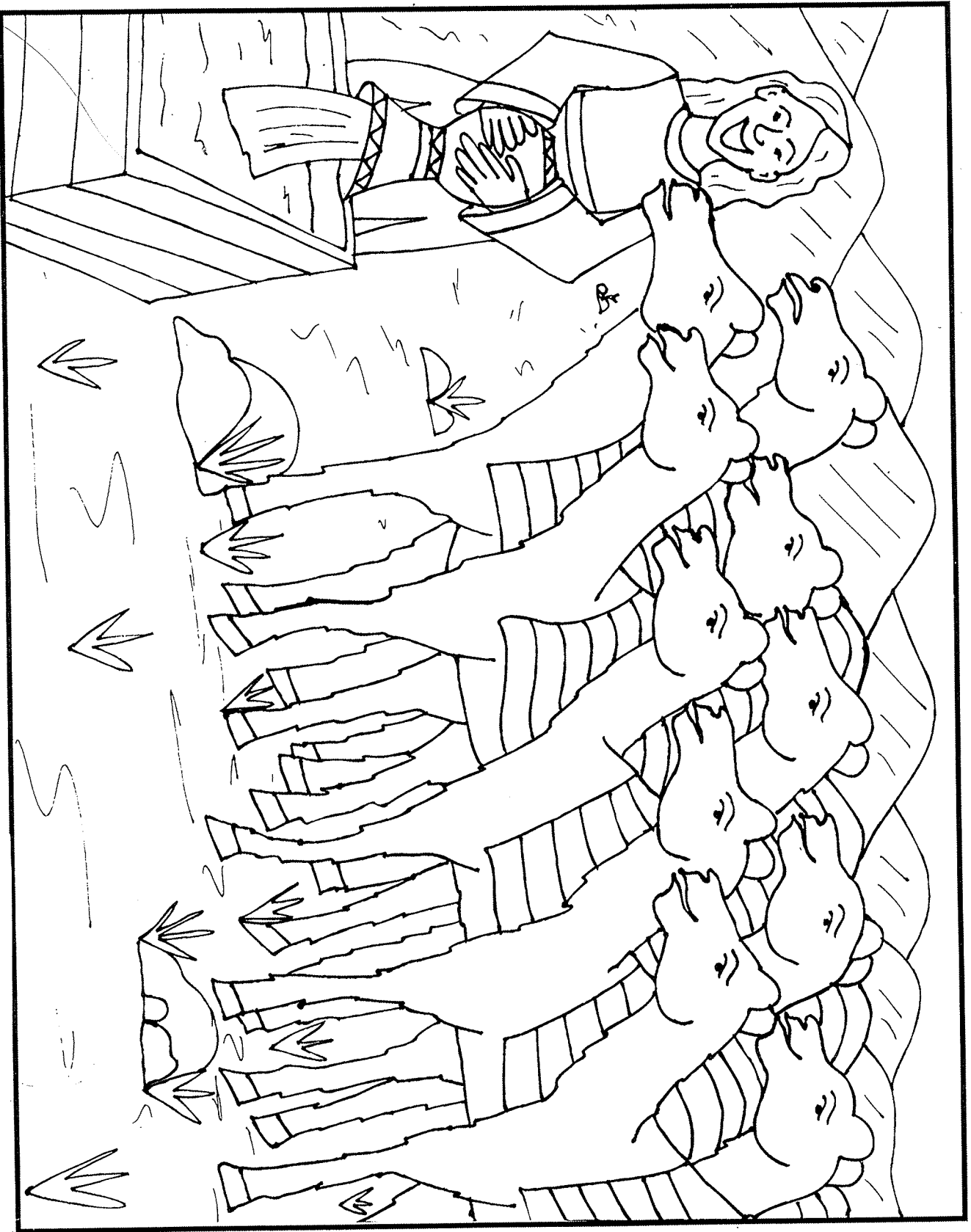

***How many camels did Rachael give  
water to? \_\_\_\_\_***

# LEAH & RACHEL

(GENESIS 29:1-30)

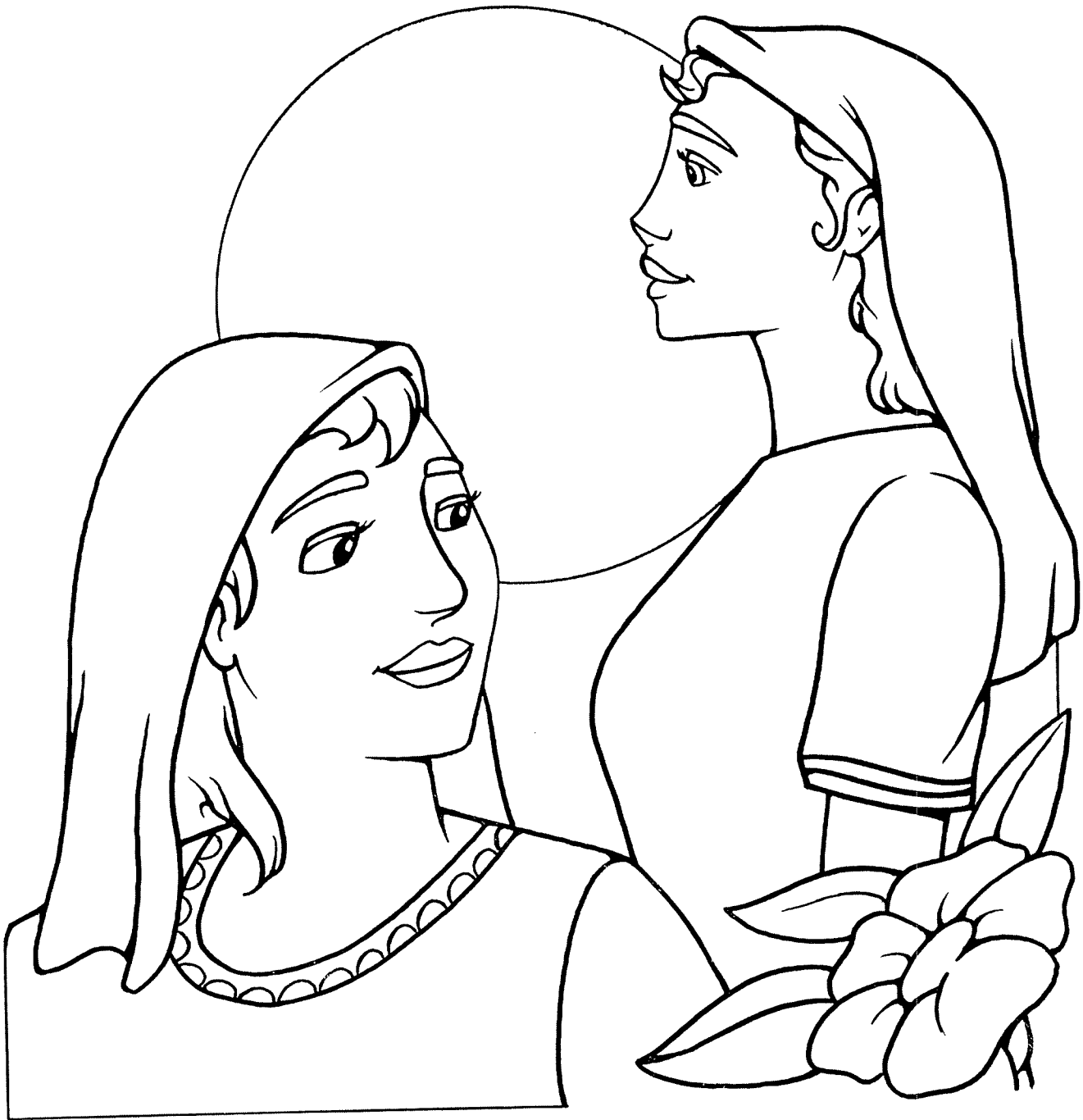

"And Laban had two daughters: the name of the elder was Leah, and the name of the younger was Rachel."

**GENESIS 29:16**





# Jacob & Rachel

And then Laban gave him his daughter Rachel to be his wife.  
Genesis 29:28b (NIV)

The puzzle is based on Genesis 29:15-28

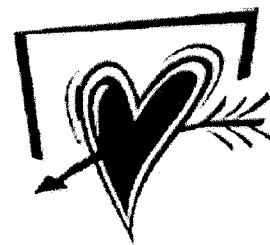

## A Love Story

L F V E Y K I P N D C N R J Q  
P O F P B M L A R X J O Z O D  
I I V O K E B E S T M L U X I  
W R C E H A T A J Q Y D P R D  
I A W C L H W O R K F E S K Q  
J F A B G C I U A D G R A K M  
D R Y U E G L I F T H B Q R V  
E B A Y N A W E W C N H S K S  
C D K E U A U P A A B A E G B  
E F B C W W M T C H I M V F O  
I I J I P R G E I B K L E N S  
V G S N N M H J P F U V N S C  
E Y X F M K V T Y O U N G E R  
D I R B I B I N V H W L R J Y  
I D Q E M K V A D W E T T D Q

WIFE	LABAN	LOVE	RACHEL	BEAUTIFUL
JACOB	LEAH	NAME	SEVEN	DAUGHTER
YOUNGER	WORK	DECEIVED	OLDER	YEARS

name \_\_\_\_\_

## Rachel and Leah

D	S	Z	H	L	O	W	I	C	N	J	A	E	U	T	Y	Q	R	N	P
I	D	R	L	O	L	H	F	F	A	R	F	S	Q	V	W	O	A	A	E
M	A	Z	N	V	D	L	V	C	Z	S	O	D	M	X	N	B	N	N	I
W	X	L	U	E	Y	I	O	N	V	J	K	B	R	Q	A	A	J	F	U
U	U	D	R	D	S	B	E	L	W	V	D	C	T	L	R	B	P	T	G
J	U	Z	I	A	H	R	M	Y	W	A	X	K	O	S	H	S	B	B	F
V	J	R	E	P	C	I	A	B	A	R	R	E	N	L	R	A	S	T	X
O	I	I	Y	D	Q	N	K	E	X	F	G	D	O	E	F	I	E	C	E
R	S	M	W	L	N	B	U	R	Y	F	Z	O	L	R	G	V	F	L	V
Q	I	D	M	Z	W	I	A	A	G	N	L	Q	C	I	T	F	B	K	R
O	U	Q	E	E	N	C	D	C	G	A	E	B	E	W	R	Z	E	X	E
U	F	A	A	R	Y	E	X	H	F	V	T	V	C	H	W	T	U	D	S
R	L	O	R	V	V	G	U	E	J	B	V	I	E	Z	K	H	U	O	E
S	S	M	O	I	I	F	E	L	F	I	S	U	M	S	E	L	O	R	D
R	M	T	E	H	U	K	P	F	I	F	Y	X	M	J	A	F	L	N	F
O	S	C	O	P	T	V	K	X	R	T	X	D	F	R	R	F	I	Y	Z
Q	E	F	Y	N	L	B	N	F	F	L	M	F	V	B	W	Y	M	W	Y
D	X	W	S	I	E	O	M	F	B	Y	V	V	J	Z	M	Z	U	I	Q
D	R	S	M	U	N	H	X	J	R	J	H	R	O	I	T	M	U	X	M
G	T	N	K	H	H	C	C	B	W	B	U	U	P	H	X	F	B	V	S

JACOB	LOVED
LABAN	RACHEL
LEAH	SERVE
LORD	SEVENYEARS
BARREN	DECEIVED
STONE	FIRSTBORN
WIFE	FLOCKS

**Verse Jan 13, 2013**

Genesis 29:20

So Jacob served  
seven years for Rachel,  
and they seemed only  
a few days to him  
because of the love  
he had for her.

**Verse Jan 13, 2013**

Genesis 29:20

So Jacob served  
seven years for Rachel,  
and they seemed only  
a few days to him  
because of the love  
he had for her.

**Verse Jan 13, 2013**

Genesis 29:20

So Jacob served  
seven years for Rachel,  
and they seemed only  
a few days to him  
because of the love  
he had for her.

**Verse Jan 13, 2013**

Genesis 29:20

So Jacob served  
seven years for Rachel,  
and they seemed only  
a few days to him  
because of the love  
he had for her.

# LEAH & RACHEL

(GENESIS 29:1-30)

V T J N Q P E F A M V W I F E  
 I Q K A S N P O G J B K C N W  
 O D S S T R I J W K G R C Y L  
 N H E Y H K A R A C H E L M W  
 L A M V H E Y E A G C E H A W  
 O U J Q I B P S Y E V R E S Z  
 R U T S T E N H F N Z N R S O  
 D T A S T O C R E N E C E V A  
 H T A K S O B E O R E V M Y K  
 I D N C T C N W D B D R E K L  
 U D E O L D B E U J T E R S N  
 A Q N L R O P S L H A S S A U  
 F C Q F R W V S T E H C R S B  
 L A B A N K P E O G A V O I D  
 F U N U W I Y I D D K H Q B F

BARREN  
 DECEIVED  
 FIRSTBORN  
 FLOCKS  
 JACOB  
 LABAN

LEAH  
 LORD  
 LOVED  
 RACHEL  
 SERVE

SEVEN YEARS  
 SHEPHERDESS  
 SONS  
 STONE  
 WIFE

WRITE DOWN THE LETTERS AS YOU COME TO THEM ON THE LINES BELOW

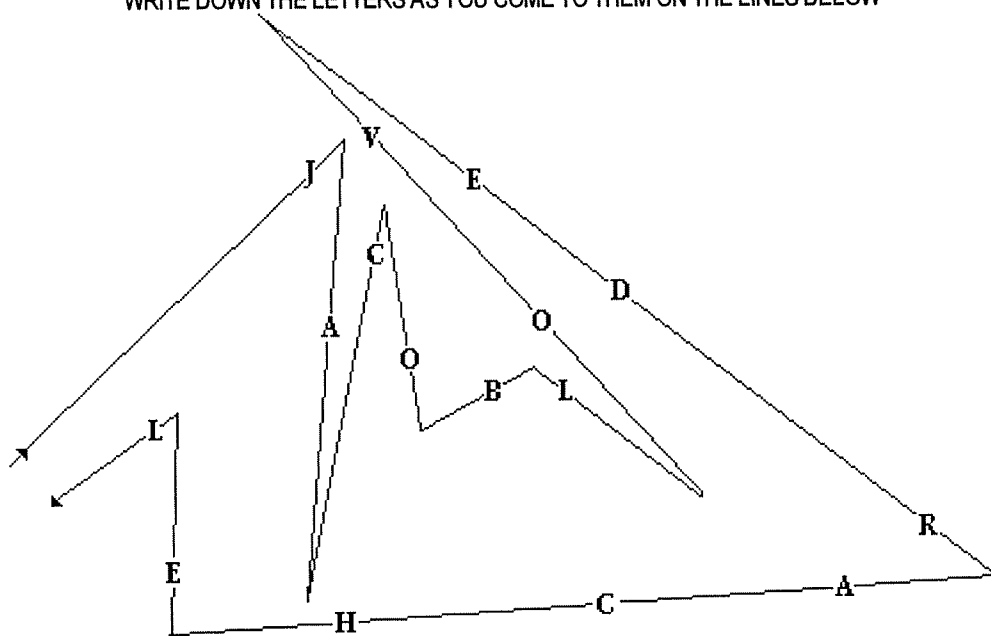

# LEAH & RACHEL

## (GENESIS 29:1-30)

### MEMORY VERSE:

*"The wicked man does deceptive work, but to him who sows righteousness will be a sure reward."* PROVERBS 11:18

### CIRCLE THE CORRECT WORDS:

1. "And it came to pass, when Jacob saw (**REBEKAH, RACHEL**) the daughter of Laban his mother's brother, and the (**COWS, SHEEP**) of Laban his mother's brother, that Jacob went near and rolled the stone from the well's mouth, and watered the flock of Laban his mother's brother." **GENESIS 29:10**
2. "And Jacob told Rachel that he was her father's relative and that he was Rebekah's son. So she (**RAN, WALKED**) and told her father." **GENESIS 29:12**

### FILL IN THE BLANKS:

3. "Now Laban had two daughters: the name of the elder was \_\_\_\_\_, and the name of the younger was \_\_\_\_\_." **GENESIS 29:16**

### TRUE OR FALSE:

4. "Leah's eyes were delicate, but Rachel was beautiful of form and appearance." **GENESIS 29:17**  
**TRUE OR FALSE**
5. "Now Jacob loved Rachel; and he said, 'I will serve you seven years for Rachel your younger daughter.'" **GENESIS 29:18**  
**TRUE OR FALSE**

### CIRCLE THE CORRECT WORDS:

6. "So Jacob served seven years for Rachel, and they seemed but a few (**DAYS, YEARS**) to him because of the love he had for her." **GENESIS 29:20**
7. When Laban tricked Jacob into marrying his older daughter Leah, Jacob asked, "What is this you have done to me? Was it not for Rachel that I served you? Why then have you (**DECEIVED, BELIEVED**) me?" **GENESIS 29:25**
8. "And (**LABAN, YUBAN**) said, 'It must not be done so in our country, to give the younger before the firstborn.'" **GENESIS 29:26**
9. Now Jacob "loved Rachel more than Leah. And he served with Laban still another (**SEVEN, SEVENTY**) years." **GENESIS 29:30**

# LEAH & RACHEL

## (GENESIS 29:1-30)

### MEMORY VERSE:

"The wicked man does deceptive work, but to him who sows righteousness will be a sure reward." PROVERBS 11:18

### FILL IN THE BLANKS:

1. "And it came to pass, when \_\_\_\_\_ saw \_\_\_\_\_ the daughter of Laban his mother's brother, and the \_\_\_\_\_ of Laban his mother's brother, that Jacob went near and rolled the stone from the well's mouth, and watered the flock of Laban his mother's brother."  
**GENESIS 29:10**
2. "And Jacob told Rachel that he was her father's relative and that he was Rebekah's son. So she \_\_\_\_\_ and told her father." **GENESIS 29:12**
3. "Now Laban had two daughters: the name of the elder was \_\_\_\_\_, and the name of the younger was \_\_\_\_\_." **GENESIS 29:16**

### TRUE OR FALSE:

4. "Leah's eyes were delicate, but Rachel was beautiful of form and appearance."  
**GENESIS 29:17**  
**TRUE OR FALSE**
5. "Now Jacob loved Rachel; and he said, 'I will serve you seven years for Rachel your younger daughter.' "**GENESIS 29:18**  
**TRUE OR FALSE**

### CIRCLE THE CORRECT WORDS:

6. "So Jacob served seven years for Rachel, and they seemed but a few (**DAYS, YEARS**) to him because of the love he had for her." **GENESIS 29:20**
7. When Laban tricked Jacob into marrying his older daughter Leah, Jacob asked, "What is this you have done to me? Was it not for Rachel that I served you? Why then have you (**DECEIVED, BELIEVED**) me?" **GENESIS 29:25**

### FILL IN THE BLANKS:

8. "And Laban said, 'It must not be done so in our country, to give the younger before the \_\_\_\_\_.'" **GENESIS 29:26**
9. Now Jacob "loved Rachel more than Leah. And he served with Laban still \_\_\_\_\_ seven years." **GENESIS 29:30**

# LEAH & RACHEL

name \_\_\_\_\_

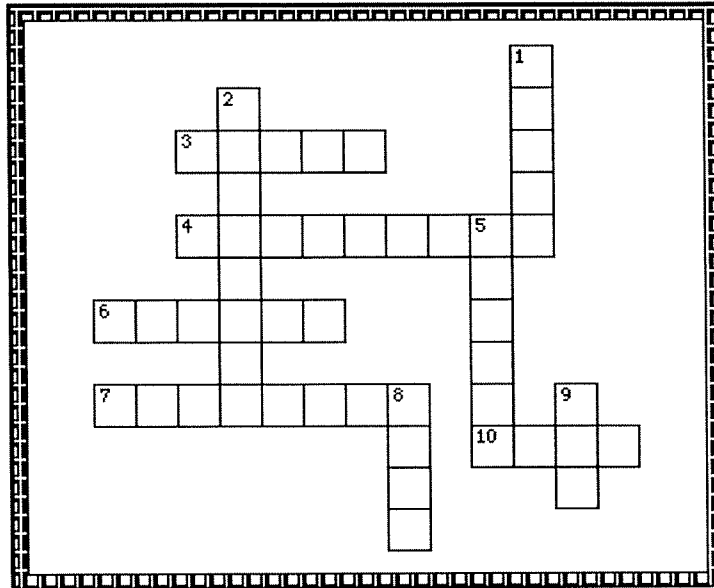

- 6 ACROSS PROVERBS 11:18

"The wicked man does deceptive work, but to him who sows righteousness will be a sure \_\_\_\_\_."

- 5 DOWN GENESIS 29:10

"And it came to pass, when Jacob saw \_\_\_\_\_ the daughter of Laban his mother's brother, and the sheep of Laban his mother's brother, that Jacob went near and rolled the stone from the well's mouth, and watered the flock of Laban his mother's brother."

- 9 DOWN GENESIS 29:12

"And Jacob told Rachel that he was her father's relative and that he was Rebekah's son. So she \_\_\_\_\_ and told her father."

- 10 ACROSS GENESIS 29:16

"Now Laban had two daughters: the name of the elder was \_\_\_\_\_, and the name of the younger was Rachel."

- 2 DOWN GENESIS 29:17

"Leah's eyes were \_\_\_\_\_, but Rachel was beautiful of form and appearance."

- 3 ACROSS GENESIS 29:18

"Now Jacob loved Rachel; and he said, 'I will \_\_\_\_\_ you seven years for Rachel your younger daughter.' "

- 8 DOWN GENESIS 29:20

"So Jacob served seven years for Rachel, and they seemed but a few \_\_\_\_\_ to him because of the love he had for her."

- 7 ACROSS GENESIS 29:25

When Laban tricked Jacob into marrying his older daughter Leah, Jacob asked, "What is this you have done to me? Was it not for Rachel that I served you? Why then have you \_\_\_\_\_ me?"

- 4 ACROSS GENESIS 29:26

"And Laban said, 'It must not be done so in our country, to give the younger before the \_\_\_\_\_.' "

- 1 DOWN GENESIS 29:3

Now Jacob "loved Rachel more than Leah. And he served with Laban still another \_\_\_\_\_ years."



**LEAH & RACHEL (GENESIS 29:1-30)**

name \_\_\_\_\_

**FILL IN THE BLANKS:**

1. "And it came to pass, when \_\_\_\_\_ saw \_\_\_\_\_ the daughter of Laban his mother's brother, and the \_\_\_\_\_ of Laban his mother's brother, that Jacob went near and rolled the stone from the well's mouth, and watered the flock of Laban his mother's brother."  
GENESIS 29:10
2. "And Jacob told Rachel that he was her father's relative and that he was Rebekah's son. So she \_\_\_\_\_ and told her father." GENESIS 29: 12
3. "Now Laban had two daughters: the name of the elder was \_\_\_\_\_, and the name of the younger was \_\_\_\_\_." GENESIS 29: 16

**TRUE OR FALSE:**

"Leah's eyes were delicate, but Rachel was beautiful of form and appearance." GENESIS 29: \_\_\_\_  
TRUE OR FALSE

"Now Jacob loved Rachel; and he said, 'I will serve you seven years for Rachel your younger daughter.' "

GENESIS 29: \_\_\_\_ TRUE OR FALSE

**CIRCLE THE CORRECT WORDS:**

"So Jacob served seven years for Rachel, and they seemed but a few ( DAYS YEARS ) to him because of the love he had for her." GENESIS 29: 20

When Laban tricked Jacob into marrying his older daughter Leah, Jacob asked,

"What is this you have done to me? Was it not for Rachel that I served you?"

Why then have you ( DECEIVED BELIEVED ) me?"

GENESIS 29: 25

**FILL IN THE BLANKS:**

GENESIS 29:26

"And Laban said, 'It must not be done so in our country, to give the younger before the \_\_\_\_\_.' "

GENESIS 29:30

Now Jacob "loved Rachel more than Leah. And he served with Laban still \_\_\_\_\_ seven years."

# Story & Questions

Have you ever played a trick on someone? Was it a funny trick or a nasty trick? Sometimes when you play a trick on someone it is funny - but sometimes it isn't. Sometimes it really hurts. Remember that Jacob tricked his father into giving him the blessing instead of giving it to his brother Esau. That wasn't a very nice trick, was it. Esau was so angry, in fact, that he planned to kill Jacob.

So Jacob ran away to Harran, and along the way one night he met God in a dream of a ladder reaching up to heaven. Remember that when you meet God your life gets changed. Let's see how God begins to change Jacob...

Verse 21

**Finally, the time came for Jacob to marry Rachel. "I have fulfilled my agreement," Jacob said to Laban. "Now give me my wife so I can marry her"**

**So Laban invited everyone in the neighborhood and prepared a wedding feast. <sup>23</sup> But that night, Laban tricked Jacob and had him marry Leah instead of Rachel.**

**"What have you done to me?" Jacob raged at Laban. "I worked seven years for Rachel! Why have you tricked me?"**

**"It's not our custom here to marry off a younger daughter ahead of the firstborn," Laban replied. You have to work seven more years for me to marry my other daughter.**

**So Jacob agreed to work seven more years. And he was able to marry Rachel, too. He loved her much more than Leah.**

**When the LORD saw that Leah was unloved, he enabled her to have children, but Rachel could not. So Leah had her first son, named him Reuben. She soon again had another son. She named him Simeon. Leah had many sons with Jacob and each time she hoped that Jacob would love her more than Rachel.**

**When Rachel saw that she wasn't having any children for Jacob, she became jealous of her sister. Jacob told her to pray to God because he is in control. One day God answered her prayers by letting her have a baby. She said "God has removed my disgrace," And she named him Joseph, for she said, "May the LORD add yet another son to my family."**

1. Who were the relatives of Jacob whom he met in Canaan?
2. What pay did Jacob agree to receive for working 7 years for Jacob?
3. Why was he willing to wait that long? Do you have the patience to wait that long?
4. What happened on the day Jacob got married?
5. Why was it that he did not do something bad in return for Laban's trick on him?
6. Would you have done as Jacob did?
7. What lessons can we learn from this story? (Patience, willing to wait for the best thing, not to reciprocate evil for evil...)

# Discussion Questions

- **Jacob went East and came across a well and there were shepherds there. Where did the shepherds say that they were from?** *Harran.*
- **Who came while he was talking to the shepherds?** *Rachel, Laban's daughter, his cousin.*
- **Why did Jacob kiss Rachel and begin to weep?** *He had found his mother's family and he was overwhelmed with joy.*
- **How did Laban receive him?** *He said, "You are my own flesh and blood." and he took him in to live with him.*
- **What did Laban ask Jacob after he had been there one month? What wages did he want for his work?**
- **How did Jacob answer?** *He would work for him for 7 years in exchange for Rachel for his wife.*
- **Describe Rachel.** *She was the younger daughter of Laban. She was beautiful.*
- **Describe Leah.** *She was the older daughter of Laban. She had "weak" eyes. Maybe she was cross-eyed or blind. We don't know exactly what that means.*
- **Do you think that Jacob should have been picking a wife just for her beauty? No. He should be looking for inner qualities that would make her a good wife.**
- **Who did Jacob end up married to?** *Leah*
- **How do you think that it is possible that he could marry her without realizing that it wasn't Rachel?** *The bride would have been wearing a veil.*
- **Jacob was angry when he realized that his wife was Leah instead of Rachel and he demanded an explanation from Laban. What was Laban's answer?** *It is customary for the eldest daughter to marry first.*
- **Do you remember someone else who had deceived others in the same way in the lesson 2 weeks ago? Yes. Jacob had deceived his brother and father in the same way. (Gen. 25:29-34 and Gen. 27: 1-41)**
- **How long did he have to work for Laban to pay for her?** *Seven more years.*
- **Why do you think that God had a purpose in allowing Jacob to be deceived in this way?** *The Lord disciplines those he loves. (Hebrews 12:6) He wanted him to see his own sin. God was now beginning to mold Jacob into a Godly man.*
- **Do your parents ever discipline you?** *Yes.*
- **Why do you think that they discipline you?** *To help me to correct my bad behavior and help me to grow into a more godly person.*

## Jacob Works for a Wife

### Laban meets Jacob

Laban, the father of Rachel, was pleased to meet Jacob.

Laban made a deal with Jacob whereby Jacob had to work for Laban for 7 years in exchange for his daughter Rachel's hand in marriage. However, Laban substituted her sister Leah instead and Jacob had to serve a further 7 years in order to marry Rachel.

Laban was a nomad. He and his family and servants lived in a number of tents.

They followed their sheep as they were moved from one feeding ground to the next.

Laban in Hebrew means: *white, glorious*. He was the son of Bethuel and the brother of Rebekah, who had married Jacob's father, Isaac.



9. What does Laban mean when he says to Jacob, "Surely you are my bone and my flesh"?

10. When Laban gives his daughter Leah in marriage to Jacob instead of Rachel, what does this show about Laban's character?

### Jacob

Jacob lived 147 years, from 2005BC-1885BC. He married two sisters, Leah and Rachel, and then had 12 sons and at least one daughter, Dinah. God changed Jacob's name to Israel and from his sons came the 12 tribes of Israel.

Before Jacob and Esau were born, God had said "Jacob I have loved and Esau I have hated."

Jacob stole the blessing, of the first born, from Esau that their father Isaac's was to give Esau on his death bed.

Rebekah the mother of Esau and Jacob helped Jacob to deceive their father Isaac.



11. In Genesis 25, Jacob is described as "a mild man, dwelling in tents" and loved by his mother. What does his service to Laban show about Jacob's love for Rebekah?

12. Jacob's sons Judah and Levi become two prominent tribes in Israel. Who is their mother? Why is Levi important? Why is Judah important?

13. Which of Jacob's wives has a daughter named Dinah?

# Middle School

## Lesson 20: Wives & Sons of Jacob

### Leah

The older sister of Rachel and first wife of Jacob. After working seven years for Laban in order to marry Rachel, Jacob was tricked by Laban into marrying Leah instead.

In order to then marry Rachel, Jacob had to promise to work another seven years for Laban.

The Hebrew meaning of Leah is *languid, weary*.

Leah gave birth to six of Jacob's twelve sons who came the twelve tribes of Israel.

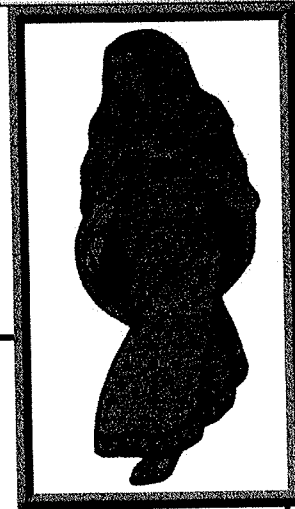

(glue Leah's sons here)

14. What is Leah's physical weakness?

15. How does the Lord show pity for Leah since Jacob doesn't love her?

16. What did Leah say when she had Reuben:  
when she had Simeon:  
when she had Levi:  
when she had Judah:  
when she had Issachar:  
when she had Zebulun:

### Zilpah

Zilpah, the handmaiden of Leah, bore two sons to Jacob, named Asher and Gad.

It was the custom of those times if the wife was barren. Then a another woman would bare children for her.

Zilpah was not from the family of Laban but a servant in the extended household.

Zilpah in Hebrew means *Drooping*.

(glue sons here)



17. Who were Zilpah's sons?

18. What did Leah say when Zilpah had Gad:  
when Zilpah had Asher:

## **Jacob Flees From Laban**

**Scriptures: Genesis 30:25-43, Genesis 31**

**Key Verse: Genesis 31:3 "Then the Lord said to Jacob, 'Return to the land of your fathers and to your family, and I will be with you.'"**

### **Key Points:**

- 1.** Jacob wanted to leave Laban and go home to his own people. Laban agreed to give Jacob all the speckled sheep and goats. However, Laban tricked him and gave all the speckled sheep and goats to his sons.
- 2.** Jacob had a plan to increase his flocks, and God saw to it that his flocks multiplied. So when it came time for him to leave, Jacob had become very prosperous.
- 3.** Laban's sons were jealous of Jacob's prosperity, so Laban had an unfavorable attitude toward him.
- 4.** Jacob planned to return to his father Isaac in the land of Canaan. While her father was away, Rachel stole household idols from Laban. They left, unknown to Laban. God came to Laban in a dream and told him not to harm Jacob, but Laban pursued Jacob and angrily confronted Jacob about the idols. Rachel hid them in her camel's saddle and sat on them.
- 5.** Jacob pleaded with Laban that he had worked for Laban for 20 years and treated him well. He requested from Laban that he be allowed to go to leave in peace. They made a covenant together that the Lord be with them while they were absent from one another.

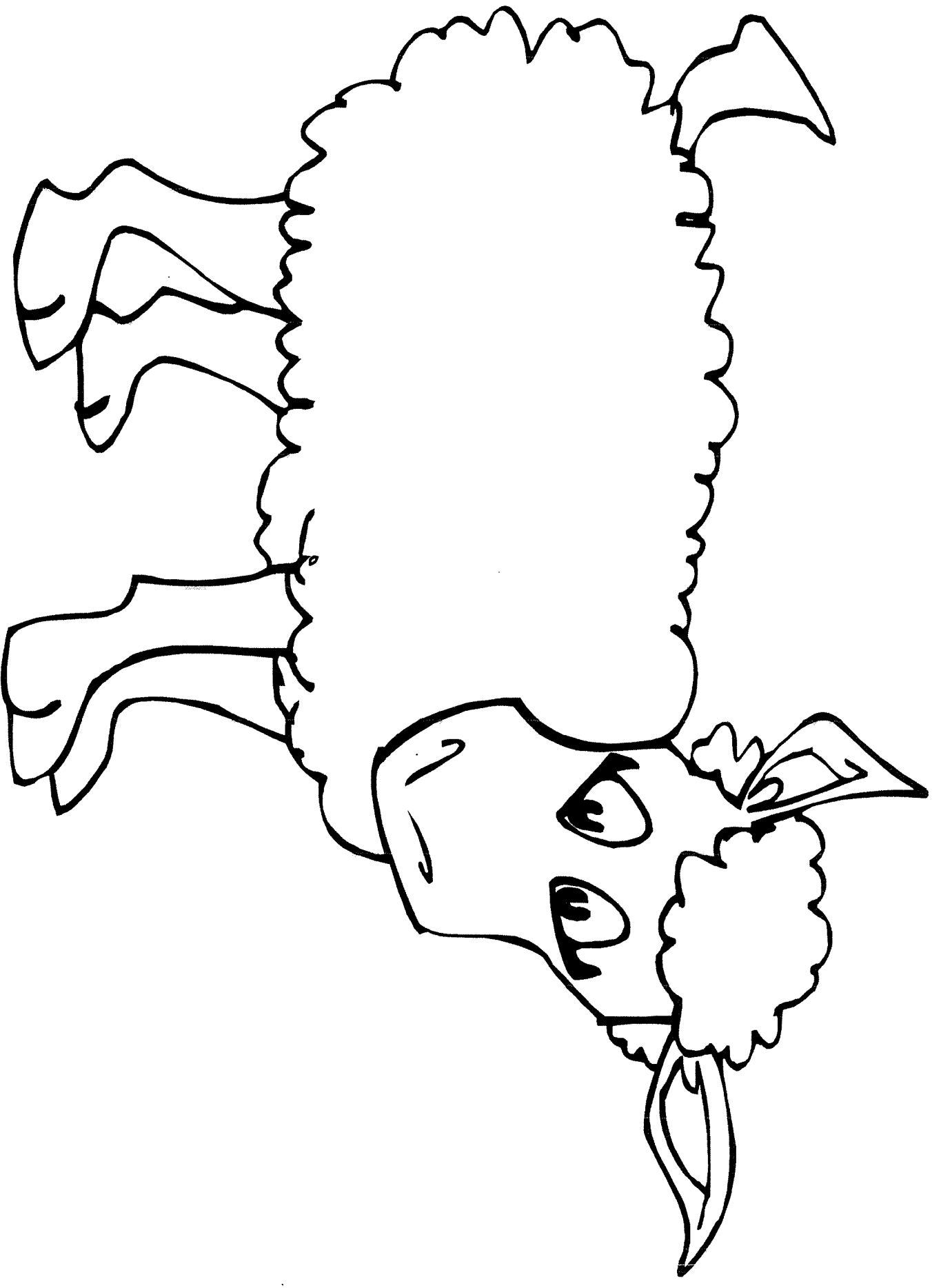

The day(or night) before class, dab cotton balls in brown paint and let dry. Children can glue them onto the lambs.

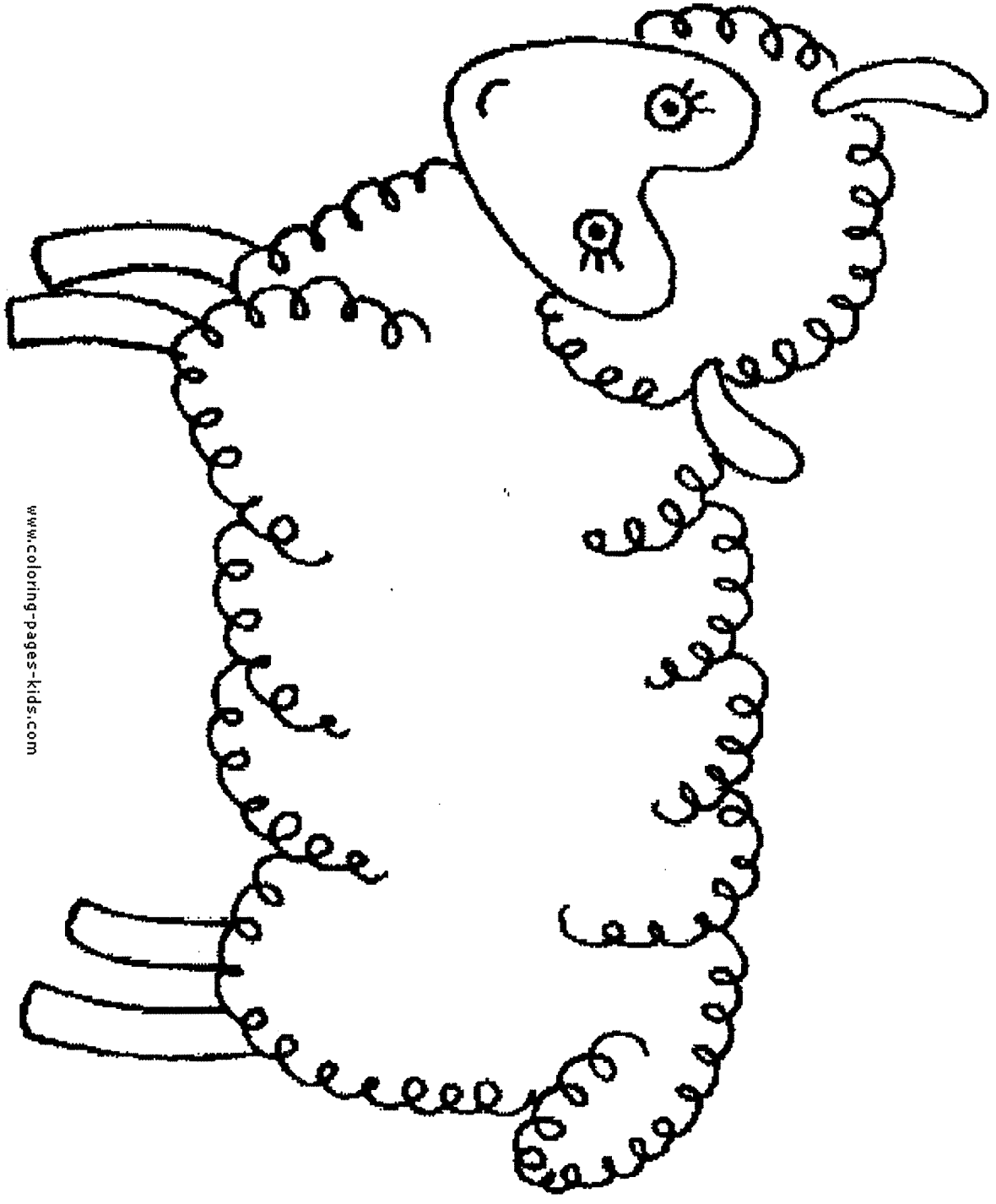

www.coloring-pages-kids.com



# Solution

```
K + S + L S G O A T S + I + +
+ C + T E E R U E B E N D + +
L + O V R + H P E E H S O + +
+ R I T + E H C + + + L + +
A W M + S P A D A S N O S I +
+ S + B E E E K + R + + + L S
D + H S S L V + E + + + Z A P
A + O E K C H I L D R E N T O
G J L C R + + J L + B + O H T
S I E M A C U + B U + N E P T
N P A + + D + + L O + A M A E
S A H + A + + I L + C B I N D
+ + D H + + N E + + + A S + +
+ + + + + V + + + + L J + +
+ + + + + I + + + + + + + +
```

(Over,Down,Direction)

- ASHER (1, 5, SE)
- CAMELS (6, 10, W)
- CHILDREN (6, 8, E)
- DAN (3, 13, NW)
- GAD (1, 9, N)
- GORTS (7, 1, E)
- IDOLS (13, 1, S)
- JACOB (13, 14, NW)
- JOSEPH (2, 9, NE)
- JUDAH (8, 9, SW)
- LABAN (12, 14, N)
- LAMBS (1, 3, SE)
- LEAH (3, 9, S)
- LEVI (9, 12, SW)
- LIVESTOCK (9, 9, NW)
- NAPHTALI (14, 12, N)
- RACHEL (10, 6, NW)
- RUEBEN (7, 2, E)
- SHEEP (12, 3, W)
- SIMEON (13, 13, N)
- SONS (13, 5, W)
- SPECKLED (1, 12, NE)
- SPOTTED (15, 6, S)
- STREERED (3, 1, SE)
- WIVES (2, 5, NE)
- ZEBULIN (13, 7, SW)

**Year 1**  
**Week 22**

## **Jacob Wrestles with an Angel and Receives a New Name**

**Scriptures: Genesis 32 & 33**

**Key Verse: Genesis 32:28 "And He said, 'Your name shall no longer be called Jacob, but Israel; for you have struggled with God and with men, and have prevailed.'"**

### **Key Points:**

1. On his journey home, Jacob approached Esau's home. Jacob's messengers told him that Esau was on his way to meet his brother with 400 men. He was afraid Esau would be angry and would want to harm him and his family.
2. Jacob prayed to God that his brother Esau would not harm him or his family.
3. In the night Jacob was left alone, and an angel came and wrestled with him all night. The angel touched the socket of Jacob's hip, and it came out of joint. The angel asked Jacob his name and told him he would no longer be called Jacob but Israel, for he had struggled with God and with man and had prevailed.
4. Esau and Jacob reconcile.



Before Jacob reached Canaan, he wrestled with an angel of God. Because Jacob's spirit did not fail, God named him Israel, which means "The Reliable One."

# YOUR NAME SHALL BE ISRAEL

(GENESIS 32:22-32)

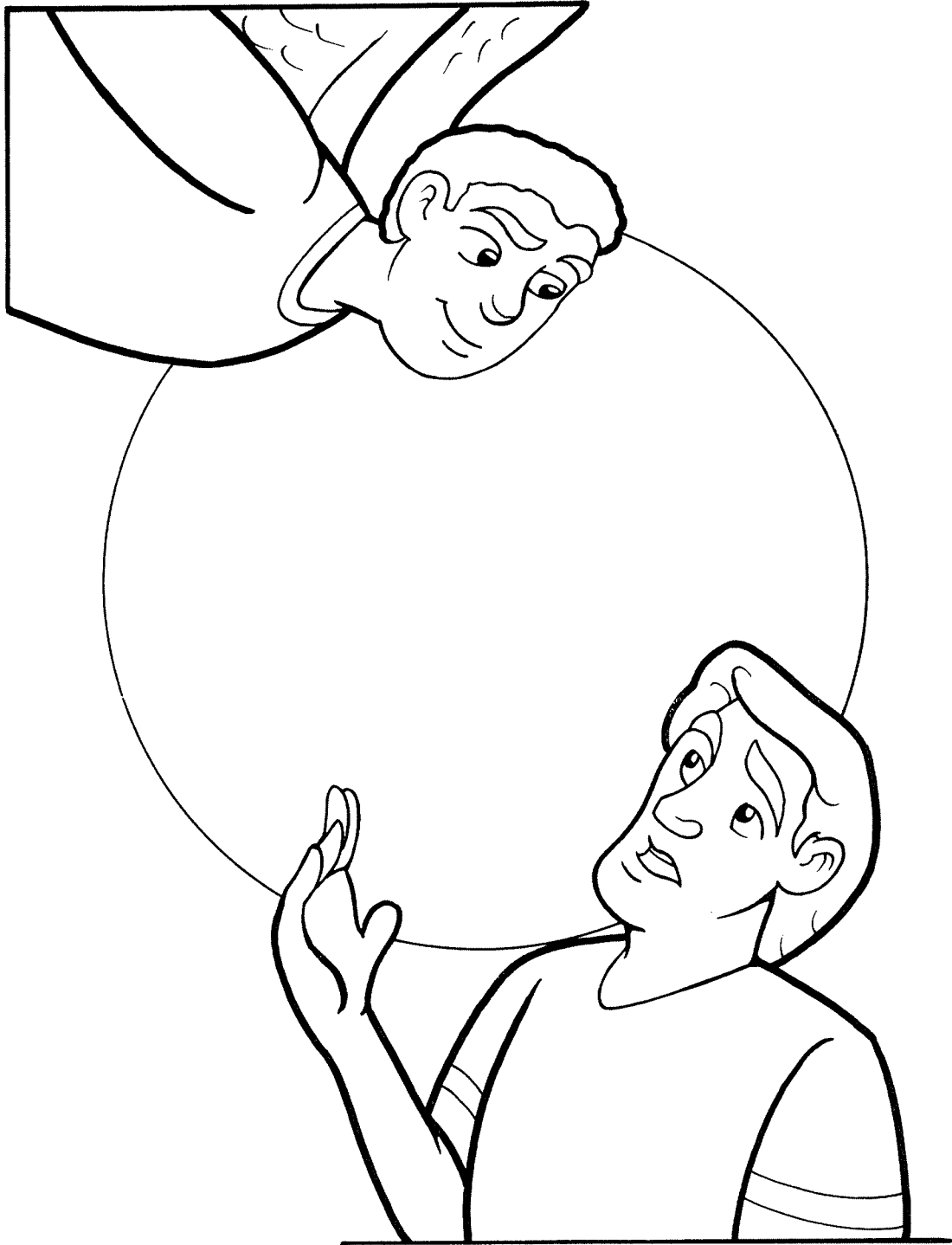

"And he said unto him, What *is* thy name? And he said, Jacob. And he said, Thy name shall be called no more Jacob, but Israel: for as a prince hast thou power with God and with men, and hast prevailed."

**GENESIS 32:27-28**

And Jā'cob said: "I will not let thee go until thou dost bless me." And the angel said:

"What is your name?"

And Jā'cob answered, "Jā'cob is my name."

Then the angel said:

"Your name shall no more be called Jā'cob, but Is'ra-el, that is, 'He who wrestles with God.' For you have wrestled with God and have won the victory."



# JACOB & ESAU

(GENESIS 25:19-34; 27:1-46; 33)



“And Esau ran to meet him, and embraced him, and fell on his neck, and kissed him: and they wept.”  
**GENESIS 33:4**

# YOUR NAME SHALL BE ISRAEL

## (GENESIS 32:22-32)

### MEMORY VERSE:

"The LORD is near to all who call upon Him, to all who call upon Him in truth."  
PSALM 145:18

### TRUE OR FALSE:

1. "Jacob was left alone; and a Man wrestled with him until the breaking of day." **GENESIS 32:24**  
**TRUE OR FALSE**

### CIRCLE THE CORRECT WORDS:

2. "Now when He saw that He did not prevail against him, He touched the socket of his (**WRENCH, HIP**); and the socket of Jacob's (**WRENCH, HIP**) was out of joint as He wrestled with him." **GENESIS 32:25**
3. "And He said, 'Let Me go, for the day breaks.' But he said, 'I will not let You go unless You (**BLESS, PUNCH**) me!' " **GENESIS 32:26**

### TRUE OR FALSE:

4. So He said to him, "What is your name?" And he said, "Joebob." **GENESIS 32:27**  
**TRUE OR FALSE**

### FILL IN THE BLANKS:

5. "And He said, 'Your name shall no longer be called \_\_\_\_\_, but \_\_\_\_\_; for you have struggled with God and with men, and have prevailed.'" **GENESIS 32:28**

### TRUE OR FALSE:

6. "Then Jacob asked Him, saying, 'Tell me Your name, I pray.' And He said, 'Why is it that you ask about My name?' And He blessed him there." **GENESIS 32:29**  
**TRUE OR FALSE**

### CIRCLE THE CORRECT WORDS:

7. "And Jacob called the name of the place Peniel: 'For I have seen God face to face and my life is (**PRESERVED, DESTROYED**).'" **GENESIS 32:30**
8. "Just as he crossed over Penuel the sun rose on him, and he (**JUMPED, LIMPED**) on his hip." **GENESIS 32:31**

# YOUR NAME SHALL BE ISRAEL

## (GENESIS 32:22-32)

### MEMORY VERSE:

*"The LORD is near to all who call upon Him, to all who call upon Him in truth."*  
PSALM 145:18

### TRUE OR FALSE:

1. "Jacob was left alone; and a Man wrestled with him until the breaking of day." **GENESIS 32:24**  
**TRUE OR FALSE**

### FILL IN THE BLANKS:

2. "Now when He saw that He did not prevail against him, He touched the socket of his \_\_\_\_\_; and the socket of Jacob's \_\_\_\_\_ was out of joint as He wrestled with him." **GENESIS 32:25**
3. "And He said, 'Let Me go, for the day breaks.' But he said, 'I will not let You go unless You \_\_\_\_\_ me!' " **GENESIS 32:26**

### TRUE OR FALSE:

4. So He said to him, "What is your name?" And he said, "Joebob." **GENESIS 32:27**  
**TRUE OR FALSE**

### FILL IN THE BLANKS:

5. "And He said, 'Your name shall no longer be called \_\_\_\_\_, but \_\_\_\_\_; for you have struggled with God and with men, and have prevailed.'" **GENESIS 32:28**

### TRUE OR FALSE:

6. "Then Jacob asked Him, saying, 'Tell me Your name, I pray.' And He said, 'Why is it that you ask about My name?' And He blessed him there." **GENESIS 32:29**  
**TRUE OR FALSE**

### FILL IN THE BLANKS:

7. "And Jacob called the name of the place Peniel: 'For I have seen God face to face and my life is \_\_\_\_\_.'" **GENESIS 32:30**
8. "Just as he crossed over Penuel the sun rose on him, and he \_\_\_\_\_ on his hip."  
**GENESIS 32:31**



# YOUR NAME SHALL BE ISRAEL

## (GENESIS 32:22-32)

G L E A R S I J G B Y J O M B  
 B O T D T V S E E M B P L S L  
 K J D K O O R B N K U N L U A  
 E B L E S S H A U A N S M M N  
 F Z D E L T S E R W M A C D W  
 J Z A J F D M W W M D E R L J  
 S K N Q A S D L D W R U S H E  
 O C R R Y V S Z W U C O Z L S  
 C E C A F O T E C A F D F S U  
 K N A M B O C A J F N E P V M  
 E T P I Y M V X Y I R H G R O  
 T I I L O A O P P X G C K C I  
 P R E V A I L E D G N U B M T  
 T O Q S F Z J J Z Y G O U L E  
 E D E P M I L H W P Z T H I P

BLESS  
 BROOK  
 FACE TO FACE  
 GOD  
 HIP  
 ISRAEL

JACOB  
 LIMPED  
 MAN  
 MUSCLE  
 NAME

PREVAILED  
 SHRANK  
 SOCKET  
 TOUCHED  
 WRESTLED

WRITE DOWN THE LETTERS AS YOU COME TO THEM ON THE LINES BELOW

→		C			L		U	
		A		L				
		R		I	M	P		O
	U		T	N		H		
		T	H		I			N

# YOUR NAME SHALL BE ISRAEL

## (GENESIS 32:22-32)

C Q Z P V U Z K T T K Q S S L W P X W Q M M J N D  
 B E D U D F Q U Y E Y W G Z T Q B S A U B N R V K  
 G Y J E S I Q A I F J T V U E I W D W G X B L R W  
 Z R V D L O A B M P W F O P H Z N Y F S W U W T Z  
 F E U V O T C J X H R O Q Q F S J K Q L Z C T D O Y  
 S H H U J Q S K T N F E B H B R A T L G S O C R F  
 M X B B P V J E E E L G V T S Q V Q F U S U G T T  
 I H O D V Q W J R T Q B A A L T I I H G E C H H N  
 Q X V I R M M B X W L K Z J I D E R N N L H E N R  
 J C B Q U F B U L M J H N A J L O H S N B E U A S  
 M V E S X I Q R M M N N T C G V E G C H S D E J K  
 E A C C Y I S Z O A D O B O E X D D A D H C L E Z  
 W L E D D G M R M O O J Q B A U Y D V N F N P X Q  
 E O M Q J D Z S P T K D X A R Z N H N I A C M I C  
 Z U Y T F G E K Y F I Z V K C N X Z K J C H I K K  
 P O Q I T O E A A Q T A Z T X Z Y W M Z E I J H H  
 N C M W F S M L A Y L S C J E I M V M X T U L C D  
 V C A S C R A X K U R E A P F O A C K E O E S O S  
 E K C H X P N D L J D B A V Q U A D F G F C Q T B  
 T Y G S T H P I E T J V Q R Y E P R M Y A G O N J  
 C D J C B K M B C A J J U B S U Q B K S C M Y D V  
 V D H O E P G J O W Z R R Z R I F Q P V E V Q J H  
 T U W N E E M O I L P H B U V M A T M N I E F L I  
 L M F D L H T N Z S H R A N K Z D Y V H B F T B P  
 S Y R V X R M O Z R D L E P B S N P D U O E H O A

BLESS  
 BROOK  
 FACE TO FACE  
 GOD  
 HIP  
 ISRAEL

JACOB  
 LIMPED  
 MAN  
 MUSCLE  
 NAME

PREVAILED  
 SHRANK  
 SOCKET  
 TOUCHED  
 WRESTLED

WRITE DOWN THE LETTERS AS YOU COME TO THEM ON THE LINES BELOW

		<b>C</b>			<b>L</b>		<b>U</b>	
		<b>A</b>		<b>L</b>				
		<b>R</b>		<b>I</b>	<b>M</b>	<b>P</b>		<b>O</b>
	<b>U</b>		<b>T</b>	<b>N</b>		<b>H</b>		
		<b>T</b>	<b>H</b>		<b>I</b>			<b>N</b>

# YOUR NAME SHALL BE ISRAEL

## (GENESIS 32:22-32)

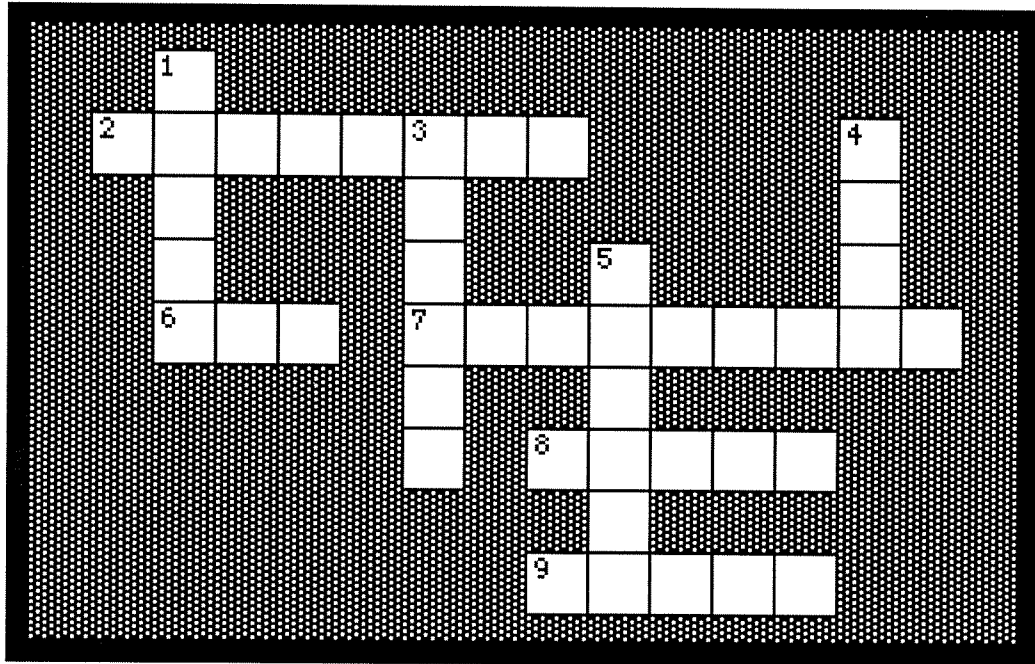

- 1 DOWN "The LORD is near to all who call upon Him, to all who call upon Him in \_\_\_\_." PSALM 145:18
- 2 ACROSS "Jacob was left alone; and a Man \_\_\_\_\_with him until the breaking of day." GENESIS 32:24
- 6 ACROSS "Now when He saw that He did not prevail against him, He touched the socket of his \_\_\_\_; and the socket of Jacob's hip was out of joint as He wrestled with him." GENESIS 32:25
- 9 ACROSS "And He said, 'Let Me go, for the day breaks.' But he said, 'I will not let You go unless You \_\_\_\_\_ me!' " GENESIS 32:26
- 8 ACROSS So He said to him, "What is your name?" And he said, "\_\_\_\_\_." GENESIS 32:27
- 5 DOWN "And He said, 'Your name shall no longer be called Jacob, but \_\_\_\_\_; for you have struggled with God and with men, and have prevailed.'" GENESIS 32:28
- 4 DOWN "Then Jacob asked Him, saying, 'Tell me Your \_\_\_\_\_ I pray.' And He said, 'Why is it that you ask about My name?' And He blessed him there." GENESIS 32:29
- 7 ACROSS "And Jacob called the name of the place Peniel: 'For I have seen God face to face and my life is \_\_\_\_\_.'" GENESIS 32:30
- 3 DOWN "Just as he crossed over Penuel the sun rose on him, and he \_\_\_\_\_ on his hip." GENESIS 32:31

# Jacob and Esau Meet

SAANILM 

--	--	--	--	--	--	--	--

  
17                          6

SIWVE 

--	--	--	--	--

  
                                 13

HICNEDLR 

--	--	--	--	--	--	--	--	--	--

  
3                                          8                                          7

REAF 

--	--	--	--

  
                                 9

SEUA 

--	--	--	--

  
                                 11    12

BAJCO 

--	--	--	--	--

  
1                                          18    4    15

MILP 

--	--	--	--

  
                                 14

PIH 

--	--	--

LETSEWR 

--	--	--	--	--	--	--	--

  
                                 16                                          10                                          19

ANM 

--	--	--

  
                                 2

NEGSSILB 

--	--	--	--	--	--	--	--	--	--

  
5

--	--	--	--	--

  
1    2    3    4    5

--	--	--

  
6    7    8

--	--	--	--

  
9    10    11    12

--	--	--	--	--	--	--	--	--	--

  
13    14    15    16    17    18    19

Unscramble each of the clue words.  
 Copy the letters in the numbered cells to other cells with the same number.

Created by [Puzzlemaker](http://puzzlemaker.discoveryeducation.com) at [DiscoveryEducation.com](http://DiscoveryEducation.com)



# Jacob and Esau Meet

SAANILM 

A	W	I	M	A	L	S
---	---	---	---	---	---	---

  
17 6

SIWVE 

W	I	V	E	S
---	---	---	---	---

  
13

HICNEDLR 

C	H	I	L	D	R	E	N
---	---	---	---	---	---	---	---

  
3 8 7

REAF 

F	E	A	R
---	---	---	---

  
9

SEUA 

E	S	A	U
---	---	---	---

  
11 12

BAJCO 

J	A	C	O	B
---	---	---	---	---

  
1 18 4 15

MILP 

L	I	M	P
---	---	---	---

  
14

PIH 

H	I	P
---	---	---

LETSEWR 

W	R	E	S	T	L	E
---	---	---	---	---	---	---

  
16 10 19

ANM 

M	A	N
---	---	---

  
2

NEGSSILB 

B	L	E	S	S	I	N	G
---	---	---	---	---	---	---	---

  
5

KEY

J	A	C	O	B
---	---	---	---	---

A	N	D
---	---	---

E	S	A	U
---	---	---	---

E	M	B	R	A	C	E
---	---	---	---	---	---	---

1 2 3 4 5      6 7 8      9 10 11 12      13 14 15 16 17 18 19

Unscramble each of the clue words.  
 Copy the letters in the numbered cells to other cells with the same number.

Created by Puzzlemaker at DiscoveryEducation.com



## Jacob and Esau Meet (Gen. 32 and Gen. 33)

### Fill In the Blank:

1. When Jacob saw the angels of God he said, "This is God's \_\_\_\_\_."
2. Then Jacob sent messengers before him to \_\_\_\_\_, his brother in the land of Seir, in the country of Edom.
3. Jacob sent gifts to Esau his brother because he wanted to find \_\_\_\_\_ in Esau's sight. Jacob said, "I will appease him with the present that goes before me and afterward I will see his \_\_\_\_\_; perhaps he will \_\_\_\_\_ me."
4. Jacob sent his wives and children over the \_\_\_\_\_ ahead of him.
5. When Jacob was alone, a \_\_\_\_\_ wrestled with Jacob all night long.
6. Because Jacob was determined to get the blessing of God, he continued to \_\_\_\_\_.
7. The \_\_\_\_\_ touched Jacob in the \_\_\_\_\_ and it went out of joint.
8. The \_\_\_\_\_ said, "Your name shall no longer be called \_\_\_\_\_ but \_\_\_\_\_ for you have struggled with \_\_\_\_\_ and with man and have prevailed.
9. Jacob asked the \_\_\_\_\_ what His \_\_\_\_\_ was.
10. Jacob walked with a \_\_\_\_\_ because his hip was touched by the Man as they wrestled.
11. Esau had \_\_\_\_\_ men with him when he met Jacob.
12. Esau ran to meet Jacob and \_\_\_\_\_ him, and fell on his \_\_\_\_\_ and kissed him, and they \_\_\_\_\_.
13. Esau told Jacob, "I have enough, my brother, \_\_\_\_\_ what you have for yourself."
14. Jacob insisted the Esau take his blessing because God had dealt \_\_\_\_\_ with him and because Jacob had enough. Esau accepted the gifts.
14. Jacob built a house and booths for his animals in \_\_\_\_\_. He also erected an altar to God there and called it \_\_\_\_\_.

# Middle School

Lesson 22: Genesis 32-33

JACOB RETURNS

Name \_\_\_\_\_



## Discussion Questions:

1. Esau was the father of what nation? What was the region called in which they lived?
2. Why would Jacob worry about Esau attacking his company?
3. In Jacob's prayer, what reasons does he give when he asks God for protection?
4. What does Jacob hope to do by sending presents for Esau ahead of his company?
5. Who did Jacob believe he had wrestled with? What in the angel's words would lead him to believe this?
6. What does the name Israel mean?
7. Why did Jacob choose to put his children in that order?
8. Why does Esau object to the presents Jacob offers?
9. What makes you believe that Jacob has changed?

**Year 1**

**Week 23**

**Jacob obeys God, Rachel Dies**

**Scriptures: Genesis 35**

**Key Verse: Gen. 35:3 “Then let us arise and go up to Bethel; and I will make an altar there to God, who answered me in the day of my distress and has been with me in the way which I have gone.”**

**Key Points:**

1. God called Jacob to return to the place he had spoken to Jacob many years earlier on his journey to Laban. The name of this place was Bethel.

2. Jacob and his family took all the idols and jewelry, changed their garments and Jacob buried them under a tree. This was to purify themselves and separate themselves for God.

3. Jacob traveled on to Bethel, the place where he had his dream, and built an altar there.

4. God appeared to Jacob again, blessed him and repeated that his name would no longer be Jacob but Israel. He told him to be fruitful and multiply and that a nation of people would come from him. Jacob set a pillar and poured oil on it for an offering.

5. Rachel came into childbirth as they traveled on to Ephrath (Bethlehem). She died while having her son Benjamin. Rachel conceived only Joseph and Benjamin-these were Jacob's favorite children. She was buried in this place, close to Bethlehem. Jacob set a pillar on her grave.

**Memory Work:**

**12 Sons of Jacob: Reuben, Simeon, Levi, Judah, Dan, Napthali, Gad, Asher, Issachar, Zebulun, Joseph, and Benjamin.**



## 12 Sons of Jacob

Make 12 figures from pattern for each child. Make a list of the names for each child. Cut all out. Have children glue the 12 "sons" to a large piece of paper with the listing of the names of Jacob's sons under them. Review often to commit to memory.

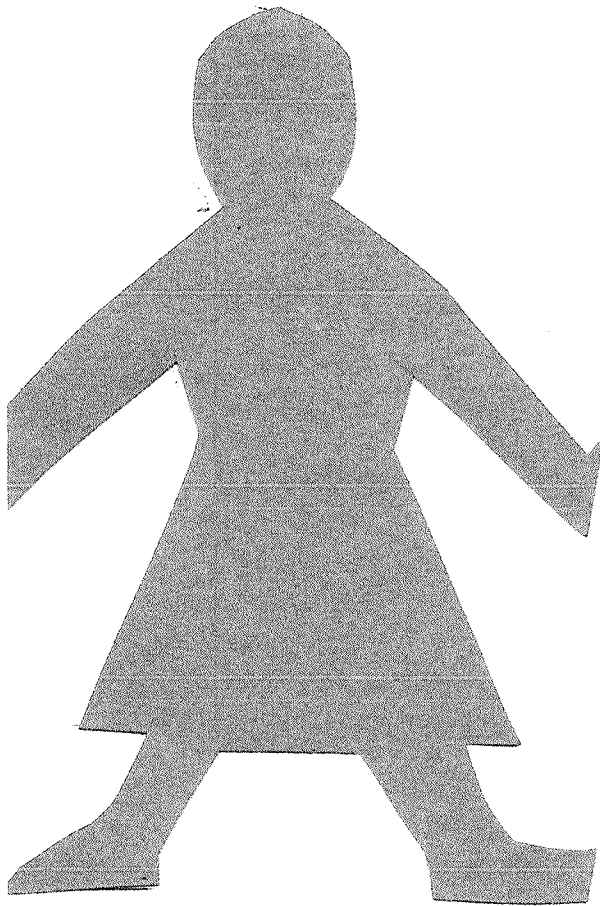

Reuben  
Simeon  
Levi  
Judah  
Dan  
Naphtali  
Gad  
Asher  
Issachar  
Zebulun  
Joseph  
Benjamin

Genesis 35:4

Name \_\_\_\_\_

*So they gave Jacob all the foreign gods which were in their hands, and the earrings which were in their ears;  
and Jacob hid them under the terebinth tree which was by Shechem*

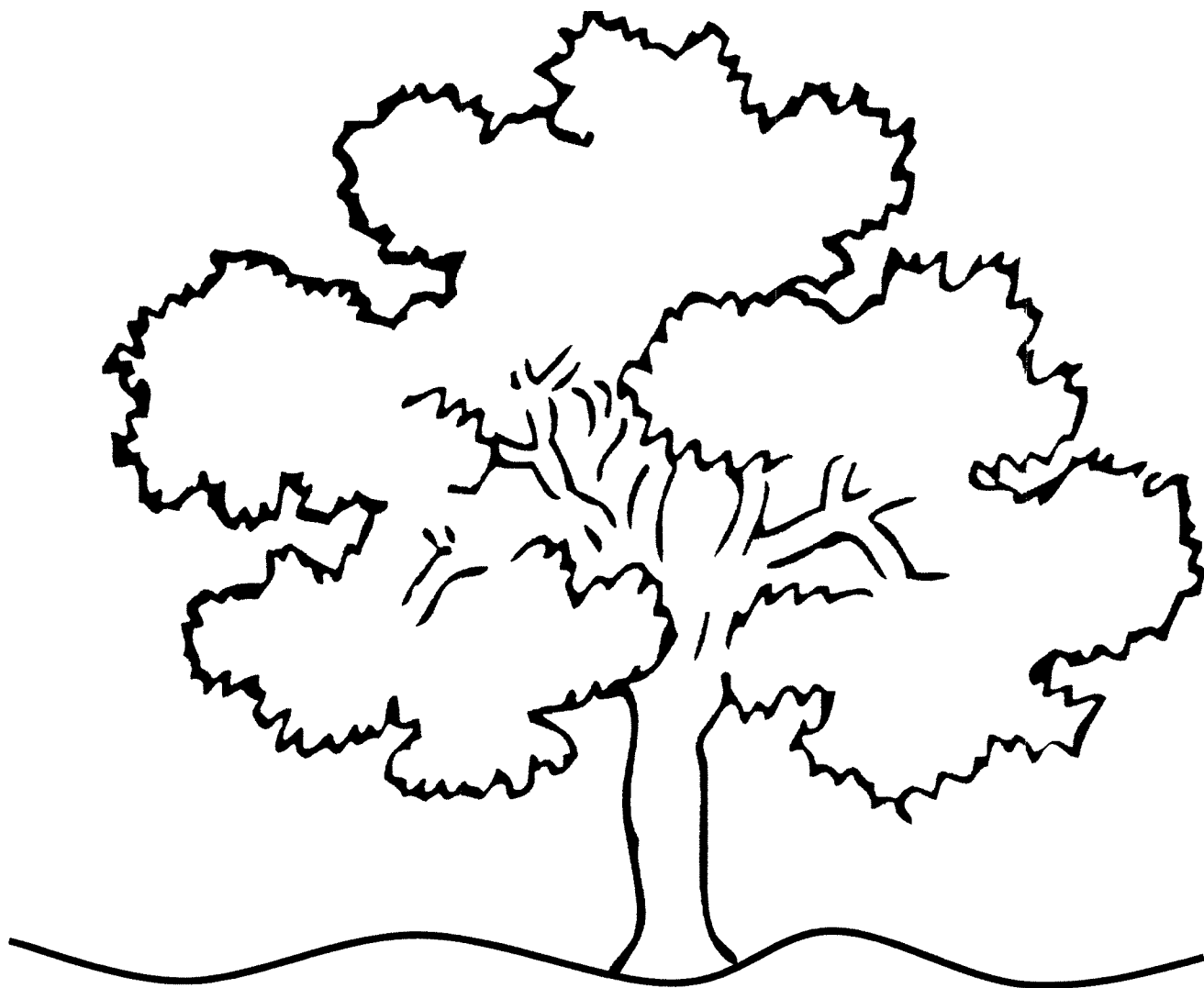

## Jacob Flees From Laban (Gen. 30: 25-43 and Gen. 31)

### Fill In The Blanks:

1. And it came to pass when Rachel had borne \_\_\_\_\_ that Jacob said to Laban, "Send me away, that I may go to my own place and to my country."
2. Jacob went on to say, "Give me my \_\_\_\_\_ and my \_\_\_\_\_ for whom I have served you, and let me go. . ."
3. Laban wanted Jacob to stay because he knew the Lord had blessed him because of Jacob. Laban said to Jacob, "Name your \_\_\_\_\_ and I will give it."
4. Jacob said, "Let me pass through all your \_\_\_\_\_ today, removing from there all the \_\_\_\_\_ and \_\_\_\_\_ sheep/ and all the \_\_\_\_\_ ones among the lambs, and the \_\_\_\_\_ and \_\_\_\_\_ among the goats; and these shall be my wages."
5. Thus, Jacob became exceedingly \_\_\_\_\_ and had large \_\_\_\_\_ female and male servants, and \_\_\_\_\_ and \_\_\_\_\_.
6. Then the Lord said to Jacob, "\_\_\_\_\_ to the land of your fathers and to your \_\_\_\_\_ and I will be with you."
7. God said, "I Am the God of Bethel where you anointed the pillar and where you made a \_\_\_\_\_ to me. Now \_\_\_\_\_ and get out of this land and return to the land of your \_\_\_\_\_."
8. Jacob arose and set his \_\_\_\_\_ and his \_\_\_\_\_ on camels.
9. So Jacob fled with all that he \_\_\_\_\_. He arose and crossed the \_\_\_\_\_ and headed toward the mountains of \_\_\_\_\_.
10. When Laban caught up with Jacob, Jacob said, "Thus I have been in your house \_\_\_\_\_ years. I served you \_\_\_\_\_ years for your two daughters and six years for your \_\_\_\_\_, and you have changed my \_\_\_\_\_ ten times."
11. Unless the God of my father, the God of Abraham and the \_\_\_\_\_ of Isaac, had been with me, surely now you would have sent me away \_\_\_\_\_. God has seen my affliction and the \_\_\_\_\_ of my hands, and rebuked you last \_\_\_\_\_.

# THE SONS OF JACOB

(GENESIS 29:31-30:24; 35:16-26)

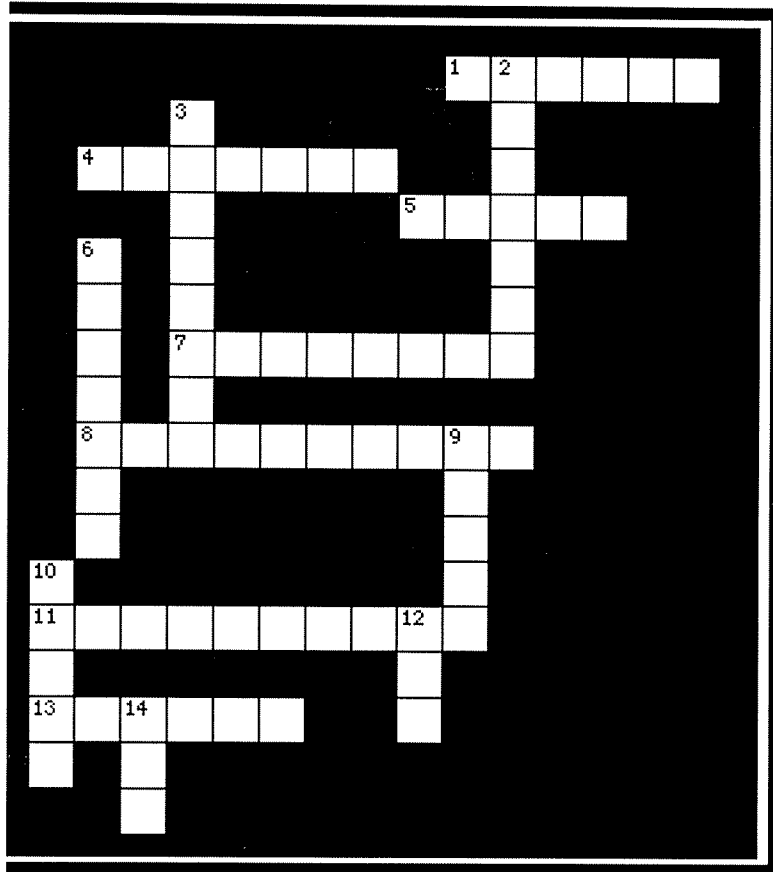

- 3 DOWN "Behold, children are a \_\_\_\_\_ from the LORD." PSALM 127:3
- 10 DOWN "\_\_\_\_\_ is the man who has his quiver full of them." PSALM 127:5
- 11 ACROSS "The LORD has surely looked on my \_\_\_\_\_. Now therefore my husband will love me." GENESIS 29:32
- 2 DOWN "Because the LORD has heard that I am \_\_\_\_\_. He has given me this son also." GENESIS 29:33
- 7 ACROSS "Now this time my husband will become \_\_\_\_\_ to me, because I have borne him three sons." GENESIS 29:34
- 13 ACROSS "Now I will \_\_\_\_\_ the LORD." GENESIS 29:35
- 1 ACROSS "God has \_\_\_\_\_ my case; and He has heard my voice and given me a son." GENESIS 30:6
- 8 ACROSS "With great \_\_\_\_\_ I have wrestled with my sister, and indeed I have prevailed." GENESIS 30:8
- 5 ACROSS "A \_\_\_\_\_ comes!" GENESIS 30:11
- 4 ACROSS "I am happy, for the daughters will call me \_\_\_\_\_" GENESIS 30:13
- 9 DOWN "God has \_\_\_\_\_ me my hire, because I have given my maid to my husband." GENESIS 30:18
- 6 DOWN "God has \_\_\_\_\_ me with a good endowment; now my husband will dwell with me, because I have borne him six sons." GENESIS 30:20
- 14 DOWN "The LORD shall \_\_\_\_\_ to me another son." GENESIS 30:24
- 12 DOWN She called his name "Ben-\_\_\_\_\_ " GENESIS 35:18

# THE SONS OF JACOB

(GENESIS 29:31-30:24; 35:16-26)

MEMORY VERSE:

*"Behold, children are a heritage from the LORD." PSALM 127:3*

*"Happy is the man who has his quiver full of them." PSALM 127:5*

MATCHING:

MATCH THE NAME OF JACOB'S SON ON THE RIGHT TO ITS MEANING ON THE LEFT

- |     |     |                                                                                                                                              |             |
|-----|-----|----------------------------------------------------------------------------------------------------------------------------------------------|-------------|
| 1.  | ___ | "The LORD has surely looked on my affliction.<br>Now therefore my husband will love me." <b>GENESIS 29:32</b>                                | A. LEVI     |
| 2.  | ___ | "Because the LORD has heard that I am unloved,<br>He has given me this son also." <b>GENESIS 29:33</b>                                       | B. NAPHTALI |
| 3.  | ___ | "Now this time my husband will become attached to me,<br>because I have borne him three sons." <b>GENESIS 29:34</b>                          | D. BENJAMIN |
| 4.  | ___ | "Now I will praise the LORD." <b>GENESIS 29:35</b>                                                                                           | E. ASHER    |
| 5.  | ___ | "God has judged my case; and He has heard my voice<br>and given me a son." <b>GENESIS 30:6</b>                                               | F. REUBEN   |
| 6.  | ___ | "With great wrestlings I have wrestled with my sister,<br>and indeed I have prevailed." <b>GENESIS 30:8</b>                                  | H. JUDAH    |
| 7.  | ___ | "A troop comes!" <b>GENESIS 30:11</b>                                                                                                        | I. JOSEPH   |
| 8.  | ___ | "I am happy, for the daughters will call me blessed." <b>GENESIS 30:13</b>                                                                   | J. SIMEON   |
| 9.  | ___ | "God has given me my hire,<br>because I have given my maid to my husband." <b>GENESIS 30:18</b>                                              | K. ZEBULUN  |
| 10. | ___ | "God has endowed me with a good endowment;<br>now my husband will dwell with me,<br>because I have borne him six sons." <b>GENESIS 30:20</b> | L. GAD      |
| 11. | ___ | "The LORD shall add to me another son." <b>GENESIS 30:24</b>                                                                                 |             |
| 12. | ___ | She called his name "Ben-Oni" <b>GENESIS 35:18</b>                                                                                           |             |

## Genesis 35 New Living Translation (NLT)

### Jacob's Return to Bethel

35 Then God said to Jacob, "Get ready and move to Bethel and settle there. Build an altar there to the God who appeared to you when you fled from your brother, Esau."

<sup>2</sup> So Jacob told everyone in his household, "Get rid of all your pagan idols, purify yourselves, and put on clean clothing. <sup>3</sup> We are now going to Bethel, where I will build an altar to the God who answered my prayers when I was in distress. He has been with me wherever I have gone."

<sup>4</sup> So they gave Jacob all their pagan idols and earrings, and he buried them under the great tree near Shechem. <sup>5</sup> As they set out, a terror from God spread over the people in all the towns of that area, so no one attacked Jacob's family.

<sup>6</sup> Eventually, Jacob and his household arrived at Luz (also called Bethel) in Canaan. <sup>7</sup> Jacob built an altar there and named the place El-bethel (which means "God of Bethel"), because God had appeared to him there when he was fleeing from his brother, Esau.

<sup>8</sup> Soon after this, Rebekah's old nurse, Deborah, died. She was buried beneath the oak tree in the valley below Bethel. Ever since, the tree has been called Allon-bacuth (which means "oak of weeping").

<sup>9</sup> Now that Jacob had returned from Paddan-aram, God appeared to him again at Bethel. God blessed him, <sup>10</sup> saying, "Your name is Jacob, but you will not be called Jacob any longer. From now on your name will be Israel."<sup>[ ]</sup> So God renamed him Israel.

<sup>11</sup> Then God said, "I am El-Shaddai—'God Almighty.' Be fruitful and multiply. You will become a great nation, even many nations. Kings will be among your descendants! <sup>12</sup> And I will give you the land I once gave to Abraham and Isaac. Yes, I will give it to you and your descendants after you." <sup>13</sup> Then God went up from the place where he had spoken to Jacob.

<sup>14</sup> Jacob set up a stone pillar to mark the place where God had spoken to him. Then he poured wine over it as an offering to God and anointed the pillar with olive oil. <sup>15</sup> And Jacob named the place Bethel (which means "house of God"), because God had spoken to him there.

### The Deaths of Rachel and Isaac

<sup>16</sup> Leaving Bethel, Jacob and his clan moved on toward Ephrath. But Rachel went into labor while they were still some distance away. Her labor pains were intense. <sup>17</sup> After a very hard delivery, the midwife finally exclaimed, "Don't be afraid—you have another son!" <sup>18</sup> Rachel was about to die, but with her last breath she named the baby Ben-oni (which means "son of my sorrow"). The baby's father, however, called him Benjamin (which means "son of my right hand"). <sup>19</sup> So Rachel died and was buried on the way to Ephrath (that is, Bethlehem). <sup>20</sup> Jacob set up a stone monument over Rachel's grave, and it can be seen there to this day.

<sup>21</sup> Then Jacob<sup>[ ]</sup> traveled on and camped beyond Migdal-eder. <sup>22</sup> While he was living there, Reuben had intercourse with Bilhah, his father's concubine, and Jacob soon heard about it.

These are the names of the twelve sons of Jacob:

<sup>23</sup> The sons of Leah were Reuben (Jacob's oldest son), Simeon, Levi, Judah, Issachar, and Zebulun.

<sup>24</sup> The sons of Rachel were Joseph and Benjamin.

<sup>25</sup> The sons of Bilhah, Rachel's servant, were Dan and Naphtali.

<sup>26</sup> The sons of Zilpah, Leah's servant, were Gad and Asher.

These are the names of the sons who were born to Jacob at Paddan-aram.

<sup>27</sup> So Jacob returned to his father, Isaac, in Mamre, which is near Kiriath-arba (now called Hebron), where Abraham and Isaac had both lived as foreigners. <sup>28</sup> Isaac lived for 180 years. <sup>29</sup> Then he breathed his last and died at a ripe old age, joining his ancestors in death. And his sons, Esau and Jacob, buried him.

# Tribes of Israel

Navigate

- Part I - Introductory Facts
- Part II - Sons of Jacob [Names, Mothers, Birth Verses]
- Part III - Prophecies about the 12 Tribes
- Part IV - Marching Order of the Tribes

## Part I - Introductory Facts about the 12 Tribes of Israel

Abraham begot Isaac. Isaac begot Jacob.

- To be an Israelite by blood, a person must be a descendent of Abraham, Isaac, and Jacob.

Jacob begot 12 sons who are listed herein in subsequent sections.

- The 12 sons of Jacob are the patriarchs of the 12 Tribes of Israel.
- For example, Jacob's son Benjamin is the patriarch of the Tribe of Benjamin. Jacob's son Reuben is the patriarch of the Tribe of Reuben. And so forth.

Well-known descendants of certain Tribes

- Tribe of Benjamin - King Saul, Paul the apostle [a.k.a. Saul of Tarsus]
- Tribe of Levi - Moses, Aaron
- Tribe of Judah - King David, King Solomon, many other kings; Lord Jesus, the Messiah

The Promised Land [Canaan], plus an area on the east side of the Jordan River, was allocated among the 12 Tribes. [Num 33.54; Num 36.3-9]

- As the priestly Tribe, Levi was given no land. [Num 18.20, 18.24] Instead of land, God gave Levi the tithes of the people of Israel.
- Jacob's son Joseph had two sons, Manasseh and Ephraim.
- By Jacob's command [Gen 48.5], Joseph's sons, Manasseh and Ephraim, were regarded as de facto "Tribes" of Israel.
- Thus, the land allocations of Joseph and Levi were given instead to Ephraim and Manasseh, preserving \*twelve\* as the number of tribes. [Josh 14.3-4]

There is no such thing as "10 lost tribes of Israel." [Mt 10.6, Acts 26.7, Jam 1.1, Rev 7.1-8; Ezek 37]

## Part II Sons of Jacob [Names, Mothers, Birth Verses]

Sons of Jacob	Meaning of Name	Mother	Birth Verse
01-Reuben	See, a son	Leah	So Leah conceived and bore a son, and she called his name Reuben; for she said, "The LORD has surely seen my affliction. Now therefore, my husband will love me." Gen 29.32
02-Simeon	Hearing	Leah	Then she conceived again and bore a son, and said, "Because the LORD has heard that I am unloved, He has therefore given me this son also." And she called his name Simeon.

			Gen 29.33
03-Levi	Joined; attached	Leah	She conceived again and bore a son, and said, "Now this time my husband will become attached to me, because I have borne him three sons." Therefore his name was called Levi. Gen 29.34
04-Judah	Yah be praised	Leah	And she conceived again and bore a son, and said, "Now I will praise Yahweh." Therefore she called his name Judah. Then she stopped bearing. Gen 29.35
05-Dan	Judge	Bilhah (Rachel's servant)	Then Rachel said, "God has judged my case; and He has also heard my voice and given me a son." Therefore she called his name Dan. Gen 30.6
06-Naphtali	My wrestling	Bilhah (Rachel's servant)	Rachel said, "With great wrestlings I have wrestled with my sister, and indeed I have prevailed." So she called him Naphtali. Gen 30.6
07-Gad	Troop; invader; good fortune	Zilpah (Leah's servant)	Then Leah said, "A troop comes!" So she called his name Gad. Gen 30.11
08-Asher	Happy	Zilpah (Leah's servant)	Then Leah said, "I am happy, for the daughters will call me blessed." So she called his name Asher. Gen 30.13
09-Issachar	Man of hire	Leah	Leah said, "God has given me my hire [wages] because I have given my maid to my husband." So she called his name Issachar. Gen 30.18
10-Zebulun	Dwelling	Leah	Leah said, "...now my husband will dwell with me, because I have borne him six sons." So she called his name Zebulun. Gen 30.20b
11-Joseph	Increaser	Rachel	So she called his name Joseph, and said, "The LORD shall add to me another son." Gen 30.24
12-Benjamin	Son of the right hand	Rachel	As her soul was departing (for she died), she called his name Ben-Oni [son of my sorrow]; but his father called him Ben-Jamin. Gen 35.18

### Part III - Prophecies about the 12 Tribes

Sons of

Jacob's Prophecies

Moses' Blessings



Jacob	Genesis 49.1-27	Deuteronomy 33.6-25
01-Reuben	<p>Reuben, you are my firstborn, My might and the beginning of my strength, The excellency of dignity and the excellency of power. Unstable as water, you shall not excel, Because you went up to your father's bed; Then you defiled it -He went up to my couch.</p>	<p>Let Reuben live, and not die, Nor let his men be few.</p>
02-Simeon	<p>Simeon and Levi are brothers; Instruments of cruelty are in their dwelling place. Let not my soul enter their council; Let not my honor be united to their assembly; For in their anger they slew a man, And in their self-will they hamstrung an ox. Cursed be their anger, for it is fierce; And their wrath, for it is cruel! I will divide them in Jacob And scatter them in Israel.</p>	<p>[Moses makes no mention of Simeon in blessing the tribes of Israel.]</p> <p>Of Levi he said: "Let Your Thummim and Your Urim be with Your holy one, Whom You tested at Massah, And with whom You contended at the waters of Meribah, Who says of his father and mother, 'I have not seen them'; Nor did he acknowledge his brothers, Or know his own children; For they have observed Your word And kept Your covenant. They shall teach Jacob Your judgments, And Israel Your law. They shall put incense before You, And a whole burnt sacrifice on Your altar. Bless his substance, LORD, And accept the work of his hands; Strike the loins of those who rise against him, And of those who hate him, that they rise not again."</p>
04-Judah	<p>Judah, you are he whom your brothers shall praise; Your hand shall be on the neck of your enemies; Your father's children shall bow down before you. Judah is a lion's whelp; From the prey, my son, you have gone up. He bows down, he lies down as a lion; And as a lion, who shall rouse him? The scepter shall not depart from Judah, Nor a lawgiver from between his feet, Until Shiloh comes; And to Him shall be the obedience of the people. Binding his donkey to the vine, And his donkey's colt to the choice vine, He washed his garments in wine, And his clothes in the blood of grapes. His eyes are darker than wine, And his teeth whiter than milk.</p>	<p>And this he said of Judah: "Hear, LORD, the voice of Judah, And bring him to his people; Let his hands be sufficient for him, And may You be a help against his enemies."</p>
05-Dan	<p>Dan shall judge his people As one of the tribes of Israel. Dan shall be a serpent by the way, A viper by the path, That bites the horse's heels So that its rider shall fall backward. I have waited for your</p>	<p>And of Dan he said: "Dan is a lion's whelp; He shall leap from Bashan."</p>

	salvation, O LORD!	
06-Naphtali	Naphtali is a deer let loose; He uses beautiful words.	And of Naphtali he said: "O Naphtali, satisfied with favor, And full of the blessing of the LORD, Possess the west and the south."
07-Gad	Gad, a troop shall tramp upon him, But he shall triumph at last.	And of Gad he said: "Blessed is he who enlarges Gad; He dwells as a lion, And tears the arm and the crown of his head. He provided the first part for himself, Because a lawgiver's portion was reserved there. He came with the heads of the people; He administered the justice of the LORD, And His judgments with Israel."
08-Asher	Bread from Asher shall be rich, And he shall yield royal dainties.	And of Asher he said: "Asher is most blessed of sons; Let him be favored by his brothers, And let him dip his foot in oil. Your sandals shall be iron and bronze; As your days, so shall your strength be."
09-Issachar	"Issachar is a strong donkey, Lying down between two burdens; He saw that rest was good, And that the land was pleasant; He bowed his shoulder to bear a burden, And became a band of slaves.	And of Zebulun he said: "Rejoice, Zebulun, in your going out, And Issachar in your tents! They shall call the peoples to the mountain; There they shall offer sacrifices of righteousness; For they shall partake of the abundance of the seas And of treasures hidden in the sand."
10-Zebulun	Zebulun shall dwell by the haven of the sea; He shall become a haven for ships, And his border shall adjoin Sidon.	
11-Joseph	Joseph is a fruitful bough, A fruitful bough by a well; His branches run over the wall. The archers have bitterly grieved him, Shot at him and hated him. But his bow remained in strength, And the arms of his hands were made strong By the hands of the Mighty God of Jacob (From there is the Shepherd, the Stone of Israel), By the God of your father who will help you, And by the Almighty who will bless you With blessings of heaven above, Blessings of the deep that lies beneath, Blessings of the breasts and of the womb. The blessings of your father Have excelled the blessings of my ancestors, Up to the utmost bound of the everlasting hills. They shall be on the head of Joseph, And on the crown of the head of him who was separate from his brothers.	And of Joseph he said: "Blessed of the LORD is his land, With the precious things of heaven, with the dew, And the deep lying beneath, With the precious fruits of the sun, With the precious produce of the months, With the best things of the ancient mountains, With the precious things of the everlasting hills, With the precious things of the earth and its fullness, And the favor of Him who dwelt in the bush. Let the blessing come 'on the head of Joseph, & on the crown of the head of him who was separate from his brothers.' His glory is like a firstborn bull, And his horns like the horns of the wild ox; Together with them He shall push the peoples To the ends of the earth; They are the ten thousands of Ephraim, And they are the thousands of Manasseh."
		Of Benjamin he said: "The beloved of the

12- Benjamin	Benjamin is a ravenous wolf; In the morning he shall devour the prey, And at night he shall divide the spoil.	LORD shall dwell in safety by Him, Who shelters him all the day long; And he shall dwell between His shoulders."
-----------------	---------------------------------------------------------------------------------------------------------------	------------------------------------------------------------------------------------------------------------------

## Part IV - Marching Order of the Tribes

### From Egypt to the Promised Land Military Organization & Marching Order of Israel Numbers Chapter 2

North - last to break camp  
Dan 62,700 | Asher 41,500  
Naphtali 53,400 | Total  
157,600

West - 3rd to break camp  
Ephraim 40,500 | Manasseh  
32200  
Benjamin 35,400 | Total  
108,100

Center - Tabernacle of Meeting  
Levi unnumbered [Num 2.33]

East - 1st to break camp  
Judah 74,600 | Issachar 54,400  
Zebulun 57,400 | Total 186,400

South - 2nd to break camp  
Reuben 46,500 | Simeon  
59,300  
Gad 45,650 | Total 151,450

<a href="#">Home</a>	<a href="#">Site Index</a>	<a href="#">Search</a>		<a href="#">Prayer Requests</a>	<a href="#">Poetry Archives</a>	<a href="#">E-mail us</a> We WILL reply!
----------------------	----------------------------	------------------------	-------------------------------------------------------------------------------------	---------------------------------	---------------------------------	---------------------------------------------

# Year 1

## Week 24

### Joseph, From Dreamer to Slavery

**Scriptures: Genesis 37**

**Key Verse: Gen. 37:3 Now Israel loved Joseph more than all his children, because he was the son of his old age. He made him a tunic of many colors.**

#### **Key Points:**

1. Jacob (Israel) and his sons lived in Canaan where they were strangers. Joseph was 17 years old and was feeding the flocks with his brothers. He brought a bad report to his father Israel (Jacob). Israel loved Joseph more than all his children because he was Rachel's son. He made him a coat of many colors. His brothers hated him because he was loved more.

2. Joseph had a dream where they were binding sheaves in the field and his brothers sheaves bowed down to his sheaf. He also had a dream where this time the sun, moon and 11 stars bowed down to him. His brothers hated him even more for his dreams. His father also rebuked him for his dreams.

3. Joseph's brothers went to feed the flocks at Shechem and Israel sent Joseph to see about them. When they saw him coming, they plotted to kill him. His brother Reuben urged his brothers not to kill Joseph; so instead they threw him into an empty water pit, stripping him of his coat.

4. Judah urged the brothers sell him to Midianite traders for 20 shekels of silver. They killed a goat and put the blood on his coat to show their father so he would believe Joseph had been killed. Israel mourned deeply for his son Joseph; he thought he would never see him again. Joseph, however, was sold to a man named Potiphar, an officer of Pharaoh and captain of the guard.



Joseph's father gave him a special robe.  
Genesis 37:3

## THE COAT OF MANY COLORS



Jacob had twelve sons. He loved Joseph more than the others and he made him a coat of many colors.



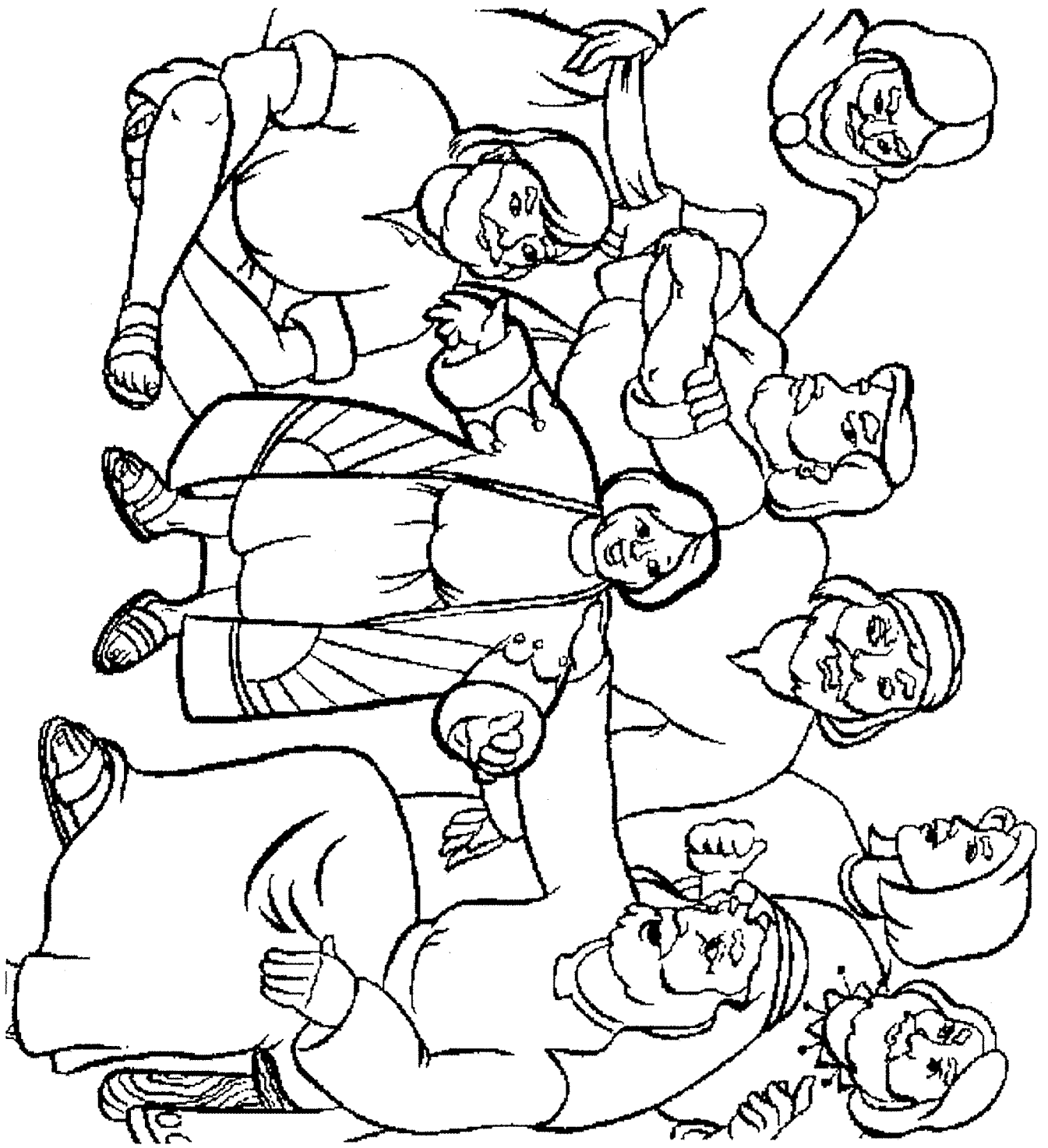



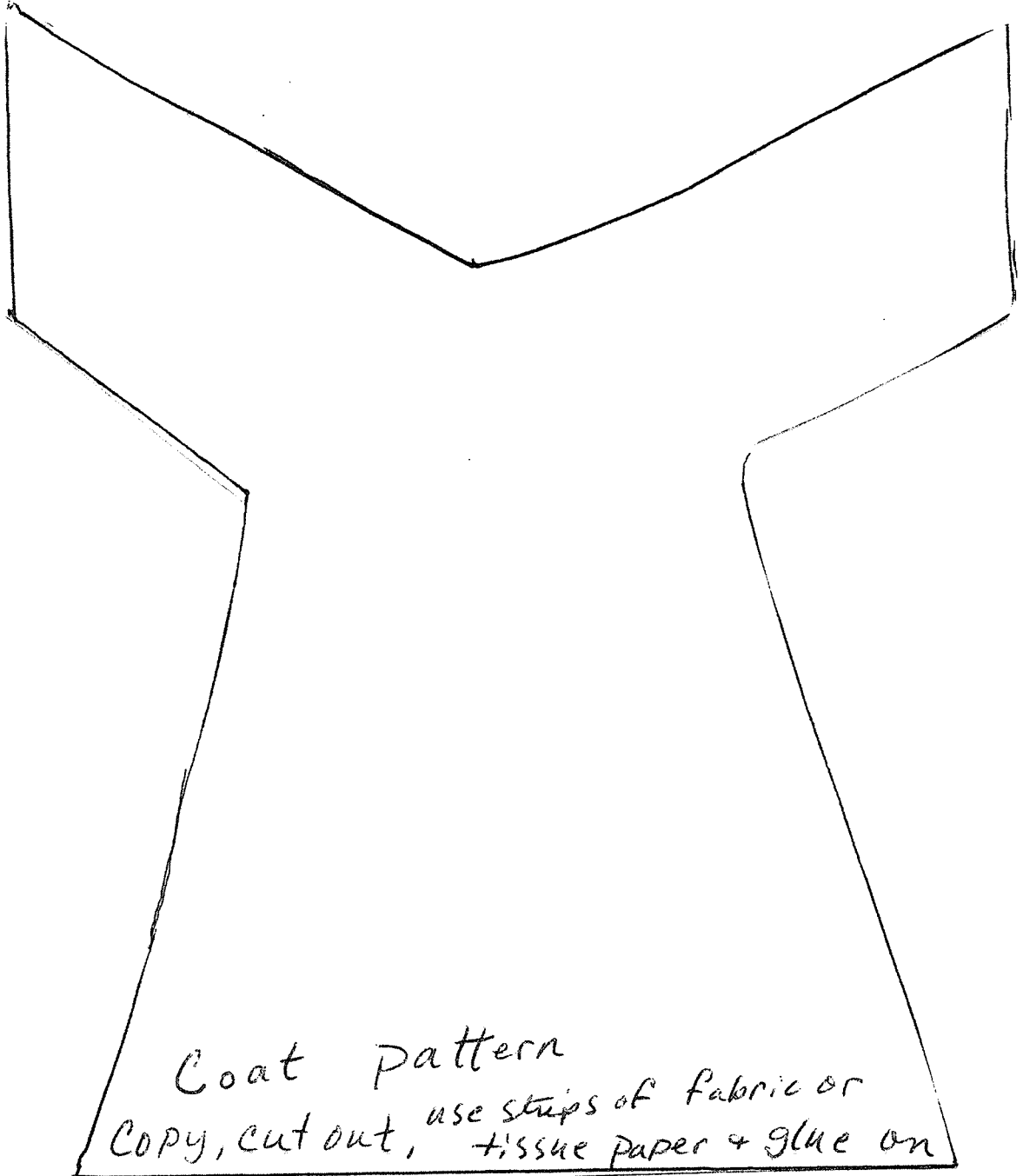

Coat pattern  
Copy, cut out, use strips of fabric or  
tissue paper + glue on



For lesson 1, summer.

For lesson 1, summer.

For lesson 9, summer.

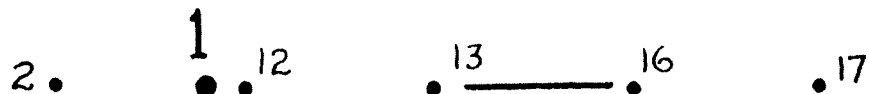
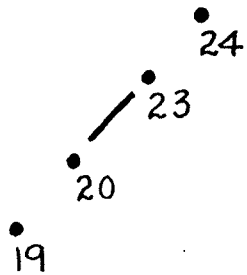
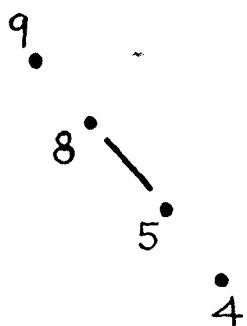
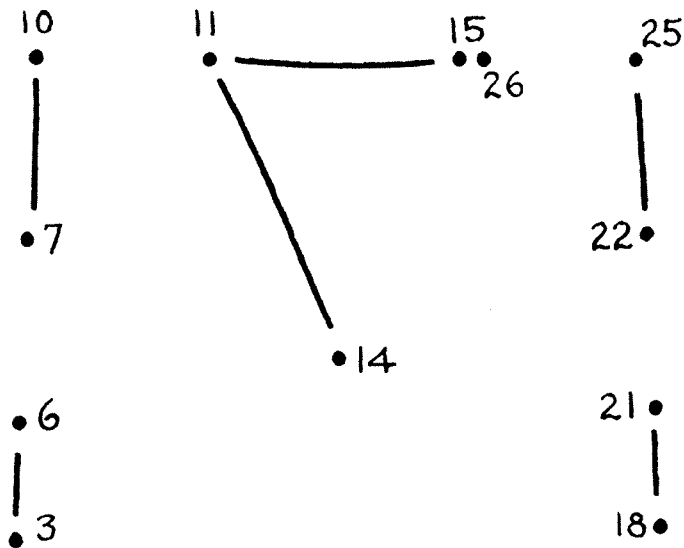

JOSEPH HAD A \_\_\_\_\_ OF MANY COLORS

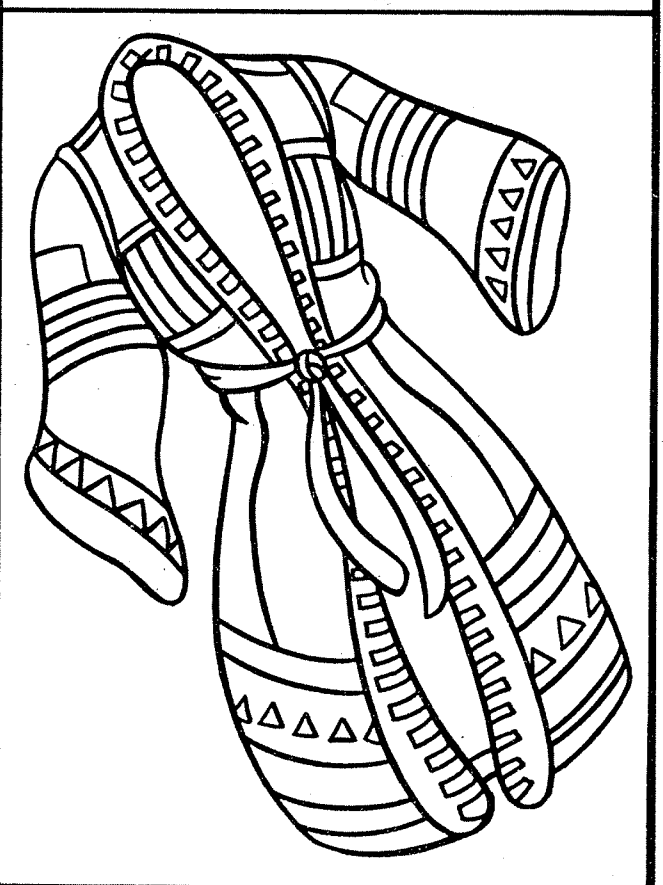
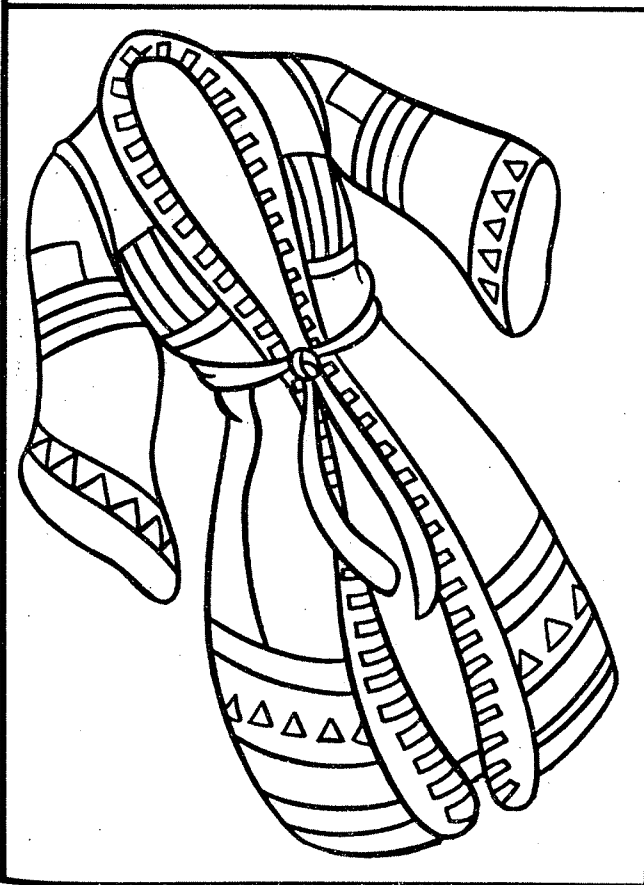
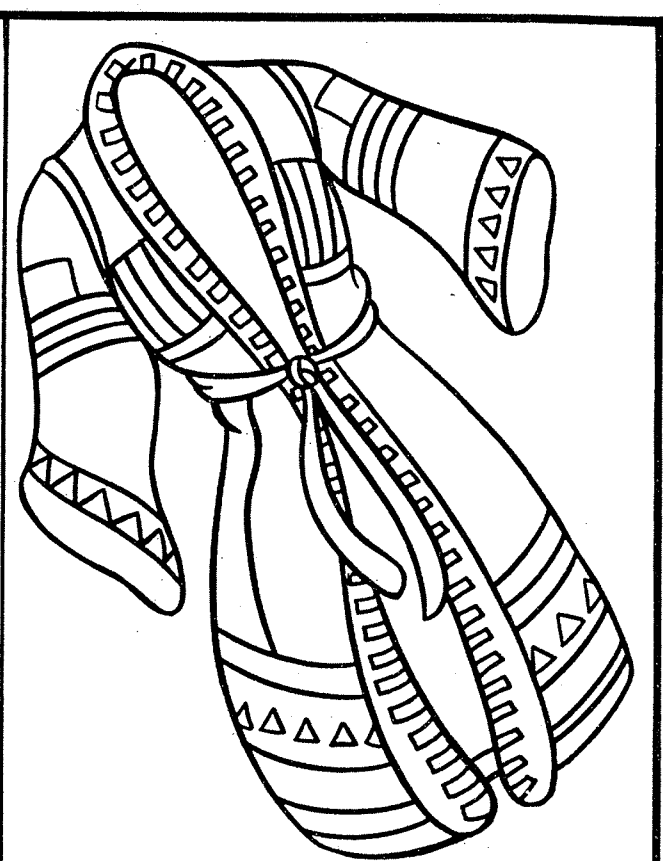
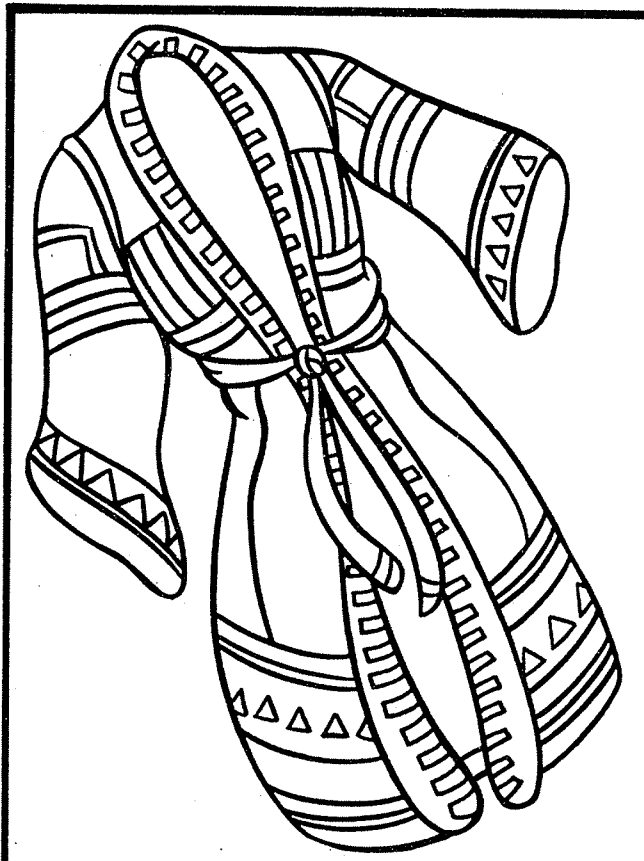

Which 2 robes are the same ?

# SUMMER

## Bulletin Board for Summer

### GROWING IN GOD'S FAMILY

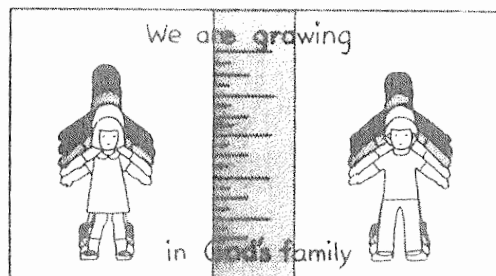

#### Materials:

Construction paper—flesh, light blue, medium blue, dark blue, black, yellow  
Thumbtacks or stapler  
Felt-tip pens  
Fabric scraps (optional)  
Patterns—boy, girl (page 45)

#### Directions:

In the center of your board place yellow sheets of construction paper (or strips, depending on the size of the board) in a vertical line. Mark the yellow sheets with a black felt-tip pen to resemble a tape measure. Using the boy and girl patterns, cut figures from skintone construction paper, and from light blue, medium blue, dark blue, and black. Cut clothing from fabric scraps or from colorful paper. Cut large block letters to form the words *We are growing in God's family*, to be placed on board as shown.

Place the figures of the boy and girl on each side of tape measure with shadows progressing up tape measure, from light blue to black.

To one side of the bulletin board, put up a sheet of paper where you can measure each child as he comes in the first week. Mark his height and his name. Tell him, "You are getting big. You are big enough to learn how to help." Later he will be big enough to share, and to worship God, as those concepts are presented.

#### Lesson 1: How We Grow

### JOSEPH STICK PUPPET

#### Materials:

Tagboard (such as file folders are made of)

Felt-tip pens

Craft sticks—1 per child

Fabric scraps

Glue

Pattern—puppet and clothing (page 48)

#### Directions:

Before class cut puppet figures using pattern on page 48. Add faces with felt-tip pens. Cut fabric scraps for coats.

During class have the children glue the puppets to the craft sticks and add the fabric coats for a touch-and-feel effect.

#### Application:

Let the children role play the story of Joseph, using their puppets. You may need to suggest various actions that make up the story. Discuss with the children how God helps us grow the way He helped Joseph.

The same puppet would fit with a lesson on Samuel and the new coat his mother brought him each year, or could be any number of Bible characters.



#### Lesson 2: Helping at Home

### BIBLE WORDS "PUZZLE"

#### Materials:

Posterboard

Construction paper

Felt-tip pen

Glue

Patterns—oval, star, heart, house (pages 46, 47)

#### Directions:

Before class cut posterboard into 4" x 12" rectangles, one per child. Trace the pattern shapes on the rectangles and add the word "at" as shown in the sketch.

# JOSEPH IS SOLD BY HIS BROTHERS

(GENESIS 37:3-36)



“Then there passed by Midianites merchantmen; and they drew and lifted up Joseph out of the pit, and sold Joseph to the Ishmeelites for twenty *pieces* of silver: and they brought Joseph into Egypt.”

**GENESIS 37:28**



Joseph was the son of Jacob and Rachel. Jacob loved Joseph more than his other sons. He had a special coat made for him.

Joseph's brothers were jealous of him.  
They threw him in an old well.

GENESIS - Chapter 37, Verses 4 and 23-24

# GENESIS 37:12-35

EORB

○	○	□	□
---	---	---	---

TYPGE

○	□	□	□	□
---	---	---	---	---

SLMECA

□	□	□	□	○	○
---	---	---	---	---	---

SANDH

□	□	□	○	○
---	---	---	---	---

EIVLA

□	○	○	○	□
---	---	---	---	---



WHAT JOSEPH'S BROTHERS DID TO HIM:

○	○	○	○
---	---	---	---

HIM FOR

○	○	○	○	○	○
---	---	---	---	---	---





The brothers sold Joseph to Egyptian merchants for twenty pieces of silver.

In Egypt, Joseph was sold to Potiphar, an officer of Pharaoh.

GENESIS - Chapter 37, Verses 28 and 36

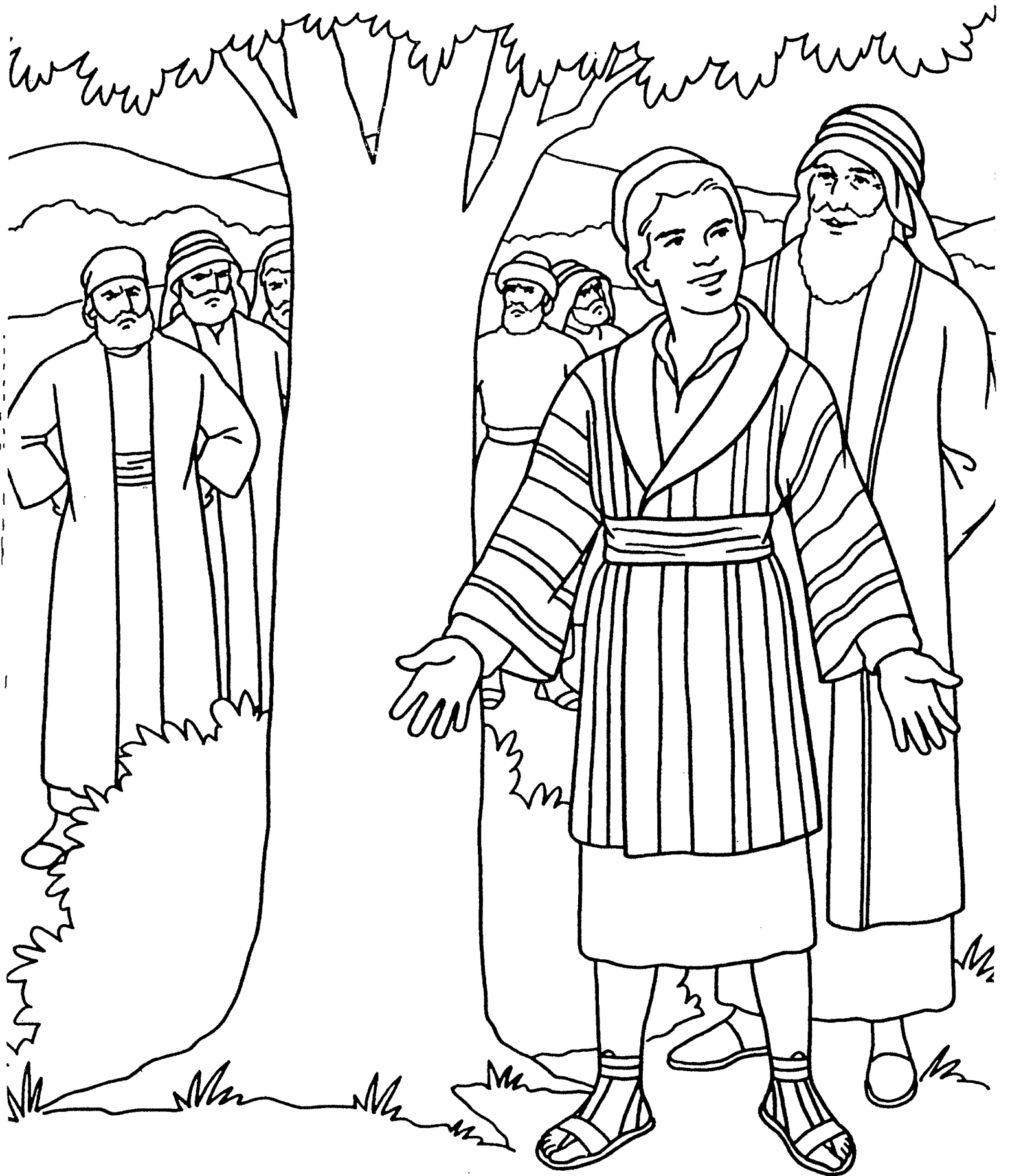

Jacob gave his favorite son, Joseph, a coat of many colors.  
Joseph's older brothers were jealous of him. *Genesis 37:1-4*

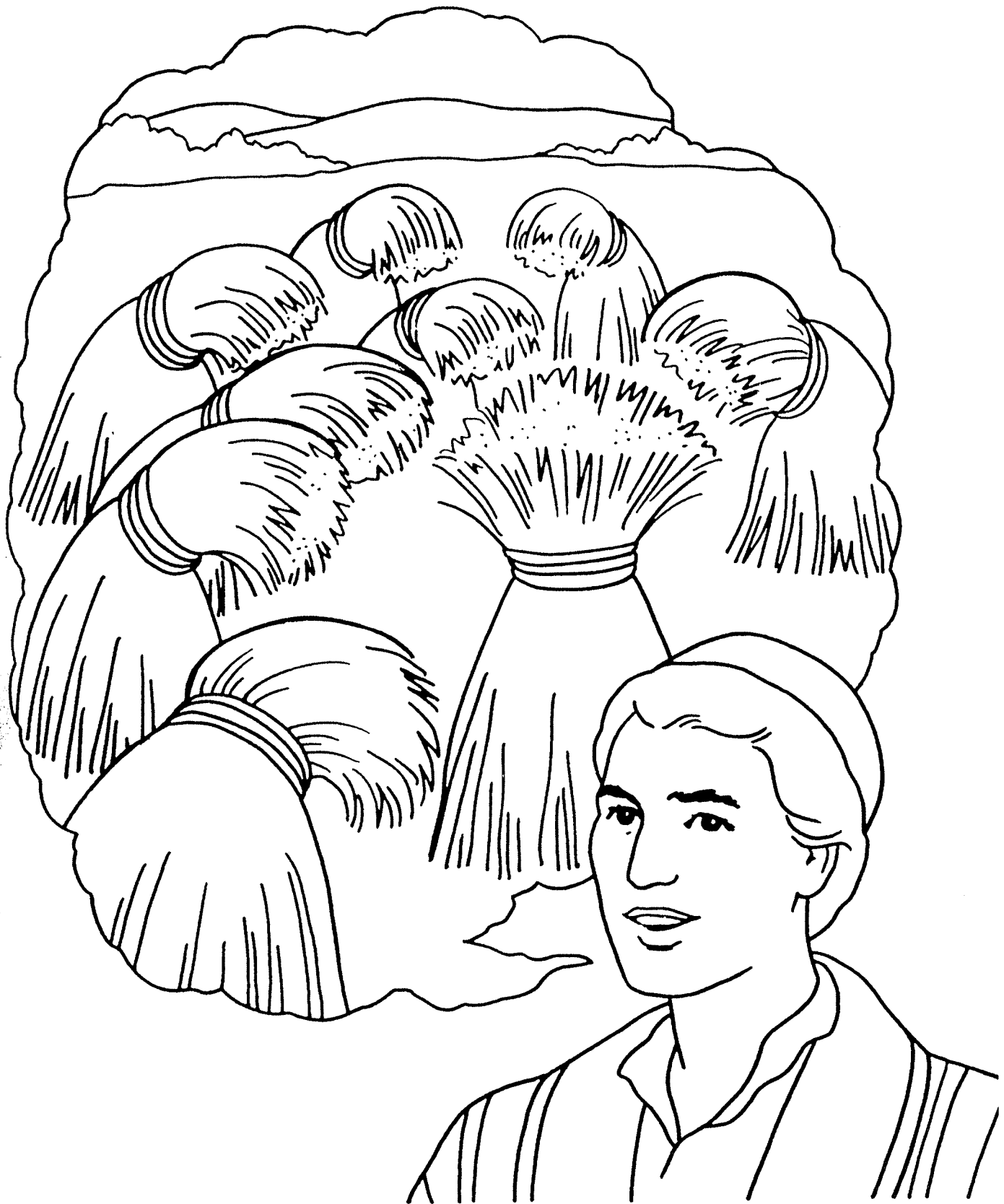

Joseph had a dream that meant his family would someday bow down to him. This made his brothers more jealous than before. *Genesis 37:5-11*



Joseph's brothers threw him in a pit. When some traders came by his brothers sold him to be a slave in Egypt.

*Genesis 37:15-28*



The brothers went back to their father, Jacob, and told him a wild animal had killed Joseph. Jacob was very sad. *Genesis 37:31-35*

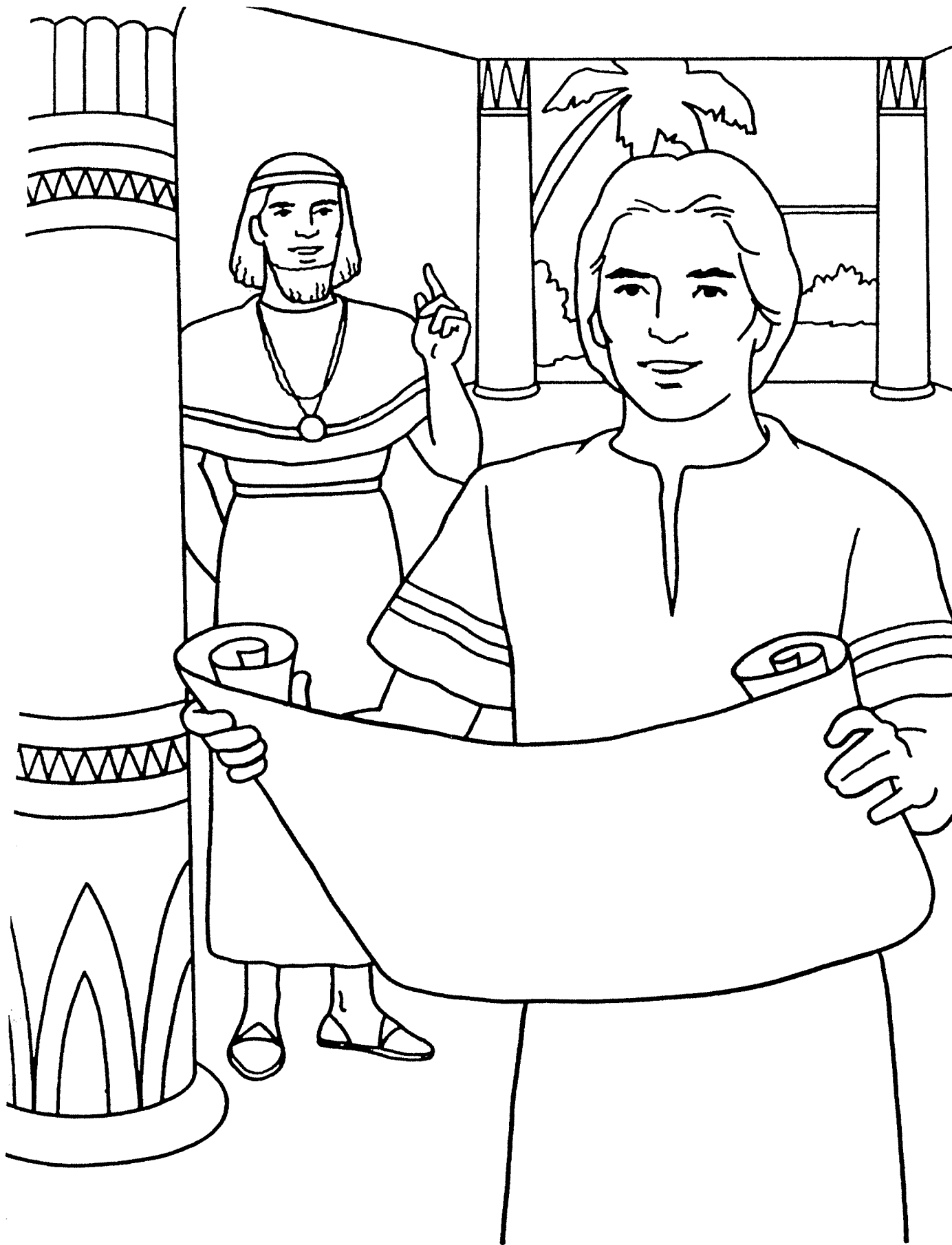

Joseph was sold to a man named Potiphar. He put Joseph in charge of everything he owned. God blessed Joseph.

*Genesis 39:1-6*



Joseph was put in prison for something he did not do. Even here he was a good worker who trusted in God.

*Genesis 39:20-23*



When Pharaoh's chief butler and chief baker had strange dreams, Joseph told them the meaning of their dreams. *Genesis 40*





Later, Joseph was called to explain Pharaoh's dreams. There would be seven years of plenty and then seven years of famine. *Genesis 41:1-36*

# JOSEPH IS SOLD BY HIS BROTHERS

## (GENESIS 37:3-36)

### MEMORY VERSE:

"Blessed are you when they revile and persecute you, and say all kinds of evil against you falsely for My sake." MATTHEW 5:11

### CIRCLE THE CORRECT WORDS:

1. "Now Israel loved Joseph (**MORE, LESS**) than all his children, because he was the son of his old age. Also he made him a tunic of many (**BUTTONS, COLORS**)." **GENESIS 37:3**

### FILL IN THE BLANKS:

2. "But when his brothers saw that their father \_\_\_\_\_ him more than all his brothers, they \_\_\_\_\_ him and could not speak peaceably to him." **GENESIS 37:4**

### TRUE OR FALSE:

3. "Now Joseph dreamed a dream, and he told it to his brothers; and they hated him even more." **GENESIS 37:5**  
**TRUE OR FALSE**
4. Joseph had no more dreams and his brothers then began to love him. **GENESIS 37:9**  
**TRUE OR FALSE**

### CIRCLE THE CORRECT WORDS:

5. "Then his brothers went to feed their father's flock in Shechem. And Israel said to Joseph, 'Are not your brothers (**FEEDING, EATING**) the flock in Shechem? Come, I will send you to them.' So he said to him, 'Here I am.'" **GENESIS 37:12-13**
6. "Now when they saw him afar off, even before he came near them, they conspired against him to kill him. Then they said to one another, 'Look, this (**SCREAMER, DREAMER**) is coming! Come therefore, let us now kill him and cast him into some (**JAIL PIT**); and we shall say, "Some wild beast has devoured him." We shall see what will become of his dreams!' " **GENESIS 37:18-20**

### TRUE OR FALSE:

7. "And Reuben said to them, 'Shed no blood, but cast him into this pit which is in the wilderness, and do not lay a hand on him' - that he might deliver him out of their hands, and bring him back to his father." **GENESIS 37:22**  
**TRUE OR FALSE**

### FILL IN THE BLANKS:

8. "Then Midianite traders passed by; so the brothers pulled Joseph up and lifted him out of the pit, and \_\_\_\_\_ him to the Ishmaelites for twenty shekels of silver. And they took Joseph to \_\_\_\_\_." **GENESIS 37:28**

### CIRCLE THE CORRECT WORDS:

9. "Then they sent the tunic of many colors, and they brought it to their father and said, 'We have found this. Do you know whether it is your son's tunic or not? And he recognized it and said, 'It is my son's tunic. A wild beast has devoured him. Without doubt (**JOSEPH, REUBEN**) is torn to pieces.'" **GENESIS 37:32-33**
10. "And all his sons and all his daughters arose to comfort him; but he (**REFUSED, ACCEPTED**) to be comforted, and he said, 'For I shall go down into the grave to my son in mourning.' Thus his father wept for him." **GENESIS 37:35**

# JOSEPH IS SOLD BY HIS BROTHERS

## (GENESIS 37:3-36)

### MEMORY VERSE:

*"Blessed are you when they revile and persecute you, and say all kinds of evil against you falsely for My sake." MATTHEW 5:11*

### FILL IN THE BLANKS:

1. "Now Israel loved Joseph \_\_\_\_\_ than all his children, because he was the son of his old age. Also he made him a tunic of many \_\_\_\_\_" **GENESIS 37:3**
2. "But when his brothers saw that their father \_\_\_\_\_ him more than all his brothers, they \_\_\_\_\_ him and could not speak peaceably to him." **GENESIS 37:4**

### UNDERLINE THE CORRECT ANSWER:

3. "Now Joseph..." **GENESIS 37:5**
  - a. dreamed a dream
  - b. told it to his brothers
  - c. and they hated him even more
  - d. all of these

### TRUE OR FALSE:

4. Joseph had no more dreams and his brothers then began to love him. **GENESIS 37:9**  
**TRUE OR FALSE**

### FILL IN THE BLANKS:

5. "Then his brothers went to feed their father's flock in Shechem. And Israel said to Joseph, 'Are not your brothers \_\_\_\_\_ the flock in Shechem? Come, I will send you to them.' So he said to him, 'Here I am.'" **GENESIS 37:12-13**
6. "Now when they saw him afar off, even before he came near them, they conspired against him to kill him. Then they said to one another, 'Look, this \_\_\_\_\_ is coming! Come therefore, let us now kill him and cast him into some \_\_\_\_\_; and we shall say, "Some wild beast has devoured him." We shall see what will become of his dreams!' " **GENESIS 37:18-20**

### TRUE OR FALSE:

7. "And Reuben said to them, 'Shed no blood, but cast him into this pit which is in the wilderness, and do not lay a hand on him' - that he might deliver him out of their hands, and bring him back to his father." **GENESIS 37:22**  
**TRUE OR FALSE**

### FILL IN THE BLANKS:

8. "Then Midianite traders passed by; so the brothers pulled Joseph up and lifted him out of the pit, and \_\_\_\_\_ him to the Ishmaelites for twenty shekels of silver. And they took Joseph to \_\_\_\_\_." **GENESIS 37:28**
9. "Then they sent the tunic of many colors, and they brought it to their father and said, 'We have found this. Do you know whether it is your son's tunic or not? And he recognized it and said, 'It is my son's tunic. A wild beast has devoured him. Without doubt \_\_\_\_\_ is torn to pieces.'" **GENESIS 37:32-33**
10. "And all his sons and all his daughters arose to comfort him; but he \_\_\_\_\_ to be comforted, and he said, 'For I shall go down into the grave to my son in mourning.' Thus his father wept for him." **GENESIS 37:35**

# JOSEPH IS SOLD BY HIS BROTHERS

## (GENESIS 37:3-36)

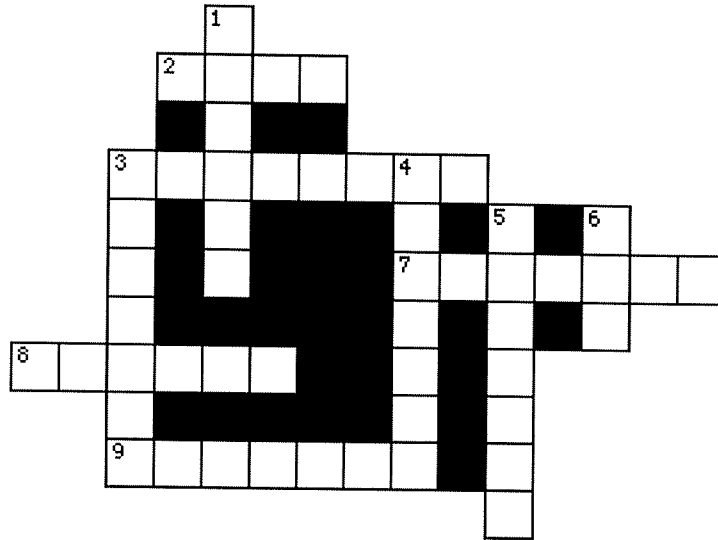

- 3 DOWN " \_\_\_\_\_ are you when they revile and persecute you, and say all kinds of evil against you falsely for My sake." **MATTHEW 5:11**
- 1 DOWN "Now Israel loved Joseph more than all his children, because he was the son of his old age. Also he made him a tunic of many \_\_\_\_\_." **GENESIS 37:3**
- 3 ACROSS "But when his \_\_\_\_\_ saw that their father loved him more than all his brothers, they hated him and could not speak peaceably to him." **GENESIS 37:4**
- 9 ACROSS "Now Joseph \_\_\_\_\_ a dream, and he told it to his brothers; and they hated him even more." **GENESIS 37:5**
- 7 ACROSS "Then his brothers went to feed their father's flock in Shechem. And Israel said to Joseph, 'Are not your brothers \_\_\_\_\_ the flock in Shechem? Come, I will send you to them.' So he said to him, 'Here I am.' " **GENESIS 37:12-13**
- 6 DOWN "Now when they saw him afar off, even before he came near them, they conspired against him to kill him. Then they said to one another, 'Look, this dreamer is coming! Come therefore, let us now kill him and cast him into some \_\_\_\_\_; and we shall say, "Some wild beast has devoured him." We shall see what will become of his dreams!' " **GENESIS 37:18-20**
- 5 DOWN "And Reuben said to them, 'Shed no blood, but cast him into this pit which is in the wilderness, and do not lay a hand on him' - that he might \_\_\_\_\_ him out of their hands, and bring him back to his father." **GENESIS 37:22**
- 2 ACROSS "Then Midianite traders passed by; so the brothers pulled Joseph up and lifted him out of the pit, and \_\_\_\_\_ him to the Ishmaelites for twenty shekels of silver. And they took Joseph to Egypt." **GENESIS 37:28**
- 8 ACROSS "Then they sent the tunic of many colors, and they brought it to their father and said, 'We have found this. Do you know whether it is your son's tunic or not? And he recognized it and said, 'It is my son's tunic. A wild beast has devoured him. Without doubt \_\_\_\_\_ is torn to pieces.'" **GENESIS 37:32-33**
- 4 DOWN "And all his sons and all his daughters arose to comfort him; but he \_\_\_\_\_ to be comforted, and he said, 'For I shall go down into the grave to my son in mourning.' Thus his father wept for him." **GENESIS 37:35**

# JOSEPH IS SOLD BY HIS BROTHERS

## (GENESIS 37:3-36)

S I L V E R J U D A H N P A G  
 H J T J R T N P I T F H O M Z  
 Y Q P A G U F S Z L H W E O S  
 Q N V H S S R O L O C Y N A M  
 K E E N S E I R V H J S I H M  
 G B H S H E A V E S A R N L A  
 O U T T L S T A K L K T A A E  
 J E O A L T L I B B Z V E Z R  
 M R L R E O O U L K T B V D D  
 B E C S S Y V V M E W A T Y L  
 N P K Y H P E S O J A U O E B  
 R G C W I T D W S N N M A G E  
 M G A C K T Y A H I W R H E W  
 I L S B O W E D C P S K I S G  
 F Y N N F G M T J I V G W K I

BOWED  
 BROTHERS  
 DREAM  
 GOAT  
 HATED  
 ISHMAELITES

ISRAEL  
 JOSEPH  
 JUDAH  
 LOVED  
 MANY COLORS

MOON  
 PIT  
 REUBEN  
 SACKCLOTH  
 SELL

SHEAVES  
 SILVER  
 STARS  
 SUN  
 TUNIC



REMOVE JOSEPH FROM THE PIT  
AND HELP HIM GET TO EGYPT

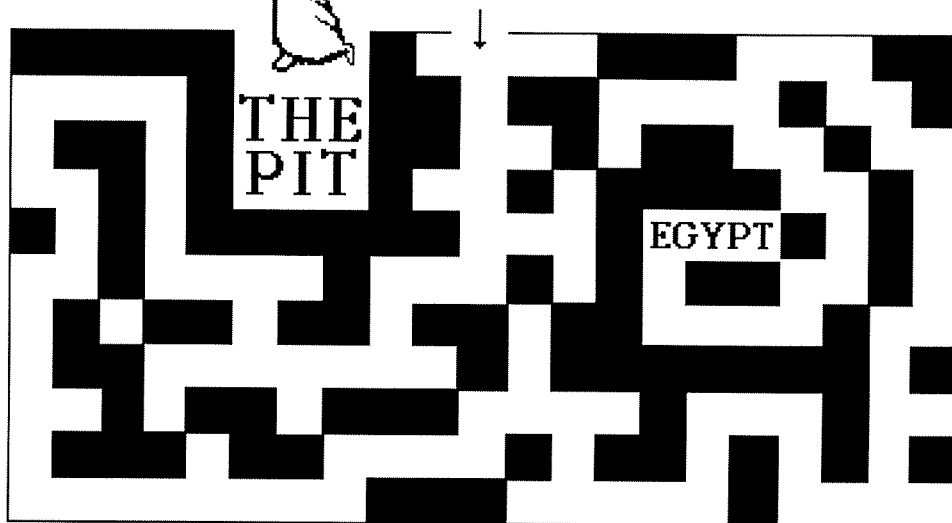

# JOSEPH IS SOLD BY HIS BROTHERS

## (GENESIS 37:3-36)

C D Y P X E Z Y X I F T H V O J T S Y G S T G T E M S V U L  
 U J D E T A H Y P X P E P A K O M M R F N I R Q S T A R S J  
 Q Q N H T P Z O N G G J J R Q U O L G Y C I H C Y C K P V V  
 D I M Z Y Z K F E Y K K H L K G E T I Q Z P U D B D T T P U  
 C K H I L C C V B P B K Q W L F M U K S M G V Y T N E J I X  
 N T L V I C T M U Y U P O J W K X N M D E C Y R I Y F I R E  
 W D D V O Q I S E B K Z A U K D N I A C R V Y I S R A E L A  
 T Y R B V I O V R D C Y W O I B N C V M P J A Q O J Y P F F  
 I L E Q S R E H T O R B V E J K O O X P J N R E W D R K V I  
 W H O Y V Z Z A A H C M O F T U A U C O M Q E E M A S L A X I  
 P Q W E E K N Z N G D J S C E T L D U E X D U B A C M Y I O  
 W S J L U D M U G R L F W S A W P T V H A D U J E E A S P Q  
 P S N N A K S S E G S A U C V I M X Z A Q B S K P U R G O H  
 I I S V N Q P H U N V H D H D L S X A Y F Y S I Q A X D R U  
 T L Z Q M J I M W G R A S U Q A C H U U G K F J T U T M A N H  
 Q S S R O L O C Y N A M J E E P C G M H A K J E F T O X V H  
 T J K T B B Q X D Z C H H C N P V E E A M J S F V E N T K P  
 A F B A G O D S W J M Z Q N R A Z I F A E M G S I K K L R U  
 U F Z Q F B W V Y P L Y O Q Y X K K P E M L R A F O V A W Y  
 U O F F H R J E P N B N E L Y V F X T C A V I G R O E B Y N  
 H P H H A B Q O D U X J W K D Q K P O N O W A T N P F H B M  
 E E N P W K R J Z O A T E D J D S P N A K Z S Q E F G P G H  
 R O G J X E I J W F C P B D I V M U R E V L I S Y S S U P B  
 J S A C K C L O T H W L K J P S O Z I I C F F F M D L V F Y  
 S O X T P F L E B L J J S O T M A V J Z Y I N H Z H C L Q A  
 T C G B E J S A M L U C U S V C T F J G U Z S W U D Y R K O  
 A F R I S T T W W M K V H E R Z M R Y O D T E U I F D R G M  
 Z K Q A G E F L U S O T P P F L Z K T A Y M L I K W T E X B  
 S B I M D J A Z F Z I W E H E U J K H T G G L K N Y L V Q H

BOWED  
 BROTHERS  
 DREAM  
 GOAT  
 HATED  
 ISHMAELITES

ISRAEL  
 JOSEPH  
 JUDAH  
 LOVED  
 MANY COLORS

MOON  
 PIT  
 REUBEN  
 SACKCLOTH  
 SELL

SHEAVES  
 SILVER  
 STARS  
 SUN  
 TUNIC



REMOVE JOSEPH FROM THE PIT  
 AND HELP HIM GET TO EGYPT

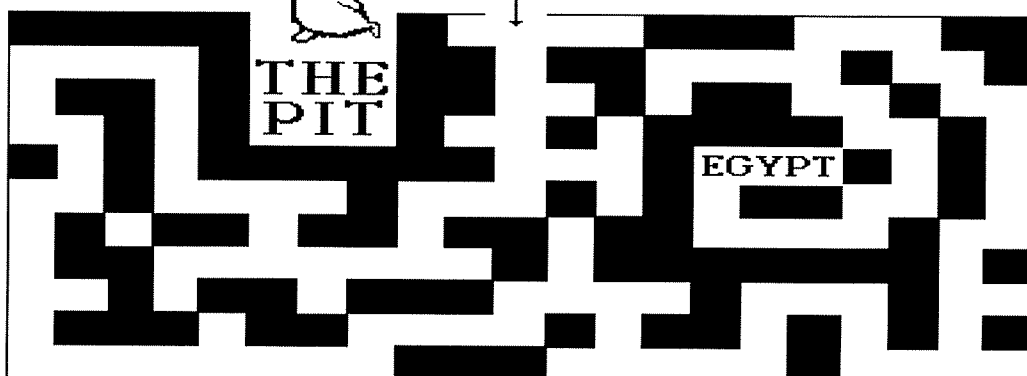

**Middle School**



**Discussion Questions:**

- 1. Who caused Joseph's brothers to hate him?**
- 2. What did both dreams mean?**
- 3. Look at Genesis 41:32. What significance does two dreams with the same meaning hold?**
- 4. Why would Joseph share these dreams with his brothers?**
- 5. How did Jacob react to the second dream?**
- 6. Which brother convinced the others to spare Joseph's life? What was his motivation?**
- 7. Which brother convinced them to sell Joseph to the Ishmaelites?**
- 8. Who else was betrayed for pieces of silver?**
- 9. What animal's blood was used to deceive Jacob?**

**Year 1**

**Week 25**

## **Joseph Goes to Prison**

**Scriptures: Genesis 39, 40**

**Key Verse: Genesis 39:2 The Lord was with Joseph and he was a successful man; and he was in the house of his master, the Egyptian.**

**Key Points:**

1. Joseph became successful in Egypt. The Lord was with him and made him prosper. Joseph had favor with Potiphar and he became overseer of his house.

2. Joseph was handsome and Potiphar's wife wanted him to love her. But Joseph would not sin with this woman. She lied to her husband, saying that Joseph had tried to grab her. Potiphar got angry and put Joseph into prison.

3. God blessed Joseph even while he was in prison and made him prosper and find favor in the eyes of the prison keeper. In prison, he met a butler and a baker who had dreams. (Explain dreams) Joseph was able to correctly interpret these dreams and the dreams came true. The baker was killed, but the butler was restored to his position. The baker forgot about Joseph in prison for 2 years.



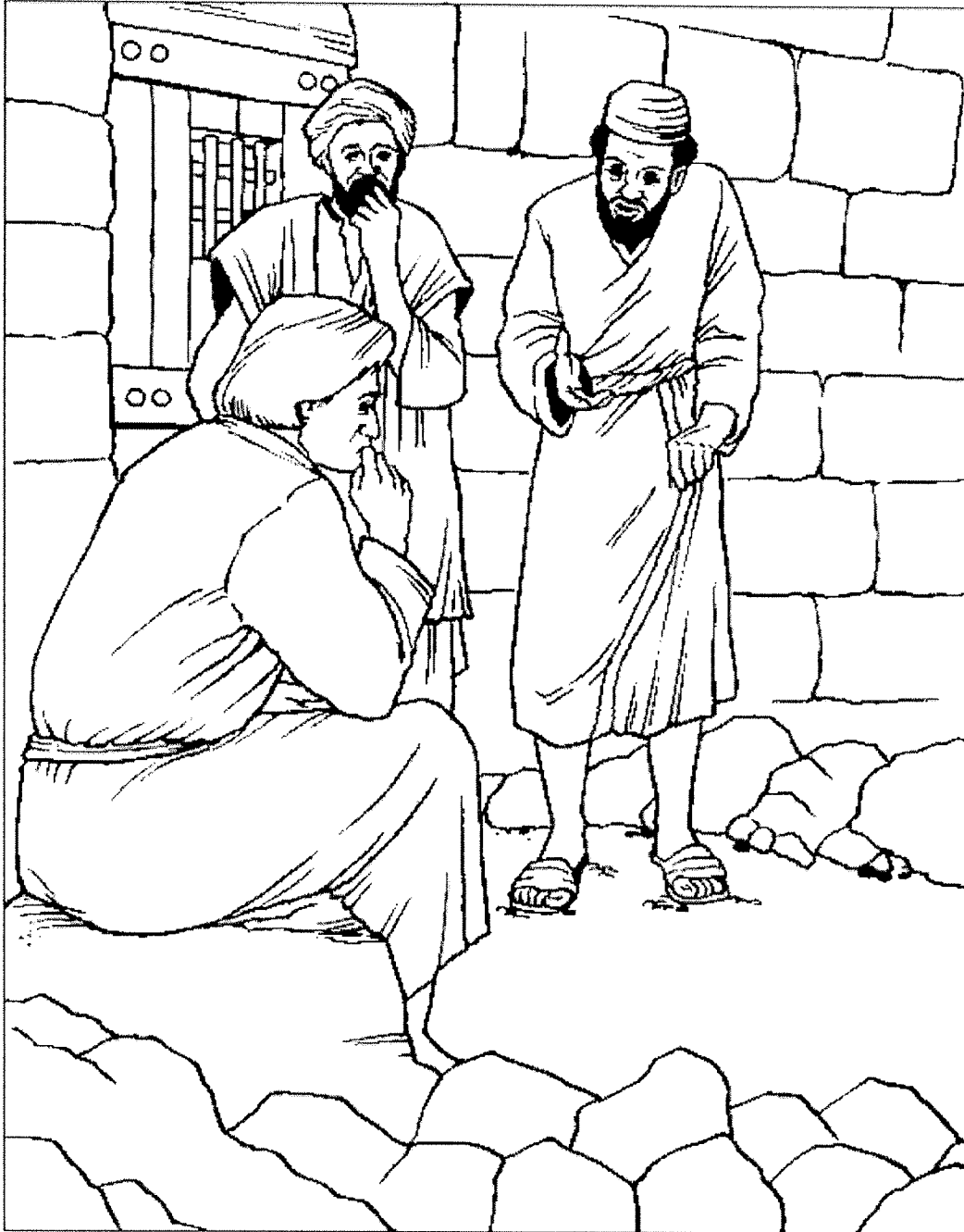

## JOSEPH IN PRISON

Scripture: Genesis 39 – 40



Memory Verse: Genesis 39:20b-21a

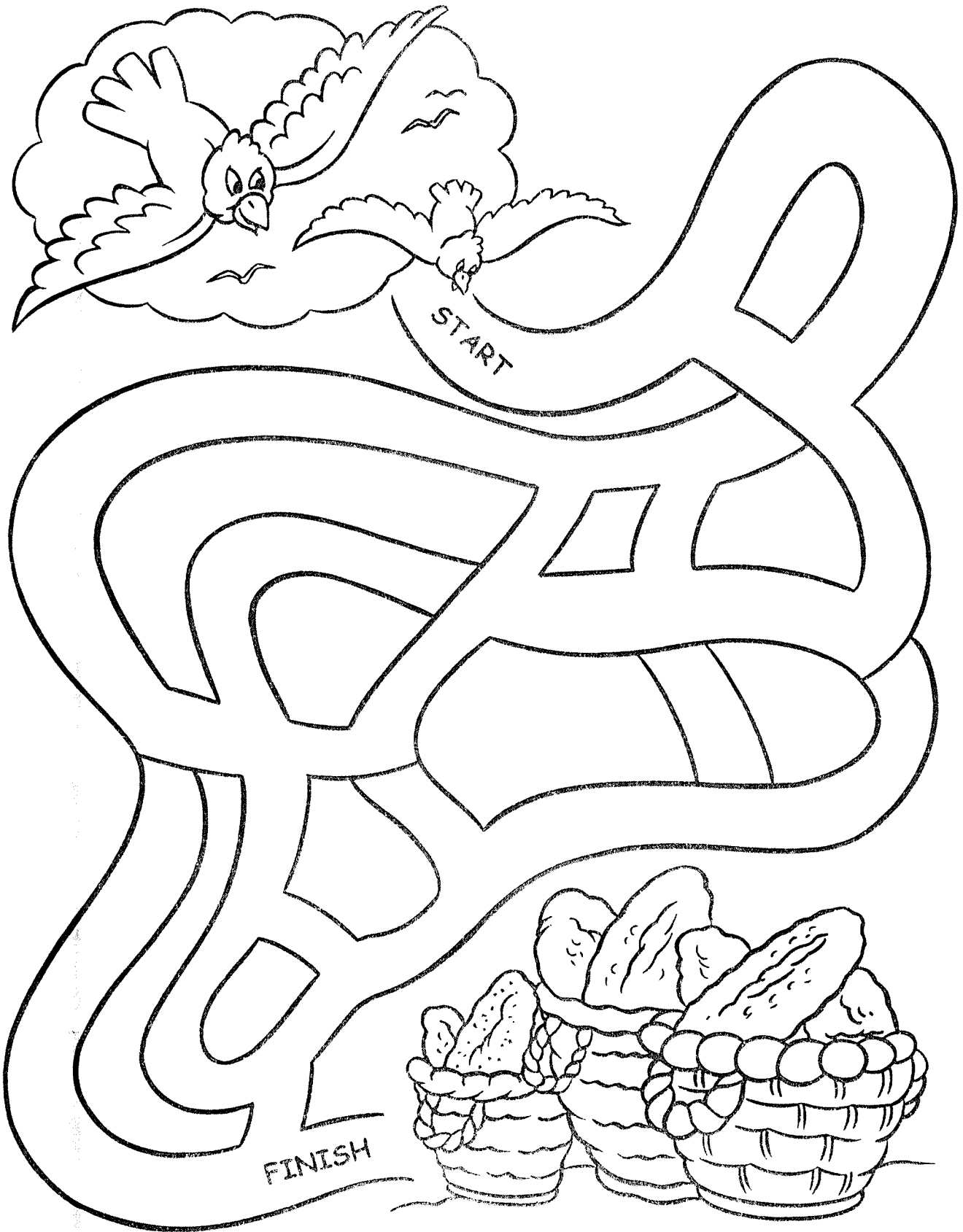

Help the birds get to the bread.

## 29. JOSEPH & POTIPHAR (GENESIS 39:1-23)

B I T T A T K I B S A S I N E  
Z U D A R T O V E R S E E R M  
Z N D W Y A B E P S F J D K Q  
N A I A I R H J O S E P H K N  
K F Q A Q C C P P I U K V R Y  
O F C U T R K P I D R O L E M  
B T Y E U P D E Y T T G B N A  
H Q U C G W A E D N O H G C S  
F P J E R Y D C S N O P C V V  
V H R N Q E P I F S E S Z C Y  
I A K O A P M T O F E S I C K  
O U S Q S N W Y W A A L S R W  
N U M X T P G B J I O V B H P  
K E E P E R E E W G F G O R L  
H T J N H N K R L W M E H R W

ANGEL  
BLESSED  
CAPTAIN  
EGYPT  
FAVOR  
JOSEPH

KEEPER  
LORD  
MERCY  
OVERSEER  
POTIPHAR

PRISON  
PROSPER  
SIN  
WICKEDNESS  
WIFE

# 29. JOSEPH & POTIPHAR

## (GENESIS 39:1-23)

P C S J E H T A W I V G G C J P D J Q I W M S P A  
 M D R O L Z N N Z O L E R L K L S U N P F A V O R  
 N U T F U I O M K T S U G M K C J O L T L O M P U  
 R Q A F W V S G N A V W N D W R A E W V A E O U E  
 X D Z O J V I F Q N M D G L I J E P K R P M A Z F  
 D C S P N B R H J R A W Z S F C H P T K E E P E R  
 C A D E S Q P A B P Z Y J N E V Q P S A P X T V P  
 U N N D E S S E L B S P P V I T O T I O I N M F T  
 G W J G Z Y B W B I H Z N R P S E C J Y R N Z R O  
 D T Q O E E I X R Q M W U C Z W W S S F C P J K N  
 T I I O L L A P B D L B O M Y H T P Y G E R S K I  
 A W J C B L M E K J S M W L Y P E C U E A O E Y J  
 S P T F Z N N S E Q V W F I O J B H E J X B M M J  
 T P D G F V T G F R O U L B C H K U A O V U X R Y  
 O W R E E S R E V O J F L M J K S E V U Q L P G T  
 T Q Y B H Q Y D J I J I M A F Q E C D G D P C I H  
 W T H Y N T L E J L E N S C A O U D Q F V M D N G  
 F A U N G A I O T S A G Z W H A H N N K S C T L F  
 A U Q M X Q S P E T W Y F J A W P Q E E M C N A Y  
 M U S H G E O Z J F L P P U H V E L N D S V X V Q  
 P O T I P H A R Z A Z Y G K Z M V K R B C S G M D  
 F H S H R F V C Z Y X B K O Y F A D Y K Z Z E O C  
 H E I L Q H Q C K Y P D B I N S R D Y K L H I U M  
 K R L D I P Z Q C O J R H T J W L O D A B F L V P  
 N J S R P J U I T M H C K E T U W K J T T M N Z O

ANGEL  
 BLESSED  
 CAPTAIN  
 EGYPT  
 FAVOR  
 JOSEPH

KEEPER  
 LORD  
 MERCY  
 OVERSEER  
 POTIPHAR

PRISON  
 PROSPER  
 SIN  
 WICKEDNESS  
 WIFE

## 29. JOSEPH & POTIPHAR (GENESIS 39:1-23)

### MEMORY VERSE:

*"Blessed are those who are persecuted for righteousness' sake, for theirs is the kingdom of heaven."* MATTHEW 5:10

### CIRCLE THE CORRECT WORD:

1. "Now Joseph had been taken down to (**GREECE, EGYPT**). And Potiphar, an officer of Pharaoh, captain of the guard, an Egyptian, bought him from the Ishmaelites who had taken him down there." **GENESIS 39:1**

### TRUE OR FALSE:

2. "And his master saw that the LORD was with him and that the LORD made all he did to prosper in his hand." **GENESIS 39:3**

TRUE OR FALSE

3. "So Joseph found favor in his sight, and served him. Then he made him overseer of his house, and all that he had he put in his hand." **GENESIS 39:4**

TRUE OR FALSE

### FILL IN THE BLANKS:

4. "So it was, from the time that he had made him overseer of his house and \_\_\_\_\_ that he had, that the LORD blessed the Egyptian's house for Joseph's sake; and the blessing of the LORD was on \_\_\_\_\_ that he had in the house and in the field." **GENESIS 39:5**

### CIRCLE THE CORRECT WORDS:

5. Then Potiphar's anger was aroused against Joseph, and his "master took him and put him into the (**PALACE, PRISON**), a place where the king's prisoners were confined. And he was there in (**PALACE, PRISON**)." **GENESIS 39:20**

### TRUE OR FALSE:

6. "But the LORD was with Joseph and showed him mercy, and He gave him favor in the sight of the keeper of the prison." **GENESIS 39:21**

TRUE OR FALSE

7. But the keeper of the prison did not trust Joseph, neither would he commit any duties to him. **GENESIS 39:22**

TRUE OR FALSE

8. "The keeper of the prison did not look into anything that was under Joseph's hand, because the LORD was with him; and whatever he did, the LORD made it prosper." **GENESIS 39:23**

TRUE OR FALSE

## 29. JOSEPH & POTIPHAR

### (GENESIS 39:1-23)

#### MEMORY VERSE:

*"Blessed are those who are persecuted for righteousness' sake, for theirs is the kingdom of heaven."* MATTHEW 5:10

#### FILL IN THE BLANKS:

1. "Now \_\_\_\_\_ had been taken down to \_\_\_\_\_. And \_\_\_\_\_, an officer of Pharaoh, captain of the guard, an Egyptian, bought him from the Ishmaelites who had taken him down there." **GENESIS 39:1**

#### TRUE OR FALSE:

2. "And his master saw that the LORD was with him and that the LORD made all he did to prosper in his hand." **GENESIS 39:3**

TRUE OR FALSE

3. "So Joseph found favor in his sight, and served him. Then he made him overseer of his house, and all that he had he put in his hand." **GENESIS 39:4**

TRUE OR FALSE

#### FILL IN THE BLANKS:

4. "So it was, from the time that he had made him overseer of his house and \_\_\_\_\_ that he had, that the LORD blessed the Egyptian's house for Joseph's sake; and the blessing of the LORD was on \_\_\_\_\_ that he had in the house and in the field." **GENESIS 39:5**

5. Then Potiphar's anger was aroused against Joseph, and his "master took him and put him into the \_\_\_\_\_, a place where the king's prisoners were confined. And he was there in \_\_\_\_\_." **GENESIS 39:20**

6. "But the LORD was with Joseph and showed him \_\_\_\_\_, and He gave him \_\_\_\_\_ in the sight of the keeper of the prison." **GENESIS 39:21**

#### TRUE OR FALSE:

7. But the keeper of the prison did not trust Joseph, neither would he commit any duties to him. **GENESIS 39:22**

TRUE OR FALSE

8. "The keeper of the prison did not look into anything that was under Joseph's hand, because the LORD was with him; and whatever he did, the LORD made it prosper." **GENESIS 39:23**

TRUE OR FALSE

## 29. JOSEPH & POTIPHAR (GENESIS 39:1-23)

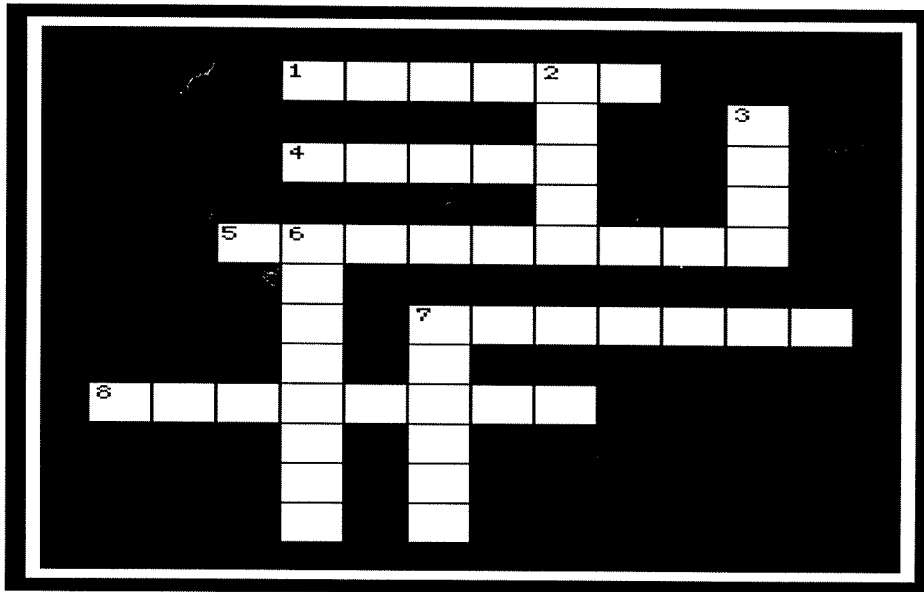

- 1 ACROSS "Blessed are those who are persecuted for righteousness' sake, for theirs is the kingdom of \_\_\_\_." **MATTHEW 5:10**
- 2 DOWN "Now Joseph had been taken down to \_\_\_\_\_. And Potiphar, an officer of Pharaoh, captain of the guard, an Egyptian, bought him from the Ishmaelites who had taken him down there." **GENESIS 39:1**
- 3 DOWN "And his master saw that the \_\_\_\_\_ was with him and that the LORD made all he did to prosper in his hand." **GENESIS 39:3**
- 6 DOWN "So Joseph found favor in his sight, and served him. Then he made him \_\_\_\_\_ of his house, and all that he had he put in his hand." **GENESIS 39:4**
- 8 ACROSS "So it was, from the time that he had made him overseer of his house and all that he had, that the LORD blessed the Egyptian's house for Joseph's sake; and the \_\_\_\_\_ of the LORD was on all that he had in the house and in the field." **GENESIS 39:5**
- 7 DOWN Then Potiphar's anger was aroused against Joseph, and his "master took him and put him into the \_\_\_\_\_, a place where the king's prisoners were confined. And he was there in prison."  
**GENESIS 39:20**
- 4 ACROSS "But the LORD was with Joseph and showed him \_\_\_\_\_, and He gave him favor in the sight of the keeper of the prison." **GENESIS 39:21**
- 5 ACROSS "And the keeper of the prison \_\_\_\_\_ to Joseph's hand all the prisoners who were in prison."  
**GENESIS 39:22**
- 7 ACROSS "The keeper of the prison did not look into anything that was under Joseph's hand, because the LORD was with him; and whatever he did, the LORD made it \_\_\_\_\_." **GENESIS 39:23**

## Joseph Tells The Meaning Of The Prisoners' Dreams (Genesis 40:1-23)

Use the secret code below to decode the following message:

SECRET CODE												
1	2	3	4	5	6	7	8	9	10	11	12	13
A	B	C	D	E	F	G	H	I	J	K	L	M
14	15	16	17	18	19	20	21	22	23	24	25	26
N	O	P	Q	R	S	T	U	V	W	X	Y	Z

7    15    4                    8    5    12    16    5    4  
 —    —    —                    —    —    —    —    —    —

10    15    19    5    16    8                    8    5                    3    1    14  
 —    —    —    —    —    —                    —    —                    —    —    —

8    5    12    16                    25    15    21                    20    15    15!  
 —    —    —    —                    —    —    —                    —    —    —!



# JOSEPH IN PRISON

## (GENESIS 40:1-41:57)

### MEMORY VERSE:

*"Blessed are the pure in heart, for they shall see God."* MATTHEW 5:8

### FILL IN THE BLANKS:

1. "And it came to pass after these things that the \_\_\_\_\_ and the \_\_\_\_\_ of the king of Egypt offended their lord, the king of Egypt." GENESIS 40:1

### TRUE OR FALSE:

2. "So he put them in custody in the house of the captain of the guard, in the prison, the place where Joseph was confined." GENESIS 40:3

TRUE OR FALSE

3. "Then the butler and the baker of the king of Egypt, who were confined in the prison, dreamed a dream, both of them." GENESIS 40:5

TRUE OR FALSE

### UNDERLINE THE CORRECT ANSWER:

4. "And they said to him, 'We each have dreamed a dream, and there is no interpreter of it.' And Joseph said to them..." GENESIS 40:8
  - a. Do not interpretations belong to God?
  - b. Tell them to me, please.
  - c. both of these

### TRUE OR FALSE:

5. The Pharaoh "restored the chief butler to his butlership again, and he placed the cup in Pharaoh's hand. But he hanged the chief baker, as Joseph had interpreted to them." GENESIS 40:21-22

TRUE OR FALSE

### CIRCLE THE CORRECT WORDS:

6. "Yet the chief butler did not remember Joseph, but (FORGOT, FORGAVE) him." GENESIS 40:23
7. "Then it came to pass, at the end of two full (DAYS, YEARS), that Pharaoh had a dream." GENESIS 41:1
8. "Now it came to pass in the morning that his spirit was troubled, and he sent and called for all the magicians of Egypt and all its wise men. And Pharaoh told them his (SECRETS, DREAMS), but there was no one who could interpret them for Pharaoh." GENESIS 41:8
9. "Then Pharaoh sent and called Joseph, and they brought him hastily out of the (DUNGEON, PALACE); and he shaved, changed his clothing, and came to Pharaoh." GENESIS 41:14
10. After Joseph interpreted Pharaoh's dreams, Pharaoh "said to his servants, 'Can we find such a one as this, a man in whom is the Spirit of God?' Then Pharaoh said to Joseph, 'Inasmuch as (GOD, MAN) has shown you all this, there is no one as discerning and wise as you. You shall be over my house, and all my people shall be ruled according to your word; only in regard to the (CROWN, THRONE) will I be greater than you.'" GENESIS 41:38-40

# JOSEPH IN PRISON

## (GENESIS 40:1-41:57)

### MEMORY VERSE:

*"Blessed are the pure in heart, for they shall see God."* MATTHEW 5:8

### FILL IN THE BLANKS:

1. "And it came to pass after these things that the \_\_\_\_\_ and the \_\_\_\_\_ of the king of Egypt offended their lord, the king of Egypt." **GENESIS 40:1**
2. "So he put them in custody in the house of the captain of the guard, in the prison, the place where \_\_\_\_\_ was confined." **GENESIS 40:3**
3. "Then the butler and the baker of the king of Egypt, who were confined in the prison, dreamed a \_\_\_\_\_, both of them." **GENESIS 40:5**

### UNDERLINE THE CORRECT ANSWER:

4. "And they said to him, 'We each have dreamed a dream, and there is no interpreter of it.' And Joseph said to them..." **GENESIS 40:8**
  - a. Do not interpretations belong to God?
  - b. Tell them to me, please.
  - c. both of these

### TRUE OR FALSE:

5. The Pharaoh "restored the chief butler to his butlership again, and he placed the cup in Pharaoh's hand. But he hanged the chief baker, as Joseph had interpreted to them." **GENESIS 40:21-22**  
**TRUE OR FALSE**

### FILL IN THE BLANKS:

6. "Yet the chief butler did not remember Joseph, but \_\_\_\_\_ him." **GENESIS 40:23**
7. "Then it came to pass, at the end of two full \_\_\_\_\_, that Pharaoh had a dream." **GENESIS 41:1**
8. "Now it came to pass in the morning that his spirit was troubled, and he sent and called for all the magicians of Egypt and all its wise men. And Pharaoh told them his \_\_\_\_\_, but there was no one who could interpret them for Pharaoh." **GENESIS 41:8**
9. "Then Pharaoh sent and called Joseph, and they brought him hastily out of the \_\_\_\_\_; and he shaved, changed his clothing, and came to Pharaoh." **GENESIS 41:14**

### CIRCLE THE CORRECT WORDS:

10. After Joseph interpreted Pharaoh's dreams, Pharaoh "said to his servants, 'Can we find such a one as this, a man in whom is the Spirit of God?' Then Pharaoh said to Joseph, 'Inasmuch as **(GOD, MAN)** has shown you all this, there is no one as discerning and wise as you. You shall be over my house, and all my people shall be ruled according to your word; only in regard to the **(CROWN, THRONE)** will I be greater than you.'" **GENESIS 41:38-40**

# JOSEPH IN PRISON

## (GENESIS 40:1-41:57)

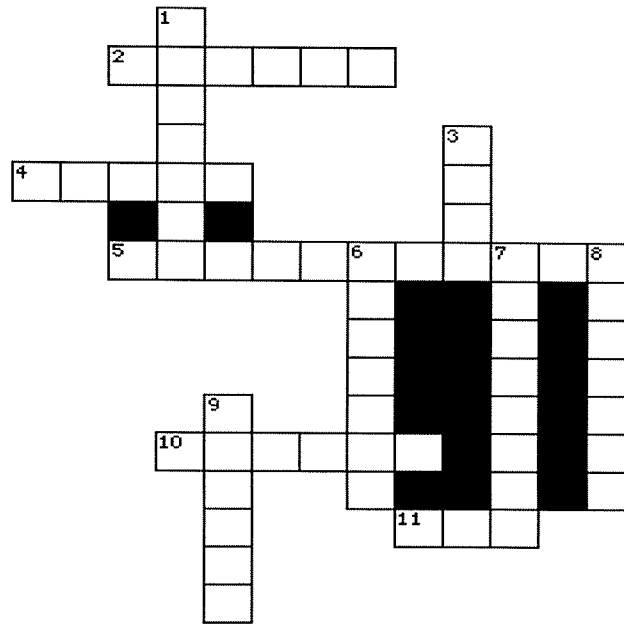

- 3 DOWN "Blessed are the \_\_\_\_\_ in heart, for they shall see God." **MATTHEW 5:8**
- 2 ACROSS "And it came to pass after these things that the \_\_\_\_\_ and the baker of the king of Egypt offended their lord, the king of Egypt." **GENESIS 40:1**
- 9 DOWN "So he put them in custody in the house of the captain of the guard, in the prison, the place where \_\_\_\_\_ was confined." **GENESIS 40:3**
- 4 ACROSS "Then the butler and the \_\_\_\_\_ of the king of Egypt, who were confined in the prison, dreamed a dream, both of them." **GENESIS 40:5**
- 8 DOWN "And they said to him, 'We each have \_\_\_\_\_ a dream, and there is no interpreter of it.' And Joseph said to them, 'Do not interpretations belong to God? Tell them to me, please.'" **GENESIS 40:8**
- 5 ACROSS The Pharaoh "restored the chief butler to his butlership again, and he placed the cup in Pharaoh's hand. But he hanged the chief baker, as Joseph had \_\_\_\_\_ to them." **GENESIS 40:21-22**
- 10 ACROSS "Yet the chief butler did not remember Joseph, but \_\_\_\_\_ him." **GENESIS 40:23**
- 6 DOWN "Then it came to pass, at the end of two full years that \_\_\_\_\_ had a dream." **GENESIS 41:1**
- 7 DOWN "Now it came to pass in the morning that his spirit was \_\_\_\_\_ and he sent and called for all the magicians of Egypt and all its wise men. And Pharaoh told them his dreams but there was no one who could interpret them for Pharaoh." **GENESIS 41:8**
- 1 DOWN "Then Pharaoh sent and called Joseph, and they brought him hastily out of the \_\_\_\_\_ ; and he shaved, changed his clothing, and came to Pharaoh." **GENESIS 41:14**
- 11 ACROSS After Joseph interpreted Pharaoh's dreams, Pharaoh "said to his servants, 'Can we find such a one as this, a man in whom is the Spirit of God?' Then Pharaoh said to Joseph, 'Inasmuch as \_\_\_\_\_ has shown you all this, there is no one as discerning and wise as you. " **GENESIS 41:38-39**

# JOSEPH IN PRISON

## (GENESIS 40:1-41:57)

D M I Y C K Y Z B Z L J E K V Z Z I H R G U T P C R I P Q Y  
 Y H M A E R D X D F O C B D R L J N G P C V B Q P R I S O N  
 H L V G C C O P N P I V K D F U S L F J J Y K T U N P I L A  
 U D N L Q T F J O G T T S O E T M B Y P N Y I F A L K R J O  
 Q I V I I I V H E K E W U K J M X A Q N H R J V U M D F V M  
 R R B O W O L G G B J H H Q O O P K D Q I T E I T A A V U B  
 S E Q V Z T S E N U K P P K U E C E C P E A F F A M I N E H  
 S U Y Q K A V U U K K J E L G M T R M Q D E T F E X Y Q L N  
 I B E Z S S E N D N I K V W F X D P P F B U S P K T S L E L  
 L W U U K N M W R C P H A K K N T A Y G Y S A R A O G I A V  
 S J L T S R A D C U Z Q R I D O M V O G K S G H O C M P F I  
 J N N A L A Z W G M Y O L J B B M L E A E F Q N P N S O I U  
 F S V N Q E D Y R G Y A W S K U G O A T O G R O F E T R M S  
 G Z Q M J P R P G D O W J U K S E U Y M K J F Y O L S A I S  
 R K T G B I S Z N L O D U E A L T V U M J S H M P V L O O A  
 A B A F B Q H W G S J V O A T P I O H A M G W Z F E A V J L  
 I Z T E R P R E T N I M E V W M K Z R O V R U U D F B K Q Y  
 N F Q H P D M B Z V F F P D L C X A A E W A I I H G H R H J  
 F H F A R L X M J R A S T Q A C P U E K H S K K D S P W U H  
 O N H W B J E W P C H W C E P V P E C C Z O E N F L F Y N W  
 P G P V K Q S N N M A U S N P Z U F N Y F F U M W C U O H Z  
 E F J P E R V U T L S D C R A N Z P A U I N Y S Y Y V B O A  
 O G T E F I O F U Y H W H Y N F V T I D Z T B C E D L G P D  
 O R B S J L J I O B Z S O Y V N F O H O A R A H P S G N I K  
 C R E M E M B E R N Y J U C Q S R N Z Y T Q T D S T R P U P  
 F Q I G T S J N F A N H E D D M K I S G M C I N K L R F Y N  
 K I A D E T E G L C J Q C J V O K J N T G D O Y T V E Q N I  
 B P M E J F A N L W T O N I S A Y J C I G Y W J E P V K M C  
 Y H N P Z A W P M J P E Q P M T R Y Z I R R A D F T U G H N  
 N Z T Z Z Y L Y S U L W L T C M G T X P H Q E V Y J V N B Z

BAKER  
 BUTLER  
 CAPTAIN  
 COWS  
 DREAM  
 DUNGEON

EGYPT  
 FAMINE  
 FOOD  
 FORGOT  
 GOD  
 GRAIN

INTERPRET  
 JOSEPH  
 KING  
 KINDNESS  
 PHARAOH  
 PLENTY

PRISON  
 REMEMBER  
 RING  
 SAD  
 STOREHOUSES

HELP JOSEPH GET TO THE THRONE OF PHARAOH

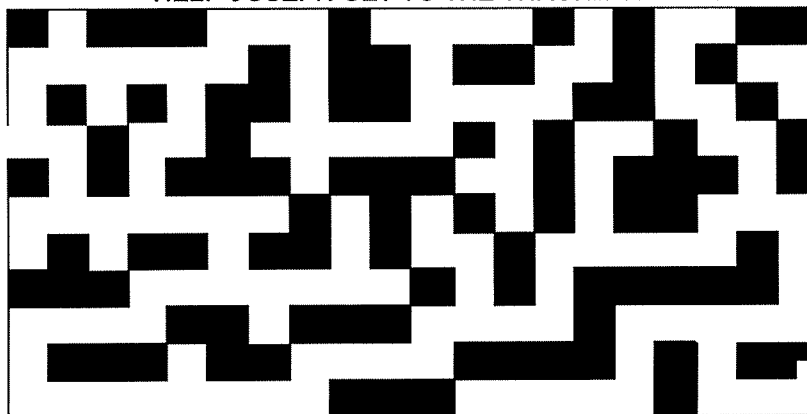

# JOSEPH IN PRISON

(GENESIS 40:1-41:57)

T O G R O F B U T L E R Z S E  
 N H K I N G R D D Q L F V D N  
 B P L T W V E S W O C F Q T I  
 U E T W S N M Y Y P G Z P I M  
 R S G D E O E N T S U Y N E A  
 E O H R S E M K N M G T Q B F  
 K J Q E U G B P E E E D S B E  
 A P C A O N E H L R O R S U O  
 B R A M H U R Q P O O F E Q N  
 Q I P V E D U R F U N M N J R  
 D S T G R Z E O F D T C D A L  
 Y O A N O T W Z L Z L R N D X  
 C N I I T P H A R A O H I I D  
 Z S N R S Q D A S O R I K O V  
 Y V Z L M B G R A I N P N B Z

- |         |        |           |             |
|---------|--------|-----------|-------------|
| BAKER   | EGYPT  | INTERPRET | PRISON      |
| BUTLER  | FAMINE | JOSEPH    | REMEMBER    |
| CAPTAIN | FOOD   | KINDNESS  | RING        |
| COWS    | FORGOT | KING      | SAD         |
| DREAM   | GOD    | PHARAOH   | STOREHOUSES |
| DUNGEON | GRAIN  | PLENTY    |             |

HELP JOSEPH GET TO THE THRONE OF PHARAOH

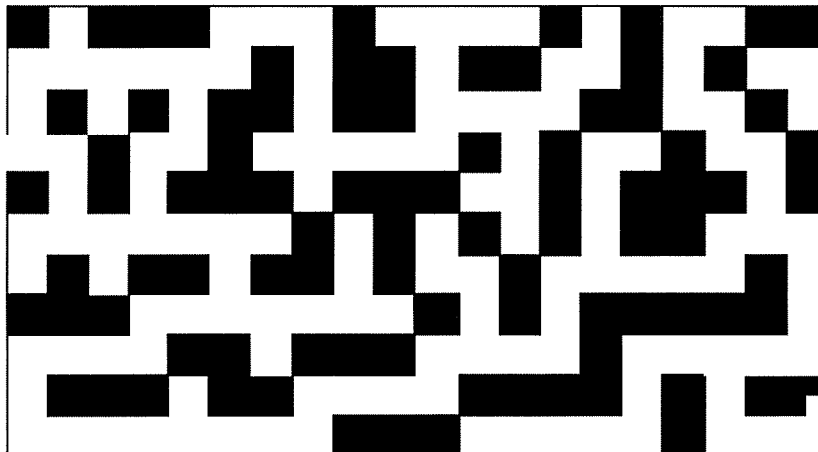

**Lesson 25: Middle School**

**RADIO PLAY OF GENESIS 39-40--JOSEPH & POTIPHAR'S WIFE,  
THE CUPBEARER & BAKER**

**News Desk:** This is the latest report from Christian Radio. Remember we've been following the story of Joseph who was sold by his jealous brothers to some Ishmaelites who sold Joseph to the Egyptian captain of the guard named Potiphar. Joseph has been in charge of Potiphar's household now for some time. One of our reporters is there now talking with one of Potiphar's servants.

**Reporter:** So what do you think of Joseph, your master's new attendant? I've heard he's been put in charge of Potiphar's household and entrusted with everything he owns.

**Servant:** Joseph? Yes, since he's arrived, everything has been going great for Potiphar. Joseph's God of Israel seems to smile on everything he does and gives him success. Therefore everything in Potiphar's house and fields prospers because of Joseph and this God that blesses him.

**Reporter:** Great to hear! So no problems now that this Joseph the Israelite is here?

**Servant:** Well . . . there is one thing. Joseph is very well-built and handsome, AND Potiphar's wife . . . well, she's always flirting with Joseph. He's very careful as slaves and servants must be; he tries to stay away from her as much as possible. But--off the record--I'm a little worried because Potiphar's wife likes getting her way no matter who gets hurt!

**Reporter:** That's the story from Potiphar's house. Back to you at the news desk.

**Several weeks later:**

**News Desk:** We're back with a breaking story about a scandal at Potiphar's house. Most of you know he's a captain of the guard here in Egypt. Let's see if we can get him to talk with us.

**Reporter:** Can you tell us what happened, Potiphar?

**Potiphar:** (*angrily*) Oh, I'll tell you what happened all right! That slave Joseph that I trusted with everything, thought he could take advantage of my absence and get too friendly with my wife! She had evidence, too-- Joseph's own cloak in her hands! My wife's exact words were "That Hebrew slave you brought us came to me to make sport of me. But as soon as I screamed for help, he left his cloak beside me and ran out of the house." Good thing I put him in prison or I would have killed him I was so angry!

**Reporter 2:** Thank you, Joseph, for speaking with me. (to Warden) Warden, tell us about your prisoner, Joseph.

**Warden:** He's a born leader, this Joseph. Things are running smoothly here at the prison ever since I've put Joseph in charge--just amazing!

**Reporter:** News Desk, that's the other side of the story for our listeners, here from the prison.

**News Desk:** Thank you for that report.

**Some time later:**

**News Desk:** This is Christian Radio coming to you with a taped report once again from the Egyptian prison where the king or pharaoh's prisoners are sent. You may remember weeks ago the report about the Israelite Joseph who was falsely accused by Potiphar's wife. When our reporter arrived at the prison this time, he found Joseph speaking with both the king's cupbearer and the king's baker who had angered their master. Listen in . . .

**Joseph:** Why are your faces so sad today?

**Cupbearer:** We both had dreams . . .

**Baker:** . . . but there is no one to interpret them.

**Joseph:** Do not interpretations belong to God? Tell me your dreams.

**Cupbearer:** In my dream I saw a vine in front of me, and on the vine were three branches. As soon as it budded, it blossomed, and its clusters ripened into grapes. Pharaoh's cup was in my hand, and I took the grapes, squeezed them into Pharaoh's cup and put the cup in his hand.

**Joseph:** This is what it means. The three branches are three days. Within three days Pharaoh will lift up your head and restore you to your position, and you will put Pharaoh's cup in his hand, just as you used to do when you were his cupbearer. But when all goes well with you, remember me and show me kindness; mention me to Pharaoh and get me out of this prison. For I was forcibly carried off from the land of the Hebrews, and even here I have done nothing to deserve being put in a dungeon.

**Baker:** That was a favorable interpretation. I too had a dream: On my head were three baskets of bread. In the top basket were all kinds of baked goods for Pharaoh, but the birds were eating them out of the basket on my head.

## Middle School

### Lesson 25: Draw Joseph in each situation.

Name \_\_\_\_\_

Joseph, Overseer for Potiphar \_\_\_\_\_ Joseph, Overseer of the Prison \_\_\_\_\_

\_\_\_\_\_ Joseph with the Cupbearer and the Baker \_\_\_\_\_

#### Discussion Questions:

1. Who was responsible for Joseph's quick rise to responsibility in Potiphar's house?
2. What sort of person is placed in charge of another man's possessions?
3. How did Joseph resist the temptation with Potiphar's wife?
4. What motivated Potiphar's wife to lie about her encounter with Joseph?
5. What does the Lord's care for Joseph show us about times when we suffer injustices?
6. What lessons can we learn from Joseph's behavior in Potiphar's house and in prison?
7. Name another person in the Bible who had dreams and visions and could interpret for others. . .
8. When we read that the cupbearer forgot all about Joseph, what are we reminded to do?



**Year 1**

**Week 26**

## **Pharaoh's Dreams**

**Scriptures: Genesis 41**

**Key Verse: Genesis 41:16 Joseph answered Pharaoh saying, "It is not in me; God will give Pharaoh an answer of peace."**

**Key Points:**

1. Pharaoh had 2 dreams. He had one dream about 7 fat cows coming up out of the river and eating up 7 skinny cows. The second dream was similar, 7 thin, blighted heads of grain devoured 7 plump, full heads of grain. These dreams troubled Pharaoh and no one could interpret the dreams.
2. The butler finally remembered Joseph and told Pharaoh how he had interpreted his dream. Pharaoh sent for Joseph and he interpreted his dreams for him. Joseph told Pharaoh there would be 7 years of plenty, then 7 years of famine that would eat up the 7 good years.
3. Joseph advised Pharaoh to set up a man to be over the land of Egypt and officers to collect one-fifth of the grain in the good years to save for the famine. Pharaoh recognized that God was with Joseph and that he was wise. He appointed Joseph to be over the land of Egypt and clothed him with fine clothing and jewelry.
4. Joseph was 30 years old when he was put over Egypt. He had two sons during this time by his wife Asenath: Manasseh and Ephraim.
5. Joseph gathered much grain during the plentiful years. When the famine was over all the face of the earth, all the countries came to Joseph to buy grain for the famine was severe.

## 29. JOSEPH & POTIPHAR (GENESIS 39:1-23)



"And it came to pass, when his master heard the words of his wife, which she spake unto him, saying, After this manner did thy servant to me; that his wrath was kindled."

**GENESIS 39:19**

# JOSEPH IN PRISON

(GENESIS 40:1-41:57)



“And Joseph's master took him, and put him into the prison, a place where the king's prisoners *were* bound: and he was there in the prison.”

**GENESIS 39:20**

## Joseph's dreams crafts

Joseph dream wheel ~ print on cardstock and cut out where indicated. Let the children color/and or find stickers to use on the wheel.

Fat cows/skinny cows ~ use paper plate folded over to make cow. You can fold them to be either fat or skinny.

Cut out this  
window.

*the*  
**Joseph • Dreamer**



[www.gospelhall.org](http://www.gospelhall.org)

**Year 1**

**Week 26**

## **Pharaoh's Dreams**

**Scriptures: Genesis 41**

**Key Verse: Genesis 41:16 Joseph answered Pharaoh saying, "It is not in me; God will give Pharaoh an answer of peace."**

**Key Points:**

1. Pharaoh had 2 dreams. He had one dream about 7 fat cows coming up out of the river and eating up 7 skinny cows. The second dream was similar, 7 thin, blighted heads of grain devoured 7 plump, full heads of grain. These dreams troubled Pharaoh and no one could interpret the dreams.

2. The butler finally remembered Joseph and told Pharaoh how he had interpreted his dream. Pharaoh sent for Joseph and he interpreted his dreams for him. Joseph told Pharaoh there would be 7 years of plenty, then 7 years of famine that would eat up the 7 good years.

3. Joseph advised Pharaoh to set up a man to be over the land of Egypt and officers to collect one-fifth of the grain in the good years to save for the famine. Pharaoh recognized that God was with Joseph and that he was wise. He appointed Joseph to be over the land of Egypt and clothed him with fine clothing and jewelry.

4. Joseph was 30 years old when he was put over Egypt. He had two sons during this time by his wife Asenath: Manasseh and Ephraim.

5. Joseph gathered much grain during the plentiful years. When the famine was over all the face of the earth, all the countries came to Joseph to buy grain for the famine was severe.

## 29. JOSEPH & POTIPHAR (GENESIS 39:1-23)



"And it came to pass, when his master heard the words of his wife, which she spake unto him, saying, After this manner did thy servant to me; that his wrath was kindled."

**GENESIS 39:19**

# JOSEPH IN PRISON

(GENESIS 40:1-41:57)



“And Joseph's master took him, and put him into the prison, a place where the king's prisoners *were* bound: and he was there in the prison.”

**GENESIS 39:20**



## Joseph's dreams crafts

Joseph dream wheel ~ print on cardstock and cut out where indicated. Let the children color/and or find stickers to use on the wheel.

Fat cows/skinny cows ~ use paper plate folded over to make cow. You can fold them to be either fat or skinny.

Cut out this window.

# Joseph • the Dreamer

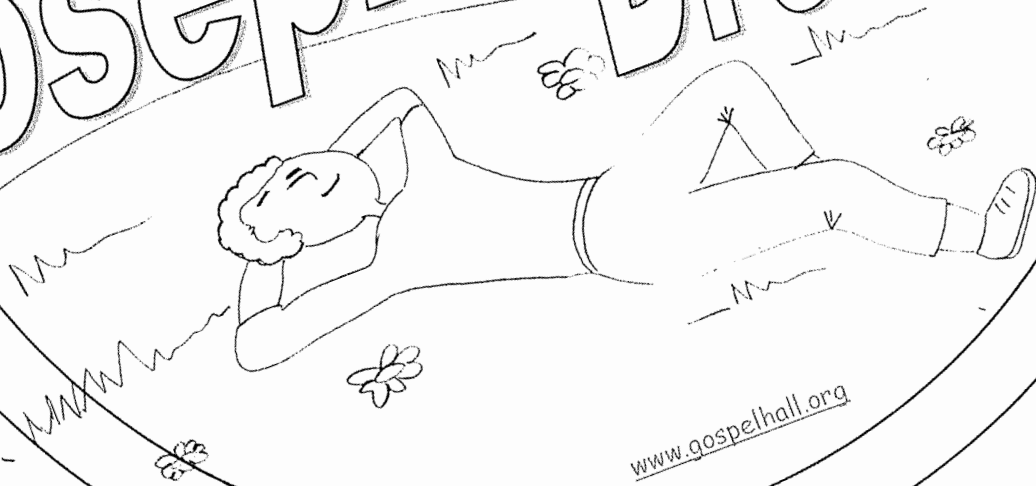

[www.gospelhall.org](http://www.gospelhall.org)



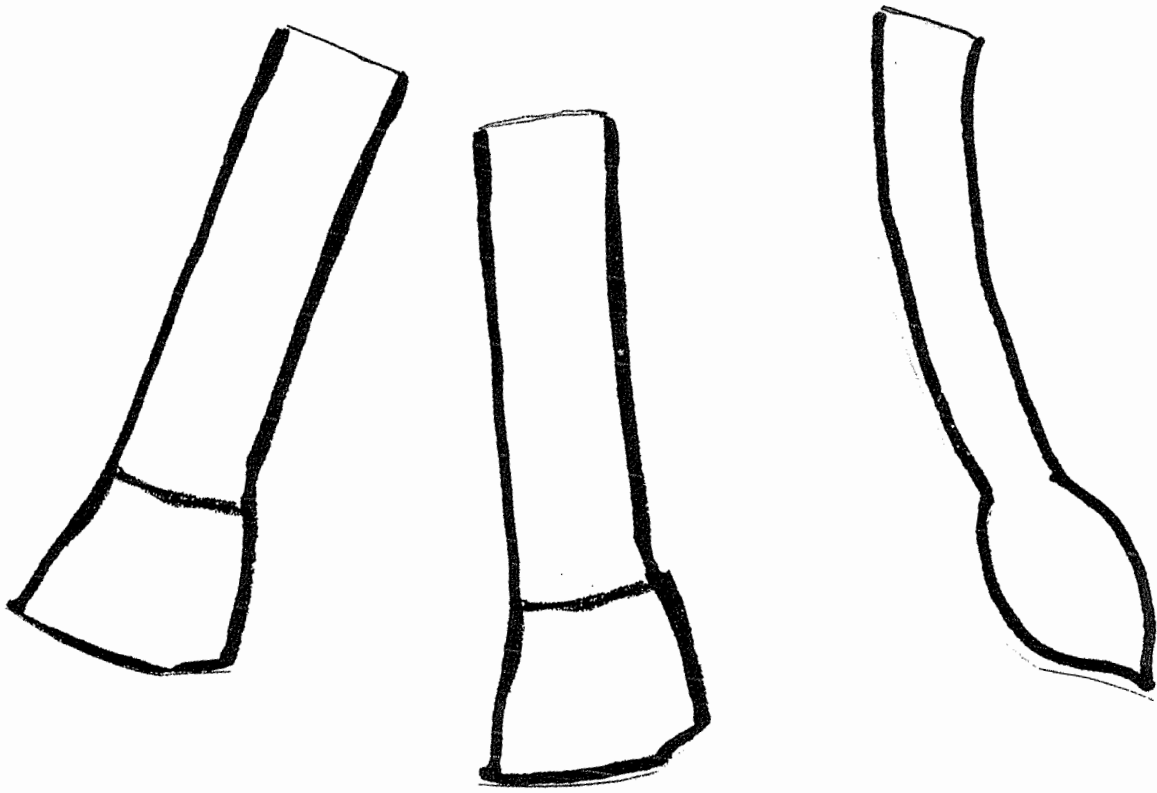
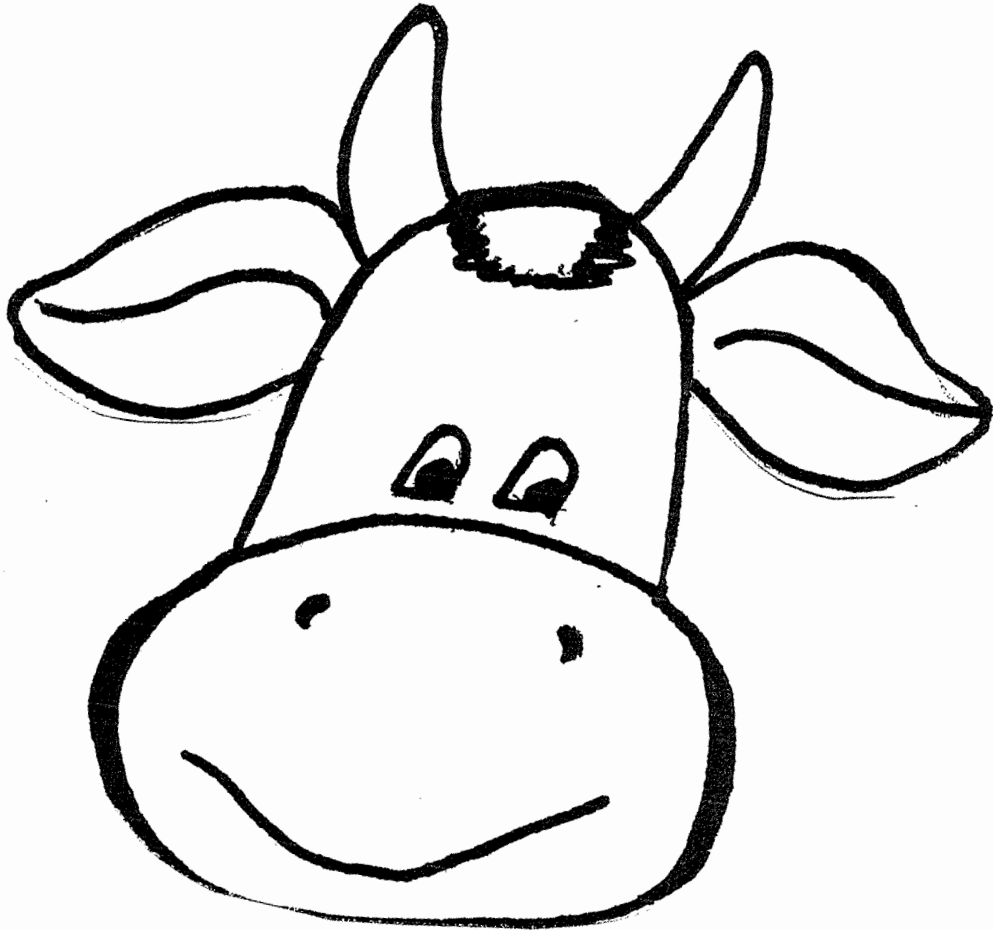

Seven fat cows,  
Seven skinny cows  
Genesis 41

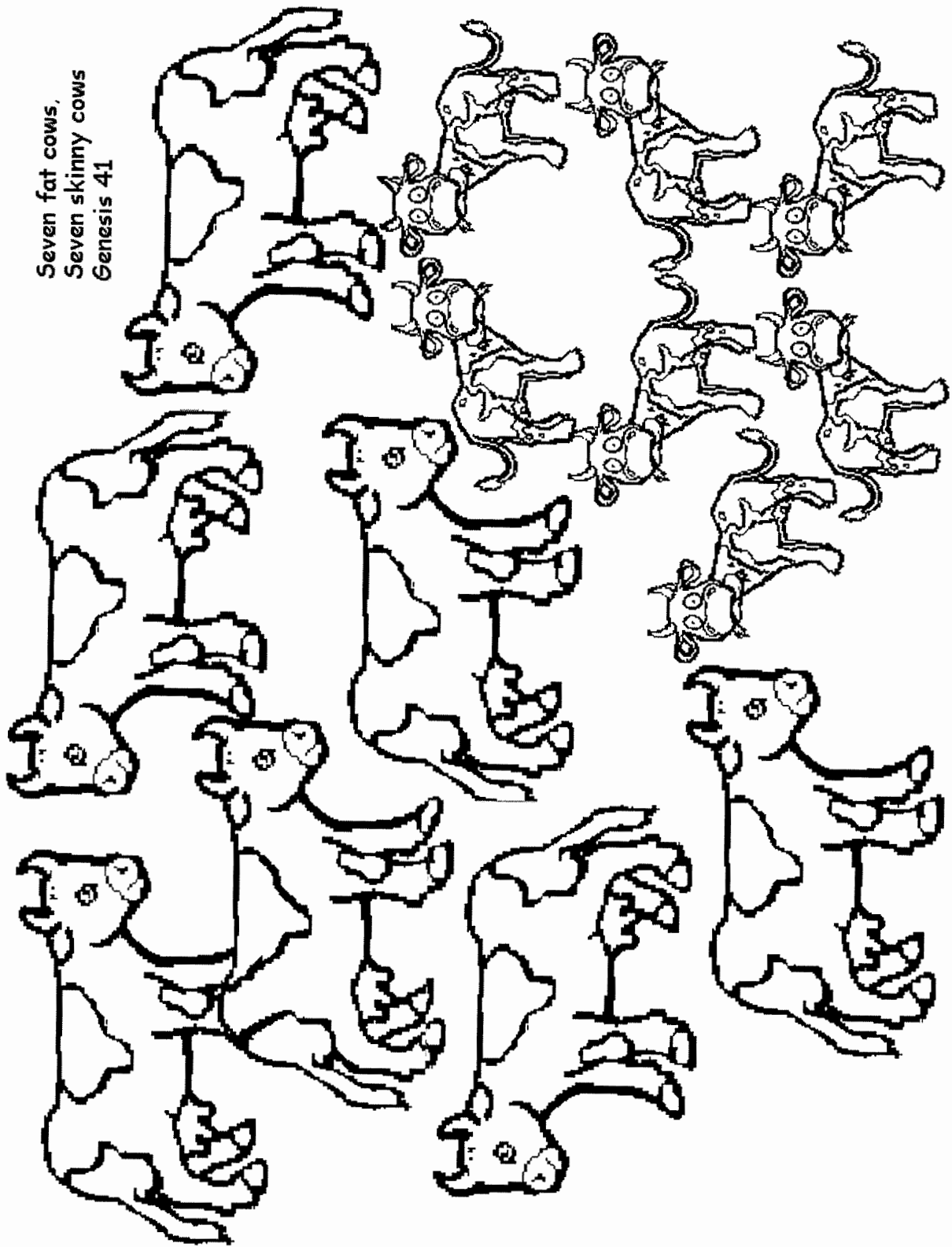

The seven thin ears of corn devoured  
the seven good ears of corn.  
Genesis 41



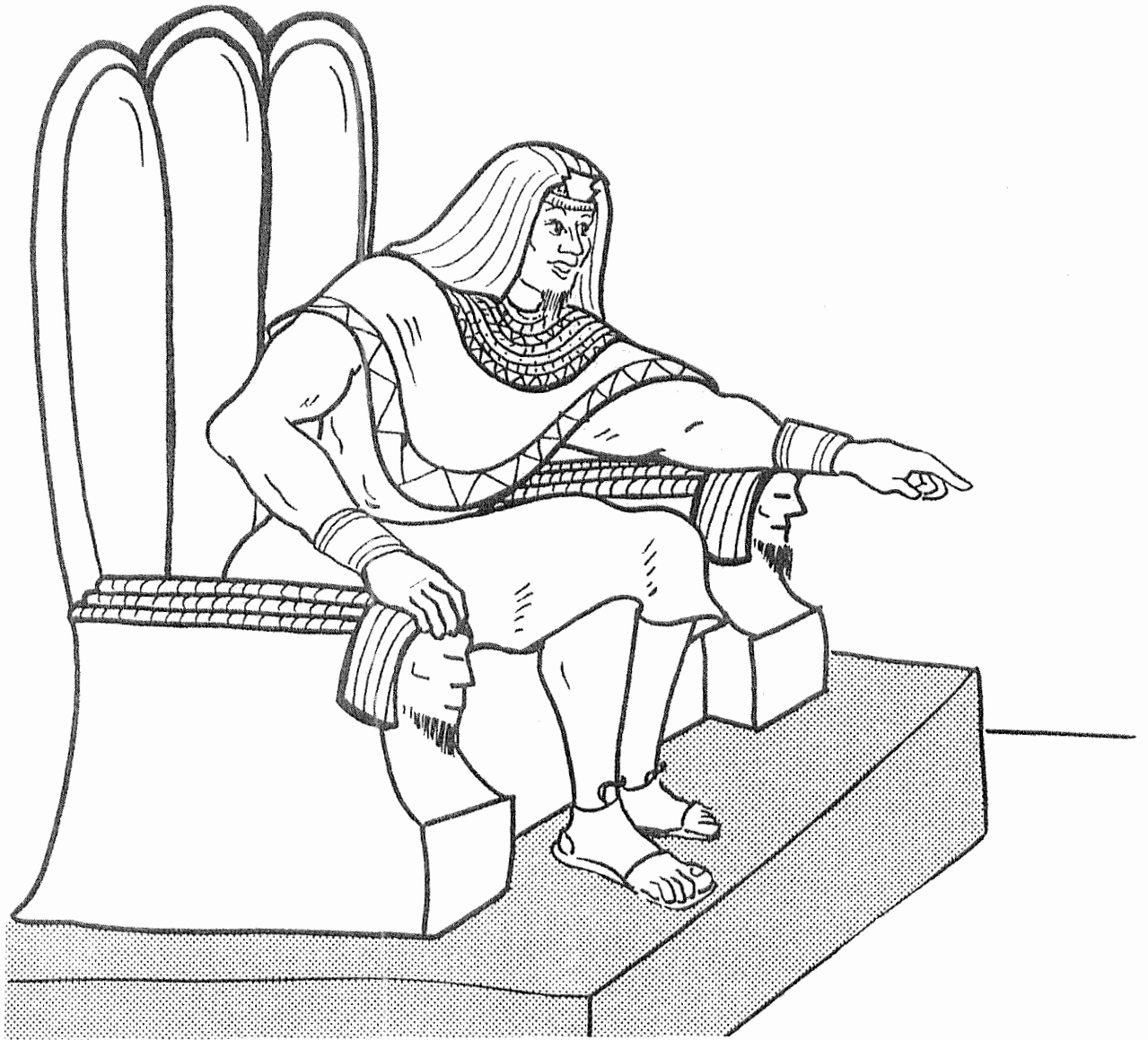

As an adult, Joseph became a high official in Egypt.

When a great famine came over the land, people came to Egypt  
from all over to buy food.

Jacob sent his sons to find food in Egypt.

Joseph welcomed his brothers and told them that  
they could make their home in Egypt.

GENESIS - Chapter 41, Verse 55; Chapter 42, Verse 3;  
Chapter 47, Verses 5-6

Genesis 41:36- “Then that food shall be as a reserve for the land for the seven years of famine which shall be in the land of Egypt, that the land may not perish during the famine.”

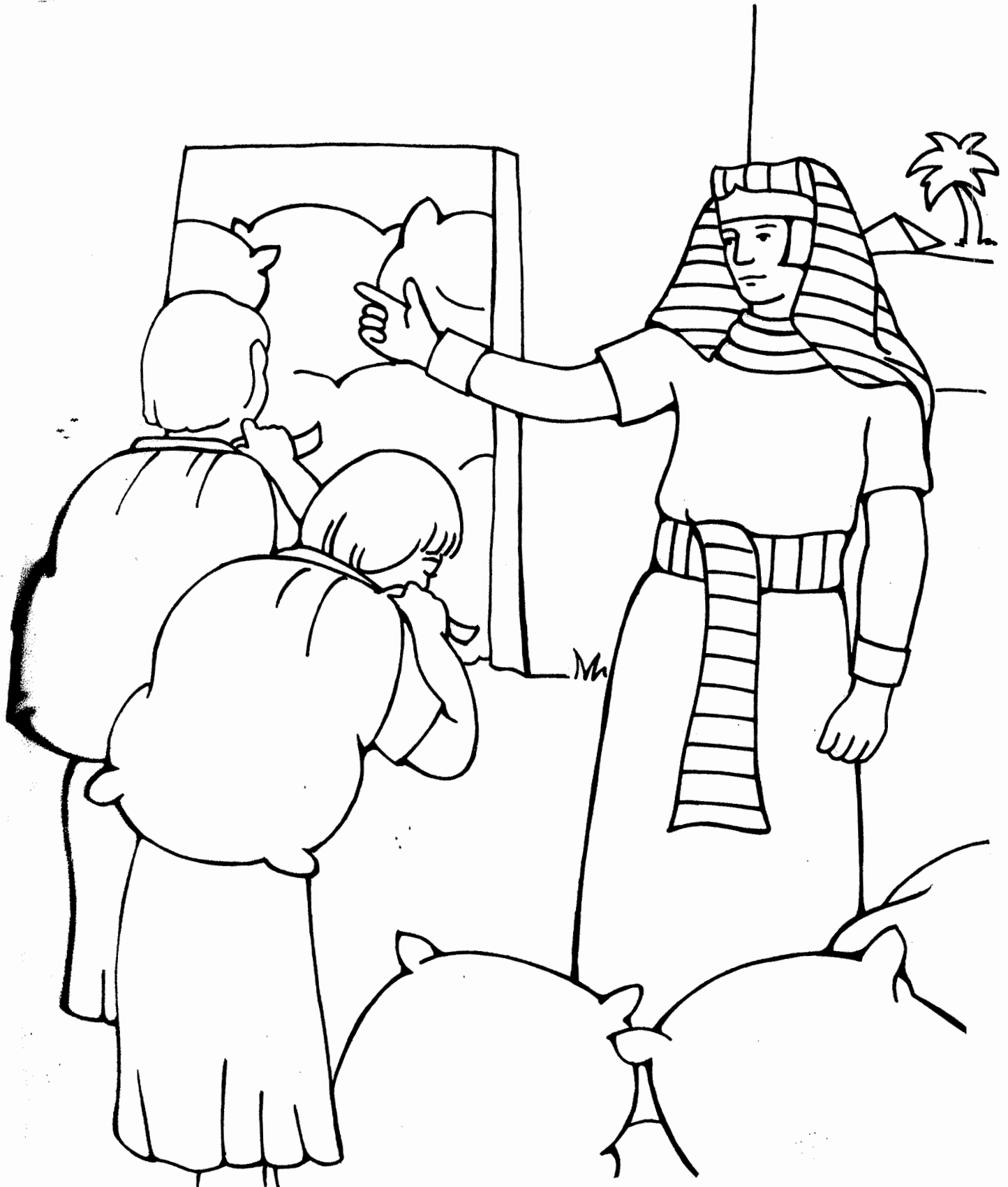



## Lesson 9: God Gives Us Food

### CORN ON THE COB

or use  
popcorn

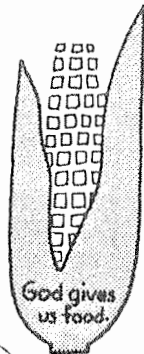

#### Materials:

Construction paper—green and yellow  
White paper  
Glue  
Paintbrush—1" wide  
Felt-tip pen  
Pattern—corn husk (page 37)

#### Directions:

Ahead of time, cut yellow construction paper into 1/2" squares (like mosaic tiles). Cut green husks using the pattern. Print the words *God gives us food* on the husks. Draw a corn-cob shape, about 2" wide and 8" long on the white paper.

Let the children place the yellow squares on the corn-cob shape. The best way to do this is for you to paint glue on the area with a wide paintbrush before the child begins. When the child has placed as many corn kernels as he wants, let him glue the husk over the kernels. You may want to add the Bible words to the craft.

#### Application:

Talk about different foods. Ask the children what their favorite foods are. Say something like, "*I am thankful God made (their favorite foods), aren't you?*"

Use this also as a Thanksgiving craft.

Clear, adhesive-backed plastic  
Felt-tip pen  
Paper punch  
Crayons  
Patterns—boat and sail (pages 37, 38)

#### Directions:

Before the session, cut a boat out of a sponge for each child. Make a small hole in the sponge for the straw to fit into. Cut a sail for each child out of construction paper. Print the words *God gives us water* on one side of each sail. Cover both sides of the sails with the plastic to make the sails waterproof. Punch two holes on the long side of each sail, where indicated. Cut straws to 7" in length.

Let the children decorate their sails with crayons. (The wax will stick to the plastic.) Give each child a straw and help him put it through the holes in the sail. Help him put the straw in the hole in the sponge.



#### Application:

Tell the children they can sail their boats in the bathtub when they take their baths. Their boats will remind them to thank God for giving them water to use and to drink. If you have several large containers in your room, the children will enjoy sailing their boats as a learning activity. This activity requires close supervision, but the children love it. Provide plastic bags for taking the boats home.

This boat can be used with any lesson that has something to do with water or with boats, such as a story on the missionary journeys of Paul.

## Lesson 11: God Gives Us Clothes

## Lesson 10: God Gives Us Water

### BATHTUB BOAT

#### Materials:

Sponges—about 1" thick, 1 per child  
Drinking straws—1 per child  
Construction paper

### PERSONALIZED T-SHIRT

#### Materials:

Construction paper  
Felt or fabric for letters  
Glue  
Felt-tip pen  
Crayons  
Pattern—T-shirt (page 38)

# Food for Thought

Read Genesis 41:38-43, 46-49, 53-57. Then write the food names from each square in the matching line of the acrostic puzzle. When complete, the shaded area will tell about the crisis Joseph warned Pharaoh was coming.

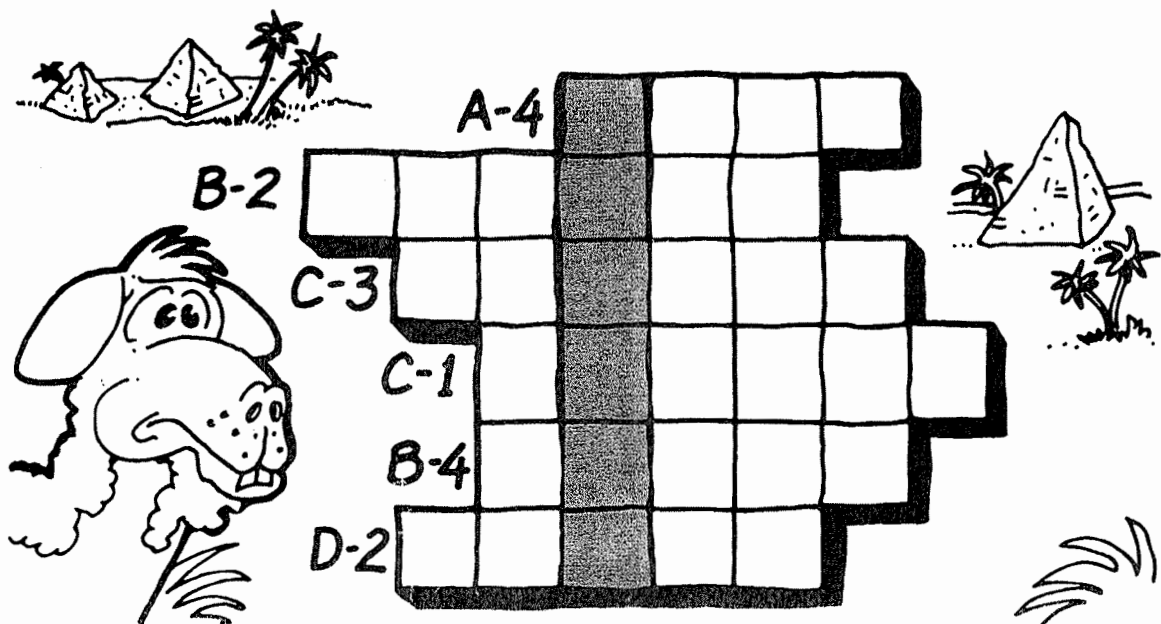
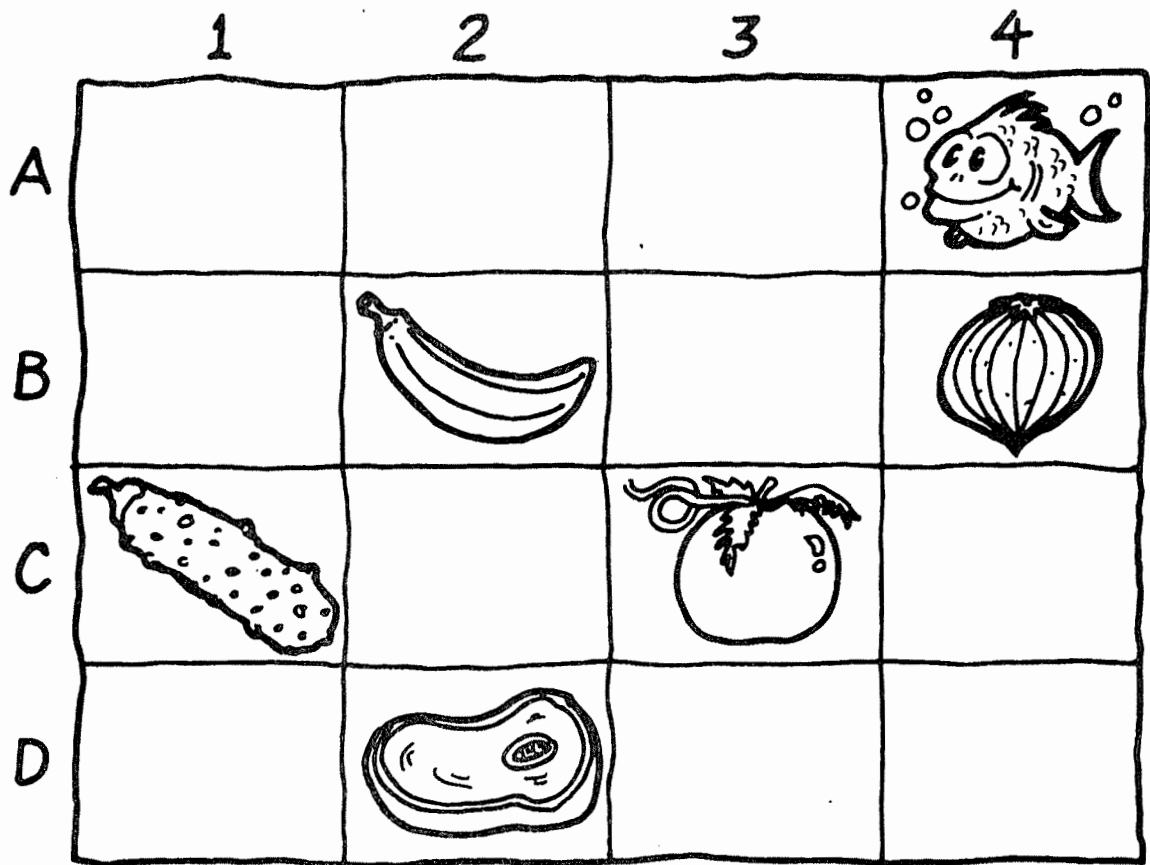

# A NEW JOB FOR JOSEPH

Genesis 41

**Beginning with #1, connect the dots to complete the picture.**

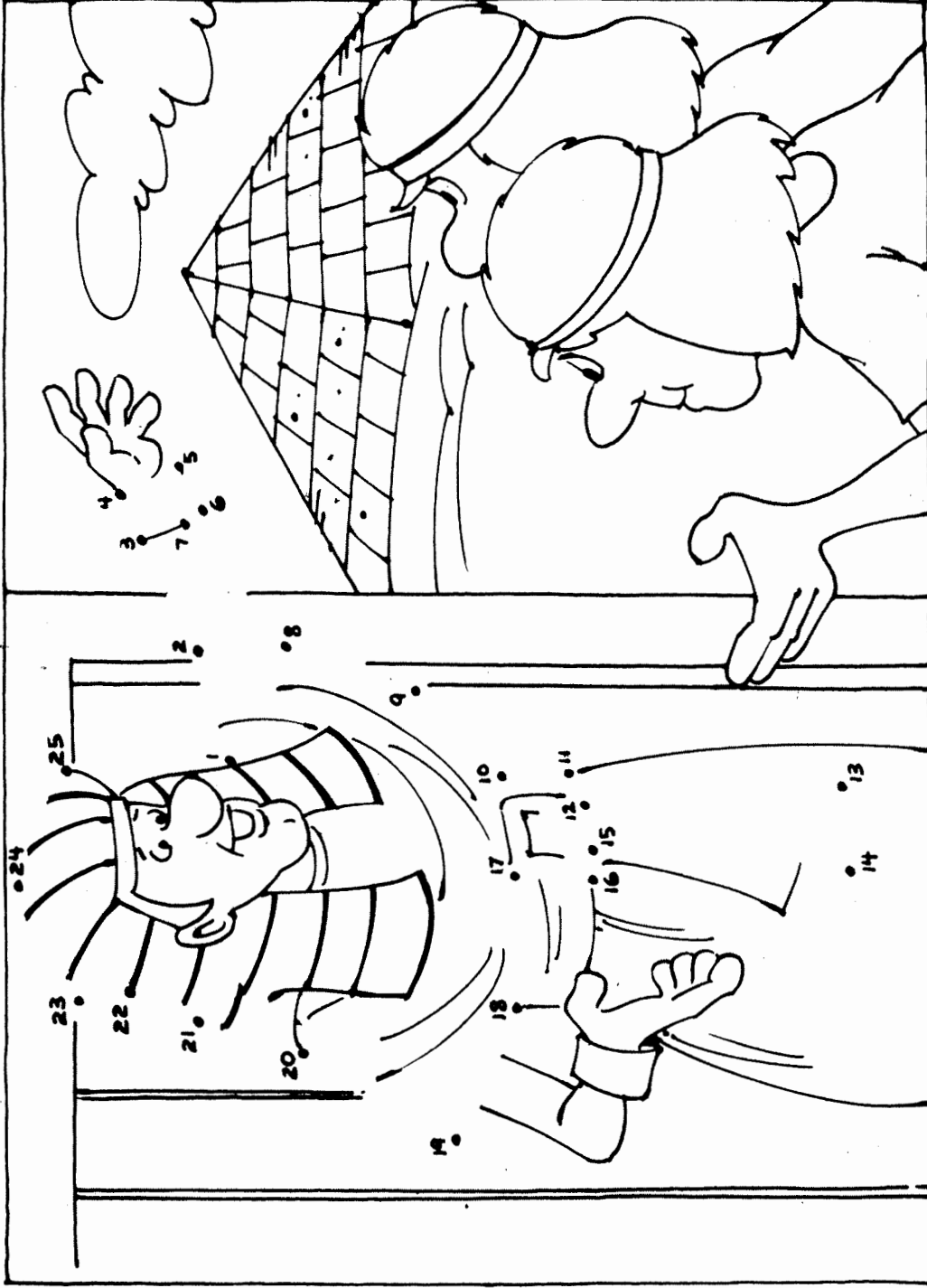

When the pharaoh of Egypt had a dream he didn't understand, God helped Joseph explain it. Pharaoh was so happy

that he released Joseph from prison and made him second-in-command over all of Egypt. Joseph went from being a prisoner to being a very powerful man.

**Joseph  
Forgives  
His Brothers**

—Genesis 41–43, 45

**Be Like  
Joseph**

Joseph's brothers were not nice to him. They sold him to be a slave. They pretended he was dead. Much later, Joseph became a powerful leader in Egypt. When the brothers needed help, they went to Egypt. What did Joseph do?

Use a dark color to fill in all the bricks in the pyramid that have the letters J, S, P, and H. Copy the leftover letters, from top to bottom, onto the spaces below.

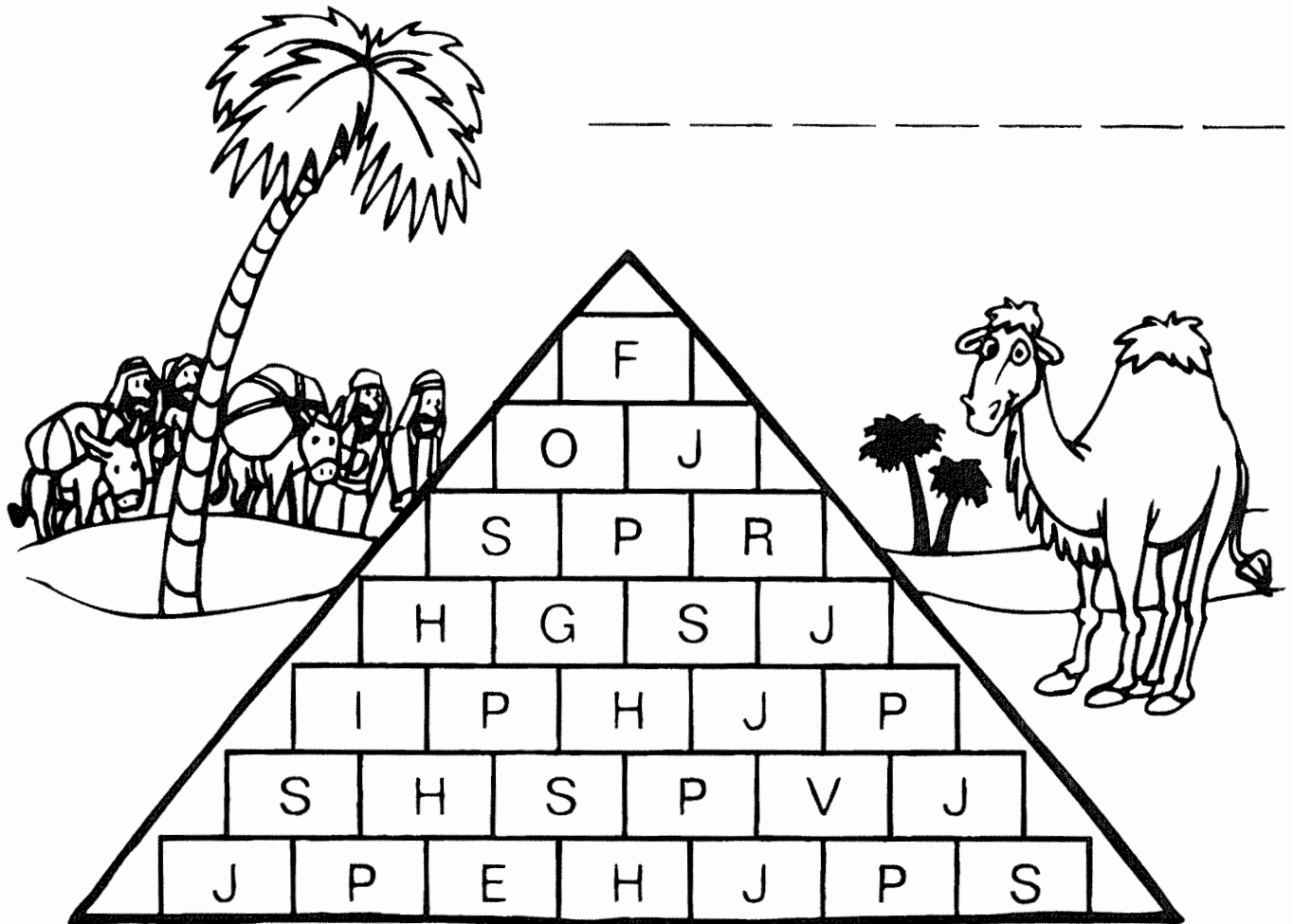

# GENESIS 41

NRGIA

	○			
--	---	--	--	--

DOLT

			○
--	--	--	---

TANRESV

○	○	○		○		
---	---	---	--	---	--	--

INEFAM

	○	○			○
--	---	---	--	--	---

OGD

		○
--	--	---



JOSEPH HELPED THE PHARAOH BECAUSE  
HE COULD:

○	○	○	○
---	---	---	---

HIS

○	○	○	○	○	○
---	---	---	---	---	---



## JOSEPH INTERPRETS THE KING'S DREAMS (Genesis 41:1-36)

Unscramble the following words and use them to complete the sentences below.

GETPY

FICEH OKOC

ILAJ

UPT OT HEDAT

LINE VIRRE

WOSC

ASRSG

NISKNY

SALONERP VANTERS

SMEARD

SHOJEP

NEEVS SAYER

TYPLEN

GIVTRANS

1. Joseph was a slave in \_\_\_\_\_.
2. The \_\_\_\_\_ was thrown in jail with Joseph.
3. Joseph, the king's personal servant, and the chief cook were in \_\_\_\_\_ together.
4. The chief cook was \_\_\_\_\_.
5. The king dreamed he was standing on the bank of the \_\_\_\_\_.
6. The king dreamed about fat \_\_\_\_\_ eating the \_\_\_\_\_.
7. The king also dreamed about \_\_\_\_\_ cows eating the fat ones.
8. The king's \_\_\_\_\_ told the king about Joseph.
9. The king sent for Joseph because he wanted to know what his \_\_\_\_\_ meant.
10. God helped \_\_\_\_\_ to know what the dreams meant.
11. The king's dreams meant that there would be \_\_\_\_\_ of more than enough grain in Egypt, followed by not enough.
12. Joseph told the king there would be seven years of \_\_\_\_\_.
13. Joseph told the king that after that the Egyptian people would be \_\_\_\_\_.



**Year 1**

**Week 27**

## **Joseph's Brothers Visit Egypt**

**Scriptures: Genesis 42**

**Key Verse: Genesis 42:6 Now Joseph was governor over the land; and it was he who sold grain to all the people of the land. And Joseph's brothers came and bowed down before him with their faces to the earth.**

### **Key Points:**

1. The famine was great in the land so Jacob sends his sons to Egypt to buy grain, Benjamin did not go.

2. Joseph was governor of the land so the brothers had to go to him to buy their grain. They bowed down before him, just as was as prophesied in Joseph's dreams.

3. Joseph recognized his brothers, but they did not recognize him. He accused them of being spies and put them in prison 3 days. On the third day, in order to prove they were not spies, Joseph made them go back to their father and bring Benjamin to Egypt when they returned. Simeon had to remain there in prison.

4. Joseph had their sacks filled with grain, also returning their money in their sacks as well. On their journey home, the brothers discovered the money and were fearful of what that might mean.

5. They returned to their father and told him all that had happened. Jacob grieved that Joseph was dead, Simeon was in prison and now they wanted to take Benjamin. Jacob said that they would not return to Egypt, however, their grain did run out.



Year 1, Week 27  
Genesis 42  
Joseph's Brothers Visit in Egypt



**Genesis 42:6**

Now Joseph was governor over the land; and it was he who sold to all the people of the land. And Joseph's brothers came and bowed down before him with their faces to the earth. (NKJV)

“The king put Joseph in charge of all of Egypt”  
(Genesis 41:43).



Joseph



Pharaoh put Joseph in charge of storing food for the years of famine.  
In power, Joseph was second only to Pharaoh.

*Genesis 41:37-45*



Joseph's Best Work  
Genesis 37, 39, 41

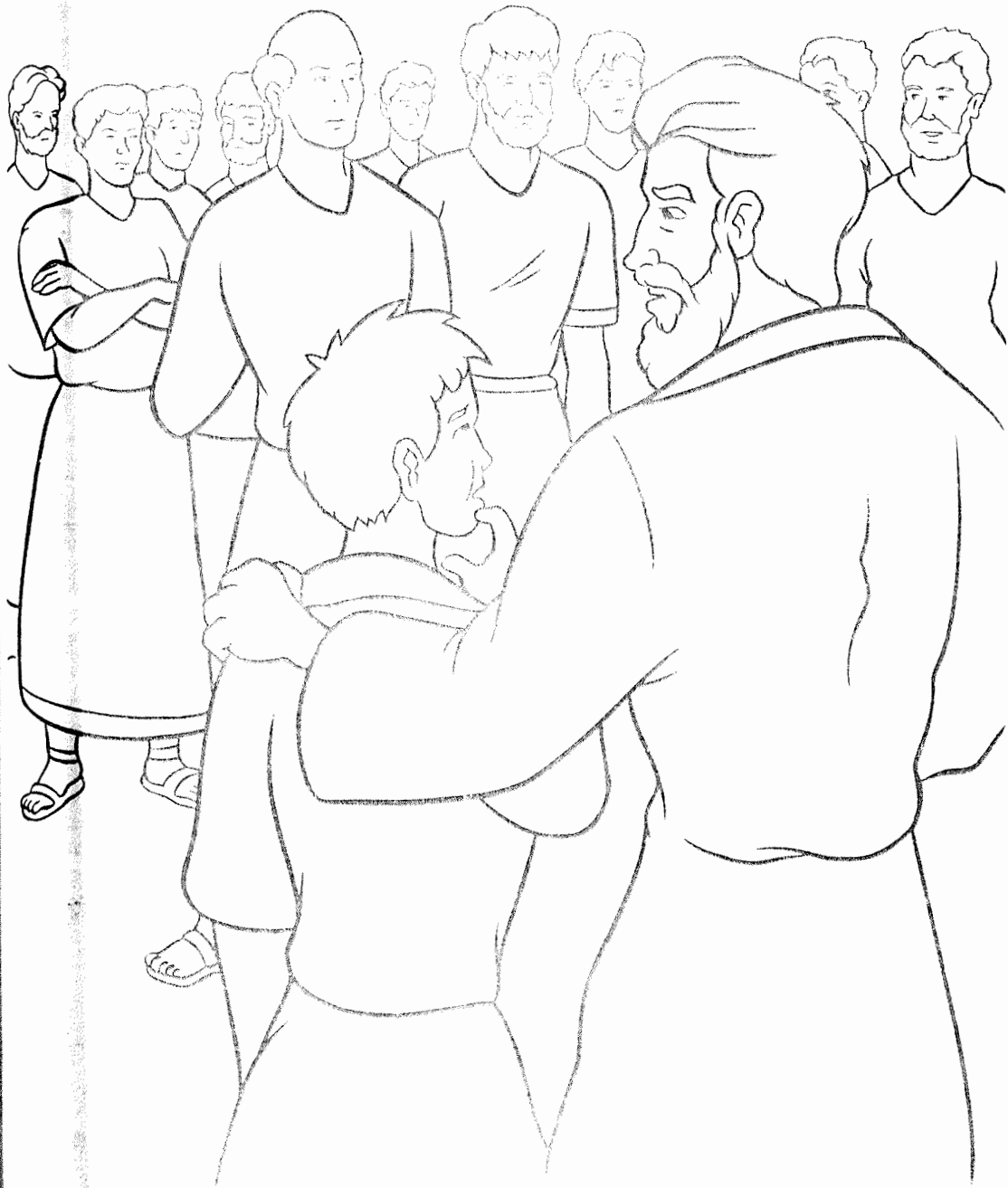

Jacob sent ten of his sons to Egypt to buy grain. He kept his youngest son, Benjamin, home with him.



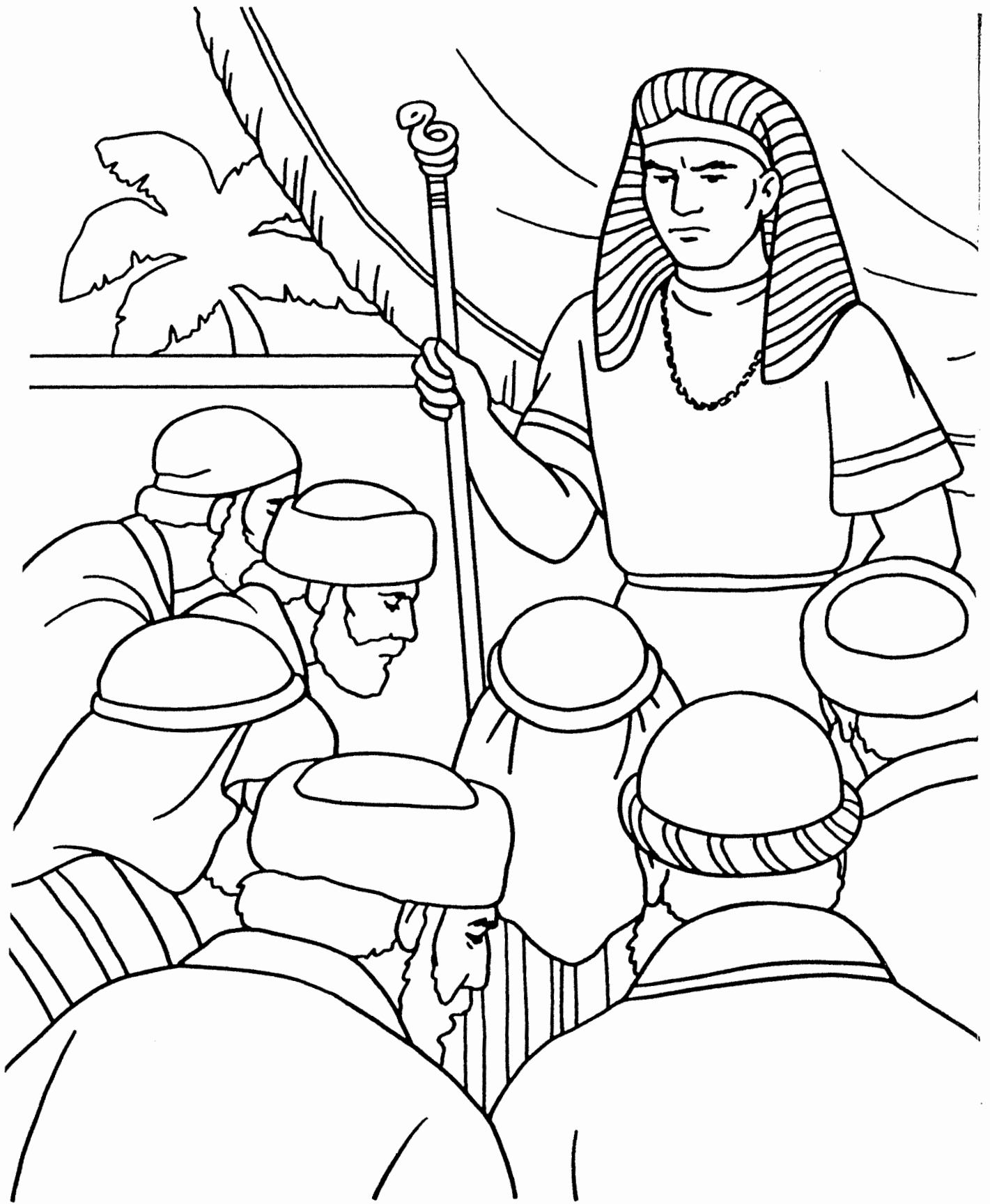

Joseph's older brothers came to Egypt to buy food. They bowed down to Joseph, not knowing who he was.

*Genesis 42:1-6*





# Joseph Is Kind to His Brothers

Genesis 42

## Materials needed:

Construction paper—gray or brown, and contrasting color  
Cardboard or tagboard  
Popcorn (unpopped)  
Felt-tip pen—black  
Silver crayon or foil  
Chenille Wire  
Yarn  
Glue

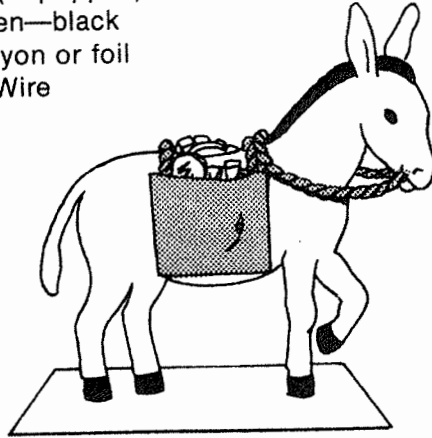

9

## Directions:

Using donkey pattern (page 23), cut two donkeys out of gray or brown construction paper. Draw details with black felt-tip pen. Glue figures together, inserting one 3-inch piece of chenille wire in front and one piece in back legs. Leave 1-inch ends of wire below feet. Cut two bases,  $3\frac{1}{2}$  inches by  $2\frac{1}{2}$  inches. Punch holes to match with feet and insert chenille wire ends in holes, bending wires in opposite directions. Glue other base on bottom, over exposed wires. Cut two saddlebags from contrasting shade of paper. Fold and glue on sides, inserting small pieces of yarn in seams to connect bags. Place saddlebags over donkey's back and add glue beneath yarn. Cut coins from cardboard or tagboard and color with silver crayon, or cover with foil. Put corn and coins in saddlebags. Cut 6 inches of yarn and tie ends together. Cut a slit for donkey's mouth and insert yarn rein.

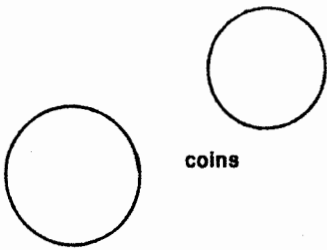
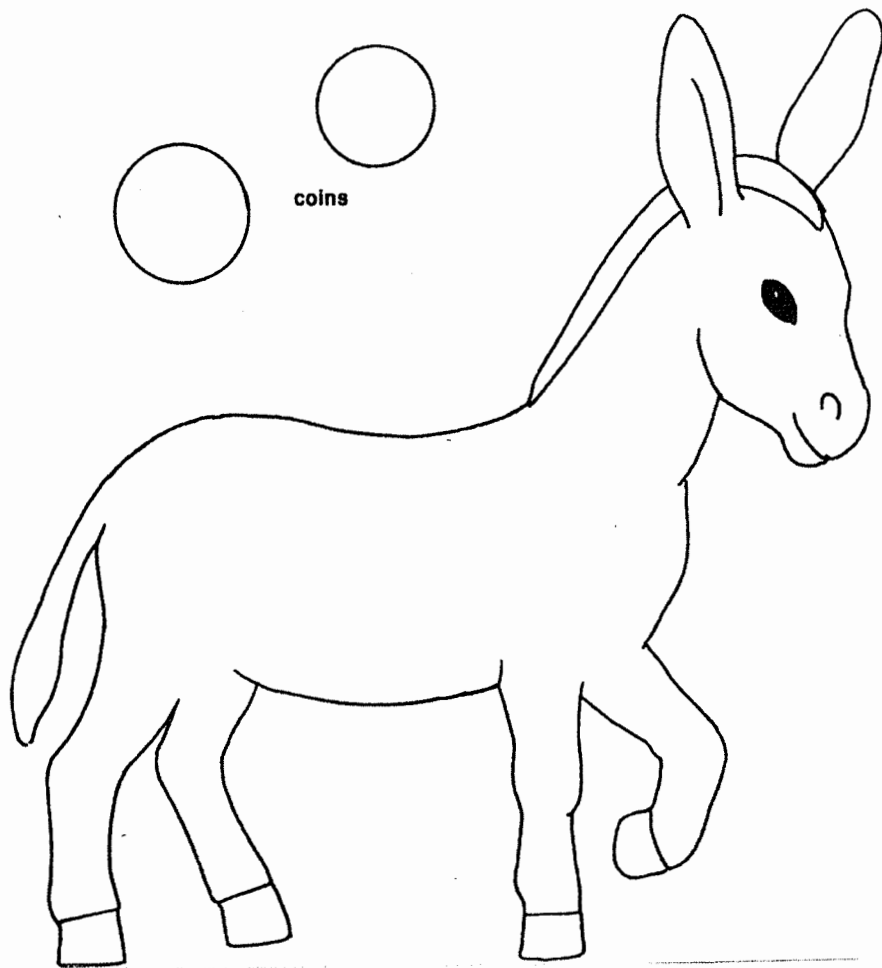

coins

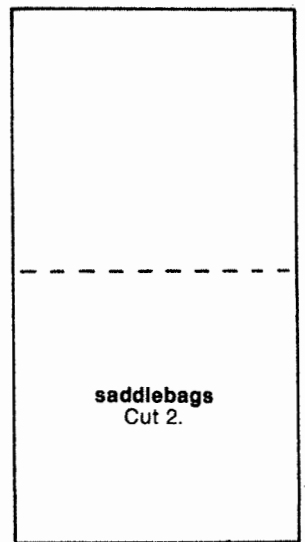

saddlebags  
Cut 2.

# Children of Israel

The twelve sons of Israel became the twelve tribes of Israel. Their names are listed below. All the boxes connect with a box containing the same letter. After you find the names of the twelve sons of Israel, check your work in Genesis 35:23-26.

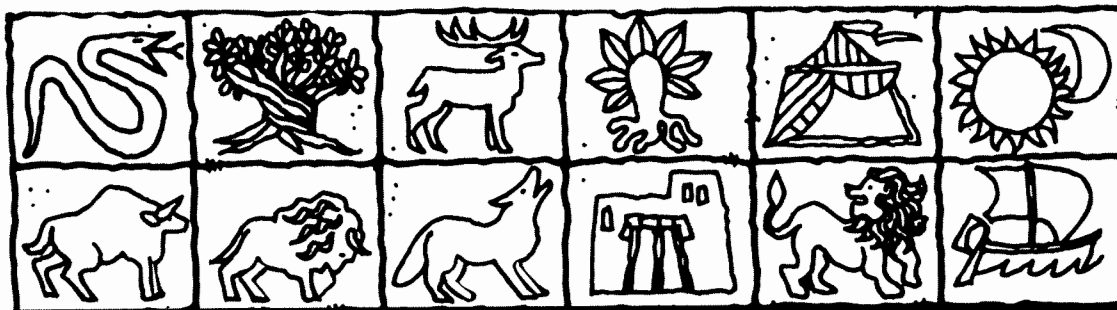
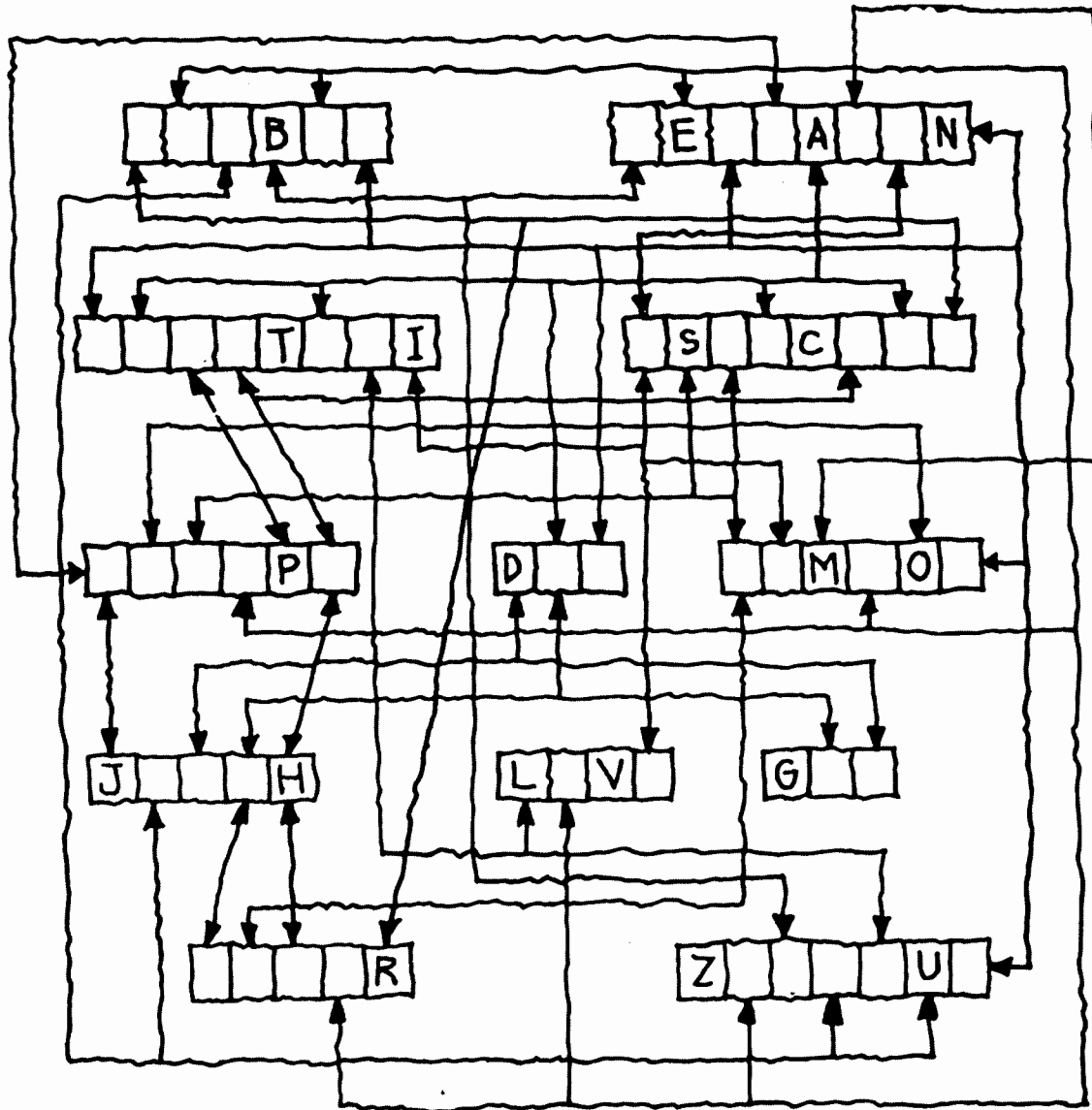

# God Cares for Jacob

—Genesis 28-33

# Jacob's Sons

God blessed Jacob with twelve sons. Can you fit all of their names into the puzzle below? Some letters are already in the puzzle to help you. When you are finished, take the letters from the shaded boxes and put them into the boxes below. These letters will spell the name of Jacob's daughter.

REUBEN  
SIMEON  
LEVI  
NAPHTALI  
ISSACHAR  
ASHER  
DAN  
ZEBULUN  
GAD

BENJAMIN  
JUDAH  
JOSEPH  
and

\_\_\_\_\_

# THE SONS OF JACOB

(GENESIS 29:31-30:24; 35:16-26)

G B K V L H A M C T I H N T A  
S O S J N J I S S A C H A R A  
N N P N O U V Q J N T F H T U  
B H O S A Q L S W D R E H S A  
K S E E V P C U Y R A V I D E  
K P P R M I H Q B A L N U D N  
H S R G D I A T J E B I A Q Q  
O R N H A L S V A Z Z M F P N  
J R O A D D L P T L Z A F U N  
Q V E D Z H O B N E I J T J A  
S N S U Z T Z Q A M Z N Q K Y  
P G L J B Y M J S D N E H S Q  
M D K W N E F I L W K B A M U  
L E V I O A N C P Q O I U J Q  
B P W E W O D T U X B O U T T

ASHER  
BENJAMIN  
DAN  
GAD

ISSACHAR  
JOSEPH  
JUDAH  
LEVI

NAPHTALI  
REUBEN  
SIMEON  
ZEBULUN

# Sons of Jacob

Jacob had twelve sons. Fit their names in the stack-a-word puzzle below.

REUBEN  
SIMEON  
LEVI  
JUDAH  
DAN  
NAPHTALI  
GAD  
ASHER  
ISSACHAR  
ZEBULUN  
JOSEPH  
BENJAMIN

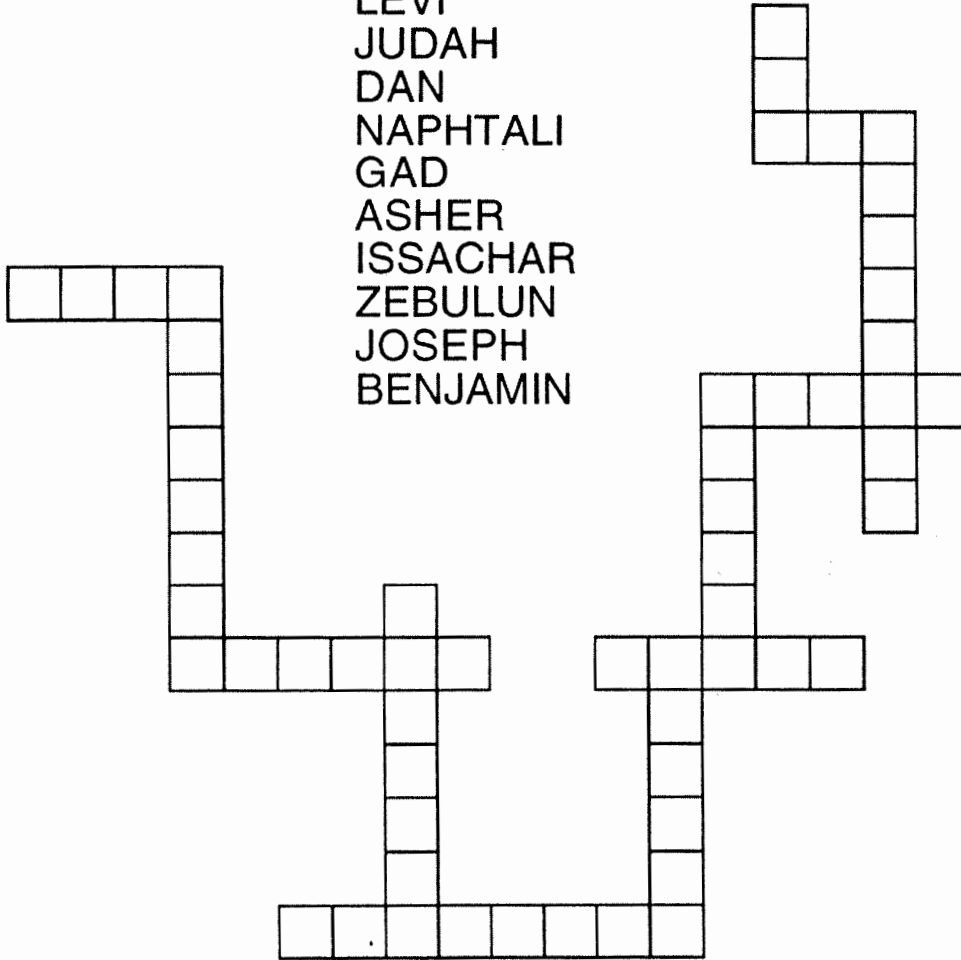

# THE SONS OF JACOB

## (GENESIS 29:31-30:24; 35:16-26)

E M N P I J M H S R O V N L W M S O G S U Z P Q M  
 D W B P L I D I M R J B Y U Q U O U H Q B F Z N P  
 P N K R H C W U N W W G M F N L T I X U N Z F R M  
 U G K X T N Q A D O S R E U B E N I V M H N V P L  
 G K O O Y T A A J P E C A L I S W B S J X D F W C  
 I B J S O C N P T N S M S Y S E I R U Q A K H B S  
 C Y Q L A J X F H K I Z I H V J H W H P E S O J G  
 E K S K V W I F A T A H V S U M J G X L U L N I E  
 U P P W C Y T T A B A K Y X U G I T H J V U E F Y  
 X U M V A J A Q U C G L K O A O S K U N A Y E W U  
 M Y B J L T L H E D H K I I D V S W Q U E E M L W  
 K F B X O N B A N W W A W R D S A I T L I E J J I  
 U K O W Z A Z U Q K A R D F W P C U P U S J Q B A  
 Y T G E M S Z U X I F E L U T T H M L B G A V B C  
 Y G H A F L N B N E U N W Y J W A F J E J V E K L  
 R E S L D P K T E P T C W X L B R O B Z P K V J P  
 F Y S V M U O T A N O V Z D A H D E J T Z U V K A  
 H G R D Q T B D Y I J C O F O J R P H W F O L U I  
 E M V D S N H D Q Y M A A B A Y E K T K B Z A M E  
 L Q N Z Q D F Q U B J C M E P K H J J M X X I X Y  
 M H G Z V R V C Q B K H K I A P S N Y L K A L Y A  
 G V D O P A I I T P G R U H N G A R R U M M R R Q  
 M V P W B Z V U H P H E N T D K U T D G Z Z U T A  
 B G K H Q E O J T Y G M U L Y G O W C C X B U T O  
 P S S Q L E N K T F D Q D U S P L U G V I T C C Y

ASHER  
 BENJAMIN  
 DAN  
 GAD

ISSACHAR  
 JOSEPH  
 JUDAH  
 LEVI

NAPHTALI  
 REUBEN  
 SIMEON  
 ZEBULUN

## Joseph and His Brothers

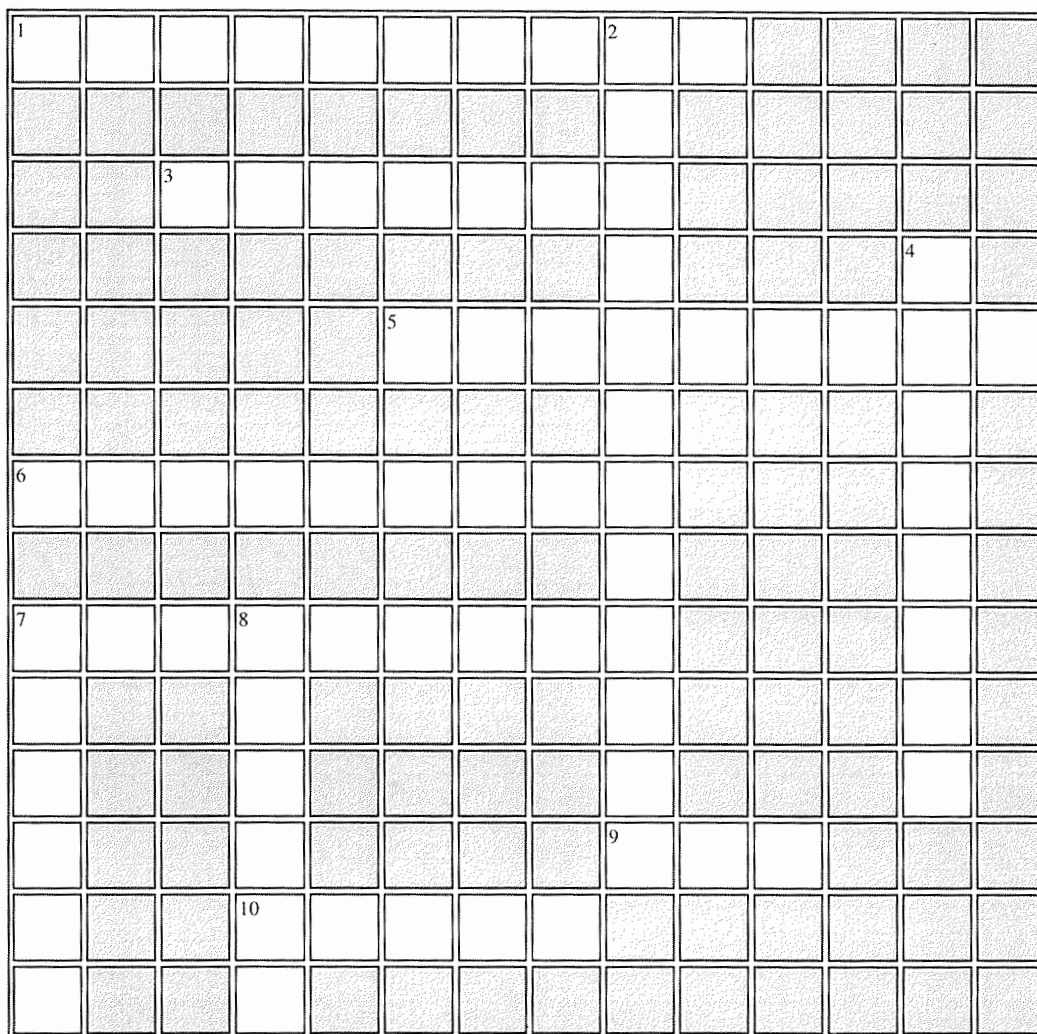

### Across

1. the length of the famine in Egypt
3. a word describing the brothers
5. how Jacob felt when he saw Joseph again
6. what the brothers did when they saw Joseph
7. a word to describe Joseph
9. the number of Joseph's sons
10. the only country that had food

### Down

2. Joseph held this governmental position.
4. Joseph's own brother
7. a time of drought and great need
8. where Joseph's family settled in Egypt

WORD BANK: TWO, FAMINE, EGYPT, RULER IN EGYPT, BOWED DOWN, BENJAMIN, FORGIVING, FEARFUL, OVERJOYED, SEVEN YEARS, GOSHEN



# Joseph and His Brothers

<http://gardenofpraise.com/bibl6s.htm>

D U S G Q E J R N Y P S  
I D E N B E N E U H R K  
A J R I R R H I A L C A  
R X V V D S O R M O E G  
F E A I O E A T T A R R  
A G N G L O W S H A F K  
D Y T R H G E O I E J B  
E P S O M V O N B X R J  
V T C F I H P E S O J S  
O B T L B E N J A M I N  
M F Q P L E N T Y T B G  
O B O C A J H A P P Y U

AFRAID  
BROTHERS  
FORGIVING  
HAPPY  
LIVESTOCK  
PLENTY

BENJAMIN  
EGYPT  
GOSHEN  
JACOB  
MOVED  
RULER

BOWED  
FAMINE  
GRAIN  
JOSEPH  
PHARAOH  
SERVANTS

# JOSEPH TESTS HIS BROTHERS

## (GENESIS 42:1-44:34)

### MEMORY VERSE:

"For nothing is secret that will not be revealed, nor anything hidden that will not be known and come to light." LUKE 8:17

### CIRCLE THE CORRECT WORDS:

1. "Joseph's ten brothers went down to buy (**HORSES, GRAIN**) in Egypt. But Jacob did not send Joseph's brother (**BENJAMIN, ISAIAH**) with his brothers, for he said, 'Lest some calamity befall him.'" **GENESIS 42:3-4**
2. "Now Joseph was governor over the land; and it was he who (**SOLD, TALKED**) to all the people of the land. And Joseph's brothers came and bowed down before him with their faces to the (**EARTH, SKY**)." **GENESIS 42:6**

### TRUE OR FALSE:

3. So Joseph recognized his brothers, and they recognized Joseph too. **GENESIS 42:8**  
**TRUE OR FALSE**

### FILL IN THE BLANKS:

4. Joseph said, "You are \_\_\_\_\_! In this manner you shall be \_\_\_\_\_: By the life of Pharaoh, you shall not leave this place unless your youngest brother comes here. Send one of you, and let him bring your brother; and you shall be kept in \_\_\_\_\_, that your words might be tested to see whether there is any truth in you; or else, by the life of Pharaoh, surely you are spies!" **GENESIS 42:14-16**

### CIRCLE THE CORRECT WORDS:

5. "Then Joseph gave a command to fill their sacks with (**MUD, GRAIN**), to restore every man's money to his sack, and to give them provisions for the journey." **GENESIS 42:25**
6. "And it came to pass, when they had eaten up the grain which they had brought from (**JERUSALEM, EGYPT**), that their father said to them, 'Go back, buy us a little food.'" **GENESIS 43:2**

### TRUE OR FALSE:

7. "So the men took that present and Benjamin, and they took double money in their hand, and arose and went down to Egypt; and they stood before Joseph." **GENESIS 43:15**  
**TRUE OR FALSE**

### CIRCLE THE CORRECT WORDS:

8. "Now the men were (**EXCITED, AFRAID**) because they were brought into Joseph's house; and they said, 'It is because of the money, which was returned in our sacks the first time, that we are brought in, so that he may seek an occasion against us and fall upon us, to take us as (**SLAVES, PRINCES**) with our donkeys.'" **GENESIS 43:18**
9. As the brothers were heading home, Joseph commanded, 'Put my cup, the (**SILVER, GOLD**) cup, in the mouth of the sack of the youngest, and his grain money.'" **GENESIS 44:2**
10. Now the cup was found in the sack of Benjamin, and as the brothers again stood before Joseph, "Judah said, 'What shall we say to my lord? What shall we speak? Or how shall we clear ourselves? (**GOD, PHARAOH**) has found out the iniquity of your servants; here we are, my lord's slaves, both we and he also with whom the cup was found.'" **GENESIS 44:16**

# JOSEPH TESTS HIS BROTHERS

## (GENESIS 42:1-44:34)

### MEMORY VERSE:

"For nothing is secret that will not be revealed, nor anything hidden that will not be known and come to light." LUKE 8:17

### FILL IN THE BLANKS:

1. "Joseph's ten brothers went down to buy \_\_\_\_\_ in Egypt. But Jacob did not send Joseph's brother \_\_\_\_\_ with his brothers, for he said, 'Lest some calamity befall him.'" **GENESIS 42:3-4**
2. "Now Joseph was governor over the land; and it was he who \_\_\_\_\_ to all the people of the land. And Joseph's brothers came and \_\_\_\_\_ down before him with their faces to the earth." **GENESIS 42:6**

### TRUE OR FALSE:

3. So Joseph recognized his brothers, and they recognized Joseph too. **GENESIS 42:8**

TRUE OR FALSE

### FILL IN THE BLANKS:

4. Joseph said, "You are \_\_\_\_\_! In this manner you shall be \_\_\_\_\_: By the life of Pharaoh, you shall not leave this place unless your youngest brother comes here. Send one of you, and let him bring your brother; and you shall be kept in prison that your words might be tested to see whether there is any truth in you; or else, by the life of Pharaoh, surely you are spies!" **GENESIS 42:14-16**
5. "Then Joseph gave a \_\_\_\_\_ to fill their sacks with grain, to restore every man's money to his sack, and to give them provisions for the journey." **GENESIS 42:25**

### CIRCLE THE CORRECT WORD:

6. "And it came to pass, when they had eaten up the grain which they had brought from (JERUSALEM, EGYPT), that their father said to them, 'Go back, buy us a little food.'" **GENESIS 43:2**

### TRUE OR FALSE:

7. "So the men took that present and Benjamin, and they took double money in their hand, and arose and went down to Egypt; and they stood before Joseph." **GENESIS 43:15**

TRUE OR FALSE

### FILL IN THE BLANKS:

8. "Now the men were \_\_\_\_\_ because they were brought into Joseph's house; and they said, 'It is because of the money, which was returned in our sacks the first time, that we are brought in, so that he may seek an occasion against us and fall upon us, to take us as \_\_\_\_\_ with our donkeys.'" **GENESIS 43:18**
9. As the brothers were heading home, Joseph commanded, 'Put my cup, the \_\_\_\_\_ cup, in the mouth of the sack of the youngest, and his grain money.'" **GENESIS 44:2**

### CIRCLE THE CORRECT WORD:

10. Now the cup was found in the sack of Benjamin, and as the brothers again stood before Joseph, "Judah said, 'What shall we say to my lord? What shall we speak? Or how shall we clear ourselves? (GOD, PHARAOH) has found out the iniquity of your servants; here we are, my lord's slaves, both we and he also with whom the cup was found.'" **GENESIS 44:16**

# JOSEPH TESTS HIS BROTHERS

(GENESIS 42:1-44:34)

D K V P U C R E V L I S E T P E W T Z K  
A G E E B S H W T E Q B U U D X Y Q Z I  
M C Y O J K R Z B N N P R E Y D L T E Z  
D B W Z O Z Y E H C U I T L C M C I T U  
I E B H M M J F H L R S M M Z M O B Q W  
D B G R F J A O G T E F B A A M Y A H A  
R V R O S A L J A T O A M O F X Y C D T  
G K A N P P C L G C B R B E N J A M I N  
K G I R I N Q N O C L B B T J O C D D C  
F V N E E E Y A D T Y E K J P R Y N S O  
Q E P V S P V Y A L F G N B T R D V F B  
N A B O O N F O L W B G X H L P I B N U  
I B N G N U D P M S O H H Z T H Y S V M  
S Y E K N O D M I I W S O R R O W G O P  
R Y Y F V U Q E G M M B A J A P W C E N  
C A N A A N D A H E C M E R C Y S V W A  
J Z Q M E K I Q T O W Y G L E N A C T J  
B O C A J C D T Y N A X K L H P E S O J  
L R Q C H A B S K R V A Y E N O M A J Y  
D Q F G C S V C E S W P S B L T B W R K

**BENJAMIN**

**FAMINE**

**MERCY**

**SIMEON**

**BOWED**

**GOD ALMIGHTY**

**MONEY**

**SORROW**

**BROTHERS**

**GOVERNOR**

**PRISON**

**SPIES**

**CANAAN**

**GRAIN**

**SACK**

**TESTED**

**DONKEYS**

**JACOB**

**SILVER CUP**

**WEPT**

**EGYPT**

**JOSEPH**

# JOSEPH TESTS HIS BROTHERS

## (GENESIS 42:1-44:34)

O V M T V S P A H W F A B F J U Z Z L T A A G P S A H X L T  
 J J F N I M N G K W B D P O B G S S R C Q L A L L K C I J I  
 Q X M D O J K W K Z E Y S E J C I A U M A U K Y P R O V V L  
 S W Q R B T B A R H S S O G O V E R N O R E R M H V V M R E  
 P E S O N A G F E O P M T P H V F M U P O D B T L Z N T R I  
 M L C H H A C O R O H E W K T U A Z C M Y K N F Q Y J Q K A  
 B A Q A A U D R D A T U S J J B M B Q L N I A R G E L V J K  
 J V V Z I D O U N A L X I O Y N I T N C E L Y H D E W O B Q  
 B D P E U W U T C K L S H F J H N P R S A S Y E K N O D S Y  
 O D B M A E W J V U U M J Y R L E Z U G E C N D U H D U F R  
 H Z Q D F N K O C N W E I T D A Z F N E B M M R I Z R G Q P  
 S Z J W F Q I M C U Q J D G C N F V B Y E N Q S C C Z B V T  
 S O W E P T E J H D N M U W H V Z F I U N Q N R C S N D X P  
 R W I Q T E G Y P T I G O U G T P H F W J A P E M G L O R K  
 V H C X Q X P Y R L S O L G S A N N W I A R L H R I A N B Z  
 N Q T I H N I C E U V V O H Q E D E L N M U J T X F E Z I O  
 G I T T A A Y R S F U S U N U I K E A A I M D O G L M F U V  
 D L C E U Y B E M I U P I V M S X C J C N E D R B B X N Q L  
 P H J A S Q B M Q L L T I S J G U M B L Q S R B I K Z X H C  
 K T W L U T P K N Y A V B U Q J Y J B P U Z M S V M U A C Y  
 S Y Y B T U E G Y H D W E N O S I R P N T P J M S I I D C Y  
 P O J Z T Q P D M X D B R R L P E Q K O V J L C M U J P N P  
 P A T Z D T Y H A O W H W X C Z E V J E S H P U K X L U U D  
 R V N N D H F G S I T J G H J U J S M M E D O R I W M K K D  
 X C A K Q T O D K R L Y T U T F P E U I T C L S R V P I S A  
 O A S O C T J V V C A K K Q W I A V M S K U T J K K V V U W  
 S L L B U R W B Y F A P W T E B V V M A N U P L Q G E R N Z  
 L M O N E Y S G K H O S I S K L K L Y I B S N P Y P C Q E C  
 K O P H J R S C W L A G U P M K U A R E Y Y R B C H H I S P  
 W Z N F H W I Z L D P K M L L M O I T Y Z J A N Z K M J X Y

<b>BENJAMIN</b>	<b>FAMINE</b>	<b>JUDAH</b>	<b>SIMEON</b>
<b>BOWED</b>	<b>GOD ALMIGHTY</b>	<b>MERCY</b>	<b>SORROW</b>
<b>BROTHERS</b>	<b>GOVERNOR</b>	<b>MONEY</b>	<b>SPIES</b>
<b>CANAAN</b>	<b>GRAIN</b>	<b>PRISON</b>	<b>TESTED</b>
<b>DONKEYS</b>	<b>JACOB</b>	<b>SACK</b>	<b>WEPT</b>
<b>EGYPT</b>	<b>JOSEPH</b>	<b>SILVER CUP</b>	

# JOSEPH TESTS HIS BROTHERS

## (GENESIS 42:1-44:34)

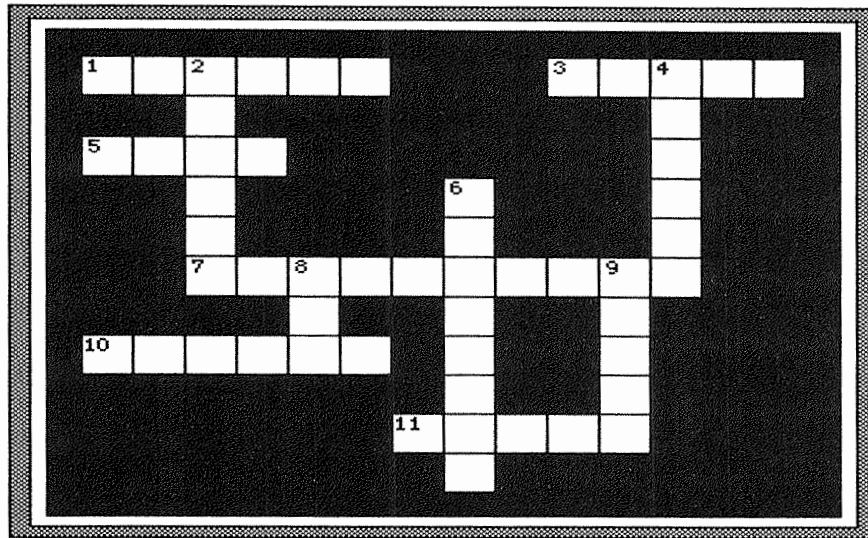

- 11 ACROSS "For nothing is secret that will not be revealed, nor anything hidden that will not be known and come to \_\_\_\_\_." **LUKE 8:17**
- 6 DOWN "Joseph's ten brothers went down to buy grain in Egypt. But Jacob did not send Joseph's brother \_\_\_\_\_ with his brothers, for he said, 'Lest some calamity befall him.'" **GENESIS 42:3-4**
- 5 ACROSS "Now Joseph was governor over the land; and it was he who \_\_\_\_\_ to all the people of the land. And Joseph's brothers came and bowed down before him with their faces to the earth." **GENESIS 42:6**
- 7 ACROSS "So Joseph \_\_\_\_\_ his brothers, but they did not recognize him." **GENESIS 42:8**
- 1 ACROSS Joseph said, "You are spies! In this manner you shall be \_\_\_\_\_: By the life of Pharaoh, you shall not leave this place unless your youngest brother comes here." **GENESIS 42:14-15**
- 3 ACROSS "Then Joseph gave a command to fill their sacks with \_\_\_\_\_ to restore every man's money to his sack, and to give them provisions for the journey." **GENESIS 42:25**
- 9 DOWN "And it came to pass, when they had eaten up the grain which they had brought from \_\_\_\_\_ that their father said to them, 'Go back, buy us a little food.'" **GENESIS 43:2**
- 10 ACROSS "So the men took that present and Benjamin, and they took double money in their hand, and arose and went down to Egypt; and they stood before \_\_\_\_\_." **GENESIS 43:15**
- 4 DOWN "Now the men were \_\_\_\_\_ because they were brought into Joseph's house; and they said, 'It is because of the money, which was returned in our sacks the first time, that we are brought in, so that he may seek an occasion against us and fall upon us, to take us as slaves with our donkeys.'" **GENESIS 43:18**
- 2 DOWN As the brothers were heading home, Joseph commanded, 'Put my cup, the \_\_\_\_\_ cup, in the mouth of the sack of the youngest, and his grain money.'" **GENESIS 44:2**
- 8 DOWN Now the cup was found in the sack of Benjamin, and as the brothers again stood before Joseph, "Judah said, 'What shall we say to my lord? What shall we speak? Or how shall we clear ourselves? God has found out the iniquity of your servants; here we are, my lord's slaves, both we and he also with whom the \_\_\_\_\_ was found.'" **GENESIS 44:16**

# Joseph in Egypt

Genesis 39-41 (NIV)

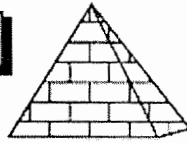
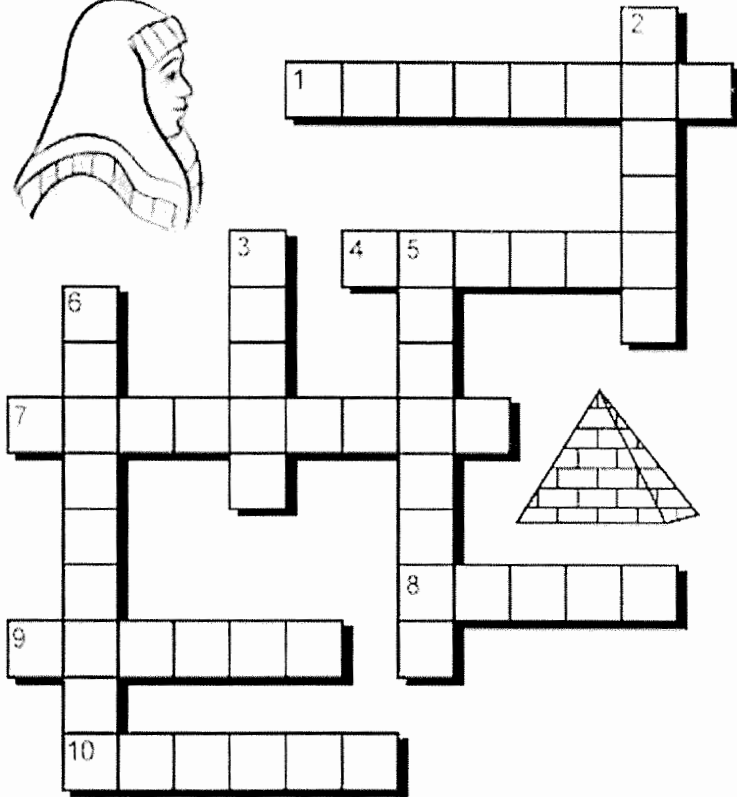

Down:

2. Joseph told Pharaoh that there would be seven years of abundance followed by seven years of \_\_\_\_\_. (41:29,30)

3. Joseph told the cupbearer and the \_\_\_\_\_ what their dreams meant. (40:9-22)

5. Joseph said to Pharaoh " God has \_\_\_\_\_ what he is about to do" (41:25)

6. Potiphar put Joseph in Charge of his \_\_\_\_\_. (39:4)

Across:

1. Potiphar's wife lied about Joseph and \_\_\_\_\_ had him put in prison. (39:4 & 20)

4. The Warden put Joseph in charge of all those in \_\_\_\_\_. (39:22)

7. The \_\_\_\_\_ and the baker of the king of Egypt, who were being held in prison — had a dream the same night. (40:5)

8. Pharaoh put Joseph in Charge of the whole land. of \_\_\_\_\_. (41:43)

9. The Lord was with \_\_\_\_\_ and gave him success in whatever he did. (39:23)

10. Pharaoh had two \_\_\_\_\_. (41:1)



# Joseph and His Brothers

Genesis 37 (NIV)

Jacob, whose name was changed to Israel, had twelve sons. He showed special favor to Joseph who was one of his youngest sons.

Read about Joseph and what happened to him in Genesis 37.

Unscramble the word to fill in the blanks.

RILSEA

\_\_\_\_\_ loved Joseph more than any of his other sons.  
(verse 3)

OREB

Israel . . . made a richly ornamented \_\_\_\_\_ for him. (verse 3)

TEHDA

When his brothers saw that their father loved Joseph more than any of them they \_\_\_\_\_ him. (verse 3)

REDMARE

Joseph's brothers called him a \_\_\_\_\_. (verse 19)

LFCSKO

Joseph's brothers had gone to graze their father's \_\_\_\_\_ near Shechem.  
(verse 12)

UBRENE

\_\_\_\_\_ tried to rescue Joseph from his brothers. (verse 21,22)

ICSETRN

Joseph's brothers threw him into a \_\_\_\_\_. (verse 24)

ISLEVR

Joseph's brothers sold him to Midianite merchants for 20 shekels of \_\_\_\_\_. (verse 28)

GEPTY

The Midianites sold Joseph in \_\_\_\_\_ to Potiphar. (verse 36)



# 41

## Joseph Quiz

OBJECTIVE: Interesting facts about one of God's heroes

*Appropriate for age 9 to teens*

These intriguing questions about Joseph will get your students hunting the Scriptures. All the answers can be found in Genesis chapters 37-50. Ask your students the questions, and allow them to search in these chapters for the answers.

These questions can also be used with the many Bible drills and quizzes in this book.

### Joseph Quiz Questions:

1. Who was Jacob's favorite son? Joseph.
2. Why was he the favorite of Jacob? He was the son of Jacob's old age.
3. Who was Joseph's grandfather? Isaac. Who was his great-grandfather? Abraham.
4. How many brothers did Joseph have? How many sisters? 11 brothers and one sister.
5. Why were his brothers jealous of Joseph? They disliked the favor their father paid him.
6. What was the main idea of Joseph's dream? That someday Joseph's brothers would bow down to him.
7. What did the brothers plan to do with Joseph when he came to visit them in the fields? At first they planned to kill him, but Reuben protested; so they put him in a pit. Then they decided to sell him.
8. What did the boys tell their father? They dipped Joseph's coat in a kid's blood, showed it to Jacob, and asked him to identify it. Jacob thought a wild animal had killed Joseph.
9. Where was Joseph taken? Egypt.
10. Who purchased him? Potiphar, an officer of the Pharaoh.
11. Did Potiphar trust Joseph? Yes.
12. Why was Joseph cast into prison? Potiphar's wife said false things about him and convinced her husband they were true.
13. Two men had dreams that Joseph interpreted. Who were they? Butler and baker.
14. How long did Joseph remain in prison? Two years.
15. The Pharaoh had dreams which Joseph interpreted. What did they mean? They meant that there would be seven fat years and seven lean years.
16. What did Joseph tell Pharaoh he must do after Joseph interpreted the dreams? He must store up food for seven years until the years of famine. If he did this there would be enough food.
17. Who did Pharaoh set up as the leader in collecting the grain? Joseph.
18. Who came to buy food in Egypt? Joseph's brothers.
19. What did Joseph do when he recognized them, but they did not recognize him? At first he treated them harshly, and at last he told them who he was.
20. What did Joseph insist his brothers do? Bring Benjamin to Egypt.
21. Did Joseph ever see his father again? Yes, he was finally reunited with him and Isaac lived to see Joseph's sons.



**Year 1**

**Week 28**

## **Jacob's Sons Second Journey to Egypt**

**Scriptures: Genesis 43**

**Key Verse: Genesis 43:2 And it came to pass that when they had eaten up the grain which they had brought from Egypt that their father said to them, "Go back and buy us a little food."**

**Key Points:**

1. The famine was severe in the land and Jacob's family ran out of grain. They had to return to Egypt to buy food. That meant that they would have to take Benjamin back with them when they returned. This was very difficult for Jacob but he decided to let them go, praying that God would show them mercy and return his sons to him.

2. As they returned to Egypt, they took double their money to replace the money that was placed in their sacks. They also took fruits of the land as gifts.

3. Joseph made ready a meal for them. The brothers were fearful but explained that they had come again to buy food. They were invited in and again bowed down to Joseph (prophecy fulfilled again).

4. Joseph asked about their father but when he saw Benjamin he was overtaken with emotion and had to leave the room to weep.

5. When the meal was ready sat them at the table according to their birthright. The brothers were astonished by this. Benjamin's serving was 5 times larger than the others.

**This would be a good time to review sons of Jacob for memory work. Song for sons of Jacob on next page.**

Year 1, Week 28  
Genesis 43  
Jacob's Sons Second Journey to Egypt

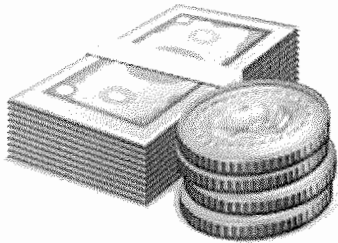

**Genesis 43:2**

And it came to pass, when they had eaten up the grain which they had brought from Egypt, that their father said to them, "Go back, buy us a little food."  
(NKJV)

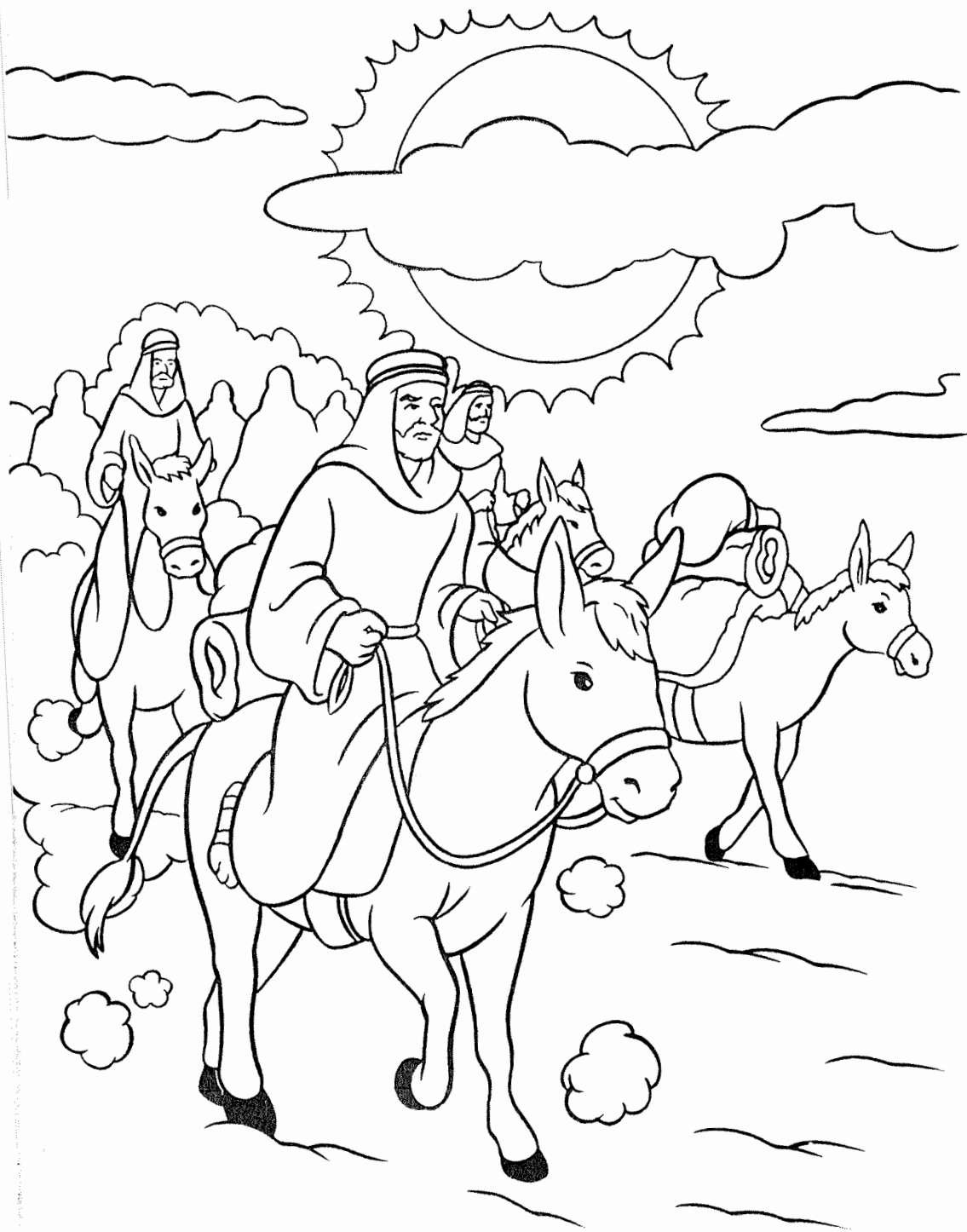

This time they took Benjamin with them.

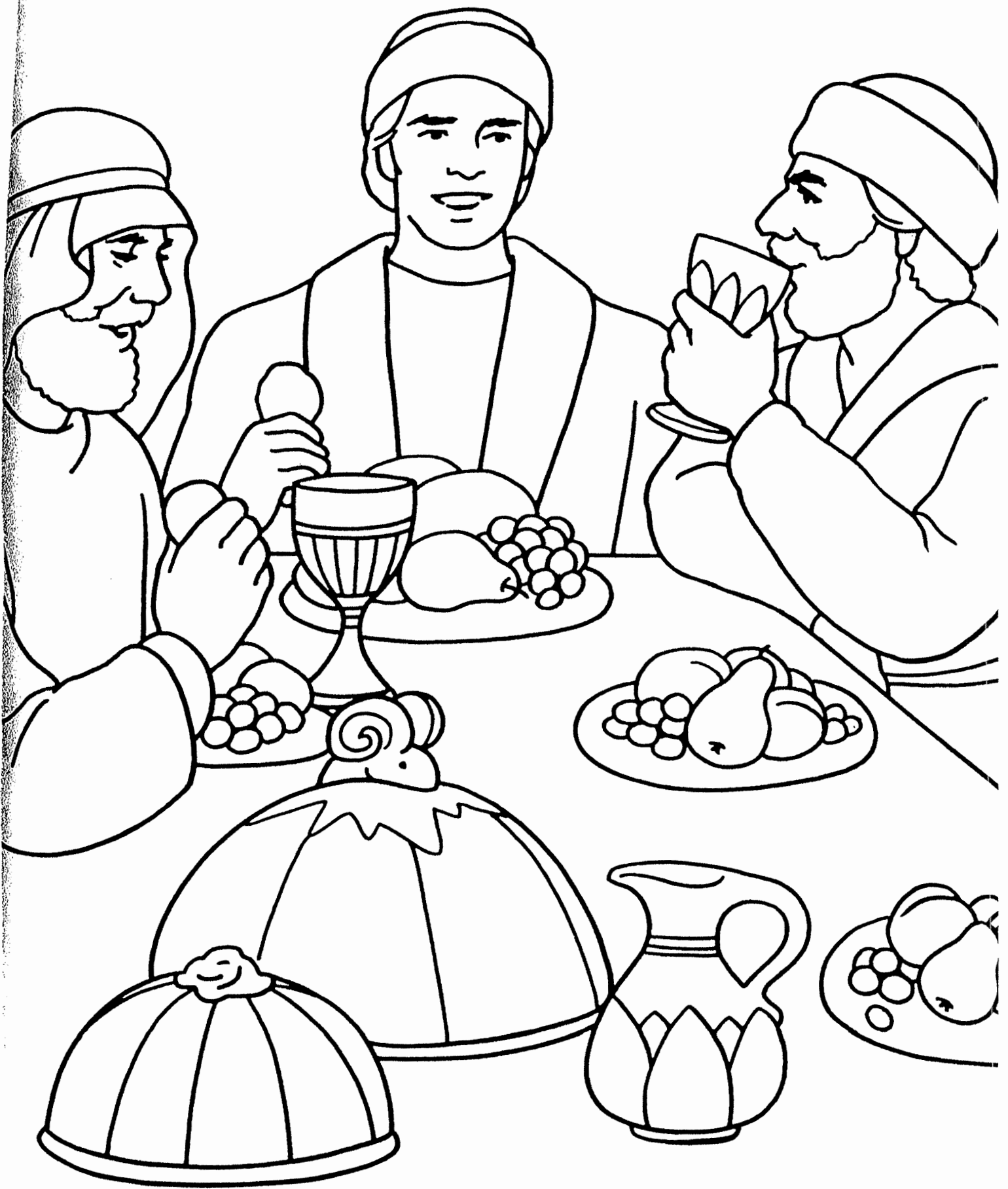

The second time they came, Joseph gave his brothers a feast. He gave his younger brother, Benjamin, more than all the rest. *Genesis 43:26-34*

"Peace be to you, fear not."  
(Genesis 43:23)

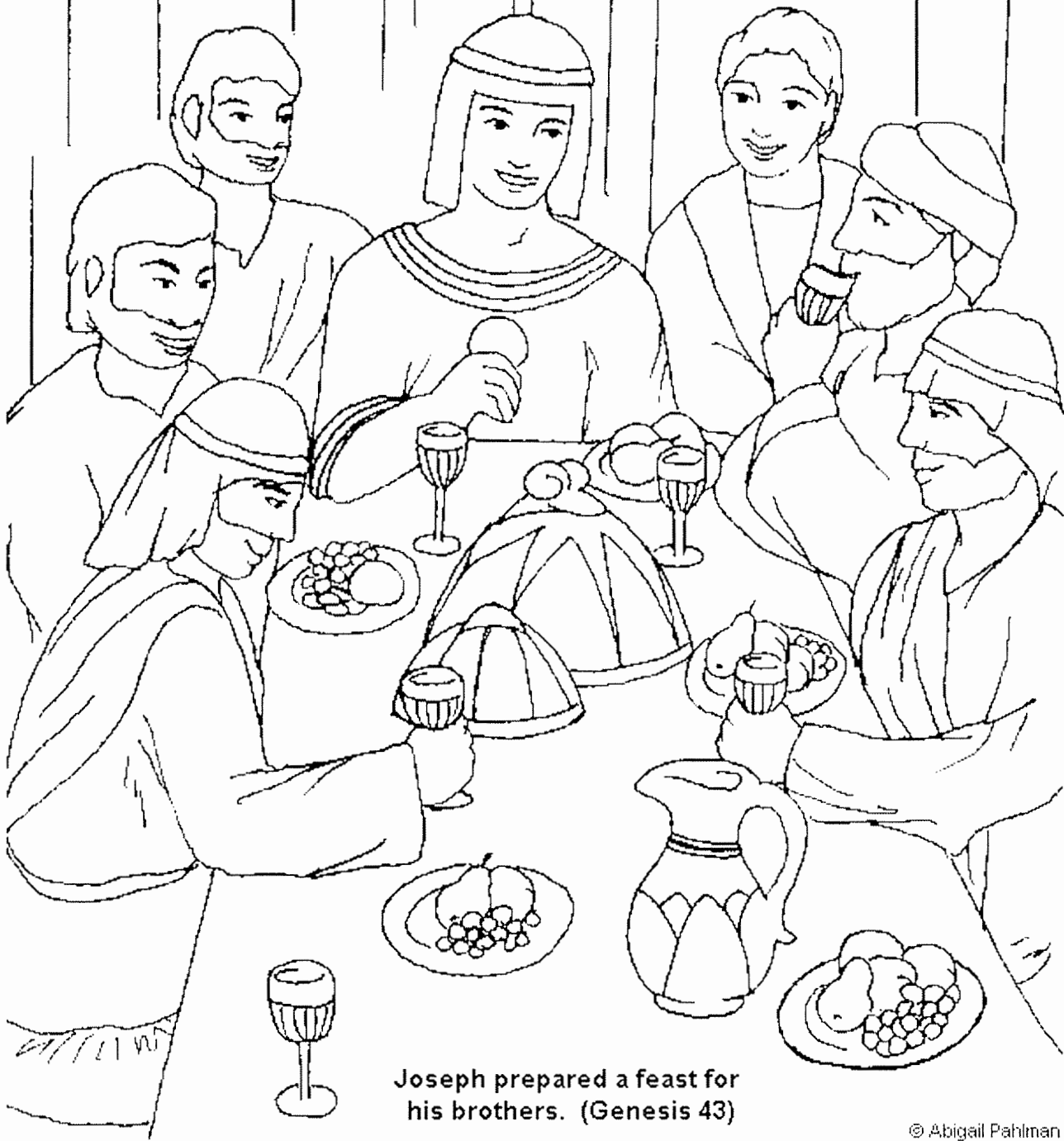

Joseph prepared a feast for  
his brothers. (Genesis 43)

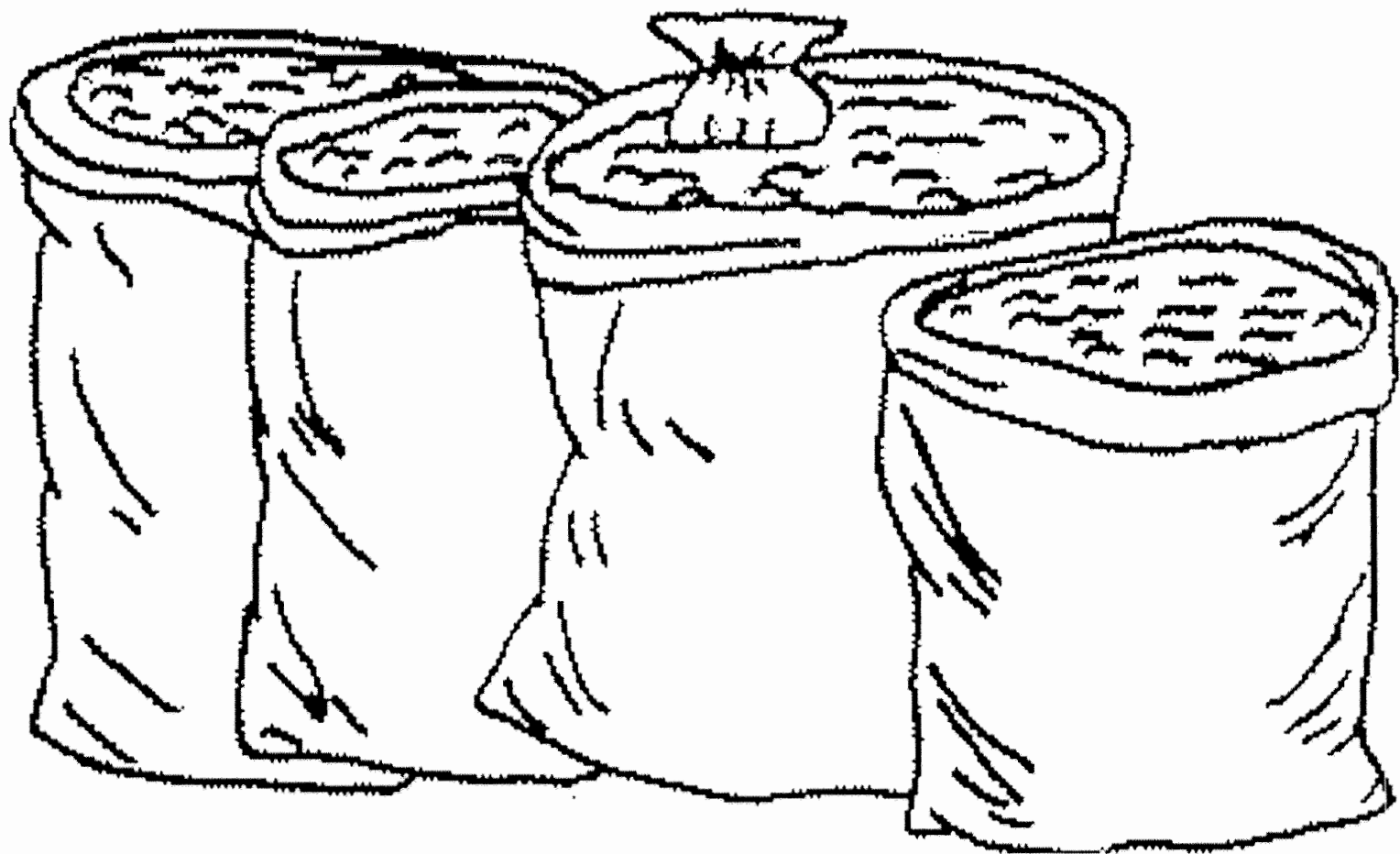

Putiphar's wife



Joseph as a 17 year old Israelite



Reuben, the oldest son

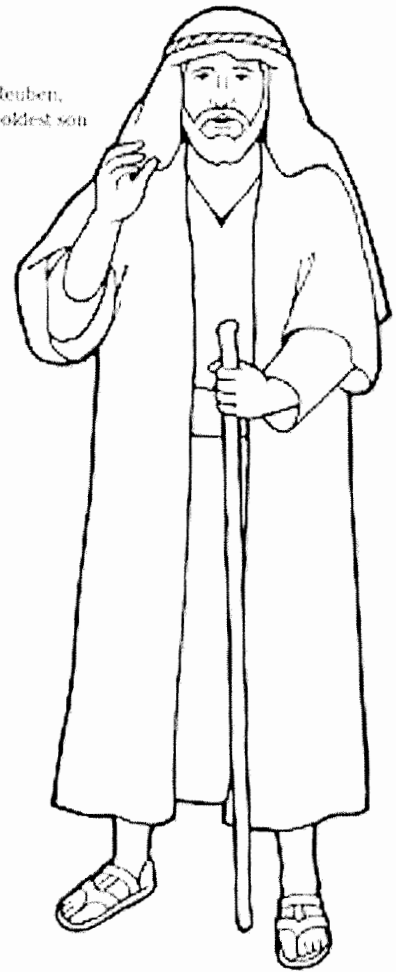

Joseph as an overseer in Egypt



The other shepherds





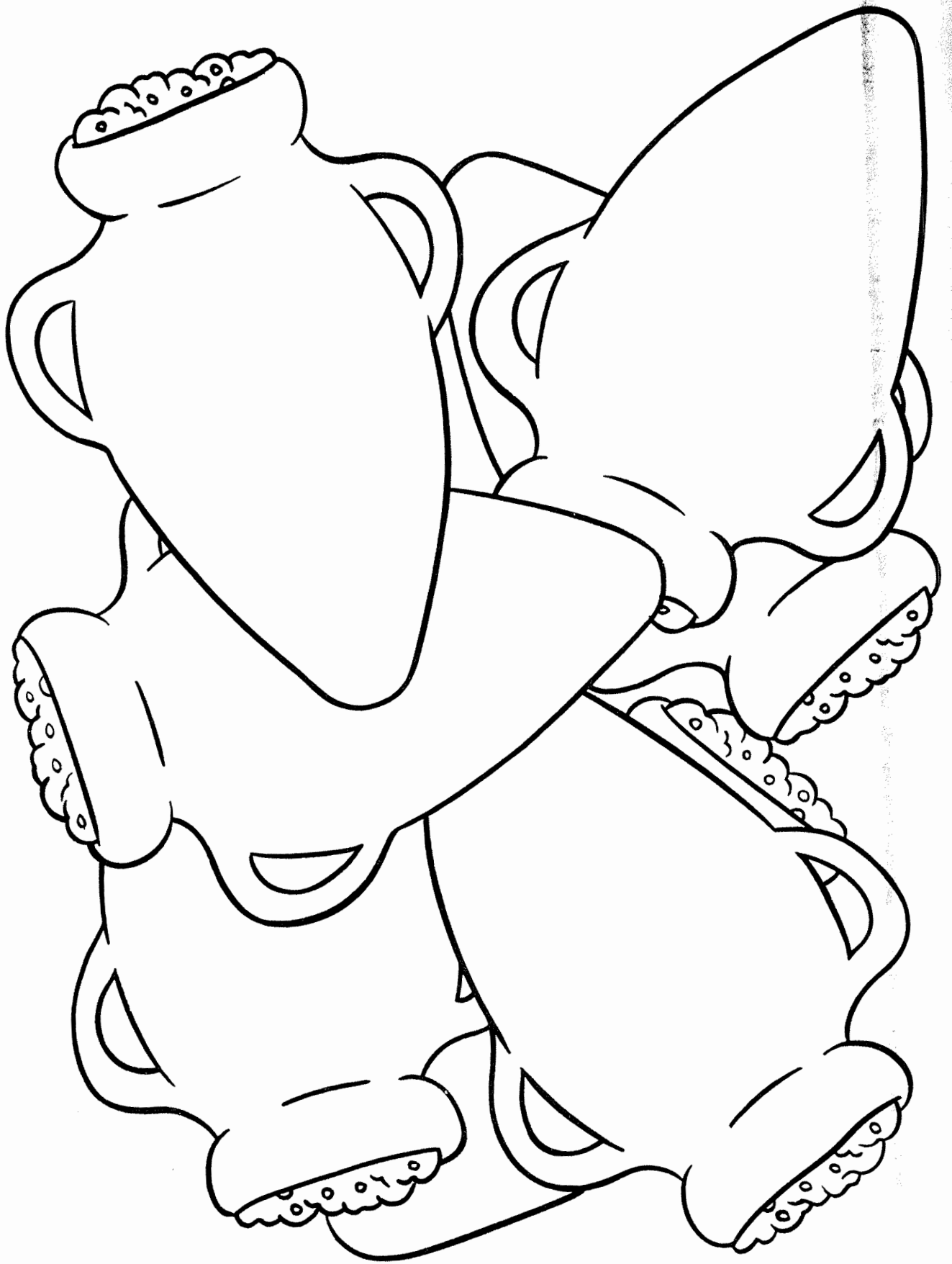

How many containers of grain are there ?

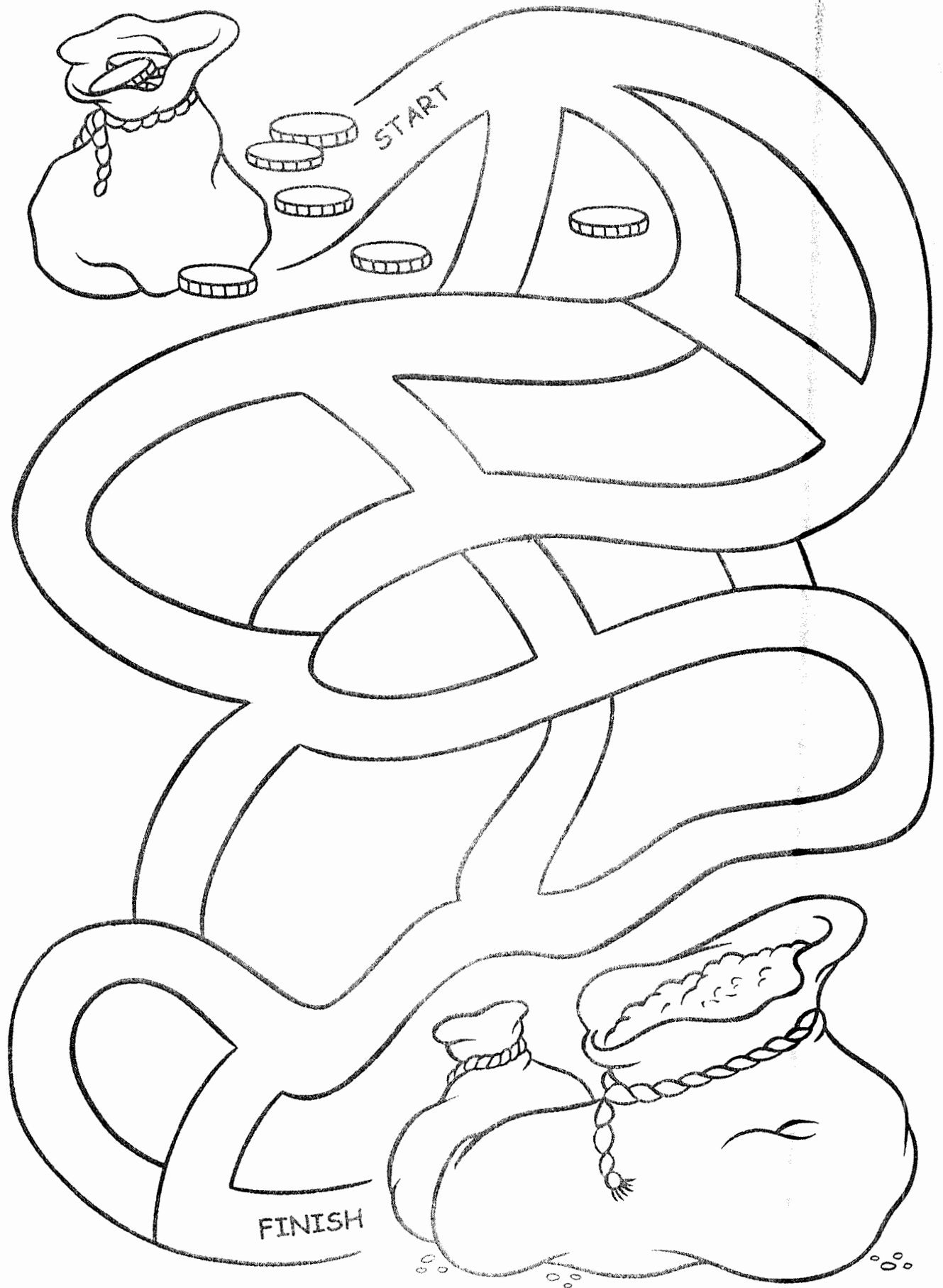

Put the money into the grain sacks.

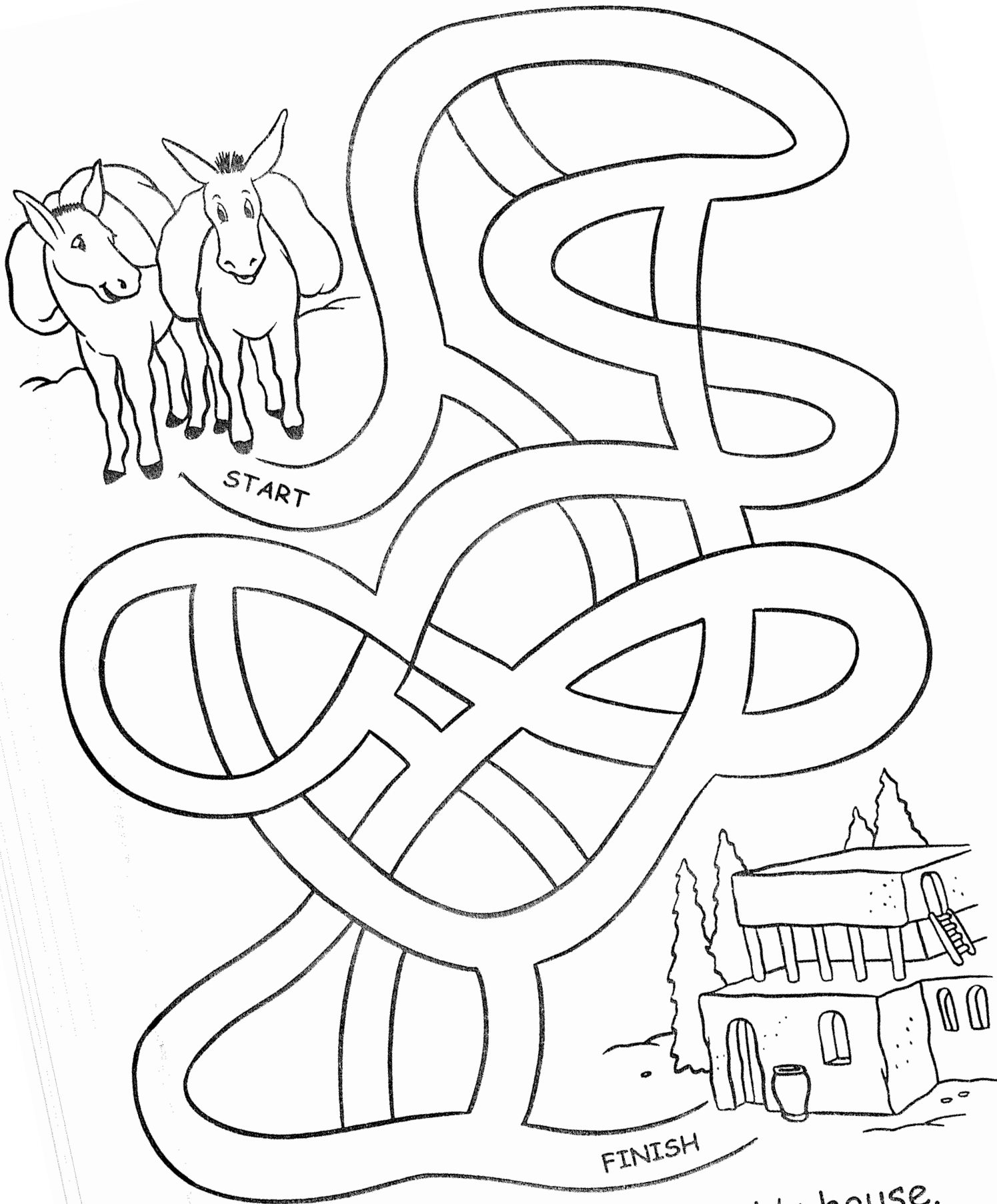

Get the donkeys to Joseph's house.

## **12 Sons of Jacob**

Genesis 29:31-Genesis 30: 24 and Genesis 35:16-20

Genesis 35:23-26 (according to each wife)

1. Reuben
2. Simeon
3. Levi
4. Judah
5. Dan
6. Naphtali
7. Gad
8. Asher
9. Isaachar
10. Zebulun
11. Joseph
12. Benjamin

# Jacob's Family

Jacob

Children by Leah

Reuben Simeon Levi Judah Issachar Zebulun Dinah (d.)

Children by Bilhah

Dan Naphtali

Children by Zilpah

Gad Asher

Children by Rachel

Joseph Benjamin

d. = daughter. All others are sons.

# Joseph Entertains His Brothers (Genesis 43)

- |            |           |
|------------|-----------|
| AFRAID     | HONEY     |
| ALMONDS    | ISRAEL    |
| BENJAMIN   | JOSEPH    |
| BIRTHRIGHT | JUDAH     |
| BOWED      | MERRY     |
| BREAD      | MONEY     |
| BROTHER    | MYRRH     |
| CHAMBER    | OBEISANCE |
| EGYPTIANS  | PEACE     |
| FAMINE     | SACKS     |
| FATHER     | SERVANT   |
| FOOD       | SIMEON    |
| GOD        | SPICES    |
| GRACIOUS   | TREASURE  |
| HEBREWS    | WEPT      |

B	E	N	J	A	M	I	N	O	H	A	D	U	J	M
O	J	M	M	T	M	N	O	E	M	I	S	G	Y	E
S	B	O	W	E	D	B	R	O	T	H	E	R	X	R
K	I	E	J	I	L	W	X	Q	U	R	A	J	R	
C	R	N	I	R	E	B	M	A	H	C	O	Y	X	G
A	T	I	S	S	P	I	C	E	S	J	I	S	X	G
S	H	R	A	R	E	A	T	M	O	N	E	Y	O	E
N	A	R	A	R	F	N	H	I	Y	A	M	U	P	O
A	I	F	E	V	O	M	C	H	X	Q	U	S	H	D
I	G	R	L	A	O	T	R	E	A	S	U	R	E	T
T	H	R	M	N	D	J	M	B	I	D	T	O	D	A
P	T	R	E	T	Y	T	M	R	A	F	R	A	I	D
Y	H	O	N	E	Y	H	I	E	P	E	A	C	E	A
G	O	F	A	T	H	E	R	W	A	T	W	O	M	A
E	F	A	I	T	H	B	S	S	D	N	O	M	L	A

## Bonus Trivia

Complete the prayer, "Create in me a clean heart, O God—" Ps. 51:10

# 48

## Jacob & Sons

ASHER  
BENJAMIN  
CANAAN  
COAT  
DONKEY  
EGYPT  
EPHRAIM  
FAMINE  
FLOCKS  
GAD  
GOSHEN  
GRAIN  
ISRAEL

JOSEPH  
JUDAH  
LADDER  
MARRIAGE  
PHARAOH  
REBEKAH  
REUBEN  
SLAVE  
STARS  
WELL  
WRESTLE  
ZEBULUN

J	U	S	G	R	A	I	N	I	K	S	R	Q	E	K
H	P	E	S	O	J	U	D	A	H	S	M	D	P	N
F	M	H	E	K	S	H	V	O	E	K	P	W	N	M
L	A	R	D	E	R	H	M	N	B	F	L	H	D	
O	R	C	A	N	U	B	E	N	C	K	R	C	M	Y
C	R	E	Y	S	F	X	T	I	R	T	P	Y	G	E
S	A	F	B	E	N	J	A	M	I	N	H	M	P	B
L	G	D	A	E	N	C	O	B	M	A	H	I	U	
A	E	K	J	H	K	Z	C	F	R	F	R	M	F	L
V	S	T	A	R	S	A	M	I	H	A	A	U	B	U
E	R	H	Z	L	B	I	H	N	I	M	O	G	Q	N
G	A	D	E	K	M	U	A	M	R	I	H	A	L	M
F	T	X	R	R	H	S	X	B	H	N	W	J	K	I
I	S	R	A	E	L	L	E	W	R	E	S	T	L	E

### Bonus Trivia

What prophet commanded, "Make you a new heart and a new spirit; for why will ye die"?

Ezekiel. Ezek. 18:31.





T -- True

F -- False

\_\_\_\_\_ Joseph lived in the land of Ur as a boy.

\_\_\_\_\_ Jesus lived in the land of Egypt as a boy.

\_\_\_\_\_ Joseph was the son of Leah.

\_\_\_\_\_ Benjamin was a brother of Joseph.

\_\_\_\_\_ Jesus did not have any brothers or sisters.

\_\_\_\_\_ Joseph was sold to the Ishmeelites for thirty pieces of silver.

\_\_\_\_\_ Reuben wanted to kill Joseph.

\_\_\_\_\_ The Gentiles will not trust in the name of Jesus.

\_\_\_\_\_ God said, "Thou art my beloved son, in who I am well pleased."

\_\_\_\_\_ Jesus said, "As I live, saith the Lord, every knee will not bow to me."

\_\_\_\_\_ Jacob said, "Shall I and thy mother and thy brethren indeed come to bow down ourselves to thee to the earth?"

\_\_\_\_\_ Joseph said, "My sheaf will make obeisance to your sheaves.

\_\_\_\_\_ The moon and eleven stars made obeisance to the sun in Joseph's dream.

\_\_\_\_\_ The son of man is the Lord of the sabbath.

\_\_\_\_\_ Jesus whom you have crucified was made slave to all.

\_\_\_\_\_ No man can say that Jesus is Lord, but by the Holy Ghost.

\_\_\_\_\_ Joseph had a coat whose color was blue.

\_\_\_\_\_ Jesus had a robe made of several pieces of cloth.

\_\_\_\_\_ Joseph asked his father if he could go see about his brethren.

\_\_\_\_\_ The son of man came to seek those that were saved.

\_\_\_\_\_ God sent his Son into the world to condemn the world.

- \_\_\_\_\_ Joseph's brothers loved him.
- \_\_\_\_\_ Jesus' brothers (the Jews) hated him.
- \_\_\_\_\_ Joseph's brothers conspired against him to slay him.
- \_\_\_\_\_ The chief priest and the scribes and the elders of the people consulted with Caiaphas to give Jesus a present.
- \_\_\_\_\_ Joseph took his many-colored coat with him to Egypt.
- \_\_\_\_\_ Jesus' robe was left on him when he was nailed to the cross.
- \_\_\_\_\_ Jesus was sold for thirty pieces of silver.
- \_\_\_\_\_ Jesus was taken by the Grecian soldiers and they stripped him and put on him a scarlet robe.
- \_\_\_\_\_ Judah said to his brethren, "What profit is it if we slay our brother and conceal his blood?"
- \_\_\_\_\_ Joseph was sold to the King of Egypt.
- \_\_\_\_\_ The Devil was with Joseph in Egypt.
- \_\_\_\_\_ Joseph yielded to the temptation of Potiphar's wife.
- \_\_\_\_\_ Joseph was a goodly person and well-favored.
- \_\_\_\_\_ Jesus was led into the wilderness by Satan.
- \_\_\_\_\_ The Tempter said to Jesus, "If thou be the Son of God, command that these stones be made bread."
- \_\_\_\_\_ Jesus said, "It is written: Man shall live by bread alone."
- \_\_\_\_\_ Satan said, "Thou shalt worship the Lord thy God and him only shalt thou serve."
- \_\_\_\_\_ Potiphar's wife was a virtuous woman.
- \_\_\_\_\_ Potiphar's wife lied to her husband about Joseph's chastity.
- \_\_\_\_\_ Joseph was bound and cast into prison, and God forgot all about Joseph while he was there.

- \_\_\_\_\_ Joseph had more power than Pharoah.
- \_\_\_\_\_ Jesus was received up into heaven and sat on the right hand of God.
- \_\_\_\_\_ Pharoah gave Joseph a special name.
- \_\_\_\_\_ Jesus was twelve years old when he began his ministry.
- \_\_\_\_\_ The church is the bride of Christ.
- \_\_\_\_\_ People come to Jesus for bread to survive.
- \_\_\_\_\_ People came to Joseph for the bread of life to survive.
- \_\_\_\_\_ Joseph's brothers recognized him when they first saw him in Egypt.
- \_\_\_\_\_ Joseph's brethren said, "We are verily guilty concerning our brother."
- \_\_\_\_\_ Jesus said, "I am the bread of life: he that cometh to me shall hunger."
- \_\_\_\_\_ The disciples prepared the table for Jesus.
- \_\_\_\_\_ Joseph and his brothers and the Egyptians all ate together.
- \_\_\_\_\_ Joseph would not forgive his brethren for selling him to the Ishmeelites.
- \_\_\_\_\_ Then said Jesus, "Father, do not forgive them, for they know what they are doing."
- \_\_\_\_\_ God sent me (Joseph) before you, not to preserve you as a posterity in the earth and to destroy your lives.
- \_\_\_\_\_ It was God that sent Joseph to Egypt.
- \_\_\_\_\_ Jesus was sent to seek and destroy those that were lost.
- \_\_\_\_\_ Joseph said to his brothers, "See that ye fall not by the way."
- \_\_\_\_\_ God made the church to be over Christ.
- \_\_\_\_\_ We are to lay up treasures on earth to buy our way into heaven.

# **Year 1**

## **Week 29**

## **Joseph Reveals Himself**

**Scriptures: Genesis 44 – 45:15**

**Key Verse: Genesis 44:7 And God sent me before you to preserve a posterity for you in the earth, and to save your lives by a great deliverance.**

### **Key Points:**

1. Joseph had his brothers sacks filled with grain again, also putting their money back. Joseph also instructed that his silver cup be put in Benjamin's sack.
2. As the brothers journeyed back home, Joseph sent his messenger to catch up to them and confront them about the money and cup.
3. Because of the cup being found in Benjamin's sack, he was to come back to Joseph and be his slave. In their grief, they tore their clothes and returned to face Joseph. Once again they fell on the ground before him.
4. Judah intercedes for Benjamin, explaining how grieved their father will be, also offering to be his slave in Benjamin's place. This is an interesting change of events, since it was Judah, who 22 years earlier, wanted to sell Joseph to the Ishmaelites. Judah had become a better man, willing now to offer his own life for Benjamin.
5. Joseph can no longer restrain himself and reveals his identity. He told them not to fear him or be angry at themselves because it was God's plan that he go to Egypt to preserve their lives and the lives of others.
6. Joseph tells them to bring their father to Egypt where he could provide for them for there would be 5 more years of famine. Joseph was filled with emotion and wept with his brothers.

Year 1, Week 29  
Genesis 44-45:15  
Joseph Reveals Himself



**Genesis 44:7**

And they said to him, "Why does my lord say these words? Far be it from us that your servants should do such a thing. (NKJV)

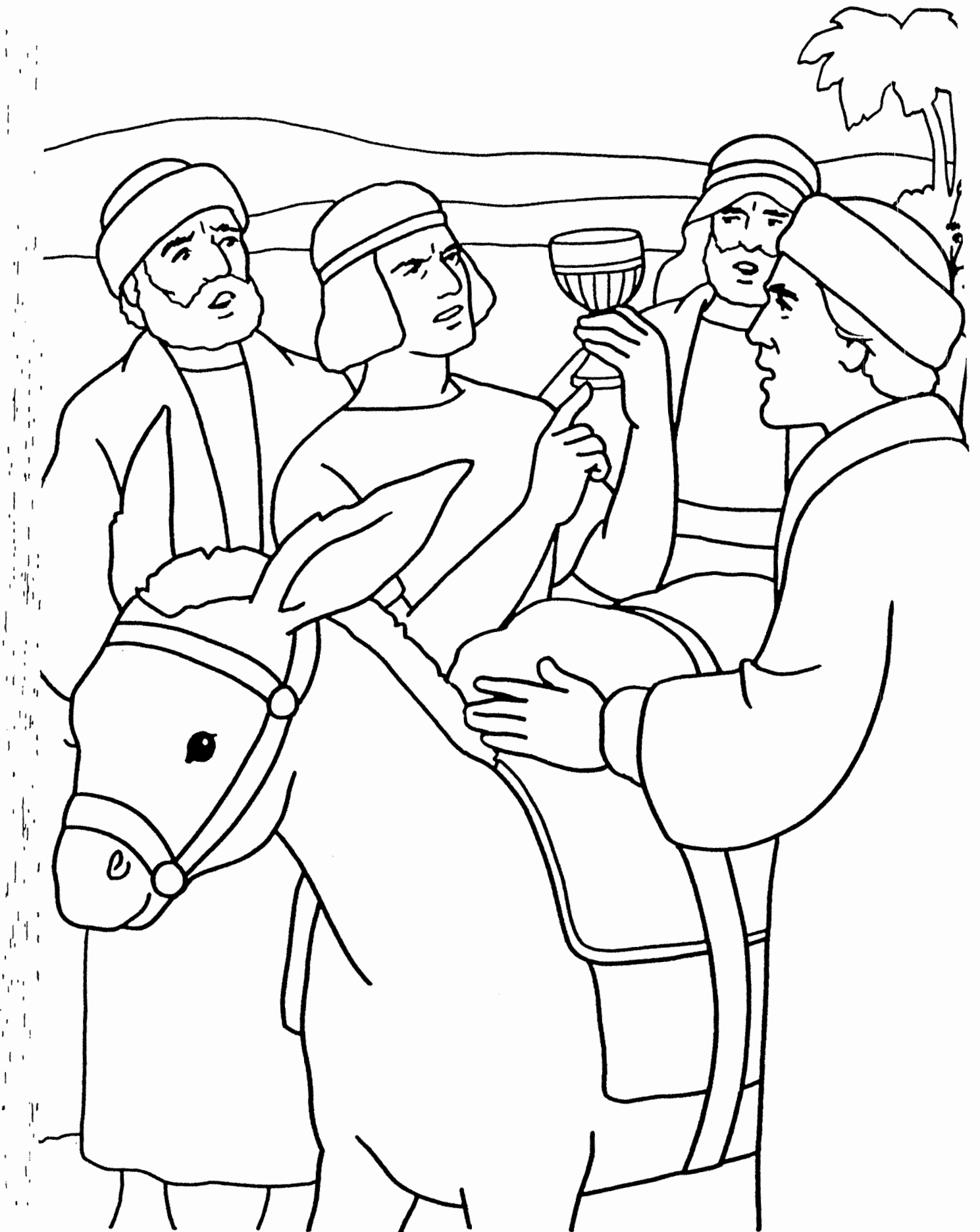

A servant put Joseph's silver cup in Benjamin's sack of grain. Joseph sent the servant to make the brothers return.

*Genesis 44:1-13*

JOSEPH'S \_\_\_\_\_ WAS FOUND IN BENJAMIN'S SACK OF GRAIN

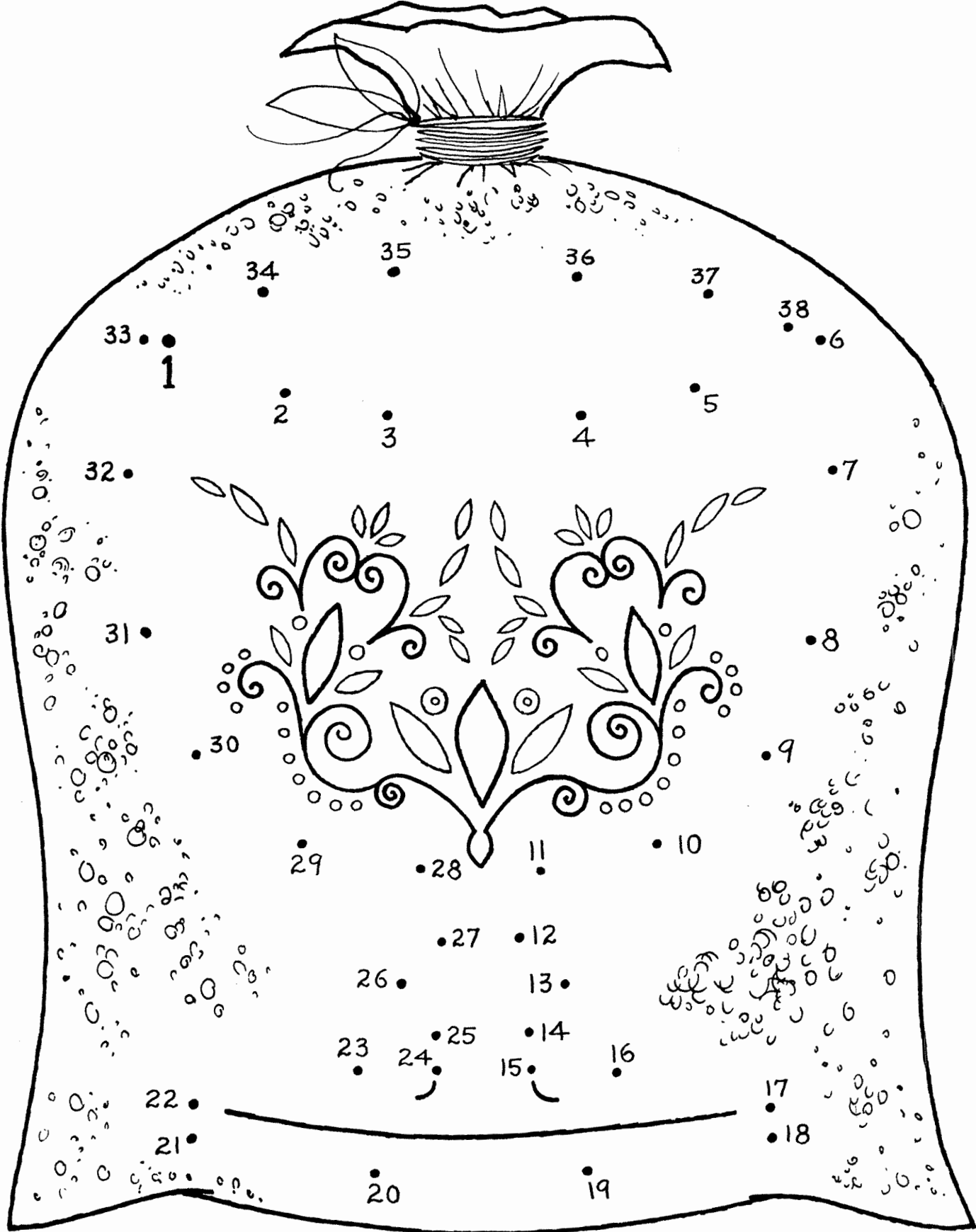



When Joseph saw his brothers were afraid, he told them who he was.



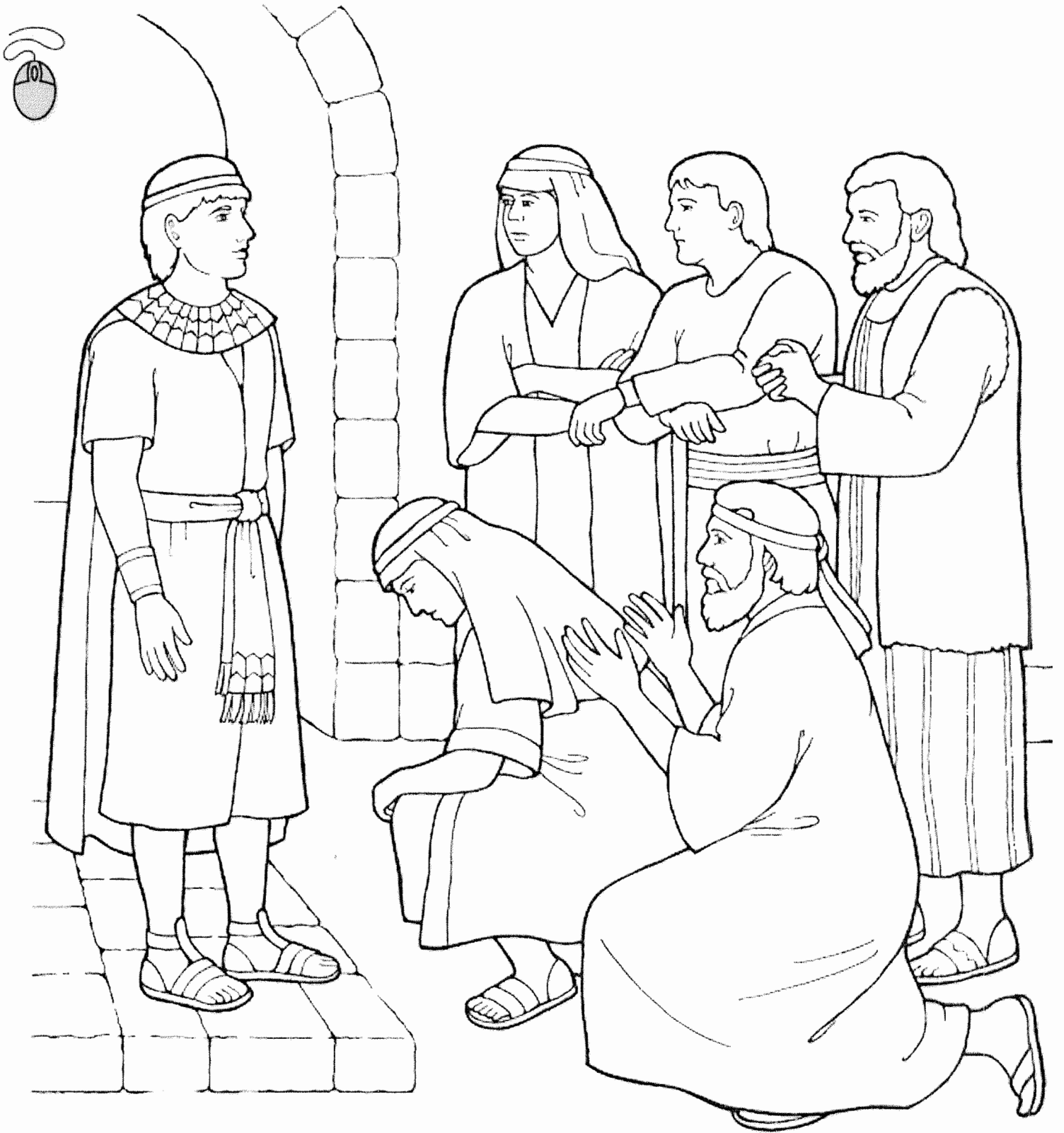

**Joseph Forgives His Brothers**

*I am Joseph your brother, whom ye sold into Egypt. Now therefore be not grieved, nor angry with yourselves, that ye sold me hither: for God did send me before you to preserve life*

*Genesis 45:1-5*



Because of the famine in Canaan, Jacob sent his sons to Egypt for grain. There they met their brother, Joseph.



Joseph Forgives His Brothers  
Genesis 42-46

# JOSEPH TELLS HIS SECRET

Genesis 44:1-45:16

Color the picture using the color code.

- COLOR KEY**
- 1 = red
  - 2 = blue
  - 3 = yellow
  - 4 = green
  - 5 = brown
  - 6 = orange

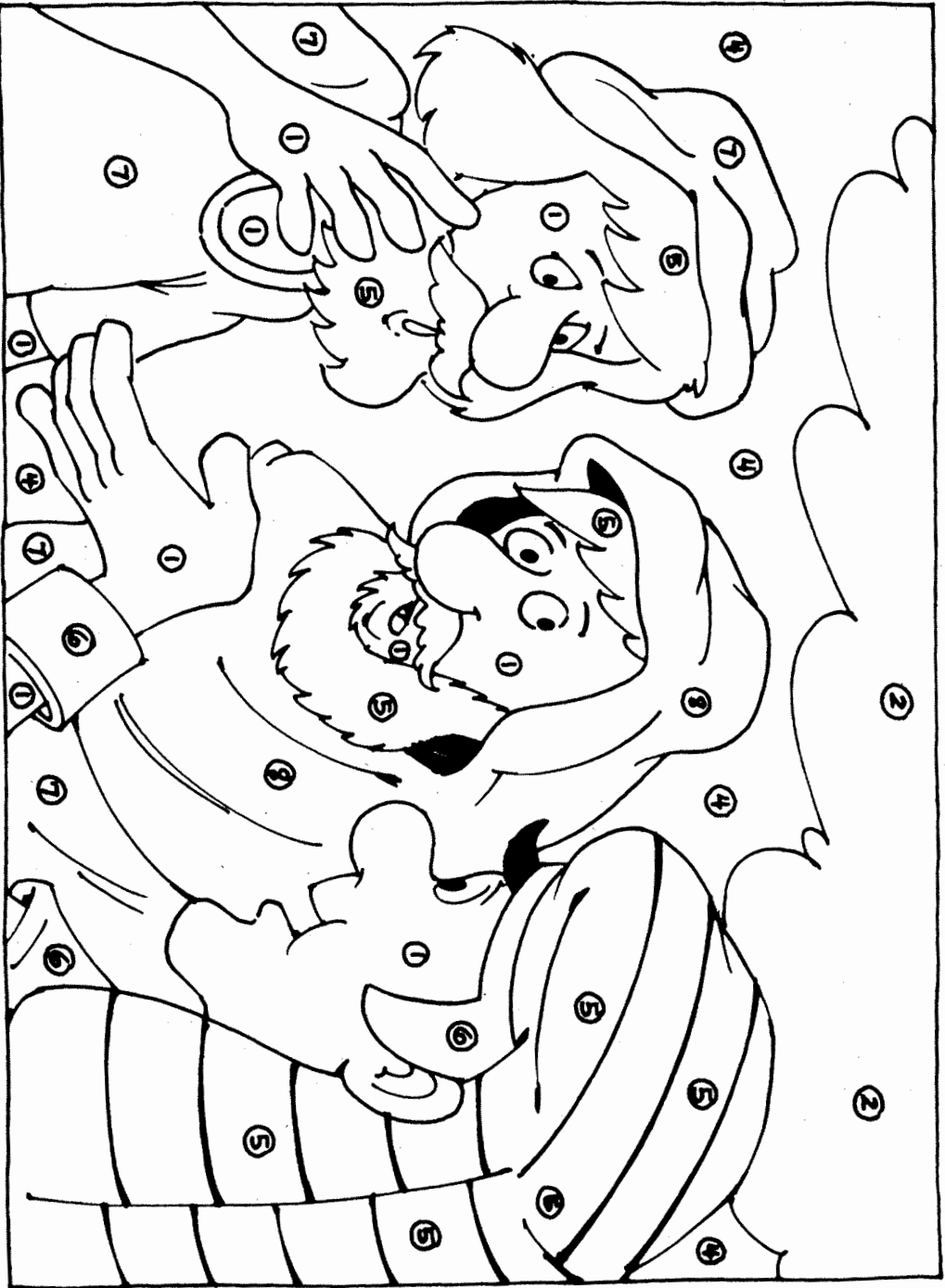

Joseph finally told his brothers who he was. Then they were afraid that he would have them killed because of the way they had treated him. Instead, Joseph promised that he would take care of all of them. He sent them home to get their families and his father to come live in Egypt.

# Joseph's Family Reunion

Genesis 39-41 (NIV)

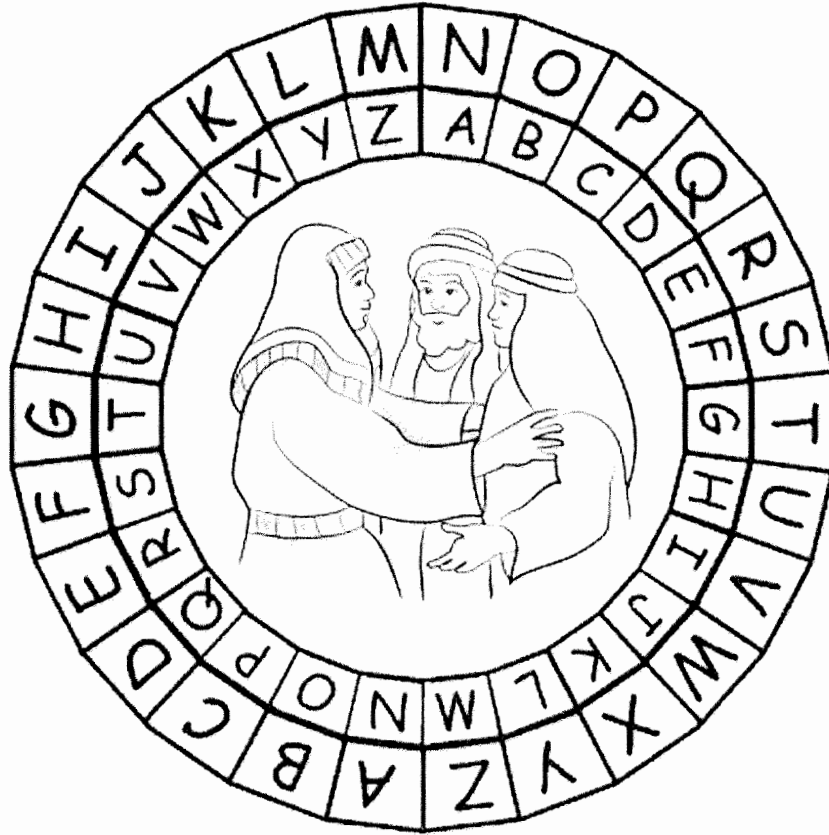

To find out what Joseph said to his brothers, when he revealed himself to them, use the code to solve the puzzle. Find the Letter in the message on the outside circle. Match it with the letter under it on the inside circle.

"I am your brother Joseph, the one you sold into Egypt. . .

---

TBQ FRAG ZR NURNQ BS LBH GB CERFREIR

---

SBE LBH N ERZANAG BA RNEGU NAQ GB

---

FNIR LBHE YVIRF . . ." (Genesis 45:5-7)

## Genesis 45:4-5

Fill in the blanks using the New King James Version of the Bible.

And Joseph said to his \_\_\_\_\_, "Please  
come \_\_\_\_\_ to me." So they came near.

Then he said: "I *am* \_\_\_\_\_ your  
\_\_\_\_\_, whom you sold into \_\_\_\_\_.

But now, do not therefore be \_\_\_\_\_  
or \_\_\_\_\_ with yourselves because you  
\_\_\_\_\_ me here; for \_\_\_\_\_ sent me  
\_\_\_\_\_ you to \_\_\_\_\_.

"Scripture taken from the New King James Version. Copyright © 1982 by Thomas Nelson,

Inc. Used by permission. All rights reserved."

# Joseph Crossword

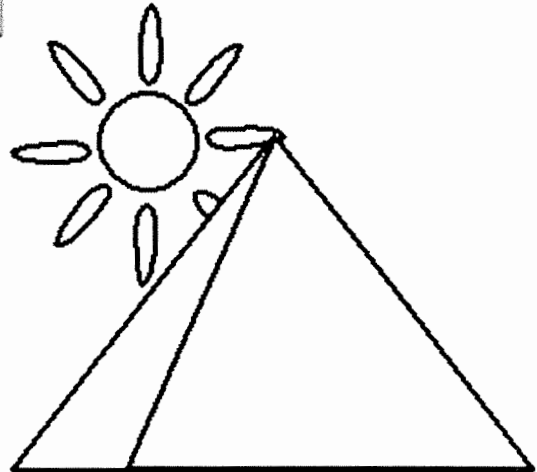
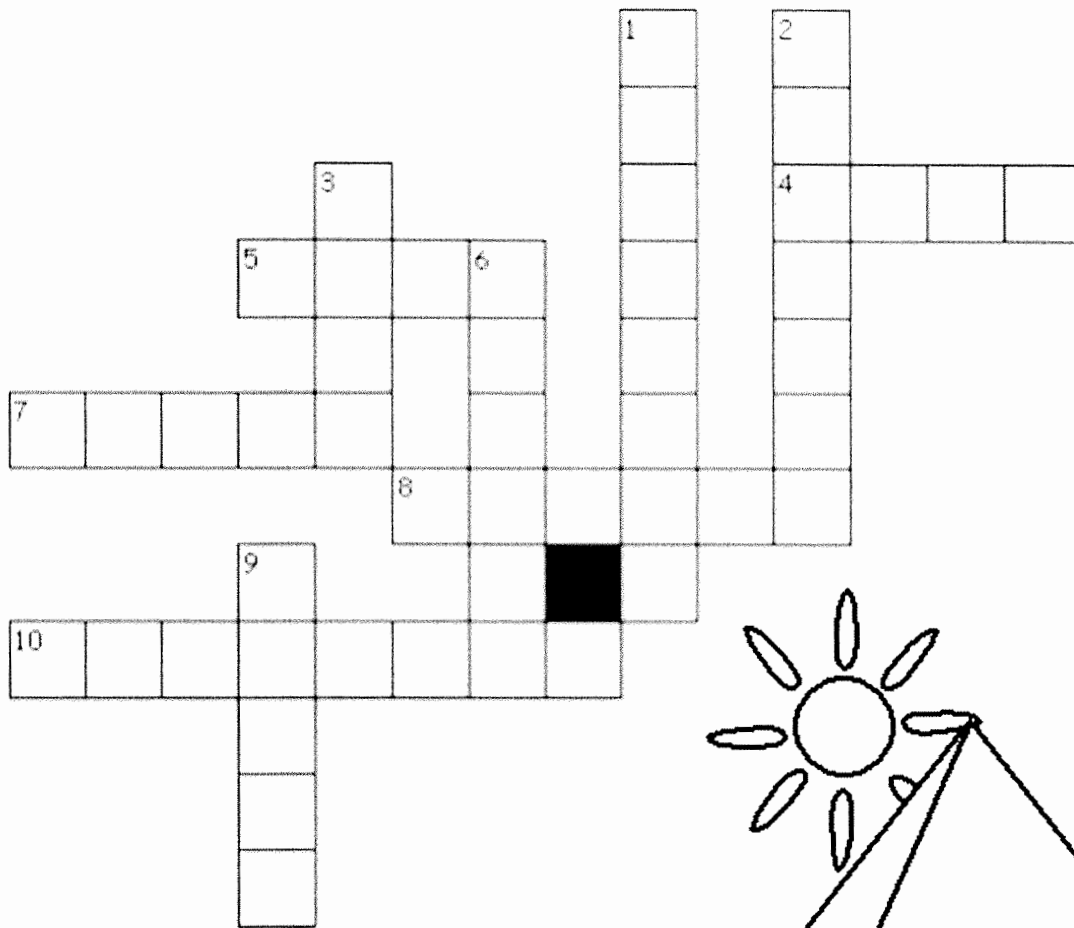

## Across

- Pharaoh gave this to Joseph when he put him in charge of Egypt.
- Joseph's brothers didn't kill him, they \_\_\_\_ him.
- After God told Joseph about Pharaoh's dreams he became in charge of this whole place.
- During the seven years of this, Joseph had enough food in reserve to share with those in need.
- It was because of this that Joseph ended up in Egypt.

## Down

- This is the name of the youngest brother.
- Joseph did the right thing when he \_\_\_\_ his brothers.
- Joseph received this from his father.
- Joseph had a gift of interpreting these.
- Joseph's brother's covered his coat in animal \_\_\_\_ so their father thought he was dead

# PEOPLE OF THE BIBLE

FIND THE WORDS LISTED BELOW IN THE WORD SEARCH ON THE NEXT PAGE.

JACOB            SIMEON

REUBEN            LEAH

REBEKAH            LEVI

RACHEL            JUDAH

NAPHTALI            DAN

GAD            BILHAH

S	R	J	R	N	M	J	N	B	V	S	H	
E	I	D	F	K	R	A	D	B	B	R	A	G
W	X	M	H	R	D	L	Y	V	E	M	F	
R	V	D	E	J	O	N	L	L	G	P	B	
Y	N	A	G	O	J	V	B	T	B	R	X	
I	M	H	A	H	N	E	H	D	F	E	X	
O	P	F	A	N	T	A	E	L	Q	U	C	
F	O	D	T	P	H	R	B	W	R	B	U	
E	U	V	I	L	T	E	D	V	E	E	R	
J	U	V	I	A	C	A	R	B	B	E	A	
U	E	B	H	A	G	P	I	N	E	S	C	
L	K	Y	Q	L	R	V	B	J	K	Z	H	
L	J	U	M	W	I	B	B	P	A	K	E	
N	A	P	H	T	A	L	I	C	H	W	L	
B	S	G	J	A	C	O	B	Q	N	S	N	



# JOSEPH REVEALS HIMSELF TO HIS BROTHERS (GENESIS 45:1-16)

## MEMORY VERSE:

*"Therefore be merciful, just as your Father also is merciful." LUKE 6:36*

## TRUE OR FALSE:

1. "Then Joseph could not restrain himself before all those who stood by him, and he cried out, 'Make everyone go out from me!' So no one stood with him while Joseph made himself known to his brothers." **GENESIS 45:1**

**TRUE OR FALSE**

## CIRCLE THE CORRECT WORD:

2. "And he (**SANG, WEPT**) aloud, and the Egyptians and the house of Pharaoh heard it." **GENESIS 45:2**

## TRUE OR FALSE:

3. "Then Joseph said to his brothers, 'I am Joseph; does my father still live?' " **GENESIS 45:3**

**TRUE OR FALSE**

**"AND JOSEPH SAID TO HIS BROTHERS, 'PLEASE COME NEAR TO ME.' AND THEY CAME NEAR. AND HE SAID: 'I AM JOSEPH YOUR BROTHER, WHOM YOU SOLD INTO EGYPT. BUT NOW, DO NOT THEREFORE BE GRIEVED NOR ANGRY WITH YOURSELVES BECAUSE YOU SOLD ME HERE; FOR GOD SENT ME BEFORE YOU TO PRESERVE LIFE. ' " GENESIS 45:4-5**

## CIRCLE THE CORRECT WORD:

4. Joseph also said to his brothers, "So now it was not you who sent me here, but (**ME, GOD**); and He has made me a father to Pharaoh, and lord of all his house, and a ruler throughout all the land of Egypt." **GENESIS 45:8**

## FILL IN THE BLANK:

5. Then Joseph said, "You shall \_\_\_\_\_ in the land of Goshen, and you shall be near to me, you and your children, your children's children, your flocks and your herds, and all that you have." **GENESIS 45:10**

## TRUE OR FALSE:

6. Joseph told his brothers, "So you shall tell my father of all my glory in Egypt, and of all that you have seen; and you shall hasten and bring my father down here." **GENESIS 45:13**

**TRUE OR FALSE**

7. Joseph "kissed all his brothers and wept over them, and after that his brothers talked with him." **GENESIS 45:15**

**TRUE OR FALSE**

# JOSEPH REVEALS HIMSELF TO HIS BROTHERS (GENESIS 45:1-16)

## MEMORY VERSE:

*"Therefore be merciful, just as your Father also is merciful." LUKE 6:36*

## TRUE OR FALSE:

1. "Then Joseph could not restrain himself before all those who stood by him, and he cried out, 'Make everyone go out from me!' So no one stood with him while Joseph made himself known to his brothers." **GENESIS 45:1**

**TRUE OR FALSE**

## FILL IN THE BLANKS:

2. "And he \_\_\_\_\_ aloud, and the Egyptians and the house of Pharaoh heard it."  
**GENESIS 45:2**

3. "Then Joseph said to his brothers, 'I am Joseph; does my father still \_\_\_\_\_?' " **GENESIS 45:3**

**"AND JOSEPH SAID TO HIS BROTHERS, 'PLEASE COME NEAR TO ME.' AND THEY CAME NEAR. AND HE SAID: 'I AM JOSEPH YOUR BROTHER, WHOM YOU SOLD INTO EGYPT. BUT NOW, DO NOT THEREFORE BE GRIEVED NOR ANGRY WITH YOURSELVES BECAUSE YOU SOLD ME HERE; FOR GOD SENT ME BEFORE YOU TO PRESERVE LIFE. ' " GENESIS 45:4-5**

## FILL IN THE BLANKS:

4. Joseph also said to his brothers, "So now it was not you who sent me here, \_\_\_\_\_; and He has made me a father to Pharaoh, and lord of all his house, and a ruler throughout all the land of Egypt." **GENESIS 45:8**

5. Then Joseph said, "You shall \_\_\_\_\_ in the land of Goshen, and you shall be near to me, you and your children, your children's children, your flocks and your herds, and all that you have." **GENESIS 45:10**

6. Joseph told his brothers, "So you shall tell my father of all my glory in Egypt, and of all that you have seen; and you shall hasten and \_\_\_\_\_ down here."  
**GENESIS 45:13**

## TRUE OR FALSE:

7. Joseph "kissed all his brothers and wept over them, and after that his brothers talked with him." **GENESIS 45:15**

**TRUE OR FALSE**

# JOSEPH REVEALS HIMSELF TO HIS BROTHERS (GENESIS 45:1-16)

C P D Z F I H D J N H N E F U  
 T U W R D G B R O T H N E R S O M  
 C H A D O E A Q T A T K P S O M  
 J E P S E U S F A M I N E J M  
 N T H E V L L A A Y T B I W J K  
 W E Q Z S A I C E D O G Y S K  
 N N D E I O E V A L R C B S G H  
 Y D P L G F J U U I R E W P A T  
 J F I N O Y U U I R E W P A T  
 T R A R O S P J U V A S P G P  
 N A T T R F T T E L O N S W E  
 A Z A O H U T K N Q I R C I W  
 S E L B N E L S Q U R F P E K  
 D W E L L T R E P Q W K E A P  
 L M B H H Q D M R T P I Y F D

BROTHERS  
 DELIVERANCE  
 DWELL  
 EGYPT  
 FAMINE  
 FATHER

GOD  
 GOSHEN  
 JOSEPH  
 KISSED  
 LIFE  
 NEAR

PLEASED  
 PROVIDE  
 RULER  
 SOLD  
 WEPT



# JOSEPH REVEALS HIMSELF TO HIS BROTHERS (GENESIS 45:1-16)

G S Q B A F D X D A K K O V L G T K H C P V V B A  
 S P I Q Z V Q N W G K W I U S P K J T V Z K E K C  
 N P L J E I C A H W R L R U E S W F J J U F M V J L  
 B R H I M D U Y D P E P R O V I D E Y B B O V K P  
 K X R C D O E W K A E W F A J O I Y R N X Z L L A  
 K O T E W N E L I U C W O D M T M T R E H T A F E  
 O S Y T L L J Q I U V Z Y J G W F W D H K X I X Y  
 J L O C L U K R Q P T E O X D O V H I G G D Z M R R Q  
 Q K A J Q H R Q I O C R D W V S J S H S E L Z U T A  
 S W V W X I S T I O C R D W V S J S H S E L Z U T A  
 P V C Y N E A R Y M D A A T S J S H S E L Z U T A  
 M J A J I U M H B J C E F N P D M X Q S I B U T O  
 B M L T T A E T B K H M S L C P A V U A Z T C C Y  
 B W F N A F F T P G R M B S T E Y S M E F P Q M E  
 O E O A L F I B P H E N E A I O E U J L Z Z N P A  
 H L Z A M T L R R G M U H O W K D X Q P M F R M E  
 S V M S B I J R Y O Q D T A B L O H L A D V M L Q  
 S D F L Z Q N W F D T L L P H O N U J U K F W C U  
 R D M P Z H T E O V N H U A J U E Q T V X H B S T  
 V Z Q U N A A P J B Y U E D Y I H T W A U N I G V  
 N Z S T K U A D W G M L W R K I S P K E Y E F E S  
 G O Q N O U U N O C A L Q Y S B O L M I E E W Y E  
 D W V D B T E K S G S Y N S P R G J L S E M L P T  
 P S O L D T N B S Z V H I M G W E B U G J J J W K  
 K H P R H D Q C I H Y M S P K G P J G J A Q B I N

BROTHERS  
 DELIVERANCE  
 DISMAYED  
 DWELL  
 EGYPT  
 FAMINE

FATHER  
 GOD  
 GOSHEN  
 JOSEPH  
 KISSED  
 LIFE

NEAR  
 PLEASED  
 PROVIDE  
 RULER  
 SOLD  
 WEPT



## **Year 1**

### **Week 30**

### **Joseph Sees His Father (through the end of his life)**

**Scriptures: Genesis 44:8 - 50**

**Key Verse: Genesis 50:20 But as for you, you meant evil against me; but God meant it for good, in order to bring it about as it is this day, to save many people alive.**

#### **Key Points:**

1. Pharaoh told Joseph to send carts, food, clothing and animals to Canaan to bring Joseph's family to Egypt. This was very generous of an Egyptian Pharaoh, there was usually contempt shown to the Canaanites from the Egyptians. This shows the respect Joseph had in the land.

2. Jacob's (Israel) spirit is revived when he hears the news of his sons. He travels to Egypt, makes sacrifice and God speaks to him in a vision, telling him not to fear to go to Egypt and that he would make him a great nation there. He takes all his possessions and family with him. They numbered 70 people in all.

3. Israel is taken to the land of Goshen in Egypt to live. There he is reunited with Joseph. Pharaoh allows them to shepherd flocks in that area for their occupation.

4. Famine remains and the people sold their land in Egypt as payment for grain. Thus all the land of Egypt eventually belonged to Pharaoh which made him very powerful.

5. Israel was 147 years old, he knew he would soon die so he made Joseph promise he would take him back to Canaan, his home, to bury him. He gave a special blessing to Joseph's sons, Ephriam and Manasseh. He blessed his sons as well, these becoming the 12 tribes of Israel.

## **Week 30 Cont**

Joseph takes him back to Canaan and buries him as promised. His family grew great in possessions and number.

6. Now that Israel was dead, Joseph's brothers worried Joseph would hate them and finally take his revenge. Joseph assured his brothers and comforted them. He said what they had meant for evil, God had meant for good. He was sent to save their families and many more besides.

7. Joseph lived many more years in the land of Egypt. He gave an oath of promise to the children of Israel, that God would bring them out of Egypt and take them back to their home in Canaan. He died at 110 years old and they put his body in a coffin so they could take him back to bury him some day in Canaan.

(This is a lot of information to teach little children in one class session, however, there are so many important details about the children of Israel in this lesson that is a foundation for stories to come. Please use your discretion in teaching the material as best as you can.)

Year 1, Week 30  
Genesis 44:8-50  
Joseph See His Father (through the end of his life)

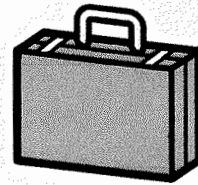
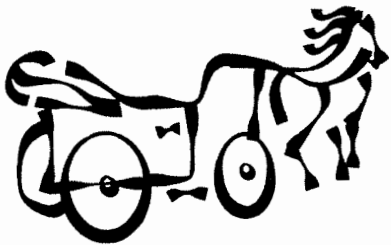

**Genesis 50:20**

"But as for you, you meant evil against me; but God meant it for good, in order to bring it about as it is this day, to save many people alive. (NKJV)

# JACOB MOVES TO EGYPT

(GENESIS 45:17-50:26)



“And take your father and your households, and come unto me: and I will give you the good of the land of Egypt, and ye shall eat the fat of the land.”

**GENESIS 45:18**





Joseph's brothers brought their old father, Jacob, and all their families to live in the land of Egypt.  
Genesis 46:26-3





After receiving help, Jacob and his family went to live in the land of the pharaohs.

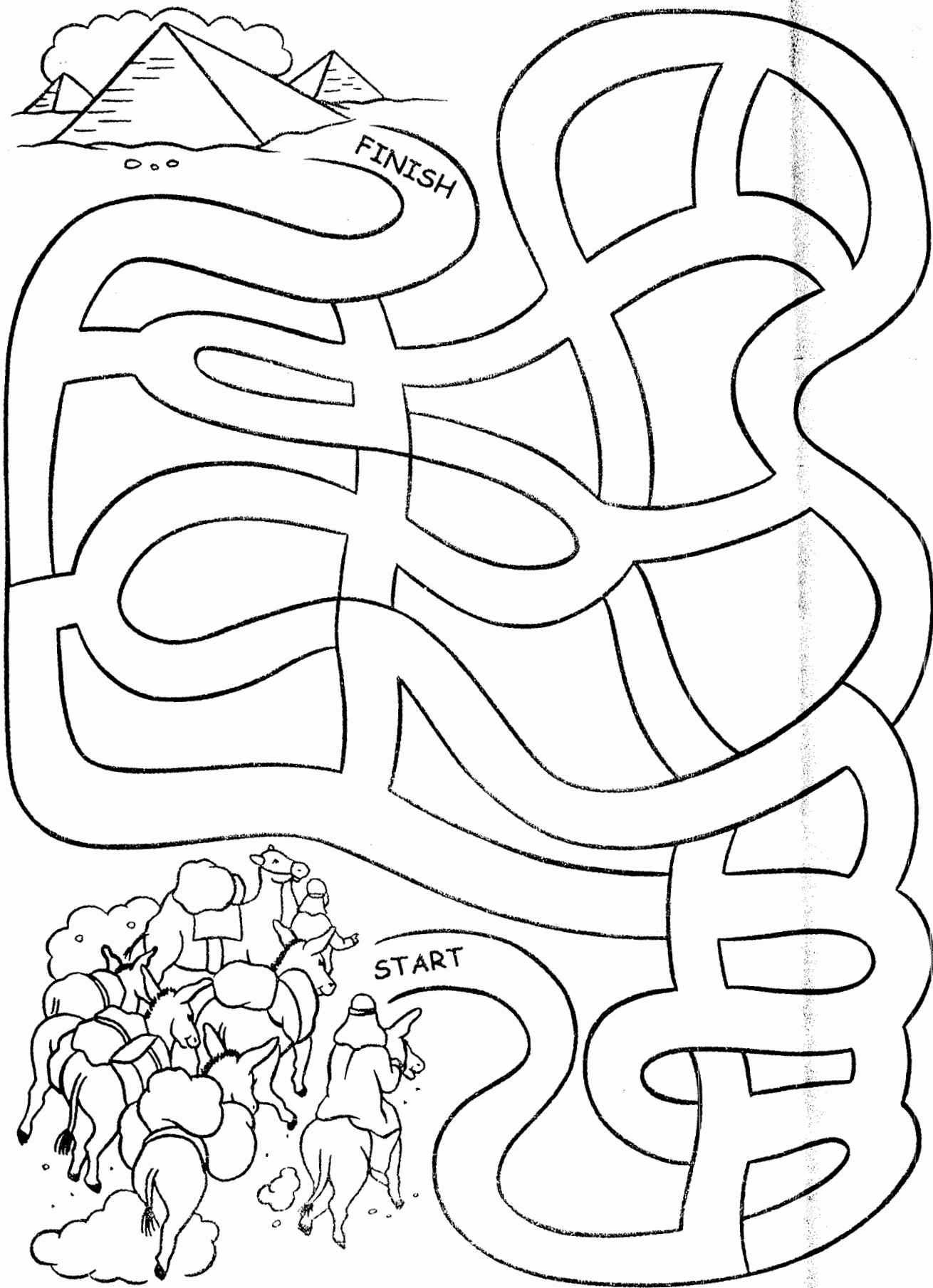

Lead the family to Egypt.

# Joseph Maze

Help Jacob find his son Joseph.

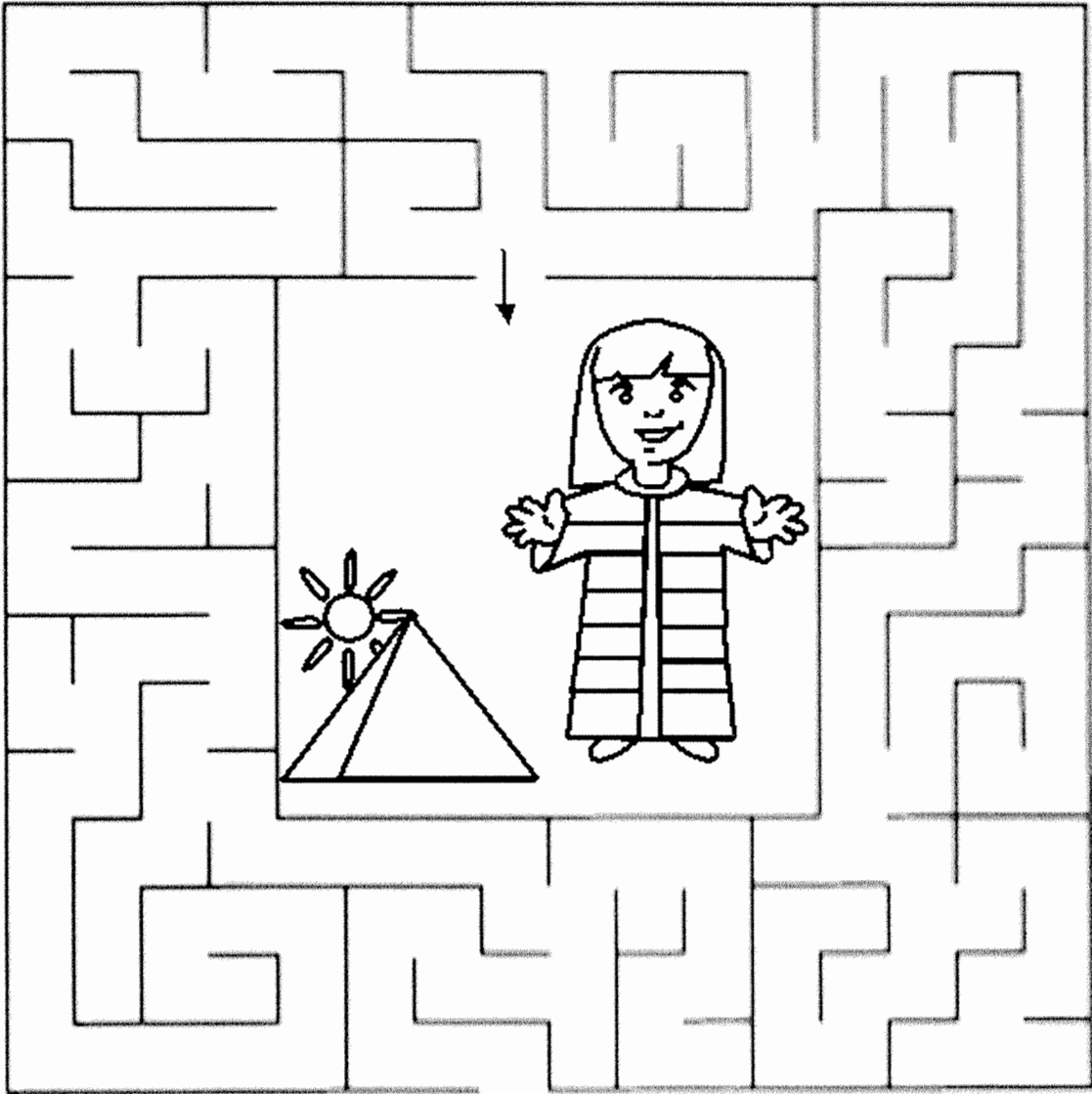

# HIDDEN MESSAGE

Decode the message below.

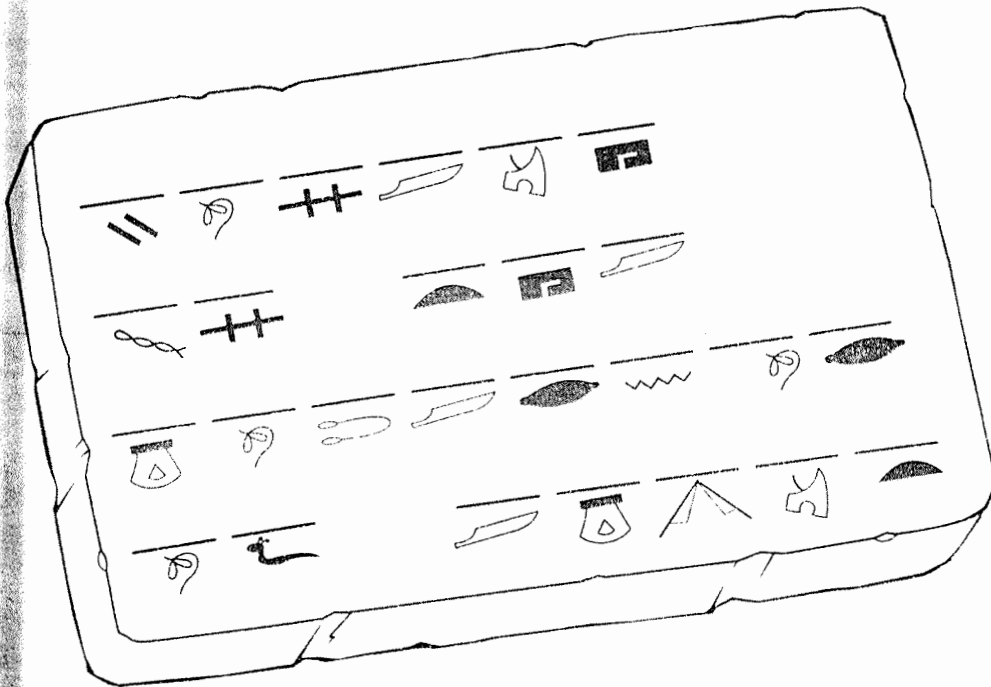

A	B	C	D	E	F
G	H	I	J	K	L
M	N	O	P	Q	R
S	T	U	V	W	X
Y	Z				

# Israel Moves to Egypt

Genesis 46 (NIV)

When Jacob heard from his sons that Joseph was still alive he decided to go see him in Egypt. On his way there he offered up sacrifices to God. That night God spoke to Jacob in a vision and made a promise to him. Read Genesis 46:3 to see what he said and fill in the blanks below.

" I am God, the God of your father," he said.

"Do not be \_\_\_\_\_ to go down to \_\_\_\_\_ ,  
for I will make you into a \_\_\_\_\_ there.  
I will go down to \_\_\_\_\_ with you, and I will  
surely \_\_\_\_\_ you \_\_\_\_\_ again. . . ."

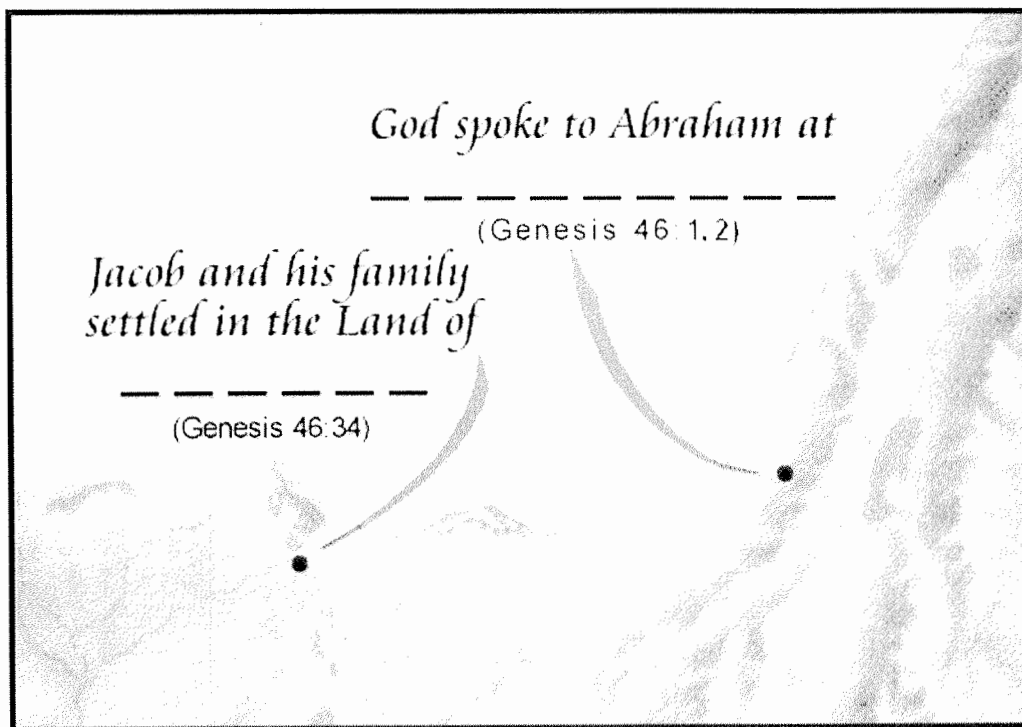

# Family Reunion

Read about Joseph's reunion with his family in Genesis 42, 45, and 47. Then mark an O over the statements that are true and an X over the false ones. If you're correct, you will have three X's or O's in a row.

<p>Ten of Joseph's brothers went to Egypt to try to buy grain.</p>	<p>Joseph's brothers didn't know who he was when they met him in Egypt.</p>	<p>Joseph was angry that his brothers had sold him into slavery.</p>
<p>Joseph told his brothers they should be mad at themselves for what they did.</p>	<p>Joseph said it was good he had been sold into Egypt because he had saved lives.</p>	<p>Joseph didn't want his brothers to tell his father he was alive.</p>
<p>Joseph's brothers were shepherds.</p>	<p>Pharaoh would not let Joseph's family settle in Goshen.</p>	<p>The Israelites increased greatly in number.</p>



# Egyptian Inscription

Read Exodus 1:1-5. These verses tell the names of the twelve sons of Israel. These men and their families moved to the land of Egypt to escape the famine. The names of these twelve men are hidden in the Egyptian inscriptions below. Can you find them?



# JACOB MOVES TO EGYPT

(GENESIS 45:17-50:26)

M U L T I P L I E D D E H J E  
F A T H E R M A C H P E L A H  
E K D L R L S V N H B D B T H  
G S O Z S S D P R A W R E Q M  
Y J O J E I D A H E T H I H U  
P F G O N R I L L A C I E N N  
T R L U I M R L O C R S O L G  
O C V R F B F B A H S A U N C  
D R O N I Y N V L A E C O U A  
O L N E R R E B N E V S O H J  
N S E Y C U V A J L S A U M K  
K P H J A B M A J G I S D O E  
E E S P S V C W L E O V E V H  
Y F O E J O S E P H H D E D R  
S Z G N B B R O T H E R S D L

BLESSED  
BRING  
BROTHERS  
BURY  
CAVE  
COME  
DONKEYS

DWELL  
EGYPT  
EPHRAIM  
EVIL  
FATHER  
GOD

GOOD  
GOSHEN  
HOUSEHOLDS  
JACOB  
JOSEPH  
JOURNEY

MACHPELAH  
MANASSEH  
MULTIPLIED  
NATION  
PHARAOH  
SACRIFICES

# JACOB MOVES TO EGYPT

## (GENESIS 45:17-50:26)

P V L F S K G C W X T T U X U E E V K G Q G N R I H D U S M  
 R C P V M B W V Z D L W I V M I E F B E U C M S C Z R G F Q  
 X A U I J C A C O F A B I S J S J H I Y T M Q M C C Z B Q Y  
 O L T O T D F C A H J H B B R O T H E R S N P C M S M D V R  
 S O N N A W S H K O O J R U Q G D N F U V Q L U R G Y O X X  
 L Z D R A N U A S B O A W X L J O E W W S R J R X I A N R T  
 K M R H E I T E C E A Y R H J P N E L I G N I R B F E Z B P  
 W F A I U H P R U R P K G A T Z K M J A E U D S N E H S O G  
 V M Z U E H T E N H I P T U H F E J B C T H E S S A N A M K  
 J Q E A N E O A U T A F K Q W P Y Q B L K M D J G L M F I Z  
 X S M F Q P M M F L D G I T K B S V K P M E R L B B X N U O  
 W Q D F M I J Q D U Y K W C M X A E J A U S M H I K Z X Q V  
 E V B U R M K N L W S G M P E M V V K I L Z J A V M U A H L  
 L P W T N J A C O B M P I I L S M V U E T P L L S I I D C C  
 V B Q Q A Y G L A Q U S U L A M U L M Y I J P E M U J P C Y  
 D Q X H Y B H L U V M O M J U R O A X A P H O P K X L U N Y  
 D J J A Q B G E H N E T F B G Z H I Y Q L D L H I W M K U P  
 Z I I O U P D W F O S W O J C X Z P R A I C T C R V P I K D  
 Z C T U U P V D L I U I E H V I X L E O E U P A K K P P S D  
 O T A U Q R B Y Y S E S P T U Z A R T Y D U N M Q G E R U A  
 W C L T T Y N M H V J H E N O I T A N D N S R P Y P C Q N W  
 H J B T H F G E E U M D K H B F M U T E B Y A B C H H I E Z  
 Q W Z D T O C A L V O J J J O Z Z U C S Y J P N Z K M J S C  
 I Y Z D T J Z S M G I D F Y N L B C M S Z G L S A H X L X P  
 L J N Q R W H V D U G L Y R H X D Q P E A A M L K C I J T Y  
 H T K C R S K Y O O O U T D X D T S M L M K M P R O V V I E  
 T N O U W S K K I A O O W C A K P O M B U R T H V V M R L J  
 Y E G Y P T R W R D V G U G U N C N L E E B F L Z N T R E R  
 O A B J P I E L F D S L G S V M Z R C A D N H Q Y J Q K I L  
 A S H K N A N W Y W P O H Q A Y F L S E K Y D U E L V J A P

**BLESSED**  
**BRING**  
**BROTHERS**  
**BURY**  
**CAVE**  
**COME**  
**DONKEYS**

**DWELL**  
**EGYPT**  
**EPHRAIM**  
**EVIL**  
**FATHER**  
**GOD**

**GOOD**  
**GOSHEN**  
**HOUSEHOLDS**  
**JACOB**  
**JOSEPH**  
**JOURNEY**

**MACHPELAH**  
**MANASSEH**  
**MULTIPLIED**  
**NATION**  
**PHARAOH**  
**SACRIFICES**

# JACOB MOVES TO EGYPT

## (GENESIS 45:17-50:26)

### MEMORY VERSE:

*"And we know that all things work together for good to those who love God." ROMANS 8:28*

### CIRCLE THE CORRECT WORDS:

1. "Pharaoh said to Joseph, 'Say to your brothers, 'Do this: Load your beasts and depart; go to the land of Canaan. Bring your father and your households and come to me; I will give you the (BEST, WORST) of the land of Egypt, and you will eat of the fat of the land.' " **GENESIS 45:17-18**
2. Then Joseph's brothers "went up out of Egypt, and came to the land of Canaan to Jacob their father. And they told him, saying, 'Joseph is still alive, and he is governor over all the land of Egypt.' And Jacob's heart stood still, because he did not (LIKE, BELIEVE) them." **GENESIS 45:25-26**
3. "Then God spoke to Israel in the visions of the night, and said, 'Jacob, Jacob!' And he said, 'Here I am.' And He said, 'I am God, the God of your father; do not fear to go down to Egypt, for I will make of you a great (NATION, CHARIOT) there. I will go down with you to Egypt, and I will surely bring you up again.' " **GENESIS 46:2-4**
4. "So they took their livestock and their goods, which they had acquired in the land of Canaan, and went to (EGYPT, AMERICA), Jacob and all his descendants with him." **GENESIS 46:6**
5. Now when Jacob arrived in Egypt "Joseph made ready his chariot and went up to Goshen to meet his father Israel; and he presented himself to him, and fell on his neck and (PAINTED, WEPT) on his neck a good while." **GENESIS 46:29**
6. "Pharaoh spoke to Joseph, saying, 'Your father and your brothers have come to you. The land of Egypt is before you. Have your father and brothers dwell in the best of the land; let them dwell in the land of (GOOSHIE, GOSHEN).' " **GENESIS 47:5-6**
7. "When the time drew near that Israel must die, he called his son Joseph and said to him, 'Now if I have found favor in your sight, please put your hand under my thigh, and deal kindly and truly with me. Please do not (BURY, FEED) me in Egypt, but let me lie with my fathers; you shall carry me out of Egypt and bury me in their burial place.' And he said, 'I will do as you have said.' " **GENESIS 47:29-30**

### TRUE OR FALSE:

8. "When Jacob had finished commanding his sons, he drew his feet up into the bed and breathed his last, and was gathered to his people. Then Joseph fell on his father's face, and wept over him, and kissed him." **GENESIS 49:33-50:1**

TRUE OR FALSE

9. When Joseph's brothers saw that their father was dead, they said, "Perhaps Joseph will love us, and may actually repay us for all the kind things which we did for him." **GENESIS 50:15**

TRUE OR FALSE

10. "Joseph said to them, 'Do not be afraid, for am I in the place of God? But as for you, you meant evil against me; but God meant it for good, in order to bring it about as it is this day, to save many people alive.' " **GENESIS 50:19-20**

TRUE OR FALSE

**"JOSEPH SAID TO HIS BRETHREN, '...GOD WILL SURELY VISIT YOU, AND BRING YOU OUT OF THIS LAND TO THE LAND OF WHICH HE SWORE TO ABRAHAM, TO ISAAC, AND TO JACOB.' "**  
**GENESIS 50:24**

# JACOB MOVES TO EGYPT

## (GENESIS 45:17-50:26)

### MEMORY VERSE:

*"And we know that all things work together for good to those who love God." ROMANS 8:28*

### FILL IN THE BLANKS:

1. "Pharaoh said to Joseph, 'Say to your brothers, "Do this: Load your beasts and depart; go to the land of Canaan. Bring your father and your households and come to me; I will give you the \_\_\_\_\_ of the land of Egypt, and you will eat of the fat of the land." ' " **GENESIS 45:17-18**
2. Then Joseph's brothers "went up out of Egypt, and came to the land of Canaan to Jacob their father. And they told him, saying, 'Joseph is still alive, and he is governor over all the land of Egypt.' And Jacob's heart stood still, because he did not \_\_\_\_\_ them." **GENESIS 45:25-26**
3. "Then God spoke to Israel in the visions of the night, and said, 'Jacob, Jacob!' And he said, 'Here I am.' And He said, 'I am God, the God of your father; do not fear to go down to Egypt, for I will \_\_\_\_\_ make of you a great \_\_\_\_\_ there. I will go down with you to Egypt, and I will surely bring you up again.' " **GENESIS 46:2-4**

### CIRCLE THE CORRECT WORDS:

4. "So they took their livestock and their goods, which they had acquired in the land of Canaan, and went to (**EGYPT, AMERICA**), Jacob and all his descendants with him." **GENESIS 46:6**
5. Now when Jacob arrived in Egypt "Joseph made ready his chariot and went up to Goshen to meet his father Israel; and he presented himself to him, and fell on his neck and (**PAINTED, WEPT**) on his neck a good while." **GENESIS 46:29**
6. "Pharaoh spoke to Joseph, saying, 'Your father and your brothers have come to you. The land of Egypt is before you. Have your father and brothers dwell in the best of the land; let them dwell in \_\_\_\_\_ the land of (**GOOSHIE, GOSHEN**).' " **GENESIS 47:5-6**

### FILL IN THE BLANKS:

7. "When the time drew near that Israel must die, he called his son Joseph and said to him, 'Now if I have found favor in your sight, please put your hand under my thigh, and deal kindly and truly with me. Please do not \_\_\_\_\_ me in Egypt, but let me lie with my fathers; you shall carry me out of Egypt and bury me in their burial place.' And he said, 'I will do as you have said.' " **GENESIS 47:29-30**
8. "When \_\_\_\_\_ had finished commanding his sons, he drew his feet up into the bed and breathed his last, and was gathered to his people. Then Joseph fell on his father's face, and wept over him, and kissed him." **GENESIS 49:33-50:1**
9. When Joseph's brothers saw that their father was dead, they said, "Perhaps Joseph will \_\_\_\_\_ us, and may actually repay us for all the evil which we did to him." **GENESIS 50:15**

### TRUE OR FALSE:

10. "Joseph said to them, 'Do not be afraid, for am I in the place of God? But as for you, you meant evil against me; but God meant it for good, in order to bring it about as it is this day, to save many people alive.' " **GENESIS 50:19-20**

TRUE OR FALSE

**"JOSEPH SAID TO HIS BRETHREN, '...GOD WILL SURELY VISIT YOU, AND BRING YOU OUT OF THIS LAND TO THE LAND OF WHICH HE SWORE TO ABRAHAM, TO ISAAC, AND TO JACOB.' "**  
**GENESIS 50:24**

## **Year 1**

### **Week 31**

#### **A Growing Nation and Baby Moses**

**Scriptures: Exodus 1 – 2:10**

**Key Verse: Exodus 2:10 And the child grew, and she brought him to Pharaoh's daughter and he became her son. So she called his name Moses, because "I drew him out of the water".**

#### **Key Points:**

1. The children of Israel multiplied greatly in the land of Egypt. A new Pharaoh came to power who did not know Joseph. Pharaoh feared the Israelites and made slaves of them. The Egyptians were hard taskmasters and made their lives miserable. God gave them strength, however, and they became greater still.

2. The king of Egypt spoke to the midwives of the Hebrew women and told them to kill the male babies when they were born but the Israelite midwives feared God and spared the babies. Determined to have his way, he ordered that all the male babies be cast into the river.

3. A Hebrew woman, Jochebed, gave birth to a beautiful son. She hid him 3 months to keep him from being killed. She placed him in a basket boat that floated in the Nile River, near the king's palace. Pharaoh's daughter found him and took him from the river. The baby's sister, Miriam, was watching nearby and offered to find a Hebrew woman to nurse the baby. She got the baby's mother, Jochebed, to be a nurse for the baby. The baby was named "Moses" for he was "drawn out of the water". He grew up in Pharaoh's palace.

Year 1, Week 31  
Exodus 1-2:10  
A Growing Nation and Baby Moses



**Exodus 2:10**

And the child grew, and she brought him to Pharaoh's daughter, and he became her son. So she called his name Moses, saying, "Because I drew him out of the water." (NKJV)

## NILE MAZE

Help baby Moses's basket reach Pharaoh's daughter.

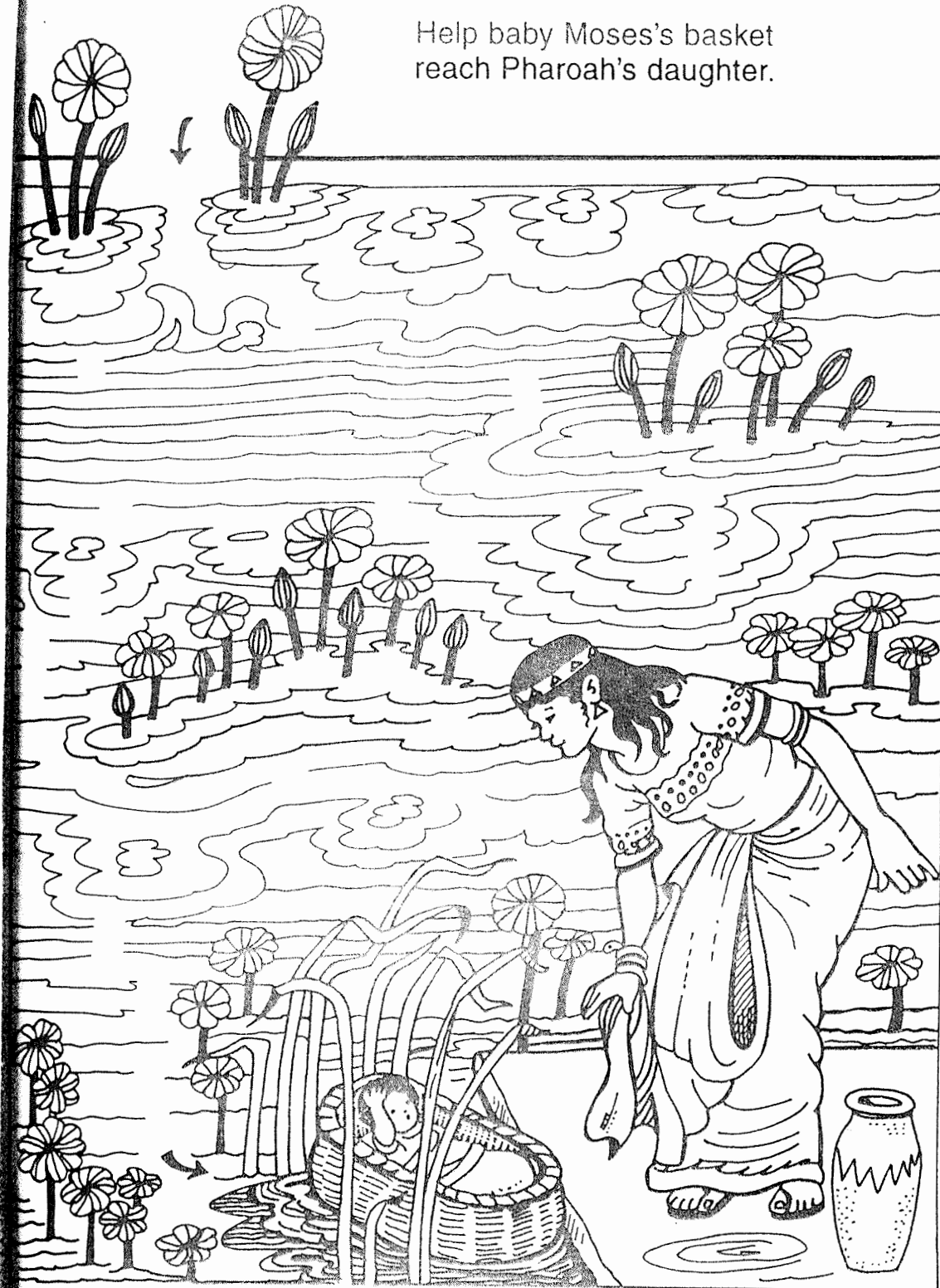





God Cares for Baby Moses  
Exodus 2



And when she had opened it, she saw the child: and, behold, the babe wept. And she had compassion on him, and said, "This is one of the Hebrews' children."

*Exodus 2:6*

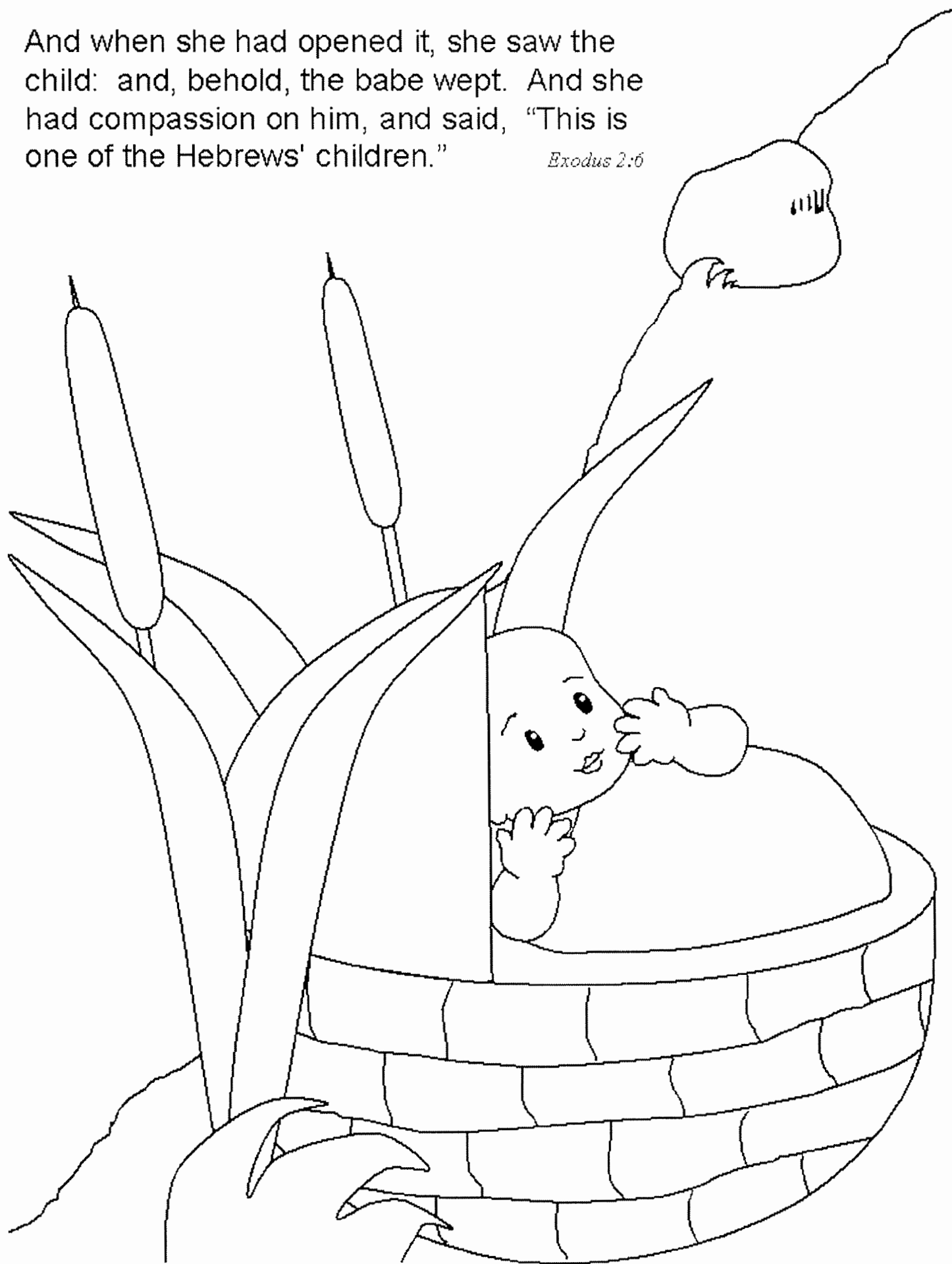

Pharaoh's daughter finds Moses  
in his basket of reeds and cares  
for him as her own. *Exodus 2:1-10*





the years went by, a new Pharaoh became the ruler of Egypt. He did not like the great number of Israelites living within his domain.

Because the Israelites kept multiplying, the new Pharaoh commanded all male Israelite infants be destroyed. The baby Moses was hidden in a basket and placed on the river

# Baby in a Basket

Exodus 2:1-10

## Materials needed:

Small Styrofoam tray

Tagboard

Felt-tip pens—permanent ink

Brass paper fastener

Cloth—about 10-inch square



## Directions:

Cut two babies and two arms (patterns on page 23) from tagboard and glue bodies together and arms together. Color baby and arm. Attach arm with the brass paper fastener. Color bottom of "basket" with permanent-ink pen. Cut a handle from tagboard, 11 inches long and  $\frac{3}{4}$  inch wide. Color and staple or tape to basket. Wrap baby in blanket and put his little arm out to hold blanket in place. Put in the basket. Have a large pan of water to float basket in as you tell the story.

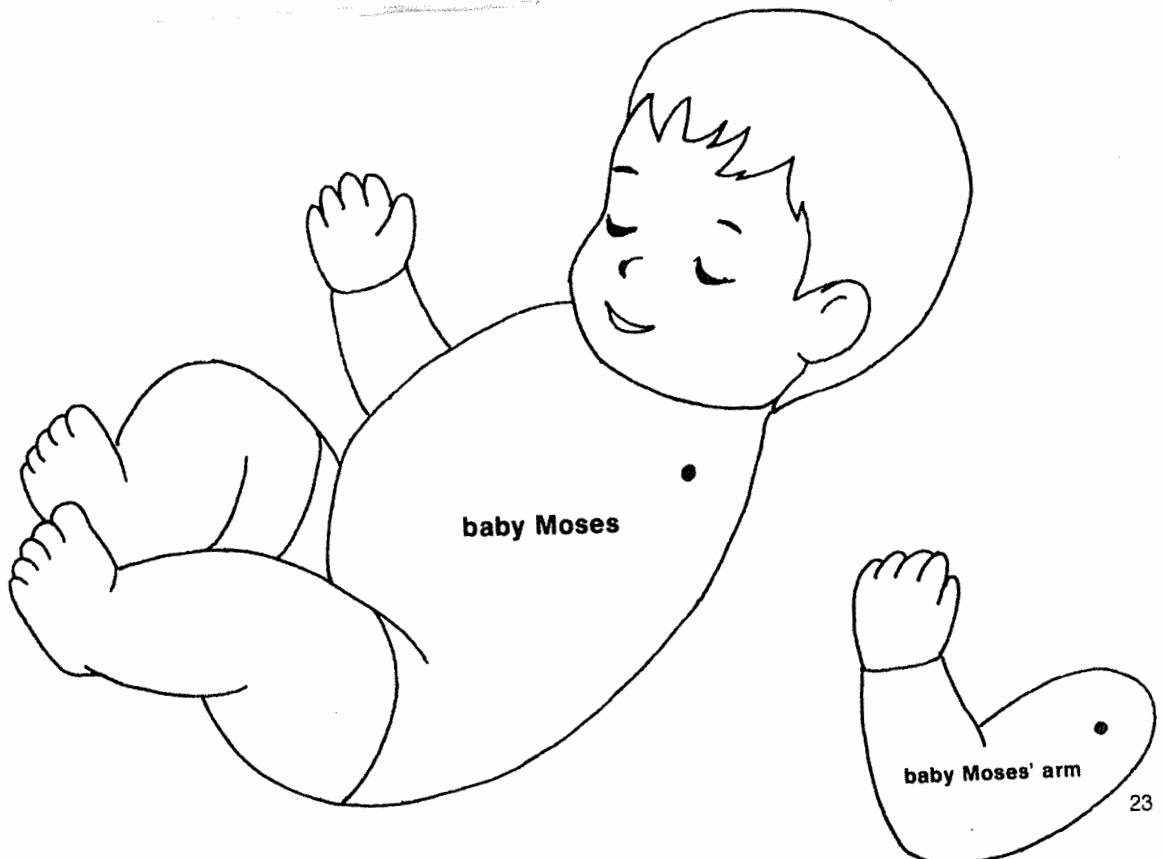

## Moses activities for younger class

Can you?

...hop like a rabbit?

...jump like a frog?

...walk like a duck?

...run like a dog?

Stand straight and tall

Making no sound at all

Shhhhh----

---

God cares for you.

Cut out magazine pictures of parents, grandparents, brothers, sisters, babysitters, teachers. Make a collage or a mobile with the pictures.

Ask, "which pictures remind you of a person who helps and cares for you?"  
Thank you God for (name person) who cares for (child's name).

---

Hidden Basket

Place a doll inside a small basket. Hide the basket, and give clues to its location. Ex. The basket is hidden by something green, the basket is hiding by a table, etc.

Our Bible story today is about a baby names Moses who was hidden in a special place. See if you can find a baby doll hidden in a basket in our classroom.

---

Leaving Egypt

One or two small suitcases and items such as comb, toothbrush, map, socks, robe. Have children place items in case and carry it around the room. Ask, "If you were going on a trip, what would you pack in your suitcase?"

Our story today is about the Israelites who traveled on a long, long trip. God took care of the people while they traveled. How does God take care of you when your travel on a trip?

# Moses Maze

Help Pharaoh's daughter find baby Moses.

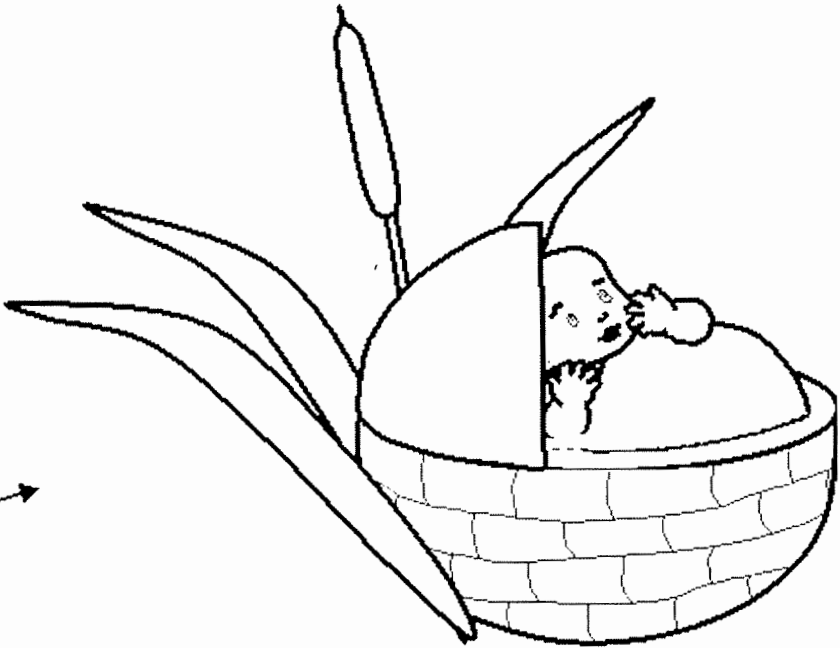
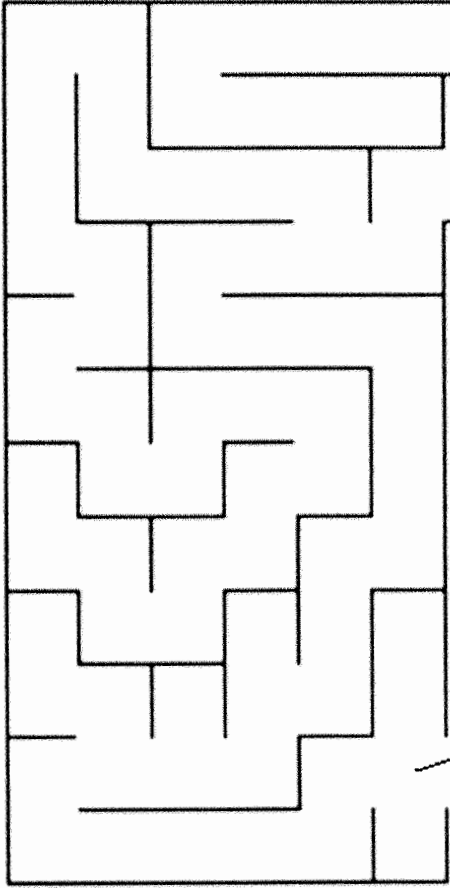
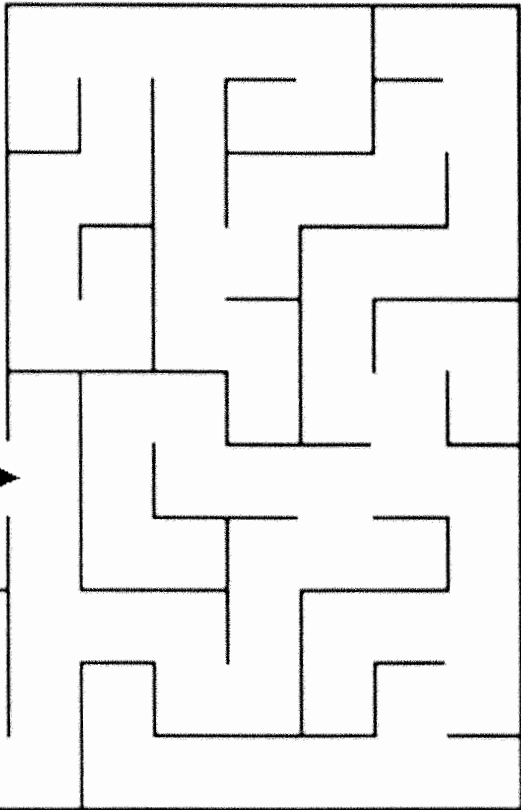
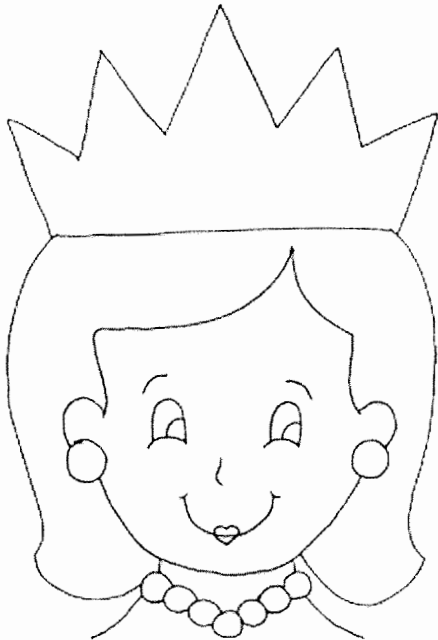



# M is for

# Moses

Write Moses above.

The life of Moses is a remarkable story of God's plan to save His chosen people Israel. The story of Moses begins in your Bible: Exodus chapter 1.

Use the dotted lines and squares to finish the picture of baby Moses.

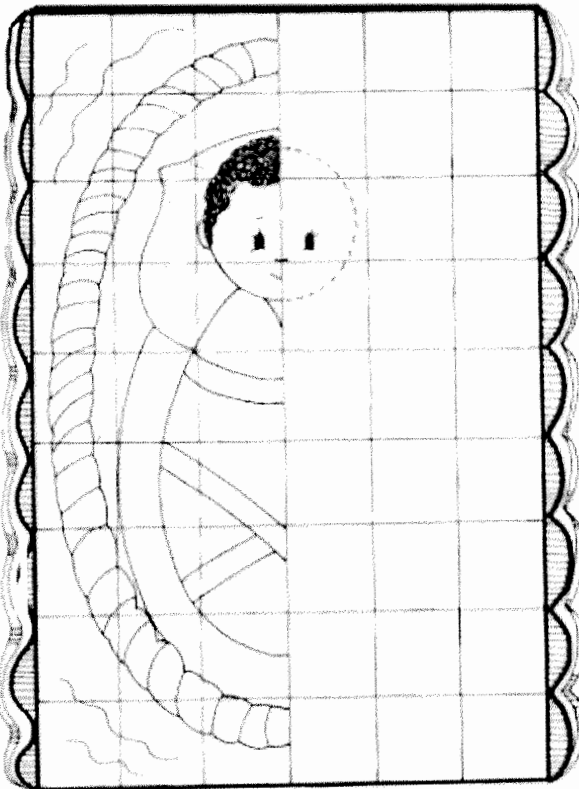

Color baby Moses and his sister Miriam.  
[www.calvarywilliamsport.com/kids-index.html](http://www.calvarywilliamsport.com/kids-index.html)

# GENESIS 41

NRGIA

DOLT

TANRESV

INEFAM

OGD

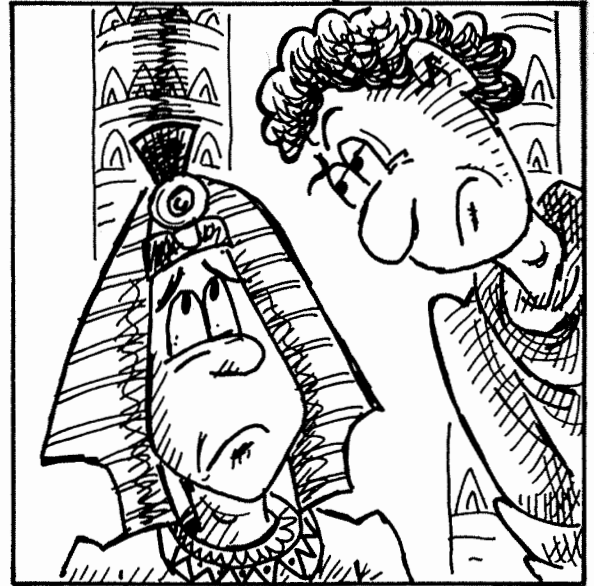

JOSEPH HELPED THE PHARAOH BECAUSE HE COULD:

HIS

# EXODUS 1-2:10

KETBAS

ILYMAF

GINK

DLOER

YIGNRC



WHERE PHARAOH'S DAUGHTER FOUND MOSES:

IN A

## Key

### Genesis 41

Grain	R
Told	D
Servant	S E R A
Famine	A M E
God	D

### READ DREAMS

### Exodus 1

Basket	B A T
Family	F
King	I N G
Older	O L
Crying	C R I

### FLOATING CRIB

# MOSES IS BORN

(EXODUS 2:1-10)

M O T H E R L U P H  
P A E R O M D D H E  
Q T C I L F F A A B  
L S E S O M Y Y R R  
Q M M O N T H S A E  
R E T H G U A D O W  
F D E L L I F G H I  
G M A R I V E R T P  
F R U I T F U L I G  
K A O R E T T I B C

AFFLICT  
ARK  
BITTER  
DAUGHTER

FILLED  
FRUITFUL  
HEBREW

MONTHS  
MORE  
MOSES

MOTHER  
PHARAOH  
RIVER

HELP MOSES'S ARK FIND ITS' WAY TO THE PHARAOH'S DAUGHTER

Moses →

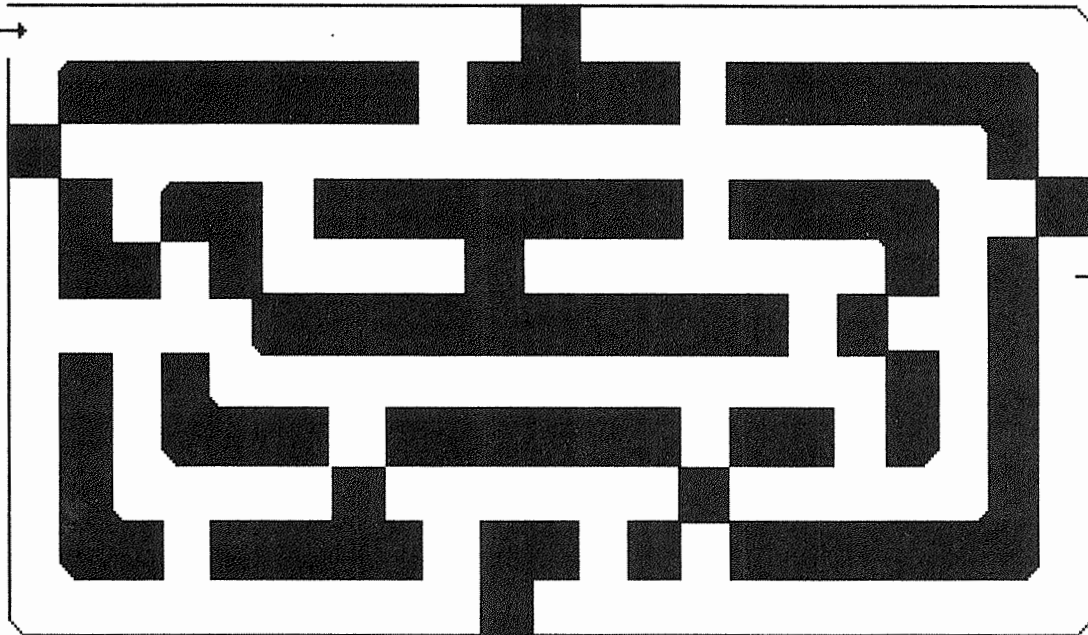

→ Pharaoh's  
Daughter

# Moses Word Search

J F B U S H F Y

T F F A T S R B

H S N E T Z O A

B A S K E T G B

baby  
basket  
bush  
frog  
staff  
ten

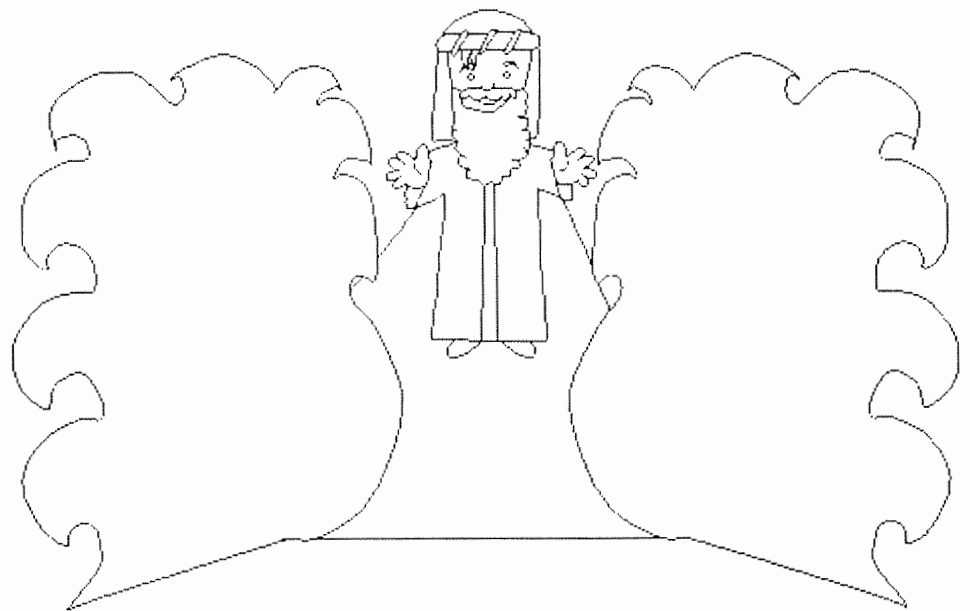

# Moses Word Search

E K A N S A M U G N N I Q R P  
T N E M D N A M M O C S M E R  
F I R S T B O R N I D R I V E  
S S E N K R A D D T O A R O D  
S H E P H E R D P C O E A S A  
M I R I A M Y T L E L L C S E  
H O A R A H P A A T B I L A L  
N O R A A Y C E G O D T E P C  
U V O G G C Y S U R S E S O M  
P N R E S L A V E P F L I E S

Aaron  
blood  
commandment  
darkness  
Egypt  
firstborn  
flies  
Israelite  
leader  
miracle

Miriam  
Moses  
Passover  
Pharaoh  
plague  
protection  
sea  
shepherd  
slave  
snake

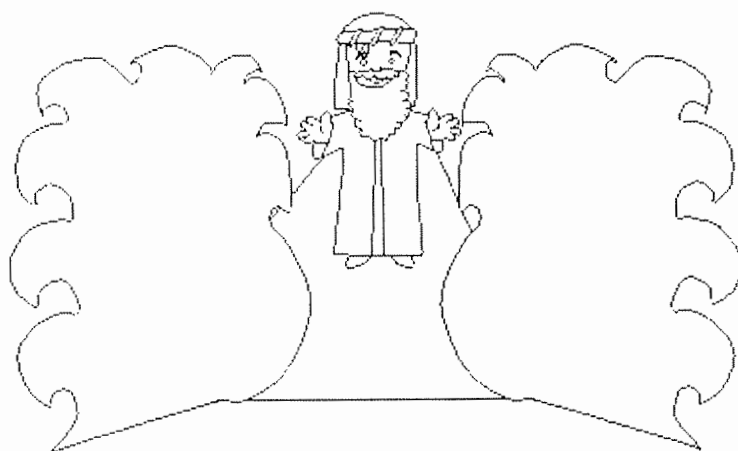

# Baby in a Basket

Read Exodus 2:1-10 about an important child. To solve the puzzle, first work the math problems. Then, beginning with the square that contains the answer 1, write the words in order on the lines below.

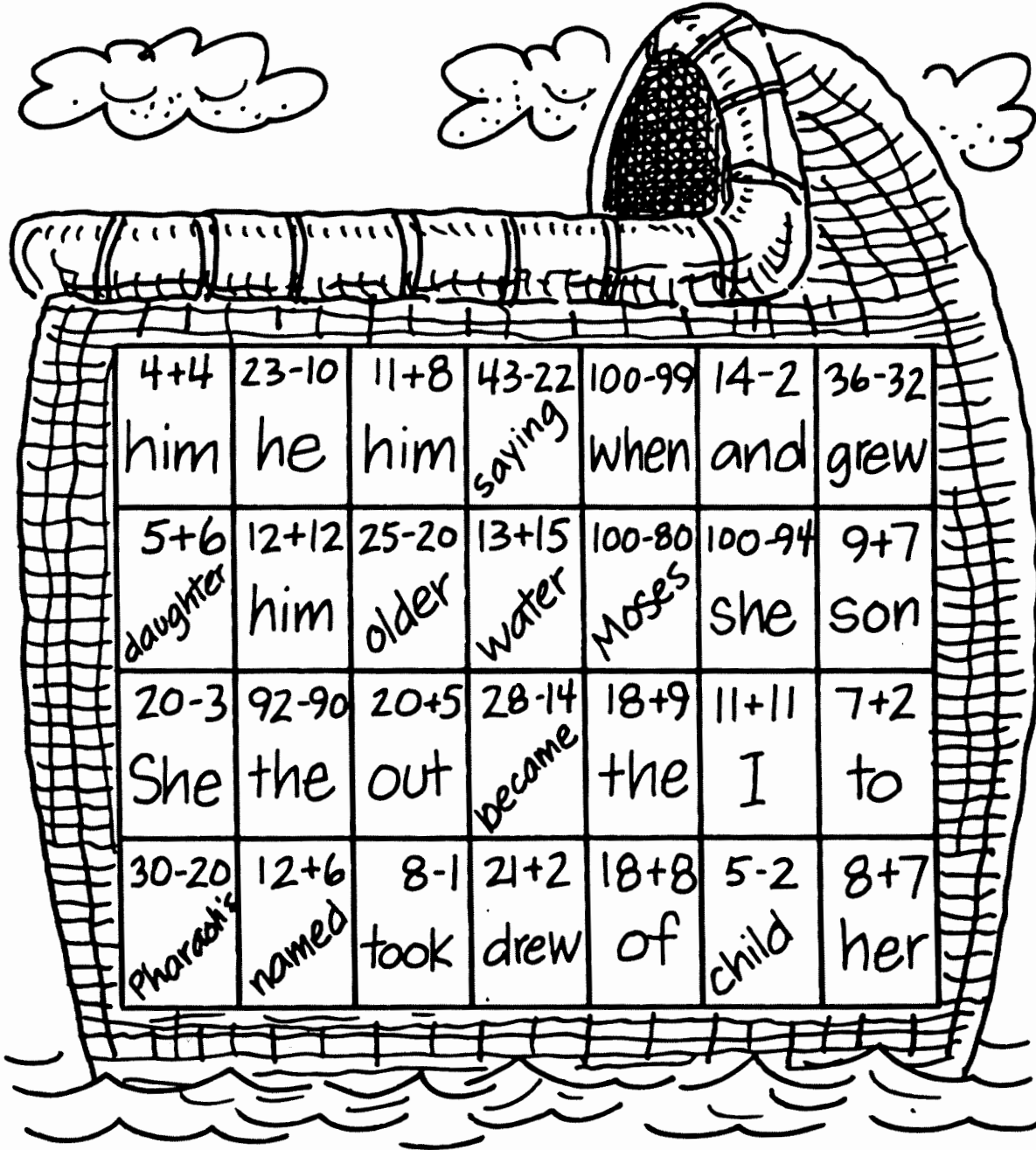

---



---



---

# 40

## MOSES

- AARON
- BASKET
- BRICKS
- CHARIOTS
- COMMANDMENTS
- CURTAIN
- EGYPTIANS
- HEBREWS
- HORSES
- LAMB
- LOCUSTS
- NILE
- PASSOVER
- PHARAOH
- PILLAR
- PLAGUES
- PRIESTHOOD
- SABBATH
- SACRIFICE
- SINAI
- SMOKE
- STAFF
- SWARMS
- TABERNACLE
- WILDERNESS

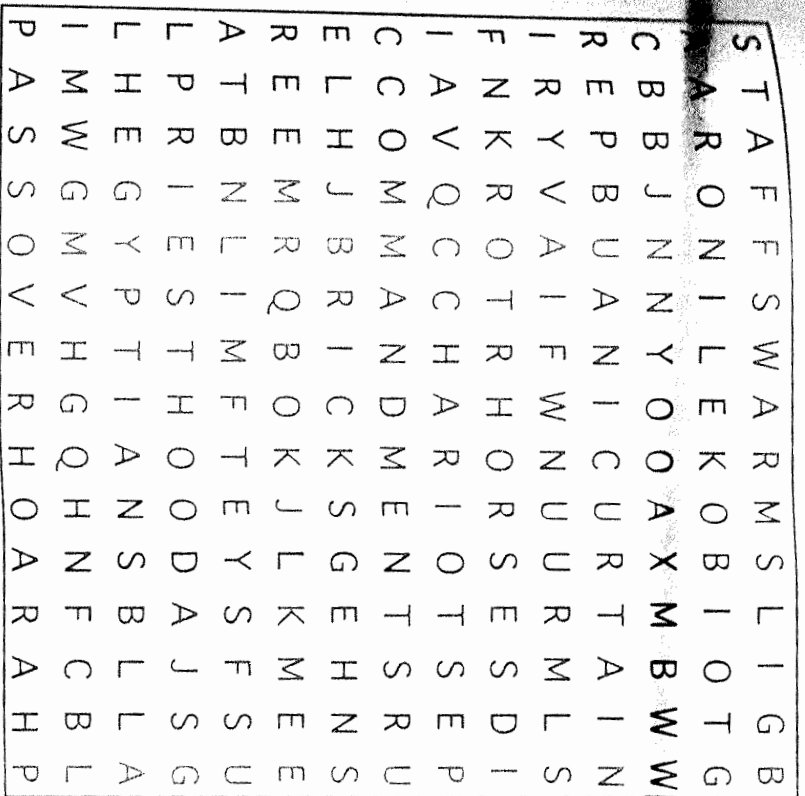

### Bonus Trivia

Finish the beatitude, "Blessed are the poor in spirit—"

"For theirs is the kingdom of heaven."  
Matt. 5:3.



# TOWER POWER

THE ISRAELITES WERE SLAVES TO THE PHARAOH, WHO FORCED THEM TO MAKE BRICKS FOR BUILDING CITIES. CAN YOU FIND THE FOLLOWING THINGS HIDDEN BELOW? "ISRAEL" (11 TIMES) "MOSES" (3 TIMES) "AARON", THE NUMBER 10, A FLY, A FROG, A SWORD, A FISH AND A SNAKE? • EXODUS 1:8-14



# Baby Moses

Now the Israelites prospered and grew in population while living in Egypt. After a long time a new king who did not know about Joseph came to power. He made the Israelites work hard at slave labor. The Pharaoh (Egyptian King) was worried about the Israelites becoming too strong and so he gave an order to all his people:

"Every (Israelite) boy that is born you must throw into the Nile."

Read Exodus 2 (NIV) to see how a baby named Moses was saved.

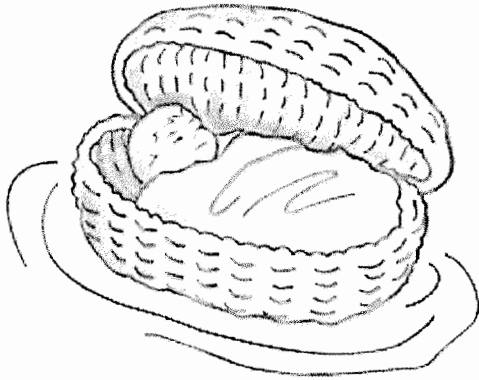

## Across:

1. The baby was placed in a \_\_\_\_\_ by his mother.
5. After Moses was born his mother hid him for three \_\_\_\_\_.
7. Pharaoh's daughter adopted the baby and named him \_\_\_\_\_.

## Down:

2. Pharaoh's \_\_\_\_\_ found the baby in the basket.
3. The basket with the baby was place among the reeds along the \_\_\_\_\_ river.
4. The basket was coated with \_\_\_\_\_.
5. The babys sister got her \_\_\_\_\_ to nurse the baby for Pharoah's daughter.
6. Moses \_\_\_\_\_ watched to see what would happen to her baby brother.

Read vs. 10 to see why Pharaoh's daughter named the baby Moses.

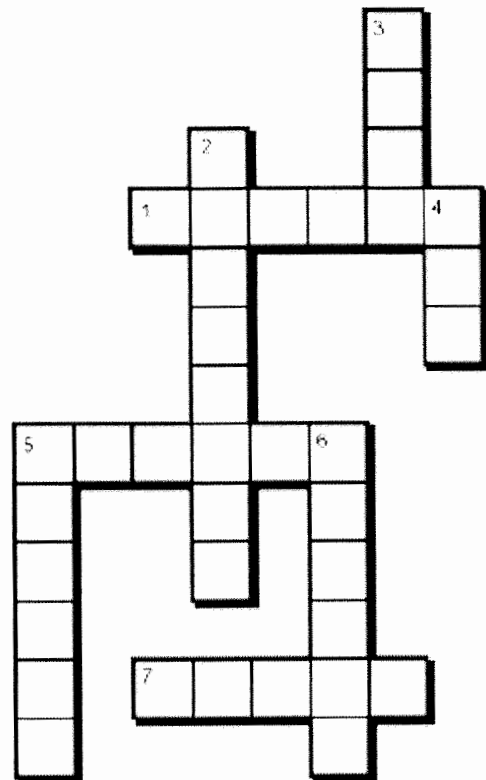

# THE SLAVERY OF THE ISRAELITES

(EXODUS 1:1-14; 2:23-24)

U R E T T I B M A P C B Z R T  
Q F N N L V A X N M Q R Z P F  
S O M S G B Q T M L I B K I A  
S P H Z R Q F Y R E E G C Q Y  
I E T C I L F F A A I A H D Y  
L O L K Q Y H L M S T K R T O  
E O D B I E P F F G W R T S Y  
G C R Z P L J I R D Z E O J I  
Y T N A N E V O C U P F R M F  
P F E F H N T O H E I O I Q V  
T K U H Z K B V A P G T O R M  
S B W N I V C Q W I K J F I S  
B O N D A G E I R Z Q T T U V  
J Y J G V Q I Z R C J E A L L  
F G N I K T A U X B B J N S M

AFFLICT  
BITTER  
BONDAGE  
BRICK

COVENANT  
EGYPT  
FRUITFUL  
ISRAEL

KING  
MIGHTY  
MORTAR  
RIGOR

*"Come to Me, all you who labor and are heavy laden, and I will give you rest."*  
MATTHEW 11:28

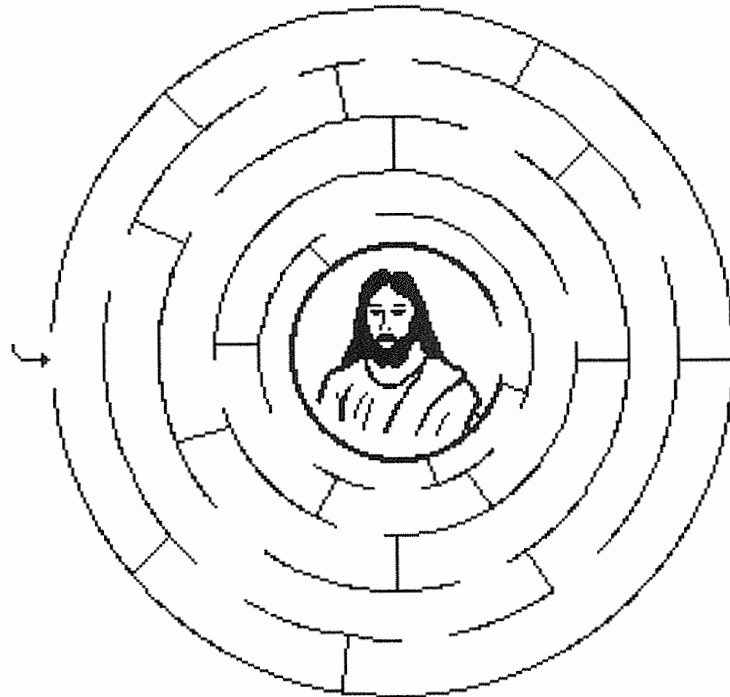

# THE SLAVERY OF THE ISRAELITES

## (EXODUS 1:1-14; 2:23-24)

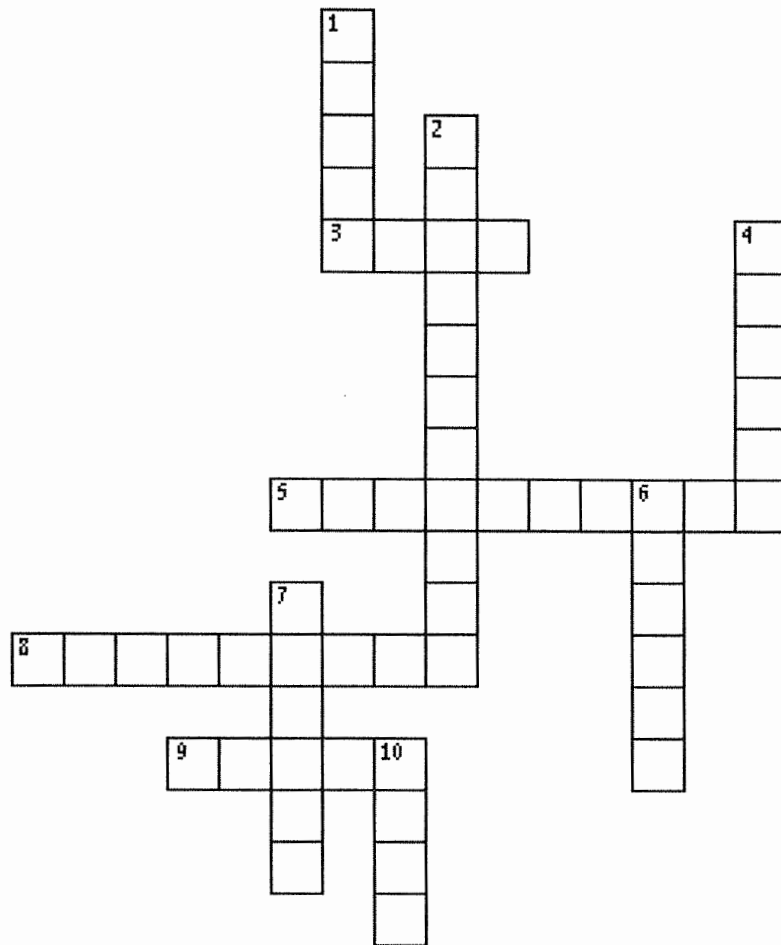

- 3 ACROSS "Come to Me, all you who labor and are heavy laden, and I will give you \_\_\_\_." **MATTHEW 11:28**
- 4 DOWN "The children of Israel were fruitful and increased abundantly, multiplied and grew exceedingly mighty; and the land was \_\_\_\_ with them." **EXODUS 1:7**
- 10 DOWN "Now there arose a new \_\_\_\_ over Egypt, who did not know Joseph." **EXODUS 1:8**
- 6 DOWN The king "said to his people, 'Look, the people of the children of \_\_\_\_ are more and mightier than we.'" **EXODUS 1:9**
- 2 DOWN "They set \_\_\_\_ over them to afflict them with their burdens." **EXODUS 1:11**
- 7 DOWN "They built for Pharaoh supply \_\_\_\_, Pithom and Raamses." **EXODUS 1:11**
- 5 ACROSS "But the more they afflicted them, the more they \_\_\_\_ and grew." **EXODUS 1:12**
- 8 ACROSS "So the \_\_\_\_ made the children of Israel serve with rigor". **EXODUS 1:13**
- 9 ACROSS "And they made their lives bitter with hard bondage- in mortar, in \_\_\_\_, and in all manner of service in the field." **EXODUS 1:14**
- 1 DOWN "All their service in which they made them serve was with \_\_\_\_." **EXODUS 1:14**

**Year 1**

**Week 32**

## **Moses Runs Away**

**Scriptures: Exodus 2:11 - 25**

**Key Verse: Exodus 2:11** Now it came to pass in those days, when Moses was grown, that he went out to his brethren and looked at their burdens. And he saw an Egyptian beating a Hebrew, one of his brethren.

### **Key Points:**

1. Moses is grieved by the burden of the Israelites and how they were treated. When he witnessed an Egyptian hitting a Hebrew, one of his brethren, he killed him and hid him in the sand. He did not know anyone saw him.

2. On another occasion, he interrupted a fight between two Hebrew men. Moses tried to stop this but was confronted about him killing the Egyptian. The man asked if he would kill him like he did the Egyptian.

3. Moses fled to the land of Midian to hide from Pharaoh, he wanted to kill Moses for what he had done. The priest of Midian, Jethro, had 7 daughters and Moses stayed there and helped them water their father's sheep. He lived with Jethro's family and married one of his daughters, Zipporah. They had a son, Gershom, which meant "stranger there".

4. The Pharaoh died but the children of Israel still groaned because of the hard work they had to do in Egypt. God heard them and remembered His covenant made to their forefathers.

Year 1, Week 32  
Exodus 2:11-25  
Moses Runs Away

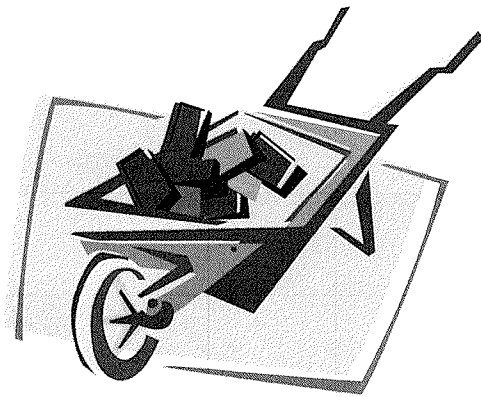

**Exodus 2:11**

Now it came to pass in those days, when Moses was grown, that he went out to his brethren and looked at their burdens. And he saw an Egyptian beating a Hebrew, one of his brethren. (NKJV)

Complete this picture by drawing the missing person. Then color the picture.

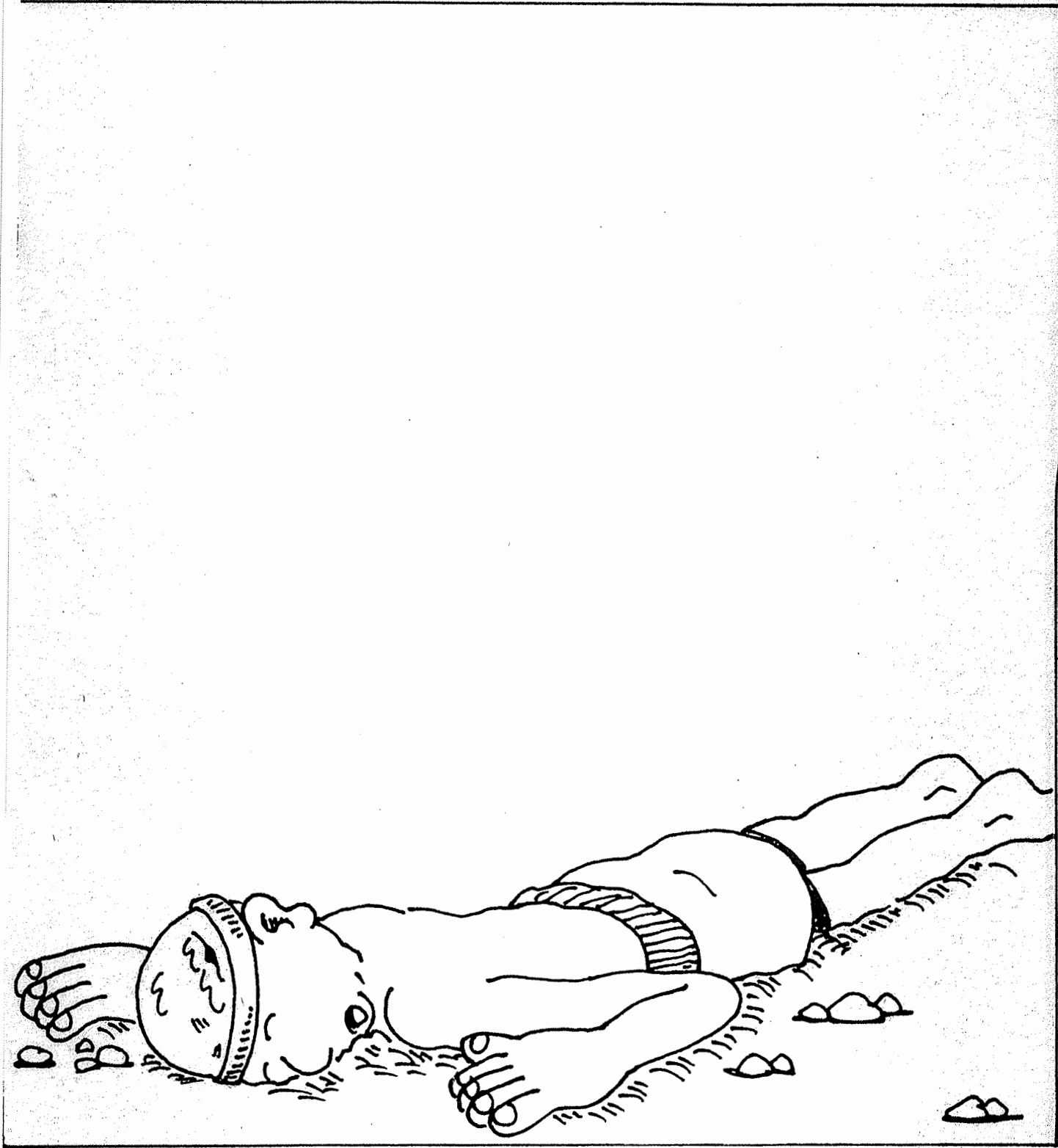

One day Moses killed an Egyptian that was beating a Hebrew slave. Then he ran to hide in Midian.



Moses flees to the land of Midian.







# Moses Delivers Jethro's Daughters

## Exodus 2:15-22

Now the priest of Midian had seven daughters; and they came to the well to draw water, and fill the troughs to water their father's flocks. Then shepherds came and drove them away, but Moses stood up and helped them, and watered their flock.





When Moses was grown he went to Midian. At a well Moses chased away some bad men and helped seven sisters water their sheep. *Exodus 2:15-20*

Now Moses kept the flock of Jethro  
his father in law, the priest of  
Midian: and he led the flock to the  
backside of the desert, and came  
to the mountain of God, even to  
Horeb.

*Exodus 3:1*

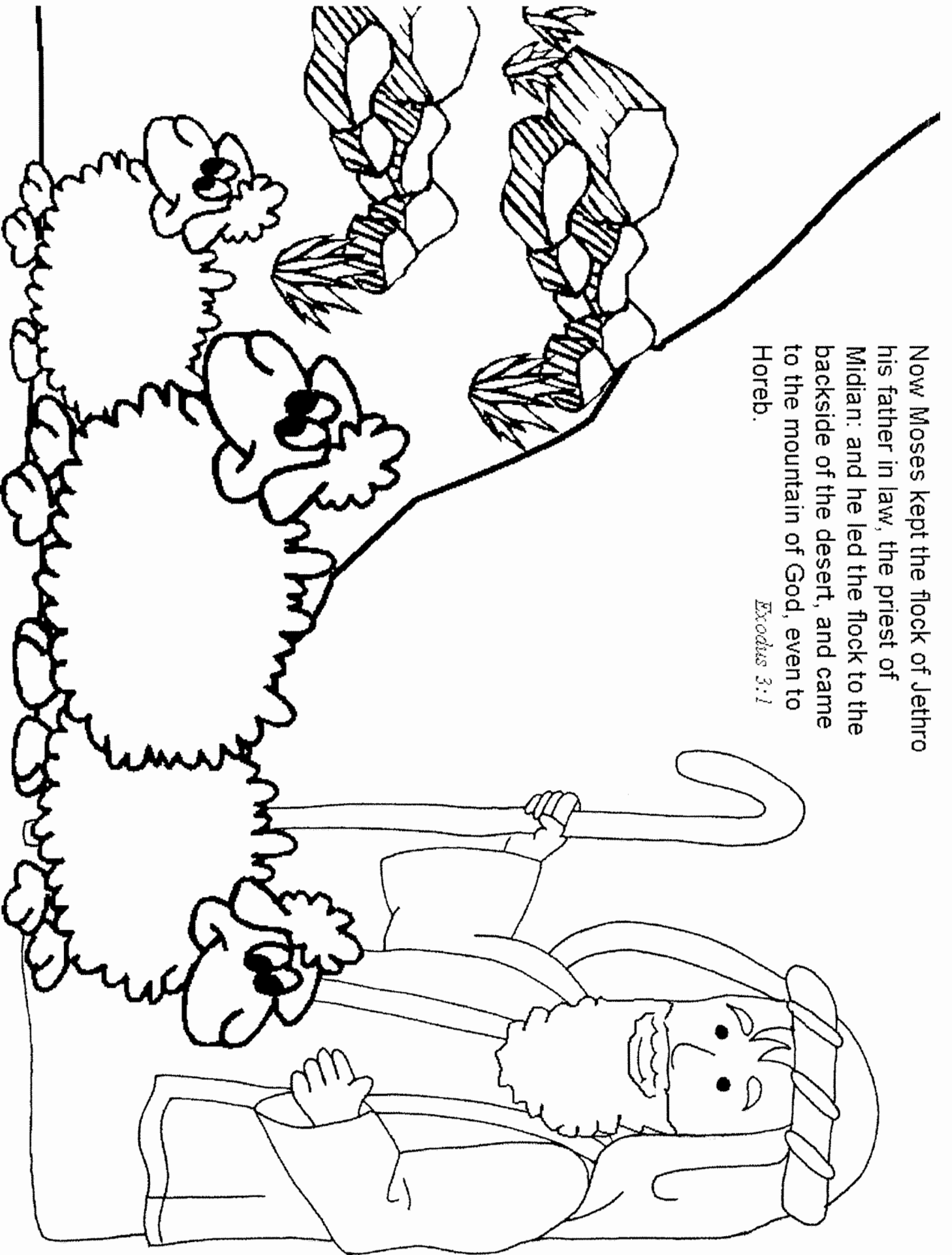

# Moses

## Puzzle Eighty-nine

AARON  
 ADOPTED  
 BABY BOYS  
 BASKET  
 BURNING BUSH  
 CANAAN  
 CHARIOTS  
 CHOSEN people  
 CODE  
 Ten  
 COMMAND-  
 MENTS  
 DEUTERONOMY  
 EGYPT  
 EXODUS  
 FORTY days  
 GENESIS  
 GOLDEN calf  
 ISRAELITES  
 KING  
 LAWS  
 LEADER  
 LEVITICUS  
 Mount NEBO  
 NILE  
 NUMBERS  
 PALESTINE

I	C	E	L	C	A	N	R	E	B	A	T	P	Y	G	E
X	C	O	F	B	O	B	G	C	T	F	L	R	B	L	F
P	H	I	D	M	N	M	A	E	Y	R	E	V	A	L	S
T	A	B	L	E	T	S	M	B	N	E	I	W	S	R	L
K	R	L	D	S	H	W	Y	A	Y	E	S	B	K	E	E
N	I	L	E	H	N	E	G	T	N	B	S	H	E	D	V
G	O	P	A	S	S	O	V	E	R	D	O	I	T	S	I
G	T	D	E	U	T	E	R	O	N	O	M	Y	S	E	T
E	S	R	D	B	C	I	T	A	Z	G	F	E	S	A	I
N	E	E	E	G	N	T	N	I	A	P	N	S	N	X	C
A	H	H	T	N	E	B	P	E	L	R	R	I	B	T	U
A	S	P	P	I	B	P	X	A	E	E	E	D	K	G	S
N	U	E	O	N	O	O	G	D	B	X	A	D	F	B	V
A	R	H	D	R	D	U	L	M	H	O	A	R	A	H	P
C	I	S	A	U	E	I	U	P	I	A	N	I	S	E	A
U	H	H	S	B	W	N	E	S	O	H	C	N	B	I	L

PASSOVER lamb  
 PHARAOH  
 PLAGUE  
 RED SEA  
 RUSHES  
 SHEPHERD  
 Mount SINAI

SLAVERY  
 TABERNACLE  
 TABLETS  
 TRIBES  
 WILDERNESS  
 ZIPPORAH

## Moses leaves Egypt

### To Remember:

- God solves problems His way, not ours

### Vocabulary

- **shepherd:** person who guides and protects animals

**Lesson** Exodus 2:11-22

### Discussion points:

- Moses reacted in a very human way to the cruelty and injustice he saw. But his way did not accomplish anything. It even made him a murderer in the eyes of the people he was trying to protect. God's ways are not like ours, but they work. We must submit to his ways of doing things.
- Moses looked like someone in the perfect position to help the Israelites. But he threw it away by taking revenge himself. God was still able to use him, but had to give Moses time to grow out of his anger, pride, and lack of dependence on God.

**Sing:** Father Abraham had many sons

**Activity:** Pick one student to act out a shepherd. Have the other students act like sheep. Tell them that sheep tend to get lost, get attacked, and forget instructions quickly. Have the shepherd try to keep the sheep together. You be a wolf trying to attack the ones far away. Then discuss how this job trained Moses to be a leader, protect the weak, and deal with misbehaving sheep.

### True or False

1. Moses identified himself with the Israelites. T
2. God had forgotten the Israelites. F
3. God approves of murder when a situation is unfair. F
4. Moses lost his influence in Egypt by killing the Egyptian. T

### Memory Work:

**Exodus 2:15a** When Pharaoh heard of it, he sought to kill Moses. But Moses fled from Pharaoh. He settled in the land of Midian.

**Review Questions** for Moses gameboard



linguistic questions

1. What does a shepherd do? protects and cares for animals.
2. Name Moses' new family. Zipporah and Jethro
3. Unscramble: phedsehr



activity questions

1. Act out Moses helping Zipporah water her flock.
2. Draw a sheep or goat.
3. Find Midian on a map.



## emotion questions

1. What feeling drove Moses to kill the Egyptian? anger
2. What feeling caused Moses to flee Egypt? fear for his life
3. What feeling caused Moses to help Zipporah? compassion



## application questions

1. When God's ways are taking too long, should we use our own methods to accomplish justice? no
2. How can a single mistake of anger (or desire) take away future opportunities for good? (if we steal or hurt people, we can lose their trust, job opportunities, and influence on others)
3. What can we learn from the consequences of our mistakes? (patience, how to build trust, how easy it is to make mistakes, how to help others recover from mistakes....)



## fact questions

1. Why did Moses flee Egypt? the pharaoh wanted to kill him for killing an Egyptian
2. What did Moses do after that? tended flocks for Jethro, priest of Midian
3. Who did Moses marry? Zipporah, Jethro's daughter



## review questions

1. How could Moses have helped Israel as the son of a pharaoh? He could have influenced pharaoh or become a leader himself someday.
2. How did God train Moses out of his temper and pride? He made him a lowly shepherd for 40 years.
3. What emotion did Moses show both to the Israelites and Zipporah? compassion and a desire to help.

**Copyright:** Sunday School Sources at eBibleTeacher.com © 2000-2008

Papyrus Document & Design All rights reserved. [Read our usage terms and ad policy.](#)

NETFLIX

Rent *(500) Days of Summer* today!

Watch Movies From Netflix  
**FREE TRIAL!**

Click here



# **Year 1**

## **Week 33**

### **God Calls Moses through a Burning Bush**

**Scriptures: Exodus 3 and 4**

**Key Verse: Exodus 3:5 Then He said “Do not draw near this place. Take your sandals off your feet, for the place where you stand is holy ground.”**

#### **Key Points:**

1. Moses led Jethro’s flock into the desert and came to Mt. Horeb, the mountain of God. The Angel of the Lord appears from a bush that was burning with fire. God calls to him by name as Moses turned to look where the fire was coming from. He tells Moses to take off his sandals for he was standing on holy ground. Moses hid his face as he heard the voice of God for he was afraid to look upon God.

2. God tells Moses that he has heard the cries of his people and has come to deliver them out of the land of Egypt. He wants to use Moses as his representative to go to Pharaoh. Moses felt unable to do the job God wanted him to do. God tells him that he will be with him, that he should say that, “I AM” has sent him. This is the Hebrew name YHWH (Jehovah) translated here as “I AM”.

3. Moses is to go to Pharaoh with the elders of Israel and tell him to let His people go. Moses worries he is slow of speech and cannot talk to Pharaoh. God gave Moses mighty deeds to show Pharaoh; a rod turns into a snake, a hand becoming leprous, water turned to blood. He warns Moses to use all the deeds he has given him. Aaron is sent with him to help Moses speak.

4. God tells Moses he will harden Pharaoh’s heart so that he will by no means let the people go. The elders of Israel will see all the signs Moses does and bow their heads to worship the Lord. It was hard for Moses, but he trusted that God would provide the power to do what was asked.



SAVING IN EGYPT: GOD TURNED MOSES' ROD INTO A SNAKE THAT HE COULD FREE THE PEOPLE FROM

...TURNED MOSES' STAFF INTO A SNAKE AS A SIGN TO MOSES THAT HE COULD FREE THE PEOPLE FROM



Moses became a shepherd in Midian. One day, God spoke to him from a burning bush. God told Moses to go back to Egypt to help his people.

*Exodus 3:1-10*

# I Am That I Am.

*Exodus 3:14*

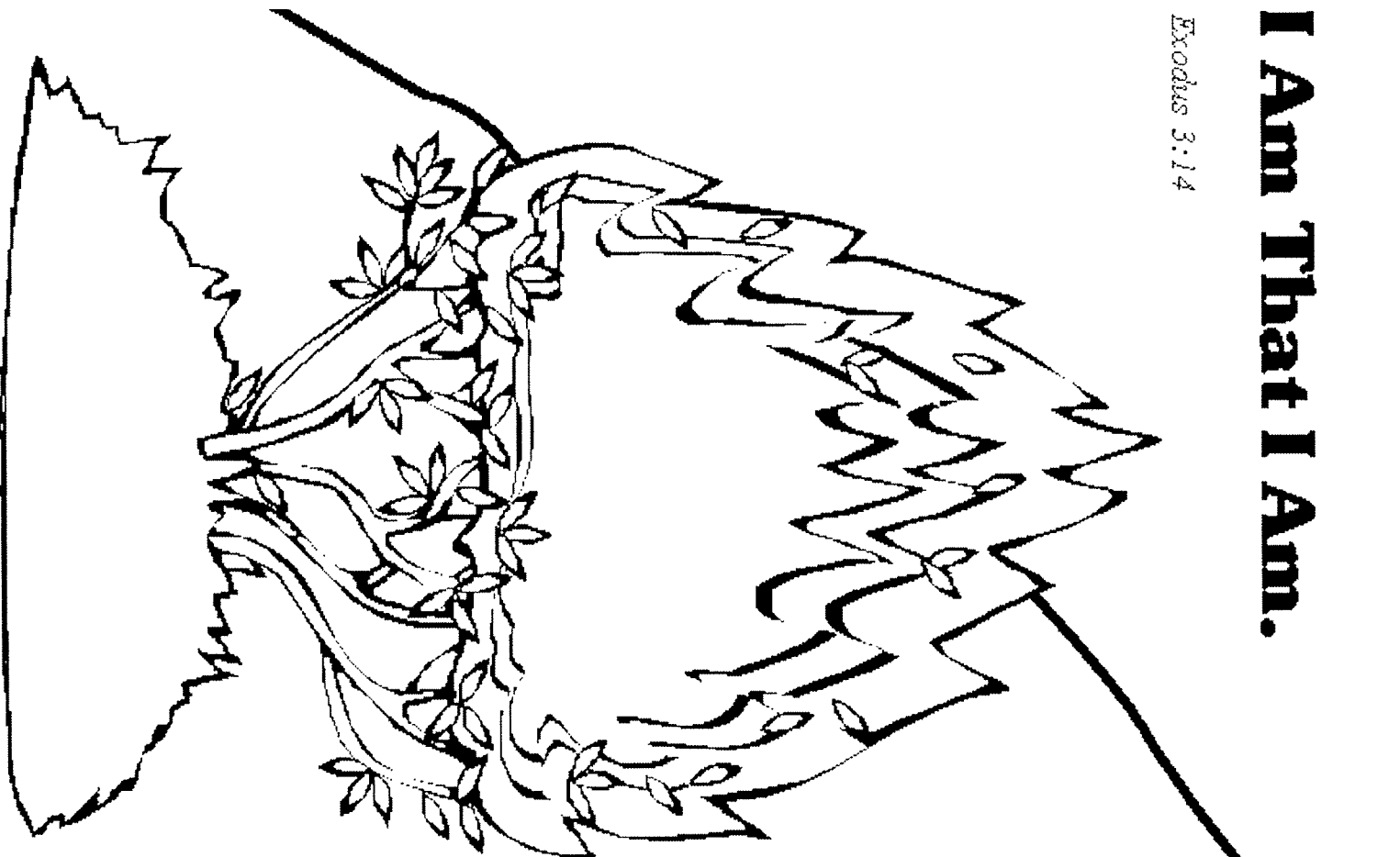



# \* Barefoot Before God \*



## Memory Verse

"Do not come any closer," God said. "Take off your sandals, for the place where you are standing is holy ground."

~ Exodus 3:5

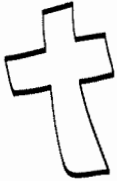

## Bible Truth

God calls me to serve Him.



## Bible Story

God talks to Moses through a burning bush. (Exodus 3)

## What You Need



- \* page 22
- \* tempera paints
- \* paint smocks
- \* tape
- \* felt, 9" x 12" sheets
- \* chenille stems
- \* yarn
- \* shallow pans

## What to Do



1. Give each child a pattern page.
2. Tell the story of Moses and the burning bush, from Exodus 3.
3. Say, God called to Moses to remove his sandals. When we approach God, we should remember that it is a privilege to talk to and hear from God. Our "Barefoot Before God" plaques will remind us that God calls each of us to serve Him.
4. Have each student cut the oval from the pattern page and glue it to a 9" x 12" piece of felt.
5. Show how to fold over 1" of the top of the felt toward the back, and glue or staple it to secure.
6. Have each child thread a chenille stem through the opening of the folded felt, and bend down the ends.
7. Show how to tie each end of a two-foot length of yarn to either end of the chenille stem to form a hanger.
8. Have each child make a fist, then press the end of the fist into the paint and onto the plaque. Show how to put small fingerprints above the print for toes. Repeat for the other "foot."



## Before class



Duplicate a pattern page for each child. Pour tempera paints into shallow pans. Men's old shirts work well for paint smocks.

**"Do not come any closer," God said.**

**"Take off your sandals, for the place where you are standing is holy ground." ~Exodus 3:5**

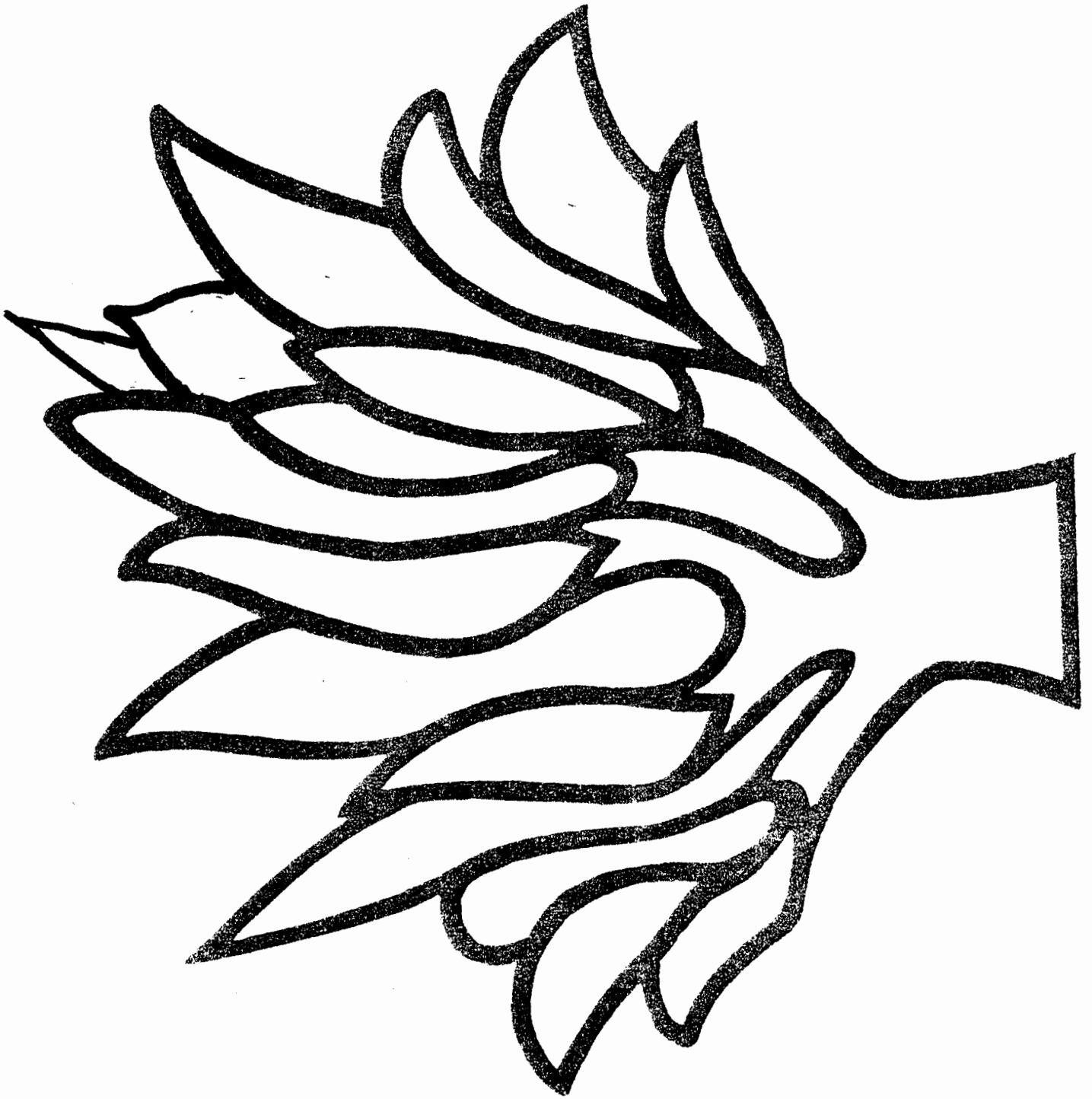



# HIDDEN PICTURE



Color the spaces that contain one dot.

# COLOR BY NUMBER MOSES

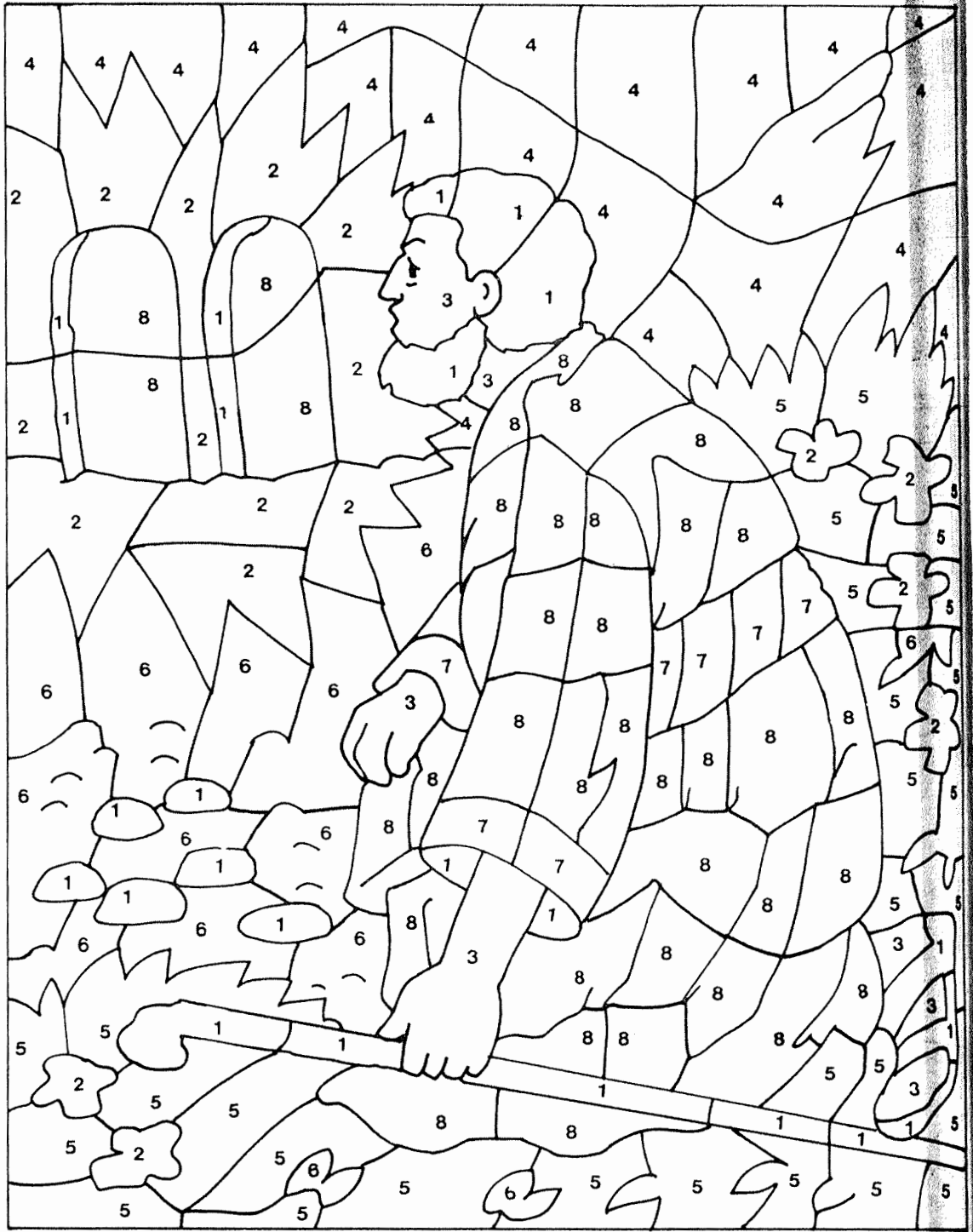

1—brown 2—yellow 3—tan 4—blue  
5—dark green 6—light green 7—red 8—orange

# Exodus 3:3-5

Fill in the blanks New King James Version

So Moses thought, "I will go \_\_\_\_\_ and  
see this \_\_\_\_\_ sight—why the  
\_\_\_\_\_ does not \_\_\_\_\_ up."

When the \_\_\_\_\_ saw that he had gone  
over to look, \_\_\_\_\_ called to him from  
within the bush, " \_\_\_\_\_! \_\_\_\_\_!"

And Moses said, " \_\_\_\_\_ I am."

"Do not come any \_\_\_\_\_," God said.

"Take off your \_\_\_\_\_, for the place  
where you are \_\_\_\_\_ is  
\_\_\_\_\_."

"Scripture taken from the New King James Version. Copyright © 1982 by Thomas Nelson, Inc. Used by permission. All rights reserved."

# Moses

<http://gardenofpraise.com/bibl7s.htm>

N Z W Y H N F E D D J M  
S L A V E S L N A W I B  
M K A S Q C U U S D E O  
G O N I A O G C I J S A  
H O T R F H B A L B E T  
R O I H T G N I N R U B  
E M A E E B O B V G G A  
V K R R N R U D O R A S  
I F A I A S E S O M L K  
R K L N Y H S A H D P E  
W E V A S E P T F E Z T  
L X W Z U I A A R O N J

AARON  
BURNING  
FOUND  
MOSES  
PHARAOH  
ROD

BASKET  
BUSH  
MIDIAN  
MOTHER  
PLAGUES  
SLAVES

BOAT  
DAUGHTER  
MIRACLE  
NILE  
RIVER  
SNAKE

# The Early Life of Moses

Exodus 1 — 12

God's people had lived in Egypt for many years. A new king made the Israelites slaves and was very cruel to them. God chose Moses to lead his people to a new land God promised them. God took care of Moses all his life and helped him be a good leader of God's people.

Use the clues to help you fill in the blanks in the puzzle. The Bible verses will help you.

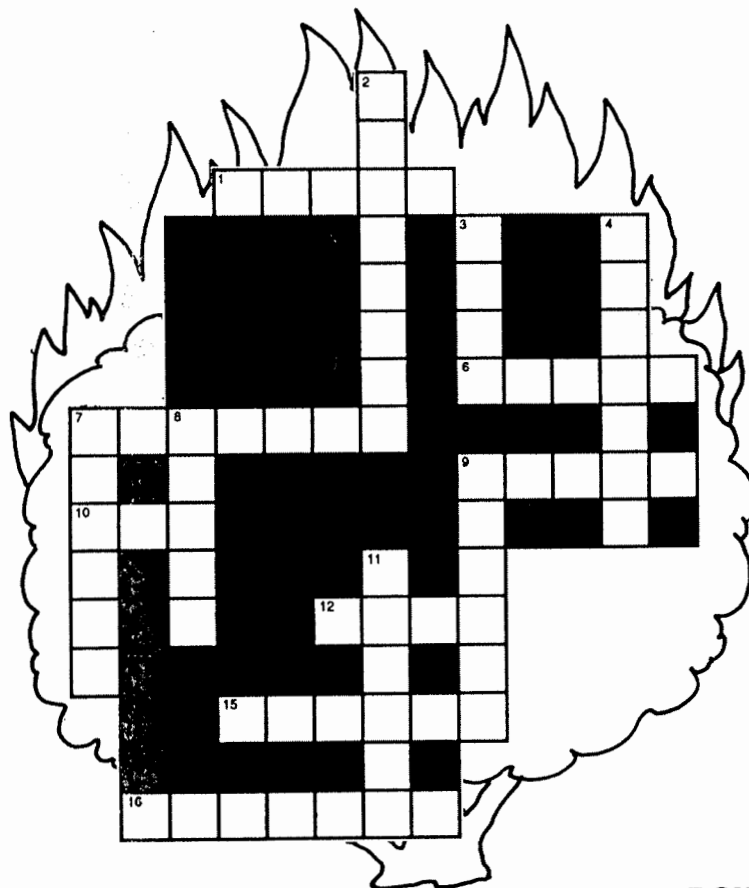

## ACROSS

1. The Israelites were slaves in this country. (1:8, 13)
6. Moses saw the burning bush at Mount \_\_\_\_\_. (3:1)
7. The ruler of Egypt was called by this title. (1:22)
9. This name means "drawn out of the water." (2:10)
10. The basket bed Moses' mother made was covered with slime or pitch, which is similar to a thick, black, sticky substance we call \_\_\_\_\_.
12. Moses' parents were from this tribe (house). (2:1)
15. The Israelite slaves lived in this region. (Genesis 45:10)
16. The name of Moses' son. (2:21-22)

## DOWN

2. Moses' wife. (2:21)
3. God spoke to Moses from a burning \_\_\_\_\_. (3:2)
4. The city which the Israelites left after the last plague. (12:31, 37)
7. The Israelite slaves built this treasure city for Pharaoh. (1:11)
8. Moses' brother (4:14); God let him be the spokesman for Moses.
9. Jethro was the priest of \_\_\_\_\_. (3:1)
11. Moses' father-in-law. (3:1)

# Moses and the Burning Bush (Exodus 3)

Puzzle Eighty-five

MOSES,  
HEBREW  
PATRIARCH  
and LAWGIVER,  
was FAVORED  
by the  
ALMIGHTY.  
The TURNING  
POINT  
in THIS  
SHEPHERD'S  
LIFE was  
the EVENT  
of the BURNING  
BUSH.  
The FIERY  
SHRUB,  
IN WHICH  
GOD APPEARED,  
WAS NOT  
CONSUMED.  
GOD SAID,  
"The PLACE  
ON WHICH  
YOU ARE  
STANDING

Y K S A Y I N G G O W D H D D W  
U R H T U S H O L Y D E Z A M A  
R H E H V T C O Z L B R U E R S  
V F P I G A I H L R A O D L X N  
S R H S F N H I E T Y V R O L O  
G E E G Z D W W J H J A O T F T  
M O R V I I N J T F H F L E E T  
T O D A I N O I G O D S A I D F  
N G S A U G W G N I N R U T F C  
I C N E P O W H J A F C P B O E  
O S K I S P Y A I U W Y U N D L  
P I R S N J E B L C G R S N T H  
H C R A I R T A P E H U U O N H  
E L P O E P U H R S M O L Q E W  
I J E C A L P B D E R D P L V A  
Y T H G I M L A D G D C W J E P

is HOLY  
GROUND."  
The LORD  
TOLD  
the AMAZED,  
FEARFUL  
Moses TO LEAD

the PEOPLE  
of ISRAEL  
out of EGYPT,  
SAYING,  
"I WILL  
be WITH YOU."



## The Burning Bush

Exodus 3 & 4 (NIV) tells about a conversation that God has with Moses from a burning bush that doesn't burn up!

Read Exodus 3:1-21

and

Exodus 4:1-14

to see what God had to say to him. Find the words from the word list in the word search puzzle below.

### WORD LIST

BURNING	MIDIAN
BUSH	MIRACULOUS
DESERT	MOSES
EGYPT	PROMISED
ELDERS	RESCUE
GROUND	SANDALS
HELP	SNAKE
HOLY	SPEAK
HOREB	STAFF
ISRAELITES	WONDERS



# Moses and the Burning Bush

"Do not come any closer," God said. "Take off your sandals, for the place where you are standing is holy ground." Exodus 3:5 (NIV)

The puzzle is based on Exodus 3:1-15



X M V H O I W S G U U Y O I J  
 P P H M P U P H A R K E I L H  
 P G Q H H C X L W N O Q Q O O  
 I F U O B N P S F R D U T O L  
 Z R I N U G L I L U Y A N K Y  
 A L U E R C L G O Y N O L D D  
 R F B Y N F B H C E W R E S U  
 J G O D R K A T K P Z U B Y F  
 R V L H L S F B F M L I G O V  
 C B D I W W N U B Q O N A P E  
 E Z M J K I L S O E I S D F H  
 V I B E C Y B H X W C N E U N  
 S B S M Z B L G O B A E Q S K  
 J A D D X S L L K L U W M Z H  
 Y R E T W E F S T R A N G E A

LAND	MILK	STRANGE	FLOWING	SANDALS
FLOCK	LOOK	HOLY	BUSH	HONEY
GOD	MOSES	GROUND	BURN	SIGHT



# Moses and the Burning Bush



"Do not come any closer," God said. "Take off your sandals, for the place where you are standing is holy ground." Exodus 3:5 (NIV)

Each number represents a letter of the alphabet. Substitute the correct letter for the numbers to reveal the coded words.

U	T	Z	R	O	Q	M	H	E	P	D	A	F	L	I	K	G	N	Y	V	J	X	W	C	S	B
1	2	3	4	5	6	7	8	9	10	11	12	13	14	15	16	17	18	19	20	21	22	23	24	25	26

1. 7-5-25-9-25 \_\_\_\_\_

2. 26-1-25-8 \_\_\_\_\_

3. 13-15-4-9 \_\_\_\_\_

4. 26-1-4-18 \_\_\_\_\_

5. 25-12-18-11-12-14-25 \_\_\_\_\_

6. 8-5-14-19 \_\_\_\_\_

7. 17-4-5-1-18-11 \_\_\_\_\_

8. 14-12-18-11 \_\_\_\_\_

9. 7-15-14-16 \_\_\_\_\_

10. 8-5-18-9-19 \_\_\_\_\_

SANDALS	BURN	HOLY	LAND	GROUND
MILK	BUSH	MOSES	FIRE	HONEY

# Moses and the Burning Bush

"Do not come any closer," God said. "Take off your sandals, for the place where you are standing is holy ground." Exodus 3:5 (NIV)

Puzzle is based on Exodus 3:1-15

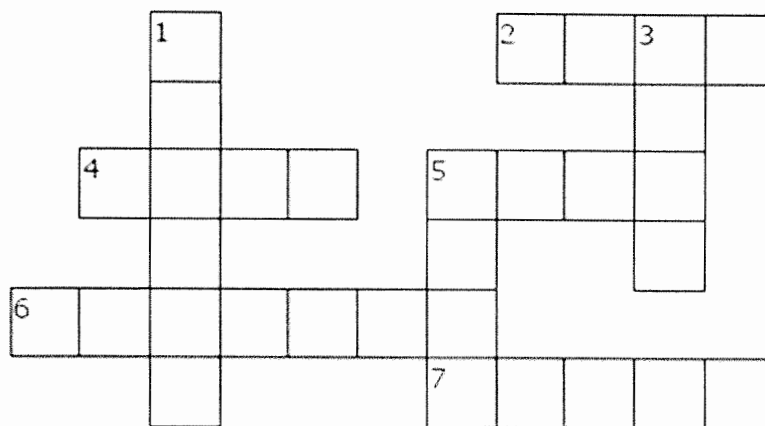

## ACROSS

2. A white liquid produced by cows, goats, and sheep
4. Belonging to God; sacred
5. To cause something to be destroyed by fire
6. Shoes with a bottom part held onto the foot by straps
7. A sweet, sticky substance made by bees

## DOWN

1. The surface of the Earth; soil
3. A country or region, especially someone's home
5. A plant that is smaller than a tree with many small branches

MILK  
BUSH

BURN  
HONEY

GROUND  
HOLY

SANDALS  
LAND

# Moses and the Burning Bush

"Do not come any closer," God said. "Take off your sandals, for the place where you are standing is holy ground." Exodus 3:5 (NIV)

Complete the sentences by filling in the blanks with the correct words from the word bank at the bottom of the page.



1. \_\_\_\_\_ was tending the flock of Jethro his father-in-law.
2. Moses saw a \_\_\_\_\_ that was on fire, but it did not burn up.
3. God told Moses to take off his \_\_\_\_\_ because he was standing on holy ground.
4. God said, "I am the God of your \_\_\_\_\_, the God of Abraham, Isaac, and Jacob."
4. Moses hid his \_\_\_\_\_ because he was afraid to look at God.
5. God was concerned about his people suffering in \_\_\_\_\_.
6. God wanted his people to go to a land flowing with \_\_\_\_\_ and \_\_\_\_\_.
7. God told Moses to tell \_\_\_\_\_ to let his people go out of Egypt.
8. God \_\_\_\_\_ Moses that he would be with him.

MILK	FACE	HONEY	PROMISED	PHARAOH
BUSH	EGYPT	SANDALS	FATHER	MOSES

# Moses' Excuses

God chose Moses to lead the Israelites out of Egypt, but Moses had excuses for not obeying God. Have you ever given a reason for disobeying God? There are no excuses for disobedience to God. When we want to obey God, He will help us do what is right.

The hidden words are from this story in Exodus 4:10-17. The code following each word tells the coordinates where one of the letters of the word is found in the puzzle. After you have found all the hidden words, start at the upper left and use all the leftover letters to fill in the blanks at the bottom of the page with a Bible verse which tells that God will help us when we obey Him.

AARON (4B)

ANGER (8J)

BROTHER (6F)

BLIND (11A)

COMETH (11I)

DEAF (11M)

DUMB (12D)

ELOQUENT (13G)

FORTH (2K)

GLAD (8N)

HAND (4O)

HEART (5O)

INSTEAD (14J)

KINDLED (10G)

KNOW (3A)

LEVITE (6E)

LORD (10D)

MAKETH (4G)

MOSES (8G)

MOUTH (10K)

	A	B	C	D	E	F	G	H	I	J	K	L	M	N	O	P	
1	W	S	S	I	N	A	M	S	E	K	O	P	S	N	H	A	1
2	O	L	E	O	L	E	A	T	H	B	F	H	E	C	A	Y	2
3	N	W	R	E	E	Y	K	A	R	O	Y	S	E	A	N	C	3
4	K	A	V	K	T	N	E	O	R	O	W	E	I	A	D	L	4
5	A	I	A	E	I	H	T	T	P	D	P	U	N	G	R	E	5
6	H	I	N	M	V	H	H	A	N	S	D	G	G	E	S	T	6
7	W	H	T	D	E	S	E	S	S	H	E	N	L	A	E	L	7
8	B	E	L	R	L	P	S	D	D	R	I	O	R	A	N	E	8
9	L	O	L	O	C	E	R	T	T	H	Q	T	Y	P	D	A	9
10	I	T	W	L	S	O	D	M	O	U	T	H	E	D	T	K	10
11	N	N	H	O	W	P	H	T	E	M	O	C	E	S	W	A	11
12	D	U	M	B	R	L	P	N	R	O	N	A	V	I	E	E	12
13	R	B	S	A	T	E	T	H	R	I	F	E	L	E	E	P	13
14	S	I	Y	X	D	A	E	T	S	N	I	T	L	A	H	S	14
	A	B	C	D	E	F	G	H	I	J	K	L	M	N	O	P	

PEOPLE (8F)

PRAY (14C)

SAY (3F)

SEEING (6M)

SEETH (3D)

SEND (6O)

SERVANT (5C)

SHALT (14N)

SINCE (13J)

SLOW (10C)

SPEAK (11P)

SPEECH (5K)

SPOKEN (2F)

SPOKESMAN (1L)

TEACH (13L)

TONGUE (9L)

UNTO (10B)

WELL (9C)

WILT (12N)

WORDS (7I)

**HIDDEN VERSE:** \_\_\_\_\_ ,  
 \_\_\_\_\_ .  
 \_\_\_\_\_ :

# Moses and the Burning Bush

## Moses' Saga



Sing "Moses' Saga" to the tune of "Oh, Dear! What Can the Matter Be?"

(Spoken) **Moses said,**

**"Oh, dear! What can the matter be?"** *(Hold one hand out, palm up, then the other.)*

**Fire, fire, there in that burning tree!** *(Bring both palms to cheeks, then point away.)*

**What, what? God wants to talk to me?** *(Point to yourself.)*

**How could that possibly be?"** *(Shrug shoulders and stand with arms out, palms up.)*

(Spoken) **God said,**

**"Stop there! Take off your dirty shoes."** *(Point down.)*

**Moses, I want to talk to you!**

**Listen, I'm planning to use you** *(place one hand behind ear and lean)*

**To bring all my people back home."** *(Motion with whole arm to come.)*

## GOD CALLS MOSES

There was a bush burning in the desert. It was full of fire, but it did not burn up. Moses went closer to the bush. Then he heard a voice.

"Moses! Do not come closer until you take off your shoes. You are on holy ground. God is talking to you!"

Moses was afraid, but God kept talking. "I have heard the cries of the Israelites who have become prisoners of the Egyptians. I will send you to Pharaoh to get their freedom."

Moses was amazed! "But, Lord, I am only a shepherd; no one will listen to me."

"Moses, I will help you," replied God. "Tell the Israelites that God has spoken and has promised to take all of you to a wonderful land."

Moses kept on complaining. "They won't believe me. Anyway, I can't speak well. Send someone else." God knew that Moses could do all these things, but He finally gave Moses some help.

Whenever Moses dropped his staff, it would become a snake until he picked it up. Whenever he put his hand in and out of his robe, it would become diseased until he put it back. Whenever he poured water from the river onto the ground, it would become blood. These miracles would prove to the people that Moses had God's message.

Also, God gave Moses a helper. Moses' brother Aaron would speak to the Israelites for Moses.

*Exodus 3:1-4:20*

?

*Could Moses have done what God asked?  
Will God ever ask you to do something too hard for you?*

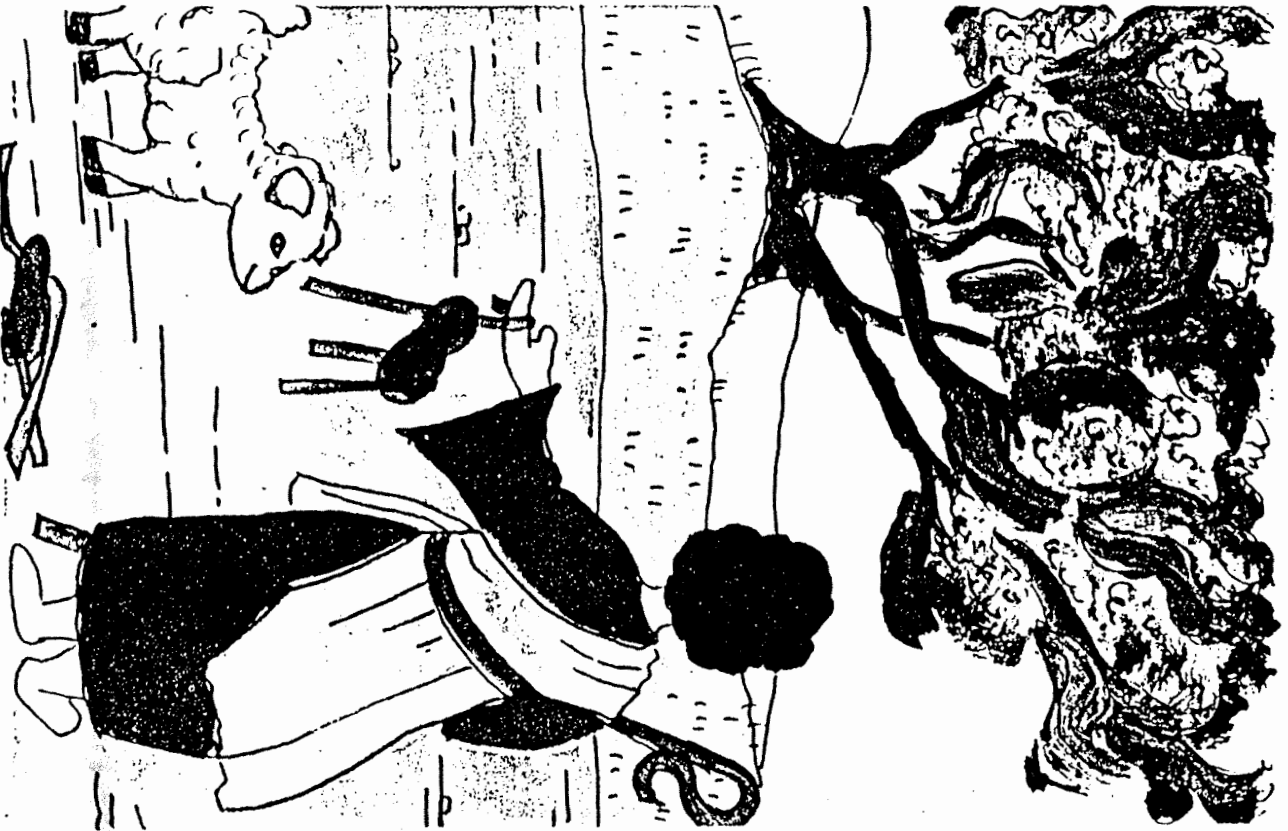

# The Early Life of Moses

Exodus 1 — 12

God's people had lived in Egypt for many years. A new king made the Israelites slaves and was very cruel to them. God chose Moses to lead his people to a new land God promised them. God took care of Moses all his life and helped him be a good leader of God's people.

Use the clues to help you fill in the blanks in the puzzle. The Bible verses will help you.

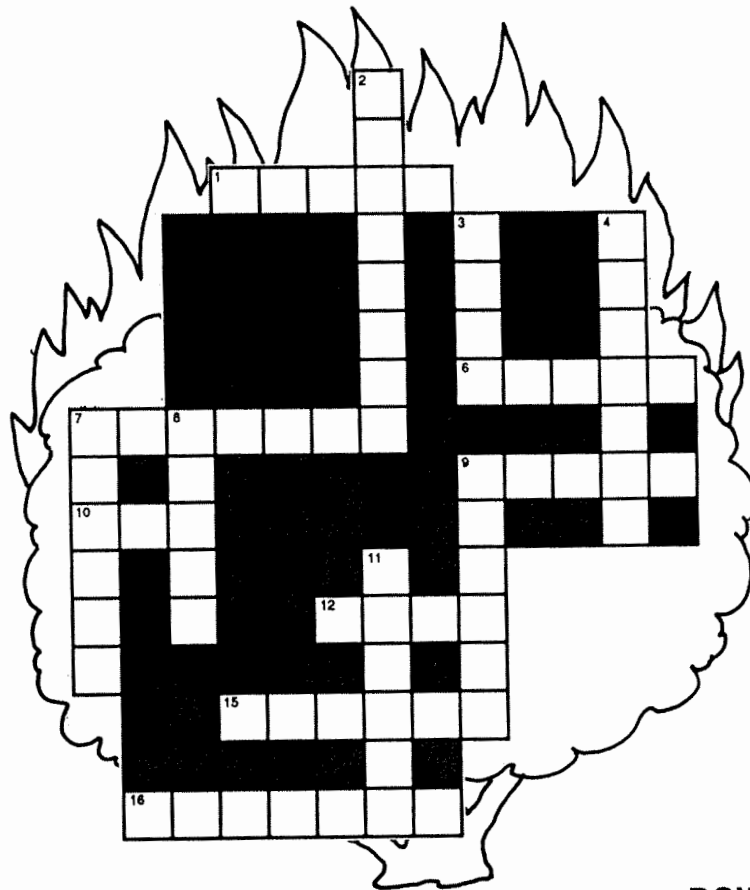

## ACROSS

1. The Israelites were slaves in this country. (1:8, 13)
6. Moses saw the burning bush at Mount \_\_\_\_\_. (3:1)
7. The ruler of Egypt was called by this title. (1:22)
9. This name means "drawn out of the water." (2:10)
10. The basket bed Moses' mother made was covered with slime or pitch, which is similar to a thick, black, sticky substance we call \_\_\_\_\_.
12. Moses' parents were from this tribe (house). (2:1)
15. The Israelite slaves lived in this region. (Genesis 45:10)
16. The name of Moses' son. (2:21-22)

## DOWN

2. Moses' wife. (2:21)
3. God spoke to Moses from a burning \_\_\_\_\_. (3:2)
4. The city which the Israelites left after the last plague. (12:31, 37)
7. The Israelite slaves built this treasure city for Pharaoh. (1:11)
8. Moses' brother (4:14); God let him be the spokesman for Moses.
9. Jethro was the priest of \_\_\_\_\_. (3:1)
11. Moses' father-in-law. (3:1)

# The Burning Bush

(Exodus 3)

- ABRAHAM
- BURNED
- BUSH
- CHILDREN
- CONSUMED
- DAUGHTERS
- DELIVER
- EGYPT
- FIRE
- GOLD
- GROUND
- HOLY
- HONEY
- HOREB
- I AM
- ISAAC
- JACOB
- JETHRO
- JEWELS
- LAND
- LORD
- MEMORIAL
- MILK
- MOSES
- NAME
- PHARAOH
- RAINMENT
- SHOES
- SILVER
- SONS

Z	S	I	L	V	E	R	H	O	A	R	A	H	P	M
E	U	D	A	U	G	H	T	E	R	S	I	O	O	M
G	U	L	B	U	R	N	E	D	M	S	Z	S	Q	J
Y	H	O	N	E	R	E	V	I	L	E	D	E	M	
P	O	U	F	I	R	E	J	M	L	S	Q	W	Z	Y
T	L	E	M	A	N	I	O	Q	K	Q	L	E	U	M
Z	A	L	O	K	G	O	S	A	L	L	D	D	T	
M	I	O	M	S	S	D	B	T	S	U	I	P	E	K
A	R	R	T	C	O	N	S	U	M	E	D	H	T	Z
H	O	D	U	M	N	A	Z	X	S	H	O	R	E	S
A	M	P	Q	B	S	L	I	A	M	H	O	R	E	B
R	E	S	O	W	R	R	O	G	R	O	U	N	D	V
B	M	C	R	A	I	M	E	N	T	L	O	V	E	Y
A	A	I	S	A	A	C	I	O	U	Y	G	O	L	D
J	E	T	H	R	O	N	N	E	R	D	L	I	H	C

## Bonus Trivia

Who said, "I am he that liveth, and was dead; and, behold, I am alive for evermore"?

Christ. Rev. 1:18.



# THE BURNING BUSH

## (EXODUS 3:1-4:17)

### MEMORY VERSE:

"My sheep hear My voice, and I know them, and they follow Me." JOHN 10:27

### TRUE OR FALSE:

1. "Now Moses kept the flock of of Jethro his father-in-law, the priest of Midian. And he led the flock to the back of the desert, and came to Horeb, the mountain of God." EXODUS 3:1  
TRUE OR FALSE

### CIRCLE THE CORRECT WORDS:

2. "And the Angel of the LORD appeared to him in a flame of fire from the midst of a (**STORM, BUSH**) So he looked, and behold, the bush burned with fire, but the bush was not consumed." EXODUS 3:2
3. "And the LORD said, 'Do not draw near this place. Take your sandals off your (**HEAD, FEET**), for the place where you stand is holy ground." EXODUS 3:5
4. The LORD said, "I have come down to deliver My people out of the hand of the Egyptians, and to bring them up from that land to a good and large land, to a land flowing with (**MILK AND HONEY, SODA AND JAM**)." EXODUS 3:8

### FILL IN THE BLANKS:

5. "Then Moses said to God, 'Indeed, when I am come to the children of Israel and say to them, "The God of your fathers has sent me to you," and they say to me, "What is His name?" what shall I say to them?' And God said to Moses, '\_\_\_\_ \_.' " EXODUS 3:13-14

**MOSES SAID, "BUT SUPPOSE THEY WILL NOT BELIEVE ME OR LISTEN TO MY VOICE; SUPPOSE THEY SAY, 'THE LORD HAS NOT APPEARED TO YOU.' " EXODUS 4:1**

### CIRCLE THE CORRECT WORDS:

6. "So the LORD said to him, 'What is that in your hand?' And he said, 'A rod.' And He said, 'Cast it on the ground.' So he cast it on the ground, and it became a (**SERPENT, ELEPHANT**); and Moses fled from it." EXODUS 4:2-3
7. "Then the LORD said to Moses, 'Reach out your hand and take it by the (**HEAD, TAIL**).' " EXODUS 4:4
8. "Furthermore the LORD said to him, 'Now put your hand in your bosom.' And he put his hand in his bosom, and when he took it out, behold, his hand was leprous, like (**SNOW, COAL**)." EXODUS 4:6

### TRUE OR FALSE:

9. "And He said, 'Put your hand in your bosom again.' So he put his hand in his bosom again, and drew it out of his bosom, and behold, it was restored like his other flesh." EXODUS 4:7  
TRUE OR FALSE

### CIRCLE THE CORRECT WORD:

10. When Moses told the LORD that he did not speak well, "the LORD said to him, 'Who has made man's mouth? Or who makes the mute, the deaf, the seeing, or the blind? Have not I, the LORD? Now therefore, go, and I (**WILL, WON'T**) be with your mouth and teach you what you shall say.' " EXODUS 4:10-12

# THE BURNING BUSH

(EXODUS 3:1-4:17)

S H E L B P N B Q X C J B T J  
 A U O D Z H V I Z P C B K A Q  
 N Q O R F Z Q A U E Q B E T R  
 D S C E H I H T U O M M F N I  
 A S S U O R P E L S I O J E L  
 L I F U N V T M A G W S T P S  
 S L M W G V A X N D Z E E R T  
 J S B J L B Q T M E K S J E F  
 Q D E M U S N O C T O N Z S A  
 I J Y N G Q F Y G P K N Z N Y  
 K F E R I F H L F Z Q O K R R  
 T F N S R Y P I H H D R C P O  
 I A M W H O I A M S R A T I D  
 D O M Z Q E J O A U O A I Q Y  
 Y P H K I L T V W B L R O D O

AARON  
 BUSH  
 FIRE  
 I AM WHO I AM

LEPROUS  
 LORD  
 MOSES  
 MOUTH

NOT CONSUMED  
 ROD  
 SANDALS  
 SERPENT

WRITE DOWN THE LETTERS AS YOU COME TO THEM ON THE LINES BELOW

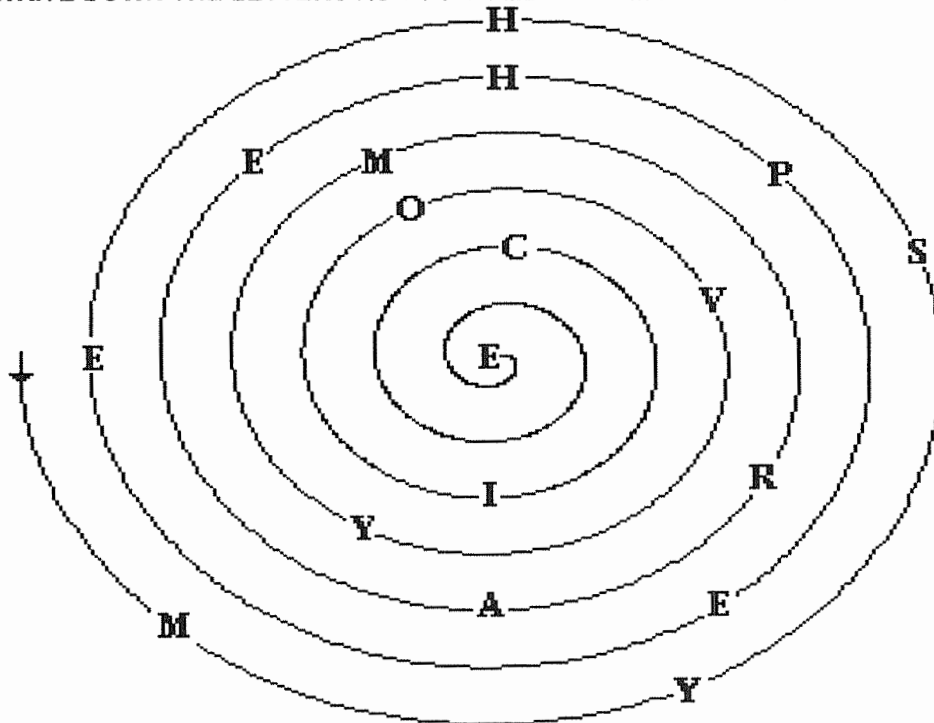

"-----"

# THE BURNING BUSH

## (EXODUS 3:1-4:17)

### MEMORY VERSE:

"My sheep hear My voice, and I know them, and they follow Me." JOHN 10:27

### TRUE OR FALSE:

1. "Now Moses kept the flock of of Jethro his father-in-law, the priest of Midian. And he led the flock to the back of the desert, and came to Horeb, the mountain of God." **EXODUS 3:1**  
**TRUE OR FALSE**

### FILL IN THE BLANKS:

2. "And the Angel of the LORD appeared to him in a flame of fire from the midst of a \_\_\_\_\_ So he looked, and behold, the bush burned with fire, but the bush \_\_\_\_\_ consumed." **EXODUS 3:2**
3. "And the LORD said, 'Do not draw near this place. Take your \_\_\_\_\_ off your feet, for the place where you stand is holy ground.'" **EXODUS 3:5**

### CIRCLE THE CORRECT WORDS:

4. The LORD said, "I have come down to deliver My people out of the hand of the Egyptians, and to bring them up from that land to a good and large land, to a land flowing with **(MILK AND HONEY, SODA AND JAM)**." **EXODUS 3:8**

### FILL IN THE BLANKS:

5. "Then Moses said to God, 'Indeed, when I am come to the children of Israel and say to them, "The God of your fathers has sent me to you," and they say to me, "What is His name?" what shall I say to them?' And God said to Moses, ' \_\_\_\_\_.'" **EXODUS 3:13-14**

**MOSES SAID, "BUT SUPPOSE THEY WILL NOT BELIEVE ME OR LISTEN TO MY VOICE; SUPPOSE THEY SAY, 'THE LORD HAS NOT APPEARED TO YOU.' " EXODUS 4:1**

### CIRCLE THE CORRECT WORD:

6. "So the LORD said to him, 'What is that in your hand?' And he said, 'A rod.' And He said, 'Cast it on the ground.' So he cast it on the ground, and it became a **(SERPENT, ELEPHANT)**; and Moses fled from it." **EXODUS 4:2-3**

### FILL IN THE BLANKS:

7. "Then the LORD said to Moses, 'Reach out your hand and take it by the \_\_\_\_\_.'" **EXODUS 4:4**
8. "Furthermore the LORD said to him, 'Now put your hand in your bosom.' And he put his hand in his bosom, and when he took it out, behold, his hand was \_\_\_\_\_, like snow." **EXODUS 4:6**
9. "And He said, 'Put your hand in your bosom again.' So he put his hand in his bosom again, and drew it out of his bosom, and behold, it was \_\_\_\_\_ like his other flesh." **EXODUS 4:7**

### CIRCLE THE CORRECT WORD:

10. When Moses told the LORD that he did not speak well, "the LORD said to him, 'Who has made man's mouth? Or who makes the mute, the deaf, the seeing, or the blind? Have not I, the LORD? Now therefore, go, and I **(WILL, WON'T)** be with your mouth and teach you what you shall say.'" **EXODUS 4:10-12**

# THE BURNING BUSH

## (EXODUS 3:1-4:17)

U B Y P P Z O J E O T J A R B U G M F Q  
 G P G M R Z Z W M B Q K Y R B T C A L N  
 I M M D X O T Y D S A N D A L S Z S Y I  
 C W O B N W M N W H H S Q W P O H V H S  
 E R Q B O O F J E F A M U P P M K Y X V  
 U N H O S H T T Q P U J Q N Y J K K O U  
 X G V H L Q M C X V R T T K F K R W I U  
 M K V S K I Q N O I U E H B O S E L R A  
 K B G S W L S A H N T A S C S U N W F D  
 U Y S R V H Q S I T S A T E J O C W Y D  
 Y B N V J T V L T O U U S D W R V Z X W  
 Y K U N X I P P A N T O M W S P C O D T  
 R P B S W Y A U L H M U M E S E C A F L  
 F U B G H O B M D R O L N K D L H K B A  
 H Y N D E A Q T W I D E O I I G R U E O  
 E F O P L V J N B H D N R E A H E N H A  
 L N J K V E I D Z U O Q A P G G M U T P  
 M T Q S R C C R Z A Q I A I W D Q D L A  
 G G S I D A T A N L C X A Y A V N L U D  
 M E F P D L C Z K L U N T M F B Y U W Y

**AARON**  
**BUSH**  
**FIRE**  
**I AM WHO I AM**

**LEPROUS**  
**LORD**  
**MOSES**  
**MOUTH**

**NOT CONSUMED**  
**ROD**  
**SANDALS**  
**SERPENT**

WRITE DOWN THE LETTERS AS YOU COME TO THEM ON THE LINES BELOW

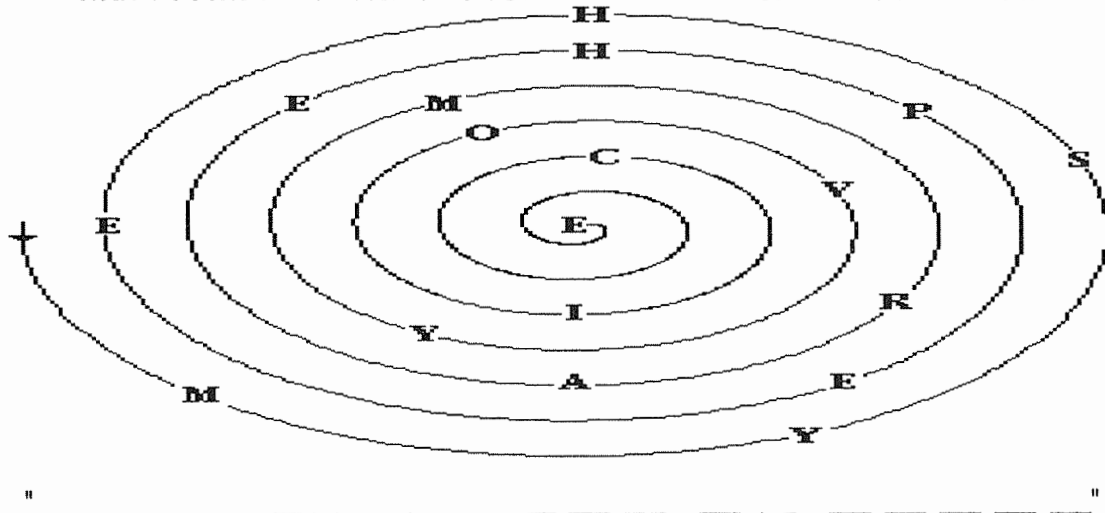

**Year 1**

**Week 34**

## **God Versus Pharaoh**

**Scriptures: Exodus 5 - 10**

**Key Verse: Exodus 6:6** “Therefore say to the children of Israel: *I am the Lord*; I will bring you out from under the burdens of the Egyptians, I will rescue you from their bondage, and I will redeem you with an outstretched arm and with great judgments”

### **Key Points:**

1. Moses goes to see Pharaoh and he becomes angry. Pharaoh scoffs at God and makes the children of Israel work even harder, having to find their own straw for making bricks. Moses is discouraged, Pharaoh becomes meaner, but God becomes even stronger against him.
2. God promises He will deal with Pharaoh and that Pharaoh will drive the children of Israel out of his land. He will do many signs so that the people would know that HE IS GOD. God instructs Moses and Aaron to go to Pharaoh again, this time using Aaron’s rod to become a snake. Pharaoh called his sorcerers and they too made snakes from rods, but Aaron’s snakes ate up Pharaoh’s and this made him very angry again and would not let the people go.
3. God sends the first 9 plagues to the Egyptians, none ever affected the Israelites. Through all 9 plagues Pharaoh would not give up. Several times Moses went to Pharaoh before the plague would come to give him a chance to free the Israelites, but he would not. (As time permits, go over each plague; briefly talk about how they affected the people).

## **Week 34 con't**

4. God shows His power to Pharaoh through these plagues. God also shows love for His people and that He keeps His promises and covenants.

### **10 Plagues: Water to Blood, Frogs, Lice, Flies, diseased Livestock, Boils, Hail, Locusts, Darkness, and death of the Firstborn.**

Death of the Firstborn will be covered in lesson 35. This is a lot of material, however, teaching the important concepts of God using Pharaoh's stubbornness, God showing his power to the people, and keeping promises would be important to bring out in this lesson. It may not be as necessary to focus too much on the individual plagues.

Year 1, Week 34  
Exodus 5-10  
God Versus Pharaoh

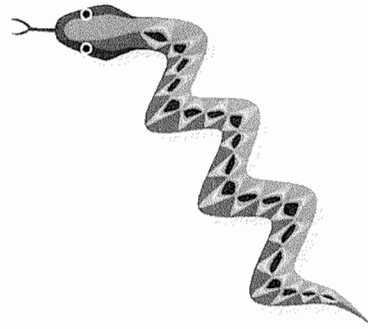

**Exodus 6:6**

"Therefore say to the children of Israel: 'I am the LORD; I will bring you out from under the burdens of the Egyptians, I will rescue you from their bondage, and I will redeem you with an outstretched arm and with great judgments. (NKJV)



Moses told Pharaoh, "Let my people go!" But Pharaoh refused. Then God sent terrible plagues upon the people of Egypt. *Exodus 7:15-10:29*



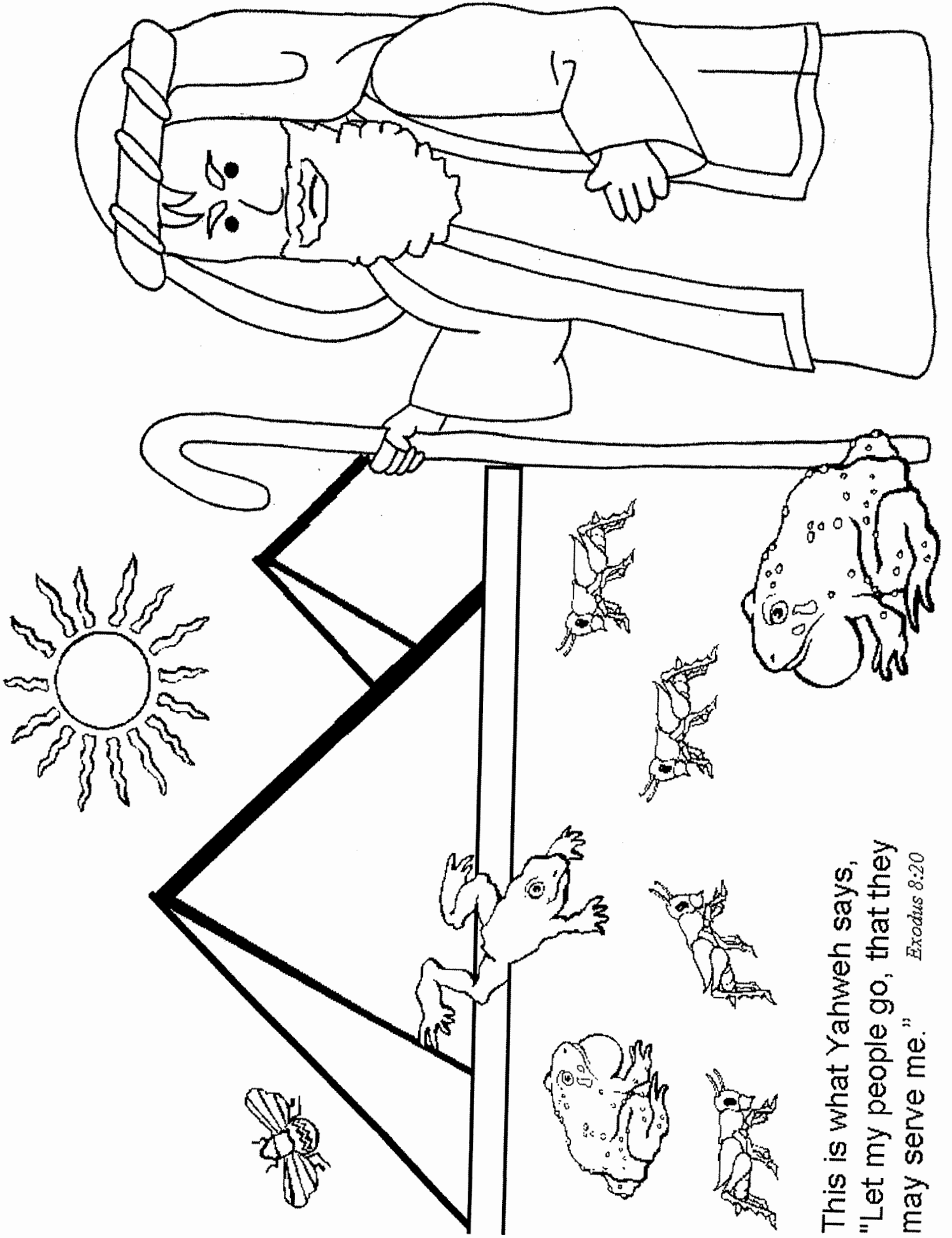

This is what Yahweh says,  
"Let my people go, that they  
may serve me." *Exodus 8:20*

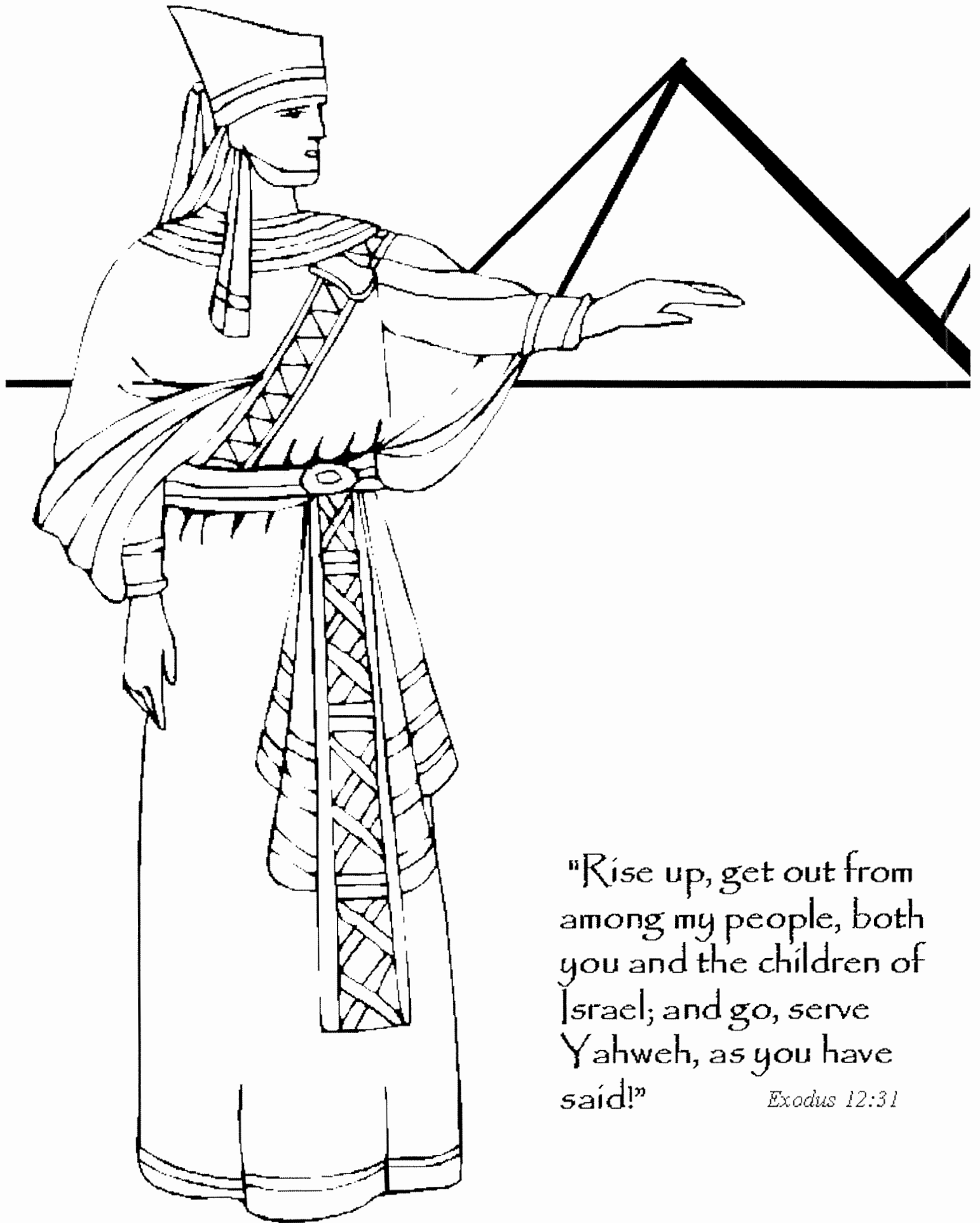

"Rise up, get out from among my people, both you and the children of Israel; and go, serve Yahweh, as you have said!"

*Exodus 12:31*



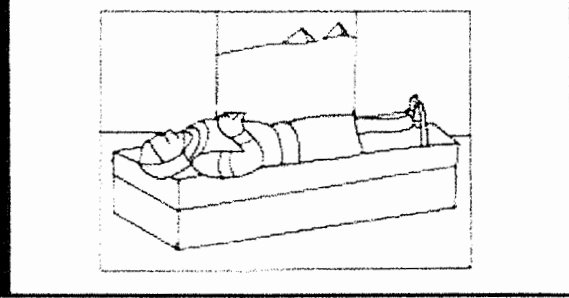
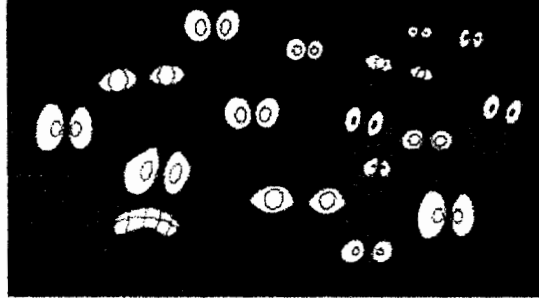
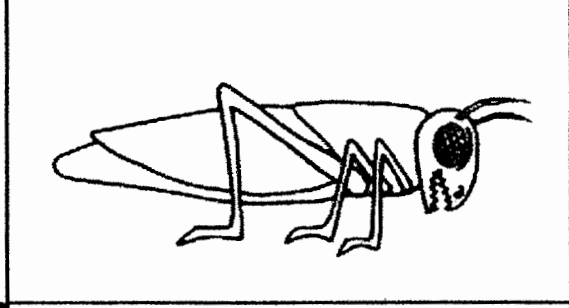
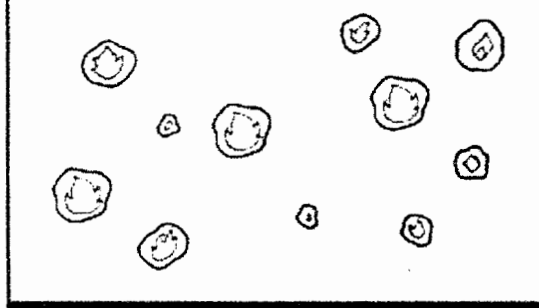
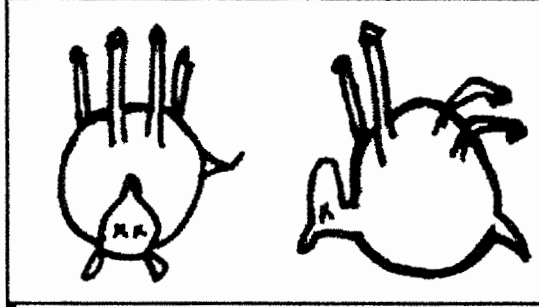
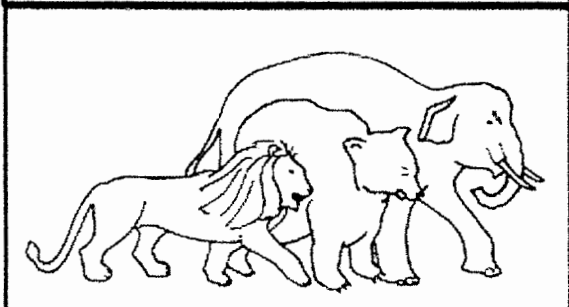
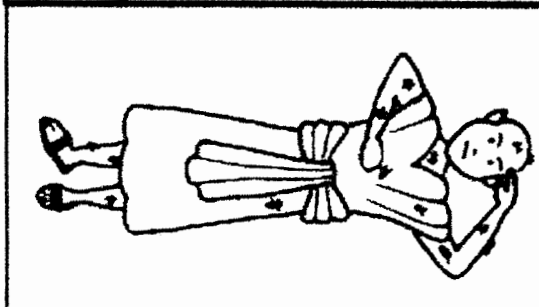
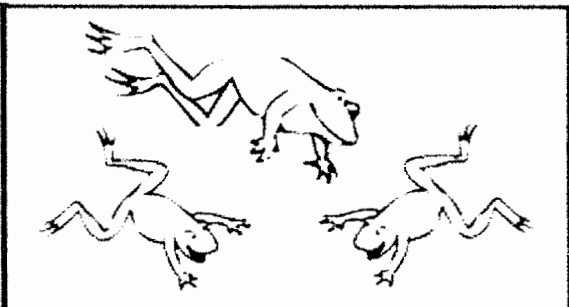
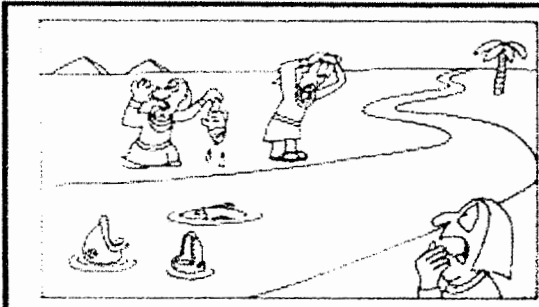

**The 10 Plagues**

**Exodus  
5-12**



**Tell Pharaoh  
"I AM sent me."**

**Exodus  
3:14**



**#1**

**#2**



**#3**

**#4**



**#5**

**#6**

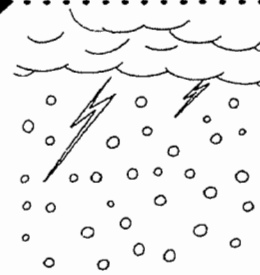

**#7**

**#8**

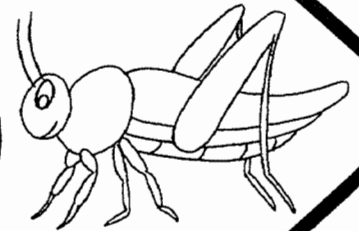

**#9**



**#10**



or

© 2000 by Bible Project

Why should I listen to you or to your God?" Pharaoh's angry shouts echoed through the palace. Moses and Aaron had asked if the Israelites could go for three days to worship God. But Pharaoh just made the poor slaves work harder than ever.

God told Moses He would send ten terrible troubles to Egypt so that Pharaoh would listen to God. First, the water in all the rivers was turned to blood. Second, the land was filled with frogs.

Third, the dust of the land became lice. Fourth, swarms of flies bit the Egyptians. Fifth, the cattle of the Egyptians died. Sixth, the Egyptians broke out in terrible sores.

Seventh, terrible thunderstorms came and ruined the countryside. Eighth, thousands of locusts ate up everything that was growing.

Ninth, for three days the land of Egypt was full of darkness. Tenth, the oldest child of each family died unless God's special mark was on the door of the house.

Each time a trouble came, Pharaoh would decide to let the Israelites go. But when God took the trouble away, Pharaoh would change his mind and make them stay. Finally, when Pharaoh's own son died, Pharaoh told the Israelites to get out of Egypt in a hurry.

?

Exodus 5-13

*Why did God send troubles to Egypt?  
Why do you sometimes have troubles or problems?*



# The Plague Song!

by Craig

**A catchy little song about the plagues of Egypt that can be sung to the tune of "This Old Man".**

[Hear a sample of this song](#) or [Listen to full version](#) 🎵

*Music by Rich Nelson Music*

**Topics:**

Plagues, Hardened Heart, Moses



**Target Audience:**

Grades 2-6 (Ages 7-12)

First God sent,  
**Plague number one,**  
Turned the Nile into blood.  
All the people in Egypt were feeling pretty low,  
They told Pharaoh "Let them Go!"

Then God sent,  
**Plague number two,**  
Jumping frogs all over you.  
All the people in Egypt were feeling pretty low,  
They told Pharaoh "Let them Go!"

Then God sent,  
**Plague number three,**  
Swarms of gnats from head to knee.  
All the people in Egypt were feeling pretty low,  
They told Pharaoh "Let them Go!"

Then God sent,  
**Plague number four,**  
Filthy flies need we say more?  
All the people in Egypt were feeling pretty low,  
They told Pharaoh "Let them Go!"

Then God sent,  
**Plague number five,**  
All the livestock up and died.  
All the people in Egypt were feeling pretty low,  
They told Pharaoh "Let them Go!"

Then God sent,  
**Plague number six,**  
Boils and sores to make you sick.  
All the people in Egypt were feeling pretty low,  
They told Pharaoh "Let them Go!"

Then God sent,  
**Plague number seven,**  
Hail and lightning down from heaven.  
All the people in Egypt were feeling pretty low,  
They told Pharaoh "Let them Go!"

Then God sent,  
**Plague number eight,**  
Locust came and they sure ate.  
All the people in Egypt were feeling pretty low,  
They told Pharaoh "Let them Go!"

Then God sent,  
**Plague number nine,**  
Total darkness all the time.  
All the people in Egypt were feeling pretty low,  
They told Pharaoh "Let them Go!"

Then God sent,  
**Plague number ten,**  
Pharaoh's son died so he gave in.  
All the people in Egypt were feeling pretty low,  
Finally Pharaoh *let them go*.

## Moses and the plagues

Cut an empty egg carton so that there are 10 cups (instead of 12). Now, find little items to represent the 10 plagues and place in each of the 10 cups. For example, a red piece of paper for blood, plastic frog, fly, cow, Styrofoam ball for hail, etc. The kids may want to draw pictures to help them remember the plagues.

Put a drop of red food coloring on the end of a toothpick. Dip it in water and watch the water turn red. Talk about how the magicians did the same thing.

Share how God did a miracle and how it was different. (Even the water in pots turned red etc.)

Make a booklet of the plagues or play a game about the plagues (see the attached sheet.)



# Scrambled Plagues

One of the ten plagues God sent to the Egyptians was frogs. Unscramble the words on the frogs to discover eight other plagues God sent. If you need help, read Exodus 7-10.

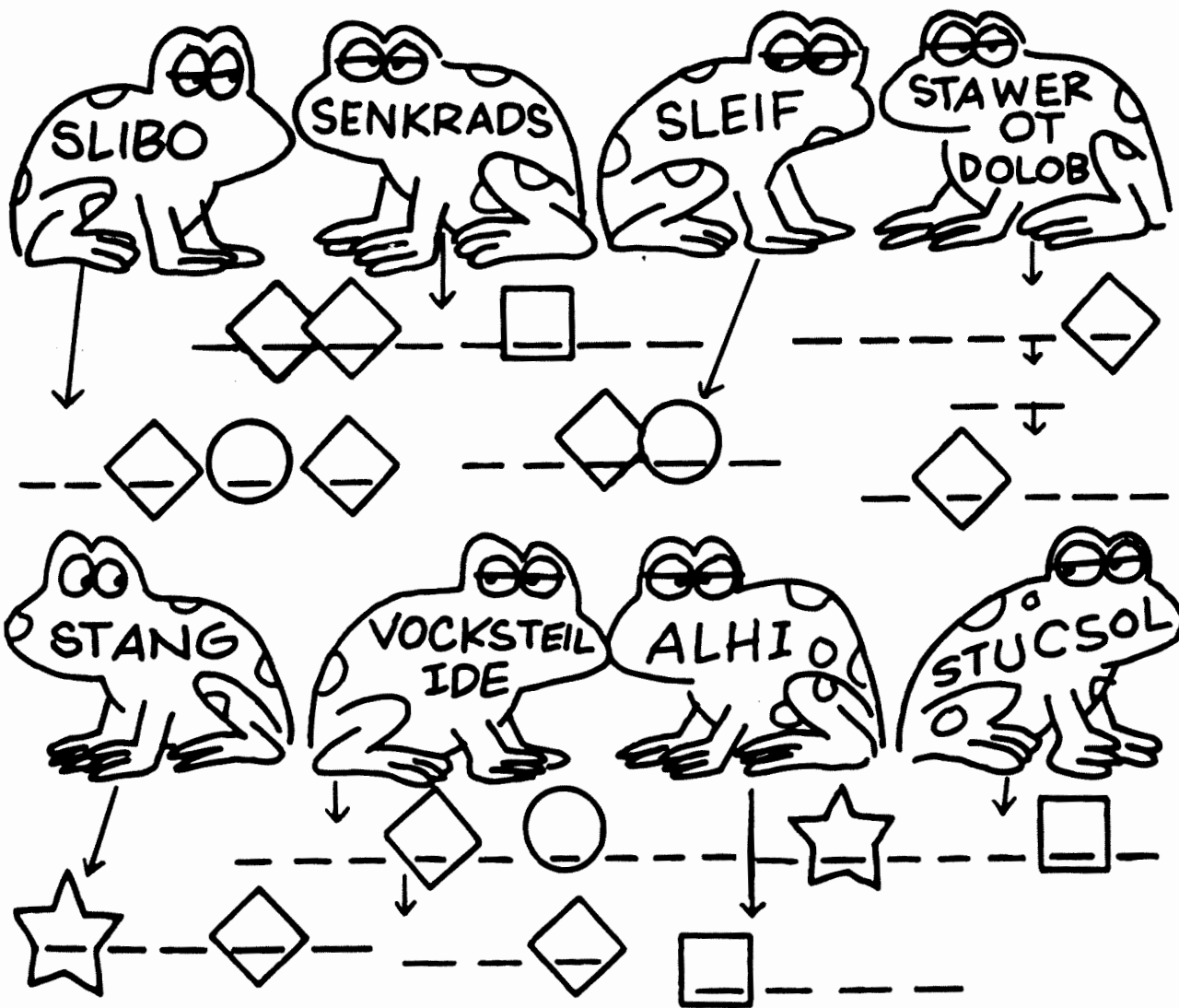

Now put each circled letter in a circle below, each letter with a square around it in a square below, and so on. Unscramble the letters to find God's message to Pharaoh.

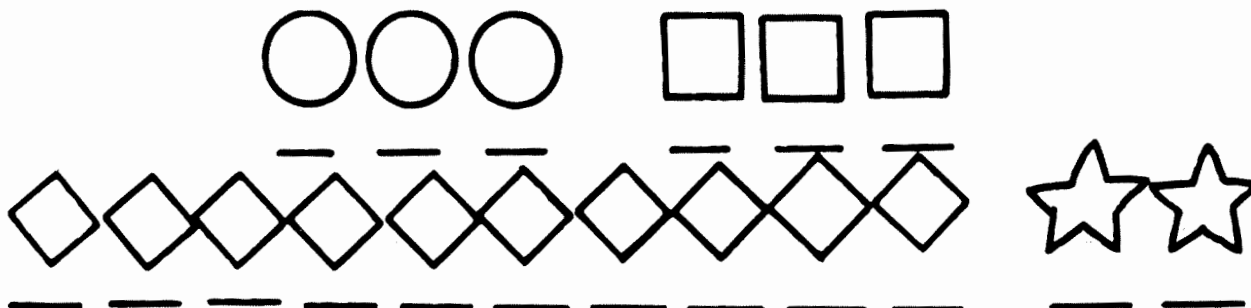

# Eat and Run

Read about God's plan to free Israel in Exodus 12:3, 7, 8, 11-14. Then connect the dots in order from 1-73 to find the Bible name for this event.



2.				1.
3.		4.		7.
14.		5.	6.	
13.				.8
	12.			.15
	11.			
10.				.73
9.				
68.	.69	72.	65.	64.
	.70	71.		
67.				.62
56.	.57	60.	.66.	63.
				.61
			53.	52.
	58.	59.		
55.	21.	54.	22.	51.
20.				
19.				.50
	18.		17.	.16
48.		.24		.49
				.23
45.				.47
				.46
				.25
	42.	41.	38.	37.
44.	.43	40.	39.	36.
33.				.35
32.		31.		.34
30.		28.		
29.		27.	26.	



# **12 Plagues**

Exodus 7:14-12:30

1. Water to Blood
2. Frogs
3. Lice
4. Flies
5. Diseased Livestock
6. Boils
7. Hail
8. Locusts
9. Darkness
10. Death of the First Born

**The Plagues  
in Egypt  
Exodus 7**

# Plaguing Problems

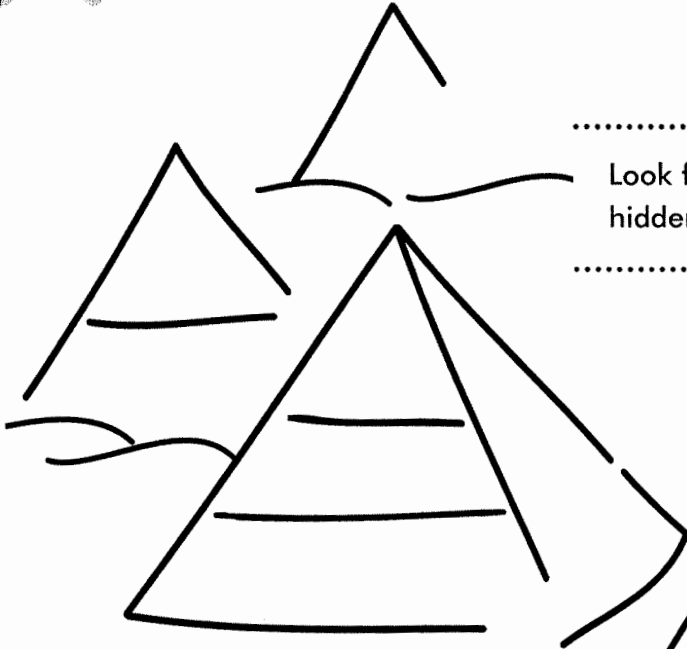

Look for the ten plagues in this pyramid. They are hidden forwards, backwards, up, down, and diagonally.

When Moses grew up, he was chosen by God to lead the Hebrews out of slavery. God sent plagues to the land of Egypt to help Moses convince Pharaoh to free the people. You can read about it in Exodus 7-14.

**PLAGUES**

- BLOOD
- FROGS
- GNATS
- FLIES
- LIVESTOCK
- BOILS
- HAIL
- LOCUST
- DARKNESS
- DEATH

K	B	O	I	L	S	T	S	L
N	C	O	B	G	X	S	I	B
S	A	O	U	E	E	A	S	L
E	N	E	T	N	H	X	G	O
I	S	K	K	S	J	I	O	O
L	T	R	M	C	E	P	R	D
F	A	L	B	V	C	V	F	F
D	N	H	T	A	E	D	I	Y
S	G	T	S	U	C	O	L	L

# CROSSWORD PUZZLE

Use the clues below to solve the puzzle.

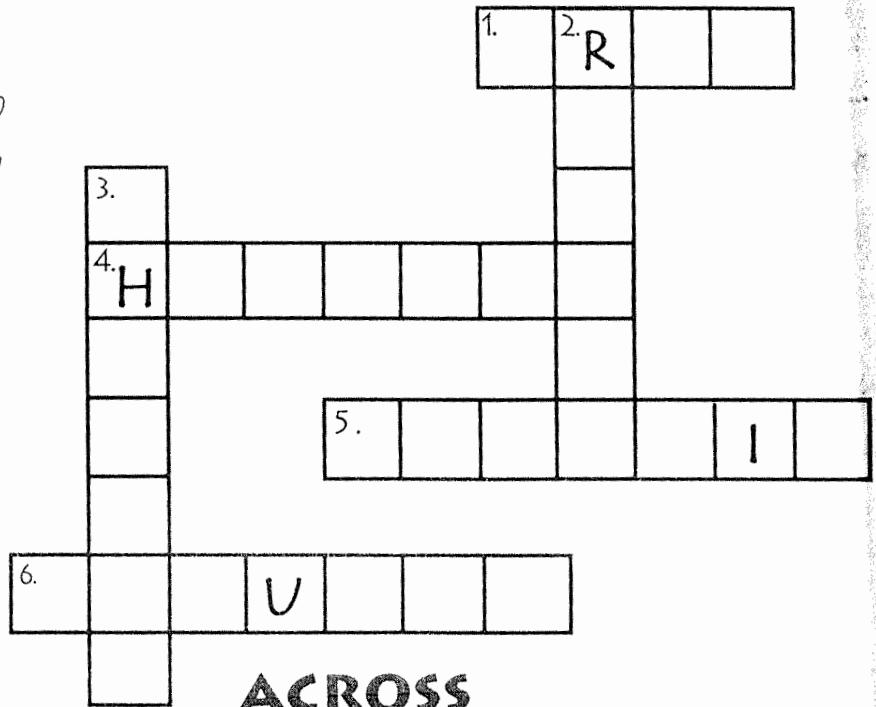
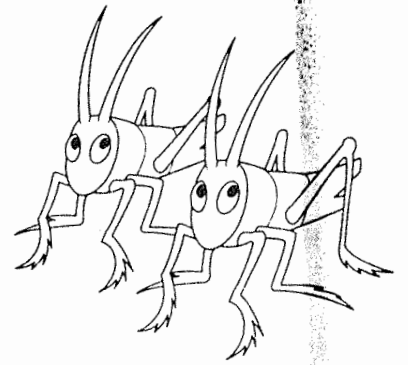

## ACROSS

1. A green amphibian
4. A group of people who were slaves for the Egyptians
5. Egyptian grave for kings
6. One of the ten plagues

## DOWN

2. The sea Moses parted
3. Another word for king

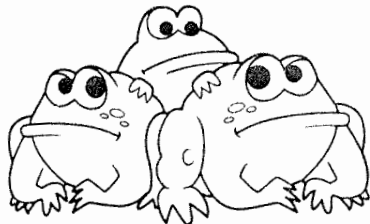

# What God Used to Show His Power

Exodus 7:1-25

God chose Moses to lead the Israelites out of slavery in Egypt and into the land God promised Abraham. But the cruel ruler, Pharaoh, did not want the Israelite slaves to leave Egypt. God showed Pharaoh His power through miracles and ten plagues which came on the nation of Egypt.

Connect the dots to reveal two things God used to show Pharaoh His power. Then unscramble the words and write them on the lines to tell what happened.

ANRSOA DOR ECBMAE A EPSRNET

HTE AICGAMINS DOSR SLAO AECBME PNTSERES

ARNSOA PRETNSE WAOLLEWSD EHT HTREO SPEETNSR

ARONA ETOMS TEH VRREI TWIH ISH DOR

TEH TWEAR RNTUDE OT DOLOB

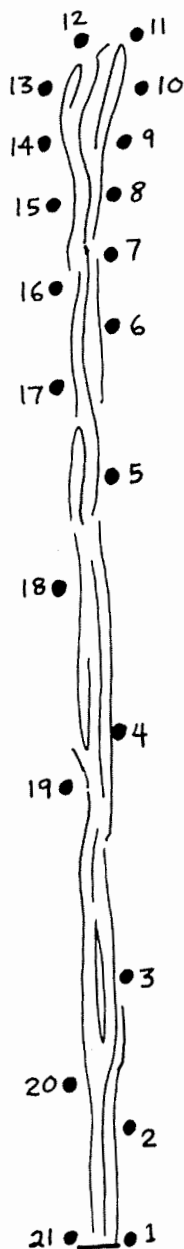

# The Plagues upon Egypt

Read in Exodus 5:1  
(NIV) to see what  
Moses and Aaron had to  
say to Pharaoh and fill in  
the blanks below.

"This is what the LORD,  
the God of Israel says:

' \_\_\_\_\_  
\_\_\_\_\_ ' "



Pharaoh's heart was hard and he wouldn't let the Israelites leave Egypt. So God sent plagues to convince Pharaoh to let His people go. It took 10 plagues before Pharaoh let them leave. Unscramble the words below to see what the plagues were.

OBDLO \_\_\_\_\_  
(EXODUS 7:14-24)

GRSFO \_\_\_\_\_  
(EXODUS 8:1-15)

ANTGS \_\_\_\_\_  
(EXODUS 8:16-19)

SLEFI \_\_\_\_\_  
(EXODUS 8:20-32)

TSLVOIKCE  
\_\_\_\_\_  
(EXODUS 9:1-7)

OBLIS \_\_\_\_\_  
(EXODUS 9:1-7)

LAHI \_\_\_\_\_  
(EXODUS 9:13-35)

OLTSCUS \_\_\_\_\_  
(EXODUS 10:1-18)

AKDENSRS \_\_\_\_\_  
(EXODUS 10:21-29)

ROFSBNIRT  
\_\_\_\_\_  
(EXODUS 11:1-10)

# Moses in Egypt

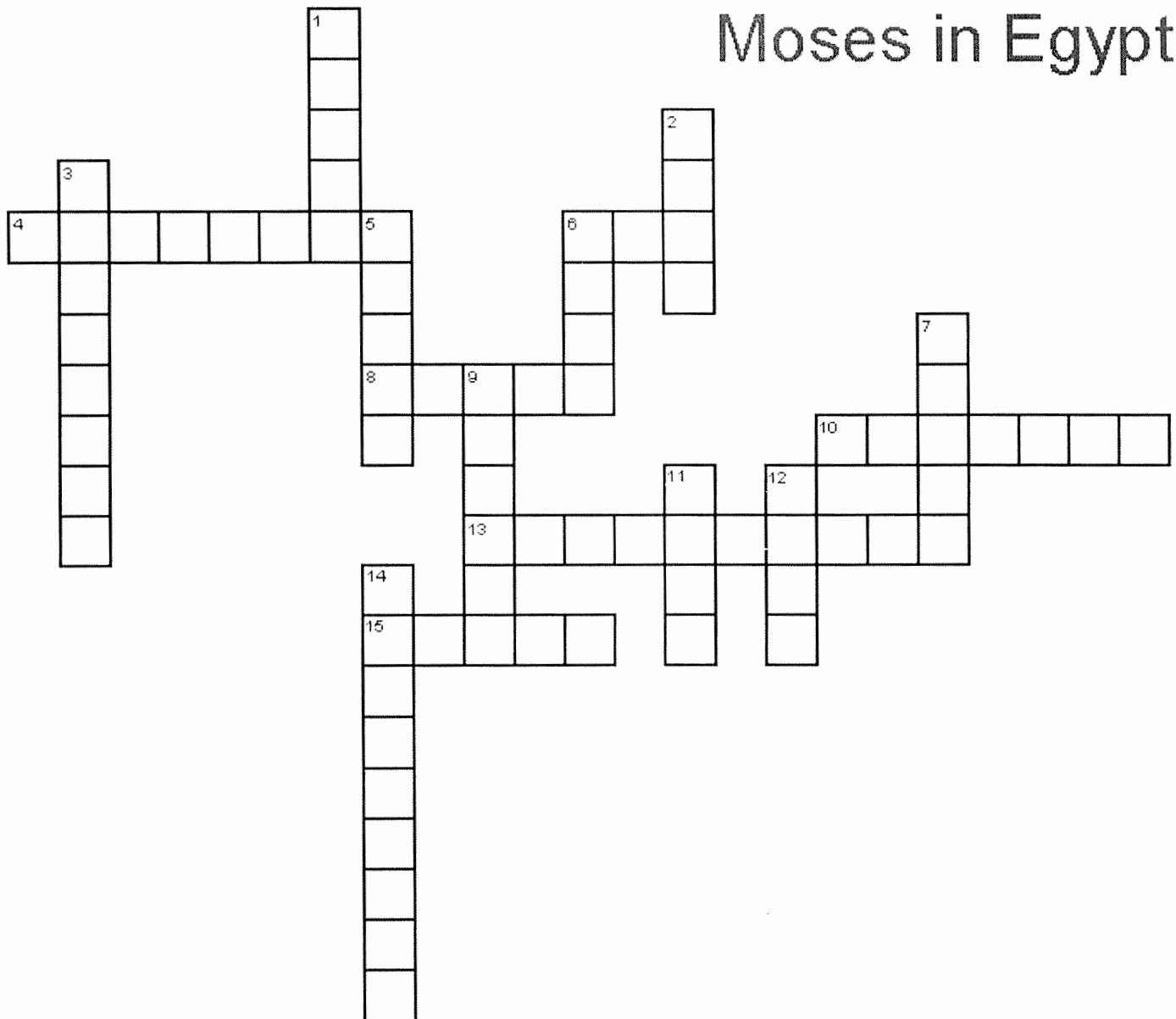

## Across

4. The Egyptians didn't need sunglasses during this plague.
6. How many plagues were there all together?
8. True or false - Pharaoh never had a chance to stop the plagues?
10. God promised he would do this for his people.
13. The Israelites had to make bread quickly, what is this flat bread called?
15. What turned to blood in all of Egypt?

## Down

1. The Egyptians had these jumping in their plates of food.
2. Pharaoh died because he kept changing his \_\_\_\_.
3. What is it still called when God saw the blood on the doors?
5. What did Moses use to separate the Red Sea?
6. True or false - the Israelites were safe from all the plagues?
7. What did the Israelites put over their doors to protect them?
9. This plague is very similar to the grasshopper.
11. Pharaoh's heart was like a rock - it was \_\_\_\_.
12. The magicians stopped this many plagues.
14. What did Moses' snake do to the magician's snakes?



# 10

## Plagues (Exodus 7-12)

- AARON
- BLOOD
- BOILS
- DARKNESS
- DEATH
- EARTH
- EGYPTIANS
- ENCHANTMENTS
- FIRSTBORN
- FLAX
- FROGS
- GOD
- HAIL
- HEART
- HEBREWS
- LAMB
- LOCUSTS
- LORD
- MAGICIANS
- MOSES
- PASSOVER
- PHARAOH
- ROD
- SACRIFICES
- SERPENTS
- SMITE
- SWARMS OF FLIES
- THUNDER
- WIND

B	L	O	O	D	S	N	A	I	C	I	G	A	M		
A	N	X	S	E	C	I	F	I	R	C	A	S	D	O	
A	R	F	C	I	E	G	Y	P	T	I	A	N	S	A	S
T	H	I	H	A	T	H	U	N	D	E	R	S	W	R	E
H	R	P	A	S	S	O	V	E	R	S	E	K	S		
S	S	N	I	A	N	H	I	Y	A	T	R	N	E		
K	T	E	Y	R	X	T	R	N	L	X	N	B	E	T	
Q	B	K	Y	O	J	A	M	O	J	A	E	E	S	I	
O	O	C	B	N	X	E	R	E	D	L	P	H	S	M	
M	R	I	P	M	Y	D	I	S	N	F	R	O	G	S	
S	N	R	Z	L	A	X	Y	L	O	T	E	A	T	S	
R	Y	T	W	I	J	L	W	I	N	D	S	G	O	D	
V	X	S	W	A	R	M	S	O	F	F	L	I	E	S	
I	L	O	V	H	I	O	M	B	H	E	A	R	T	P	
L	O	C	U	S	T	S	I	H	O	A	R	A	H	P	

### Bonus Trivia

Fill out the verse, "In thy presence —;  
at thy right hand —."

Ps. 16:11.  
"is fulness of joy; at thy right hand  
there are pleasures for evermore."

# THE TEN PLAGUES

## (EXODUS 7:14-11:10; 12:29-30)

### MEMORY VERSE:

*"God delivers and rescues, and He works signs and wonders in heaven and on earth."*  
DANIEL 6:27

### CIRCLE THE CORRECT WORDS:

1. "The LORD spoke to Moses, 'Say to Aaron, "Take your rod and stretch out your hand over the waters of Egypt, over their streams, over their rivers, over their ponds, and over all their pools of water, that they may become **(OIL, BLOOD)**.'" " EXODUS 7:19
2. "Then the LORD spoke to Moses, 'Say to Aaron, "Stretch out your hand with your rod over the streams, over the rivers, and over the ponds, and cause **(FROGS, SNAILS)** to come upon the land of Egypt.'" " EXODUS 8:5
3. "The LORD said to Moses, 'Say to Aaron, "Stretch out your rod, and strike the dust of the land, so that it may become **(LICE, MICE)** throughout all the land of Egypt.'" " EXODUS 8:16
4. "And the LORD said to Moses, 'Rise early in the morning and stand before Pharaoh as he comes out to the water. Then say to him, "Thus says the LORD: 'Let My people go, that they may serve Me. Or else, if you will not let My people go, behold, I will send swarms of **(BEES, FLIES)** on you and your servants, on your people and into your houses.'" " " EXODUS 8:20-21
5. "Again the LORD said, "Behold, the hand of the LORD will be on your cattle in the field, on the horses, on the onkeys, on the camels, on the oxen, and on the sheep. There will be a very severe pestilence... So the LORD did this thing on the next day, and all the **(LIVESTOCK, BIRDS)** of Egypt died; but of the livestock of the children of Israel, not one died." EXODUS 9:3, 6
6. "So the LORD said to Moses and Aaron, 'Take for yourselves handfuls of ashes from a furnace, and let Moses scatter it toward the heavens in the sight of Pharaoh. And it will become fine dust in all the land of Egypt, and it will cause **(SOILS, BOILS)** that break out in sores on man and beast throughout all the land of Egypt.'" EXODUS 9:8-9
7. Then the LORD said, "Behold, tomorrow about this time I will cause very heavy **(HAIL, ROCKS)** to rain down, such as has not been in Egypt since its founding until now." EXODUS 9:18
8. "Then the LORD said to Moses, 'Stretch out your hand over the land of Egypt for the **(BUTTERFLIES, LOCUSTS)**, that they may come upon the land of Egypt, and eat every herb of the land - all that the hail has left.'" EXODUS 10:12
9. "Then the LORD said to Moses, 'Stretch out your hand toward heaven, that there may be **(DARKNESS, LIGHT)** over the land of Egypt.'" EXODUS 10:21  

"AND THE LORD SAID TO MOSES, 'I WILL BRING YET ONE MORE PLAGUE ON PHARAOH AND ON EGYPT. AFTERWARD HE WILL LET YOU GO FROM HERE.'" EXODUS 11:1  
MOSES THEN EXPLAINED TO THE ELDERS OF ISRAEL, "THE LORD WILL PASS THROUGH TO STRIKE THE EGYPTIANS; AND WHEN HE SEES THE BLOOD ON THE LINTEL AND ON THE TWO DOORPOSTS, THE LORD WILL PASS OVER THE DOOR AND NOT ALLOW THE DESTROYER TO COME INTO YOUR HOUSES TO STRIKE YOU." EXODUS. 12:23
10. "And it came to pass at midnight that the LORD struck all the **(FIRSTBORN, SECONDBORN)** in the land of Egypt, from the firstborn of Pharaoh who sat on his throne to the firstborn of the captive who was in the dungeon, and all the firstborn of livestock." EXODUS 12:29

**Year 1**

**Week 35**

## **Saved by Blood**

**Scriptures: Exodus 11, 12, 13**

**Key Verse: Exodus 12:13** “Now the blood shall be a sign for you on the houses where you are. And when I see the blood, I will pass over you; and the plague shall not be on you to destroy you when I strike the land of Egypt.”

### **Key Points:**

1. To deliver the people out of Egypt, God announces one final plague—the death of all the firstborn in Egypt. The oldest child in each family would die if the family was not protected by the blood of the lamb.
2. God gave Moses and Aaron specific instructions for the Hebrew people to follow so they would be safe from the coming plague. Explain these instructions and discuss the importance of the children of Israel in keeping them.
3. Also discuss how as Christians we are saved by the blood of the lamb. Our lamb being Christ who died on the cross, to save us from the bondage of our sins. As time permits, further discuss the parallels between the Passover and Christ.

Year 1, Week 35  
Exodus 11, 12, 13  
Saved by Blood, Passover Instituted

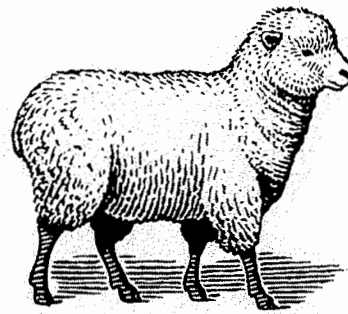
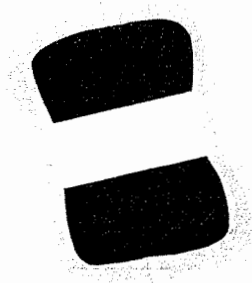

**Exodus 12:13**

'Now the blood shall be a sign for you on the houses where you are. And when I see the blood, I will pass over you; and the plague shall not be on you to destroy you when I strike the land of Egypt. (NKJV)



"Speak ye unto all the congregation of Israel, saying, In the tenth *day* of this month they shall take to them every man a lamb, according to the house of *their* fathers, a lamb for an house:"

**EXODUS 12:3**



The tenth plague caused the deliverance of the Israelites.  
An angel of God was sent to destroy every first-born in  
Egypt, man and beast alike.

The blood of a perfect lamb appearing upon the doorposts  
of the Israelites, as commanded by Moses, caused the angel  
of God to pass over their homes.

# Leaving Egypt Tonight

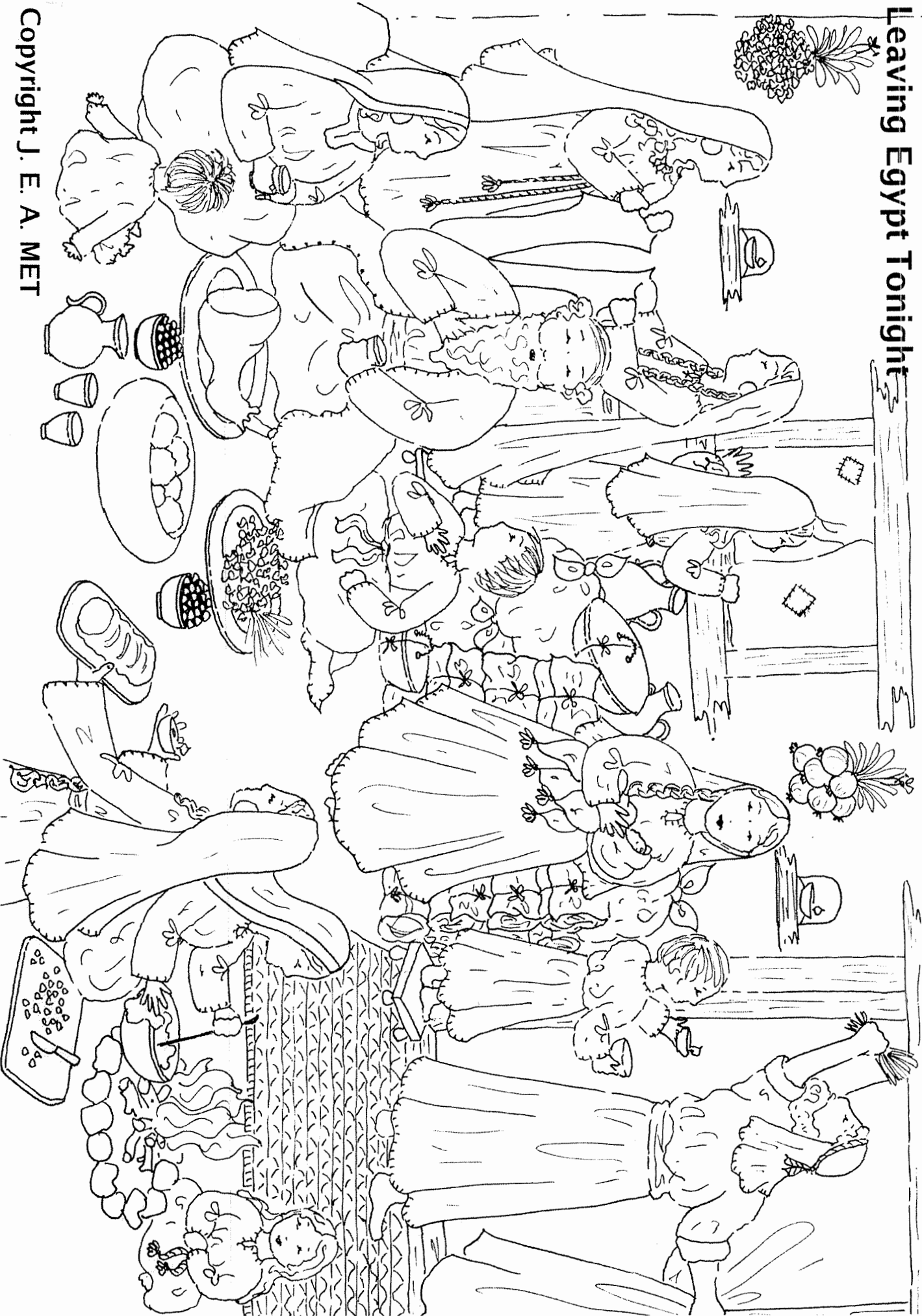

Copyright J. E. A. MET

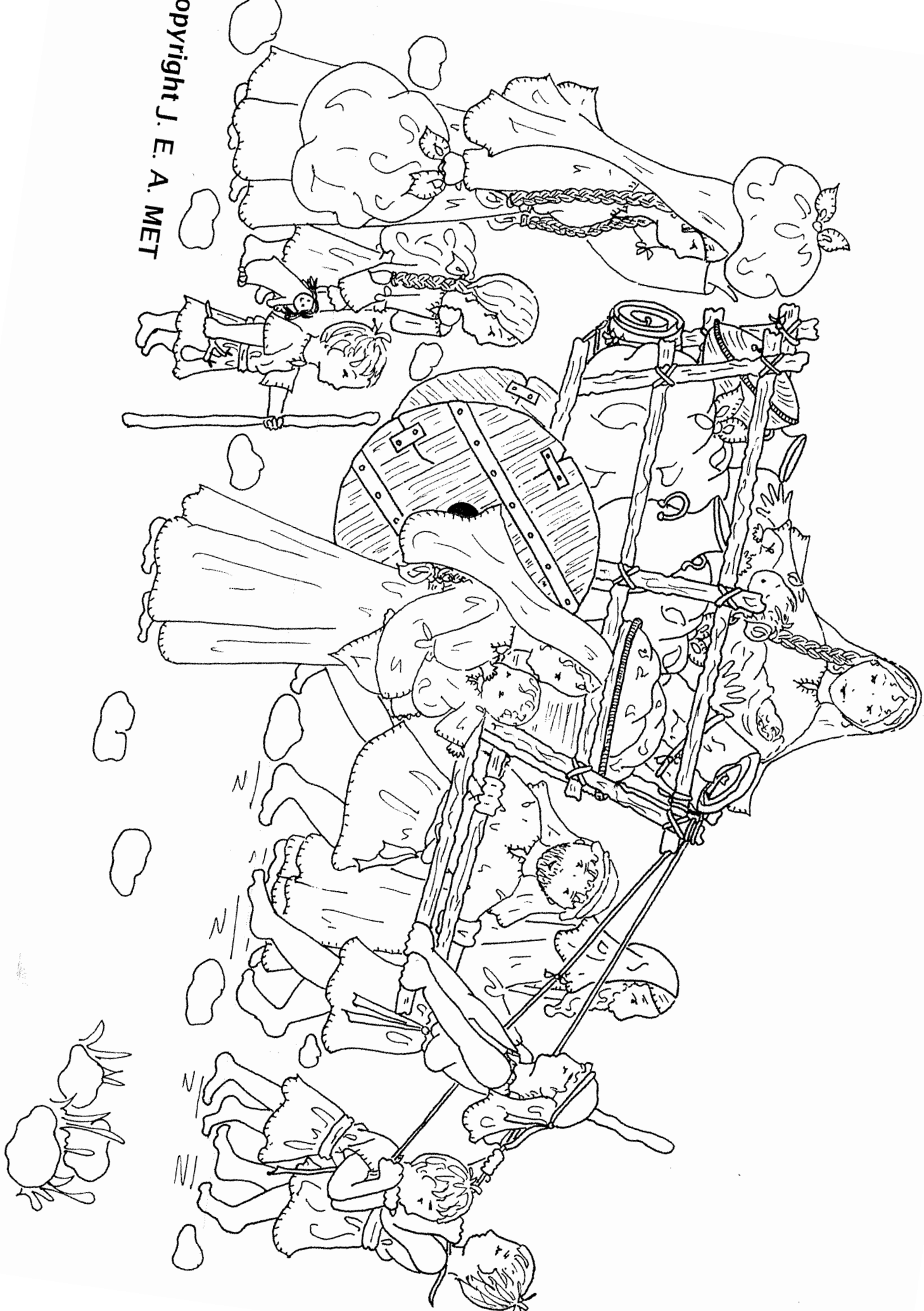

Copyright J. E. A. MET





The Israelites were told to kill a lamb and put the blood on the door. Then the death angel would pass over. The firstborn in each Egyptian family was killed. There was much sorrow in Egypt.

*Exodus 12:3-13, 29, 30*

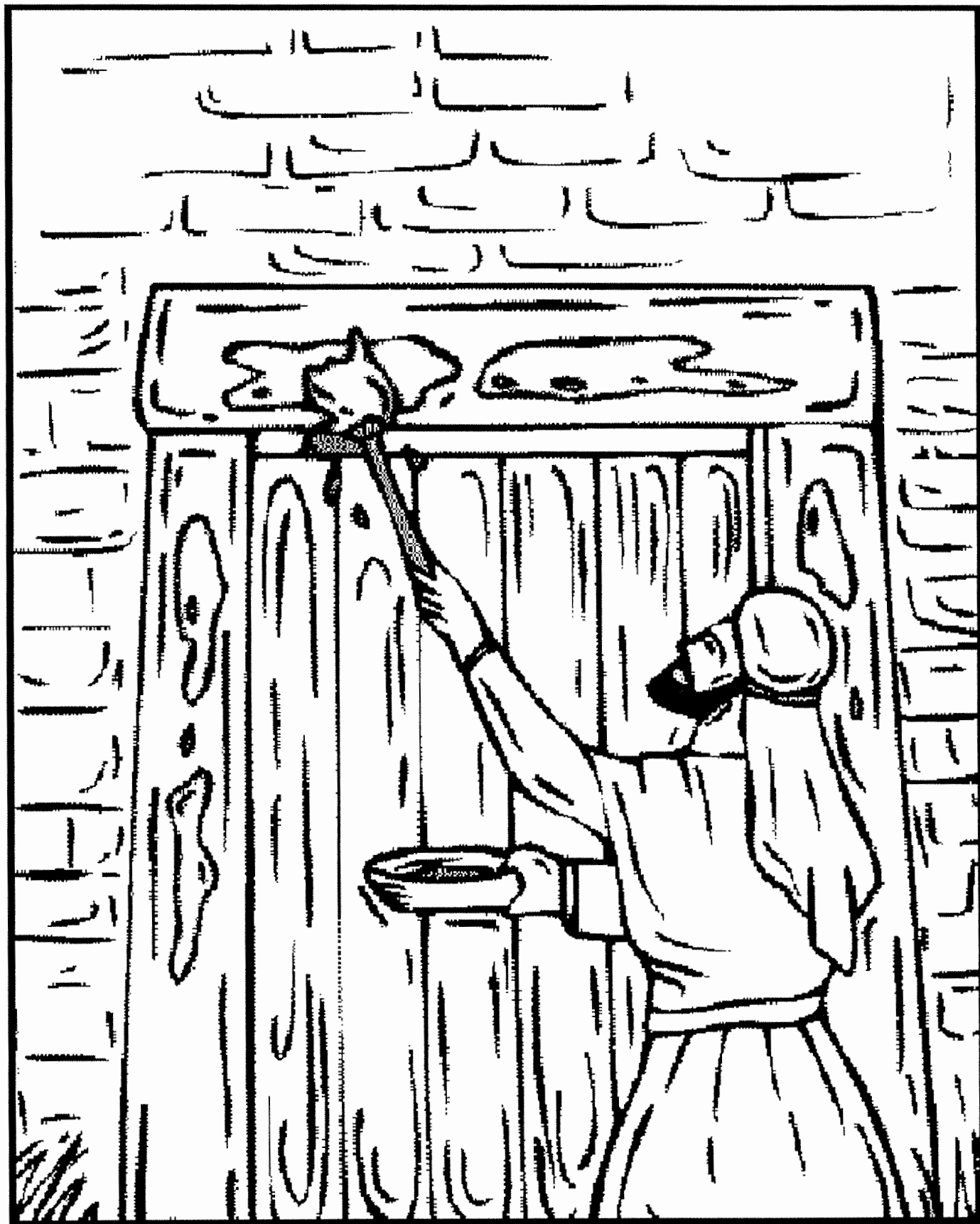

# Bible Story Craft - The Passover

## Materials:

1. For the doorposts, pieces of wood nailed together would be best, or cardboard colored brown, or brown construction paper..
2. For the lamb, cardboard or heavy construction paper, cotton puffs for the wool.
3. For the blood on the door post, red paint, felt pen or crayon

## Instructions:

1. Have the three pieces of wood nailed together, or trace the drawing on cardboard and color it brown, or trace it on brown construction paper.

Explain to the children how the LORD told Moses he was going to pass through Egypt on a night, and all the firstborn in the land of Egypt, both man and beast would die.. (Exodus 12:12)

2. Trace the lamb onto cardboard or heavy construction paper, color the legs and face white or what color you like, paste on cotton puffs for the wool.

Explain to the children how each household took a lamb into their house, where it lived with them for 4 days in the house, and then it was killed in the evening to provide the blood that would protect those in the house.

3. Take red paint or red felt pen or crayon and put red on the top of the doorpost, and each side.

Explain to the children that the blood of the lamb was put on the doorposts, and each side post, to protect all who were in the house when the LORD passed through to kill all the firstborn in the land of Egypt. Tell them that everyone who was in the house protected by the blood of the lamb remained alive, because the LORD passed over the house when he saw the blood.

Explain to the children that this is a picture of the Lord Jesus Christ who is the Lamb of God, who shed his precious blood to atone for our sins on

Calvary's cross.

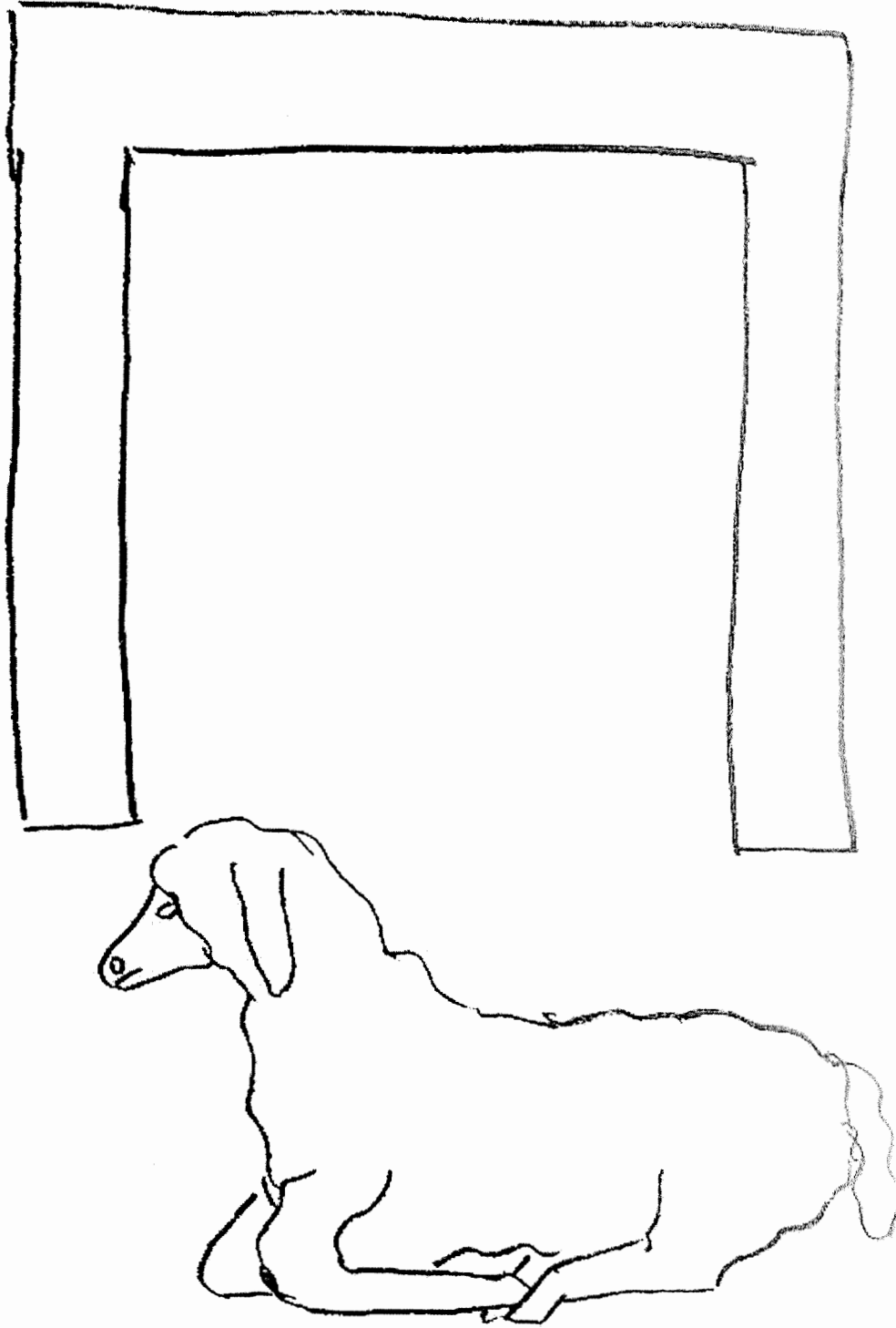

Little Lambs Ministry



## **Jesus is our Passover Lamb**

### **1 Peter 1:19-21**

**19** But with the precious blood of Christ, as of a lamb without blemish and without spot:

**20** Who verily was foreordained before the foundation of the world, but was manifest in these last times for you,

**21** Who by him do believe in God, that raised him up from the dead, and gave him glory; that your faith and hope might be in God.

# 38. THE FIRST PASSOVER

(EXODUS 12:1-28)

A N E V E S C D Y M Z P W C F  
 M Q W Z Q F T J O B X D R O L  
 X Z R C J J I Q F L R Z M G L  
 T M O S E S O R V L E E F R L  
 Y U R E V O S S A P P T A G M  
 L A P C B T T I L S J W N D S  
 B N E Q B E A L S V H B I I Z  
 L M S I R J N S V O G M X N L  
 O D E N E V A E L N U H G G F  
 O G G W B M A L M J E S Y Z P  
 D F D Z B Z R T A J U I P J G  
 I H E K K Z P F Z E W M Y P K  
 D O O R P O S T S A D E B N B  
 O A P K E K I A S W W L D U U  
 V N O R A A Q Y H L Y B R O K

AARON

DOORPOSTS

MOSES

BLEMISH

LAMB

PASSOVER

BLOOD

LINTEL

SEVEN

BREAD

LORD

UNLEAVENED

# 38. THE FIRST PASSOVER

(EXODUS 12:1-28)

U M E P R O M Y M B H S Q N Y J Z A F W  
 G B Y M X W F J D H A M U M F P H S L Q  
 I P G D O H D T W B L E M I S H K V Y N  
 C M R B U Q M A Q F U J Q B O G K Y H I  
 E O M B S N Q N E V U T T C J H R K R S  
 L W Q O L I L N O R A A H D L E T N I L  
 U N H H K L S E R I B A T W W G E W O V  
 X G V S W H Q A A O T A T K S R N L I U  
 M K V S V T V S I V T U R I D E C W R U  
 K B G R J Y P L T N E E R O S V V W F A  
 U M S V P O B P A H D N O E I O C Z Y D  
 Y Y O N W D Q U L I D L E P A S C O X D  
 Y K N S E A O T B U B N W D G S H A D W  
 R P B G E V J O B M A L N I W A R B F T  
 F U N D L S I N R A Q Q E Y A P E U B L  
 H Y N P V C C D Z P C R V B F D M N E A  
 E F O N D A T R Z F O N E B U V Q U H O  
 L K J S D L C A N F U S S P T B N D T A  
 M T Q P Z O J Z K T J A T P O G Y L L P  
 G G S P Z Z W E O Q K Y P S M C M U U A

**AARON**

**DOORPOSTS**

**MOSES**

**BLEMISH**

**LAMB**

**PASSOVER**

**BLOOD**

**LINTEL**

**SEVEN**

**BREAD**

**LORD**

**UNLEAVENED**

# The First Passover

"When I see the blood, I will pass over you." Exodus 12:13

The puzzle is based on Exodus 12:1-14



E N B R E A D F L R E D H O P  
 A S F A Y I O P A S S O V E R  
 D O O R V E E U I V B V Y L Q  
 F R F Q Y Y V K Z S M U Q M V  
 L J A B U R O C E K R A Z O B  
 G D M E H M Z I X T Z A L B R  
 P D I R Y E G Y P T W N E E E  
 M L L Q L B J G T H G L U L S  
 O A Y U S N U M D I A G G E C  
 S M G F L B D A L V A J L B S  
 E B T H T M G U A L T Z B X O  
 S S P A E L M T P R A F L N A  
 U K E Q C M E R B F O I O U B  
 N M S F J Y N M V T J N O Y O  
 U X O F G K T L A M B P D W J

MALE	BREAD	ISRAEL	AARON	PLAGUE
FAMILY	MOSES	LAMB	JUDGMENT	DOOR
EGYPT	BLOOD	PASSOVER	LAMBS	MEAT



# 38. THE FIRST PASSOVER

## (EXODUS 12:1-28)

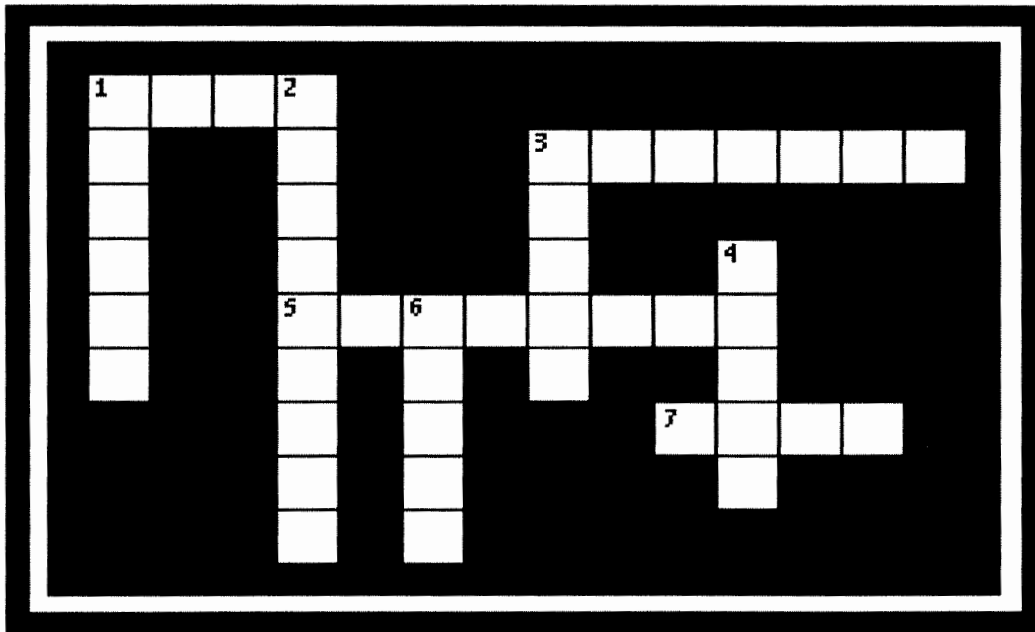

- 3 DOWN "But now in Christ Jesus you who once were far off have been made near by the \_\_\_\_\_ of Christ." **EPHESIANS 2:13**
- 7 ACROSS The LORD said, "Speak to all the congregation of Israel, saying: 'On the tenth day of this month every man shall take for himself a \_\_\_\_\_, according to the house of his father, a lamb for a household.' " **EXODUS 12:3**
- 3 ACROSS The LORD said, "Your lamb shall be without \_\_\_\_\_, a male of the first year." **EXODUS 12:5**
- 4 DOWN Also the LORD said to Moses, "In the first month, on the fourteenth day of the month at evening, you shall eat unleavened \_\_\_\_\_, until the twenty-first day of the month at evening." **EXODUS 12:18**
- 6 DOWN "For \_\_\_\_\_ days no leaven shall be found in your houses, since whoever eats what is leavened, that same person shall be cut off from the congregation of Israel, whether he is a stranger or a native of the land." **EXODUS 12:19**
- 5 ACROSS "Then Moses called for all the elders of Israel and said to them, 'Pick out and take lambs for yourselves according to your families, and kill the \_\_\_\_\_ lamb.'" **EXODUS 12:21**
- 1 DOWN Moses told them, "You shall take a bunch of hyssop, dip it in the blood that is in the basin, and strike the \_\_\_\_\_ and the two doorposts with the blood that is in the basin." **EXODUS 12:22**
- 2 DOWN Then Moses said to them, "For the LORD will pass through to strike the Egyptians; and when He sees the blood on the lintel and on the two \_\_\_\_\_ the LORD will pass over the door and not allow the destroyer to come into your houses to strike you." **EXODUS 12:23**
- 1 ACROSS "Then the children of Israel went away and did so; just as the \_\_\_\_\_ had commanded Moses and Aaron, so they did." **EXODUS 12:28**

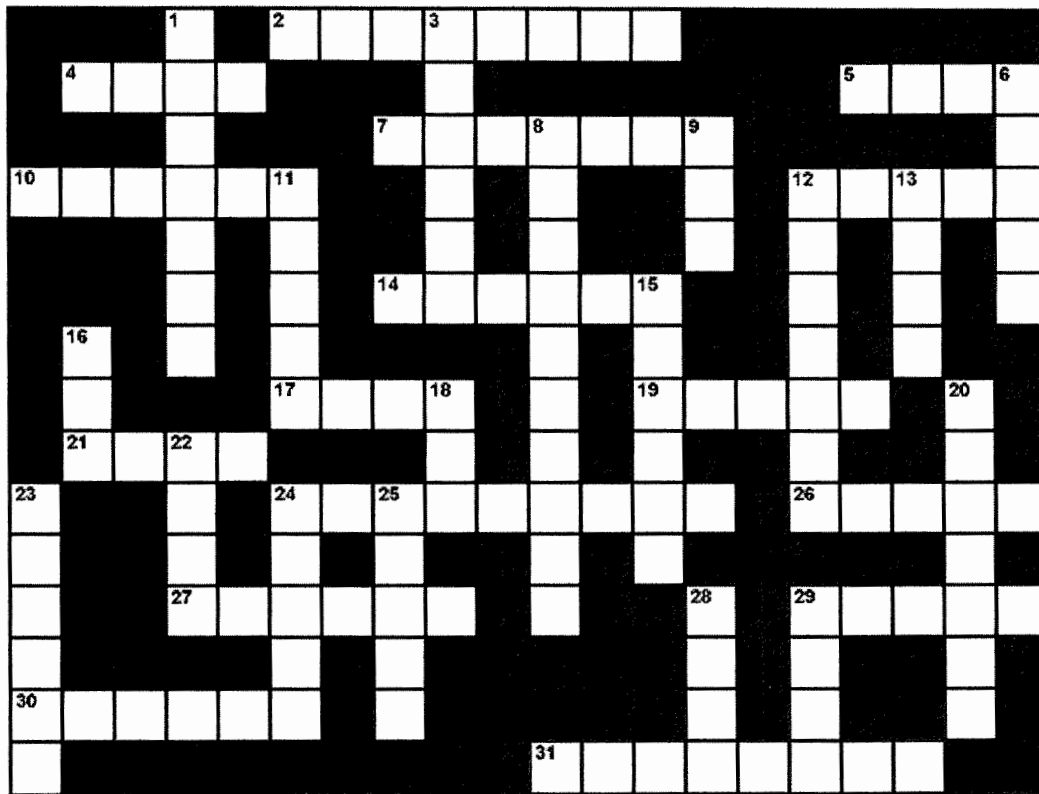

## Genesis and Exodus

### Across

- 2. The youngest son of Jacob *Gen. 35:16-18*
- 4. The first listed son of Noah *Gen. 5:32*
- 5. The first person murdered *Gen. 4:8*
- 7. The son of Abraham and Hagar *Gen. 16:15*
- 10. Sold as a slave *Gen. 37:28*
- 12. His name was changed to Israel. *Gen. 35:10*
- 14. One of two sisters married to Jacob *Gen. 29:15*
- 17. He was told to build a large boat *Gen. 6:13-14*
- 19. A shepherd that became a great leader of Israel *Ex. 3:1, 10*
- 21. Jacob's twin brother *Gen. 25:24*
- 24. Abraham and Isaac told the same lie to this man. *Gen. 20:4-11, 26:9*
- 26. The mother of Ishmael *Gen. 16:15*
- 27. The sister of Moses *Ex. 6:20, 15:20*
- 29. Abraham's wife *Gen. 17:15*
- 30. Jacob's oldest son *Gen. 29:31-32*
- 31. This man had Joseph thrown into prison. *Gen. 39:1, 20*

### Down

- 1. Isaac's wife *Gen. 24:67*
- 3. God chose this man to take the place of Moses. *Numbers 27:17-18*
- 6. The brother of Rebekah *Gen. 24:29*
- 8. The oldest man named in the Bible *Gen. 5:27*
- 9. The nephew of Abraham *Gen. 12:5\**
- 11. Abram went to this place on the way to Canaan. *Gen. 12:5*
- 12. The third listed son of Noah *Gen. 5:32*
- 13. The first murderer *Gen. 4:8*
- 15. The father of Noah *Gen. 5:28-29*
- 16. The first wife *Gen. 4:1*
- 18. The second listed son of Noah *Gen. 5:32*
- 20. The ruler of Egypt *Gen. 41:46*
- 22. Made in the image of God *Gen. 1:26*
- 23. Moses' father-in-law *Ex. 3:1*
- 24. The brother of Moses *Ex. 6:20*
- 25. The promised son of Abraham *Gen. 21:1-3*
- 28. The priesthood of Israel came from this man. *Ex. 6:16-20, Ex. 32:28, Ex. 28:1*

\* word not in verse

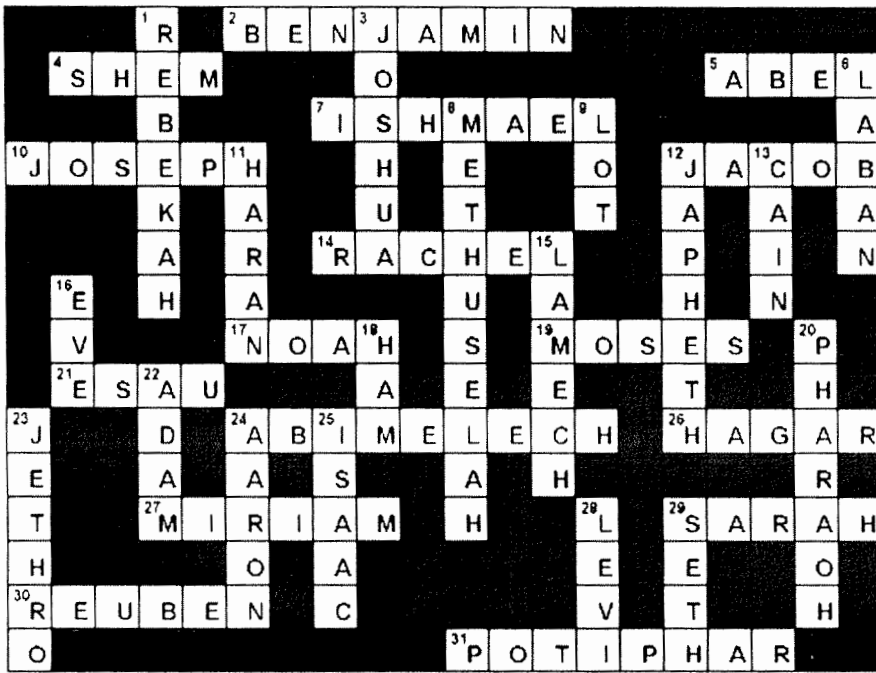

Crossword

Page 2 of 2

29. Eve said this son took the place of Abel. Gen 4:25

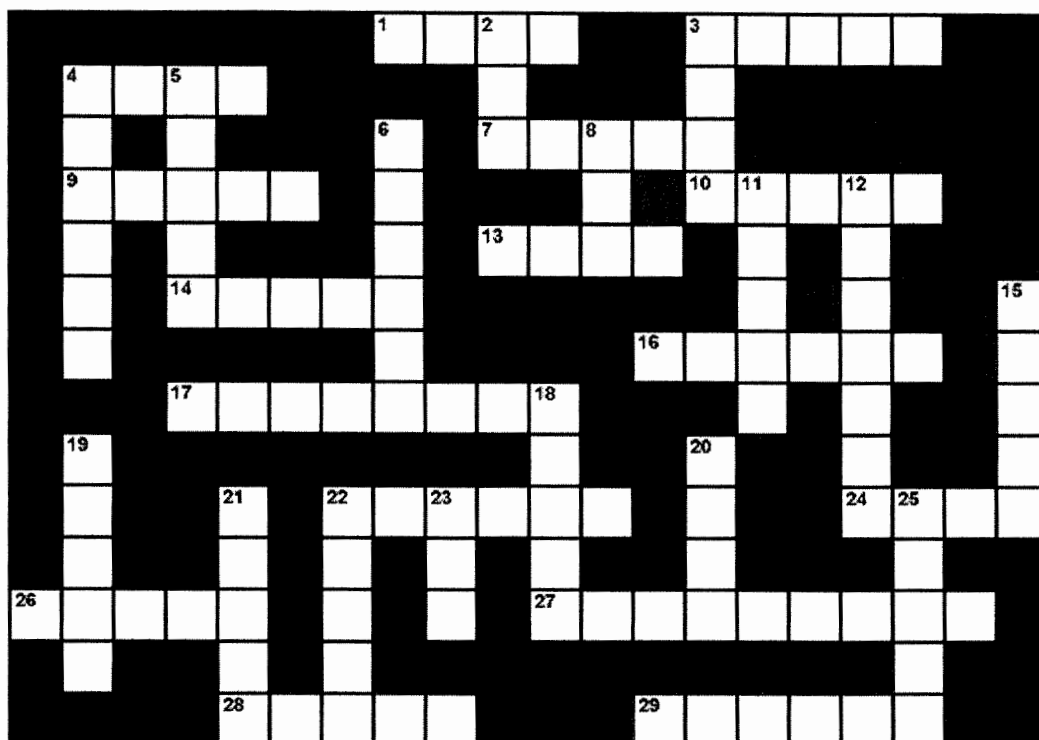

## Exodus

### Across

1. The famous river in Egypt (4)
3. This plague could be the plague of roaches. (5) Ex. 8:21
4. In the last plague, every firstborn who was not in a house with blood on the door lost his/her \_\_\_\_\_. (4) Ex. 12:29 \*
7. This turned to blood (5) Ex. 7:17
9. The Israelites were guided by the \_\_\_\_\_ during the day. (5) Ex. 13:21
10. The Israelites were slaves in this country. (5) Ex. 1:8,13 Ex. 4:7
13. Moses put his \_\_\_\_\_ into his cloak and it was covered with leprosy. (4)
14. God delivered the law on this mountain (5) Ex. 19:20 Ex. 3:1
16. The father-in-law of Moses (6)
17. The next to the last plague. (8) Ex. 10:21
22. The sister of Moses (6) Ex. 15:20 Ex. 6:20
24. This plague was a combination of \_\_\_\_\_ and fire. (4) Ex. 9:23
26. Because of this plague, the magicians could not stand before \_\_\_\_\_ (4) Ex. 9:11

### Down

2. Moses went up on the mountain to get the \_\_\_\_\_. (3) \*
3. At night the Israelites were lead by a pillar of \_\_\_\_\_. (4) Ex. 13:21
4. These insect ate everything that green in the land of Egypt. (6) Ex. 10:4-5
5. They piled them up in big stacks and the smelled awful. (5) Ex. 8:14
6. After Moses killed an Egyptian, he ran to this wilderness. (6) Ex. 2:15
8. The number of plagues (3) \*
11. The third plague (5) Ex. 8:17
12. The ruler of Egypt (7) Ex. 5:1
15. The meat that God supplied for the people. (5) Ex. 16:13
18. Aaron threw down his \_\_\_\_\_ before Pharaoh. (5) Ex. 7:10
19. The Nile River turned to \_\_\_\_\_. (5) Ex. 7:20
20. The Egyptians worshiped many \_\_\_\_\_. (4) Ex. 12:12
21. This eighty year old shepherd Ex. 31, Ex. 7:7

\* word not in verses

Moses. (5)

27. The last plague. (9) Ex.11:4-5

28. Aaron's rod became a \_\_\_\_\_.  
(5) Ex.7:10\*

29. This Egyptian land was given to the Israelites. (6) Gen 47:27

became a great leader (5)

22. The first food provided by God while the people were in the wilderness (5) Ex.16:31

23. The Israelites crossed the \_\_\_\_\_ Sea on dry ground. (3) Ex.13:18, Ex.14:22

25. The brother of Moses (5) Ex.6:20



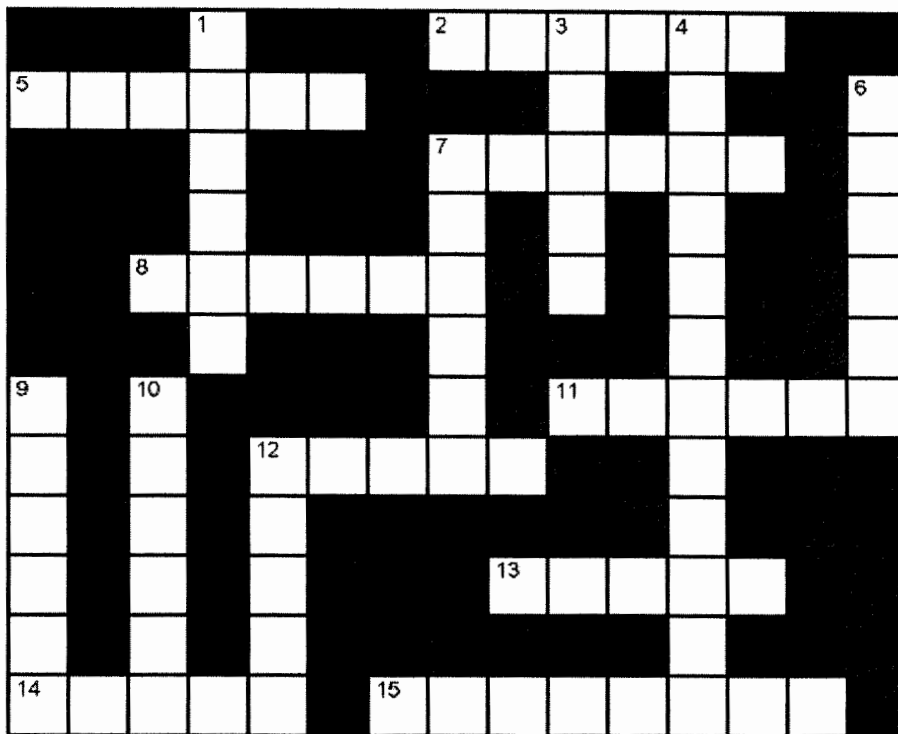

# Moses

## Across

- 2. God provided cities of \_\_\_\_\_ for those who had accidentally harmed another person. (6) Num. 35:6
- 5. The place where the Israelites camped before they spied out the Promised Land/ (6) Numbers 20:1
- 7. The important river in the Promised Land (6) Num. 22:1
- 8. It took two men to carry the cluster of \_\_\_\_\_ found in the land. (6) Num. 13:23
- 11. When the people were being bitten by snakes, God told them to put up a \_\_\_\_\_ snake so that those who looked at it would not die. (6) Num 21:9 \*
- 12. The mountain where the law was given. (5) Ex. 19:20
- 13. The land flowed with milk and \_\_\_\_\_. (5) Deut. 6:3
- 14. The exodus leader of Israel (5) Ex 3:10
- 15. The people were going to the \_\_\_\_\_ Land. (8) Deut. 6:3

## Down

- 1. The Israelites wandered in the \_\_\_\_\_ because they did not believe. (6) Ex. 16:2, Num. 14:28-34
- 3. How many years did the Israelites wander. (5) Ex. 16:35, Num 14:28-34
- 4. The spies said the Israelites were like these insects in the eyes of the Canaanites. (12) Num. 13:33
- 6. The number of spies (6) Deut. 1:21-24
- 7. Moses' aide (6) Ex. 24:13
- 9. A prophet (6) Num. 22:38
- 10. There were \_\_\_\_\_ in the Land. (6) Deut. 1:28
- 12. One chosen from each tribe (5) Deut. 1:21-23

\* not the exact word



# 38. THE FIRST PASSOVER

## (EXODUS 12:1-28)

### MEMORY VERSE:

*"But now in Christ Jesus you who once were far off have been made near by the blood of Christ."*  
EPHESIANS 2:13

*"Now the LORD spoke to Moses and Aaron in the land of Egypt, saying, 'This month shall be your beginning of months; it shall be the first month of the year to you.'" EXODUS 12:1-2*

### FILL IN THE BLANKS:

1. The LORD said, "Speak to all the congregation of Israel, saying: 'On the tenth day of this month every man shall take for himself a \_\_\_\_\_, according to the house of his father, a \_\_\_\_\_ for a household.'" EXODUS 12:3
2. The LORD said, "Your lamb shall be without \_\_\_\_\_, a male of the first year." EXODUS 12:5

### TRUE OR FALSE:

3. Also the LORD said to Moses, "In the first month, on the fourteenth day of the month at evening, you shall eat unleavened bread, until the twenty-first day of the month at evening." EXODUS 12:18  
TRUE OR FALSE
4. "For seven days no leaven shall be found in your houses, since whoever eats what is leavened, that same person shall be cut off from the congregation of Israel, whether he is a stranger or a native of the land." EXODUS 12:19  
TRUE OR FALSE

### FILL IN THE BLANKS:

5. "Then Moses called for all the elders of Israel and said to them, 'Pick out and take lambs for yourselves according to your families, and kill the \_\_\_\_\_.'" EXODUS 12:21

### CIRCLE THE CORRECT WORDS:

6. Moses told them, "You shall take a bunch of hyssop, dip it in the (WATER, BLOOD) that is in the basin, and strike the lintel and the two doorposts with the (WATER, BLOOD) that is in the basin." EXODUS 12:22

### FILL IN THE BLANKS:

7. Then Moses said to them, "For the LORD will pass through to strike the Egyptians; and when He sees the blood on the \_\_\_\_\_ and on the two \_\_\_\_\_, the LORD will pass over the door and not allow the destroyer to come into your houses to strike you." EXODUS 12:23

### TRUE OR FALSE:

8. But the children of Israel would not do those things which the LORD had commanded Moses and Aaron.  
EXODUS 12:28

TRUE OR FALSE



# Places the Israelites Visited

After God's people had lived in Egypt for more than 400 years, God chose Moses to lead them to the land of Canaan, the land God promised to Abraham. Because the people disobeyed God, they wandered in the wilderness for many years before entering the Promised Land.

Unscramble the names of the places the Israelites visited or lived and write them on the lines. Then find the places in the word search puzzle. If you need help unscrambling the places, you can look up the Bible verses.



**GEPTY** \_\_\_\_\_  
(Exodus 12:41)

**EKHADS-ANAERB** \_\_\_\_\_  
(Numbers 34:4)

**ERD ASE** \_\_\_\_\_  
(Exodus 15:4)

**OEMD** \_\_\_\_\_  
(Numbers 20:23)

**RAMHA** \_\_\_\_\_  
(Exodus 15:23)

**NMTUO OHR** \_\_\_\_\_  
(Numbers 20:22)

**IHEPIMDR** \_\_\_\_\_  
(Exodus 19:2)

**OBMA** \_\_\_\_\_  
(Deuteronomy 34:1)

**UONMT ISANI** \_\_\_\_\_  
(Exodus 19:11)

**HET AJNDRO** \_\_\_\_\_  
(Numbers 22:1)

**EAHRATB** \_\_\_\_\_  
(Numbers 11:3)

**NACANA** \_\_\_\_\_  
(Exodus 16:35)

**ZOHATREH** \_\_\_\_\_  
(Numbers 11:35)

**Year 1**

**Week 36**

## **Crossing the Red Sea**

**Scriptures: Exodus 14**

**Key Verse: Exodus 14:14 The Lord will fight for you, and you shall hold your peace.**

**Key Points:**

1. Pharaoh's army pursued the Israelites. The Israelites panicked when they saw the army, and thought they would die. They were ready to give up.
2. Moses spoke to God, and He sent a strong wind to hold the waters of the sea into a wall.
3. The Israelites crossed the sea on dry land.
4. When the army followed them into the sea, God caused the water wall to collapse and kill all of the Egyptians.
5. God hears our prayers, and will always help us when we are following his will.

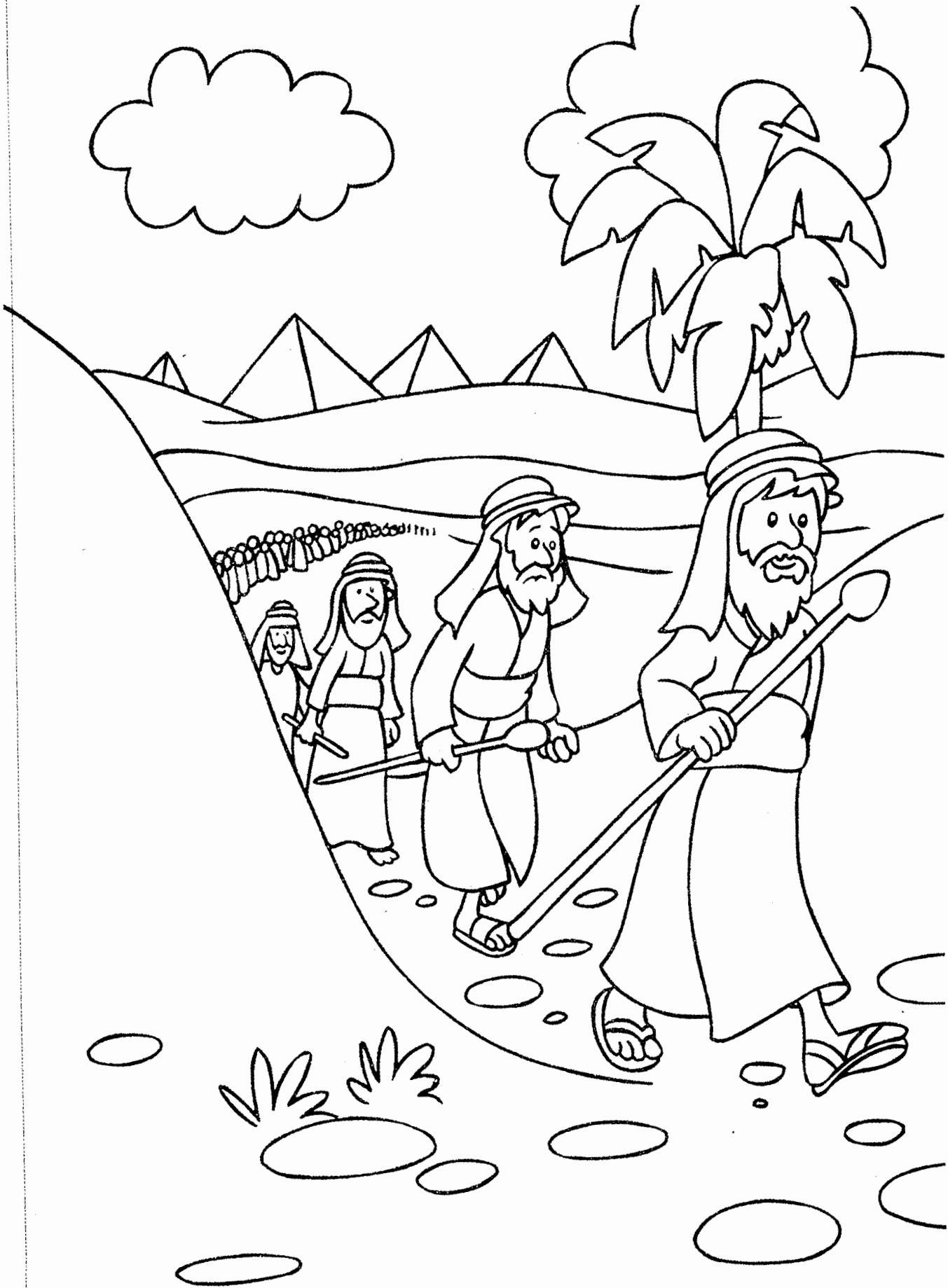

**Moses Leads His People Out Of Egypt**

Exodus 13

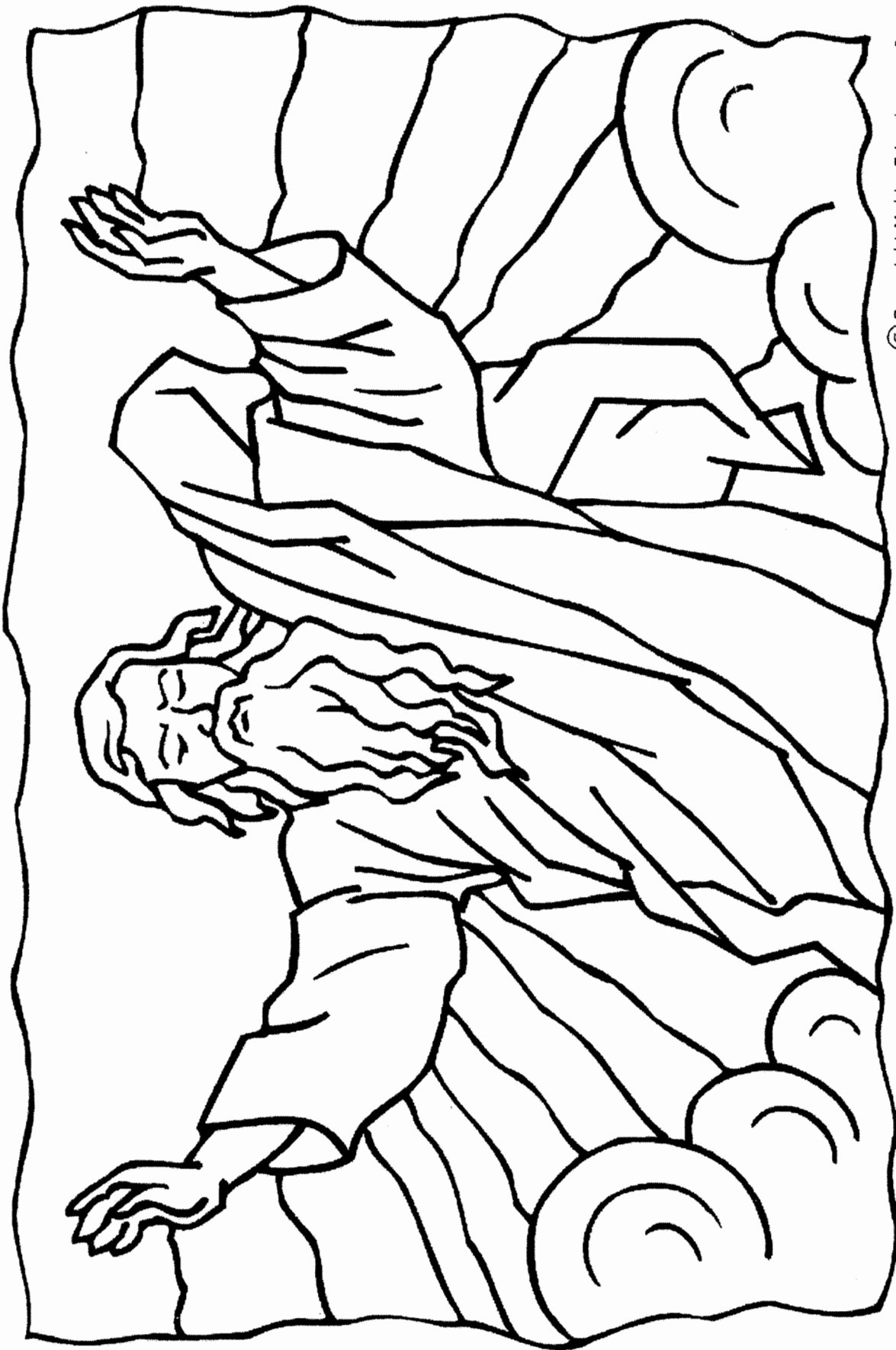

© Copyright MakingFriends.com, Inc.



... the waters parted to let them pass. The Pharaoh's army, pursuing the Israelites, was swallowed by the waters.

**1.**

---

Israel needed  
to cross the Sea.

---

**2.**

---

Moses obeyed  
God and showed  
Israel how to  
cross.

---

**3.**

---

Splash!  
The chasing  
Egyptians were  
defeated.

---

**4.**

---

God brought Israel  
safely across!

---

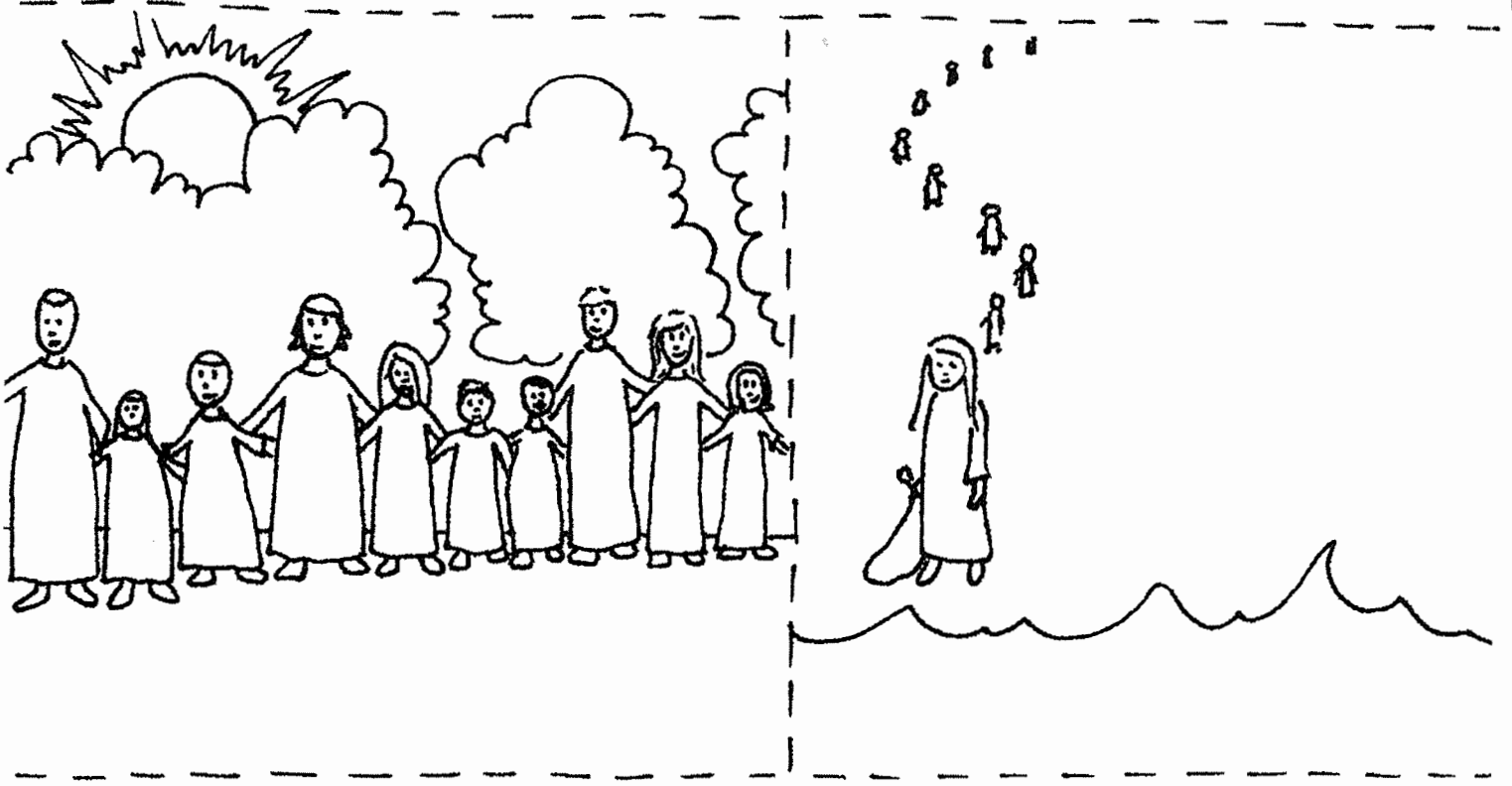

Crossing the Red Sea...

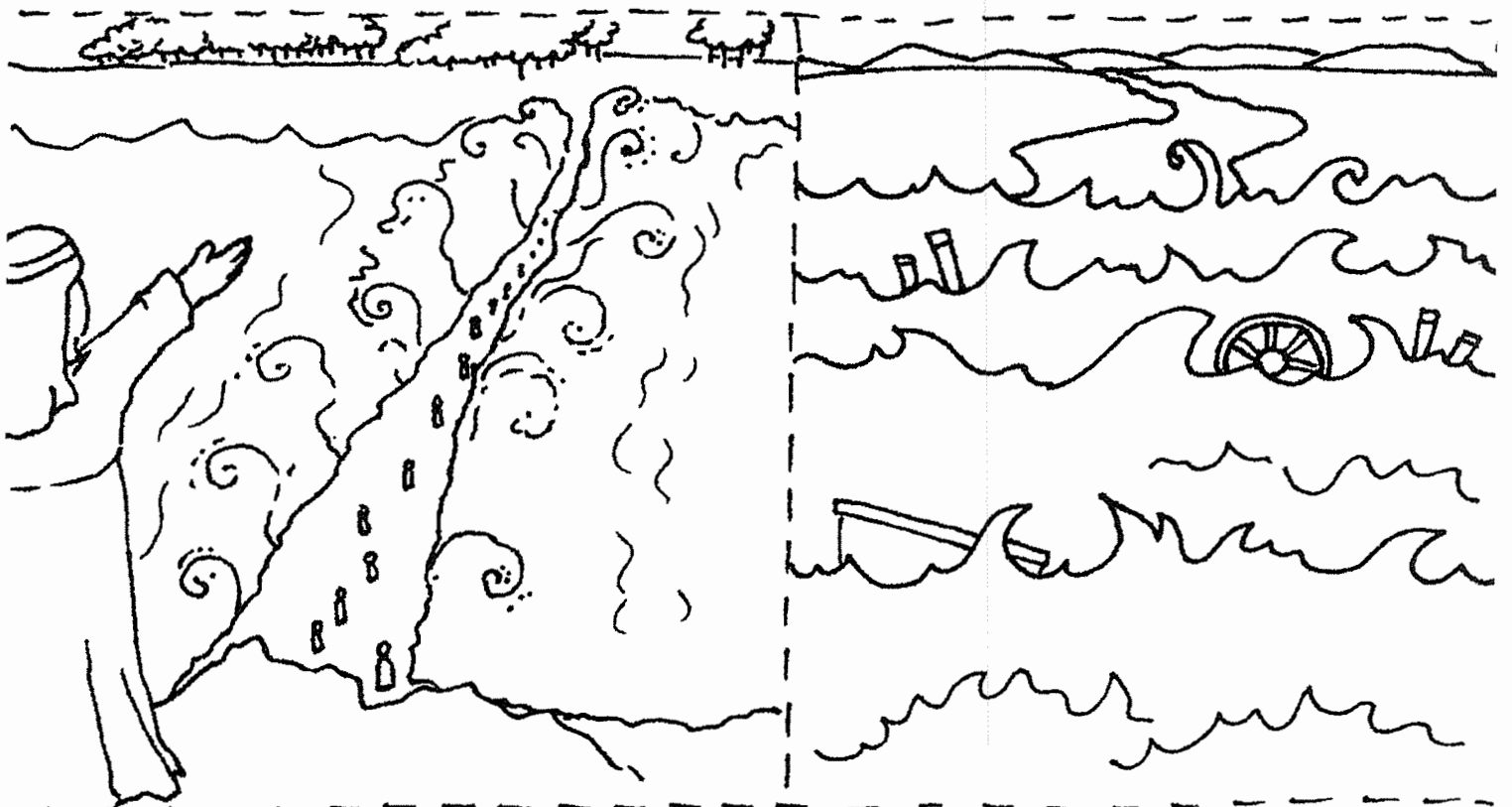



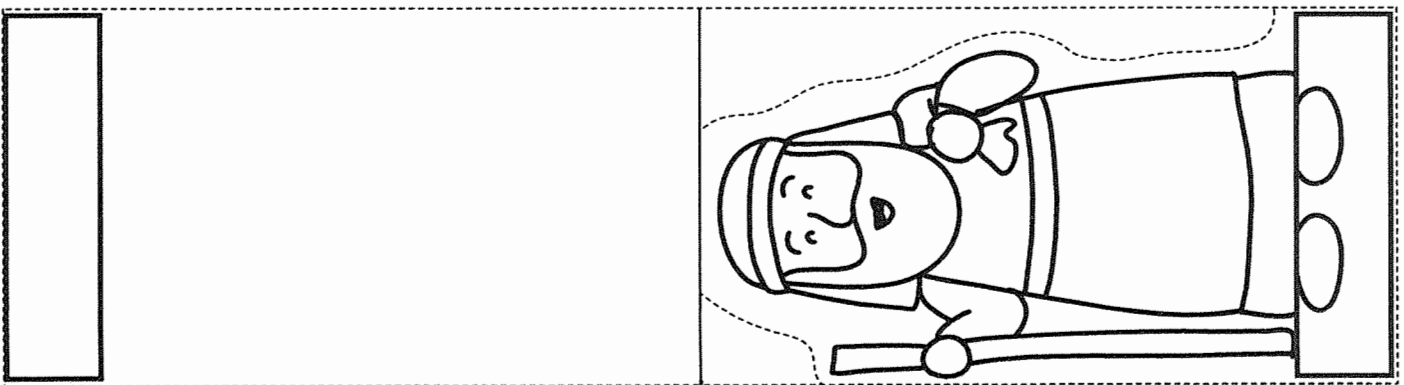
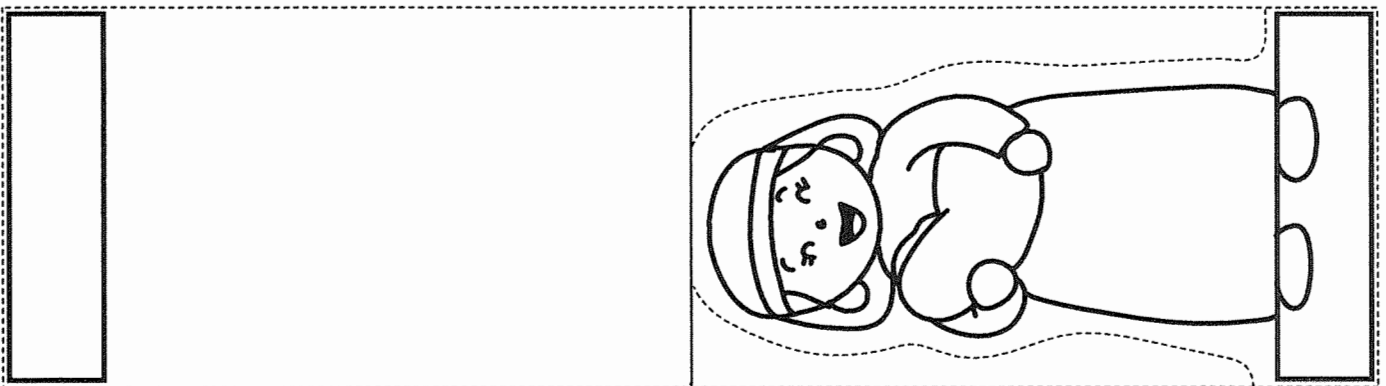
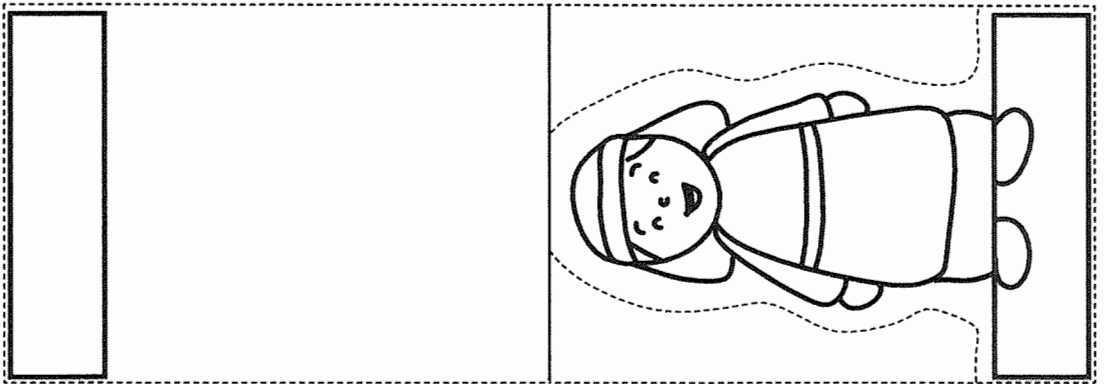
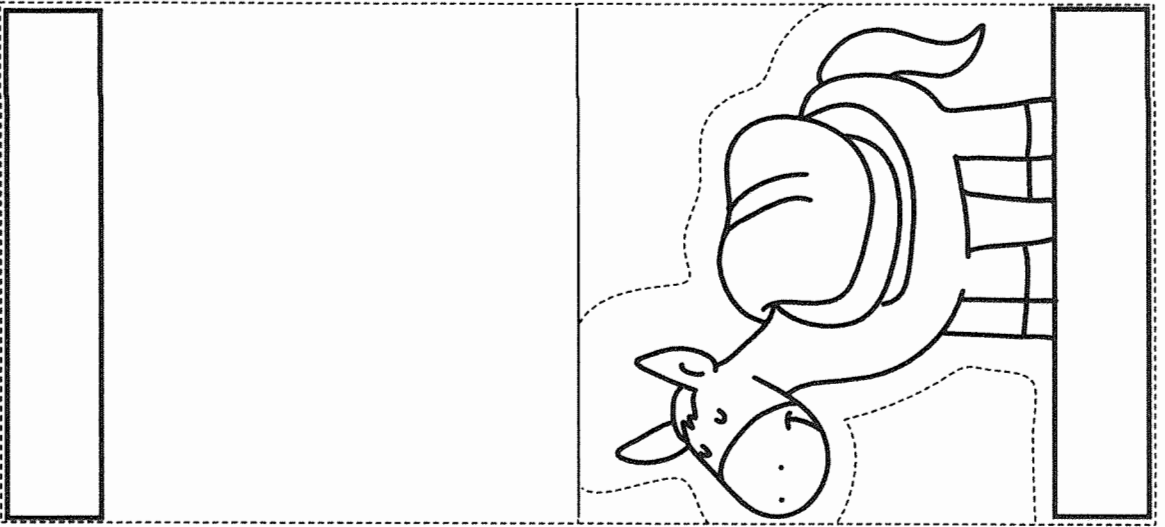

## Cross the Red Sea

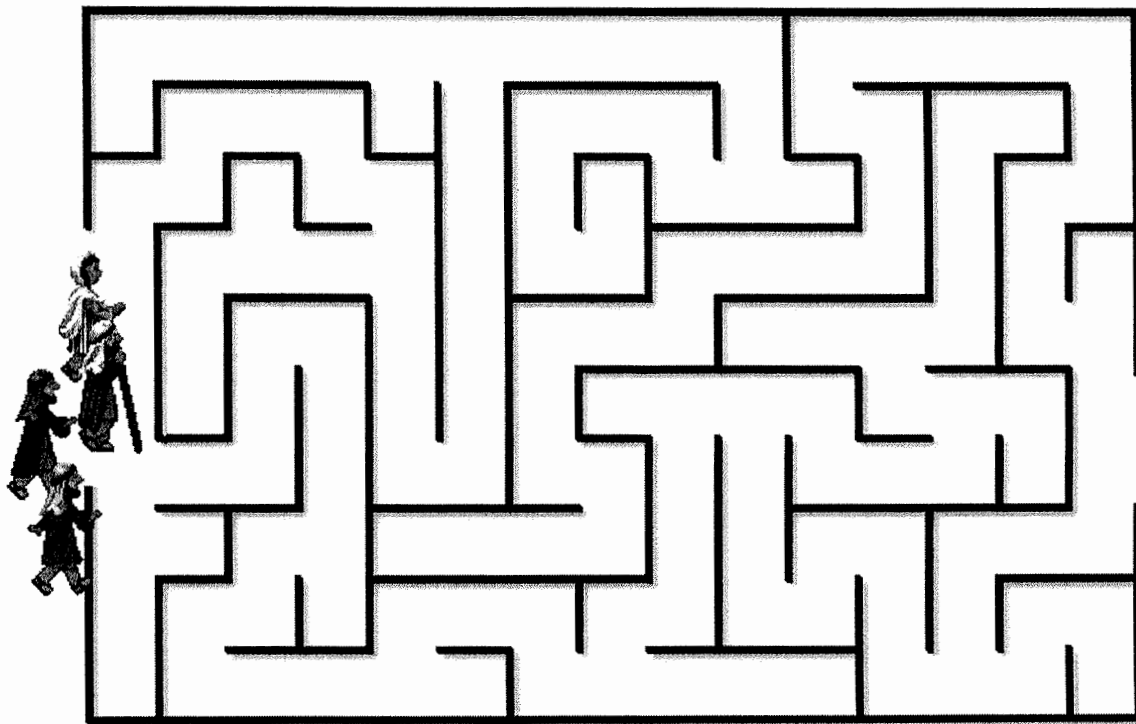

To print, click on FILE (usually located at the top left corner of your browser's screen) then select PRINT.

---

RETURN TO BILLY BEAR'S [PESACH PAGE](#)

Graphics and Content Copyright ©1998 Loraine Wauer Ferus

# THE EXODUS

Guide the Israelites across the Red Sea.

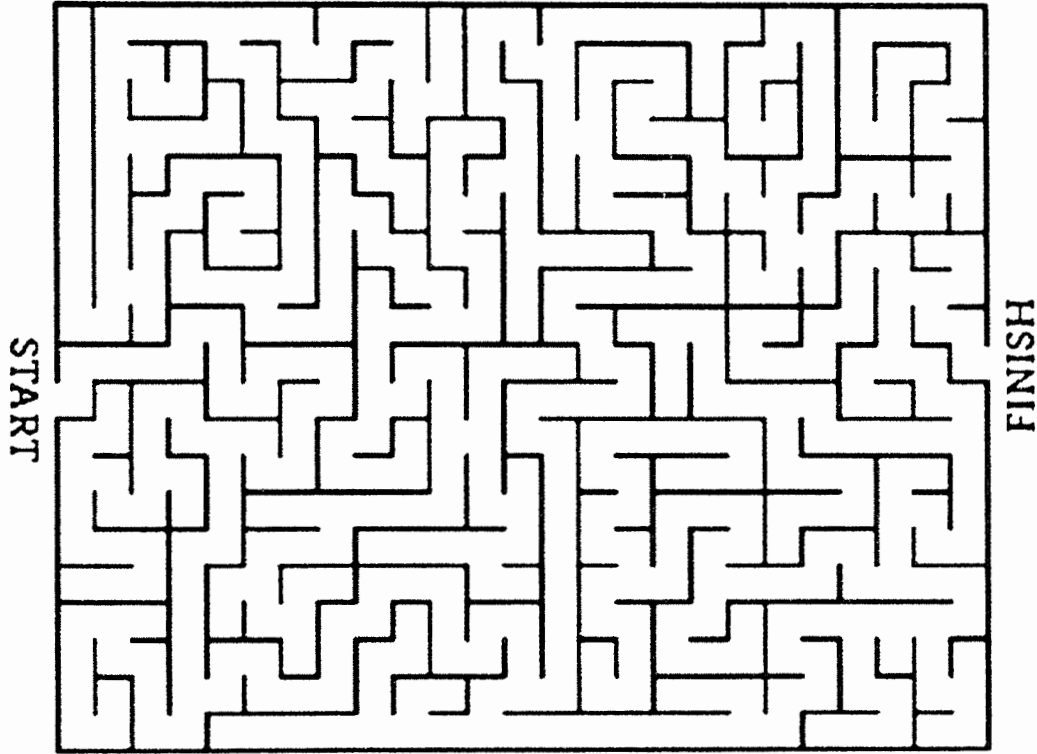

© David A. Cole. All Rights Reserved. Reproduction or Reselling is Forbidden. Not for use without an active David A. Cole subscription.

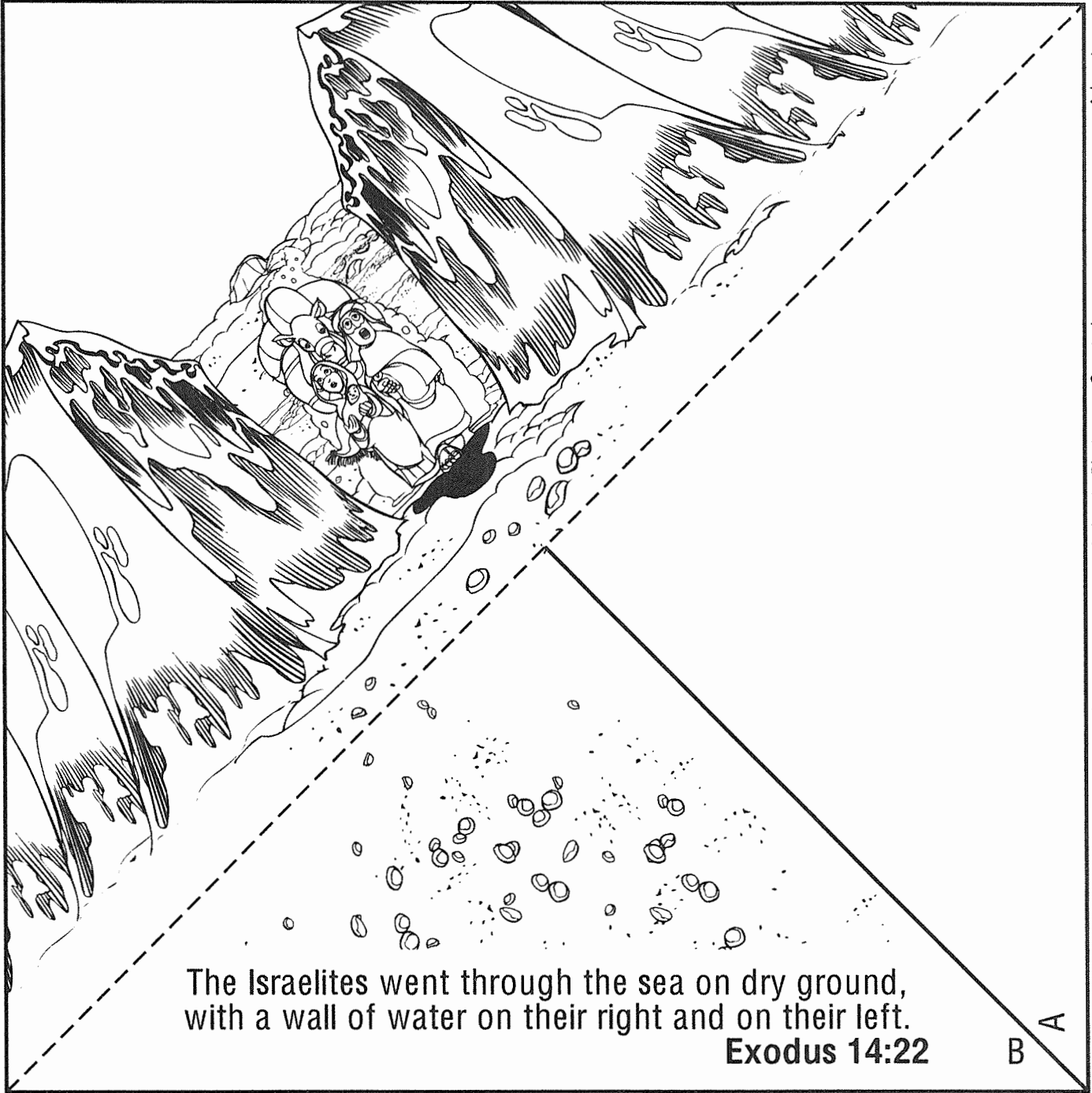

The Israelites went through the sea on dry ground,  
with a wall of water on their right and on their left.

Exodus 14:22

A  
B

Core/Craft  
1 copy for each child

- 1) cut lines <sup>on</sup> outside to start the craft
- 2) " line A/B only to the center where it meets the dotted line
- 3) fold left to right on dotted line ▷
- 4) fold triangle from bottom to top ▷▷
- 5) open and put flap A under flap B (glee in this position)
- 6) can put sandpaper on B to represent dry ground.

R E P R O D U C I B L E

PAGE

B



# Crossing the Red Sea

(Exodus 13:7-22 & 14:1-29 NIV)

God led the people of Israel to the Red Sea where he preformed a miracle for them. The Egyptians were coming from behind and the Red Sea is before them. Read Exodus 14:21 and fill in the blanks below to see what happened.

"Then Moses \_\_\_\_\_  
out his hand over the sea, and all that  
night the LORD drove the sea back  
with a strong east \_\_\_\_\_ and  
turned it into \_\_\_\_\_. The waters  
were \_\_\_\_\_,  
and the Israelites went through the  
\_\_\_\_\_ on \_\_\_\_\_,  
with a \_\_\_\_\_ of water on their  
right and on their left."

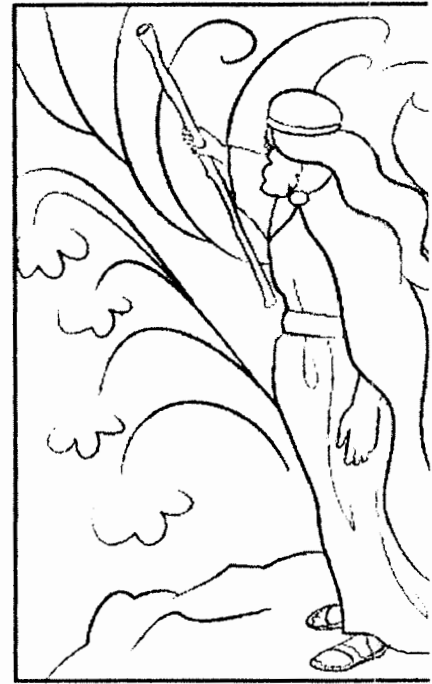

Lead the Israelites to safety through the maze below

enter

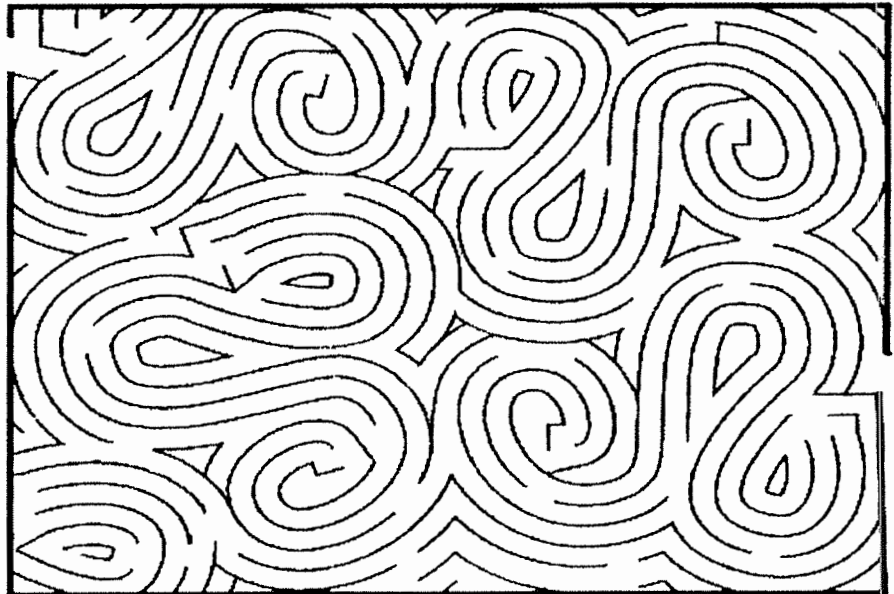

**Crossing the  
Red Sea  
Exodus 12, 14**

# Red Sea Fill-In

With Moses as their leader, the Israelites left Egypt. But Pharaoh sent an army to bring them back! You can read about it in Exodus 12-14.

The words listed below are from Exodus 12-14.  
Fit them into their proper places in the puzzles.  
All shared letters have been filled in to give you a head start.

**3 letter words**

- DRY
- MEN
- SEA

**4 letter words**

- ARMY
- DEAD
- EAST
- FIRE
- HAND
- LEFT
- LORD
- WALL

**5 letter words**

- AARON
- MOSES
- NIGHT
- RIGHT
- SAVED
- TODAY
- TRUST
- WOMEN

**6 letter words**

- AFRAID
- PEOPLE
- TROOPS
- WATERS

**7 letter words**

- DIVIDED
- PHARAOH
- RAMESES
- SUCCOTH

**8 letter words**

- HORSEMEN
- CHARIOTS
- CHILDREN

**9 letter word**

- EGYPTIANS

**10 letter word**

- ISRAELITES

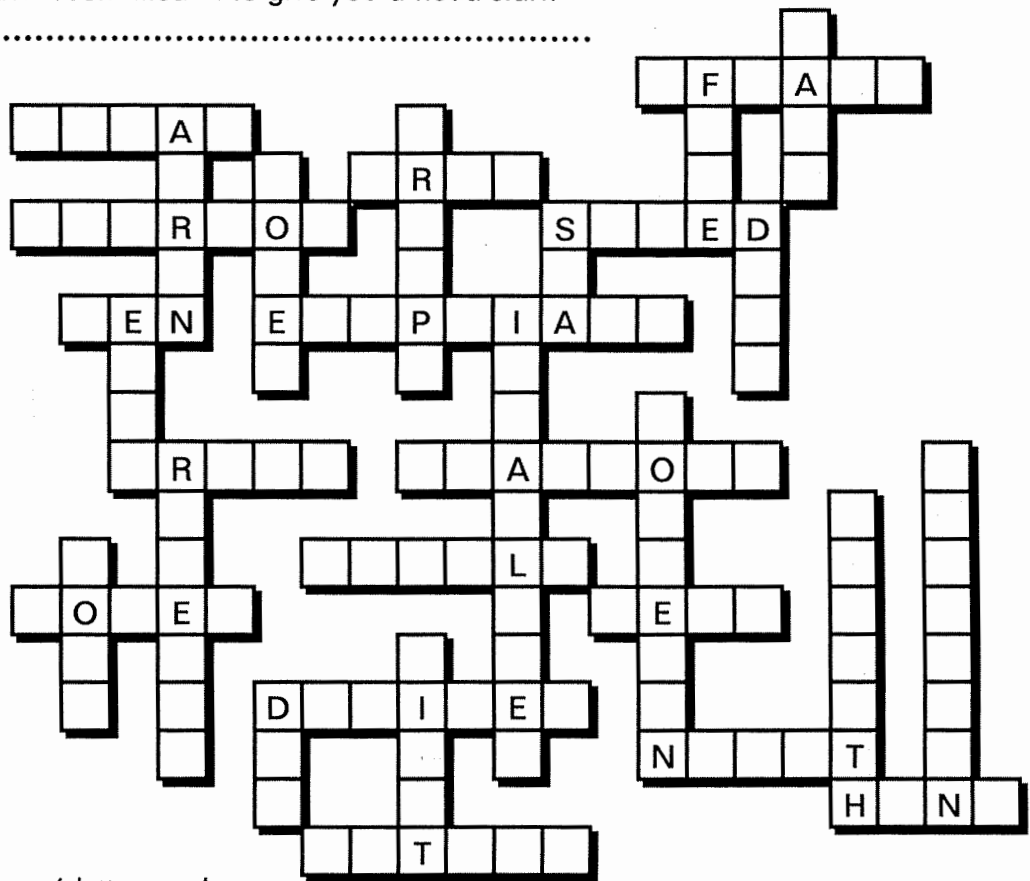



**Year 1**

**Week 37**

## **God Provides Food and Water**

**Scriptures: Exodus 15 & 16**

**Key Verse: Exodus 16:4 Then the Lord said to Moses, “Behold, I will rain bread from heaven for you.”**

### **Key Points:**

1. Moses and all Israel rejoiced and blessed God for their escape from Egypt.
2. After three days in the desert, they came to some water which was not good. God made it safe to drink.
3. Then the Israelites grumbled about food. God gave them manna in the morning and quails at night to provide for their meals.
4. On the sixth day of the week, they gathered enough food for two days, and rested on the seventh day.
5. God loves us and will provide for us. We should obey Him and be thankful for what God gives us.



# GOD GIVES MANNA TO EAT

*Exodus 16:1-36*



*In the mornings God sent manna from heaven for the Israelites to eat*





### **Exodus 16**

**4** Then the Lord said to Moses, "Behold, I will rain bread from heaven for you. And the people shall go out and gather a certain quota every day, that I may test them, whether they will walk in My law or not.

To complete the picture, draw what is missing. Then color the picture.

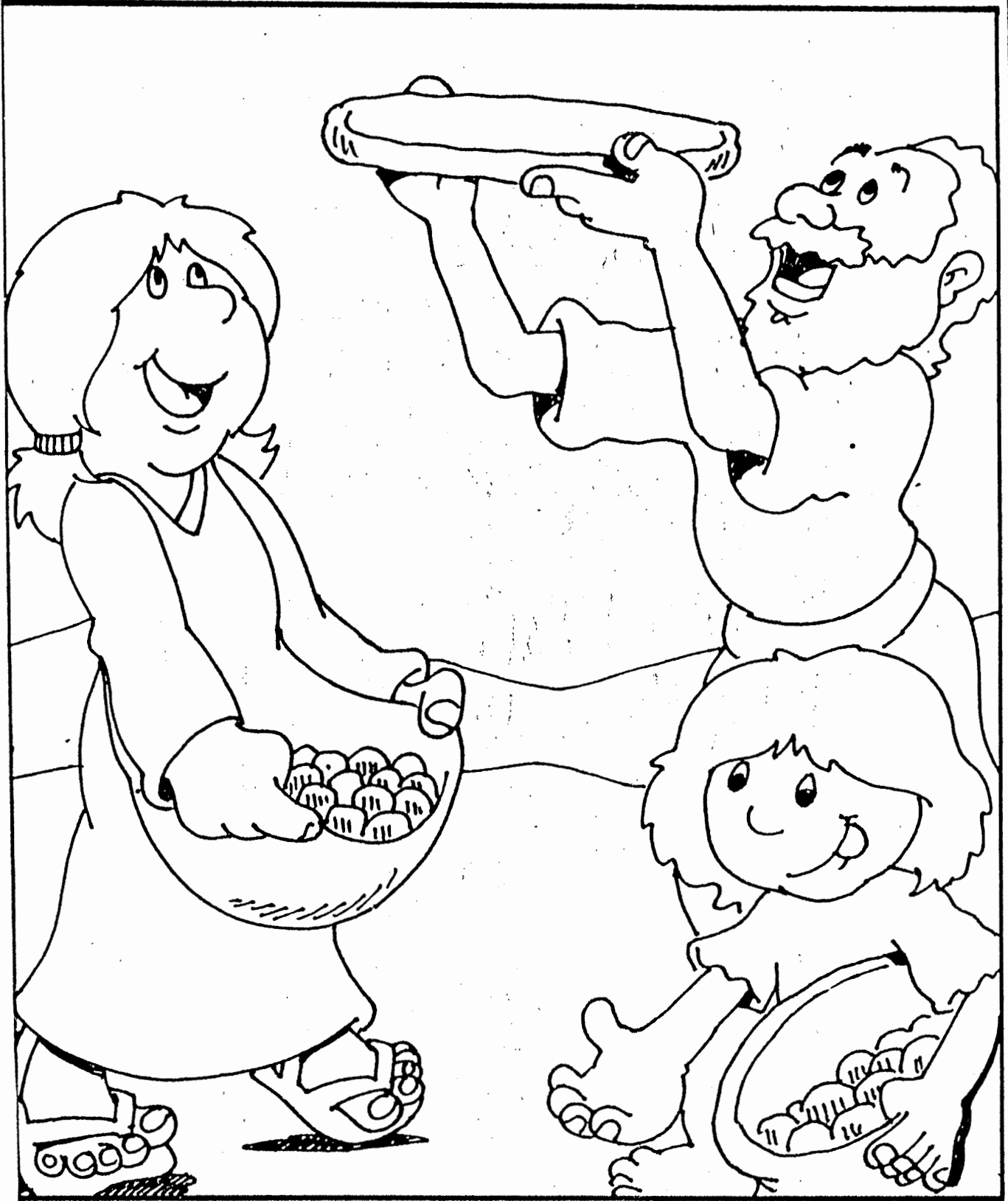

God sent bread from heaven for Moses and his people traveling through the desert. Exodus 16:2-4

# GOD GIVES MANNA TO EAT

*Exodus 16:1-36*

## PRESCHOOL GAME

**Supplies:** Popped popcorn, a clean bedsheet or a piece of plastic sheeting, and enough small paper bags for each child to have one

**Kids will become dramatic characters who find themselves transported to an ancient desert for this tempting, tasty treat.**

**S**ay: Today we are going to find out what it was like for the Israelites to wander around in the sandy desert. Have the children follow your lead as you take them through the desert. Say: **Drag your feet through the hot sand. Climb up that next tall dune. Oops! You went the wrong way! Turn around and go back. Imagine that you had been wandering for forty-five days and your tummy was growling. Start to grumble about how hungry you are as you keep walking and walking. Now stop grumbling because it's getting dark and you're too tired to even talk! Lay down with your eyes closed. Keep your eyes closed until I tell you it's morning.** Leave an area open so you can spread out the sheet or plastic with a layer of popcorn spread over it while the children have their eyes closed.

Say: **The Lord heard the grumbling of his people, and he sent a miracle in the morning. When the grumbly people woke up, there was "manna" scattered all over the ground. They gathered just enough to eat that day.** Give each of the children a bag. Have them each fill up a bag and then sit down to eat their "manna" snack.

# GOD GIVES MANNA TO EAT

*Exodus 16:1-36*

PRESCHOOL BIBLE STORY RHYME



**We're in the desert,**  
*(Use both thumbs to point to self)*

**What do we eat?**  
*(Hands out with palms up and shrugging shoulders)*

**Down from heaven,**  
*(Wiggle all fingers above head and wiggle them to the ground)*

**Comes a special treat.**  
*(Rub tummy with right hand)*

# God Gives Manna to Eat



*Exodus 16:1-36*

Colored by: \_\_\_\_\_

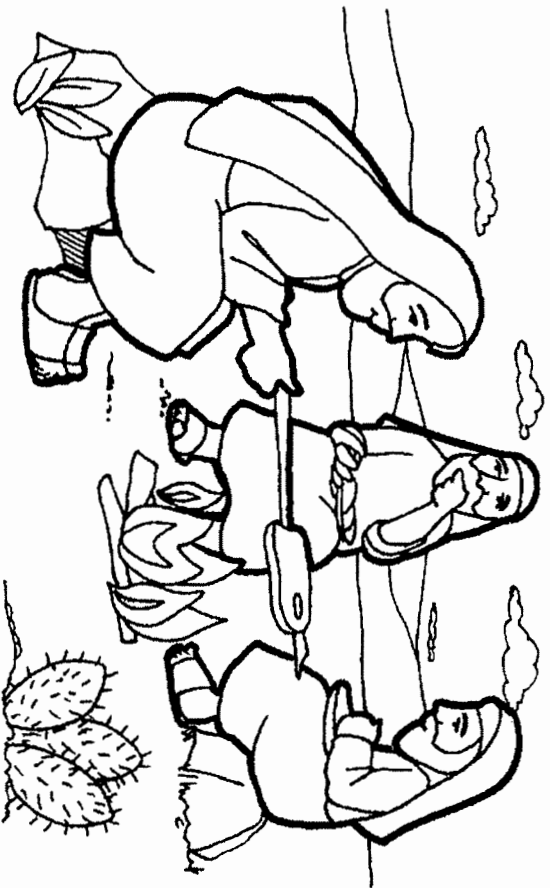

God also gave the  
Israelites meat to eat.



The Israelite's looked for  
food in the desert. Some  
people complained because  
they could find any.





God sent manna from  
heaven. Manna is bread.

## Memory Verse

“...the bread of God...gives life  
to the world...”

John 6:33

## Bible Story Rhyme

**We're in the desert,**

*(Use both thumbs to point to self)*

**What do we eat?**

*(Hands out with palms up and shrugging  
shoulders)*

**Down from heaven,**

*(Wiggle all fingers above head and wiggle  
them to the ground)*

**Comes a special treat.**

*(Rub tummy with right hand)*

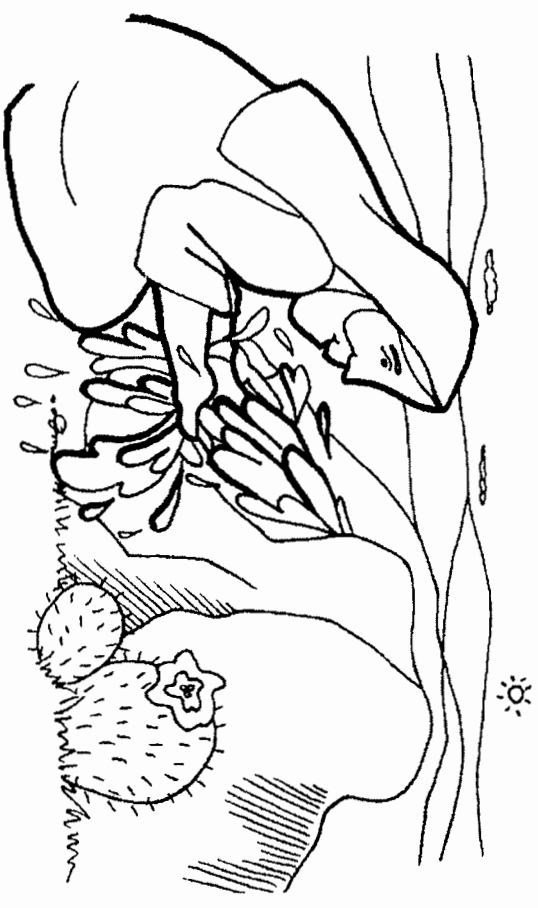

**God gave them water from  
a rock.**

# Children of Israel Complain

## Story Board

Make a story board. Use construction paper or cardstock. Copy the picture, let the children color and cut it out. Glue on to cardstock, copy and cut out scriptures, let children decorate as they desire.



## Numbers

**32** And the people stood up all that day, and all that night, and all the next day, and they gathered the quails: he that gathered least gathered ten homers: and they spread them all abroad for themselves round about the camp.

**33** And while the flesh was yet between their teeth, ere it was chewed, the wrath of the Lord was kindled against the people, and the Lord smote the people with a very great plague.

# Dinner on the Ground

Help the Israelites find the bread and quail!

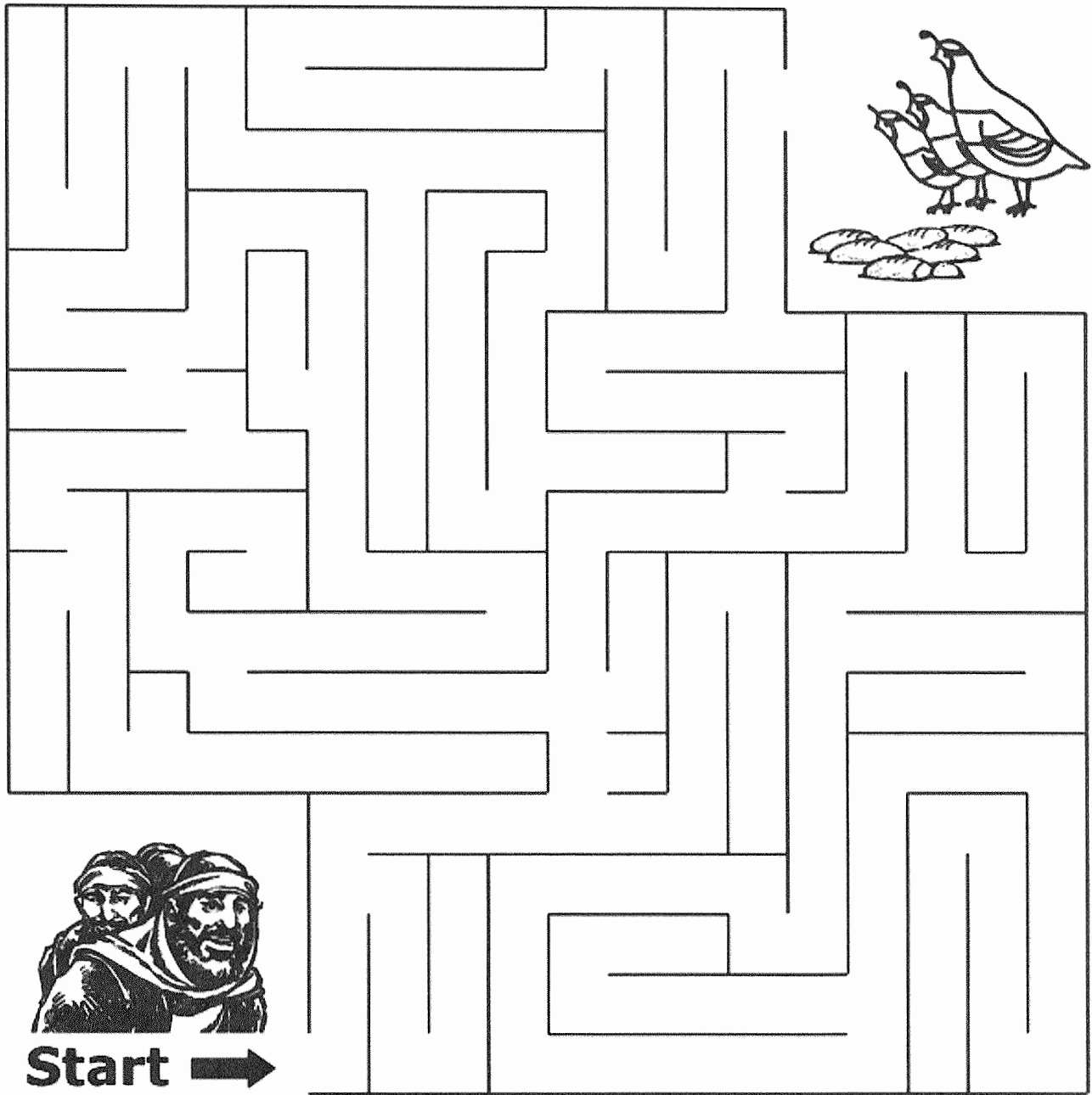

**Year 1**

**Week 38**

## **Battle with Amalek**

**Scriptures: Exodus 17**

**Key Verse: Exodus 17:6 “Behold I will stand before you...and you shall strike the rock, and water will come out of it, that the people may drink.”**

**Key Points:**

1. The Hebrews became angry with Moses when they had no water. God provided water from the rock.
2. Joshua led the Israelites when they fought the Amalekites.
3. Moses helped the Israelites win the battle when he held his arms high with the rod of God. But when his arms became tired, Moses needed help from Aaron and Hur to support them.
4. With God’s help, we can overcome anything. We can also help each other in many ways.



## Moses Strikes The Rock

Exodus 17:1-7

From BibleStoryCard Learning System(tm) Coloring Book © 1996 Wesleyan Publishing House  
Used by permission. Additional BibleStoryCard resources available by calling 1-800-493-7539 or visiting online  
[http://www.parable.com/wph/group\\_1052.htm](http://www.parable.com/wph/group_1052.htm)

# MOSES HOLDS UP HIS HANDS

*Exodus 17:8-16*



*Aaron and Hur hold up Moses' hands*

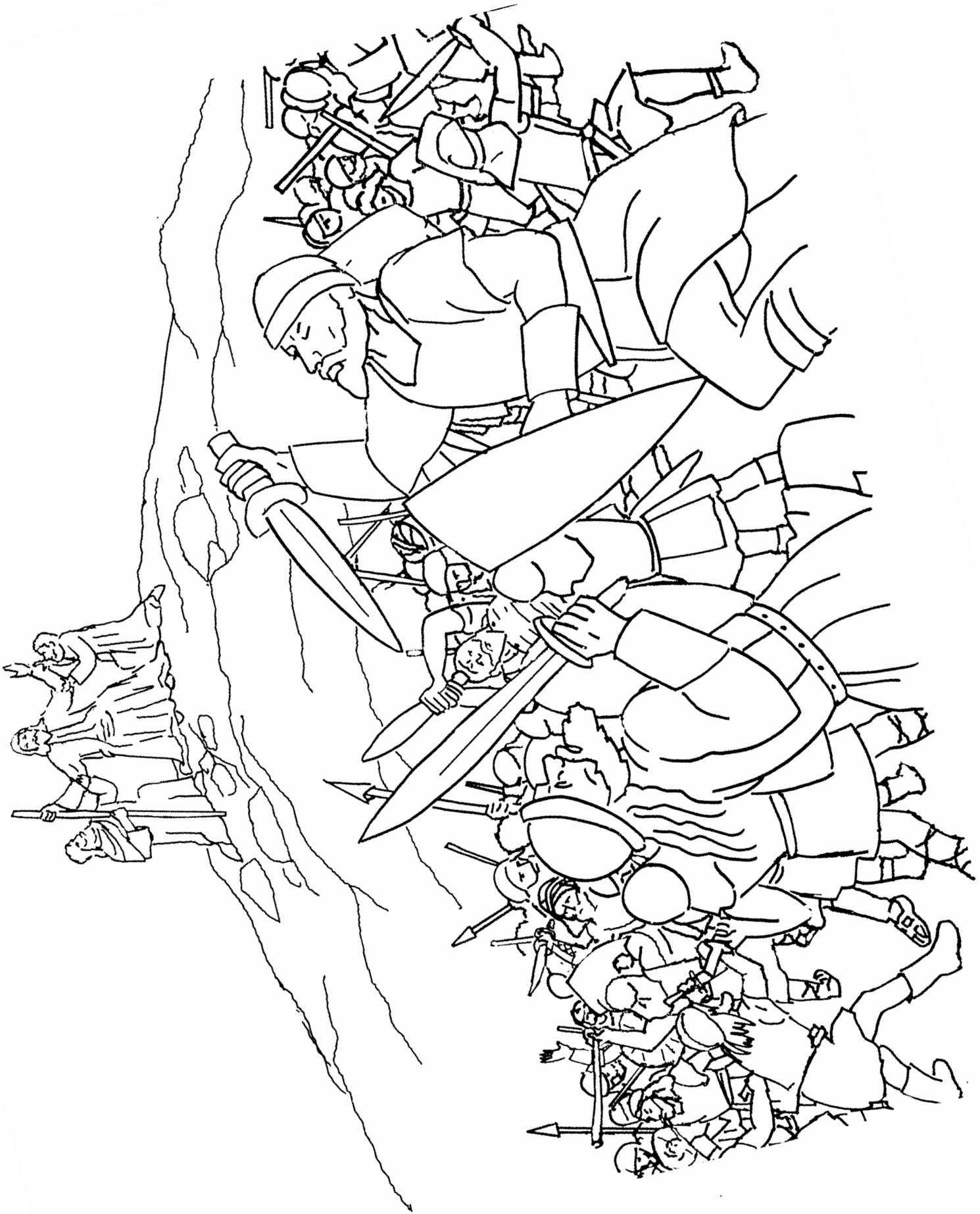







# Water from a Rock

"Strike the rock, and water will come out of it for the people to drink." So Moses did this in the sight of the elders of Israel. Exodus 17:6

Each number represents a letter of the alphabet. Substitute the correct letter for the numbers to reveal the coded words.

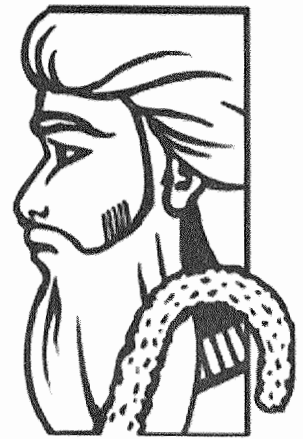

C	V	O	M	Z	R	N	Q	Y	P	B	L	S	T	F	H	G	J	U	X	K	E	W	A	D	I
1	2	3	4	5	6	7	8	9	10	11	12	13	14	15	16	17	18	19	20	21	22	23	24	25	26

1. 25-22-13-22-6-14 \_\_\_\_\_

2. 23-24-14-22-6 \_\_\_\_\_

3. 14-16-26-6-13-14 \_\_\_\_\_

4. 25-6-26-7-21 \_\_\_\_\_

5. 13-14-24-15-15 \_\_\_\_\_

6. 6-3-1-21 \_\_\_\_\_

7. 4-3-13-22-13 \_\_\_\_\_

8. 1-3-4-10-12-24-26-7 \_\_\_\_\_

THIRST	COMPLAIN	MOSES	DESERT
DRINK	WATER	STAFF	ROCK

# Water from a Rock

"Strike the rock, and water will come out of it for the people to drink."  
So Moses did this in the sight of the elders of Israel. Exodus 17:6

Based on Exodus 17:1-7

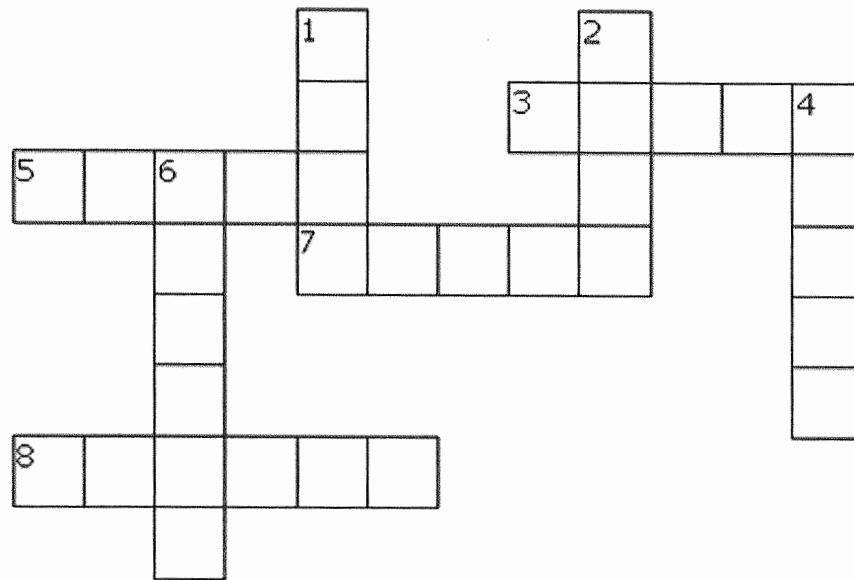

## ACROSS

3. The Hebrew prophet who led the Israelites out of Egypt
5. A fluid necessary for the life of most animals and plants
7. To take water or other liquid into the mouth and swallow it
8. A dry area of land with little or no vegetation

## DOWN

1. Another name that refers God
2. A stone
4. A strong rod or stick sometimes used as an aid in walking
6. A strong desire for something to drink

STAFF  
MOSES

DRINK  
ROCK

DESERT  
LORD

WATER  
THIRST

# Water from a Rock

"Strike the rock, and water will come out of it for the people to drink."  
So Moses did this in the sight of the elders of Israel. Exodus 17:6

Based on Exodus 17:1-7



V J F J F K C H I L D R E N N  
L E A M G M V S J D V D T C F  
V N J E R R U M T H E G L M R  
R P G K U D H U Y A F S H M O  
L O F U M R G A A G F Z E U C  
I U D Q B T W A T E R F Y R K  
V R Q T L W Y F T M O S E S T  
E R C K E C A S Q U E M K X S  
S M F O N N R L V J U C S L S  
T O V H M I I H K U P R C Y S  
O D C Z H P K L F J E E E K N  
C R R T A W L O E D T N Q T Y  
K V Z I X A X A L Z H S R T J  
U Q J D N R T E I V N W P J B  
Y L U Z R K C R G N K N T C S

COMPLAIN	ROCK	DRINK	POUR	DESERT
ELDERS	GRUMBLE	LIVESTOCK	CHILDREN	THIRST
WALK	WATER	STAFF	NILE	MOSES

# THE BIBLE TIMES HERALD

A SPECIAL REPORT ON EXODUS 17:8-16

## MOSES HOLDS UP HIS HANDS



A group of people called the Amalekites came and attacked the Israelites.

Moses told Joshua to choose some of the Israelites to fight against the

Amalekites.

The next day, Moses stood on top of the hill with a staff in his hand. Two other people went with Moses to the top of the hill. Their names were Aaron and Hur.

As long as Moses had his hands up, the Israelites were winning the battle. But when Moses lowered his hands, the Amalekites were winning.

When Moses got tired of holding up his hands, Aaron and Hur helped. They kept Moses' hands up so that the Israelites would win. By the time the sun began to set in the evening, the Israelites had won!

Then the Lord said to Moses, "Write down what happened on a scroll."

After that, Moses built an altar to the Lord.

To find out more, check out Exodus 17:8-16 in your Bible.

## QUESTIONS

1. Who fought against the Israelites?
2. What did Moses do that helped the Israelites win?
3. How did Aaron and Hur help Moses?
4. Why do you think Moses lifted his hands toward heaven?

## MEMORY VERSE

"I will praise you as long as I live, and in your name I will lift up my hands." Psalm 63:4

## FILL IN THE BLANKS

hill	Moses	Israelites
lowered	won	hands

The Amalekites and the \_\_\_\_\_ were fighting. So \_\_\_\_\_ went up on a \_\_\_\_\_. When Moses lifted up his \_\_\_\_\_, the Israelites were winning. But when the Moses \_\_\_\_\_ his hands, the Israelites were losing. In the end, the Israelites \_\_\_\_\_ the battle!

## Victory over the Amalekites

### Find the Answers

Read the questions and write the answers. You can find the answers in Exodus 17 in your copy of the Word.

1. When the Israelites came to Rephidim what did they need? (verse 1)
2. What did the Israelites do against Moses? (verse 3)
3. What did the Lord tell Moses to do? (verses 5 and 6)
4. With what was Moses to hit the rock? (verses 5 and 6)
5. Who did the Israelites tempt? (verse 7)
6. Who came and fought with Israel at Rephidim? (verse 8)
7. Who was to choose men to go fight with the Amalekites? (verse 9)
8. What happened when Moses held up his hand with the rod in it? (verse 11)
9. Who helped Moses hold up his hands? (verse 12)
10. Who won the battle? (verse 13)

Answers	
1.	water
2.	complained
3.	strike the rock at Horeb with his rod
4.	his rod
5.	the Lord
6.	the Amalekites
7.	Joshua
8.	Israel prevailed
9.	Aaron and Hur
10.	Joshua

## **Year 1**

### **Week 39**

#### **Moses Receives the Law**

**Scriptures: Exodus 20 and 32**

**Key Verse: Exodus 32:26 Then Moses said, “Whoever is on the Lord’s side—come to me!”**

#### **Key Points:**

1. God wrote the Ten Commandments on two tablets of stone, and gave them to Moses on Mt. Sinai.
2. While Moses was receiving the commandments from God, the people became restless.
3. Aaron asked the people for their gold jewelry and formed it into an idol of a golden calf.
4. God had told the Israelites to serve Him only. Moses begged God to be patient with the people, and God showed mercy to them.
5. God sent Moses back, but Moses was so angry he broke the stone tablets. Then he ground the golden calf into dust, put the dust in the water and had the people drink it.
6. Those who did not repent were killed.





God called Moses to the top of Mt. Sinai and gave him the ten commandments.



Moses went to the top of Mt. Sinai to talk with God. God gave Moses His Ten Commandments written on tables of stone. These were the laws God wanted His people to obey.

*Exodus 19:18-20; 20:1-17*

Jesus Loves \_\_\_\_\_

# The Ten Commandments

Exodus 19:20-20:19



"And you shall love the Lord your God with all your heart, with all your soul, with all your mind, and with all your strength. This is the first commandment. And the second, like it, is this: 'You shall love your neighbor as yourself.' There is no other commandment greater than these." *Mark 12:30-31*

# THE TEN COMMANDMENTS

*Exodus 20:1-17*

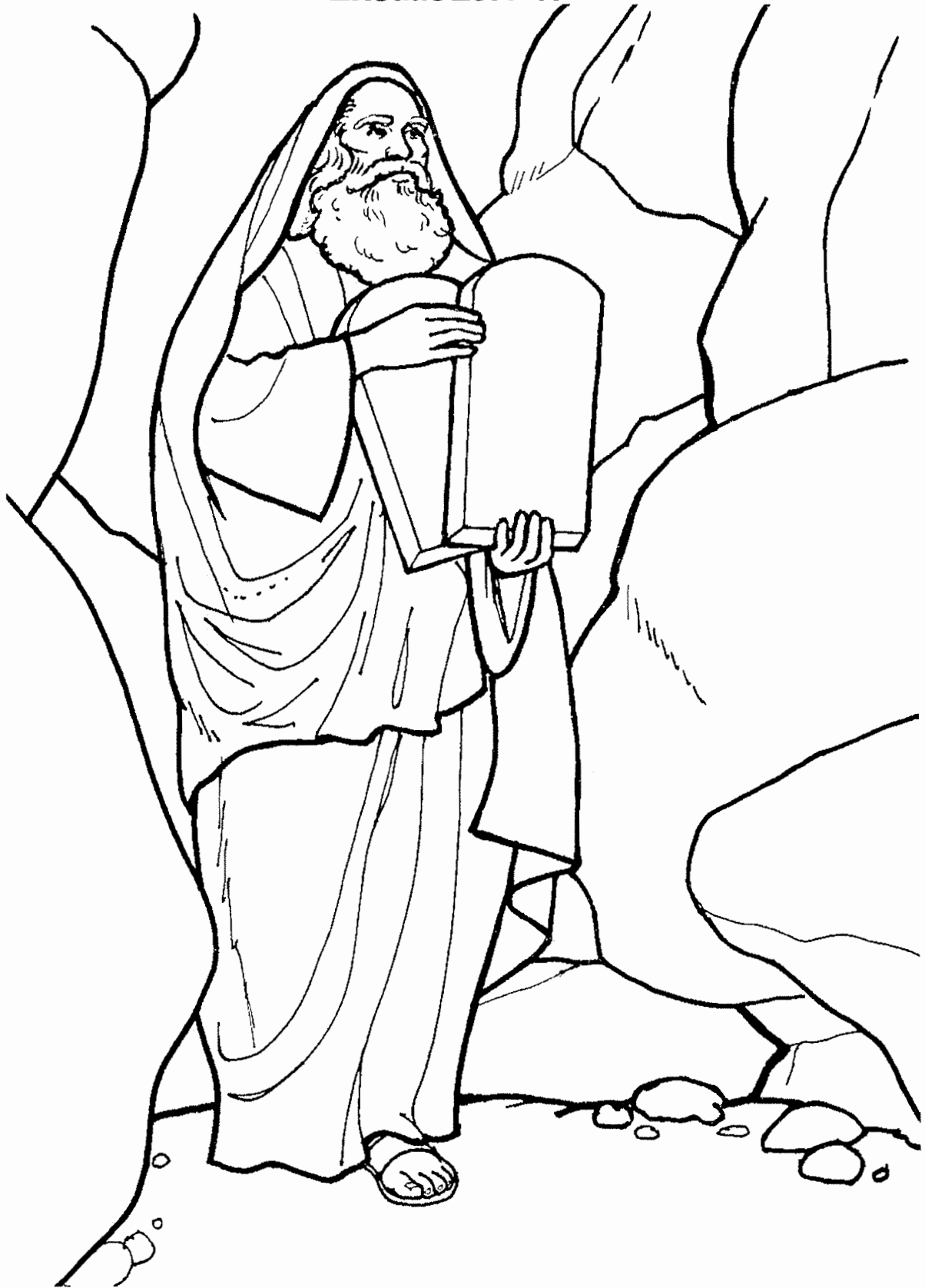

*God gave Moses 10 commandments to share with the Israelites*



While Moses talked with God, the people began to sin. They made a golden calf and bowed down to worship it.



# Worshiping the Golden Calf



***Exodus 32:19***

*And as soon as he came near the camp and saw the calf and the dancing, Moses' anger burned hot, and he threw the tablets out of his hands and broke them at the foot of the mountain.*



How did Moses find his way down the mountain? Draw a line to show the path from the top to the bottom of Mount Sinai.

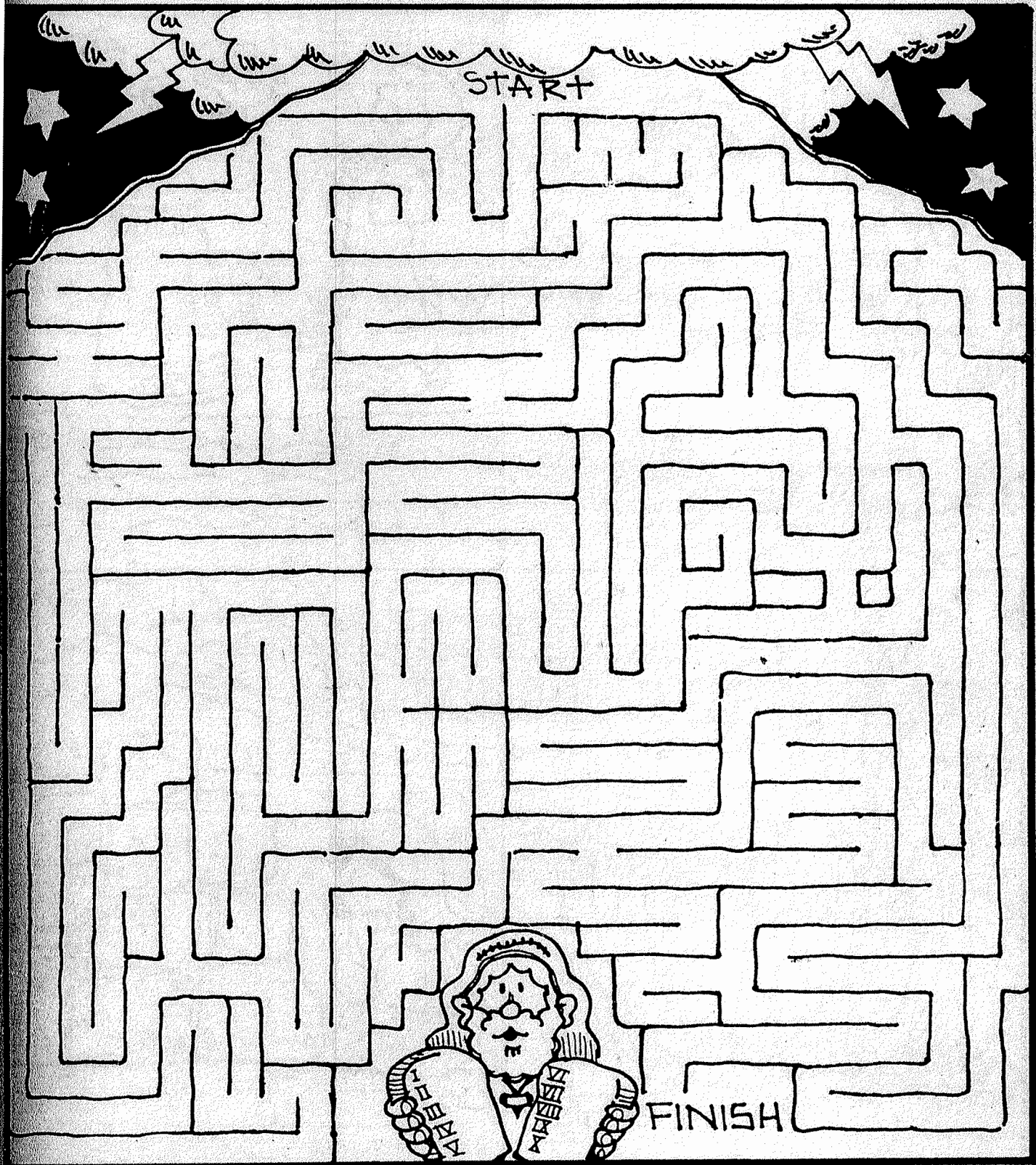

One day God called Moses to the top of a mountain and gave him the Ten Commandments. Exodus 19:20-20:17



# The Ten Commandments

Commandment  
**1**

Commandment  
**3**

Commandment  
**5**

Commandment  
**7**

Commandment  
**9**

Commandment  
**2**

Commandment  
**4**

Commandment  
**6**

Commandment  
**8**

Commandment  
**10**

**Direction:** Print out The Ten Commandments (top and bottom). Cut the top on the dotted lines and glue the top to the bottom. Be careful not to glue the flaps shut. They will help the children to test themselves on the 10 commandments.

**Materials:** Colors, scissors, and glue.

# Bottom Ten Commandments



1  
Worship  
God  
alone



2  
Nothing  
is above  
God



3  
Be care-  
ful how  
you use  
God's  
name



4  
Keep  
God's  
day of  
rest and  
worship



5  
Honor  
your  
Dad and  
Mom



6  
Don't  
hurt  
people



7  
Be faith-  
ful to  
your  
husband  
and wife



8  
Don't  
steal  
anything

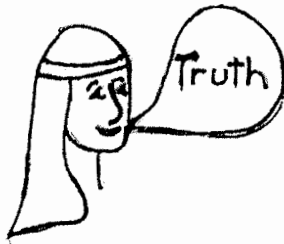

9  
Always  
tell the  
truth



10  
Be hap-  
py with  
what you  
have



## MATCHING

Draw a line from the name to the words that best describe it

- |                    |                      |
|--------------------|----------------------|
| 1. Moses           | punishment           |
| 2. Aaron           | 10 Commandments      |
| 3. golden calf     | an idol              |
| 4. Israel          | melted for an idol   |
| 5. Joshua          | Moses' brother       |
| 6. tables of stone | used to make an idol |
| 7. golden earrings | Moses' helper        |
| 8. plague          | God's true people    |
| 9. graving tool    | burned in the fire   |
| 10. graven image   | Israel's leader      |

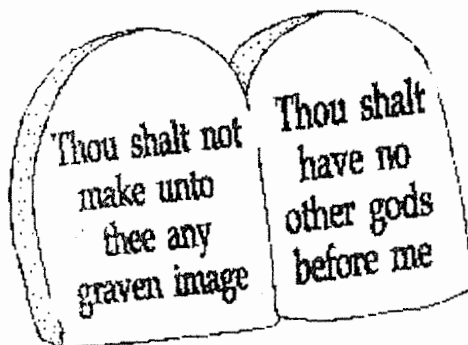

*The Golden Calf*

# THE BIBLE TIMES HERALD

A SPECIAL REPORT ON EXODUS 20:1-17

## THE TEN COMMANDMENTS

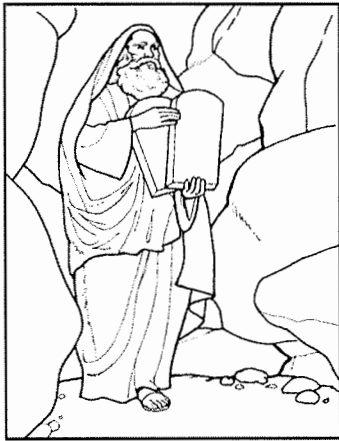

The Israelites were waiting for Moses to come down from the top of Mount Sinai. Moses was on top of the mountain listening to what God wanted him

to share with the people.

God told Moses ten commandments that he wanted the Israelites to follow. The commandments are like rules for God's people. The ten commandments are:

1. Do not worship any other god.
2. Do not worship idols.
3. Do not misuse the Lord's name.
4. Keep the Sabbath day holy.
5. Honor your father and mother.
6. Do not murder.
7. Do not commit adultery.
8. Do not steal.
9. Do not lie.
10. Do not covet.

For additional details about this story, please read Exodus 20:1-17 in your Bible.

## QUESTIONS

1. Name four of the commandments.
2. Explain what three of the commandments mean.
3. What does the memory verse mean?
4. Why do you think the Lord gave Moses these commandments?

## MEMORY VERSE

“For all have sinned and come short of the glory of God.”

Romans 3:23

## FINISH THE PICTURE







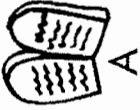

# THE TEN COMMANDMENTS

## Exodus 20:1-17

God's laws were first written in stone for the Israelites and they are still "in stone" or unchanged for us today. God's laws are for all people forever! Connect the dots below to see what God wrote his laws on. Then use the code to fill in the letters missing from the laws.

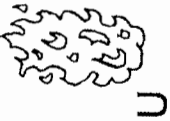
	7.	.18
	6. H N R G D 8.	D N T .17
	M K N D L S 9..20	M R D R B .16
	H N R G D'S N M .10	F T H F L D N T .15
	K P H S D Y H L Y .11	S T L D N T L .14
	H N R Y R P R N T S 1..12	D N T C V T .13

# Word Search

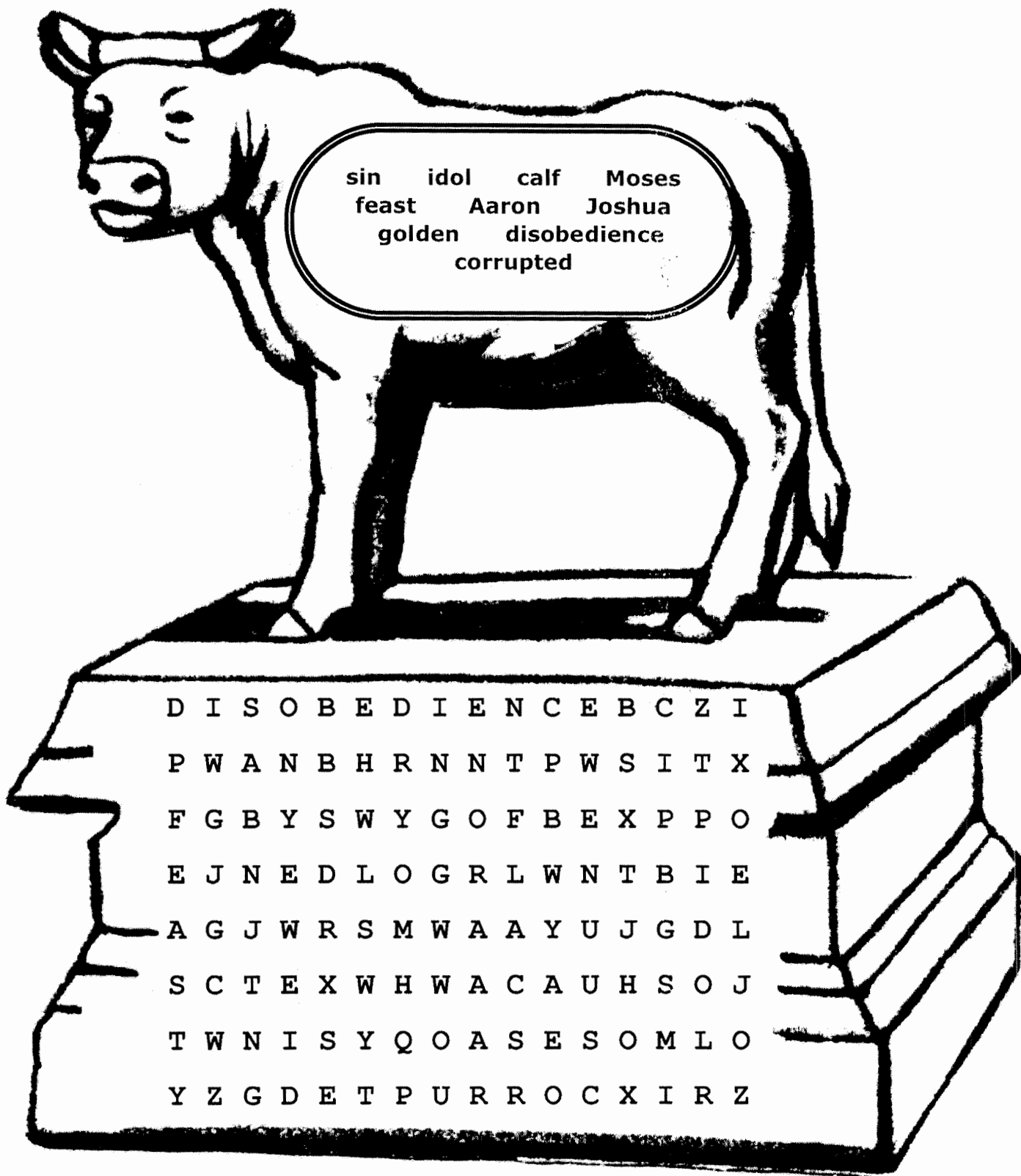

# The Ten Commandments

And God spoke all these words: "I am the LORD your God, who brought you out of Egypt, out of the land of slavery. "You shall have no other gods before me." Exodus 20:1-3

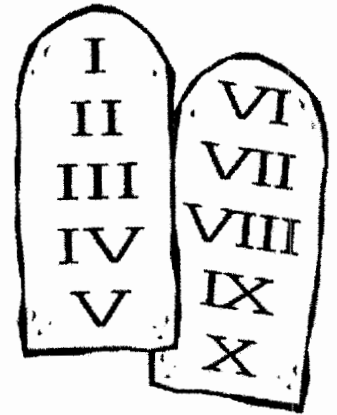

Based on Exodus 20:1-17 (NIV)

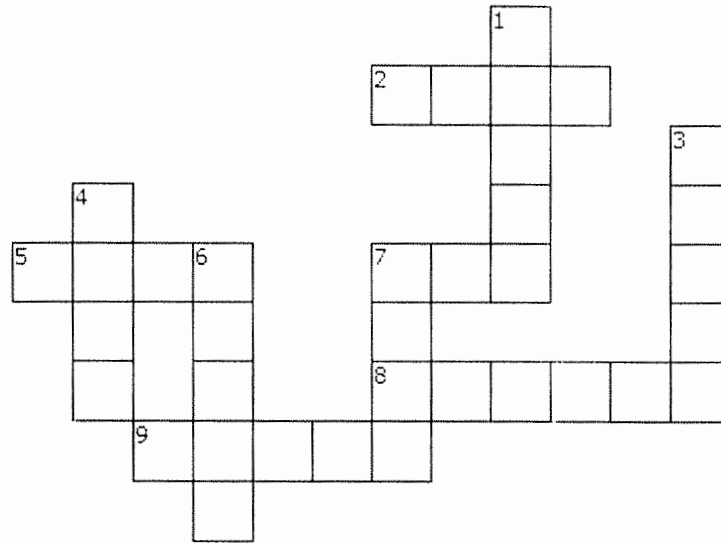

## ACROSS

2. You shall not make for yourself an \_\_\_\_\_. (a false god)
5. You shall have no other \_\_\_\_\_ before me.
7. You shall \_\_\_\_\_ commit adultery.
8. You shall not \_\_\_\_\_. (kill)
9. You shall not give \_\_\_\_\_ testimony against your neighbor. (untrue)

## DOWN

1. You shall not \_\_\_\_\_. (to want something that belongs to another)
3. \_\_\_\_\_ your father and your mother.
4. Remember the Sabbath day by keeping it \_\_\_\_\_.
6. You shall not \_\_\_\_\_. (to take what does not belong to you)
7. You shall not misuse the \_\_\_\_\_ of the LORD your God.

FALSE	IDOL	STEAL	HONOR	MURDER
NAME	COVET	HOLY	NOT	GODS



# The Ten Commandments

## Missing Word Fill In

WORSHIPED    IMAGE    VAIN    HOLY  
MOTHERS    MURDER    ADULTERY  
STEALING    LYING    COVETING

1. God shall be the only God \_\_\_\_\_.
2. No carved \_\_\_\_\_ shall be made to be worshiped.
3. The Lord's name shall not be taken in \_\_\_\_\_.
4. Keep the whole Sabbath \_\_\_\_\_.
5. Honor fathers and \_\_\_\_\_.
6. No \_\_\_\_\_.
7. No \_\_\_\_\_.
8. No \_\_\_\_\_.
9. No \_\_\_\_\_.
10. No \_\_\_\_\_.

"And you \_\_\_\_\_ love the \_\_\_\_\_ your  
\_\_\_\_\_ with all your \_\_\_\_\_, with all  
your \_\_\_\_\_, with all your \_\_\_\_\_, and  
with all your \_\_\_\_\_."

\_\_\_\_\_ : \_\_\_\_\_

# The 10 Commandments

(Exodus 20:1-17 NIV)

God brought the Israelites to Mount Sinai and God spoke to Moses from the mountain. This is what God said:

"Now if you obey me fully  
and keep my covenant. . .  
you will be a . . . \_\_\_\_\_ nation."

(Exodus 19:5,6)

The Israelites agreed to obey. God had Moses come up the mountain where he gave him the 10 Commandments.



1. You shall have no other gods before me
2. You shall not make for yourself an idol
3. You shall not misuse the name of the Lord your God
4. Remember the Sabbath day by keeping it holy
5. Honor your father and your mother

6. You shall not murder
7. You shall not commit adultery
8. You shall not steal
9. You shall not give false testimony against your neighbor.
10. You shall not covet. . . anything that belongs to your neighbor.

Write the number of the Commandment in the blank in front of their meanings below.

- \_\_\_ Use God's name only in ways that honor Him.
- \_\_\_ Be satisfied with what you have.
- \_\_\_ Do not kill anyone.
- \_\_\_ Worship God only. Do not worship things that people make.
- \_\_\_ Do not take what belongs to someone else.

- \_\_\_ Love only your own husband or wife.
- \_\_\_ Do not worship or serve any except me.
- \_\_\_ Keep one day a week for God.
- \_\_\_ Love and obey your parents.
- \_\_\_ Do not lie about other people.

# The Ten Commandments

Exodus 20:3-17

You shall have no other \_\_\_\_\_ before me.

You shall not make for yourself an \_\_\_\_\_ in the form of anything in \_\_\_\_\_ above or on the \_\_\_\_\_

beneath or in the \_\_\_\_\_ below. You shall not

\_\_\_\_\_ down to them or \_\_\_\_\_ them....

You shall not \_\_\_\_\_ the name of the \_\_\_\_\_ your God, for the Lord will not hold anyone

\_\_\_\_\_ who misuses his name.

Remember the \_\_\_\_\_ day by keeping it holy.

\_\_\_\_\_ days you shall \_\_\_\_\_ and do all your

\_\_\_\_\_ , but the \_\_\_\_\_ day is a Sabbath to

the Lord your God....

\_\_\_\_\_ your \_\_\_\_\_ and your

\_\_\_\_\_ , so that you may live long in the land the

Lord your God is giving you.

You shall not \_\_\_\_\_ .

You shall not commit \_\_\_\_\_ .

You shall not \_\_\_\_\_ .

You shall not give \_\_\_\_\_ testimony against your

\_\_\_\_\_ .

You shall not \_\_\_\_\_ your neighbor's \_\_\_\_\_ . You

shall not covet your neighbor's \_\_\_\_\_ , or his manservant

or maidservant, his ox or donkey, or \_\_\_\_\_

that belongs to your neighbor.

R J E Q I P S T E A L H  
 O G S G N B G F N E L A  
 Q K U C R O B H G I E N  
 J B S I D W I A W H Z Y  
 G Y I S L F X C O V E T  
 N E M Y W T A L S K S Z I  
 E U B R T A L S K S Z I  
 V R Y E Q X O E L W P N  
 A V H T A B B A S N U G  
 E M T L L S F K E S R P  
 H J Q U I P H O V G W I  
 N T F D M U R D E R A S  
 M H R A E X L D N K T S  
 C O J A E S U O H H R O  
 L N I A E S U O H H R O  
 Z O G F Y F X E W D S L  
 V R I D O L C R O B A L  
 U W B T A S F A T H E R

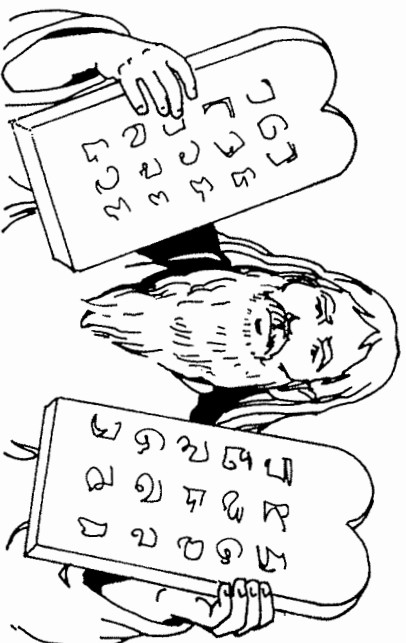

NIV Version

**Year 1**

**Week 40**

## **God's Glory Passes By**

**Scriptures: Exodus 33 & 34**

**Key Verse: Exodus 34:29 When Moses came down from Mt. Sinai ...Moses did not know that the skin of his face shone.**

**Key Points:**

1. Moses asked to see God's glory.
2. God explained it was not possible for Moses to see His face and live. He told Moses to hide in an opening of the rock, and God covered Moses while His glory passed by.
3. Moses cut two more tablets for God to write the commandments. God had such love for the people that He gave the commandments again.
4. When Moses came back down the mountain, his face was radiant, and everyone knew he had been with God.
5. Prayer is the way we talk to God.



PLEASE MAY I BEHOLD YOUR GLORY



**Moses came down from Mount Sinai.**

# THE NEW STONE TABLETS

*Exodus 34:1-35*



*God gives Moses the ten commandments again*



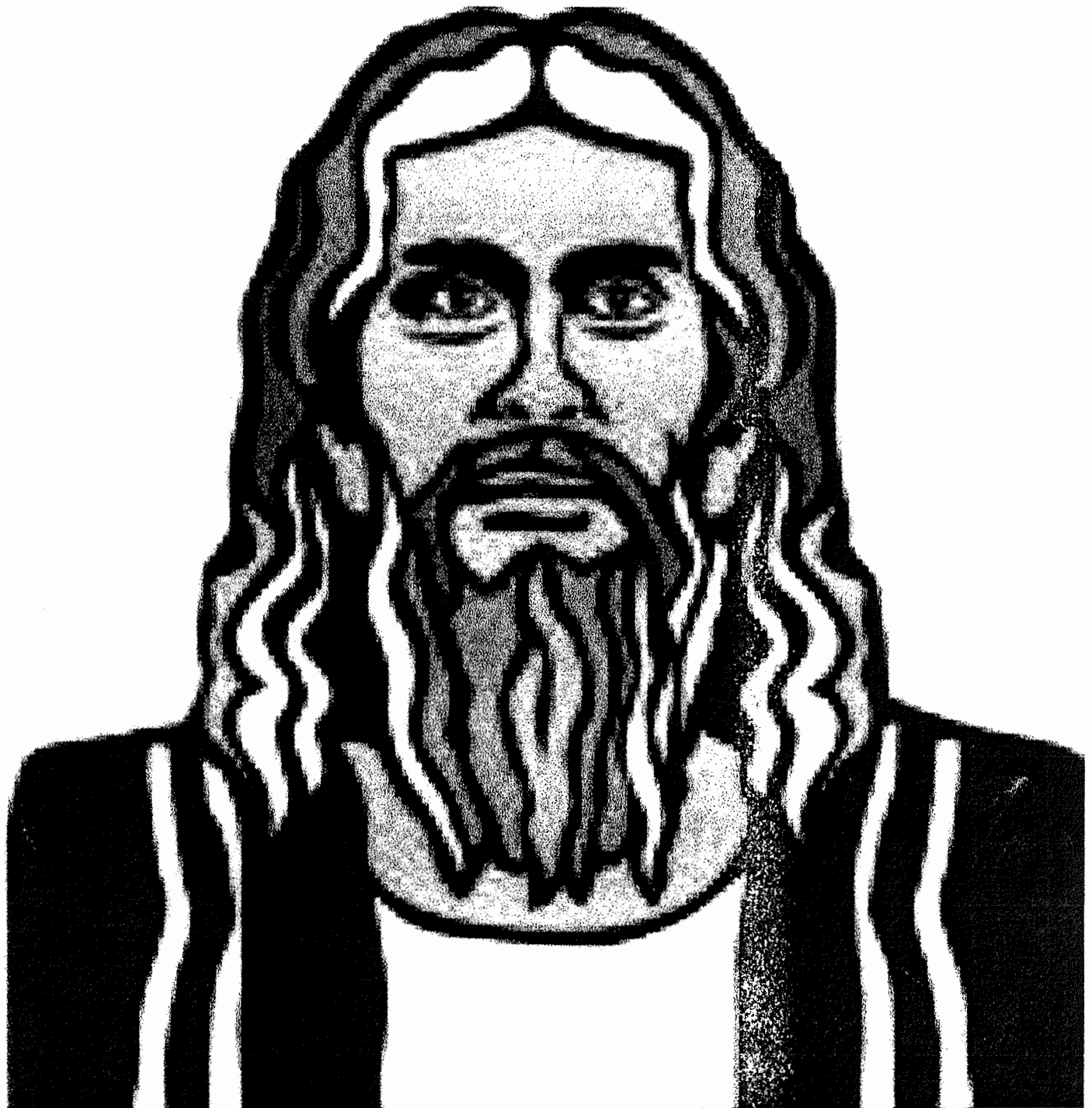

### *Moses Shining Face*

**Exodus 34:19**

Now it was so, when Moses came down from Mount Sinai , that Moses did not know that the skin of his face shone while he talked with God.

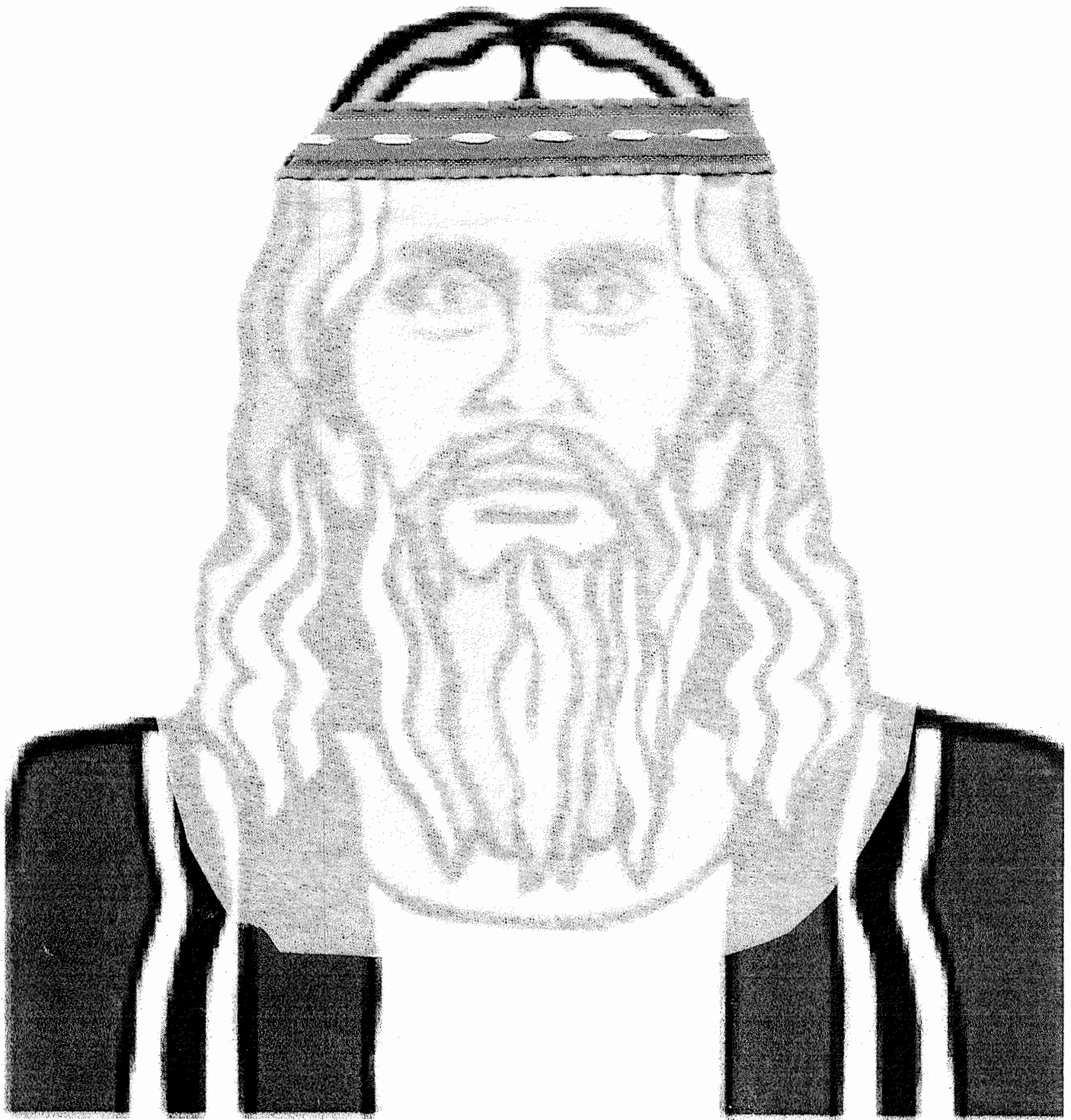

### Craft: Moses Veils his face

Copy the picture of Moses face. Let the children color it. Then glue pieces of tissue paper or tulle to make a “veil” for Moses. Explain to the children how Moses face shone after speaking with God and how the children of Israel were afraid to come near him. He would wear the veil when speaking with the Children of Israel but when going in to talk to God he took it off.

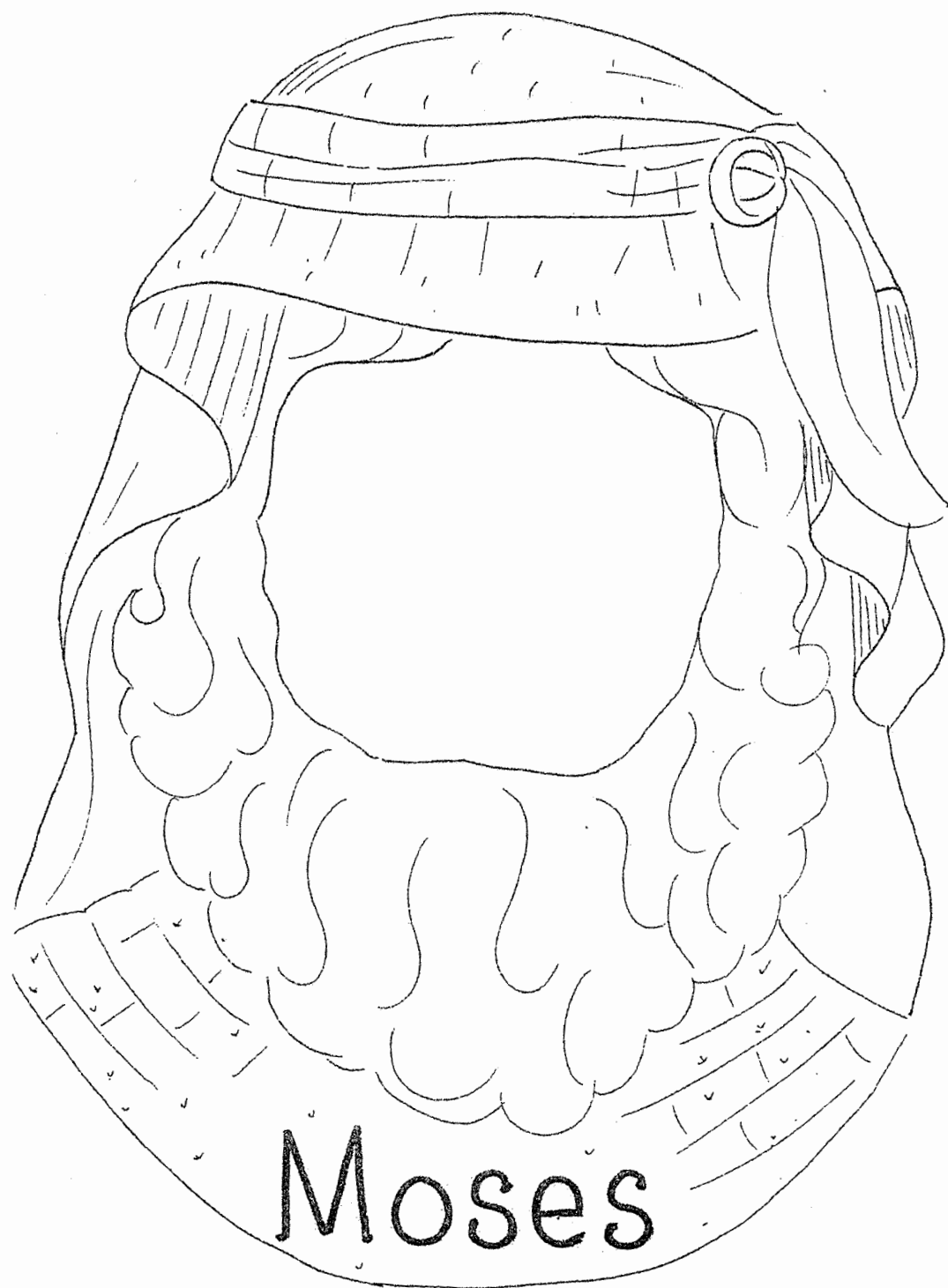

Moses

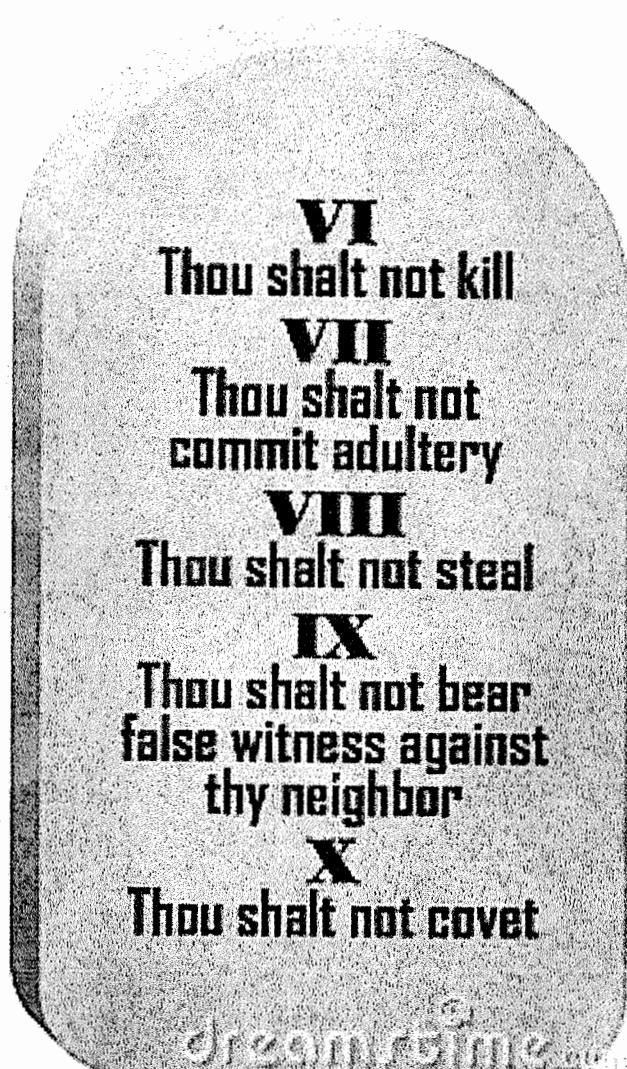
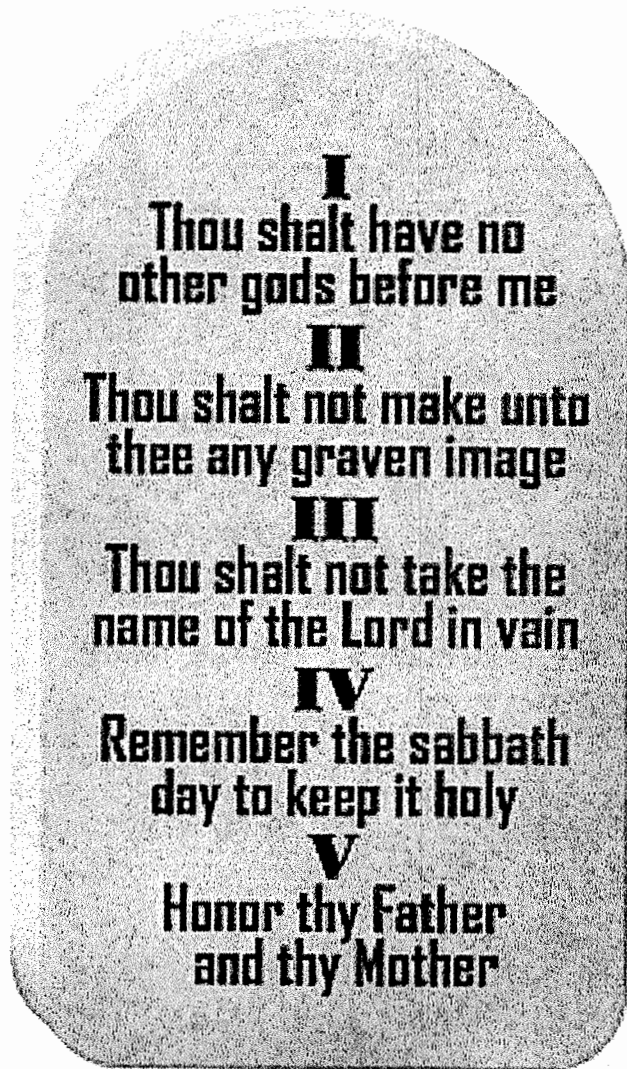

## Moses Sees God's Glory/Receives New Tablets

### Craft Idea

Trace two tablets onto cardstock, foam or other material. Have the children cut out the tablets. Copy 10 commandments and glue onto foam. You can then make a story board, magnet or other items.



[www.coloringpages101.com](http://www.coloringpages101.com)

And Moses said to the Lord:

**“Show me Your Glory”**

On the line below, write out what God’s response was to Moses:

---

---

# The 10 Commandments

How well do you know your commandments? Fill in the banks to complete each commandment.

1. Thou shalt have no other \_\_\_\_\_ before me.
2. Thou shalt not make unto thee any \_\_\_\_\_ image.
3. Thou shalt not take the name of the Lord thy God in \_\_\_\_\_.
4. Remember the \_\_\_\_\_ day to keep it holy.
5. Honor your \_\_\_\_\_ and your \_\_\_\_\_.
6. Thou shalt not \_\_\_\_\_.
7. Thou shalt not commit \_\_\_\_\_.
8. Thou shalt not \_\_\_\_\_.
9. Thou shalt not bear false \_\_\_\_\_ against thy \_\_\_\_\_.
10. Thou shalt not \_\_\_\_\_ thy neighbour's house, thou shalt not covet thy neighbor's wife, nor his manservant, nor his maidservant, nor his ox, nor his ass, nor any thing that is thy neighbor's.

Try these words:

mother	vain	witness	covet	Sabbath	adultery
kill	gods	steal	graven	father	neighbor



## Exodus 20

### The 10 commandments

1. You shall have no other gods before me.
2. You shall not make for yourselves an idol.
3. You shall not misuse the name of the Lord your God.
4. Remember the Sabbath day by keeping it holy.
5. Honor your father and your mother.
6. You shall not murder.
7. You shall not commit adultery.
8. You shall not steal.
9. You shall not give false testimony against your neighbor.
10. You shall not covet.

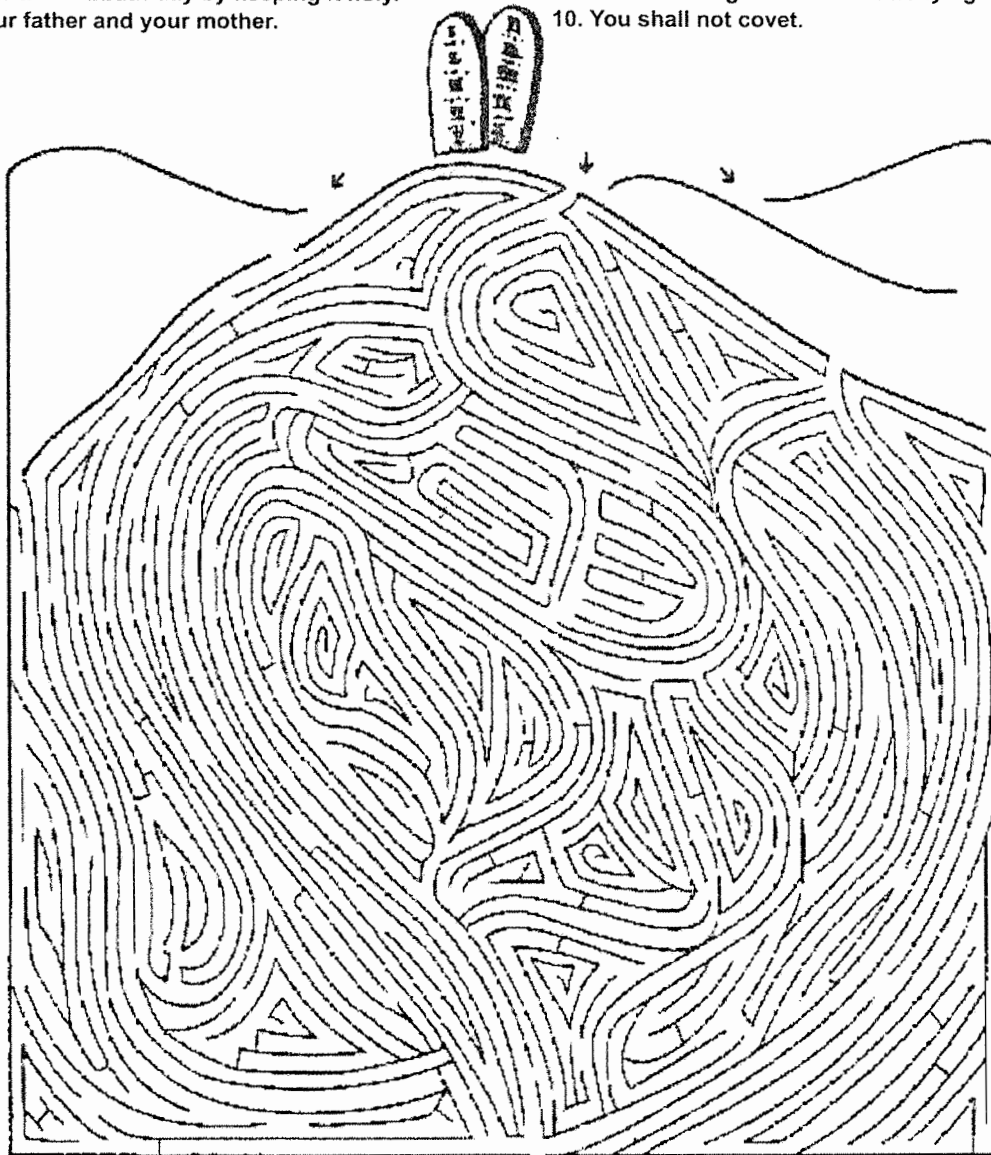

↑ End



## EXODUS 33 The Glory of God Passes By Moses

1. Ex.33:1 God once again tells Moses to move with the people he had brought out of \_\_\_\_\_.
2. Ex. 33:2 Who did God say He would send to go before the people?
3. Ex. 33:3 In this verse, the land is described as flowing with \_\_\_\_\_ and \_\_\_\_\_.
4. Ex. 33:3 God describes the people as “a stiff-necked people”. Which word best describes the meaning of stiff-necked? A) crippled B)tall C) stubborn
5. Ex. 33:4-6 In these verses, the children of Israel take off their ornaments because God is displeased with them. What is another word for ornaments?
6. Ex. 33:7 Moses pitched his tent far from camp. What did he call it? The \_\_\_\_\_ of \_\_\_\_\_
7. Ex. 33:7 Where did the people go if they were seeking the Lord? \_\_\_\_\_ of \_\_\_\_\_
8. Ex. 33:8 Whenever Moses went to the tabernacle, where did the people go?
9. Ex. 33:9 When Moses went in the tabernacle, what descended? \_\_\_\_\_ of \_\_\_\_\_.
10. Ex. 33:10 Could the people see the pillar of cloud?
11. Ex. 33:10 Who spoke to Moses in the tabernacle?
12. Ex. 33:12-15 What does Moses want to go with him and the people? \_\_\_\_\_
13. Ex. 33:18 What did Moses ask to see? \_\_\_\_\_
14. Ex. 33:19 God told Moses, He would make all of His \_\_\_\_\_ pass before him.
15. Ex. 33:20 But He said, “You cannot see \_\_\_\_\_; for \_\_\_\_\_ man shall see Me and \_\_\_\_\_.”
16. Ex. 33:22 Where was Moses when God’s glory passed by? \_\_\_\_\_ of the \_\_\_\_\_

17. Ex. 33:22 What covered Moses as God's glory passed by? God's \_\_\_\_\_
18. Ex. 33:23 God removed His hand so Moses could see what? God's \_\_\_\_\_

### EXODUS 34 Moses on Mount Sinai

1. Ex. 34:1 God had Moses cut two tablets of \_\_\_\_\_.
2. Ex. 34:1 Who wrote on the tablets?
3. Ex. 34:1 What had happened to the first tablets?
4. Ex. 34:2 Where was Moses to present himself to God? \_\_\_\_\_
5. Ex. 34:3 Who was Moses to bring with him?
6. Ex. 34:4 What did Moses take with him to Mount Sinai? \_\_\_\_\_ of \_\_\_\_\_
7. Ex. 34:5 What did the Lord descend in on the Mount?
8. Ex. 34:6 And the Lord passed before him and proclaimed, "The Lord, the Lord God, merciful and gracious, \_\_\_\_\_, and abounding in \_\_\_\_\_ and \_\_\_\_\_, keeping mercy for \_\_\_\_\_, forgiving iniquity and transgression, and sin, by no means clearing the guilty, visiting the iniquity of the fathers upon the children and the children's children to the third and the fourth generation."
9. Ex. 34:8 Moses bowed and \_\_\_\_\_.
10. Ex. 34:9 Moses ask God to go among them and forgive their \_\_\_\_\_.
11. Ex. 34:10 What is God making with the people?
12. Ex. 34:11-13 God says He is driving out several groups of people. What does He want Moses and the children of Israel to do? Destroy their \_\_\_\_\_, break their \_\_\_\_\_, cut down their \_\_\_\_\_.
13. Ex. 34:12 What kind of God does He say He is?
14. Ex. 34:15-16 Does God want the children of Israel to have a covenant with the people of the land?

15. Ex. 34:18 What feast are they to keep? Feast of \_\_\_\_\_
16. Ex. 34:19-20 Was God wanting the first born or the last born redeemed?
17. Ex. 34:21 In plowing time and harvest how many days were they to work before they rested?
18. Ex. 34:22 They were to observe the Feast of \_\_\_\_\_ and Feast of \_\_\_\_\_.
19. Ex. 34:23 How many times of year were all the men to go before the Lord?
20. Ex. 34:25-28 In these verses, God continues to give specific instructions for Moses to give the people. How long did it take Moses to receive these commandments?  
\_\_\_\_\_ days and \_\_\_\_\_ nights
21. Ex. 34:28 Did Moses eat or drink during this time?
22. Ex. 34:29 When Moses came off of Mount Sinai with the two tablets, what was different about his face?
23. Ex. 34:30 How did Aaron and the children of Israel react to Moses' shining face?
24. Ex. 34:31-33 Moses called them to him to give them the commandment of the Lord. After he finished speaking, what did he put on his face?
25. Ex. 34:34 Whenever Moses spoke to the Lord, what did he do with the veil?
26. Ex. 34:35 The children of Israel knew Moses had been speaking with God because his face \_\_\_\_\_.

## **Year 1**

### **Week 41**

### **The Tabernacle**

**Scriptures: Exodus 35 - 40**

**Key Verse: Exodus 25:8 “And let them make Me a sanctuary, that I may dwell among them.”**

#### **Key Points:**

1. Moses gathers the people together and tells them that God commands that they should work for 6 days and rest on the Sabbath (7<sup>th</sup> day) for it is holy.
2. The Lord had given Moses instructions to build a tabernacle of meeting while on Mt. Sinai. The children of Israel were to bring offerings from a willing heart. Gold, silver, bronze, linens, etc. (Ex. 35:4-9), to be used to build the tabernacle. All who had whose hearts were stirred brought these offerings to Moses.
3. Gifted artisans were requested to come build the tabernacle and its contents, furniture and courts. God filled them with special abilities to do this work.
4. Details of the tabernacle: Tent, courtyard, altars, holy place, most holy place and their respective furnishings and uses. Touch on these, they will be taught more in depth in later classes. God gave instructions on how to worship, offerings and feasts.
5. The tabernacle was anointed as God specified and HIS glory filled the tabernacle-this was the special worship place of the children of Israel. The tabernacle moved when they moved. They were to follow the cloud and pillar of fire as they set out on their journeys.

# TABERNACLE

5

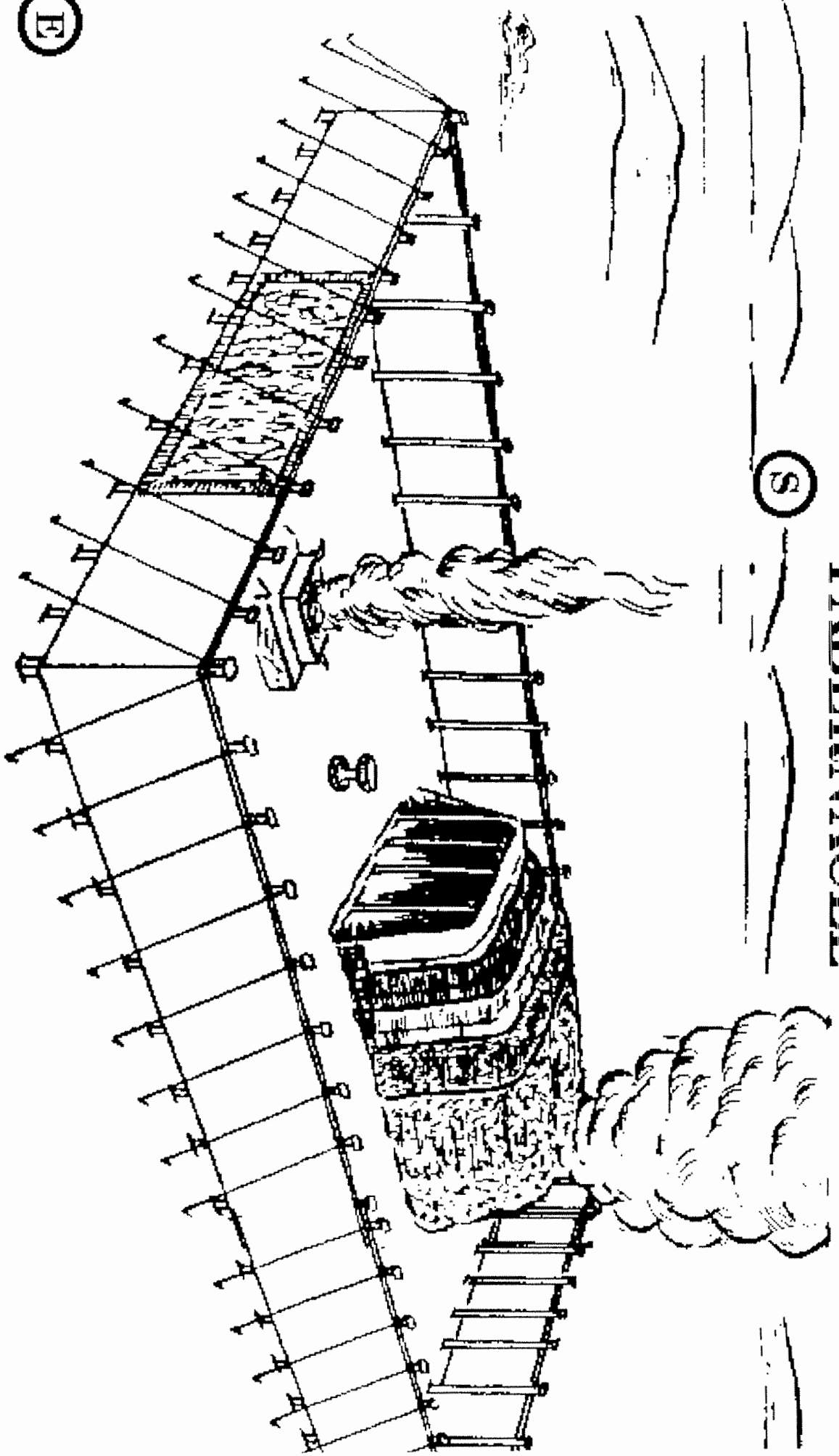

13

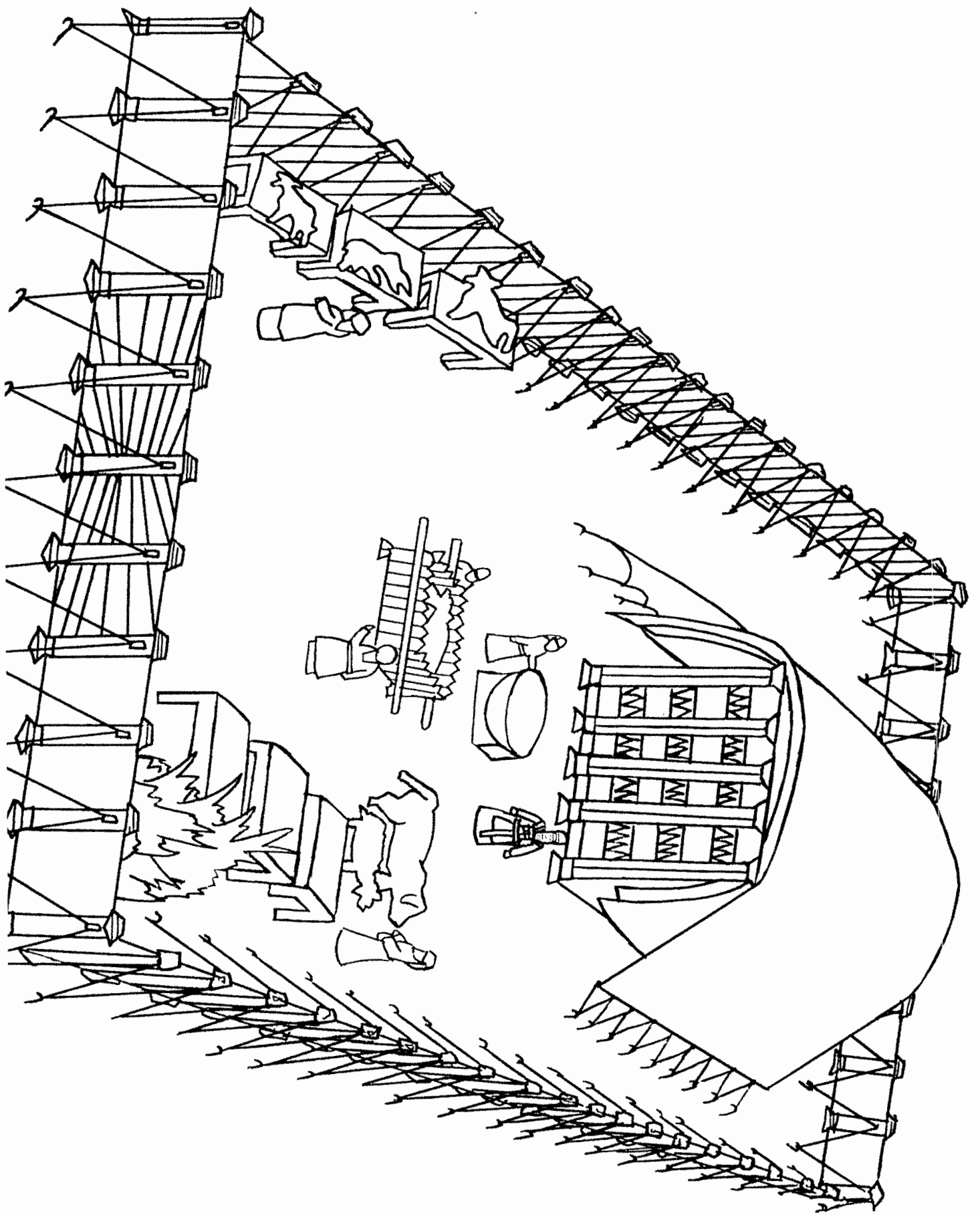

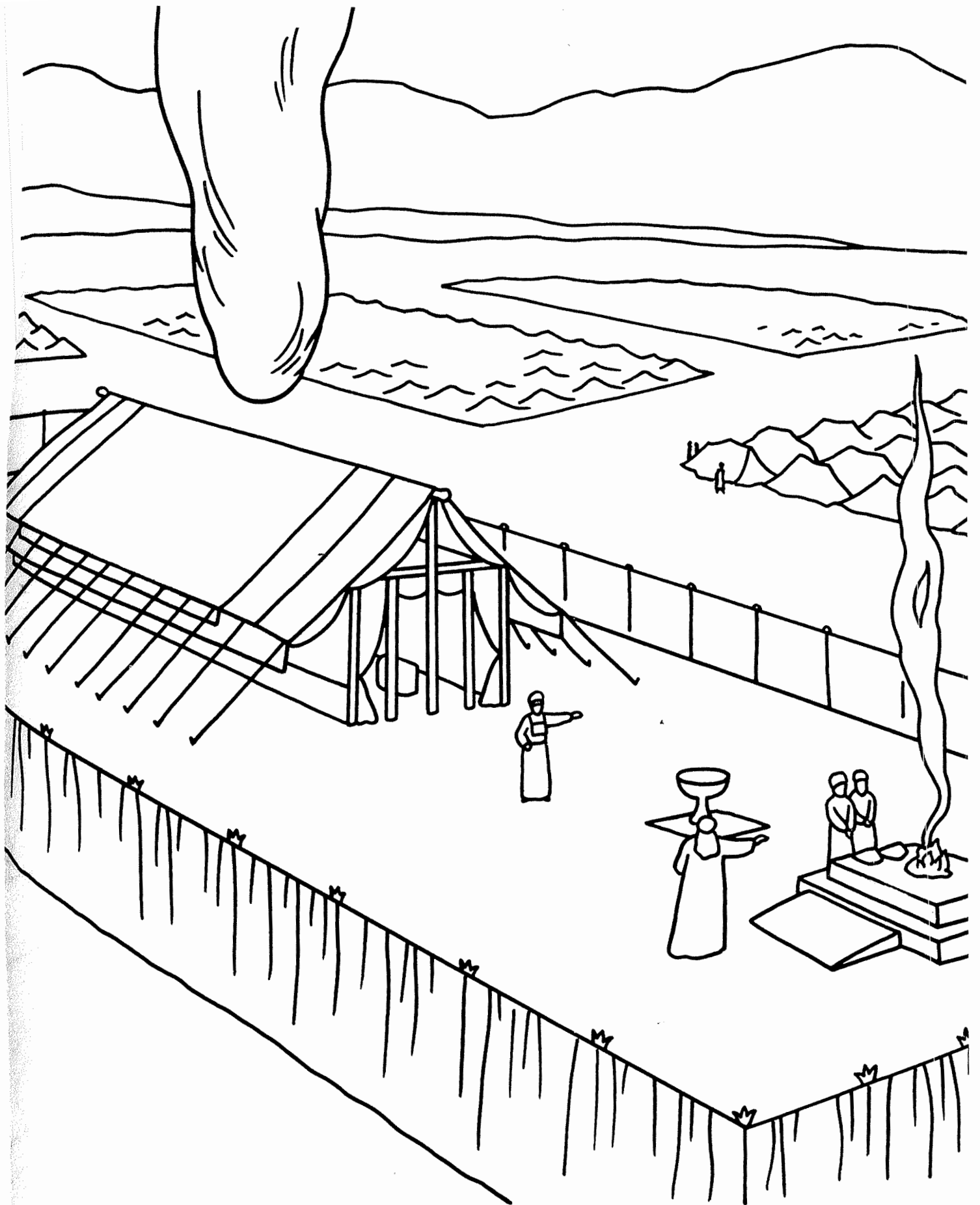

God told His people to build a tabernacle—a large, beautiful tent—as a house of worship. This could be moved from place to place.

[HOME](#)

# Building The Tabernacle

God wanted to dwell among His people in the desert, so He instructed the Israelites to build a home or Tabernacle where His presence would be with them. God instructed the Israelites at Mount Sinai to build a special tent or Tabernacle "*where I will meet with you (Exodus 25:22).*" It was also known as the *House of the Lord* and the *Tent of Meeting*.

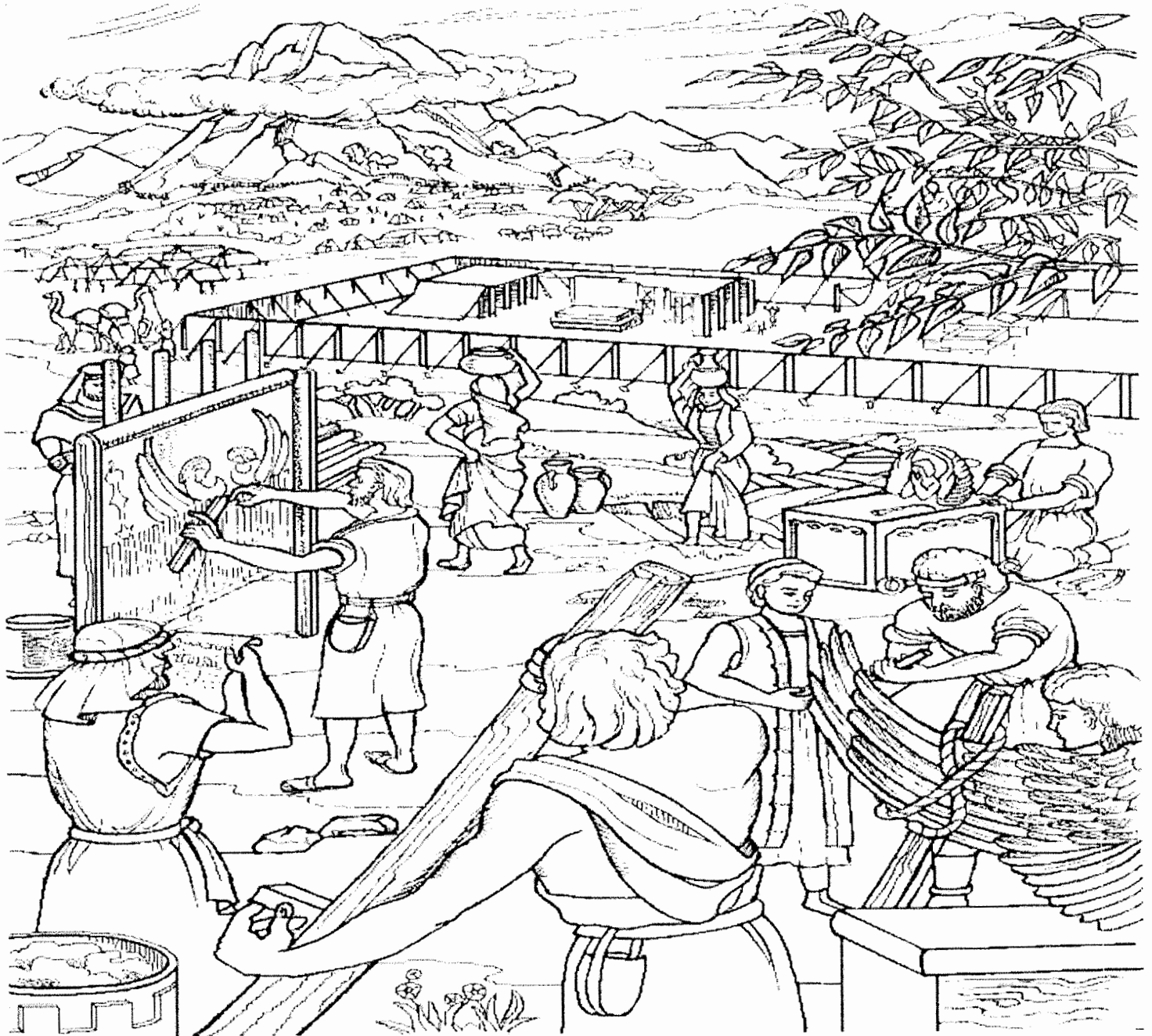



# Holy Of Holies



**The Most Holy Place**

**Exodus 35 - 37:9**



# The Tabernacle

Exodus 36:8 - 40:38

I N C E N S E D D V S P T T H  
D C Z J I S D L C B E R A A O  
C I D L D B O O V S S I B E L  
O L V Z M G U S H B O E E S Y  
F E W K O R H E E P M S R Y P  
R D N A T S P M A L E T N C L  
H O L Y O F H O L I E S A R A  
I X A N O R A A W A N L C E C  
A R K F S N I A T R U C L M E  
D F I B M M S H O W B R E A D

AARON

CURTAINS

HOLY OF HOLIES

LAMPSTAND

PRIESTS

TABERNACLE

ARK

EPHOD

HOLY PLACE

MERCY SEAT

SHOWBREAD

COURTYARD

GOLD

INCENSE

MOSES

SILVER

# The Tabernacle in the Wilderness

God not only gave Moses laws for the Israelites to obey but He also told Moses to build a tabernacle. Read Exodus 25:1-9 and fill in the blanks below to see what God promised

"Then have them make a \_\_\_\_\_ for me  
and I will \_\_\_\_\_ among them." (Exodus 25:8)

Below are some of the things that God told Moses to have built for the Tabernacle

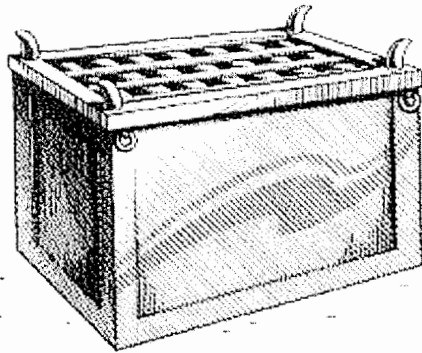

**BRAZEN ALTAR**



**LAVAR**

These were  
outside in the  
Courtyard of  
the Tabernacle



**GOLDEN  
CANDLESTICK**

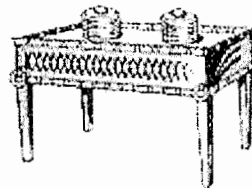
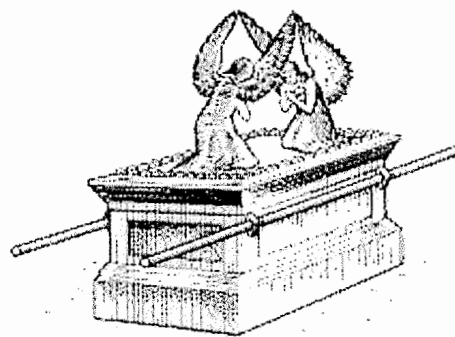

**TABLE OF  
SHEW-BREAD**



**GOLDEN ALTAR**

These were in the  
first compartment  
known as the "Holy"



**ARK OF THE COVENANT**

This was in the second  
compartment known as  
the "Most Holy"

Connect the dots to finish the the picture of the Tabernacle on the next page

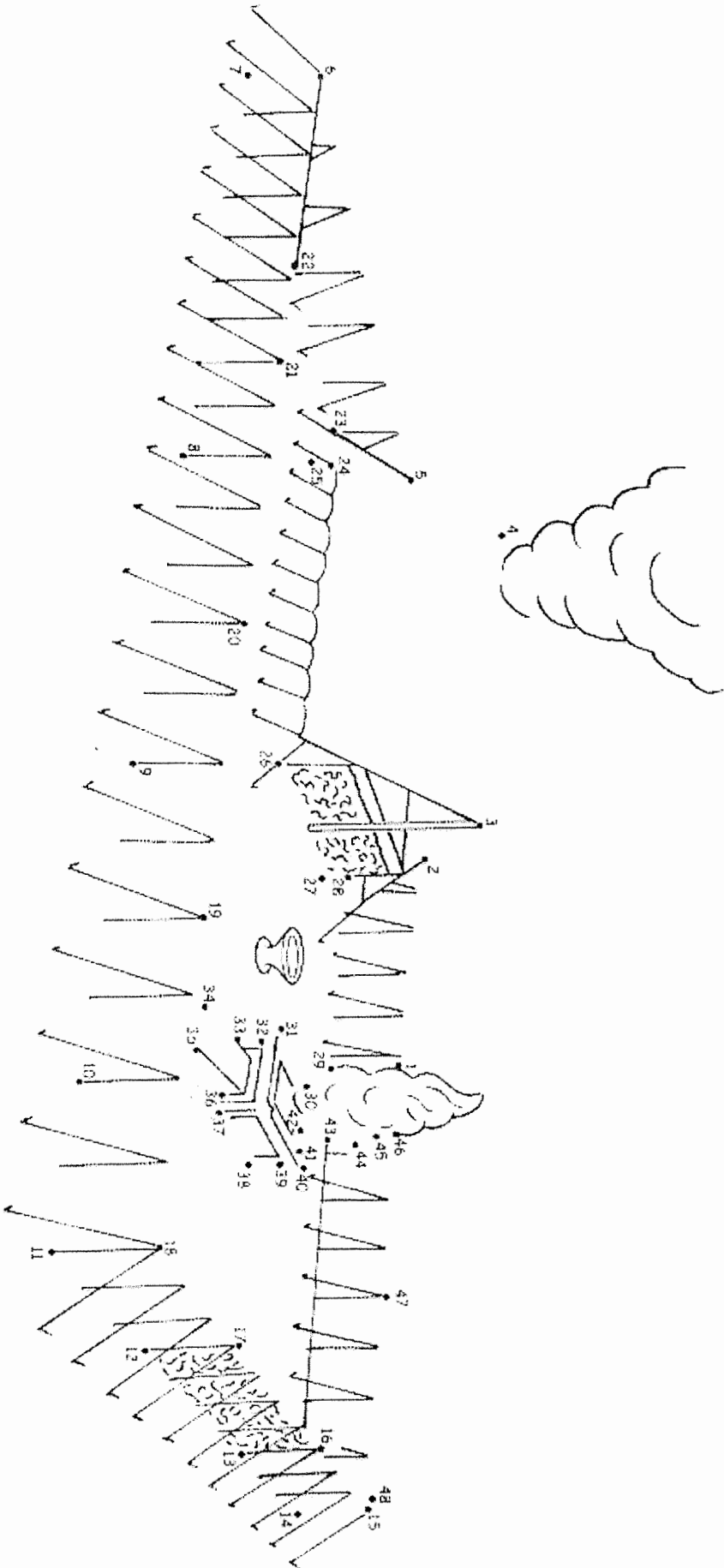

After the Israelites left Egypt, God gave Moses careful instructions for building a Holy Tent called a tabernacle. This special tent could be carried with the people wherever they went so they could worship God anywhere. God asked the people to give what they had to build the tabernacle. The people gave so much that Moses had to tell them to stop giving. God wants us to give willingly to His work too.

The hidden words are from the story in Exodus 35:21-29. The code following each word tells the coordinates where one of the letters of the word is found in the puzzle. After you have found all the hidden words, start at the upper left and use all the leftover letters to fill in the blanks at the bottom of the page with a Bible verse which tells how we should give to the Lord.

		<b>A B C D E F G H I J K L M N O P</b>		
ANOINTING OIL (8H)	1	E V S D O O W M I T T I H S E D	1	LORDS OFFERING (10A)
BLUE (14E)	2	R Y T M R A N O A C C O R G D E	2	MANNER (5H)
BRACELETS (6M)	3	G I E N G E A S M S H E S N P D	3	MOSES (5J)
BREASTPLATE (10J)	4	N U L R C O N G R E G A T I O N	4	RINGS (17K)
CHILDREN (18I)	5	I P B H O S E N T S N H E R B A	5	RULERS (15C)
COMMANDED (5P)	6	R I A N O H S I A O P S L R H M	6	SCARLET (12G)
CONGREGATION (4I)	7	E E T A R L T S I M W I E A O M	7	SERVICE (13F)
EARRINGS (5N)	8	F L E H E T Y N H I I A C E M O	8	SHITTIM WOOD (1H)
FINE LINEN (15L)	9	F S G W G I T G V I S R A E L C	9	SPICE (8M)
HEART (16F)	10	O E E N O I E T A T D F R G R U	10	SPIN (15K)
HOLY GARMENTS (10I)	11	S J D R N G L I P R O I B N G L	11	TABLETS (3C)
ISRAEL (9O)	12	D Y O G V R R L O F M N N E C E	12	WISDOM (9K)
JEWELS (8E)	13	R S O S I I A T S Y F E O R G O	13	WOMEN (4J)
LIGHT (9E)	14	O I D L B T C O V P E L N S T H	14	
	15	L R U L E R S E A C I I G T H E	15	
	16	E R U F U A L G I V E N R I S I	16	
	17	C E O R I E N T H I I E A N S N	17	
	18	I N E S C H I L D R E N E V E N	18	
		<b>A B C D E F G H I J K L M N O P</b>		

**HIDDEN VERSE:** \_\_\_\_\_

\_\_\_\_\_ , \_\_\_\_\_

\_\_\_\_\_ ; \_\_\_\_\_ , \_\_\_\_\_

\_\_\_\_\_ : \_\_\_\_\_

\_\_\_\_\_ . \_\_\_\_\_

\_\_\_\_\_ : \_\_\_\_\_

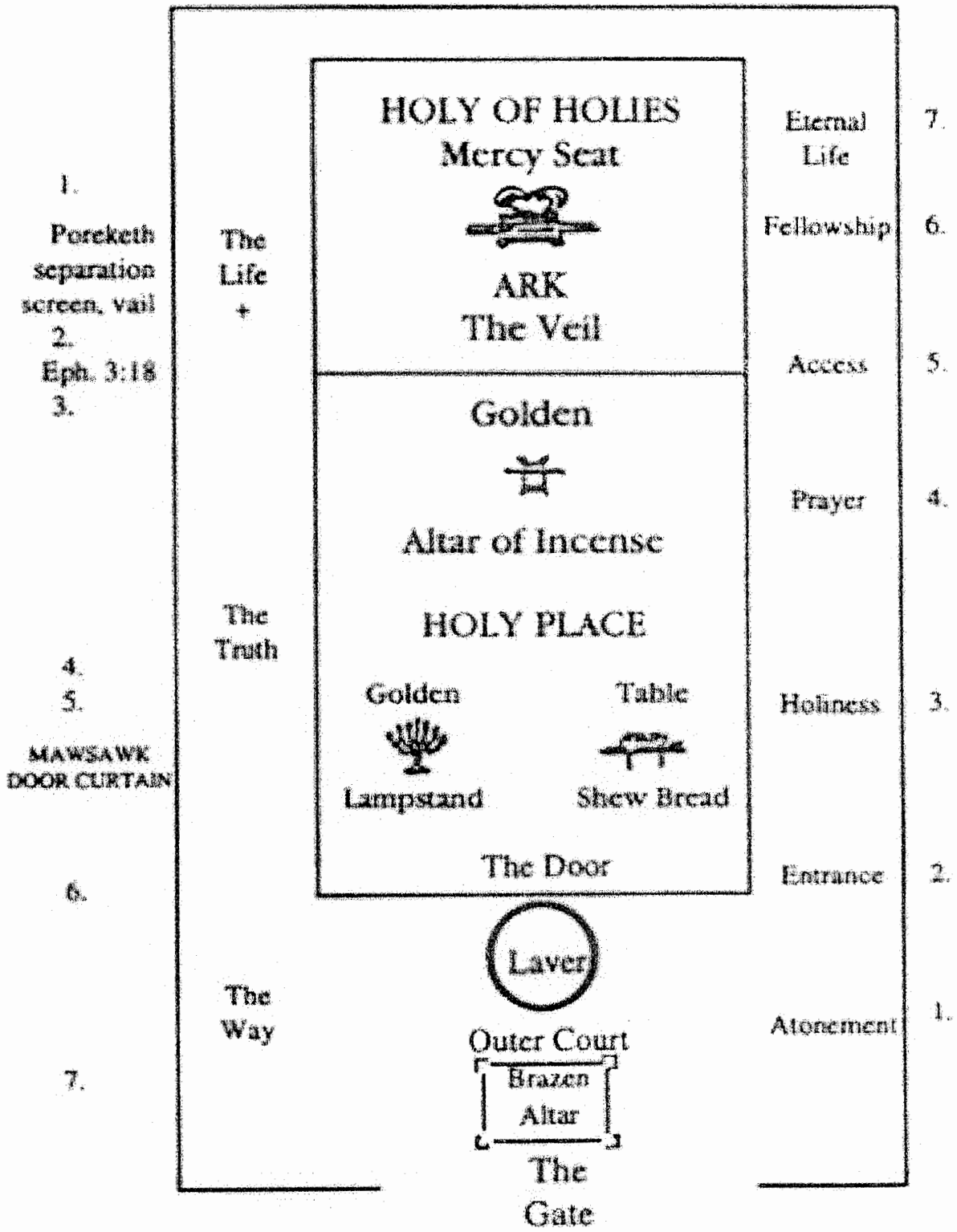

**THE**

**TABERNACLE**

GOD'S PLAN OF

REDEMPTION

THROUGH JESUS CHRIST

THE PERFECT TABERNACLE

HEB. 9:11

AFTER HIS

RESURRECTION

JESUS APPEARED

UNTO HIS DISCIPLES

"And beginning at Moses and all the prophets,

He expounded unto them in all the Scriptures the things concerning Himself." Lk. 24:27.

"And He said unto them,

These are the words which I spake unto you, while I was yet with you, that all things must be fulfilled, which were written in the law of

Moses, and in the prophets, and in the Psalms, concerning Me." v.44.

"Then opened He their understanding, that they might understand the Scriptures," v. 45.  
Deut. 18:15; Jer. 23:5; Jn. 1:45; Ac. 3:22, 23; 13:23

Shekinah Glory

Ex. 25:22; Num. 7:89; 20:6; Lev. 9:23, 24

Jesus is the Shekinah Glory

Jn. 17:5; 1:14

Cherubim

Ex. 25:18-20; 37:7-9

Guardians of God's Throne

Ps. 99:1; 80:1

Jesus is the Captain of our Salvation

Heb. 2:10

Ark of the Covenant

Ex. 25:10-15; 37:1-5

Jesus is the Divine Son of God

Jn. 1:1, 14; 1 Tim. 3:16; 1:17; Jn. 14:9; Col. 1:15, 19; 2:9; Rom. 1:20;

Heb. 1:3; Tit. 2:13; 1 Jn. 5:20; Jude 25; Rev. 1:8, 11, 17; 22:13;

The Blood of Jesus is

the blood of the everlasting covenant

Heb. 13:12, 20; Mt. 26:28; Mk. 14:24, Lk. 22:20

Contents of the Ark:

a. Two tables of the law;

Ex. 25:16; Deut. 10:2, 5

Jesus is the Living Word

Jn. 1:1, 14

b. A golden pot of manna.

Ex. 16:32-34

Jesus is our spiritual food.

Jn. 6:31-58; Rev. 2:17.

c. Aaron's rod that budded.

Num. 17:10; Heb. 9:4

Jesus is our resurrection

Jn. 11:25.

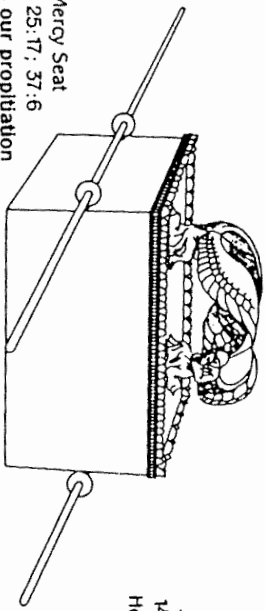

Mercy Seat

Ex. 25:17, 37:6

Jesus is our propitiation  
He pleads for our mercy  
before God

Rom. 3:24, 25; 1 Jn. 2:2;

4:10; Heb. 9:12; 10:12

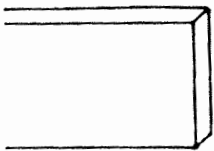

Inner Veil

Ex. 26:31; 36:35

The Flesh of Christ

Heb. 10:19, 20;

Mt. 27:50, 51;

Mk. 15:37, 38; Lk. 23:44-46

**JESUS MADE ONE SACRIFICE FOR ALL**

"But this Man, (Jesus) after He had offered ONE SACRIFICE for sins for ever, sat down on the right hand of God;" Heb. 10:12.

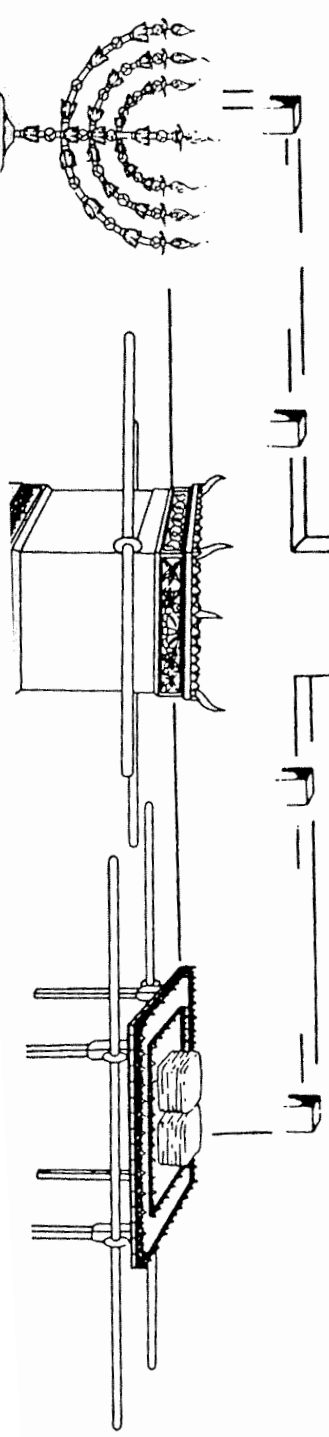



**Golden Candlestick**  
 Ex. 25:31-39; 37:17-24  
**Jesus is the Light of the world**  
 Jn. 8:12; 1:4, 9

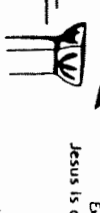
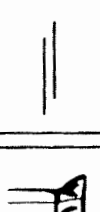

**Golden Altar**  
 (of incense)  
 Ex. 30:1-5; 37:25-28  
**Jesus is our Intercessor**  
 Heb. 7:25; Rom. 8:34; Jn. 7:1-26

**Table of Shewbread**  
 Ex. 25:23-29; 37:10-16  
**Jesus is the bread of life**  
 Jn. 6:35; 48

Incense  
 Ex. 30:34, 36  
 Jesus is our sweet smelling savour  
 Eph. 5:2

Ingredients  
 Ex. 30:34, 35; 37:29  
 Typify the work of the Holy Spirit in the Life of Christ  
 Isa. 42:1; Mt. 3:16; 12:18

Holy Anointing Oil  
 Ex. 30:23-25; 37:29  
 A Type of the Holy Spirit Christ  
 the Anointed  
 Isa. 61:1-3; Lk. 4:18; 19; Ac. 10:38;  
 Heb. 1:9; Ps. 45:7

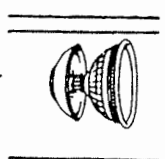

**Laver**  
 (of brass)  
 Ex. 30:18; 38:8  
**Jesus is our cleansing and sanctification**  
 Eph. 5:26; 27; Jn. 17:17; 15:3

**Lamb (for sacrifice)**  
 Ex. 29:38-41 speaks of **Jesus the Perfect Lamb of God Sacrificed for our sins**  
 Jn. 1:29; 36; 1 Pet. 1:18; 19

Blood represents life (shed and sprinkled)  
 Lev. 17:11, 14

**We have redemption through the blood of the lamb (Jesus Christ)**  
 Eph. 1:7; Col. 1:14  
**Jesus made an atonement for our soul**  
 Rom. 5:9; 11

**Altar stood elevated upon the earth, a type of Golgotha's hill, the Place of the Skull, Calvary**  
 Jn. 19:17 Mt. 27:33; Mk. 15:22; Lk. 23:33

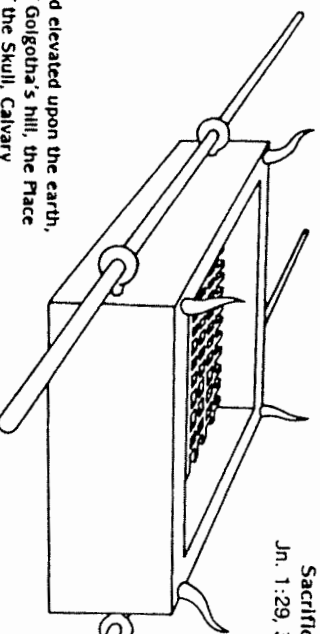

**Brazen Altar**  
 (of burnt-offering)  
 Ex. 27:1-8; 38:1-7  
**Sacrifice Atonement**  
 Lev. 17:11; Heb. 9:22, 26, 28  
**Altar is a type of the Cross (upon which Jesus Christ was Crucified)**  
 Col. 1:20; 2:14; Eph. 2:16

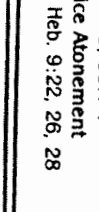
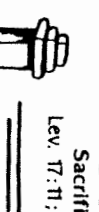
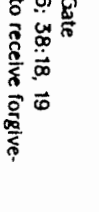
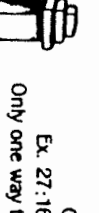
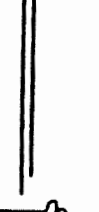

**Gate**  
 Ex. 27:16; 38:18, 19  
**Only one way to receive forgiveness from sin**  
**Jesus is the way**  
 Jn. 14:6

**Jesus Christ,**  
 "...a greater and more Perfect Tabernacle, not made with hands..."  
 Heb. 9:11

**"Jesus Christ the same yesterday, and to-day, and forever."**  
 Heb. 13:8

**For I am the Lord, I change not;"**  
 Mal. 3:6

**We see Jesus Christ THE PERFECT LAMB OF GOD Sacrificed Past, Present, and Future in The Word of God!**

- a. In Rev. 13:8  
 The Lamb slain, "From the foundation of the world;"
- b. In Exodus chapter twelve  
 The Passover lamb slain in Egypt, speaks of "Christ our Passover is Sacrificed for us;"  
 1 Cor. 5:7
- c. In Ex. 29:38-41  
 The lamb slain in The Tabernacle Courtyard upon The Brazen Altar (of burnt-offering) for the sacrifice for sin by the shedding of blood is a type of GOD'S PERFECT LAMB, Jesus Christ our Redeemer.  
 Jn. 1:29; 36  
 "Behold The Lamb of God, which taketh away the sin of the world."  
 1 Pet. 1:19 We were Redeemed, "With The Precious Blood of Christ, as of a Lamb without blemish and without spot;"  
 In Isa. 53:7, 11; Ac. 8:32
- d. The Lamb slain in prophecy;  
 Jesus, "is brought as a Lamb to the slaughter;"  
 In Mt. 27:35
- e. The Lamb of God actually slain.  
 Jesus took the form of flesh, Lived a Perfect Life (without sin) gave Himself a Sacrifice for our sins, by the shedding of His Own Blood upon The Cross (Altar) of Calvary; "And they Crucified (Jesus) Him;"  
 Mk. 15:24; Lk. 23:33; Jn. 19:23
- f. In Rev. 5:6  
 The Lamb of God in Heaven, Jesus is standing as, "a Lamb as it had been slain."  
 In Rev. 7:17  
 Jesus is, "in the midst of The Throne."

Ark,  
 (of the Covenant)  
 speaks of the Person of Christ:  
 Gold, speaks of Jesus Perfect God.  
 Wood, speaks of Jesus Perfect Man.

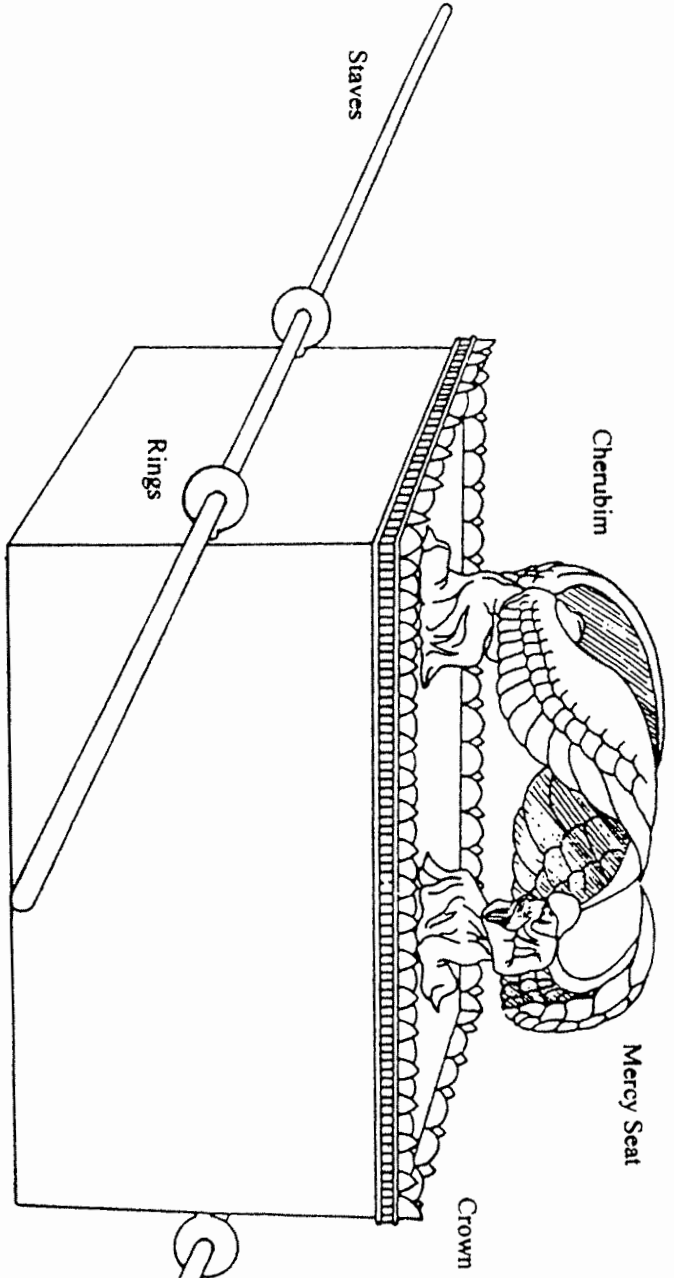

1. Visual illustration.  
**The Ark, (of the Covenant).**  
 Ex.25:10-25; 37:1-5
2. Type of Christ.
  - a. **The Divine Nature of Jesus Christ,**  
 (God made Flesh. Jesus is the  
 Divine Son of God).  
 1 Tim.3:16; 1:17; Rom.8:3; 1:20;  
 1 Jn.5:20; Jn.1:1,14; 14:9; Col.1:15,19;  
 2:9; Heb.1:3; Tit.2:13; Jude 25;  
 Phil.2:6,7; Rev.1:8,11,17; 22:13
  - a. **Our everlasting Blood Covenant.**  
 Heb.13:20; Mt.26:28;  
 Mk.14:24; Lk.22:20
3. Applied to the believer.  
**We are partakers of His Divine Nature through faith in His Blood Covenant.**  
 2 Pet.1:4  
**To receive His Divine Nature.**  
 Jn.3:5,6; 5:24; 2 Cor.5:17
4. Believer's responsibility.  
**To live under His everlasting Blood Covenant by faith in His Blood.**  
 Rom.3:25; 6:12,18; 8:16

Isa.9:6

“Unto us a Child is born, unto us a Son is given: and the government shall be upon His shoulder: and His Name shall be called wonderful, counsellor, the mighty God, the everlasting Father, the prince of peace.”

Col.1:15

Jesus, “Is the image of the invisible God.”

Locate the Ark of the Covenant  
 in the Holy of Holies on pg.14

**Year 1**

**Week 42**

## **The First Priest**

**Scriptures: Exodus 28, 39 also Leviticus 8-10**

**Key Verse: Leviticus 10:3 “By those who come near Me I must be regarded as holy; And before all the people I must be glorified.”**

### **Key Points:**

1. The high priest was to perform the sacred duties in the tabernacle. They were to perform sacrifices and offerings for the sins of the people. He was a mediator between God and the children of Israel.

2. God gave Moses very specific instructions for the anointing of the high priests as well as for making of the holy garments they were to wear. Aaron, Moses brother, and his sons were to do these tasks. Priesthood was set in the tribe of Levi from which Aaron descended.

3. Artisans made the holy garments. Explain the details of the breastplate, ephod, robe, woven tunic, turban and sash-what they were made from and how they were made. The materials for these were also free-will gifts brought from the Israelites, as for the tabernacle.

4. Sons of Aaron, Nadab and Abihu, were killed by fire for their sins for offering profane fire. God’s commandments concerning the high priests and the sacredness of the tabernacle were to be followed strictly. We also should worship in the way God has asked.

5. Christ is our high priest. He offered his own blood, once for all. He became the mediator between us and God.



'High Priest' ©Terry Tavlör Illustrated by Brian W.

# THE HIGH PRIEST AND HIS GARMENTS

---

Mitre

Breastplate

Girdle

Ephod

Robe

Embroidered  
Coat

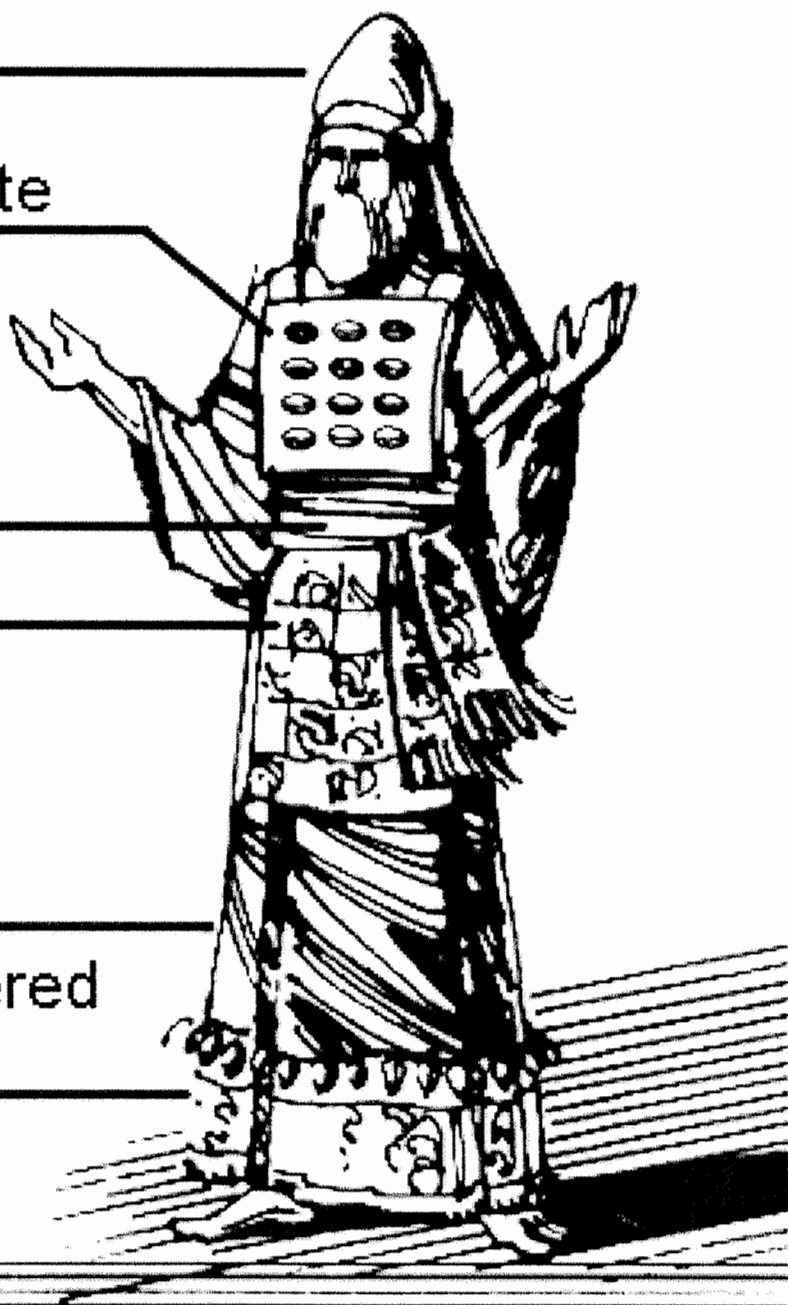



**Inscription on Turban  
"Holy to the Lord"**  
(Exodus 28:36)

**Turban  
(Mitre)**  
(Exodus 28:4, 39;  
29:6)

**Breastplate with  
12 Precious Stones**  
(Exodus 28:30;  
Exodus 28:17-21)

**Onyx Stones  
on Shoulders**  
(Exodus 28:9-12;  
39:6, 7)

**The Urim and  
Thummim (not  
visible) were  
placed in the  
breastpiece**  
(Exodus 28:30)

**Girdle  
(a Sash)**

**Ephod**  
(Exodus 28:4;  
Ps. 132:9)

**Censer of  
Burning Coals**  
(Leviticus 16:12, 13  
Hebrews 9:4)

**Robe**  
(Exodus 28:34)

**Bells and  
Pomegranates**

**Fine Linen  
Tunic**

# High Priest, and his garments of glory and beauty.

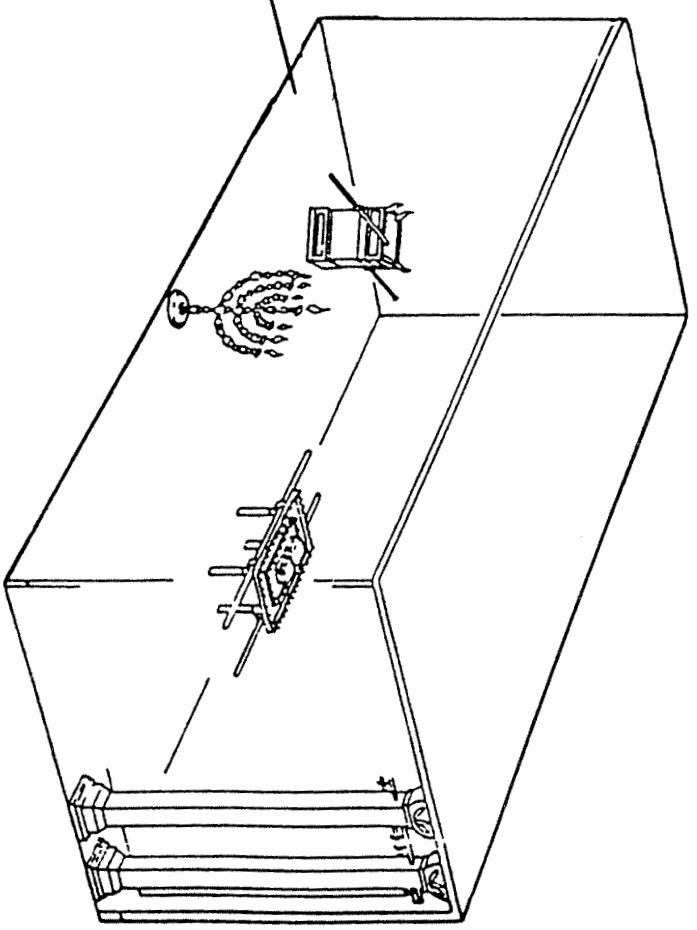
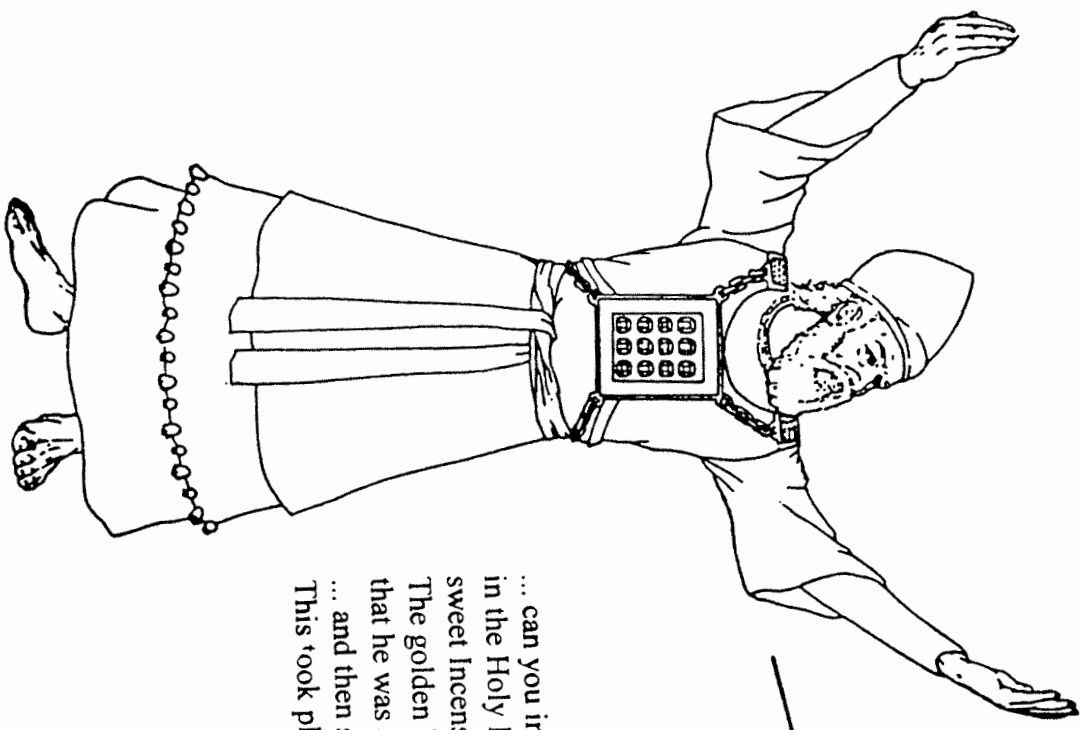

... can you imagine the high priest going about his daily service in the Holy Place, arranging the bread on the Table, burning the sweet Incense, and dressing the Lamps. The golden bells on the hem of his robe, sent up a glorious sound that he was about his Father's business! ... and then **suddenly! God, Himself rent the veil in two!** This took place in the temple. Jn.2:20-22; Mt.27:51,52

**Heb.8:1**

“We have such an high priest, who is set on the right hand of the throne of the Majesty in the heavens;”

Heb.10:12; 12:2; Eph.1:20; Col.3:1

Locate the high priest in the Holy Place on pg. 14



**High Priest and His Garments of  
Glory and Beauty is a type of Christ  
our Great High Priest High and Exalted**

**Seven articles of clothing,  
speak of Divine Perfection.**

1. Breeches, (White Linen) speak of The Perfect Provision God has made for us in Christ.
  - with the Girdle, (Plain) speaks of Service.
2. Coat, (White linen) speaks of The Righteousness and Spotless Purity of Christ.
3. Robe, (blue) speaks of The Divinity of Christ.
  - Pomegranates, (Blue, purple and scarlet) speak of Fruitfulness.
  - Bells, (Golden) speak of Testimony and Praise.
4. Ephod, (Gold, blue, purple and scarlet) speaks of The Position, Office and Character of Jesus Christ.
5. Breastplate, (Gold, blue, purple, scarlet) speaks of Jesus the Loving One.
  - Stones, are a type of believers.
  - Urim and Thummim, speak of Jesus the Light, Perfection, Illumination and Truth.
  - Shoulder Stones.
  - Shoulders, speak of Strength (or Power).
6. Curious Girdle, (Gold, blue, purple, scarlet) speak of A Gathering (Binding) Together.
7. Miter, (Fine white linen) speaks of The Authority of Jesus Christ.
  - Golden Plate, with the inscription upon it “Holiness unto the Lord”

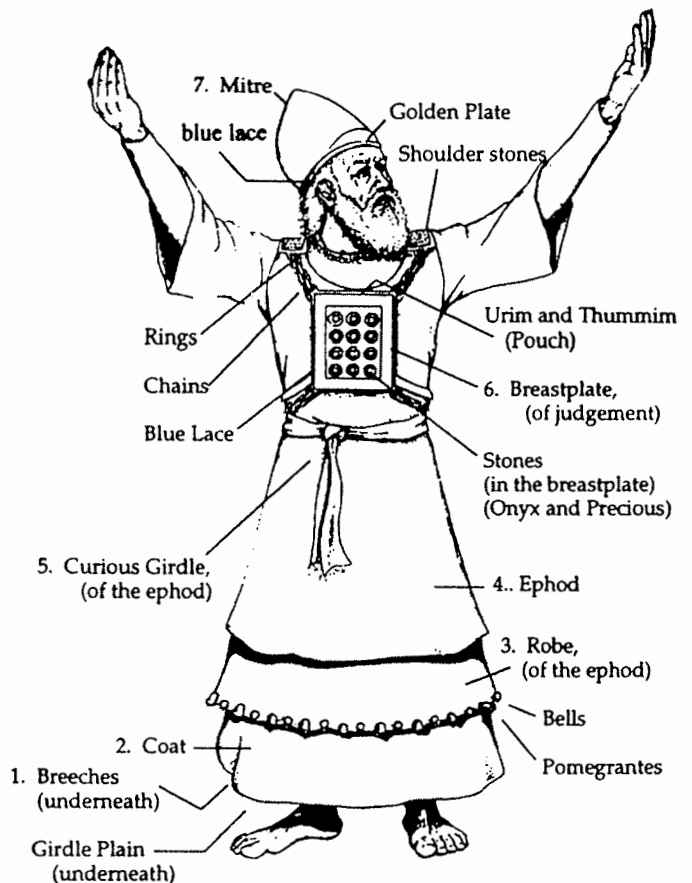

Locate the **only place** in the Tabernacle Proper where the **high priest** served when he wore his **seven piece garments of glory and beauty** on Pg.14



Name: \_\_\_\_\_

Date \_\_\_\_\_

## The Priests and the Tabernacle

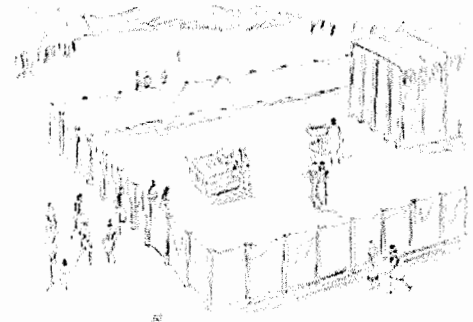

sweetpublishing.com (CC BY-SA 3.0)

1. \_\_\_\_\_ the priestly garments were made from blue, purple and \_\_\_\_\_ yarn
2. \_\_\_\_\_ box with golden cherubim on the lid
3. \_\_\_\_\_ how many lamps did the lampstand have?
4. \_\_\_\_\_ the number of precious stones in the priest's breastpiece
5. \_\_\_\_\_ the inscription on the plate on the priest's turban: \_\_\_\_\_ to the Lord
6. \_\_\_\_\_ one of the colors of the tabernacle curtains
7. \_\_\_\_\_ attached to the hem of the priest's tunic
8. \_\_\_\_\_ the \_\_\_\_\_ of the Lord filled the tabernacle
9. \_\_\_\_\_ what were the utensils for the altar made from?
10. \_\_\_\_\_ a type of tent

1. tabernacle  
2. purple  
3. ark

4. seven  
5. bronze  
6. scarlet

7. twelve  
8. pomegranates  
9. holy

10. glory

Name: \_\_\_\_\_

Date: \_\_\_\_\_

# The Priests and the Tabernacle

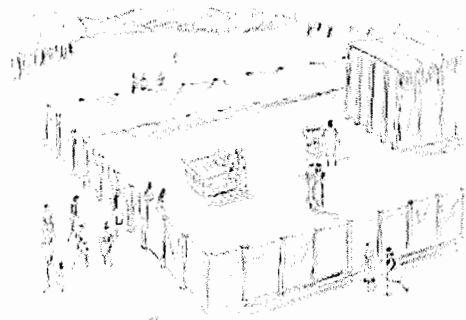

sweetpublishing.com (CC BY-SA 3.0)

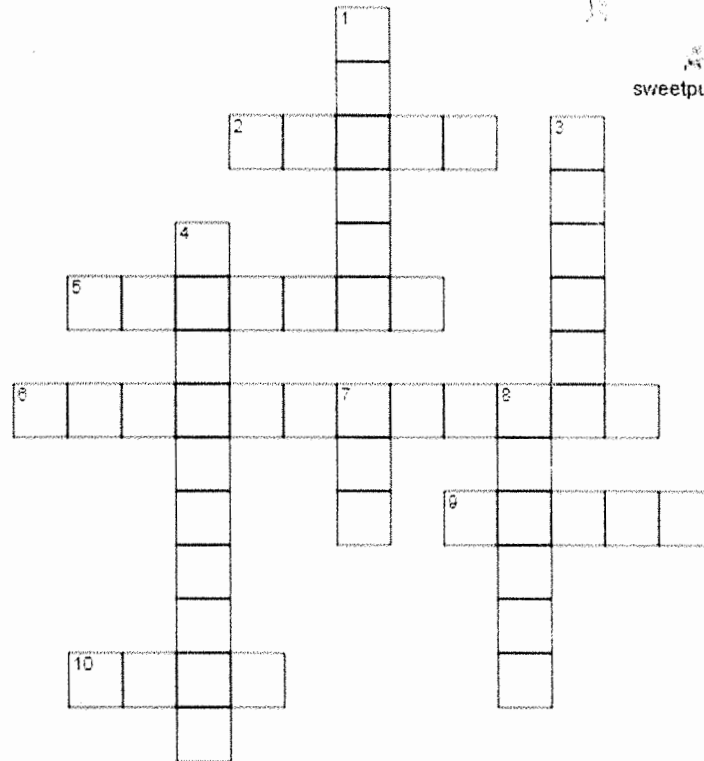

## ACROSS

2. the \_\_\_ of the Lord filled the tabernacle
5. the priestly garments were made from blue, purple and \_\_\_ yarn
6. attached to the hem of the priest's tunic
9. how many lamps did the lampstand have?
10. the inscription on the plate on the priest's turban: \_\_\_ to the Lord

## DOWN

1. what were the utensils for the altar made from?
3. one of the colors of the tabernacle curtains
4. a type of tent
7. box with golden cherubim on the lid
8. the number of precious stones in the priest's breastpiece

# God Led Them

N	C	H	I	L	D	R	E	N	M	A	C	W	C	L	O	U	D
G	G	T	R	U	F	I	R	E	Y	N	T	F	A	Y	F	C	E
L	M	N	A	A	N	G	T	N	I	O	N	A	F	E	F	A	S
A	S	E	I	L	N	I	C	A	N	M	A	F	A	M	E	N	N
L	R	C	C	T	T	A	C	J	C	A	E	N	L	N	R	D	E
C	F	F	I	A	S	A	C	O	Y	C	D	T	D	D	I	L	C
L	R	H	T	R	S	A	R	L	R	R	L	T	R	E	N	E	N
I	Y	R	L	S	C	Y	L	C	E	C	O	A	L	H	G	S	I
M	S	A	T	T	A	B	E	R	N	A	C	L	E	S	I	T	C
W	O	T	C	H	Y	R	C	N	E	Y	R	M	A	A	R	I	Y
R	T	J	N	Y	R	O	L	G	R	V	F	S	O	W	T	C	G
F	K	W	Y	E	S	A	T	A	C	U	E	I	I	S	G	K	Y
F	N	R	I	N	M	A	O	J	C	A	O	O	T	K	E	N	C
E	N	R	N	R	T	R	G	M	F	R	A	J	R	C	F	S	R
O	I	T	Y	Y	T	F	A	R	L	A	E	A	E	W	N	E	E
D	R	C	O	N	G	R	E	G	A	T	I	O	N	G	O	A	M
O	N	O	R	A	A	Y	E	C	O	L	O	A	N	F	E	R	S
R	T	A	N	M	Y	R	T	A	W	M	Y	R	N	R	T	S	N

**3 Letters**

ARK

**4 Letters**

FIRE

**5 Letters**

AARON

ALTAR

CLOUD

GLORY

MERCY

MOSES

**6 Letters**

ANOINT

ISRAEL

WASHED

**7 Letters**

INCENSE

**8 Letters**

CHILDREN

GARMENTS

JOURNEYS

OFFERING

SANCTIFY

**10 Letters**

TABERNACLE

**11 Letters**

CANDLESTICK

EVERLASTING

**12 Letters**

CONGREGATION

## **Year 1**

### **Week 43**

### **Silver Trumpets and Israelite Grumblers**

**Scriptures: Numbers 10 - 11**

**Key Verse: Numbers 11:1 Now when the people complained it displeased the Lord; for the Lord heard it and His anger was aroused.**

#### **Key Points:**

1. God commanded that 2 silver trumpets be made. They were to be for the calling of the assembly and for directing the movement of the camps. They were also to be blown during appointed feasts and over offerings and sacrifices.

2. The cloud was lifted from above the tabernacle and they set out on their journeys from the Wilderness of Sinai to the Wilderness of Paran. This was the first time the tabernacle was moved. The children of Israel were set out in groups to march, with the ark in the covenant going before them.

3. The people grumbled about their food. They missed the tasty food they had in Egypt. They whined, wanting meat to eat. God burned with anger because of their grumbling. Moses was frustrated with them and went to God for help.

4. God told Moses he would send quail for them to eat for a whole month. They would have so much quail that it would come out their nostrils and they would loathe it. He did this because they despised the Lord and grumbled against Him. A wind went out from the Lord and brought the quail. It covered 20 miles and was 3 feet high.

5. They ate the quail greedily. The Lords wrath came against them and he struck them with a plague. Many were sick and died. We should be careful of our grumbling and complaining for it is not pleasing to God.

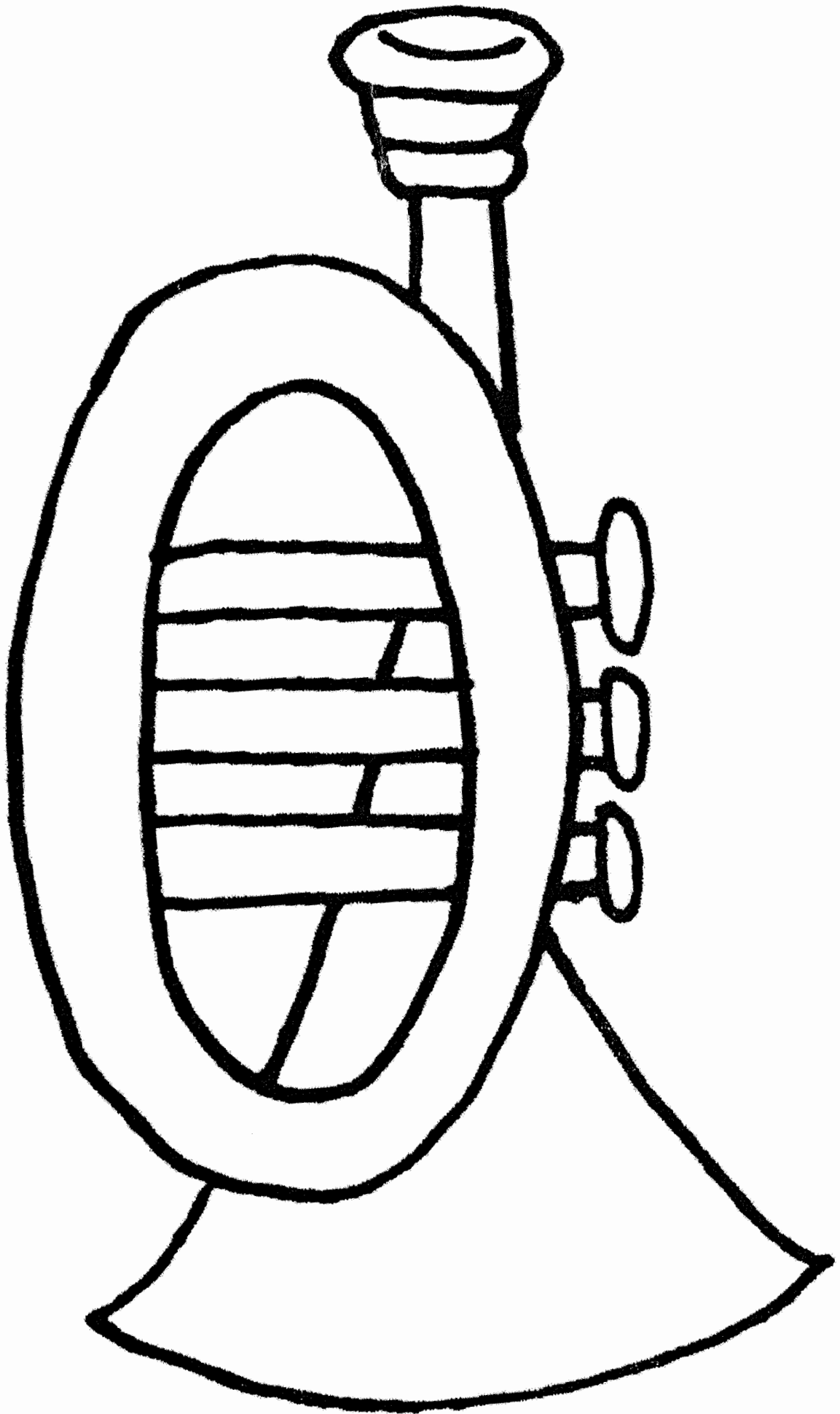

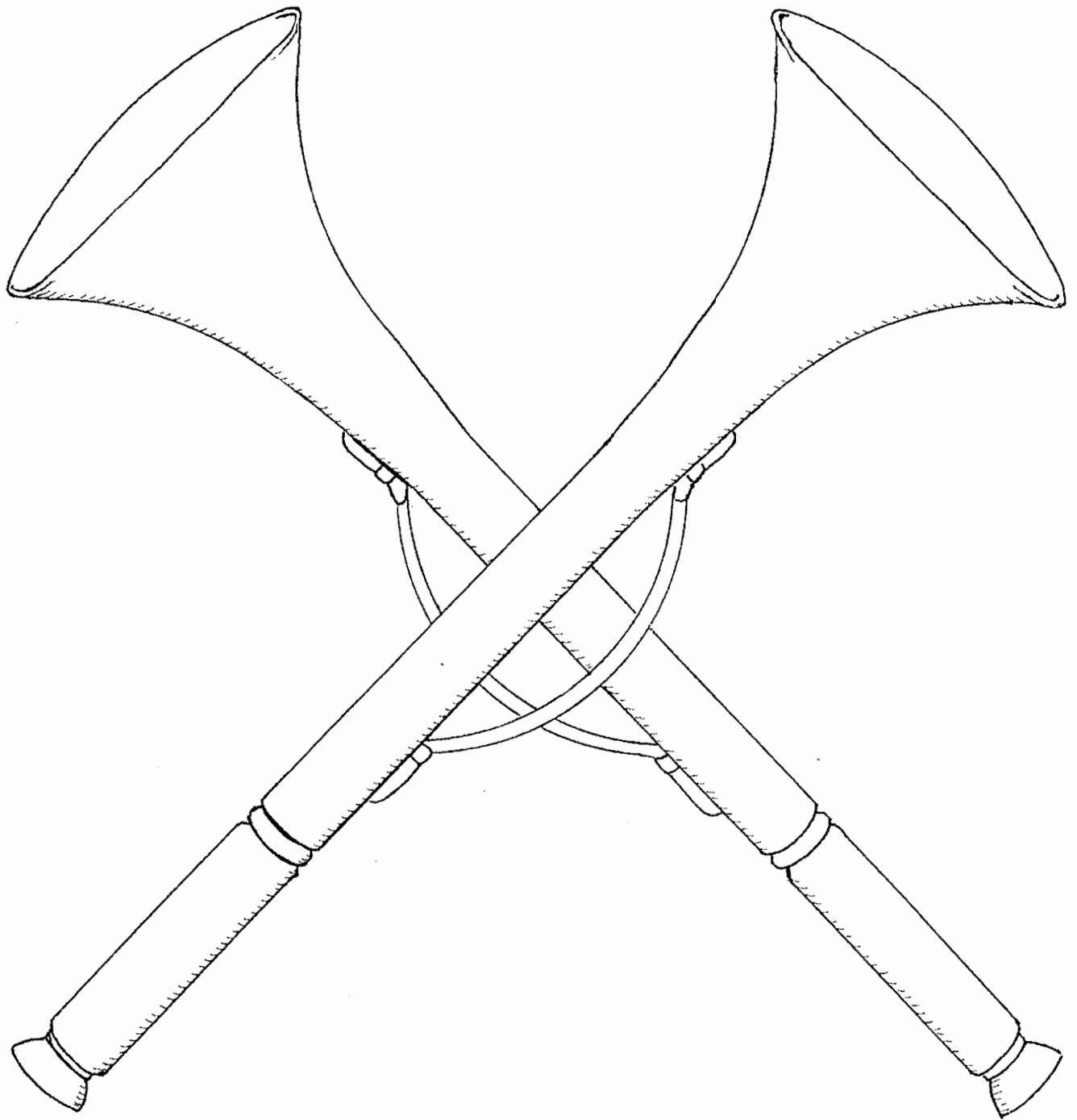

"Make two trumpets of silver for yourself. You shall make them of beaten work. And they shall be used for the calling of the assembly and for the journeying of the camps. And when they shall blow with them, all the assembly shall gather themselves to you at the door of the tabernacle of the congregation." Numbers 10:2-3



*These trumpets were to be blown for different reasons; for calling an assembly of the people, for journeying of the camps, for gathering the princes of the tribes or to blow an alarm.*



*The sons of Aaron, the Priests, were to blow the trumpets by an ordinance (or law) forever. Also they were to be blown before going to war against an enemy who attacks them, and they would be saved from their enemies.*



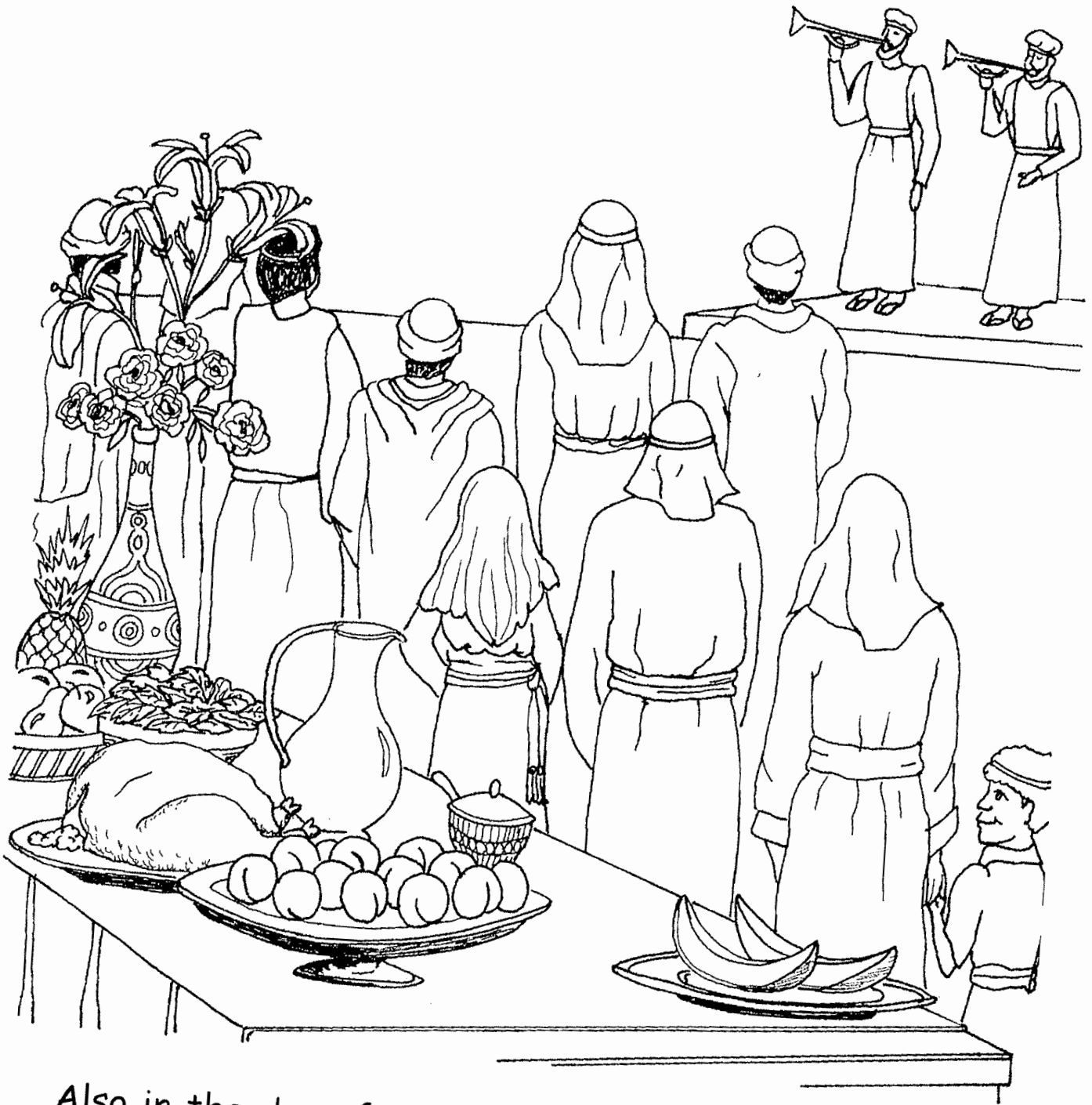

Also in the day of your gladness, and in your appointed feasts, and in the beginnings of your months, you shall blow with the silver trumpets over your burnt offerings, and over the sacrifices of your peace offerings, so that they may be to you for a memorial before your GOD. I am the LORD your God." Numbers 10:10

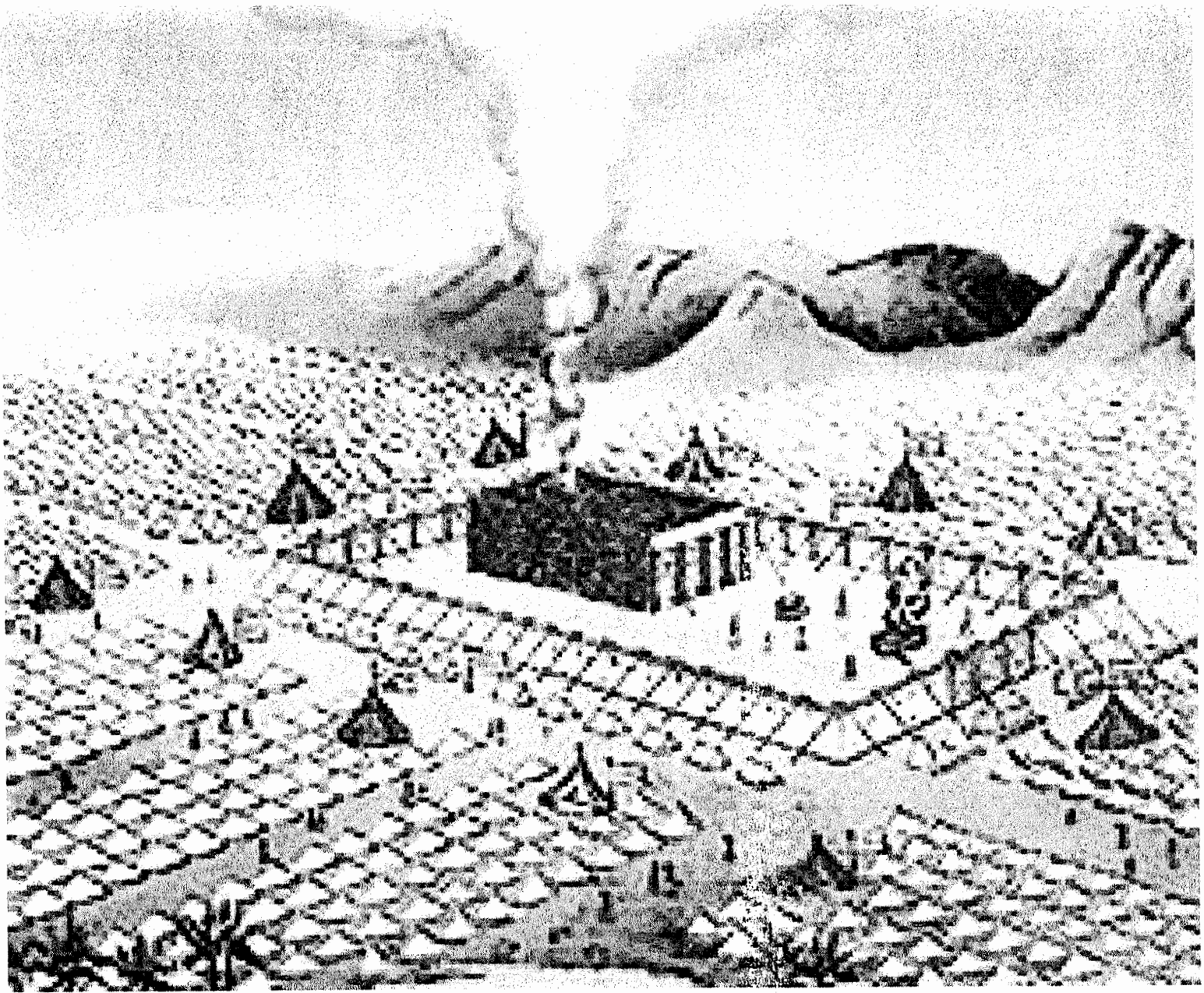

## Silver Trumpets Direct the People

### Numbers

**10** And the Lord spoke to Moses, saying: **2** "Make two silver trumpets for yourself; you shall make them of hammered work; you shall use them for calling the congregation and for directing the movement of the camps. **3** When they blow both of them, all the congregation shall gather before you at the door of the tabernacle of meeting.

# 48. THE LORD SENDS QUAIL

(NUMBERS 11:4-14, 31-34)

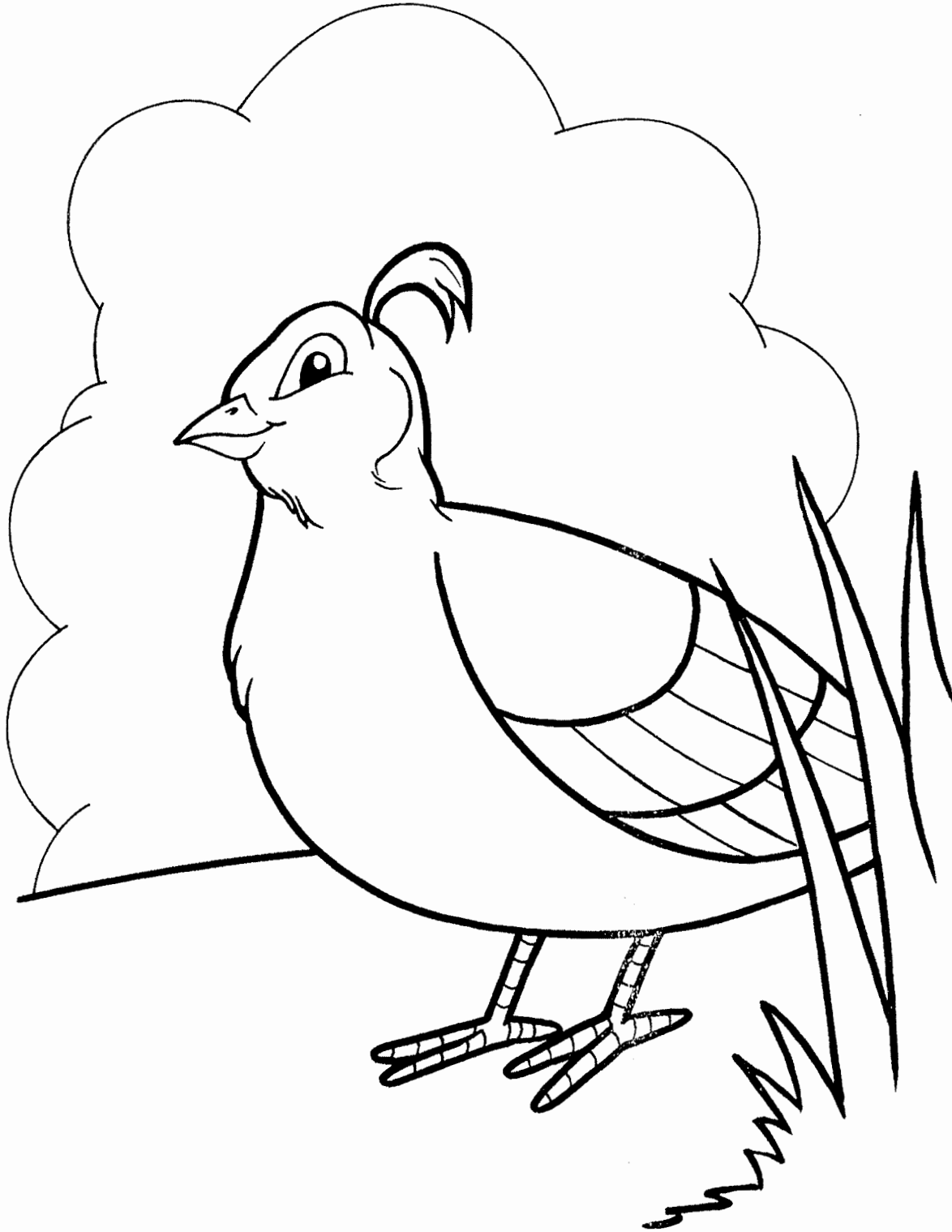

“And there went forth a wind from the LORD, and brought quails from the sea, and let *them* fall by the camp, as it were a day's journey on this side, and as it were a day's journey on the other side, round about the camp, and as it were two cubits *high* upon the face of the earth.”

**NUMBERS 11:31**

# QUAIL FROM THE LORD

*Numbers 11:4-35*



*God sent quail for the Israelites because they complained*

# QUAIL FROM THE LORD

*Numbers 11:4-35*

QUAIL PATTERN

## Paper Quail

Trace quail on to cardstock and cut out. Have the children color, cut slit and place wing through the slit. You can then place a whole in the top for a string to hang.

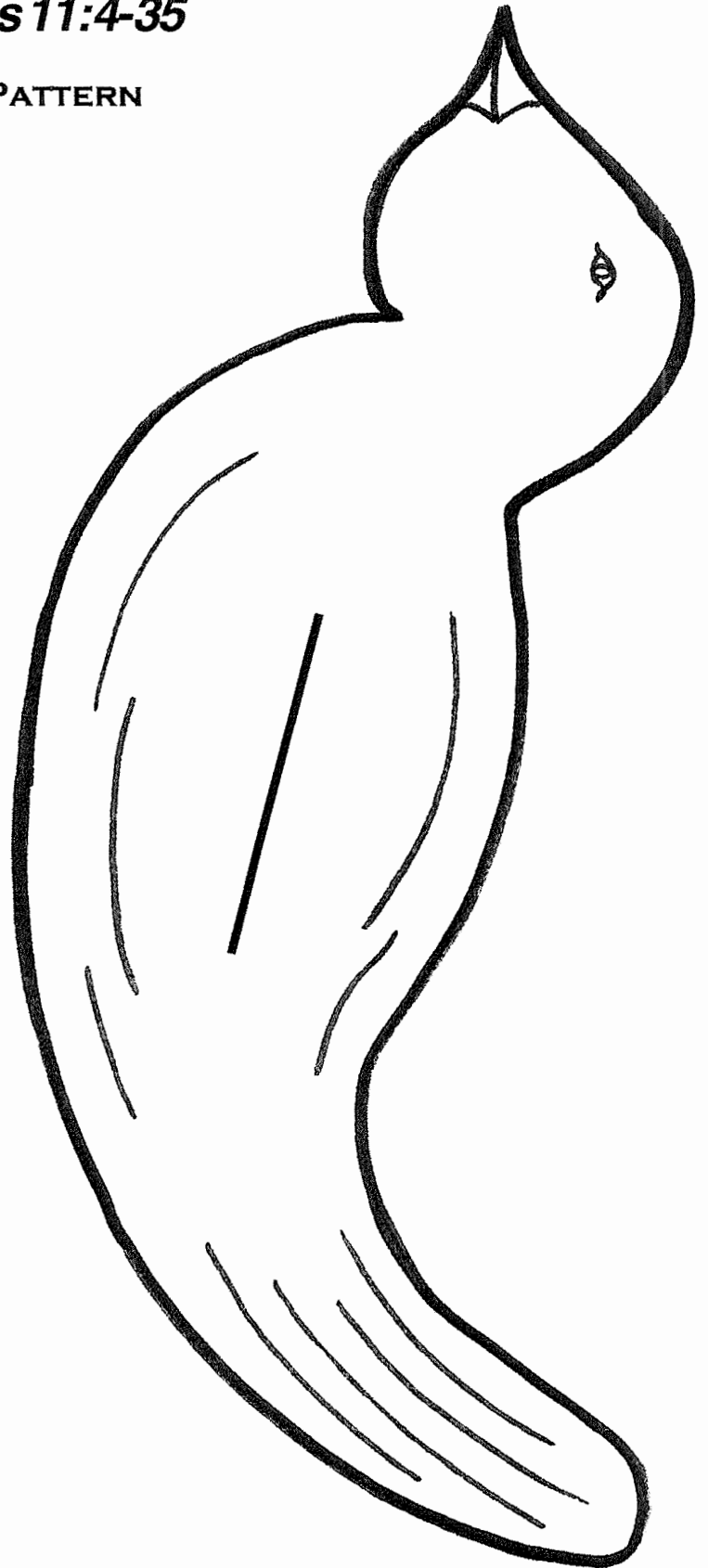
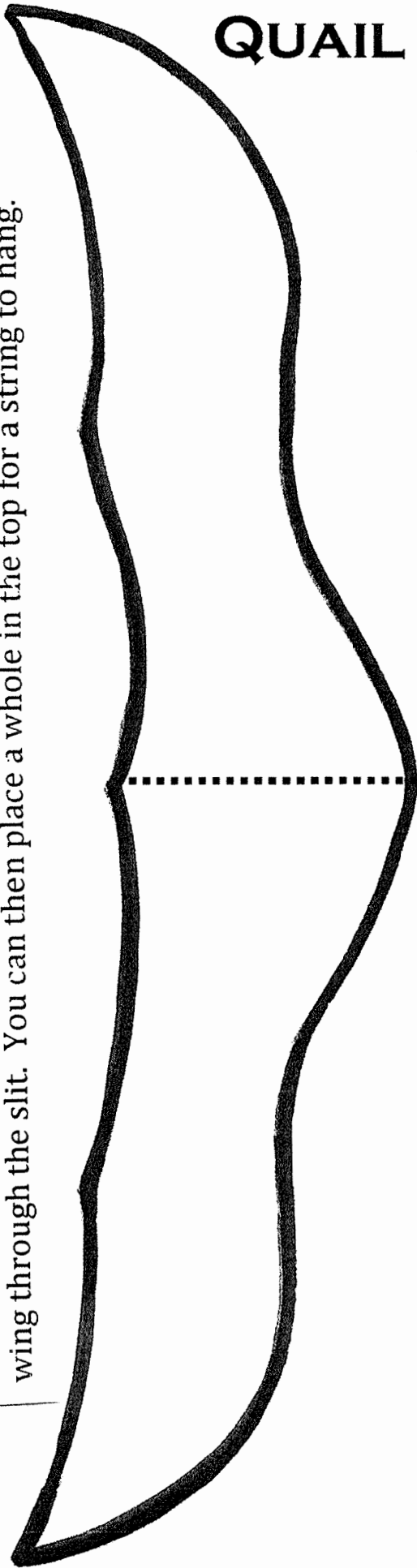

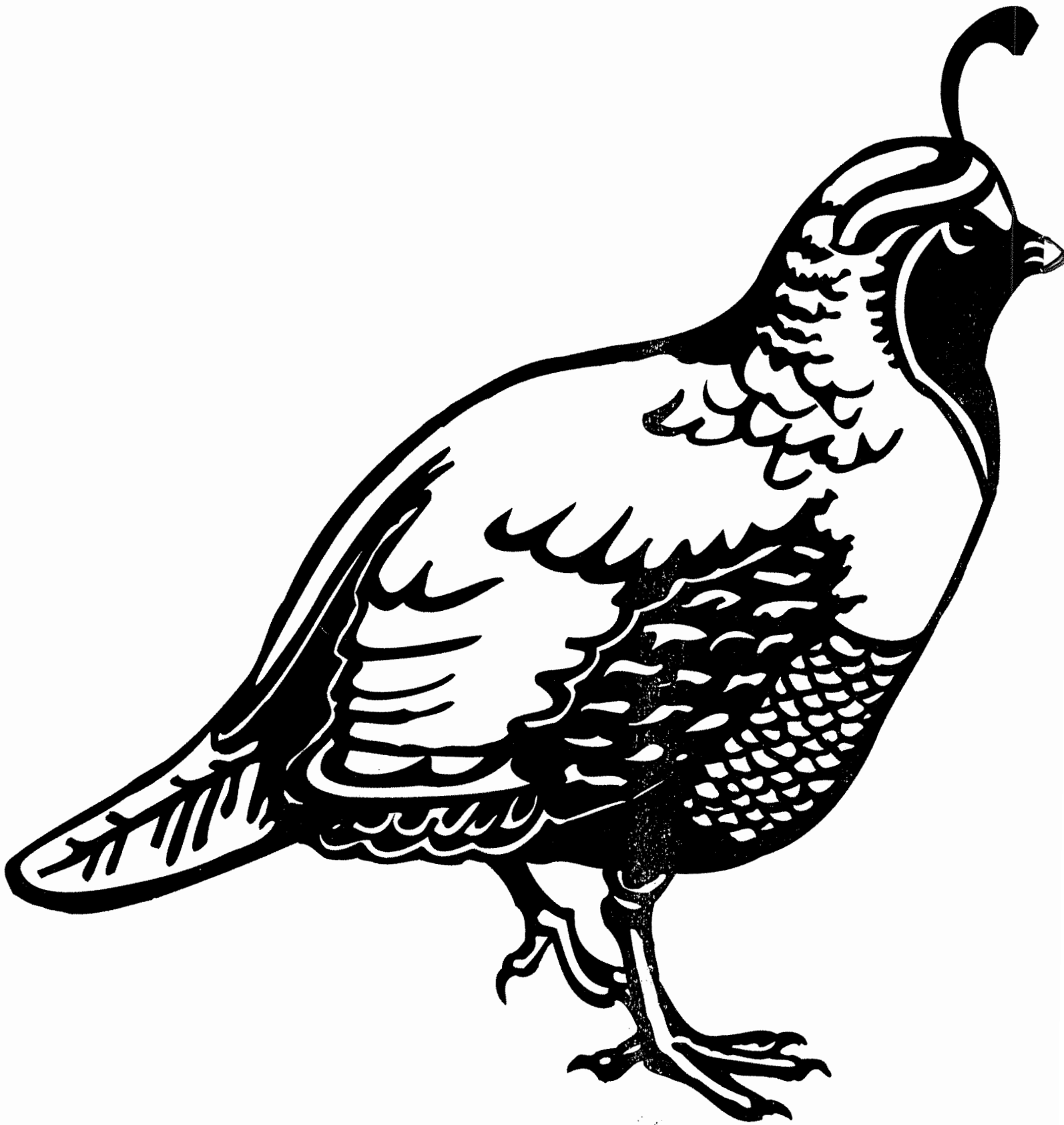

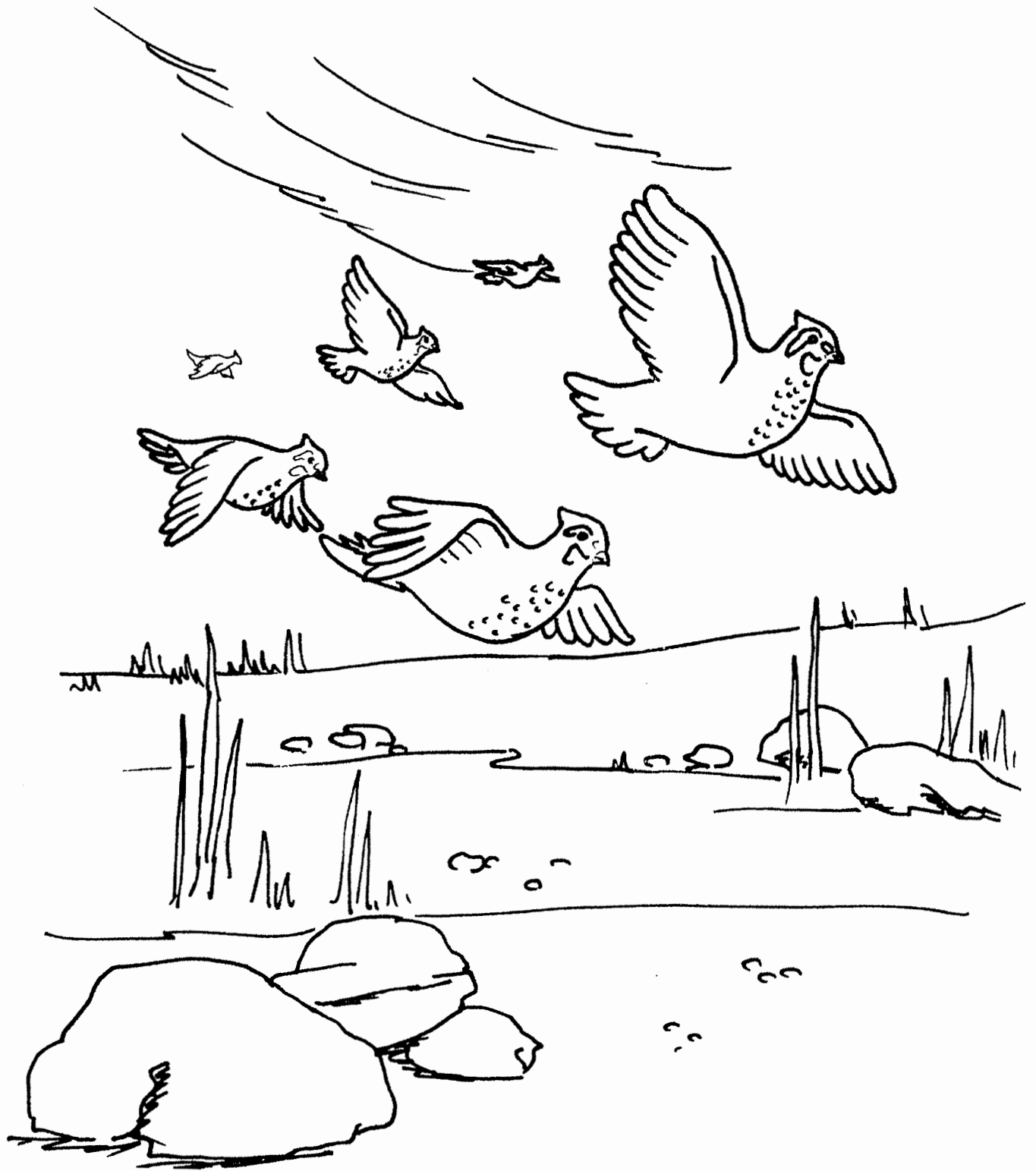

Moses timeline. This can be used as chronology or sequencing. Print and cut out. Have children place them in order on construction paper.

**1526 B.C.**

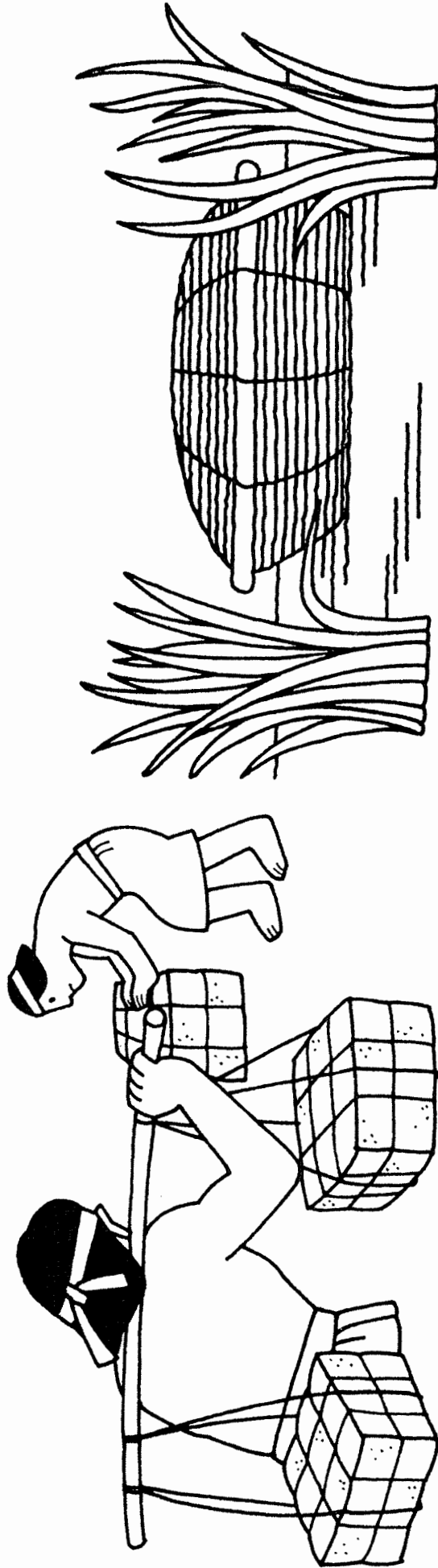

**Israel Enslaved in Egypt**

Exodus 1:1-22

**Baby Moses**

Exodus 2:1-10



**1450 B.C.**

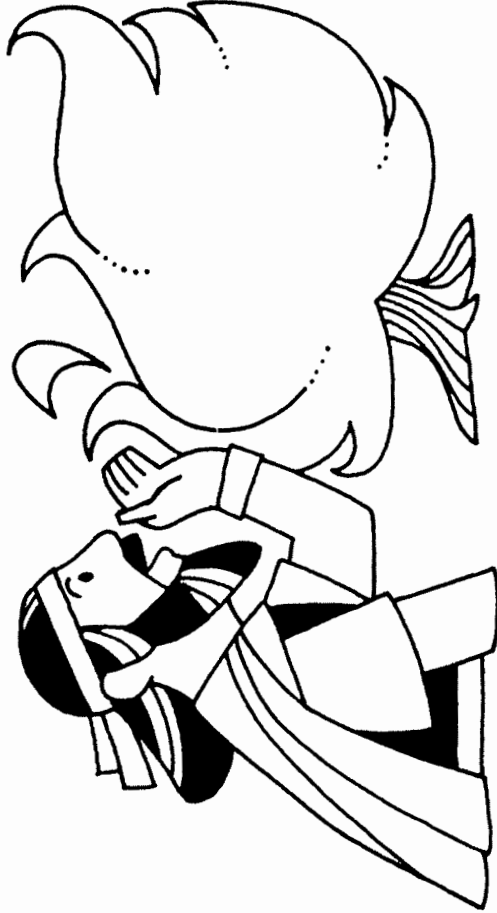

**The Burning Bush**

Exodus 3:1—4:17

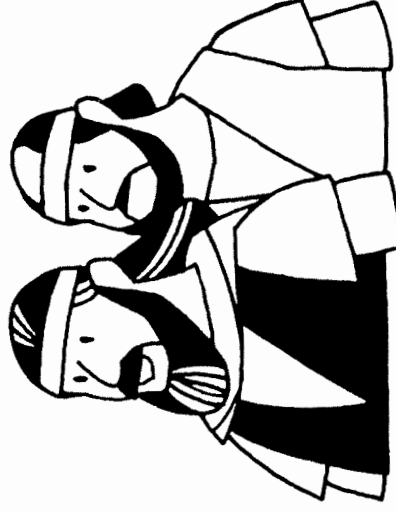

**Moses Confronts Pharaoh**

Exodus 5:1—6:1

1446 B.C.

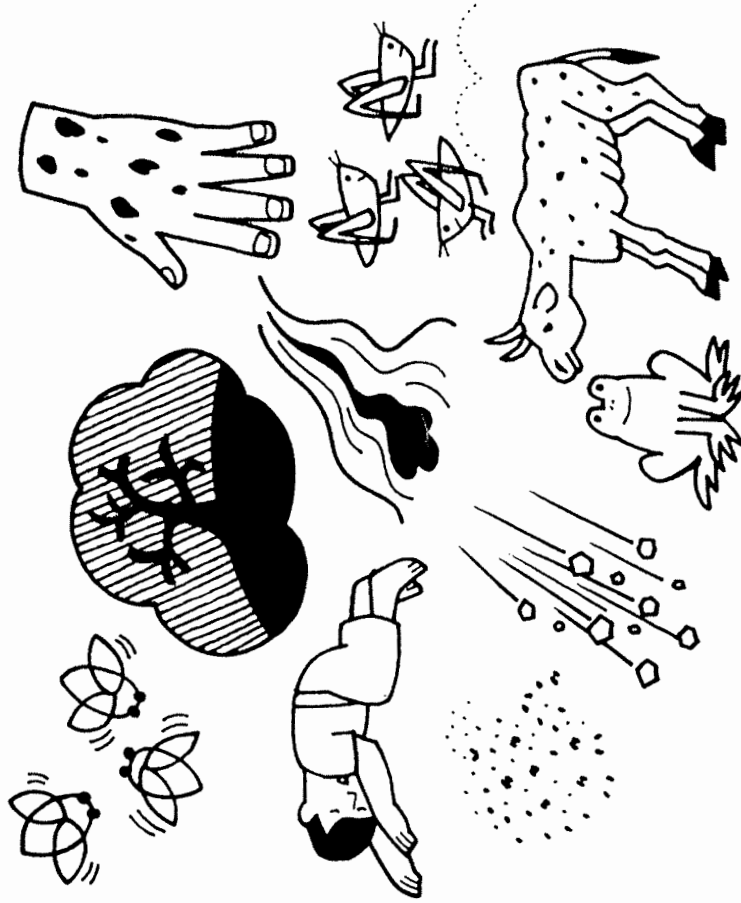

### The Plagues

Exodus 7:8 — 11:10

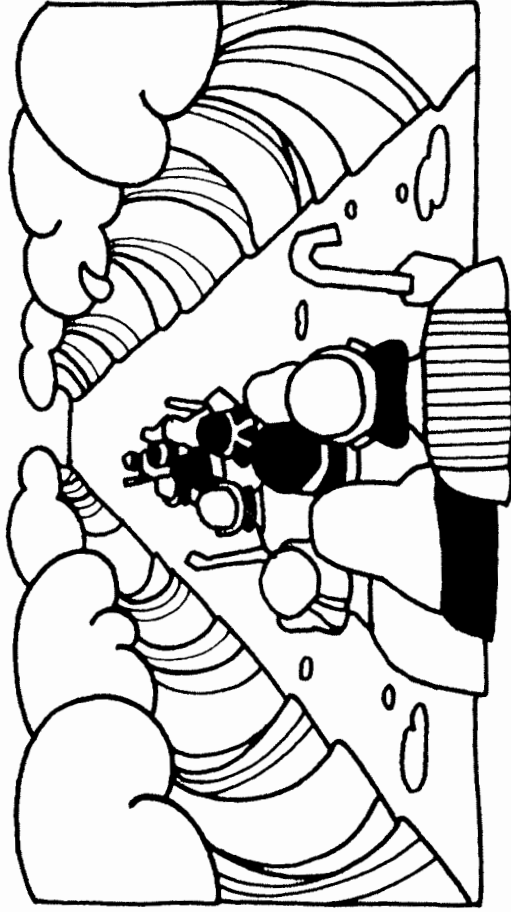

### The Red Sea Crossing

Exodus 13:17 — 14:31

**1446 B.C.**

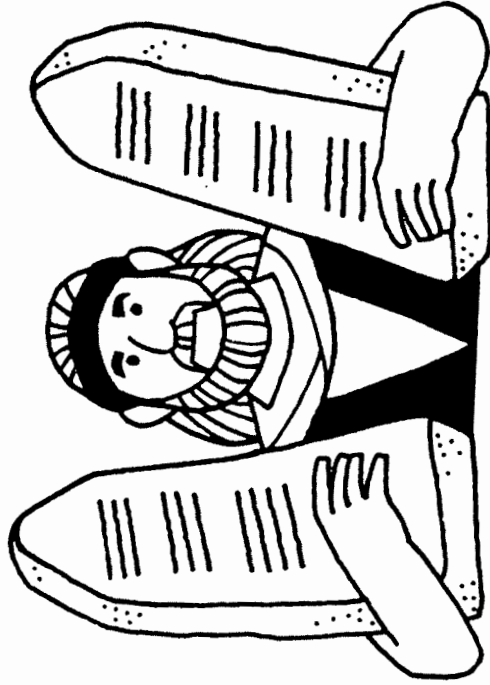

**The Ten Commandments**

Exodus 19:14—24:18;  
Deuteronomy 5:1-33



**Israel Disobeys God**

Exodus 32:1-35;  
Deuteronomy 9:7-29

**1445 B.C.**

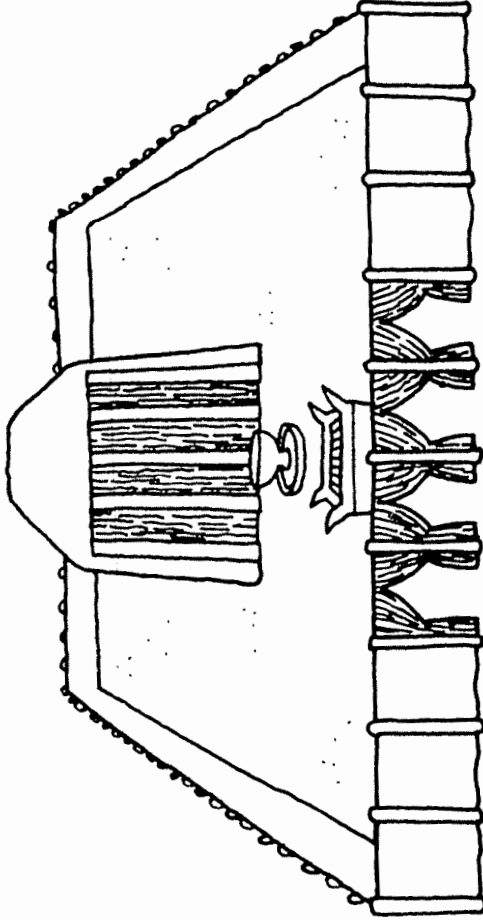

**The Tabernacle**

Exodus 36:8-38



**The Ark of the Covenant**

Exodus 37:1-9

**1444 B.C.**

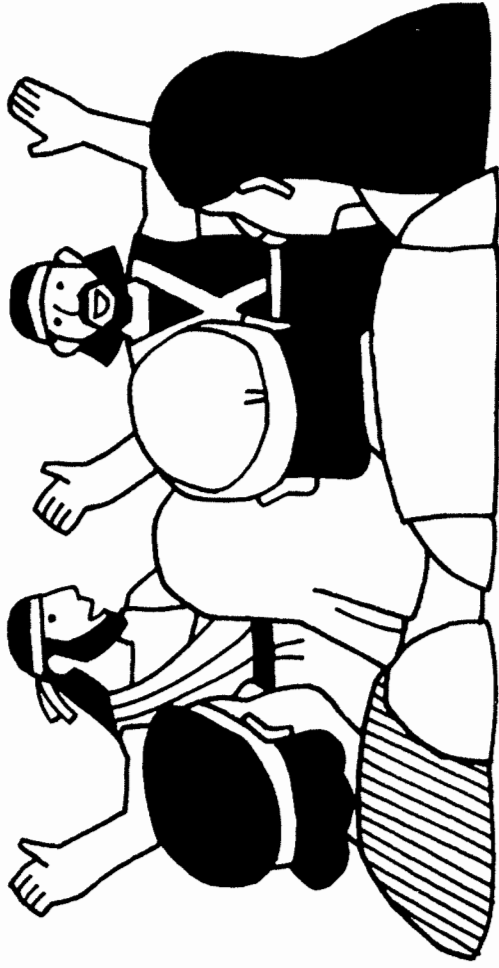

**Joshua and Caleb**

Numbers 13:1-14:45

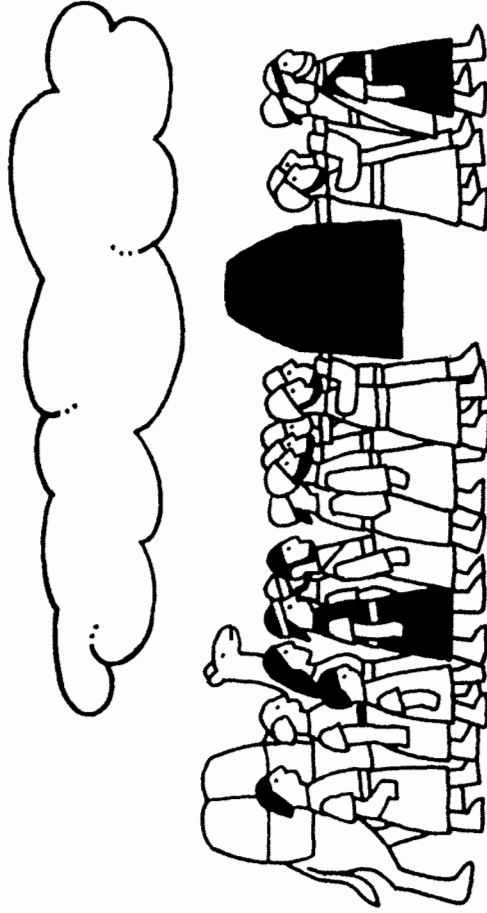

**God Leads the Israelites  
in the Desert**

Numbers 9:15-23

# Easy Trumpet Music Craft

Like 1 Send

This is an easy trumpet music craft you can make from some paper and a toilet paper roll. Looks great!

## Materials:

- toilet paper roll
- yellow or gold paper
- scissors
- glue
- 3 buttons

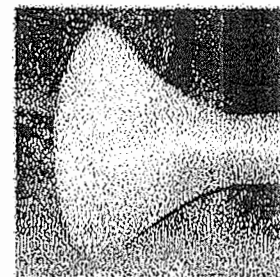
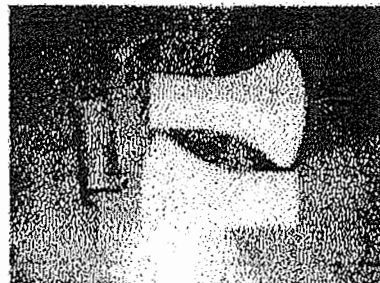

## Directions:

1. Trace and cut out 2 funnel shaped pieces from yellow or gold paper. The length should match the length of the toilet paper roll.
2. Glue the 2 pieces around the toilet paper roll and glue the ends together to form a 3D horn shape.
3. Glue on 3 buttons on the top.

Will you help these Sons of Aaron  
find the way to their trumpets?

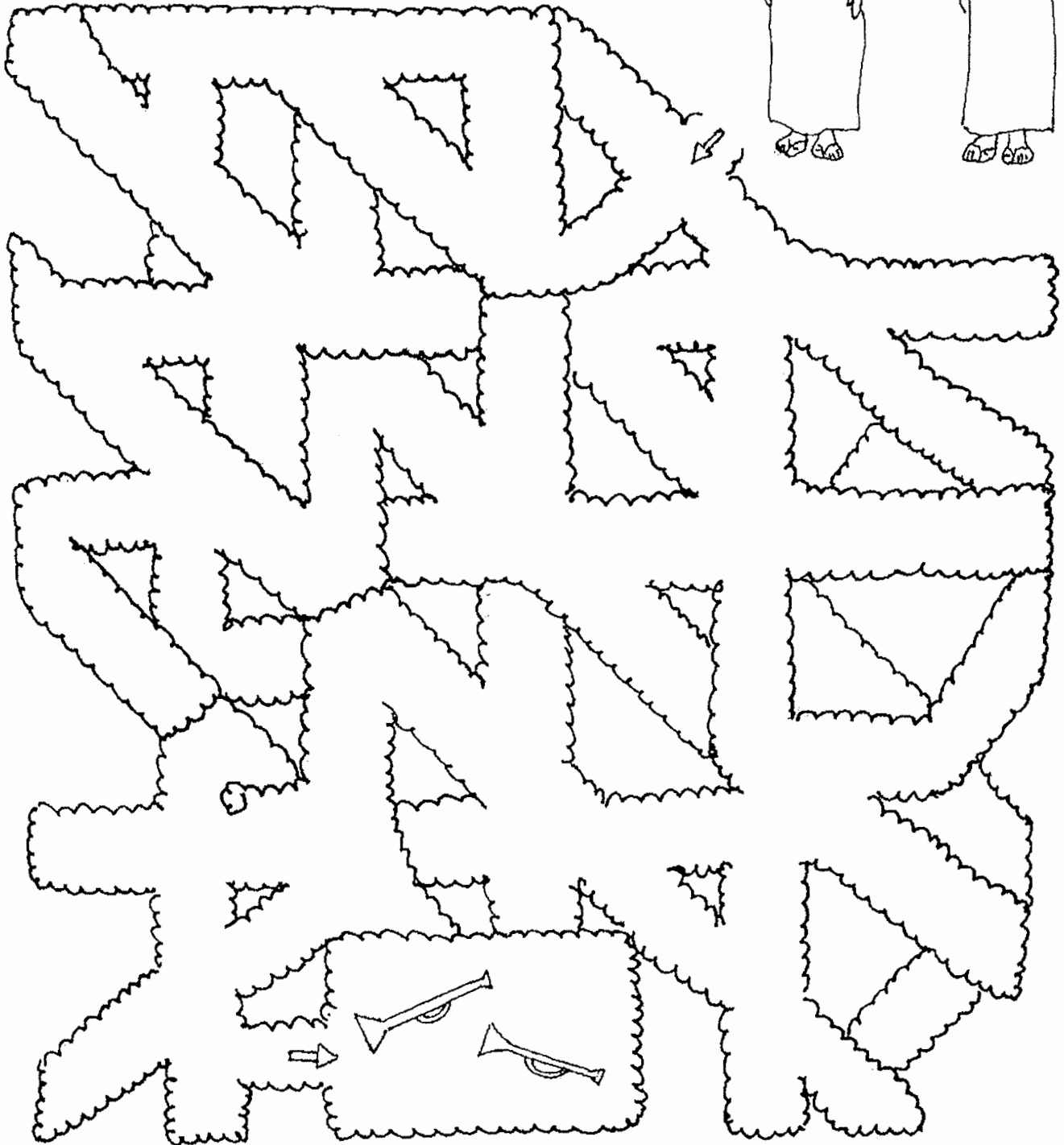
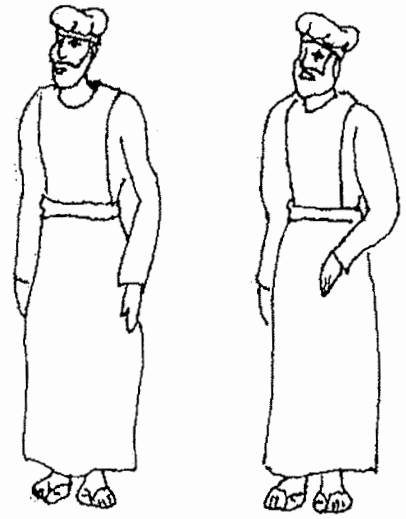

# 48. THE LORD SENDS QUAIL

(NUMBERS 11:4-14, 31-34)

M A N G E R V M V U  
A L O R D P T O H D  
N E U G A L P S T S  
N Y A H N L W E A J  
A O M E A T H S R L  
D E R E H T A G W I  
P S E K A C P Q M A  
Z J H Z J J J O F U  
G L U T T O N A S Q  
Y F A Y T C H W W H

ANGER  
CAKES  
EAT

GATHERED  
GLUTTON  
LORD

MANNA  
MEAT  
MOSES

PLAGUE  
QUAIL  
WRATH

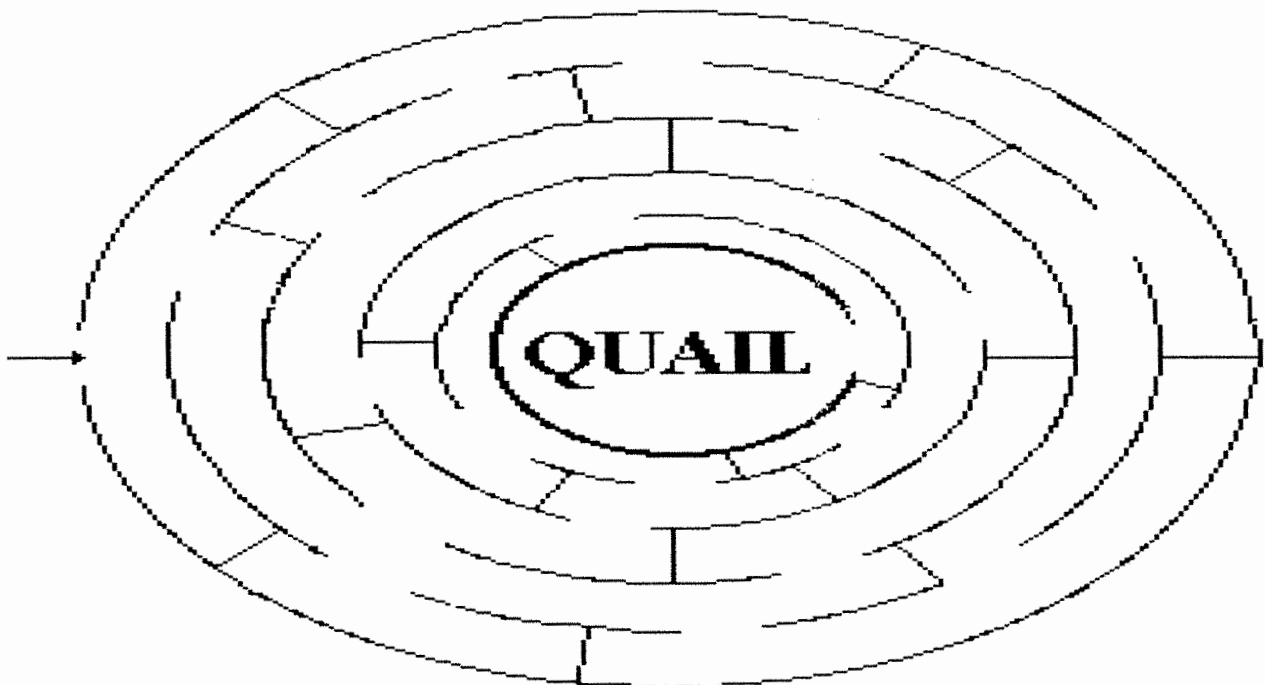



## Israelites Complain

O N B N W S T H L E X S W N Y  
 V F O R E M O H N I C C G Z I  
 W W U T C A M P T E A G I E E  
 N L G A T F B W Q U B U V Y N  
 E O L P L U O A D G K M Q Q N  
 D C C O K C L R F A K C E U A  
 J T C I U Z O G Y L E W T A E  
 F K E B N L Z H N P V R S L T  
 Y A I E O Y V E I N N A E V G  
 G T E H T D X C N B D T S J C  
 S O K S N H C L I M R H O H V  
 N F F L E S H L V E W R M K X  
 S L I R T S O N G K I Y O W Q  
 K E G V Y K J N L J N P O U S  
 N D I U O N A X B E D W M P T

ANGER  
 FLESH  
 GOD  
 MEAT  
 PLAGUE  
 TEETH  
 WRATH

CAMP  
 FLOCK  
 HOMER  
 MOSES  
 QUAIL  
 TWOCUBITS

EAT  
 GLUTTON  
 LORD  
 NOSTRILS  
 SEA  
 WIND

### Children of Israel Complain

Use the words in the list below to complete the sentence

1. Now a wind went out from the \_\_\_\_\_ and it brought \_\_\_\_\_ from the \_\_\_\_\_ and left them \_\_\_\_\_ near the \_\_\_\_\_ about a day's \_\_\_\_\_ on this side and about a day's journey on the other \_\_\_\_\_ all around the \_\_\_\_\_ and about \_\_\_\_\_ above the surface of the \_\_\_\_\_ And the \_\_\_\_\_ stayed up all that day, all night, and all the next \_\_\_\_\_ and \_\_\_\_\_ the quail (he who gathered least gathered \_\_\_\_\_ and they spread them out for \_\_\_\_\_ all \_\_\_\_\_ the \_\_\_\_\_

- two
- camp,
- day,
- themselves
- ten
- people
- quail
- fluttering
- journey
- sea
- gathered
- camp,
- Lord,
- ground
- side,
- camp.
- around
- homers);
- cubits

2. \_\_\_\_\_ And the people stayed up all that day, all night, and all the next day, and gathered the quail (he who gathered least gathered ten homers); and they spread them out for themselves all around the

Numbers 11:31-32  
NKJV

**KEY: Children of Israel Complain**

Use the words in the list below to complete the sentence

1. Now a wind went out from the Lord, and it brought quail from the sea and left them fluttering near the camp, about a day's journey on this side and about a day's journey on the other side, all around the camp, and about two cubits above the surface of the ground And the people stayed up all that day, all night, and all the next day, and gathered the quail (he who gathered least gathered ten homers); and they spread them out for themselves all around the camp.

two  
 camp,  
 day,  
 themselves  
 ten  
 people  
 quail  
 fluttering  
 journey  
 sea  
 gathered  
 camp,  
 Lord,  
 ground  
 side,  
 camp.  
 around  
 homers);  
 cubits

2. \_\_\_\_\_ And the people stayed up all that day, all night, and all the next day, and gathered the quail (he who gathered least gathered ten homers); and they spread them out for themselves all around the

Write the letter of the correct match next to each problem.

- |     |                                |                                                    |
|-----|--------------------------------|----------------------------------------------------|
| 1.  | Two Trumpets                   | a. In the Wilderness                               |
| 2.  | Blow One                       | b. Carry Holy Articles of God                      |
| 3.  | Blow Two                       | c. The Priest                                      |
| 4.  | Aaron                          | d. Leaders of Camp Gather                          |
| 5.  | Sound the Alarm                | e. Camp moves                                      |
|     |                                | f. All congregation Gathers at the Tent of Meeting |
| 6.  | Cloud Taken Up                 |                                                    |
| 7.  | Cloud Lowers                   | g. Blow the Trumpets                               |
| 8.  | Kohathites                     | h. Going to War                                    |
| 9.  | Sons of Aaron                  | i. Made of Silver                                  |
|     | Where the Children of Israel's | j. Camp Stops in Place                             |
| 10. | Journey                        |                                                    |

## Children of Israel and the Silver Trumpets Match Up

# KEY:

Write the letter of the correct match next to each problem.

- |     |                  |                                        |    |                                                 |
|-----|------------------|----------------------------------------|----|-------------------------------------------------|
| 1.  | <u>    i    </u> | Two Trumpets                           | a. | In the Wilderness                               |
| 2.  | <u>    d    </u> | Blow One                               | b. | Carry Holy Articles of God                      |
| 3.  | <u>    f    </u> | Blow Two                               | c. | The Priest                                      |
| 4.  | <u>    c    </u> | Aaron                                  | d. | Leaders of Camp Gather                          |
| 5.  | <u>    h    </u> | Sound the Alarm                        | e. | Camp moves                                      |
| 6.  | <u>    e    </u> | Cloud Taken Up                         | f. | All congregation Gathers at the Tent of Meeting |
| 7.  | <u>    j    </u> | Cloud Lowers                           | g. | Blow the Trumpets                               |
| 8.  | <u>    b    </u> | Kohathites                             | h. | Going to War                                    |
| 9.  | <u>    g    </u> | Sons of Aaron                          | i. | Made of Silver                                  |
| 10. | <u>    a    </u> | Where the Children of Israel's Journey | j. | Camp Stops in Place                             |

# 48. THE LORD SENDS QUAIL

(NUMBERS 11:4-14, 31-34)

I H F O K V C C R Z A C A N B M K Y H I  
D E K J S D A T A N F M Y K P J R K L S  
Y L T Q P D L C Z M A N N A P K E W O V  
E M G S G Z L I E K F J Q B Y G N L I U  
D G E P P A O J A O T K U C F H C W R U  
P M Y M R Z T W M U Q S Q D R E G N A A  
U B G B X O Z H D B Q M T P O G V W F D  
G P M B O W M Y E H H J H L J H C Z Y D  
I M Q O S H F J S R A T T A W T C O L W  
C W H H L Q M T W E E A T G S A H A D T  
E M V S K I Q N Q P K D R U S R R L F L  
U N E S W G S A G V J A R E I W E P B A  
P G V A V L L S I I U A C W A D M N E O  
M K G R T H Q U T A E U S K G V Q U H A  
K B S V J T V L T O T E E I W B N D T P  
U Y N N X Y P P T T T N S E A G Y L L A  
Y K B G W D B U A N O Q O P F C M U U D  
Y P K D R O Q T L H D N M I U Z A F W Y  
R L K O E A J N B I D X W Y T H S L Q S  
M Y L P L V I D Z U Q N P B O K V Y N M

ANGER  
CAKES  
EAT

GATHERED  
GLUTTON  
LORD

MANNA  
MEAT  
MOSES

PLAGUE  
QUAIL  
WRATH

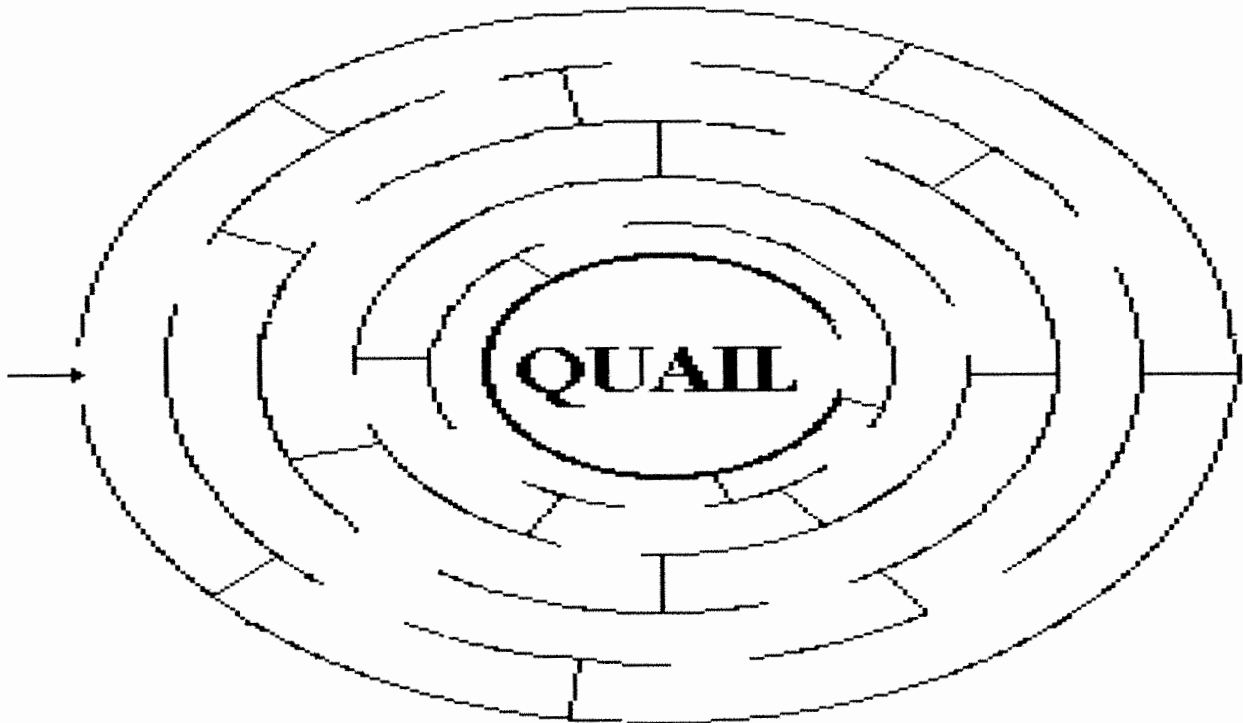

**Year 1**

**Week 44**

## **Miriam Becomes A Leper**

**Scriptures: Numbers 12**

**Key Verse: Numbers 12:10** **And when the cloud departed from above the tabernacle, suddenly Miriam became leprous, as white as snow. Then Aaron turned toward Miriam, and there she was, a leper.**

**Key Points:**

- 1.** Moses' brother, Aaron and his sister, Miriam spoke against Moses. They were jealous of Moses and the leadership position God gave him. The Lord heard it.
- 2.** Suddenly, God called Moses, Aaron, and Miriam to the tent of meeting. The Lord came down in a pillar of cloud and stood in the doorway where He called Aaron and Miriam to come forward.
- 3.** God told Miriam and Aaron that He spoke with them in visions and dreams, but that He spoke with Moses face-to-face. God asked them why they were not afraid to speak against Moses. God was angry and He departed.
- 4.** Suddenly, as the pillar of cloud rose above the tabernacle, Miriam was leprous.
- 5.** Aaron asked Moses to forgive them and to heal Miriam. Moses cries out to God. God requires Miriam to stay outside of the camp for 7 days until she is restored to good health. The Israelites wait for Miriam's healing before moving on.

# LEPROSY





# Fill in the Blanks



Miriam was a \_\_\_\_\_.

Aaron was a \_\_\_\_\_.



When Miriam and Aaron  
spoke against Moses,  
God came down in a pillar of the

\_\_\_\_\_.

The cloud departed from  
the \_\_\_\_\_.

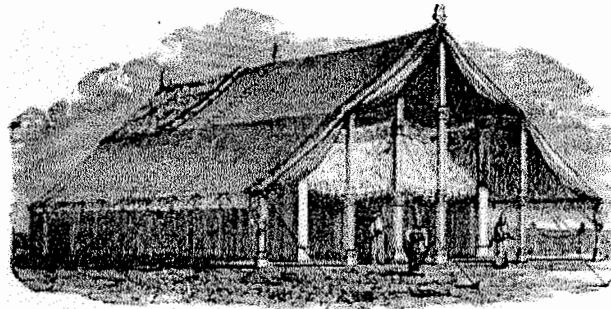

God punished  
Miriam with

\_\_\_\_\_.



Moses asked  
God to heal

\_\_\_\_\_.



For seven  
days,  
Miriam was  
put outside  
of the

\_\_\_\_\_.

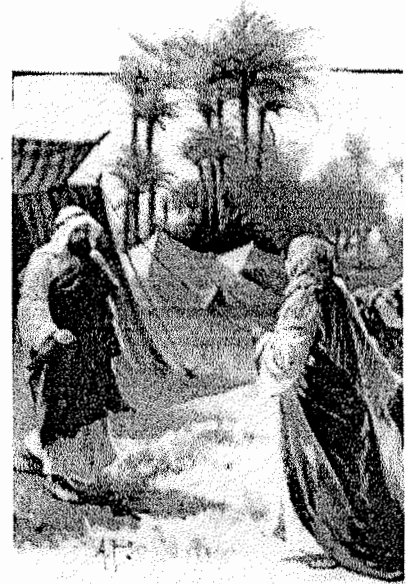

### Use These Words

Miriam

tabernacle

priest

leprosy

prophetess

cloud

camp

Miriam Becomes a Leper

I A X U T W R A P Q N F H U O  
C Y N K P N U O N T S T M V L  
F R D C T A K V F E O L V M J  
H N K G G I E F S R T E Y F M  
I V P H U P E O E P L O X G P  
V L I W J O M Z F C E D S N U  
I O L F T I A H A L P J U W N  
A F Q P R H N N V O R G V E H  
B F I I R T R U T U O V V N C  
T A A T U E N W P D U E J B S  
K M A L B Y U W C M S N O W K  
J K G A A R O N M W O B Q K C  
O T T A J F Y M H O T R A T O  
S J D U J P B Q E A V N M A O  
K W T I K U O L W S Q F F L L

AARON  
CLOUD  
ETHIOPIAN  
GOD  
HAZEROTH  
LEPROUS  
MEEK  
MIRIAM  
MOSES  
SEVEN  
SNOW  
TABERNACLE

# NUMBERS 12

C D L N R I S L M T Q Z F W G  
K L P V W D E W A Z W A A L A  
K D O O C P M B S S O T S C C  
M R C U E T E H P O R P A K M  
I E D R D R F N C X Y N H D A  
B A I R N R Q E E N G X N G I  
A M T A S E S O M V U J H O R  
U E C K M H J E Q T E G Z A I  
M L T T D Y G X G R J S X H M  
E E V M I A B S A A X V M S L  
X Q L J B E N L Z S J X A F B  
I S Q B P R L E D Q A Y R T S  
T O I T M I Q K R F Z M L F F  
Z G Z P P U X O D C V X G T F  
C T C W D X H C P V A A R O N

AARON  
HUMBLE  
MOSES  
SEVEN

CLOUD  
LEPER  
PILLAR  
TABERNACLE

DREAM  
MIRIAM  
PROPHET

**Year 1**

**Week 45**

## **The Twelve Spies**

**Scriptures: Numbers 13 and 14**

**Key Verse: Numbers 14:8 If the Lord delights in us, then He will bring us into this land and give it to us, a land which flows with milk and honey.**

### **Key Points:**

- 1.** God commands Moses to send 12 spies to spy out the promised land (Canaan). One man from each tribe is selected. They spend 40 days in Canaan.
- 2.** Joshua and Caleb bring back a good report of faithfulness while the other 10 spies bring back an evil report to Moses. The evil report stirred up the people and they became fearful. Caleb quieted them and encouraged the congregation to take possession of the land.
- 3.** The children feared and cried and complained against Moses and Aaron. They also accused God of delivering them to the promised land only to be destroyed. They desired someone to lead them back to Egypt. Joshua and Caleb encouraged the people not to rebel.
- 4.** God was angry enough to destroy the children of Israel who complained (even though they had seen the mighty deliverance from Egypt). Moses prayed to God to pardon them. God said that He would save everyone age 19 and under as well as Joshua and Caleb.
- 5.** The 10 spies who gave evil reports all died immediately from the plague God sent. The people decided to try to enter the promised land against God's Word and they were attacked by the Amalekites and Canaanite enemies.



Joshua and Caleb  
Numbers 13, 14

# THE TWELVE SPIES

(NUMBERS 13:1-14:9)

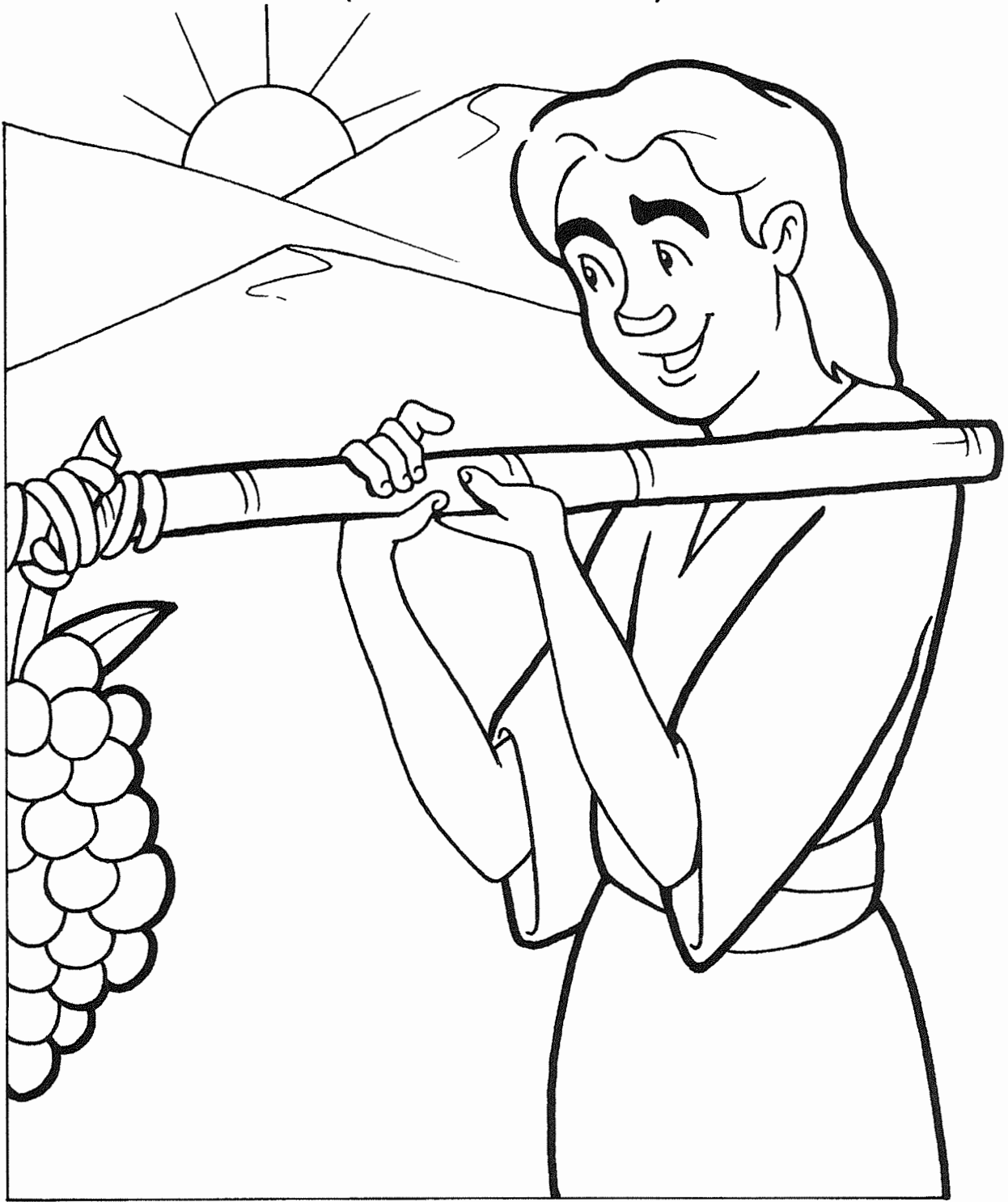

“And they came unto the brook of Eshcol, and cut down from thence a branch with one cluster of grapes, and they bare it between two upon a staff; and *they brought* of the pomegranates, and of the figs.”

**NUMBERS 13:23**

## Numbers 14:7-9

Fill in the blanks using the New King James Version of the Bible.

And they spoke to all the \_\_\_\_\_ of the children of \_\_\_\_\_, saying: "The \_\_\_\_\_ we passed through to \_\_\_\_\_ out *is* an exceedingly \_\_\_\_\_ land. If the \_\_\_\_\_ delights in us, then He will \_\_\_\_\_ us into this land and give it to us, 'a land which flows with \_\_\_\_\_ and \_\_\_\_\_.' Only do not \_\_\_\_\_ against the LORD, nor fear the \_\_\_\_\_ of the land, for they *are* our \_\_\_\_\_; their \_\_\_\_\_ has \_\_\_\_\_ from them, and the LORD *is* with us. Do not \_\_\_\_\_ them."

"Scripture taken from the New King James Version. Copyright © 1982 by Thomas Nelson,

Inc. Used by permission. All rights reserved."



# Who Said It?

When all the other Israelites were grumbling, two men said, "Don't turn against the Lord! Don't be afraid of the people in that land!" Who were those men? To find out, color the boxes containing the letters of the words in that row. The first one is done for you. The names of two brave men will appear in the uncolored boxes. Read from top to bottom.

DON'T  
TURN  
AGAINST  
THE  
LORD  
DON'T  
BE  
AFRAID

D	O	N	C	T			
T	U	J	R	A	N		
A	G	A	I	O	N	S	T
T	S	H	L	E			
L	O	H	R	E	D		
D	O	U	N	B	T		
A	E	B	E				
A	F	R	A	I	D		





# THE TWELVE SPIES

(NUMBERS 13:1-14:9)

D Y L J Y L A I O A T J A W P  
 D O M K S C D E L I G H T S I  
 Z L L G A T Z T B F D T Y P Y  
 Z I E N R P N A H F T I U R F  
 M A A B J A E A F T D A Q N B  
 O A Q I E U S L I Q Q A U K B  
 N V D C T R A S V G C U Q B P  
 W C S N A T M U H S U E T C P  
 H G Q C A L D B H O E N H D Y  
 Q A R T N L E Z I S P I T W F  
 I L V A L N W B O H O P P K O  
 L O P C P O Q Z N A J J E S J  
 H Z B J A E R N H U K Q T R W  
 H O N E Y D S D I U S M R I S  
 T M Q W S R M K U T M N R E S

CALEB  
 CANAAN  
 DELIGHTS  
 FRUIT

GIANTS  
 GRAPES  
 GRASSHOPPERS  
 HONEY

JOSHUA  
 LAND  
 LORD

MILK  
 REBEL  
 SPIES



# The Twelve Spies

B P Y P S C C A L E B B  
E K N P D E M D J J V S  
H U A U I E J O S H U A  
S R E P P O H S S A R G  
N C J I A H M S T W T O  
A O I B Z E B Y I A W O  
A T L T V S T R O N G D  
N E I L I R T J W D U P  
A K E U O E P N J E G P  
C W O F R R S N A R A Z  
T D I A R F A F H I B K  
W D T R E S E D P U G K

ABLE  
CANAAN  
FORTY  
GOOD  
PUNISHED  
TWELVE

AFRAID  
CITIES  
FRUIT  
GRASSHOPPERS  
SPY  
WANDER

CALEB  
DESERT  
GIANTS  
JOSHUA  
STRONG  
WEAK

# THE TWELVE SPIES

## (NUMBERS 13:1-14:9)

### MEMORY VERSE:

*"If the LORD delights in us, then He will bring us into this land and give it to us, 'a land which flows with milk and honey.'" NUMBERS 14:8*

"And the LORD spoke to Moses saying..."

### FILL IN THE BLANKS:

1. "Send men to spy out the land of Canaan, which \_\_\_ \_\_\_ \_\_\_\_\_ to the children of Israel; from each tribe of their fathers you shall send a \_\_\_\_\_ man, every one a leader among them." **NUMBERS 13:2**

### TRUE OR FALSE:

2. But Moses would not send them even though the LORD had commanded. **NUMBERS 13:3**  
**TRUE OR FALSE**
3. "So they went up and spied out the land from the Wilderness of Zin as far as Rehob, near the entrance of Hamath." **NUMBERS 13:21**  
**TRUE OR FALSE**

### CIRCLE THE CORRECT WORDS:

4. "Then they came to the Valley of Eshcol, and there cut down a branch with one cluster of (**GRAPES, PEAS**); they carried it between the two of them on a pole. They also brought some of the pomegranates and figs." **NUMBERS 13:23**
5. "And they returned from spying out the land after (**FOUR, FORTY**) days." **NUMBERS 13:25**
6. Joshua and Caleb told Moses, "We went to the land where you sent us. It truly flows with milk and honey, and this is its (**FRUIT, VEGETABLES**). Nevertheless the people who dwell in the land are (**STRONG, WEAK**); the cities are fortified and very (**SMALL, LARGE**)." **NUMBERS 13:27-28**

### TRUE OR FALSE:

7. "But the men who had gone up with him said, 'We are not able to go up against the people, for they are stronger than we.'" **NUMBERS 13:31**  
**TRUE OR FALSE**

### FILL IN THE BLANKS:

8. Joshua and Caleb said to the people, "Do not \_\_\_\_\_ against the LORD, nor \_\_\_\_\_ the people of the land, for they are our bread; their protection has departed from them, and the LORD is with us. Do not fear them." **NUMBERS 14:9**

# THE TWELVE SPIES

## (NUMBERS 13:1-14:9)

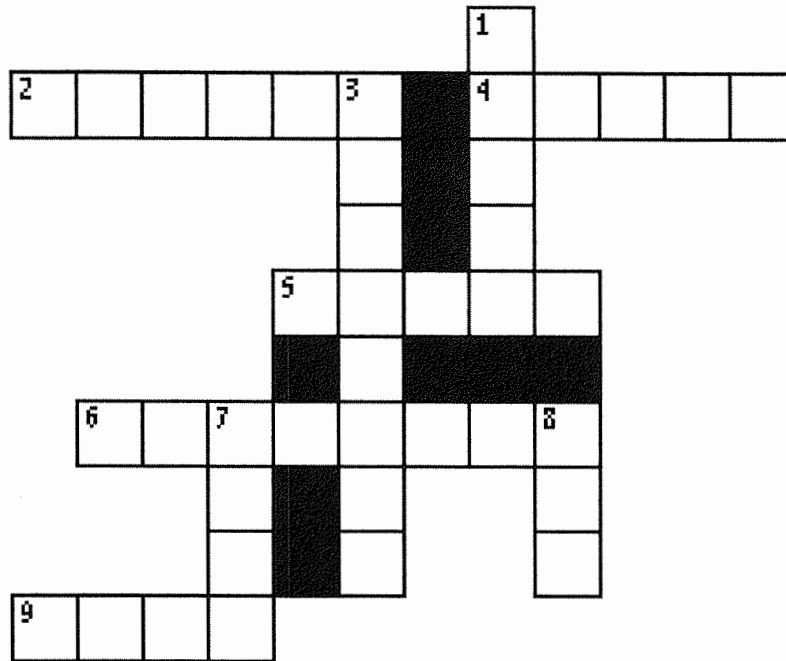

- 6 ACROSS "If the LORD \_\_\_\_\_ in us, then He will bring us into this land and give it to us, 'a land which flows with milk and honey.'" **NUMBERS 14:8**
- 8 DOWN "Send men to \_\_\_\_\_ out the land of Canaan, which I am giving to the children of Israel; from each tribe of their fathers you shall send a man, every one a leader among them." **NUMBERS 13:2**
- 7 DOWN "So Moses sent them up from the Wilderness of Paran according to the command of the \_\_\_\_\_." **NUMBERS 13:3**
- 9 ACROSS "So they went up and spied out the \_\_\_\_\_ from the Wilderness of Zin as far as Rehob, near the entrance of Hamath." **NUMBERS 13:21**
- 2 ACROSS "Then they came to the Valley of Eshcol, and there cut down a branch with one cluster of \_\_\_\_\_ they carried it between the two of them on a pole. They also brought some of the pomegranates and figs." **NUMBERS 13:23**
- 5 ACROSS "And they returned from spying out the land after \_\_\_\_\_ days." **NUMBERS 13:25**
- 1 DOWN Joshua and Caleb told Moses, "We went to the land where you sent us. It truly flows with milk and honey, and this is its \_\_\_\_\_. Nevertheless the people who dwell in the land are strong; the cities are fortified and very large." **NUMBERS 13:27-28**
- 3 DOWN "But the men who had gone up with him said, 'We are not able to go up against the people, for they are \_\_\_\_\_ than we.'" **NUMBERS 13:31**
- 4 ACROSS Joshua and Caleb said to the people, "Do not \_\_\_\_\_ against the LORD, nor fear the people of the land, for they are our bread; their protection has departed from them, and the LORD is with us. Do not fear them." **NUMBERS 14:9**

# THE TWELVE SPIES

## (NUMBERS 13:1-14:9)

### MEMORY VERSE:

*"If the LORD delights in us, then He will bring us into this land and give it to us, 'a land which flows with milk and honey.'" NUMBERS 14:8*

*"And the LORD spoke to Moses saying..."*

### FILL IN THE BLANKS:

1. "Send men to spy out the land of Canaan, which \_\_\_\_\_ to the children of Israel; from each tribe of their fathers you shall send a man, every one a leader among them." **NUMBERS 13:2**

### TRUE OR FALSE:

2. But Moses would not send them even though the LORD had commanded. **NUMBERS 13:3**  
**TRUE OR FALSE**
3. "So they went up and spied out the land from the Wilderness of Zin as far as Rehob, near the entrance of Hamath." **NUMBERS 13:21**  
**TRUE OR FALSE**

### FILL IN THE BLANKS:

4. "Then they came to the Valley of Eshcol, and there cut down a branch with one cluster of \_\_\_\_\_; they carried it between the two of them on a pole. They also brought some of the pomegranates and figs." **NUMBERS 13:23**
5. "And they returned from spying out the land after \_\_\_\_\_ days." **NUMBERS 13:25**
6. Joshua and Caleb told Moses, "We went to the land where you sent us. It truly flows with milk and honey, and this is its \_\_\_\_\_. Nevertheless the people who dwell in the land are \_\_\_\_\_; the cities are fortified and very \_\_\_\_\_." **NUMBERS 13:27-28**

### TRUE OR FALSE:

7. "But the men who had gone up with him said, 'We are not able to go up against the people, for they are stronger than we.'" **NUMBERS 13:31**  
**TRUE OR FALSE**

### FILL IN THE BLANKS:

8. Joshua and Caleb said to the people, "Do not \_\_\_\_\_ against the LORD, nor \_\_\_\_\_ the people of the land, for they are our bread; their protection has departed from them, and the LORD is with us. Do not fear them." **NUMBERS 14:9**

## The Twelve Spies

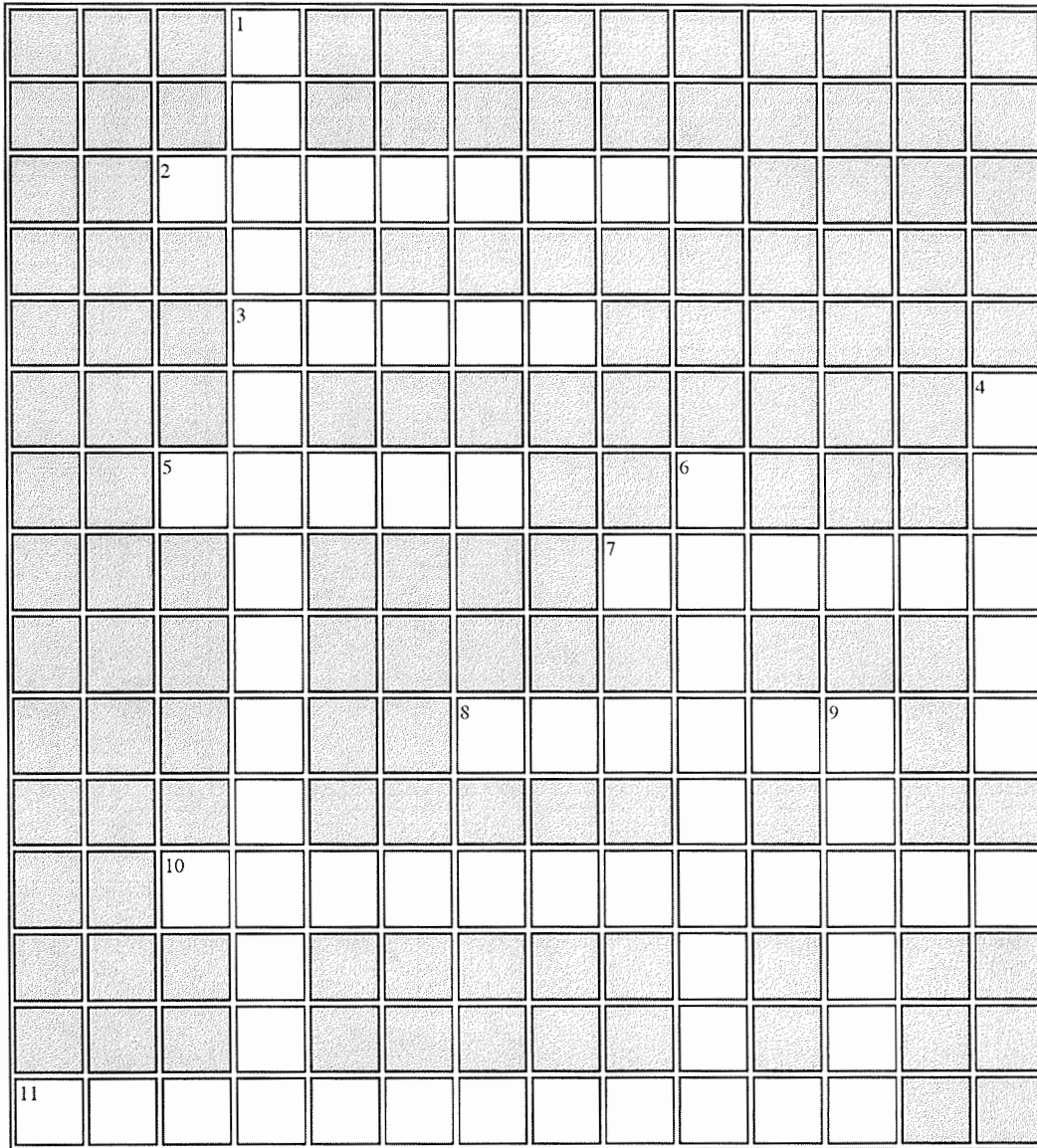

### Across

2. The unbelievers were \_\_\_\_.
3. There was one man from each \_\_\_\_.
5. The men were to bring back some of the \_\_\_\_ of the land.
7. The people had to \_\_\_\_ in the desert for 40 years.
8. Moses wanted to know if the people were \_\_\_\_.
10. where the spies were sent
11. The men felt like \_\_\_\_ in their own sight.

### Down

1. The men carried a \_\_\_\_ on a pole.
4. the number of days the men were gone
6. Caleb and Joshua gave a \_\_\_\_ report.
9. The men described the people of the land as \_\_\_\_.

WORD BANK: LAND OF CANAAN, TRIBE, FRUIT, STRONG, FORTY,  
CLUSTER OF GRAPES, GRASSHOPPERS, GIANTS, FAVORABLE, WANDER, PUNISHED



**Year 1**

**Week 46**

## **Korah's Rebellion**

**Scriptures: Numbers 16**

**Key Verse: Numbers 16:5** And he spoke to Korah and all his company, saying, "Tomorrow morning the Lord will show who is His and who is holy, and will cause him to come near to Him. That one whom He chooses He will cause to come near to Him.

### **Key Points:**

1. Korah and 250 other Levites gathered against Moses and Aaron and Aaron's sons (the priests). They were jealous of them. (All priests had to be Levites and from the lineage of Aaron, thus all priests were Levites, but not all Levites were priests).
2. Moses rebuked them because they were not appreciative of their special role as Levites who served at the tabernacle.
3. Moses told Korah and each of the 250 Levite rebels to bring their censers with fire and incense before the Lord the next morning. Dathan and Abiram refused to come.
4. The next morning, Korah and the rebels assembled with their censers at the door of the tabernacle against Moses and Aaron. God's glory appeared there to all the congregation. The earth split and swallowed alive Korah, Dathan, and Abiram (and their families). Fire came out from God and killed the 250 rebels with censers.
5. The next day, the children of Israel still grumbled against Moses and Aaron so God killed 14,700 by a plague. Aaron stood between the dead and the living with his censer of incense to atone for them and thus stopped the plague.

## Korah's Rebellion

G I B N A H T A D A A G T L T  
F Q B M O S E S E B Q B A E V  
K W F C A G D R W T R C H V O  
L V Q D L R B W O Y A O I I O  
M I X Q O C I X L S E K H T T  
Y T H A R O K B L U S Z Q E X  
E W H G B M H C A O N A L S I  
G E O N R P H T W L E L E F Q  
D D Y I Z L G P S A C Y U K U  
R G M R W A E R C E N R G X V  
N Y N E R I F A O J I N A B T  
K O E V F N X S D U O R L V X  
B A F O R E H U Q E N J P D A  
V B O C J D L Z G H R D V L O  
N W O J M C E N S E R S X R Y

ABIRAM  
CENSERS  
COMPLAINED  
COVERING  
DATHAN  
FIRE  
GOD  
GROUND  
INCENSE  
JEALOUSY  
KORAH  
LEADERS  
LEVITES  
MOSES  
PLAGUE  
PRIESTHOOD  
SWALLOWED

**Year 1**

**Week 47**

## **Aaron's Rod Buds/ Moses Strikes The Rock**

**Scriptures: Numbers 17 and Numbers 20**

**Key Verses: Numbers 17:5 “And it shall be that the rod of the man whom I choose will blossom; thus I will rid Myself of the complaints of the children of Israel which they make against you.”**

**Numbers 20:10 “And Moses and Aaron gathered the assembly together before the rock and he said to them, “Hear now, you rebels! Must we bring water for you out of this rock?”**

### **Key Points:**

- 1.** God told Moses to have a leader from each of the 12 tribes bring him a rod. Moses was to write each man's name on their rod. The next day, Aaron's rod budded, bloomed, and bore almonds in the tabernacle. Moses showed the rods to all of the people.
- 2.** God instructed Moses to place Aaron's rod back in the tabernacle as a sign to the rebels not to complain!
- 3.** As the Israelites traveled, there was no water in the wilderness so they gathered together against Moses and Aaron to grumble, complain, and accuse. Moses and Aaron fell on their faces in the doorway of the tent of meeting. God spoke to Moses, telling him to gather the children of Israel together, take his staff and speak to a rock that was before them and it would bring forth water. However, Moses struck the rock with his staff, in frustration and anger, telling them they were rebels. Water did come forth, but God was not pleased with his actions of disobedience and irreverence. He was instructed to speak to the rock, not strike it.
- 4.** Because God did not believe Moses to reverence Him while speaking in the presence of the children of Israel, neither he nor Aaron were allowed to enter the promised land. The place was called “Meribah” or contention.

# WATER FROM THE ROCK

## (EXODUS 17:1-6)

### MEMORY VERSE:

*"Tremble, O earth, at the presence of the LORD, at the presence of the God of Jacob, who turned the rock into a pool of water." PSALM 114:7-8*

Now "all the congregation of the children of Israel set out on their journey from the Wilderness of Sin, according to the commandment of the LORD, and camped in Rephidim..." EXODUS 17:1

### TRUE OR FALSE:

1. There was plenty of water for the people to drink. EXODUS 17:1  
TRUE OR FALSE

### CIRCLE THE CORRECT WORDS:

2. "Therefore the people contended with Moses, and said, 'Give us (WATER, SODA), that we may drink.' " EXODUS 17:2
3. "And Moses said to them, 'Why do you contend with me? Why do you (FEAR, TEMPT) the LORD?' " EXODUS 17:2

### TRUE OR FALSE:

4. "And the people thirsted there for water, and the people murmured against Moses." EXODUS 17:3  
TRUE OR FALSE
5. So Moses cried out to the LORD, saying, "What shall I do with this people? They are almost ready to make me a king!" EXODUS 17:4  
TRUE OR FALSE
6. "And the LORD said to Moses, 'Go on before the people, and take with you some of the elders of Israel. Also take in your hand your rod with which you struck the river, and go.' " EXODUS 17:5  
TRUE OR FALSE

### FILL IN THE BLANK:

7. And the LORD said to Moses, "Behold, I will stand before you there on the rock in Horeb; and you shall \_\_\_\_\_ the rock, and water will come out of it, that the people may drink." EXODUS 17:6

### TRUE OR FALSE:

8. "And Moses did so in the sight of the elders of Israel." EXODUS 17:6  
TRUE OR FALSE

# WATER FROM THE ROCK

## (EXODUS 17:1-6)

### MEMORY VERSE:

*"Tremble, O earth, at the presence of the LORD, at the presence of the God of Jacob, who turned the rock into a pool of water." PSALM 114:7-8*

*Now "all the congregation of the children of Israel set out on their journey from the Wilderness of Sin, according to the commandment of the LORD, and camped in Rephidim..." EXODUS 17:1*

### TRUE OR FALSE:

1. There was plenty of water for the people to drink. **EXODUS 17:1**  
**TRUE OR FALSE**

### FILL IN THE BLANKS:

2. "Therefore the people contended with Moses, and said, 'Give us \_\_\_\_\_, that we may drink.' " **EXODUS 17:2**
3. "And Moses said to them, 'Why do you contend with me? Why do you \_\_\_\_\_ the LORD?' " **EXODUS 17:2**

### TRUE OR FALSE:

4. "And the people thirsted there for water, and the people murmured against Moses." **EXODUS 17:3**  
**TRUE OR FALSE**
5. So Moses cried out to the LORD, saying, "What shall I do with this people? They are almost ready to make me a king!" **EXODUS 17:4**  
**TRUE OR FALSE**

### FILL IN THE BLANKS:

6. "And the LORD said to Moses, 'Go on before the people, and take with you some of the elders of Israel. Also take in your hand your \_\_\_\_\_ with which you struck the river, and go.' " **EXODUS 17:5**
7. And the LORD said to Moses, "Behold, I will stand before you there on the rock in Horeb; and you shall \_\_\_\_\_ the rock, and water will come out of it, that the people may drink." **EXODUS 17:6**

### TRUE OR FALSE:

8. "And Moses did so in the sight of the elders of Israel." **EXODUS 17:6**  
**TRUE OR FALSE**

# WATER FROM THE ROCK

## (EXODUS 17:1-6)

C K N I R D L F I L T V X I E  
 U W R Q S E D H H S B Q P W F  
 Q P J I S O R N O R T Z E Z J  
 D P S K I O E G R N E O S K T  
 M W T P M E T X E V I T N K E  
 C O T T D C L G B Q A U A E J  
 L Q S O L F W M V T M A G W Z  
 O T R E S K J R U A X N D Q Z  
 R D E T S R I H T R T M E J K  
 D A A D J B N Q V Q M G P B C  
 N U Z Y F Y S I B F Y U Z B T  
 W U S H F N Z P Q H K F R R I  
 S T R I K E K H Y C L H C E O  
 T H D U O M B Z O P I A C B D  
 I E J Q P H Z R E J O W Q K T

DRINK  
 HOREB  
 LORD  
 MOSES

MURMURED  
 ROD  
 ROCK  
 STONE

STRIKE  
 TEMPT  
 THIRSTED  
 WATER

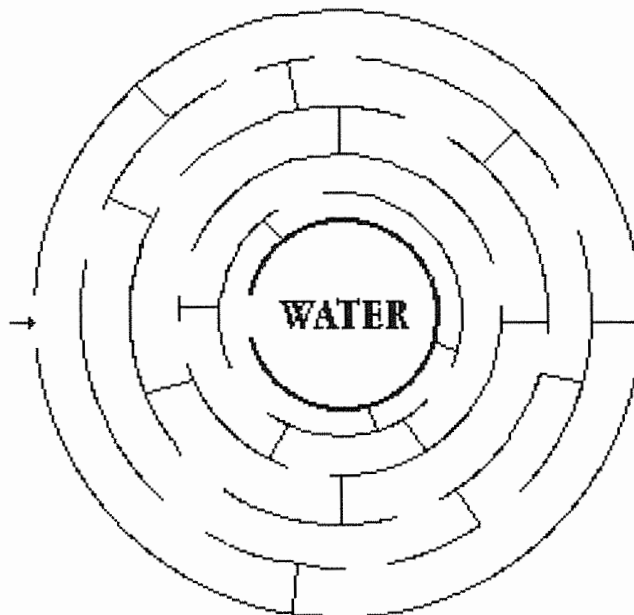

***"Tremble, O earth, at the presence of the LORD, at the presence of the God of Jacob, who turned the rock into a pool of water."***

**PSALM 114:7-8**

# WATER FROM THE ROCK

## (EXODUS 17:1-6)

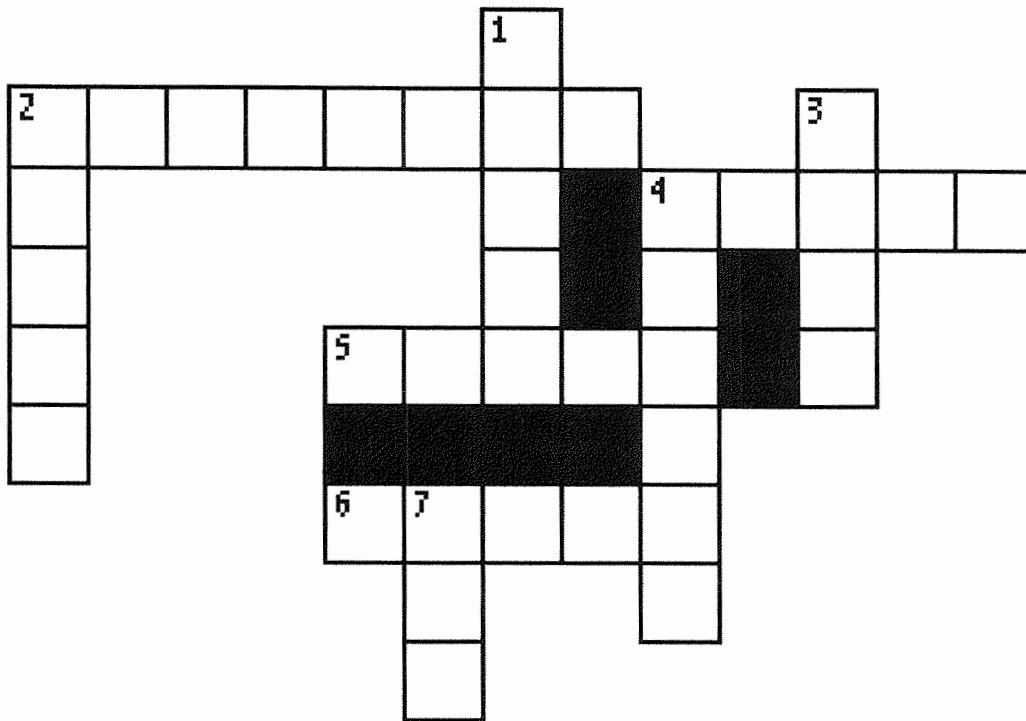

- 3 DOWN "Tremble, O earth, at the presence of the LORD, at the presence of the God of Jacob, who turned the \_\_\_\_\_ into a pool of water." **PSALM 114:7-8**
- 6 ACROSS "There was no water for the people to \_\_\_\_\_." **EXODUS 17:1**
- 5 ACROSS "Therefore the people contended with Moses, and said, 'Give us \_\_\_\_\_, that we may drink.' " **EXODUS 17:2**
- 1 DOWN "And Moses said to them, 'Why do you contend with me? Why do you \_\_\_\_\_ the LORD?' " **EXODUS 17:2**
- 2 ACROSS "And the people thirsted there for water, and the people \_\_\_\_\_ against Moses." **EXODUS 17:3**
- 4 ACROSS "So Moses cried out to the LORD, saying, 'What shall I do with this people? They are almost ready to \_\_\_\_\_ me!" **EXODUS 17:4**
- 7 DOWN "And the LORD said to Moses, 'Go on before the people, and take with you some of the elders of Israel. Also take in your hand your \_\_\_\_\_ with which you struck the river, and go.'" **EXODUS 17:5**
- 4 DOWN "And the LORD said to Moses, "Behold, I will stand before you there on the rock in Horeb; and you shall \_\_\_\_\_ the rock, and water will come out of it, that the people may drink." **EXODUS 17:6**
- 2 DOWN "And \_\_\_\_\_ did so in the sight of the elders of Israel." **EXODUS 17:6**

# WATER FROM THE ROCK

## (EXODUS 17:1-6)

U B Y M X W F J W V U A T K J G C W R U  
 G P G B O H M T Q I T A T I W D V W F A  
 I M M D S Q K N X T E M P T S V C Z Y D  
 C W O B T I Q N I O T U R E S B C O X D  
 E R Q O L H S A I N D E R P I G H A D W  
 U N H H K L I S T R D N W I R E T A W T  
 X G V S W H Q R A H D Q P E A C R K F L  
 M K V S V T V L S I Q X N L G E E U B A  
 K B G R J Y P P L T C N K D B K M N E O  
 U Y S V X O B U B U E A B E W I Q U H A  
 Y S N N W A Q T Z A U D R R A R N D T P  
 Y K T G E M J N Z F J O C S F T Y L L A  
 R P B O L V U D N F H Y D Y U S M U U D  
 F M K D N C I R K C O R S B T Z A F W Y  
 H Y K P V E C R M T K Q E B O H S L Q S  
 E F O K D A T A K U S U S P M K V Y N M  
 L K J S D L C Z O Q R Q O P J K Y H I U  
 M T Q P Z O J E B H M E M Y K R K L S B  
 G G S P Z Z W M H A J T D F G E W O V S  
 M E P R O M Y D F U T H W O H N L I U E

**DRINK**  
**ELDERS**  
**HOREB**  
**MOSES**

**MURMURED**  
**ROCK**  
**ROD**  
**STONE**

**STRIKE**  
**TEMPT**  
**THIRSTED**  
**WATER**

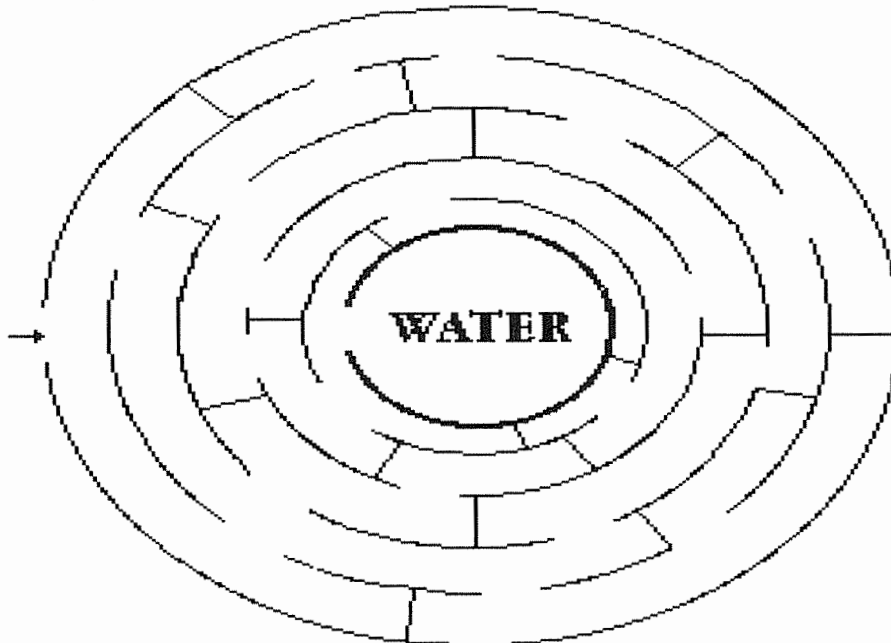

***"Tremble, O earth, at the presence of the LORD, at the presence of the God of Jacob, who turned the rock into a pool of water."***  
**PSALM 114:7-8**



**Year 1**

**Week 48**

## **Poisonous Snakes**

**Scriptures: Numbers 21**

**Key Verse: Numbers 21:8 Then the Lord said to Moses, “Make a fiery serpent, and set it on a pole and it shall be that everyone who is bitten, when he looks at it, shall live.”**

### **Key Points:**

- 1.** The children of Israel were very discouraged and unappreciative in their attitude. They accused Moses and said they did not have food or water. They also said they hated the manna that God was providing for their food (angels' food).
- 2.** God sent poisonous serpents into the camp and they bit many of them and they died.
- 3.** The people admitted that they had sinned against Moses and God. They repented and asked Moses to pray to God for the snakes' removal from the camp.
- 4.** God instructed Moses what to do to remedy the snake bites. God told Moses to make a fiery serpent and set it on a pole. He crafted one out of bronze and lifted it up on a pole. Everyone who was bitten by a poisonous snake and looked on the bronze serpent was saved!

# Who Am I?

Draw a line from the question to the name in the box that answers it.

Moses	Aaron	Israelite
Jesus	fiery serpent	Eleazar

1. I died on Mount Hor. Who am I?
2. I am the son of Aaron and I became high priest. Who am I?
3. The Israelites spoke against God and me. Who am I?
4. God sent me to punish the Israelites. Who am I?
5. I am one of many who looked at the brass serpent and lived. Who am I?
6. I am the one that you must look to today, if you want to be saved. Who am I?

**Memory Verse** Numbers 21:7a  
Therefore the people came to Moses, and said,  
We have \_\_\_\_\_, for we have spoken  
against the \_\_\_\_\_, and against  
\_\_\_\_\_.

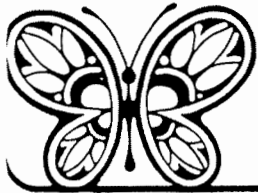

## The Israelites Are Saved

Numbers 20:22 - 21:9



The Israelites disobeyed God many times. One of the times they had displeased God. He told them they would have to wander in the wilderness for forty years.

While they were wandering, the Israelites came to Mount Hor. It was on this mountain that God chose a new high priest, Eleazar, to serve Him. It was also here that Aaron died. Aaron had served God for many years, but he died before he could go into the land of Canaan, because he had disobeyed God.

After the Israelites left Mount Hor, they began to talk against God and Moses. God punished them for speaking against Him and for not being thankful for all He had done for them. He sent fiery serpents to bite them and many Israelites died.

Finally, when the Israelites knew they had done wrong and were sorry, God told Moses to make a serpent out of brass and put it on a pole. All who looked at the brass serpent were saved.



Fill in the blanks.

1. When we disobey God, it is called a \_\_\_\_\_.
2. To be saved, we must look to \_\_\_\_\_.

# THE BRONZE SERPENT

## (NUMBERS 21:4-9)

### MEMORY VERSE:

*"And as Moses lifted up the serpent in the wilderness, even so must the Son of Man be lifted up."* JOHN 3:14

### CIRCLE THE CORRECT WORD:

1. The children of Israel "journeyed from Mount Hor by the Way of the Red Sea, to go around the land of Edom; and the soul of the people became very (**DISCOURAGED, ENCOURAGED**) on the way." **NUMBERS 21:4**

### FILL IN THE BLANKS:

2. "And the people spoke against \_\_\_\_\_ and against \_\_\_\_\_: 'Why have you brought us up out of Egypt to die in the wilderness? For there is no \_\_\_\_\_ and no \_\_\_\_\_, and our soul loathes this worthless \_\_\_\_\_.'" **NUMBERS 21:5**

### CIRCLE THE CORRECT WORD:

3. "So the LORD sent fiery (**RATS, SERPENTS**) among the people, and they bit the people; and many of the people of Israel died." **NUMBERS 21:6**

### TRUE OR FALSE:

4. "Therefore the people came to Moses, and said, 'We have sinned, for we have spoken against the LORD and against you; pray to the LORD that He take away the serpents from us.'" **NUMBERS 21:7**

TRUE OR FALSE

5. But Moses would not pray to the LORD for the people. **NUMBERS 21:7**

TRUE OR FALSE

### CIRCLE THE CORRECT WORDS:

6. "Then the LORD said to Moses, 'Make a fiery serpent, and set it on a pole; and it shall be that everyone who is bitten, when he (**LOOKS, WORKS**) at it, shall live.'" **NUMBERS 21:8**
7. "So Moses made a bronze serpent, and put it on a pole; and so it was, if a serpent had bitten anyone, when he looked at the bronze serpent, he (**LIVED, DIED**).'" **NUMBERS 21:9**

# THE BRONZE SERPENT

(NUMBERS 21:4-9)

B	D	E	K	O	O	L	H	C	R	K	Q	L	V	J
Y	U	H	H	L	P	I	A	C	B	C	D	S	M	E
N	W	N	Z	N	J	O	W	Q	D	R	J	T	A	A
M	L	O	R	D	T	V	N	E	B	E	E	F	Z	W
H	J	S	E	H	T	A	O	L	Z	T	N	A	S	L
L	N	G	I	V	B	Q	P	I	K	N	Q	N	D	Z
M	S	N	V	Q	I	Z	E	W	E	I	O	A	I	E
O	Z	G	V	T	A	U	S	Z	F	O	R	R	H	S
S	D	E	G	A	R	U	O	C	S	I	D	Y	B	M
E	K	R	B	A	M	A	G	K	J	T	E	Y	M	P
S	B	Q	Q	Q	G	N	D	K	T	A	Y	O	L	J
D	Z	I	Y	F	T	M	E	Q	E	N	A	F	S	H
S	E	R	P	E	N	T	S	J	J	R	R	V	V	G
R	F	P	E	H	Y	G	P	B	Z	P	P	M	O	E
E	E	L	O	P	L	F	Z	B	Z	I	I	S	J	U

**BREAD  
BRONZE  
DISCOURAGED  
LOATHES**

**LOOKED  
LORD  
MOSES  
POLE**

**PRAYED  
SERPENTS  
SINNED**

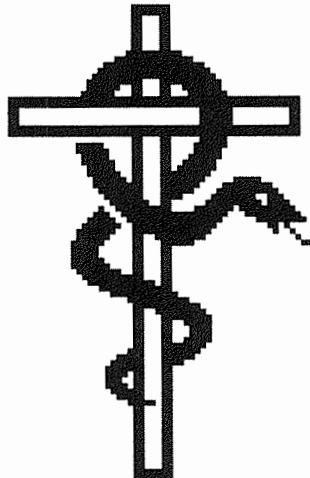

# THE BRONZE SERPENT

## (NUMBERS 21:4-9)

### MEMORY VERSE:

**"And as Moses lifted up the serpent in the wilderness, even so must the Son of Man be lifted up." JOHN 3:14**

### FILL IN THE BLANKS:

1. The children of Israel "journeyed from Mount Hor by the Way of the Red Sea, to go around the land of Edom; and the soul of the people became very \_\_\_\_\_ on the way." **NUMBERS 21:4**
2. "And the people spoke against \_\_\_\_\_ and against \_\_\_\_\_: 'Why have you brought us up out of Egypt to die in the wilderness? For there is no \_\_\_\_\_ and no \_\_\_\_\_, and our soul loathes this worthless \_\_\_\_\_.'" **NUMBERS 21:5**
3. "So the LORD sent fiery \_\_\_\_\_ among the people, and they bit the people; and many of the people of Israel died." **NUMBERS 21:6**

### UNDERLINE THE CORRECT ANSWER:

4. "Therefore the people came to Moses, and said,..." **NUMBERS 21:7**
  - a. we have sinned
  - b. we have spoken against the LORD and against you
  - c. pray to the LORD that He take away the serpents from us
  - d. all of the above

### TRUE OR FALSE:

5. But Moses would not pray to the LORD for the people. **NUMBERS 21:7**  
**TRUE OR FALSE**

### CIRCLE THE CORRECT WORD:

6. "Then the LORD said to Moses, 'Make a fiery serpent, and set it on a pole; and it shall be that everyone who is bitten, when he (**LOOKS, WORKS**) at it, shall live.'" **NUMBERS 21:8**

### FILL IN THE BLANK:

7. "So Moses made a bronze serpent, and put it on a pole; and so it was, if a serpent had bitten anyone, when he looked at the bronze serpent, he \_\_\_\_\_." **NUMBERS 21:9**

# THE BRONZE SERPENT

(NUMBERS 21:4-9)

G E P R Z Z J Z B A J Q K S G C S F W D  
 M Y M X O M W E H U T T I S D C V L Q Y  
 B G B D W F D M F P R A Y E D H Y Y N S  
 P M R O D M Y E V U A H E I V R K H I M  
 M O B S H I J D N T A T P E V I L P S U  
 L Q O L Q Q S W I N U T I A D E K O O L  
 W H H K I S T C O T I R Y G B E W O V X  
 N V S W L Q N Q O D E S B W G S L I U S  
 G V S P O L E L S U N R B A E E W R U E  
 K G R V H V A I N E R W P Z C H W F A J  
 B B V J T P S T H D S A N F Z T Z Y D M  
 Y S R N Y S L A I Q Q O G U H A O X D G  
 K N N E O B E L U C R P M E K O A D W O  
 P B G W A Q P R A B P N P T D L K P T V  
 U P D E A D U B P L N K Y O K M M B L S  
 Y R P L V J T Z F E A B F M R Q N E A P  
 F O G V C I N Z F J N C O J E N U H O T  
 S J S D A C D N T N Y T J K N Y D T A W  
 T Q P D L T R K Q S Q D S G C M L L P B  
 G S P Z O C A O H M U W W H V A U U A H

BREAD  
 BRONZE  
 DISCOURAGED  
 LIVE

LOATHES  
 LOOKED  
 LORD  
 MOSES

POLE  
 PRAYED  
 SERPENTS  
 SINNED

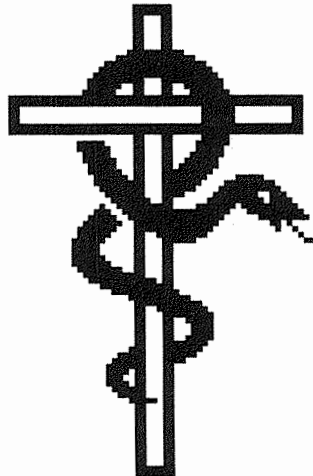

**Year 1**

**Week 49**

## **Balaam, the Donkey, And The Angel**

**Scriptures: Numbers 22, 23, and 24**

**Key Verse: Numbers 22:33** “The donkey saw Me and turned aside from me these three times. If she had not turned aside from Me, surely I would also have killed you by now, and let her live.”

### **Key Points:**

1. The Israelites camped in the land of Moab across from Jericho. Balak, king of Moab was very fearful of them because they were very numerous, very victorious, and because of the news of their Egyptian deliverance.
2. Balak wished to hire Balaam the prophet to curse God’s people so he could drive them out and defeat them. He sent messengers to entice Balaam. Balak offered Balaam great honor and riches.
3. God’s anger was kindled against Balaam because Balaam traveled with Balak’s messengers to meet the king.
4. As Balaam traveled, his donkey turned aside when she saw the Angel of the Lord so Balaam struck her. Again the donkey smashed Balaam’s foot against a wall trying to turn from the angel so Balaam struck her a second time. A third time, the donkey laid down under Balaam to avoid the angel of the Lord and Balaam struck her.
5. God opened the mouth of the little donkey and she spoke to Balaam and then the Lord opened Balaam’s eyes to see the Angel of the Lord with His sword drawn. Balaam fell on his face before the angel and confessed his sin. He proceeded on his trip and blessed Israel 4 times instead of cursing Israel as Balak, king of Moab had wanted.



**BALAAM**  
**(NUMBERS 22-24)**



“And the LORD opened the mouth of the ass, and she said unto Balaam,  
What have I done unto thee, that thou hast smitten me these three times?”

**NUMBERS 22:28**

# 11. A Talking Donkey

Balak, the king of Moab, was afraid because the Israelites had been winning many battles and now were ready to enter the land of Moab. King Balak offered a lot of money to Balaam, a man of God, if he would come and curse the Israelites.

Balaam rode his donkey to visit the king. On his way, the donkey stopped. It saw an angel with a sword on the road. Balaam hit the donkey but it wouldn't move. Then God allowed the donkey to speak. "Why did you beat me?" asked the donkey. "I have always obeyed you."

Then God opened Balaam's eyes and he saw the angel. Balaam bowed before the angel. The angel said, "The donkey saved your life. I would have killed you."

Balaam said, "I have sinned. I will go back home."

Use the dial-a-message code to find out what the angel told Balaam.

4-1 6-3 8-1 6-3 2-2 2-1 5-3 2-1 5-2 2-2 8-2 8-1  
 6-3 6-2 5-3 9-3 7-3 2-1 9-3 9-1 4-2 2-1 8-1 4-1 6-3 3-1  
 4-1 4-3 8-3 3-2 7-3 9-3 6-3 8-2 8-1 6-3  
 7-3 7-1 3-2 2-1 5-2

**How to Dial-a-Message:**  
 The first number tells you what circle to look at on the dial. The second number tells you which letter to write down (for example, 7-2 is "R," the second letter on the 7 circle).

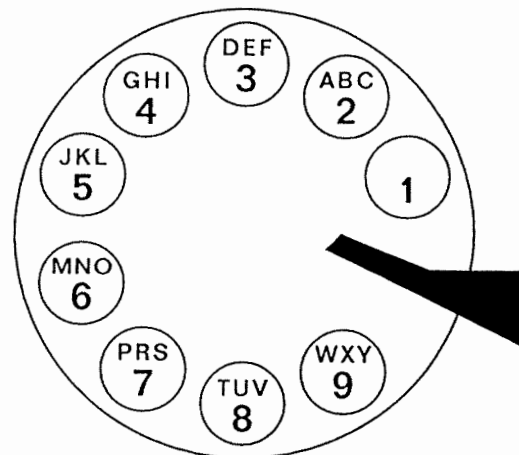

# BALAAM

## (NUMBERS 22-24)

### MEMORY VERSE:

*"He was rebuked for his iniquity; a dumb donkey speaking with a man's voice restrained the madness of the prophet." 2 PETER 2:16*

### TRUE OR FALSE:

1. "The children of Israel moved ,and camped in the plains of Moab on the side of the Jordan across from Jericho." **NUMBERS 22:1**

TRUE OR FALSE

### FILL IN THE BLANK:

2. Now Balak "sent messengers to Balaam the son of Beor at Pethor, which is near the River in the land of the sons of his people, to call him, saying: 'Look, a people has come from Egypt. See, they \_\_\_\_\_ the face of the earth, and are settling next to me!' " **NUMBERS 22:5**

### UNDERLINE THE CORRECT ANSWER:

3. Balaam was asked, "Please come at once, curse this people for me, for they are too mighty for me. Perhaps I shall be able to defeat them and drive them out of the land, for I know that..."**NUMBERS 22:6**
- a. he whom you bless is blessed
  - b. and he whom you curse is cursed
  - c. both of these answers
4. "God said to Balaam..." **NUMBERS 22:12**
- a. You shall not go with them
  - b. You shall not curse the people
  - c. They are blessed
  - d. all of the above

### FILL IN THE BLANK:

5. When Balaam did go, "God's anger was aroused because he went, and the \_\_\_\_\_ of the LORD took his stand in the way as an adversary against him. And he was riding on his donkey, and his two servants were with him." **NUMBERS 22:22**

### CIRCLE THE CORRECT WORDS:

6. "When the donkey saw the Angel of the LORD, she lay down under Balaam; so Balaam's anger was aroused, and he (**STRUCK, TICKLED**) the donkey with his staff." **NUMBERS 22:27**
7. "The LORD opened the mouth of the (**MONKEY, DONKEY**), and she said to Balaam, 'What have I done to you, that you have struck me these three times?' " **NUMBERS 22:28**
8. The Angel of the LORD said to Balaam, "The donkey saw Me and turned aside from Me these (**THIRTY, THREE**) times. If she had not turned aside from Me, surely I would also have killed you by now." **NUMBERS 22:33**

### TRUE OR FALSE:

9. "The Angel of the LORD said to Balaam, 'Go with the men, but only the word that I speak to you, that you shall speak.' " **NUMBERS 22:35**

TRUE OR FALSE

10. "Balak's anger was aroused against Balaam, and he struck his hands together; and Balak said to Balaam, 'I called you to curse my enemies, and look, you have bountifully blessed them these three times.'" **NUMBERS 24:10**

TRUE OR FALSE

# BALAAM

(NUMBERS 22-24)

P S C E H I Q B Q M I F L Q Y  
R S F U N V T I Z P W J C R Y  
O I K W G V A A U E Z T T Y O  
P L B J G B M A A L A B I E F  
H S D E S S E L B S K E O K V  
E J Y N G Q Q M A G K J T N L  
T L N S R Y F X N D Q Z A O S  
K L M Z Q E H T M E J Z N D V  
T D R O L E H T F O L E G N A  
D O H K I K A L A B B K R I M  
Y P E S R U C Y G P B C P L T  
H E L B P L P L F Z R U I S H  
J E R I C H O I H C B R Q T R  
U O D Z H N J O A C K T D F E  
Q O R F Z V T V W Q E S J A E

ANGEL OF THE LORD  
BALAAM  
BALAK  
BLESSED

CURSE  
DONKEY  
JERICO

PROPHET  
STRUCK  
THREE

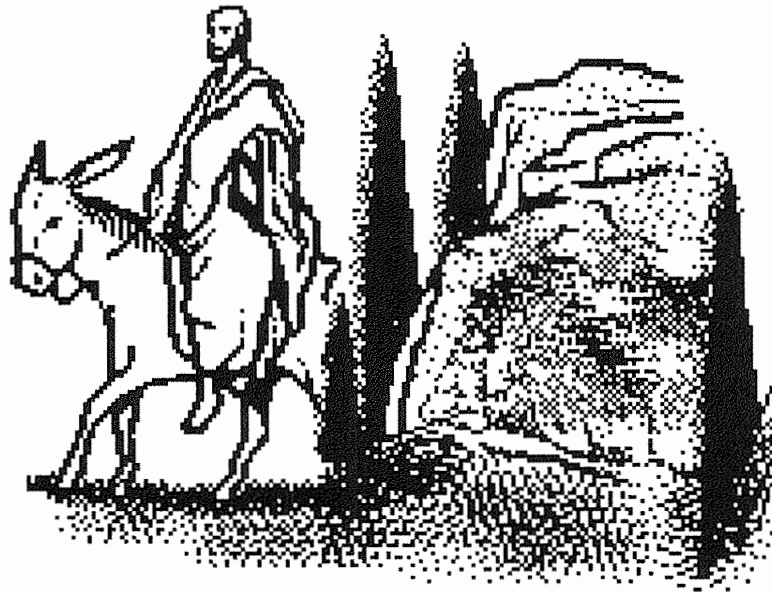

# BALAAM

## (NUMBERS 22-24)

### MEMORY VERSE:

*"He was rebuked for his iniquity; a dumb donkey speaking with a man's voice restrained the madness of the prophet." 2 PETER 2:16*

### FILL IN THE BLANKS:

1. "The children of Israel moved, and camped in the plains of Moab on the side of the Jordan across from \_\_\_\_\_." **NUMBERS 22:1**
2. Now Balak "sent messengers to Balaam the son of Beor at Pethor, which is near the River in the land of the sons of his people, to call him, saying: 'Look, a people has come from Egypt. See, they \_\_\_\_\_ the face of the earth, and are settling next to me!' " **NUMBERS 22:5**

### UNDERLINE THE CORRECT ANSWER:

3. Balaam was asked, "Please come at once, curse this people for me, for they are too mighty for me. Perhaps I shall be able to defeat them and drive them out of the land, for I know that..."**NUMBERS 22:6**
  - a. he whom you bless is blessed
  - b. and he whom you curse is cursed
  - c. both of these answers
4. "God said to Balaam..." **NUMBERS 22:12**
  - a. You shall not go with them
  - b. You shall not curse the people
  - c. They are blessed
  - d. all of the above

### FILL IN THE BLANKS:

5. When Balaam did go, "God's anger was aroused because he went, and the \_\_\_\_\_ of the LORD took his stand in the way as an adversary against him. And he was riding on his donkey, and his two servants were with him." **NUMBERS 22:22**
6. "When the donkey saw the Angel of the LORD, she lay down under Balaam; so Balaam's anger was aroused, and he \_\_\_\_\_ the donkey with his staff." **NUMBERS 22:27**
7. "The LORD opened the mouth of the \_\_\_\_\_ and she said to Balaam, 'What have I done to you, that you have struck me these three times?' " **NUMBERS 22:28**
8. The Angel of the LORD said to Balaam, "The donkey saw Me and turned aside from Me these \_\_\_\_\_ times. If she had not turned aside from Me, surely I would also have killed you by now." **NUMBERS 22:33**

### TRUE OR FALSE:

9. "The Angel of the LORD said to Balaam, 'Go with the men, but only the word that I speak to you, that you shall speak.' " **NUMBERS 22:35**

TRUE OR FALSE

### FILL IN THE BLANKS:

10. "Balak's anger was aroused against Balaam, and he struck his hands together; and Balak said to Balaam, 'I called you to \_\_\_\_\_ my enemies, and look, you have bountifully \_\_\_\_\_ them these three times.' " **NUMBERS 24:10**

# BALAAM

## (NUMBERS 22-24)

C L Y N G E A J T B A C M R B U V M U B  
 O U L B D L V I N Z N U N R P T B Q N E  
 Q Y P L P V M C D P R O P H E T G N U H  
 L Y U K A D C A R Z M J A W P O C Y D T  
 R R Y O K N A T A N T K Y P Y M Z M L L  
 H F F J S D G K A L A B Q N Y E K N O D  
 I H K Q P Z L E A K A S B K M J H A U U  
 D E T S P Z O C L O Q B Q B O D K S F W  
 Y L G P R O Z J Z O H M T C E E K V L Q  
 E M E M X W M W E B F J H S J S R Y Y N  
 D G Y B O H F Y M H A T R D W S E K H I  
 P M G B S J M J D M B U H W S E N W X S  
 U B M O L Q E T W V C T T E S L C L O V  
 G P Q H K I Q R Q I U A K K L B V W I U  
 I M H S W L S N I O T A C I I O C W R U  
 C W V S V H Q A M C T M U E A K R Z F A  
 E N V R J E V S I N H E R P G G C D Y D  
 U G G V E T P L T H D O T I W H H O X D  
 M K S R M Y B P A I D N S Y A G R A D W  
 M B T N W O Q U L U Q Q T B F D E K F T

**ANGEL OF THE LORD**  
**BALAK**  
**BALAAM**  
**BLESSED**

**CURSE**  
**DONKEY**  
**JERICO**

**PROPHET**  
**STRUCK**  
**TREE**

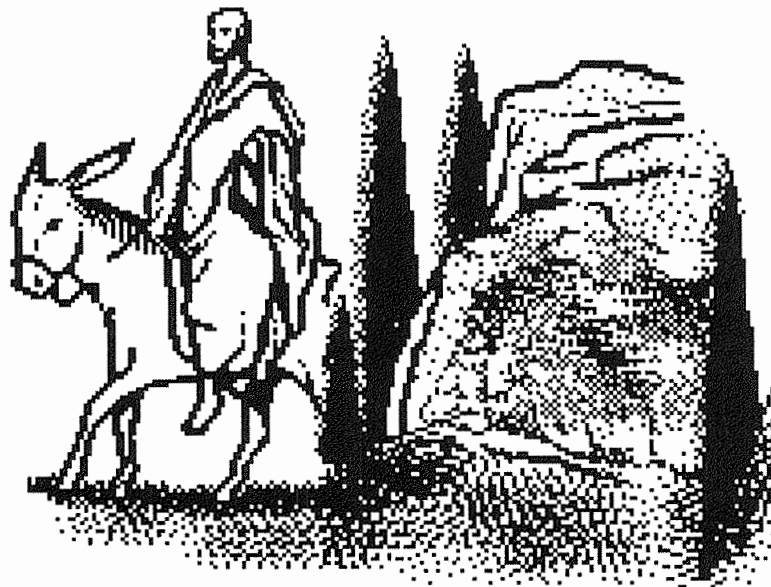

# BALAAM

## (NUMBERS 22-24)

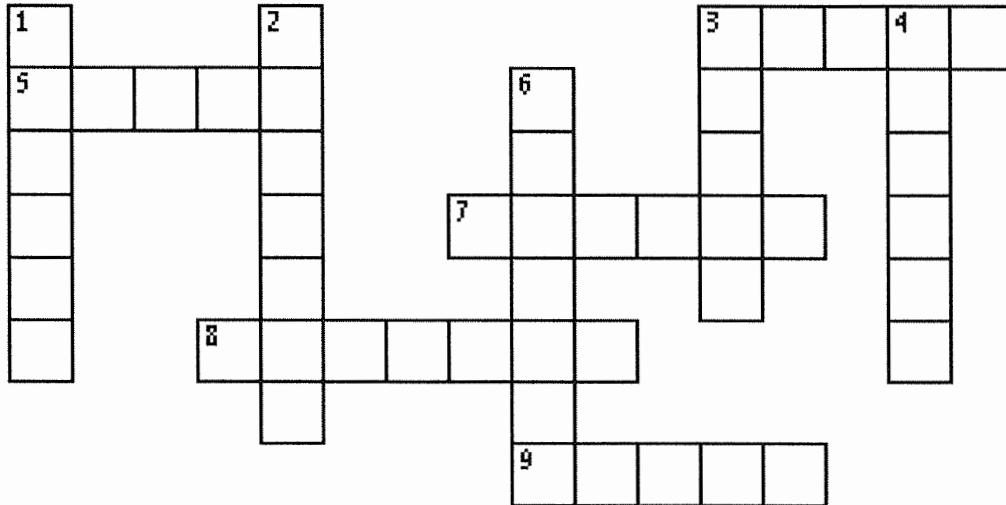

- 6 DOWN "He was rebuked for his iniquity; a dumb donkey speaking with a man's voice restrained the madness of the \_\_\_\_." **2 PETER 2:16**
- 8 ACROSS "The children of Israel moved ,and camped in the plains of Moab on the side of the Jordan across from \_\_\_\_." **NUMBERS 22:1**
- 3 DOWN Now Balak "sent messengers to Balaam the son of Beor at Pethor, which is near the River in the land of the sons of his people, to call him, saying: 'Look, a people has come from Egypt. See, they \_\_\_\_ the face of the earth, and are settling next to me!' " **NUMBERS 22:5**
- 3 ACROSS Balaam was asked, "Please come at once, \_\_\_\_ this people for me, for they are too mighty for me. Perhaps I shall be able to defeat them and drive them out of the land, for I know that he whom you bless is blessed, and he whom you curse is cursed." **NUMBERS 22:6**
- 1 DOWN "God said to \_\_\_\_, 'You shall not go with them; you shall not curse the people, for they are blessed.' " **NUMBERS 22:12**
- 5 ACROSS When Balaam did go, "God's anger was aroused because he went, and the \_\_\_\_ of the LORD took his stand in the way as an adversary against him. And he was riding on his donkey, and his two servants were with him." **NUMBERS 22:22**
- 4 DOWN "When the donkey saw the Angel of the LORD, she lay down under Balaam; so Balaam's anger was aroused, and he \_\_\_\_ the donkey with his staff." **NUMBERS 22:27**
- 7 ACROSS "The LORD opened the mouth of the \_\_\_\_, and she said to Balaam, 'What have I done to you, that you have struck me these three times?' " **NUMBERS 22:28**
- 9 ACROSS The Angel of the LORD said to Balaam, "The donkey saw Me and turned aside from Me these \_\_\_\_ times. If she had not turned aside from Me, surely I would also have killed you by now." **NUMBERS 22:33**
- 2 DOWN "Balak's anger was aroused against Balaam, and he struck his hands together; and Balak said to Balaam, 'I called you to curse my enemies, and look, you have bountifully \_\_\_\_ them these three times.' " **NUMBERS 24:10**

**Year 1**

**Week 50**

## **Death of Moses-Joshua Begins To Lead**

**Scriptures: Deuteronomy 34, Joshua 1**

**Key Verse: Joshua 1:2 “Moses, My servant is dead. Now therefore, arise, go over this Jordan, you and all this people, to the land which I am giving to them-the children of Israel.”**

### **Key Points:**

- 1.** Moses went to the top of Mt. Nebo and God showed him the entire promised land which was the land that God had sworn to Abraham, Isaac, and Jacob to give to their descendants.
- 2.** Moses died there and God buried him in a valley in Moab. He was 120 years old and still strong and his eyesight was undimmed. The children of Israel mourned for Moses 30 days. God did not permit Moses to enter the promised land.
- 3.** Joshua, Moses’ assistant became his successor. Moses had laid his hand on Joshua therefore, he was full of the spirit of wisdom.
- 4.** God told Joshua to lead His people into the promised land. God told Joshua to be brave, courageous, strong, and not to fear, or be dismayed.
- 5.** Joshua organized the people to ready themselves to go into the Canaan land (promised land). The people all agreed to follow Joshua and to obey God.



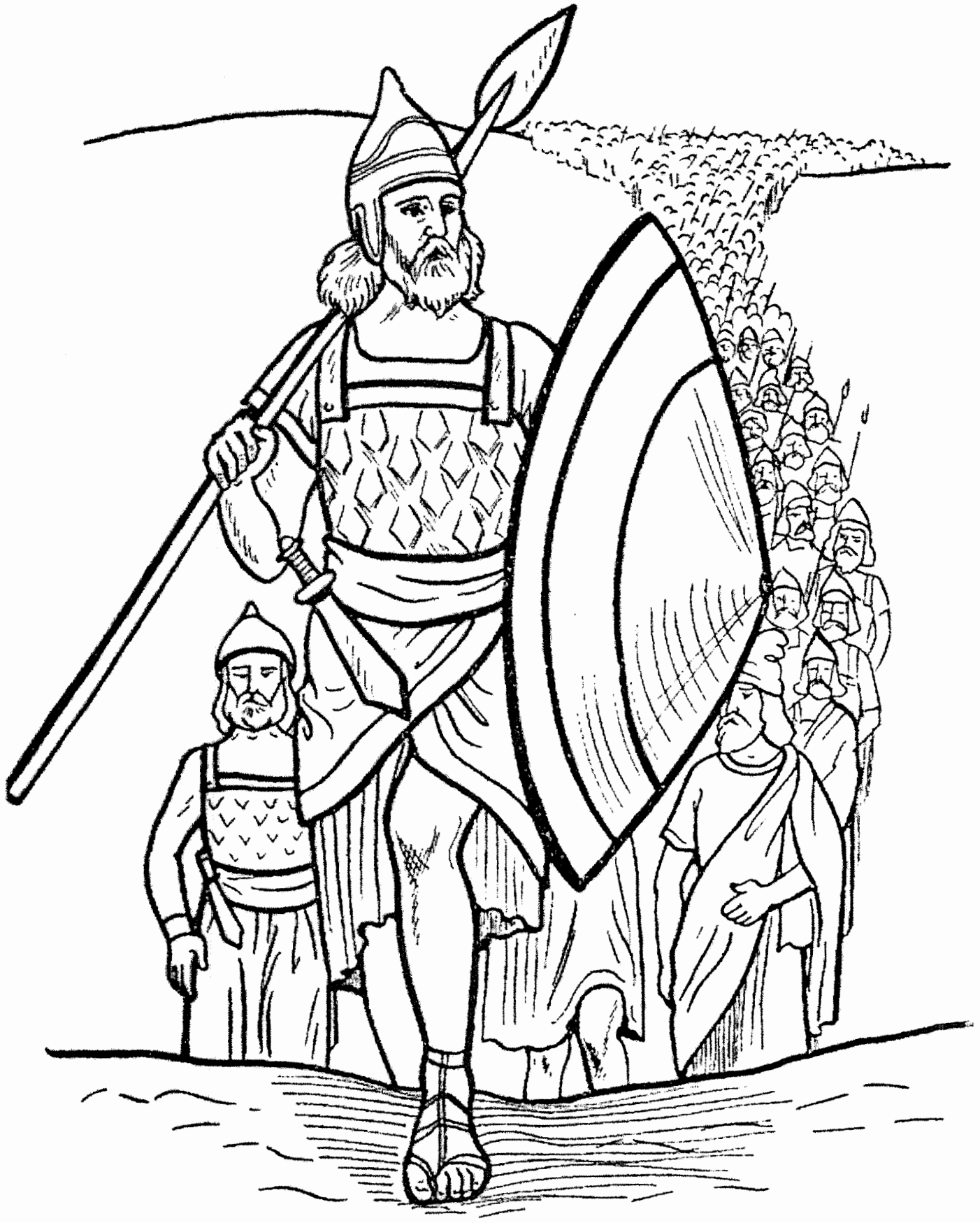

After the death of Moses, Joshua led the Hebrews in the battles for the Promised Land.

# PROMISED LAND

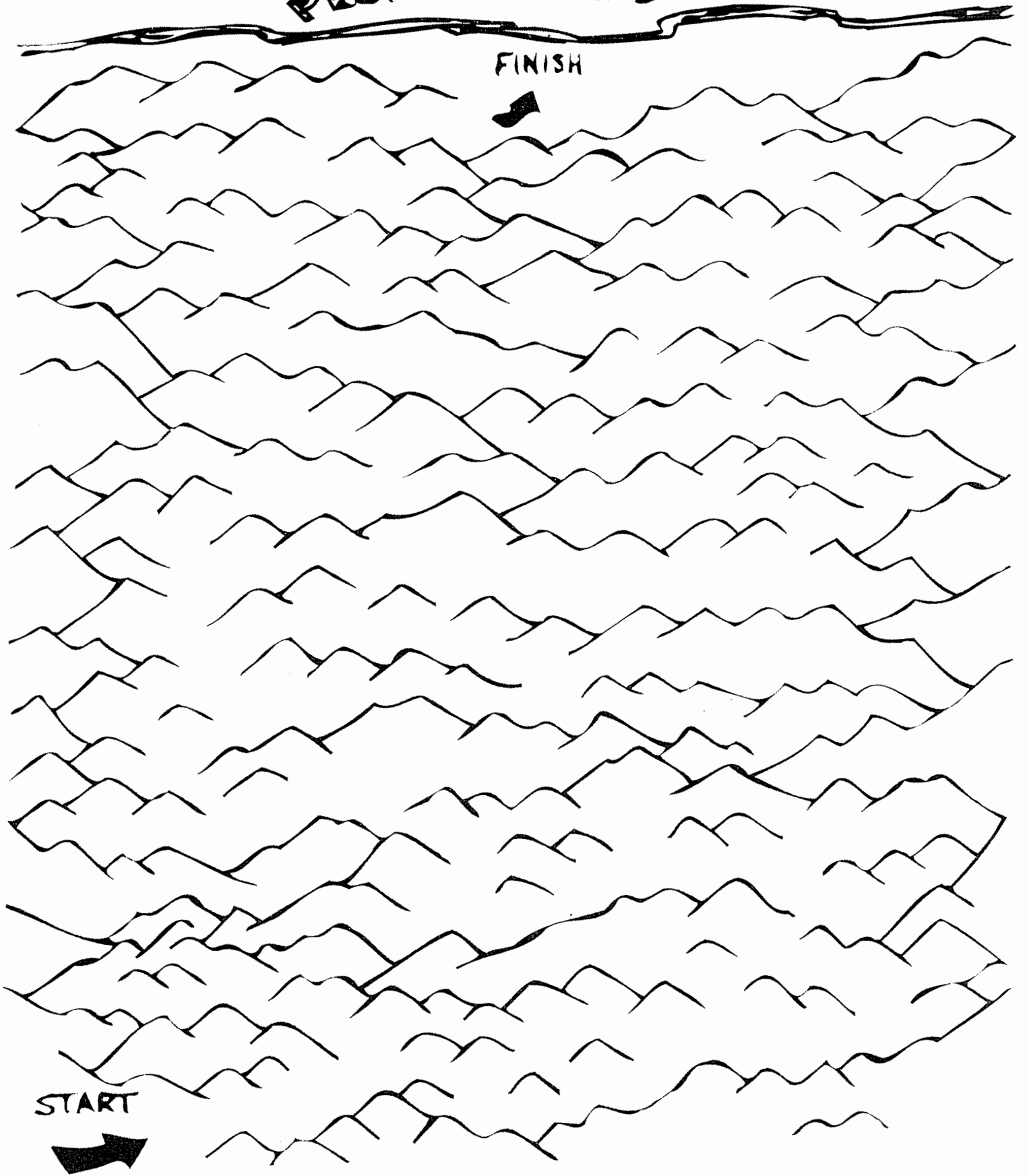

# Joshua's Answer

When it was time for Moses to die, God told Joshua to lead his people. God told Joshua to be strong and brave. God told Joshua to tell the people to obey, and to lead them with courage. What was Joshua's answer? To find out, take away (use a dark color to fill in) every face that isn't smiling. When you're finished, you'll be able to read Joshua's answer among the smiling faces.

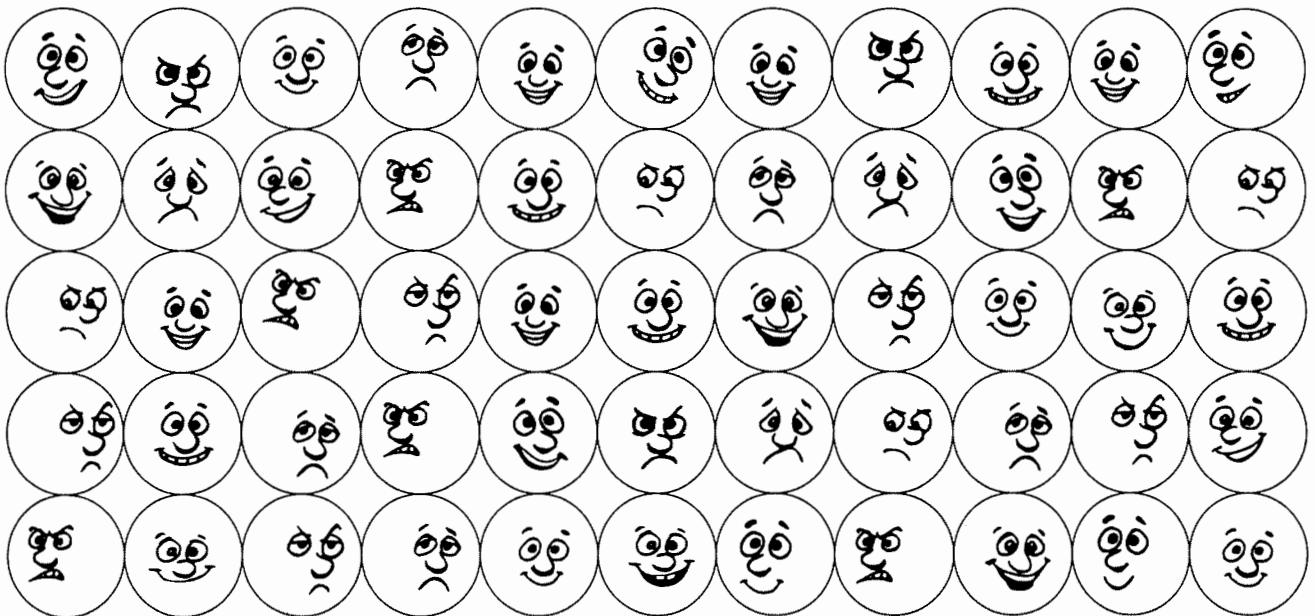

What should your answer be when God asks you to do something?

 \_\_\_\_\_ !



**Joshua Succeeds**  
**Moses**  
**Deuteronomy 34;**  
**Joshua 1**

# An Awesome Promise

.....

The children of Israel had wandered in the desert for 40 years. Now they were ready to enter the promised land. Moses had died and Joshua was appointed the new leader of God's chosen people. Follow the words around and around to discover the awesome promise that God gave to Joshua.

.....

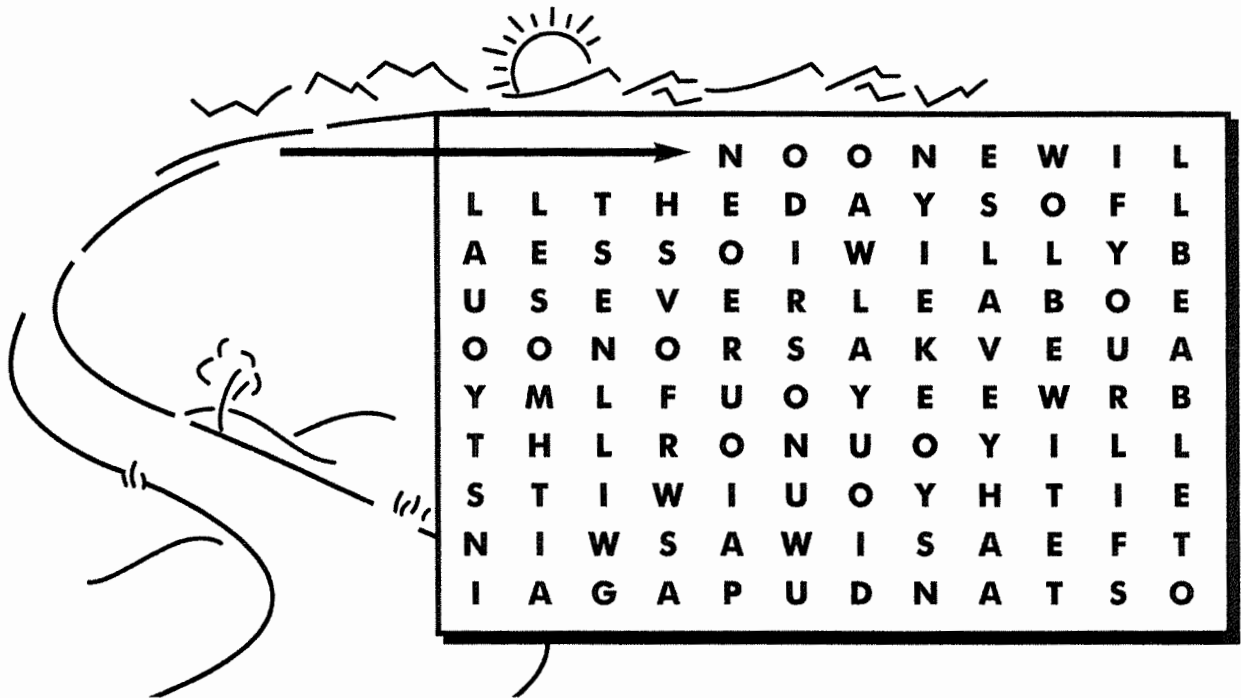

-----

-----

-----

-----

-----

Joshua 1: 6 – 9 FILL IN THE BLANKS (NKJV)

Be \_\_\_\_\_ and of good \_\_\_\_\_, for to this people you shall \_\_\_\_\_ as an inheritance the \_\_\_\_\_ which I swore to their \_\_\_\_\_ to give them. <sup>7</sup> Only be strong and \_\_\_\_\_ courageous, that you may \_\_\_\_\_ what to do according to all the \_\_\_\_\_ which \_\_\_\_\_ My servant \_\_\_\_\_ you; do not \_\_\_\_\_ from it to the \_\_\_\_\_ hand or to the \_\_\_\_\_, that you may \_\_\_\_\_ wherever you go. <sup>8</sup> This \_\_\_\_\_ of the \_\_\_\_\_ shall not depart from your \_\_\_\_\_, but you shall \_\_\_\_\_ in it day and night, that you may \_\_\_\_\_ to do according to all that is \_\_\_\_\_ in it. For then you will \_\_\_\_\_ your way \_\_\_\_\_, and then you will have good \_\_\_\_\_. <sup>9</sup> Have I not commanded you? Be \_\_\_\_\_ and of good \_\_\_\_\_; do not be \_\_\_\_\_, nor be dismayed, for the \_\_\_\_\_ your \_\_\_\_\_ is with you wherever \_\_\_\_\_ go.”

## JOSHUA 1:6 – 9

Be strong and of good courage, for to this people you shall <sup>[a]</sup>divide as an inheritance the land which I swore to their fathers to give them. <sup>7</sup> Only be strong and very courageous, that you may observe to do according to all the law which Moses My servant commanded you; do not turn from it to the right hand or to the left, that you may <sup>[b]</sup>prosper wherever you go. <sup>8</sup> This Book of the Law shall not depart from your mouth, but you<sup>[c]</sup> shall meditate in it day and night, that you may observe to do according to all that is written in it. For then you will make your way prosperous, and then you will have good success. <sup>9</sup> Have I not commanded you? Be strong and of good courage; do not be afraid, nor be dismayed, for the Lord your God *is* with you wherever you go.”

# MOSES DIES

(DEUTERONOMY 34)

M O S E S K D S L B  
G N L Z K C I W A U  
S O H C I R E J C R  
N E L F B P D V W I  
G U E P T U D R J E  
O B E N T N U O M D  
Z A U H S O J C U T  
J O M G U M L M K E  
P R O P H E T L O J  
P F S D N A L B I K

BURIED  
DIED  
JERICO  
JOSHUA

LAND  
MOSES  
MOUNT NEBO

PROPHET  
SEE  
WEPT



Name: \_\_\_\_\_

# Joshua 1

O T S Z P V S C M E D I T A T E K  
N P R O S P E R O U S K W T A R Q  
S B A F Q J S M G F O R O A N X X  
A L Z E S S G O Z U C C Z O Y H H  
V S K Z I K D D K O F C A O B F C  
G B G B Z I Y O U S S E C C U S T  
W R E D A E L R Q Y D E P A R T U  
D P Z F X F A R S T R O N G G I A  
D O U I N G A B O B E D I E N T U  
A E T L E A D Z M O V R N X W V H  
L F D C K R S E U L V W X O R W S  
T V R N O E U Y B Q A T X F I O O  
B X D L A I I T A Q G W D W T V J  
G B V L J M Z F H W L Y M R T N M  
C G O O D V M K A G A R W X E T E  
I G N W Q R R O H D I U X A N U C  
O B S E R V E D C Q B N O B V D R

- |        |           |         |            |
|--------|-----------|---------|------------|
| Book   | Commanded | courage | Day        |
| Depart | God       | Good    | Joshua     |
| Law    | Leader    | Lord    | meditate   |
| Night  | obedient  | Observe | prosperous |
| Strong | success   | Way     | Written    |



# Moses Dies

## (Deuteronomy 34)

### MEMORY VERSE:

*"There has not arisen in Israel a prophet like Moses, whom the LORD knew face to face."*

**DEUTERONOMY 34:10**

### FILL IN THE BLANK:

1. "Moses went up from the plains of Moab to Mount \_\_\_\_\_, to the top of Pisgah, which is across from Jericho." **DEUTERONOMY 34:1**

*"And the LORD showed him all the land of Gilead as far as Dan, all Naphtali and the land of Ephraim and Manasseh, all the land of Judah as far as the Western Sea, the South, and the plain of the Valley of Jericho, the city of palm trees, as far as Zoar." DEUTERONOMY 34:1-3*

### TRUE OR FALSE:

2. "Then the LORD said to him, 'This is the land of which I swore to give Abraham, Isaac, and Jacob, saying, "I will give it to your descendants." ' " **DEUTERONOMY 34:4**

**TRUE OR FALSE**

3. The LORD said, "I have caused you to see it with your eyes and you shall cross over there." **DEUTERONOMY 34:4**

**TRUE OR FALSE**

4. "So Moses the servant of the LORD died there in the land of Moab, according to the word of the LORD." **DEUTERONOMY 34:5**

**TRUE OR FALSE**

### CIRCLE THE CORRECT WORDS:

5. "And He buried him in a valley in the land of Moab, opposite Beth Peor; but **(NO ONE, EVERYONE)** knows his grave to this day." **DEUTERONOMY 34:6**

6. "And the children of Israel **(WEPT, LAUGHED)** for Moses in the plains of Moab thirty days." **DEUTERONOMY 34:8**

7. "Now **(JOSHUA, JEREMIAH)** the son of Nun was full of the spirit of wisdom, for Moses had laid his hands on him." **DEUTERONOMY 34:9**

8. "There has not arisen in Israel a **(SOLDIER, PROPHET)** like Moses, whom the LORD knew face to face." **DEUTERONOMY 34:10**

# MOSES DIES

(DEUTERONOMY 34)

P K P L A Q A Q N C A B F G G M Y Y N M  
 U O K V V J S X H U Y C O W C Q K H I U  
 Y J S D C I T I I M O U N T N E B O S P  
 F Q S D D C L E U J Q D J A Z N W X V S  
 K S P E A E P T H K D I E D R O L O U E  
 T P P Z S T S A A P U W W F H Y L I U J  
 G M R Z L O U C F S O K S U M M W R A M  
 E B X O O C M L E M Q R S T M S W F D G  
 Y B O W E P T B F N T I P O D Y Z Y D O  
 G O S W Z D T Z T J D E I E R A O X W V  
 M J L H M N N Z Q T H A I M E D A D T S  
 Q H O Q F A D N H A T R N J N Y M F L P  
 H S K S M L R K A A U P A T C T U B A T  
 V S W I H J A O U B T I O K S R N E O W  
 V R V L Q U Z B U U R Y H G V I U H A B  
 G V J H S W A H T E R B C H C H D T P H  
 S N X T Q Y E F T N W B I G C T L L A J  
 N G W Y V J M V D Q P P R D H A U U D Y  
 B S E E P T D I D X N P E V R S F W Y K  
 K D E O B N W O Q N K Y J B E V L Q S P

<b>DIED</b>	<b>JOSHUA</b>	<b>MOSES</b>	<b>SEE</b>
<b>DESCENDANTS</b>	<b>LAND</b>	<b>BURIED</b>	<b>JERICO</b>
<b>MOUNT NEBO</b>	<b>LORD</b>	<b>PROPHET</b>	<b>WEPT</b>
<b>THIRTY DAYS</b>			



# Moses Dies

## (Deuteronomy 34)

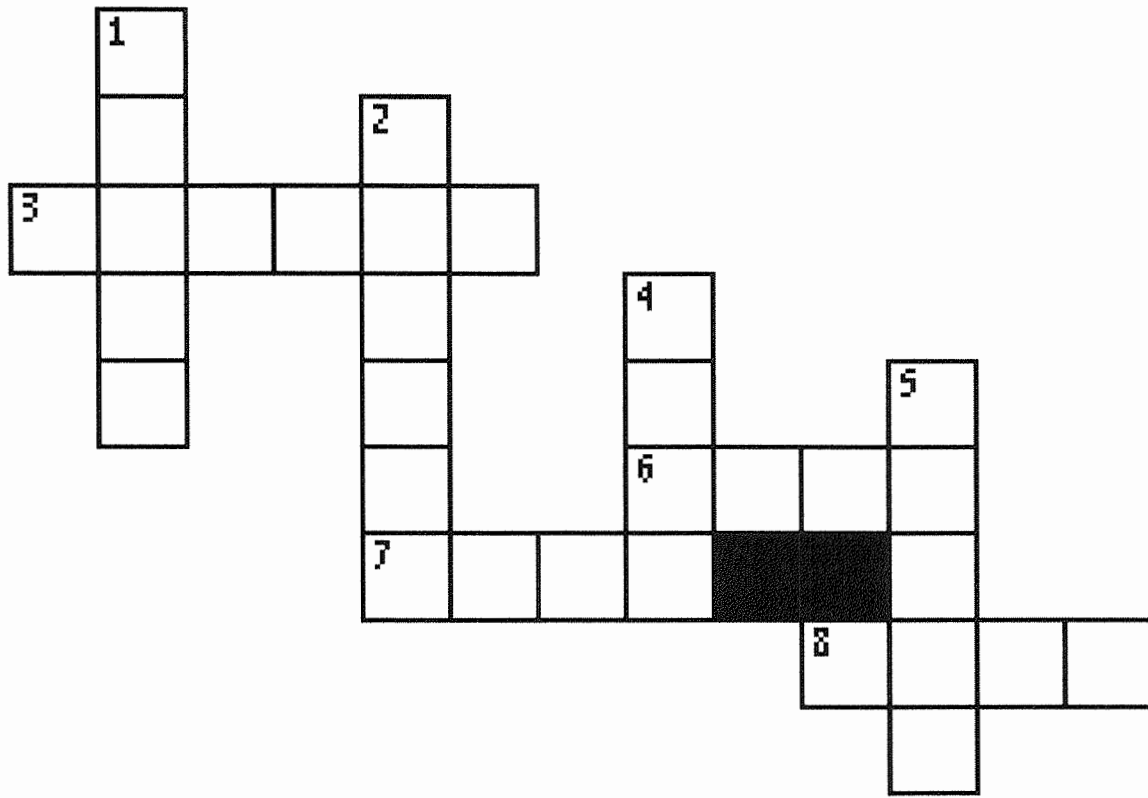

- 6 ACROSS "Moses went up from the plains of Moab to Mount \_\_\_\_\_, to the top of Pisgah, which is across from Jericho." **DEUTERONOMY 34:1**
- 4 DOWN "Then the LORD said to him, 'This is the \_\_\_\_\_ of which I swore to give Abraham, Isaac, and Jacob, saying, "I will give it to your descendants." ' " **DEUTERONOMY 34:4**
- 1 DOWN The LORD said, "I have caused you to see it with your eyes, but you shall not \_\_\_\_\_ over there." **DEUTERONOMY 34:4**
- 7 ACROSS "So Moses the servant of the LORD \_\_\_\_\_ there in the land of Moab, according to the word of the LORD." **DEUTERONOMY 34:5**
- 2 DOWN "And He \_\_\_\_\_ him in a valley in the land of Moab, opposite Beth Peor; but no one knows his grave to this day." **DEUTERONOMY 34:6**
- 8 ACROSS "And the children of Israel \_\_\_\_\_ for Moses in the plains of Moab thirty days." **DEUTERONOMY 34:8**
- 3 ACROSS "Now \_\_\_\_\_ the son of Nun was full of the spirit of wisdom, for Moses had laid his hands on him." **DEUTERONOMY 34:9**
- 5 DOWN "There has not arisen in Israel a prophet like \_\_\_\_\_ whom the LORD knew face to face." **DEUTERONOMY 34:10**



# JOSHUA BECOMES ISRAEL'S NEW LEADER

## (JOSHUA 1)

### MEMORY VERSE:

***"This Book of the Law shall not depart from your mouth, but you shall meditate in it day and night, that you may observe to do according to all that is written in it. For then you will make your way prosperous, and then you will have good success."* JOSHUA 1:8**

### FILL IN THE BLANKS:

1. "After the death of Moses the servant of the Lord, it came to pass that the LORD spoke to \_\_\_\_\_ the son of Nun, Moses' assistant." **JOSHUA 1:1**
2. He said, "Be \_\_\_\_\_ and of good \_\_\_\_\_ for to this people you shall divide as an inheritance the land which I swore to their fathers to give them." **JOSHUA 1:6**
3. "Have I not commanded you? Be strong and of good courage; do not be afraid, nor dismayed for the LORD your God is \_\_\_\_\_ wherever you go." **JOSHUA 1:9**

### TRUE OR FALSE:

4. "Then Joshua commanded the officers of the people, saying, 'Pass through the camp and command the people, saying, "Prepare provisions for yourselves, for within three days you will go back to Egypt." ' " **JOSHUA 1:10-11**  
**TRUE OR FALSE**
5. Joshua said, "Remember the word which Moses the servant of the LORD commanded you saying, 'The LORD your God is giving you rest and is giving you this land.' " **JOSHUA 1:13**  
**TRUE OR FALSE**
6. "And they answered Joshua, saying, 'All that you command us we will do, and wherever you send us we will go.' " **JOSHUA 1:16**  
**TRUE OR FALSE**

### FILL IN THE BLANKS:

7. "Just as we heeded Moses in all things, so we will heed you. Only the \_\_\_\_\_ \_\_\_\_\_ be with you, as He was with Moses." **JOSHUA 1:17**
8. "Whoever rebels against your command and does not heed your words, in all that you command him, shall be put to death. Only be \_\_\_\_\_ and of good \_\_\_\_\_ " **JOSHUA 1:18**

# JOSHUA BECOMES ISRAEL'S NEW LEADER

## (JOSHUA 1)

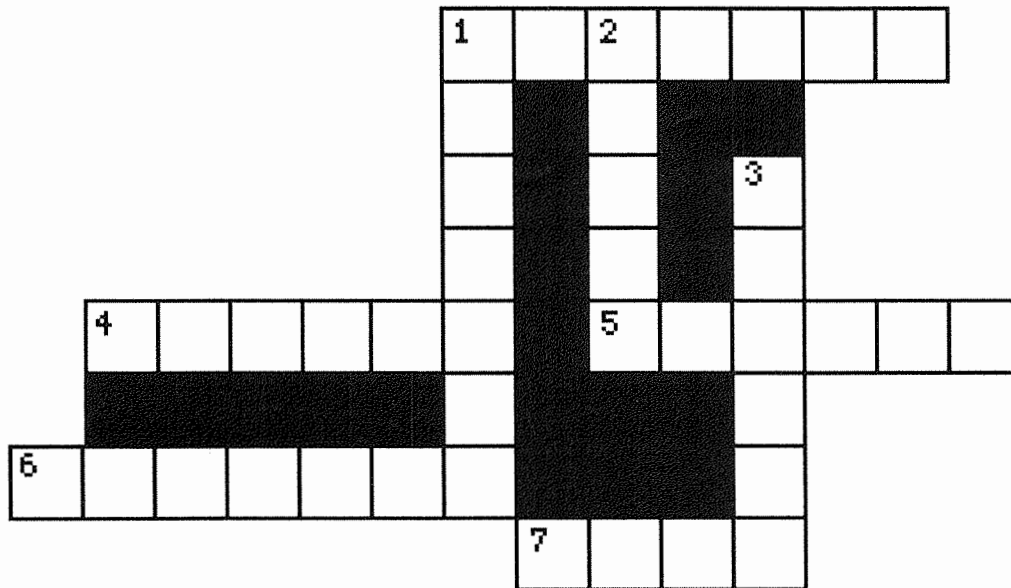

- 6 ACROSS "This Book of the Law shall not depart from your mouth, but you shall meditate in it day and night, that you may \_\_\_\_\_ to do according to all that is written in it. For then you will make your way prosperous, and then you will have good success." **JOSHUA 1:8**
- 4 ACROSS "After the death of Moses the servant of the Lord, it came to pass that the LORD spoke to \_\_\_\_\_ the son of Nun, Moses' assistant." **JOSHUA 1:1**
- 5 ACROSS He said, "Be \_\_\_\_\_ and of good courage for to this people you shall divide as an inheritance the land which I swore to their fathers to give them." **JOSHUA 1:6**
- 3 DOWN "Have I not commanded you? Be strong and of good courage; do not be \_\_\_\_\_, nor dismayed for the LORD your God is with you wherever you go." **JOSHUA 1:9**
- 7 ACROSS Joshua said, "Remember the word which Moses the servant of the \_\_\_\_\_ commanded you saying, 'The LORD your God is giving you rest and is giving you this land.'" **JOSHUA 1:13**
- 1 ACROSS "And they answered Joshua, saying, 'All that you \_\_\_\_\_ us we will do, and wherever you send us we will go.'" **JOSHUA 1:16**
- 2 DOWN "Just as we heeded Moses in all things, so we will heed you. Only the LORD your God be with you, as He was with \_\_\_\_\_." **JOSHUA 1:17**
- 1 DOWN "Whoever rebels against your command and does not heed your words, in all that you command him, shall be put to death. Only be strong and of good \_\_\_\_\_." **JOSHUA 1:18**

# JOSHUA BECOMES ISRAEL'S NEW LEADER

## (JOSHUA 1)

U C N D E K L X G T S E I L A Z F A D Y K T O Z P  
 I U W J O B A T D E T A M M C Y S R D Y A M A V T  
 W G T Q O Z U Y E J F W G S W S W L O D T O T F O  
 V D I I C F H L P Z A L Y Z J D T W K J W E M R N  
 B T W K F H S I Z Z Y Z P F U N N R Q I L M Z K I  
 M A P T K N O O C K Y X Y P K J U A O J O R D A N  
 C H P D B G J V C C O P B G O T D J M N A P J K J  
 B S E E G A R U O C L J D K I P S U M M G N S Y J  
 H T W E Y X N Q Q T V H R B T L J O L P O O M R Y  
 P O Q Y D G V Z I I X G C U E J H E W T P C P G T  
 D T T H N R Q U W O S E G K J C S E S O M B P I H  
 E W A U M Q T A Z T V U B C K V Q P K V P U C T G  
 B F U Q H I A N K A M W R O K T O T I R A L D U P  
 C A U S L P Q M K N A D G U O W E C J F M P T A Y  
 P M D O G R U O Y D R O L M P K W S S E V M N V Q  
 O F H S D H F G Q R Z W N D Z H O C U J Q C M M D  
 G H E I R Z H F J P S Y G L Y P E F E O D C G O C  
 U K R L E I P H B I H P Z S Y J B H T U V V E U M  
 P N J S U V J A B Q M Z J V O H K U A H S Z I V P  
 M C S J W V T W R D X W P R J Q S E V G E K K Z O  
 O F F I C E R S S B J S B N C F O U C D F M L X A E  
 N U T F J B B P K Q V M U M A A H N Q K C F A U A  
 R Q A F N Q I P E R O W O L H W P Q E D Z K P W Y  
 P D Z O S Y A E F I J U F B A V E L N B L S P E U  
 D C S P Z E M S J L J F L P H M V K R K U M U F H

**BOOK OF THE LAW**  
**COMMAND**  
**COURAGE**  
**HEED**

**JORDAN**  
**JOSHUA**  
**LORD YOUR GOD**

**MOSES**  
**OFFICERS**  
**STRONG**

WRITE THE LETTERS DOWN AS YOU COME TO THEM ON THE LINES BELOW

**BE STRONG**  
**AND OF GOOD COURAGE**

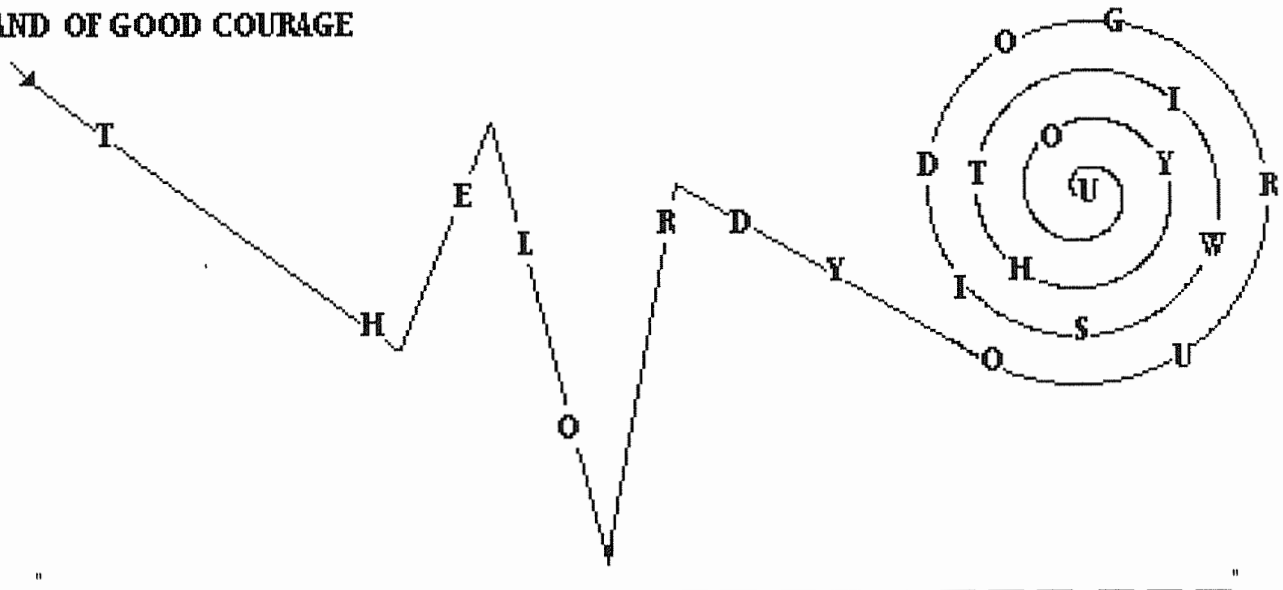

# HILLS AND MOUNTAINS

CLIMB THROUGH THIS PUZZLE AND FIND THE 14 BIBLICAL HILLS & MOUNTAINS

▲ NEBO  
DEUT. 34:1-4

▲ ARARAT  
GENESIS 8:4

▲ MORIAH  
2 CHRONICLES 3:1

▲ BASHAN  
ISAIAH 33:9

▲ OLIVES  
JOHN 8:1

▲ SKULL  
LUKE 23:33

▲ CARMEL  
1 KINGS 18:19

▲ EPHRAIM  
1 SAMUEL 1:1

▲ HOR  
NUMBERS 20:23

▲ HOREB  
EXODUS 3:1

▲ LEBANON  
2 KINGS 19:23

▲ SINAI  
EXODUS 19:18

▲ ZION  
PSALM 2:6

▲ PISGAH  
DEUTERONOMY 34:1

X	Y	Z	H	Q	Z	R	S	T
C	P	M	O	R	I	A	H	P
A	J	K	R	W	O	V	U	I
R	L	E	B	A	N	O	N	S
M	L	M	N	C	O	Q	R	G
E	P	H	R	A	I	M	B	A
L	S	K	U	L	L	E	A	H
A	E	F	H	V	G	H	S	X
N	S	I	N	A	I	O	H	Y
E	K	L	A	R	A	R	A	T
B	M	O	P	Y	O	E	N	Q
O	L	I	V	E	S	B	R	Z

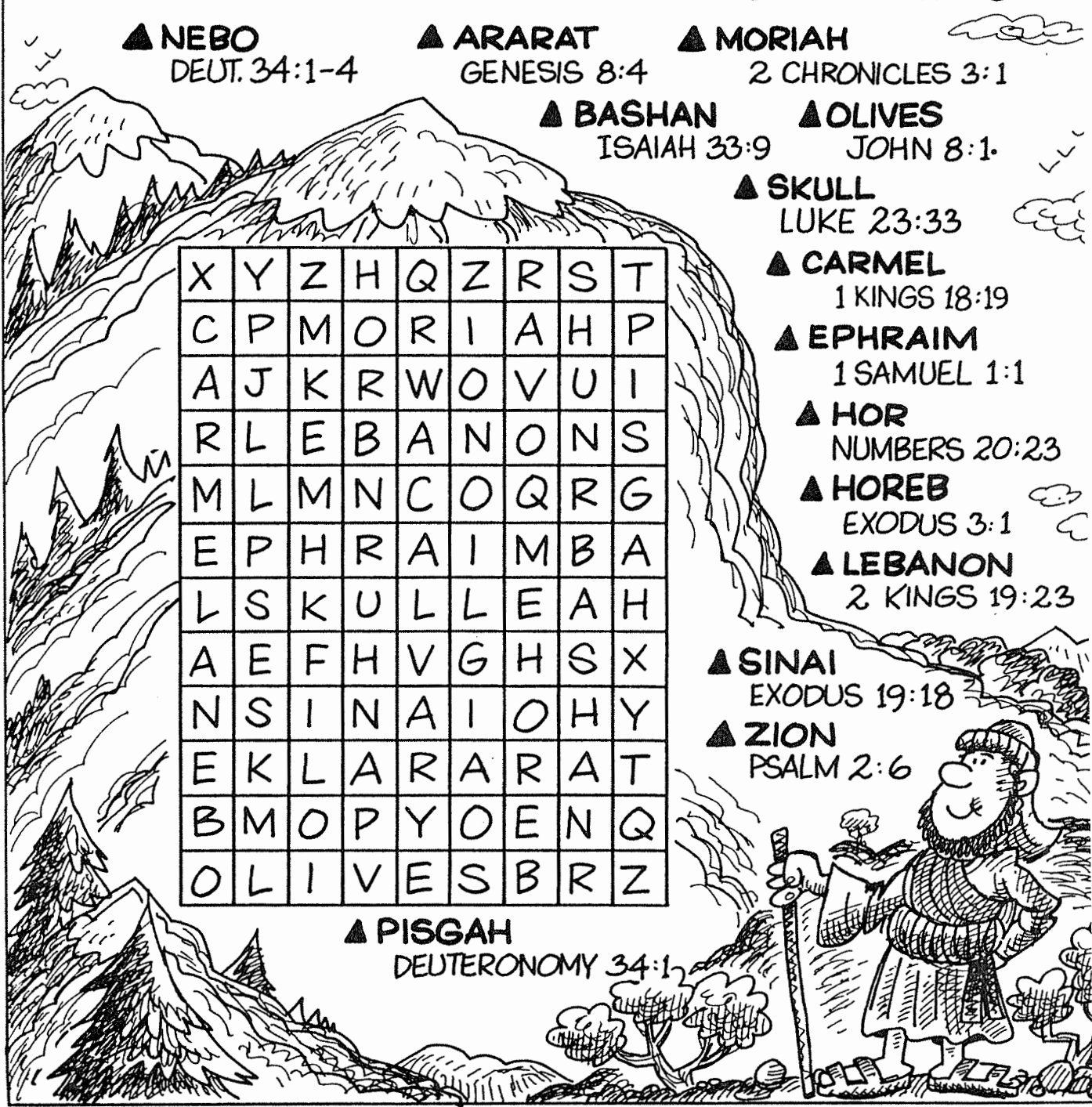



## **Year 1**

### **Week 51**

### **Rahab Helps The Israelites**

**Scriptures: Joshua 2, 3, and 4**

**Key Verse: Joshua 4:23 For the Lord your God dried up the waters of the Jordan before you until you had crossed over, as the Lord your God did to the Red Sea, which He dried up before us until we had crossed over.**

#### **Key Points:**

- 1.** Joshua sent 2 spies ahead into Jericho who hid at Rahab's house on the city wall. The Israelites were ready to drive out the people from Jericho. She sent them to the mountains for safety.
- 2.** Rahab asked the spies to spare her and her family when the Israelites conquered Jericho. The spies agreed IF the family stayed in her house and IF they placed a scarlet cord in the window.
- 3.** The spies returned to Joshua and told him Rahab said the people of Jericho were fainthearted because of the Israelites' fame regarding their deliverance from Egypt.
- 4.** As the people crossed the Jordan river into Jericho, the priests led the way bearing the ark of the covenant. The priests entered the water of the Jordan river and instantly the waters stood up in a heap before the ark of the covenant. The people all crossed the Jordan on dry ground. When everyone had passed over, Joshua commanded the priests to exit the Jordan river and the waters returned to normal.
- 5.** Joshua instructed them that one man from each of the 12 tribes was to pick up a stone from the dry riverbed as he crossed. This heap of stones was to be a memorial to the people and their children. When they saw the heap of 12 stones, they were to remember how God allowed the waters to be cut-off before the ark of the covenant (the water stood in a heap) so they could cross Jordan on dry ground.



Rahab Hiding the Spies

# RAHAB AND THE SPIES

(JOSHUA 2)



"Then she let them down by a cord through the window: for her house was upon the town wall, and she dwelt upon the wall."

**JOSHUA 2:15**

# DROPPING TO SAFETY

Joshua 2

2.

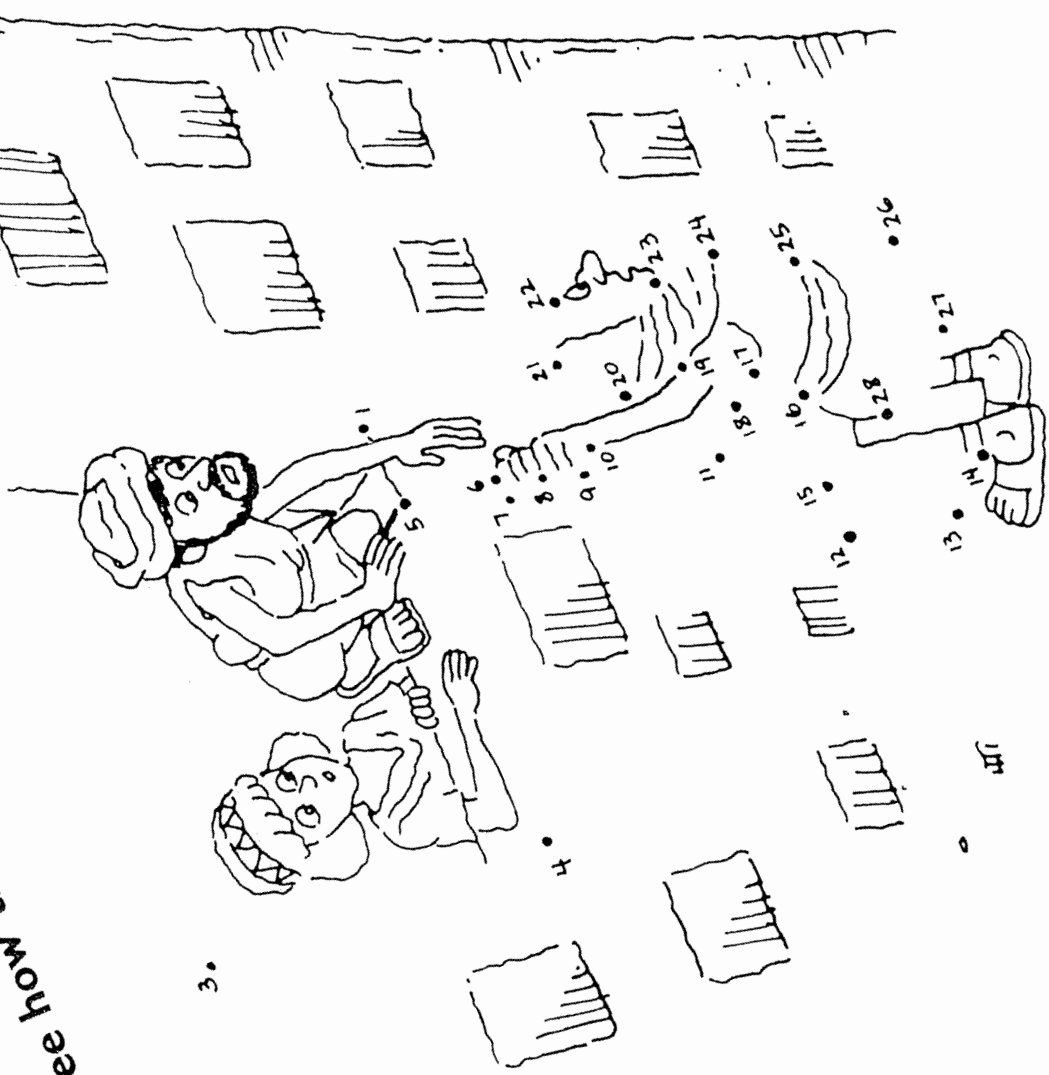

3.

Rahab hid the two spies from the soldiers. Then she helped them escape from the city.

# Rahab

Rahab helped two Israelite spies hide and later escape from her house in Jericho.

The following words were taken from Joshua 2. Find and circle them in the word search.

JOSHUA  
NUN  
SENT  
SPY  
JERICHO  
RAHAB

JORDAN  
SWEAR  
LORD  
SAVE  
HIDE  
WALL

KING  
ISRAEL  
TWO  
GATE  
ROOF

CORD  
SCARLET  
OATH  
STALKS  
FLAX

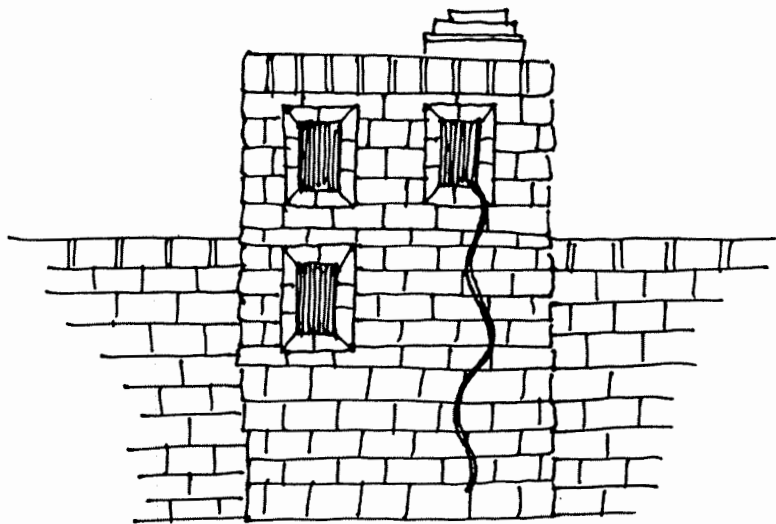

S L K I N G B O S I F T  
E W O S P Y A J Q O L S  
L J E R I C H O O Y A K  
L O M A D E A R P V X L  
A S S E R T R D E L I A  
W H E L H S C A R L E T  
N U N E D I H N U S W S  
G A T E L L O D R O C I

# RAHAB AND THE SPIES

(JOSHUA 2)

A H T A O B P N B Z X Q Q J I  
 Z T J C D Z H V I R P I J Z Q  
 S D M P R F Z Q A A A W B Z D  
 D Y F M E H I T M U U H B K J  
 C H O H C I R E J A E H A C Q  
 J O O B D N V A L N S Z S B R  
 F U R O U G V Q T F O O R O I  
 L Q G D W X B F Y M G K R T J  
 A D E R E V I L E D D L B I L  
 X S P Y J G Q H L G E E R O S  
 Q P P N N Y Y P I F P A E T T  
 D I O M S R P J O H E R F A F  
 K I N D N E S S V P Z S J N A  
 I L H H Z Q E T O A C I T R Y  
 K S O L K I L R Q W C K E P Y

CORD  
 DELIVERED  
 FLAX  
 GOD  
 HID

ISRAEL  
 JERICHO  
 JOSHUA  
 KINDNESS  
 OATH

RAHAB  
 ROOF  
 ROPE  
 SPY

WRITE DOWN THE LETTERS AS YOU COME TO THEM ON THE LINES BELOW

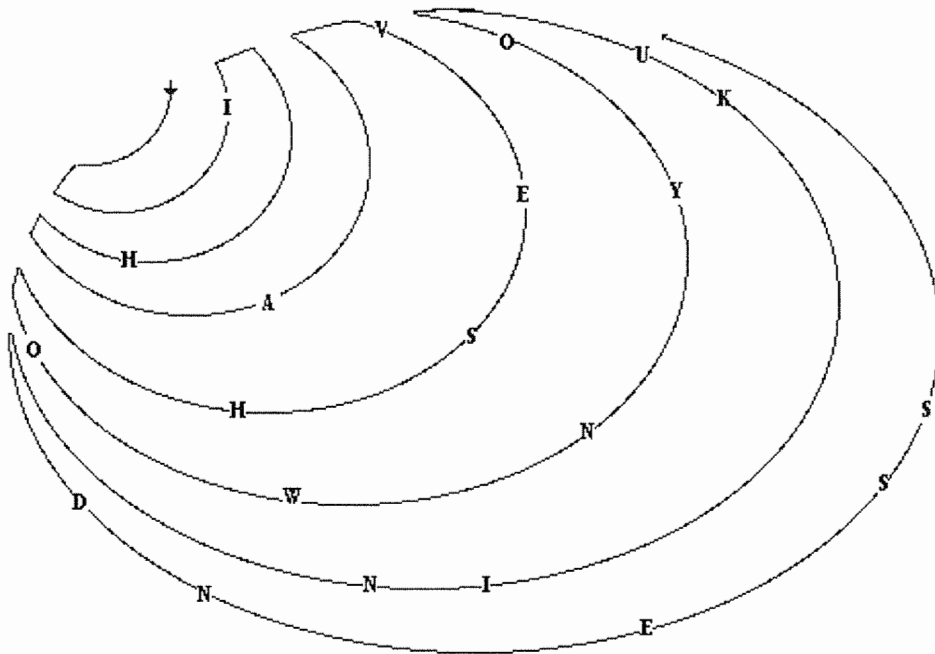

-----

# RAHAB AND THE SPIES

## (JOSHUA 2)

### MEMORY VERSE:

"And they said to Joshua, 'Truly the Lord has delivered all the land into our hands, for indeed all the inhabitants of the country are fainthearted because of us.' " JOSHUA 2:24

### TRUE OR FALSE:

1. "Now Joshua the son of Nun sent out two men from Acacia Grove to spy secretly, saying, 'Go, view the land, especially Jericho.' " JOSHUA 2:1

TRUE OR FALSE

### FILL IN THE BLANKS:

2. "The king of Jericho sent to \_\_\_\_\_, saying, 'Bring out the men who have come to you, who have entered your \_\_\_\_\_, for they have come to search out all the country.' " JOSHUA 2:3
3. "Then the woman took the two men and \_\_\_\_\_ them; and she said, 'Yes, the men came to me, but I did not know where they were from.' " JOSHUA 2:4
4. "She had brought them up to the \_\_\_\_\_ and hidden them with the stalks of \_\_\_\_\_, which she had laid in order on the \_\_\_\_\_." JOSHUA 2:6
5. Rahab said to the two men, "Now therefore, I beg you, swear to me by the LORD, since I have shown you \_\_\_\_\_, that you also will show \_\_\_\_\_ to my father's house, and give me a true token, and spare my father, my mother, my brothers, my sisters, and all that they have, and deliver our lives from death." JOSHUA 2:12-13

### TRUE OR FALSE:

6. "She let them down by a rope through the window, for her house was on the city wall; she dwelt on the wall." JOSHUA 2:15

TRUE OR FALSE

### CIRCLE THE CORRECT WORDS:

7. "Then the men said to her: 'We will be blameless of this oath of yours which you have made us swear, unless, when we come into the land, you bind this line of (**scarlet, orange**) cord in the window through which you let us down, and unless you bring your father, your mother, your brothers, and all your father's (**money, household**) to your own home. So shall it be that whoever goes outside the doors of your house into the street, his blood shall be on his own head, and we will be guiltless. And whoever is with you in the house, his blood shall be on our head if a hand is laid on him.' " JOSHUA 2:17-19

### TRUE OR FALSE:

8. "And Joshua spared Rahab the harlot, her father's household, and all that she had. So she dwells in Israel to this day, because she hid the messengers whom Joshua sent to spy out Jericho." JOSHUA 2:25

TRUE OR FALSE

### FILL IN THE BLANKS:

9. "Salmon begot Boaz by \_\_\_\_\_, Boaz begot Obed by Ruth, Obed begot Jesse, and Jesse begot \_\_\_\_\_." MATTHEW 1:5-6

# RAHAB AND THE SPIES

## (JOSHUA 2)

### MEMORY VERSE:

"And they said to Joshua, 'Truly the Lord has delivered all the land into our hands, for indeed all the inhabitants of the country are fainthearted because of us.'" JOSHUA 2:24

### TRUE OR FALSE:

1. "Now Joshua the son of Nun sent out two men from Acacia Grove to spy secretly, saying, 'Go, view the land, especially Jericho.'" JOSHUA 2:1

TRUE OR FALSE

### FILL IN THE BLANKS:

2. "The king of Jericho sent to \_\_\_\_\_, saying, 'Bring out the men who have come to you, who have entered your \_\_\_\_\_, for they have come to search out all the country.'" JOSHUA 2:3

### CIRCLE THE CORRECT WORDS:

3. "Then the woman took the two men and (**FED, HID**) them; and she said, 'Yes, the men came to me, but I did not (**KNOW, CARE**) where they were from.'" JOSHUA 2:4
4. "She had brought them up to the (**roof, kitchen**) and hidden them with the stalks of (**WAX, FLAX**), which she had laid in order on the (**FLOOR, ROOF**).'" JOSHUA 2:6
5. Rahab said to the two men, "Now therefore, I beg you, swear to me by the LORD, since I have shown you (**EVIL, KINDNESS**), that you also will show kindness to my (**FATHER'S, UNCLE'S**) house, and give me a true token, and spare my father, my mother, my brothers, my sisters, and all that they have, and deliver our lives from death." JOSHUA 2:12-13

### TRUE OR FALSE:

6. "She let them down by a rope through the window, for her house was on the city wall; she dwelt on the wall." JOSHUA 2:15

TRUE OR FALSE

### CIRCLE THE CORRECT WORDS:

7. "Then the men said to her: 'We will be blameless of this oath of yours which you have made us swear, unless, when we come into the land, you bind this line of (**SCARLET, ORANGE**) cord in the window through which you let us down and unless you bring your father, your mother, your brothers, and all your father's (**MONEY, HOUSEHOLD**) to your own home. So shall it be that whoever goes outside the doors of your house into the street, his blood shall be on his own head, and we will be guiltless. And whoever is with you in the house, his blood shall be on our head if a hand is laid on him.'" JOSHUA 2:17-19

### TRUE OR FALSE:

8. "And Joshua spared Rahab the harlot, her father's household, and all that she had. So she dwells in Israel to this day, because she hid the messengers whom Joshua sent to spy out Jericho." JOSHUA 6:25

TRUE OR FALSE

**"Salmon begot Boaz by Rahab, Boaz begot Obed by Ruth, Obed begot Jesse, and Jesse begot David the king." MATTHEW 1:5-6**



# RAHAB AND THE SPIES

(JOSHUA 2)

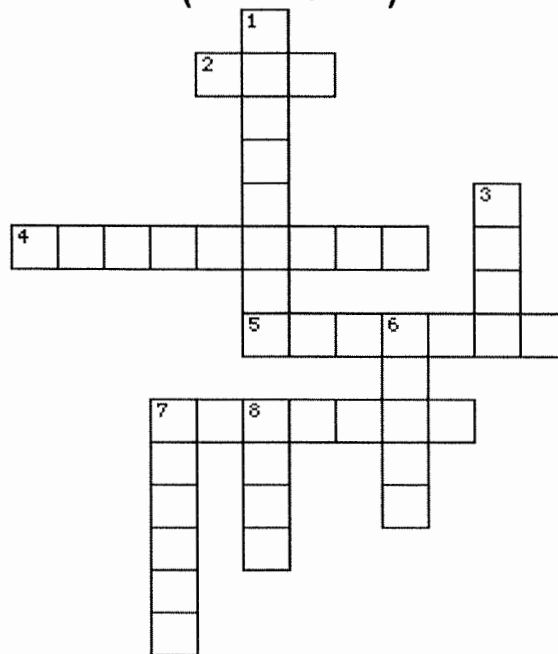

- 4 ACROSS "And they said to Joshua, 'Truly the Lord has \_\_\_\_\_ all the land into our hands, for indeed all the inhabitants of the country are fainthearted because of us.' " **JOSHUA 2:24**
- 7 ACROSS "Now Joshua the son of Nun sent out two men from Acacia Grove to spy secretly, saying, 'Go, view the land, especially \_\_\_\_\_.'" **JOSHUA 2:1**
- 6 DOWN "The king of Jericho sent to \_\_\_\_\_, saying, 'Bring out the men who have come to you, who have entered your house, for they have come to search out all the country.'" **JOSHUA 2:3**
- 2 ACROSS "Then the woman took the two men and \_\_\_\_\_ them; and she said, 'Yes, the men came to me, but I did not know where they were from.'" **JOSHUA 2:4**
- 8 DOWN "She had brought them up to the roof and hidden them with the stalks of flax, which she had laid in order on the \_\_\_\_\_." **JOSHUA 2:6**
- 1 DOWN Rahab said to the two men, "Now therefore, I beg you, swear to me by the LORD, since I have shown you \_\_\_\_\_, that you also will show kindness to my father's house, and give me a true token, and spare my father, my mother, my brothers, my sisters, and all that they have, and deliver our lives from death." **JOSHUA 2:12-13**
- 3 DOWN "She let them down by a \_\_\_\_\_ through the window, for her house was on the city wall; she dwelt on the wall." **JOSHUA 2:15**
- 5 ACROSS "Then the men said to her: 'We will be blameless of this oath of yours which you have made us swear, unless when we come into the land, you bind this line of \_\_\_\_\_ cord in the window through which you let us down " **JOSHUA 2:17-18**
- 7 DOWN "And Joshua spared Rahab the harlot, her father's household, and all that she had. So she dwells in Israel to this day, because she hid the messengers whom \_\_\_\_\_ sent to spy out Jericho." **JOSHUA 6:25**

# RAHAB AND THE SPIES

## (JOSHUA 2)

B O O T T W I J T Y V Y U U A H L I U J B I B U T  
 Y J S Y C Q M K T F B M F W D J O U Q T N Z T C C  
 K Q L O J M A S D O G A L Q Y Y U M T W H F P Q M  
 P S K E W F F M R E C S C A R L E T C O R D Z N P  
 U P P A Y I A A R J R S Y N S K I F P K X Z F R M  
 Y O W V J T H I R W Z E H I D P I H T A O M V U L  
 R M V C T A F J N S H V V I M G B O L M F O O R C  
 F B J A B A T T W T K Y H I B K R E J L A D F K S  
 K B X L N L Q A P S H K P S L G W P B U U K H B G  
 T O W O A B H A N I K E O V P E G K J E V X N I E  
 G H E Z F L A X K A O W A U S P D J H S A U E F Y  
 E S L M S Z A U B G R H I R E S T F T U E Y E W U  
 Y S V F L Z Y E C W E L C U T D K Y J O I E M L W  
 G R I M P N P N D A N W R I J E O T Y H S E J J I  
 M V D S U K S Q W F C W F A R O D G R S G J Q B A  
 Q N D Q R O U M N M V Z Y D M E W W D R J A V B C  
 H G Z S T A U N I T C O Z D G T J U C E P V E K L  
 V D Z Q N B E A E O A U H S O J S G G H Z M V J P  
 V P O V D H T L P M C A D W O W S H S T F U V K A  
 G K W P R F T Y I J H K F T V I E P Q A B O L U I  
 S S H B A V D Q Y K R U B L S H N V U F N Z A M E  
 N P Q Q Z I D U B G E N E A P J D S M G K F I X Y  
 B P I J E O Q Q B H M U H O T D N U J C M A L Y A  
 K R L I M N C T P G Q D T A W U I X Q V Z M R A Q  
 K P H C D H U H P D N L L P B O K H L U M Z U T X

- |                       |                |                 |                     |
|-----------------------|----------------|-----------------|---------------------|
| <b>DELIVERED</b>      | <b>GOD</b>     | <b>JOSHUA</b>   | <b>ROOF</b>         |
| <b>FAINTHEARTED</b>   | <b>HID</b>     | <b>KINDNESS</b> | <b>ROPE</b>         |
| <b>FATHER'S HOUSE</b> | <b>ISRAEL</b>  | <b>OATH</b>     | <b>SCARLET CORD</b> |
| <b>FLAX</b>           | <b>JERICHO</b> | <b>RAHAB</b>    | <b>SPY</b>          |

WRITE DOWN THE LETTERS AS YOU COME TO THEM ON THE LINES BELOW

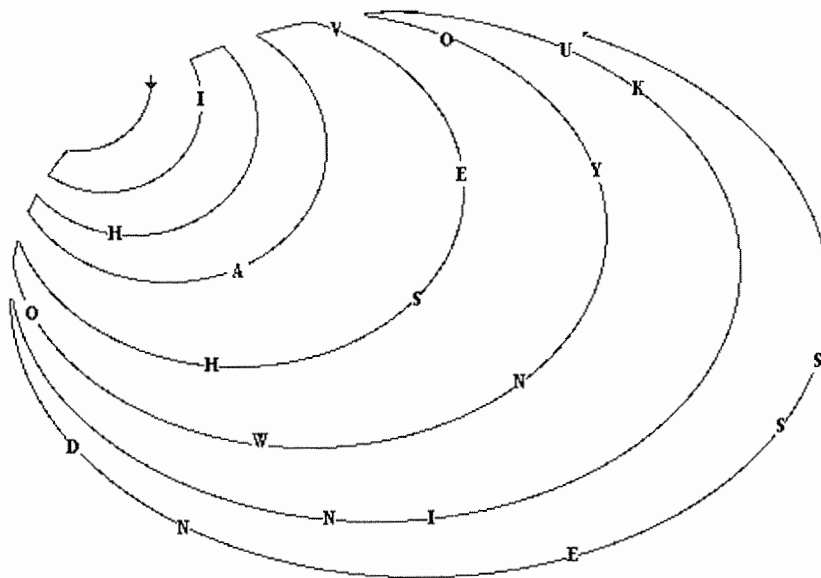

-----

# The Reason

The Lord caused the Red Sea to part and the Jordan River to stop flowing so the Israelites could cross over on dry ground. Use your calculators to find the square root of each number to discover the special reason why God performed such marvelous deeds.

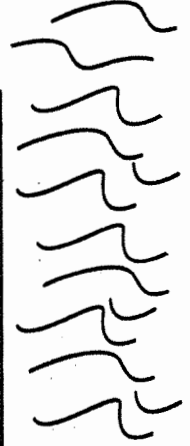
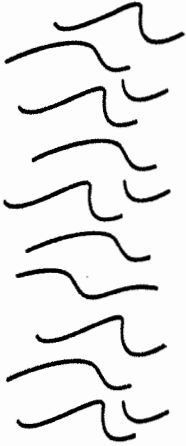

A	B	D	E	F	G	H	I	K	L
121	289	400	100	576	784	169	729	441	225
M	N	O	P	R	S	T	U	W	Y
484	196	841	361	256	529	676	144	625	324

$\overline{13 \ 10}$      $\overline{20 \ 27 \ 20}$      $\overline{26 \ 13 \ 27 \ 23}$      $\overline{23 \ 29}$      $\overline{26 \ 13 \ 11 \ 26}$      $\overline{11 \ 15 \ 15}$

$\overline{26 \ 13 \ 10}$      $\overline{19 \ 10 \ 29 \ 19 \ 15 \ 10 \ 23}$      $\overline{29 \ 24}$      $\overline{26 \ 13 \ 10}$      $\overline{10 \ 11 \ 16 \ 26 \ 13}$

$\overline{22 \ 27 \ 28 \ 13 \ 26}$      $\overline{21 \ 14 \ 29 \ 25}$      $\overline{26 \ 13 \ 11 \ 26}$      $\overline{26 \ 13 \ 10}$      $\overline{13 \ 11 \ 14 \ 20}$

$\overline{29 \ 24}$      $\overline{26 \ 13 \ 10}$      $\overline{15 \ 29 \ 16 \ 20}$      $\overline{27 \ 23}$      $\overline{19 \ 29 \ 25 \ 10 \ 16 \ 24 \ 12 \ 15}$

$\overline{11 \ 14 \ 20}$      $\overline{23 \ 29}$      $\overline{26 \ 13 \ 11 \ 26}$      $\overline{18 \ 29 \ 12}$      $\overline{22 \ 27 \ 28 \ 13 \ 26}$

$\overline{11 \ 15 \ 25 \ 11 \ 18 \ 23}$      $\overline{24 \ 10 \ 11 \ 16}$      $\overline{26 \ 13 \ 10}$      $\overline{15 \ 29 \ 16 \ 20}$

$\overline{18 \ 29 \ 12 \ 16}$      $\overline{28 \ 29 \ 20}$

**Year 1**

**Week 52**

## **Walls Of Jericho**

**Scriptures: Joshua 6, 7, and 8**

**Key Verses: Joshua 6:20** So the people shouted when the priests blew the trumpets. And it happened when the people heard the sound of the trumpet, and the people shouted with a great shout that the wall fell down flat. Then the people went up into the city, every man straight before him, and they took the city.

### **Key Points:**

1. Jericho was all closed up with no one going in or out, but God gave Jericho into the hands of Joshua and the Israelites .
2. The men of war of Israel marched once a day around the city walls for 6 days. Each day, seven priests each carried a trumpet of ram's horn before the ark of the covenant. On the seventh day, (with the armed men, priests and the ark of the covenant in the lead) they circled the city seven times. When the priests blew along blast on the trumpets the people shouted at Joshua's instruction. The walls fell in flat and they entered the city.
3. Rahab and all within her house were spared because she hid the two spies. All the other inhabitants were killed and Jericho was burned with fire.
4. Achan took some accursed things instead of giving the silver, gold, bronze, and iron to the Lord. He and his household were killed because of their sin.
5. The Israelites had 36 people killed in their next battle (the first attempt to capture the city of Ai) because of Achan's sin. The second attempt on Ai was successful as God gave them the city.



Joshua at Jericho  
*Joshua 5, 6*

Cut two ram's horns per child from tagboard. Punch holes as indicated. Do two horns at once so the holes will match. Tie one end of a piece of yarn through the two horns. Dip the other end of the yarn in white glue, twist to a point, and allow to dry. Let the children decorate their horns before sewing them. Leave the large end open so the horn can be stuffed with tissue paper or newspaper.

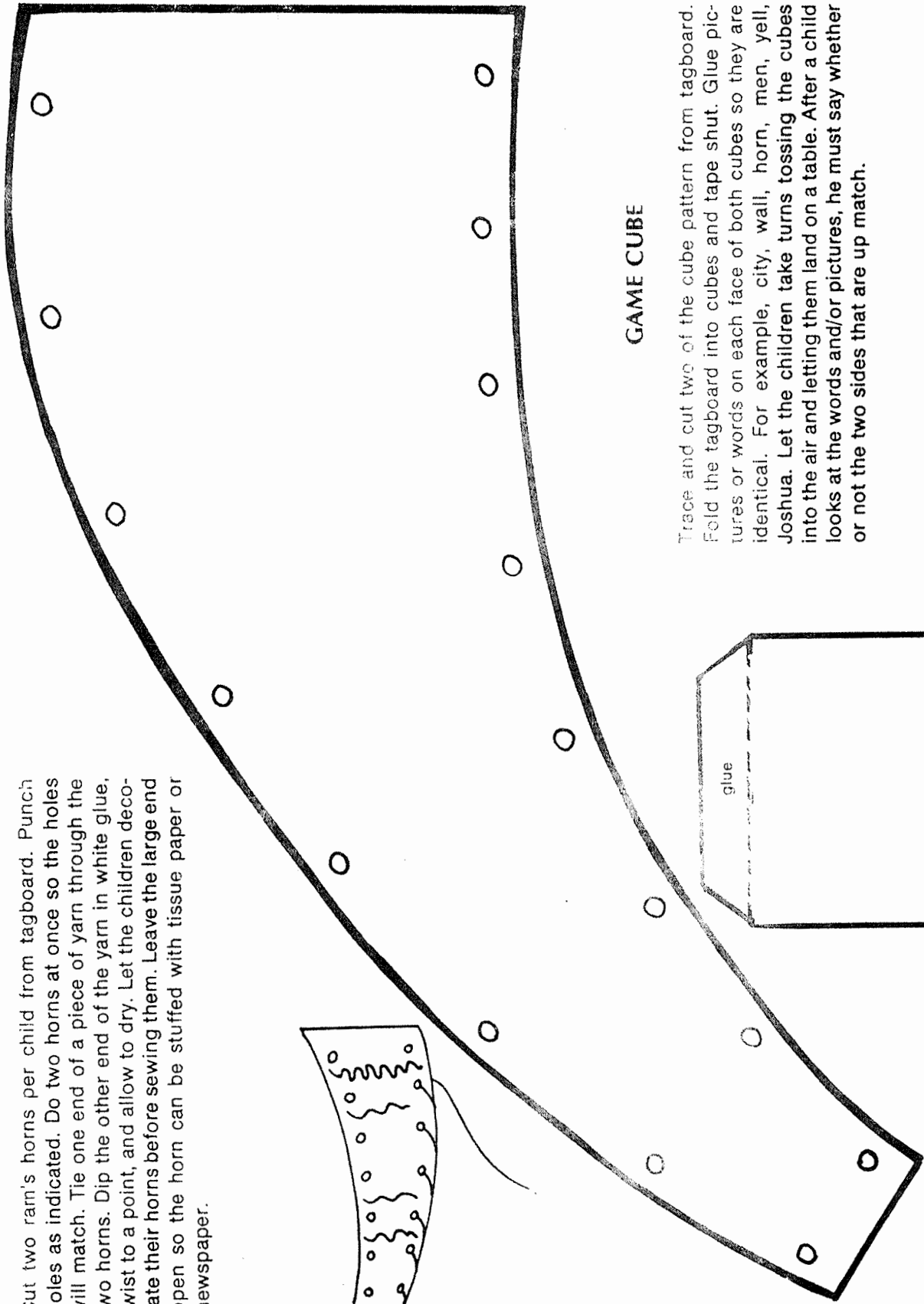
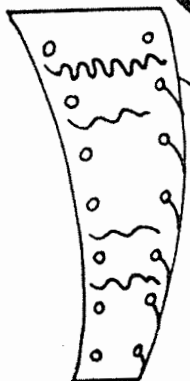

GAME CUBE

Trace and cut two of the cube pattern from tagboard. Fold the tagboard into cubes and tape shut. Glue pictures or words on each face of both cubes so they are identical. For example, city, wall, horn, men, yell, Joshua. Let the children take turns tossing the cubes into the air and letting them land on a table. After a child looks at the words and/or pictures, he must say whether or not the two sides that are up match.

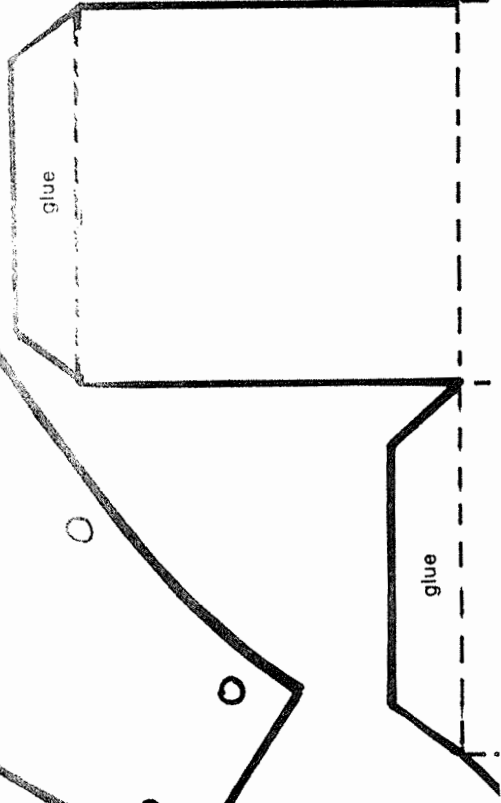



# EXODUS 14

SLWAL     

ESRSOH   

RWEOP    

TIOHCAR  

TNAVERS  



MOSES USED THESE WEAPONS AGAINST THE EGYPTIANS:

AND

# JOSHUA 6:1-21

VESEN     

DOUL     

HCARM    

HUASOJ   

TICY      



WHY THE WALLS OF JERICHO CAME TUMBLING DOWN:

THE      OF



## Key

### Exodus 14

Walls	W A
Horses	E S
Power	W E
Chariot	A
Servant	R V T

### WATER and WAVES

### Joshua 6

Seven	S N
Loud	O U D
March	M C
Joshua	S U
City	I

### The SOUND of MUSIC



To find the answers to this puzzle, start at the circled letter and move, one letter at a time, in the direction shown by the arrows. Read Joshua 6 to find out more about the story. Who did God call to lead the Israelites after Moses died?

J \_\_\_\_\_  
 ↙ ↑ → → →

What city did the Israelites march around for 6 days?

J \_\_\_\_\_  
 → ↙ ↘ ← ↑ →

What did seven priests carry in front of the ark?

T \_\_\_\_\_  
 → ↓ ↗ ↘ ↓ → ↓

How many times did the people march around the city on the seventh day?

S \_\_\_\_\_  
 ↙ ↘ ← ↗

What did the people do when the priests sounded the trumpet blast?

S \_\_\_\_\_  
 ← ↓ ← ← ↑ ↑

What did the wall of the city do when the people shouted?

C \_\_\_\_\_  
 ↘ → ↓ → → ↓ ← ←

		Ⓣ	R	M	
	S	H	U	A	P
H	O	R	D	N	E
Ⓢ	I	Ⓝ	E	V	Ⓣ
	O	L	T	U	O
		L	A	P	
		D	E	S	



# THE BATTLE OF JERICHO

(JOSHUA 6:1-26)

G A U H S O J A E U W D R L C  
D W K K R R Y Z A B U L L A F  
E Z E L L A W S A L U R G L U  
P S H O U T Y H N R E R N M M  
Z K S Y A D X I S E K A N S D  
C K P C P I O M W W V C R E L  
R Q J T I L F L L D F I G S D  
A J T I Q S V S Z W I G G Z I  
H S E M I T N E V E S O Z F S  
A B E O D R O L P Y M H J P V  
B B J T D T L V P P G C P G R  
C R Z A J F S O J Z Y I N K C  
T R U M P E T S H W P R U B M  
Q B Z N Q A V J G B Y E O U L  
I H C R A M M J E M B J F T B

ARK  
BURNED  
FALL  
GIVEN  
ISRAEL

JERICHO  
JOSHUA  
LORD  
MARCH  
RAHAB

SEVEN TIMES  
SHOUT  
SIX DAYS  
TRUMPETS  
WALL

## SOUND THE TRUMPET!

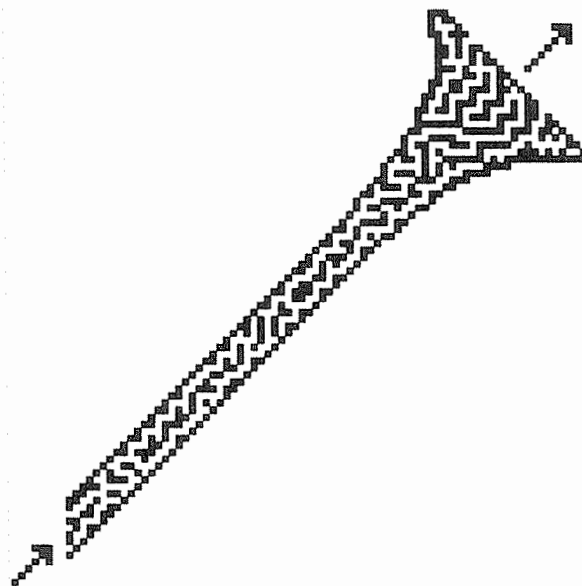

# BATTLE OF JERICHO

## (JOSHUA 6:1-26)

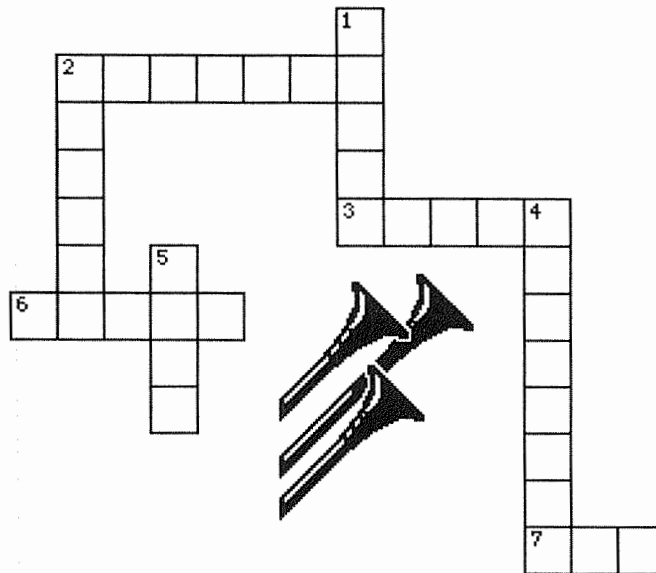

- 2 ACROSS "And the LORD, said to Joshua: 'See! I have given \_\_\_\_\_ into your hand, its king, and the mighty men of valor.' " **JOSHUA 6:2**
- 7 ACROSS "You shall march around the city, all you men of war; you shall go around the city once. This you shall do \_\_\_\_\_ days." **JOSHUA 6:3**
- 4 DOWN "But the seventh day you shall march around the city seven times, and the priest shall blow the \_\_\_\_\_." **JOSHUA 6:4**
- 1 DOWN Joshua told the priest, "Take up the ark of the covenant and let seven priests bear seven trumpets of rams' \_\_\_\_\_ before the ark of the LORD." **JOSHUA 6:6**
- 3 ACROSS "Now Joshua had commanded the people, saying, 'You shall not shout or make any noise with your voice, nor shall a word proceed out of your mouth, until the day I say to you, "\_\_\_\_\_"! Then you shall shout.' " **JOSHUA 6:10**
- 5 DOWN "So the people shouted when the priests blew their trumpets. And it happened when the people heard the sound of the trumpet, and the people shouted with a great shout, that the \_\_\_\_\_ fell down flat. Then the people went up into the city, every man straight before him, and they took the city." **JOSHUA 6:20**
- 6 ACROSS "And Joshua spared \_\_\_\_\_ the harlot, her father's household, and all that she had. So he dwells in Israel to this day, because she hid the messengers whom Joshua sent to spy out Jericho." **JOSHUA 6:25**
- 2 DOWN "So the LORD was with \_\_\_\_\_, and his fame spread throughout all the country." **JOSHUA 6:27**

# BATTLE OF JERICHO

## (JOSHUA 6:1-26)

### MEMORY VERSE:

*"And the LORD, said to Joshua: 'See! I have given Jericho into your hand, its king, and the mighty men of valor.' "* JOSHUA 6:2

### CIRCLE THE CORRECT WORDS:

1. *"And the LORD, said to \_\_\_\_\_ 'See! I have given Jericho into your hand, its king, and the mighty men of valor.' "* JOSHUA 6:2  
JOSHUA      MOSES
2. "You shall march around the city, all you men of war; you shall go around the city once. This you shall do \_\_\_\_\_ days." JOSHUA 6:3  
SIX              SIXTY
3. "But the seventh day you shall march around the city seven times, and the priest shall blow the \_\_\_\_\_." JOSHUA 6:4  
FLUTES      TRUMPETS

### TRUE OF FALSE:

4. Joshua told the priest, "Take up the ark of the covenant and let seven priests bear seven trumpets of rams' horns before the ark of the LORD." JOSHUA 6:6  
TRUE OR FALSE
5. "Now Joshua had commanded the people, saying, 'You shall not shout or make any noise with your voice, nor shall a word proceed out of your mouth, until the day I say to you, "Whisper"! Then you shall whisper.' " JOSHUA 6:10  
TRUE OR FALSE

### CIRCLE THE CORRECT WORDS:

6. "So the people ( **WHISPERED**, **SHOUTED** ) when the priests blew their trumpets. And it happened when the people heard the sound of the trumpet, and the people ( **WHISPERED**, **SHOUTED** ) with a great ( **WHISPER**, **SHOUT** ), that the wall fell down flat. Then the people went up into the city, every man straight before him, and they took the city." JOSHUA 6:20
7. "And Joshua spared ( **BABAH**, **RAHAB** ) the harlot, her father's household, and all that she had. So she dwells in Israel to this day, because she hid the messengers whom Joshua sent to spy out Jericho." JOSHUA 6:25

### TRUE OF FALSE:

8. "So the LORD was with Joshua, and his fame spread throughout all the country." JOSHUA 6:27  
TRUE OR FALSE

# BATTLE OF JERICHO

## (JOSHUA 6:1-26)

### MEMORY VERSE:

*"And the LORD, said to Joshua: 'See! I have given Jericho into your hand, its king, and the mighty men of valor.' "* JOSHUA 6:2

### FILL IN THE BLANKS:

1. "And the LORD, said to \_\_\_\_\_ : 'See! I have given Jericho into your hand, its king, and the mighty men of valor.' " JOSHUA 6:2
2. "You shall march around the city, all you men of war; you shall go around the city once. This you shall do \_\_\_\_\_ days." JOSHUA 6:3
3. "But the seventh day you shall march around the city seven times, and the priest shall blow the \_\_\_\_\_." JOSHUA 6:4

### TRUE OF FALSE:

4. Joshua told the priest, "Take up the ark of the covenant and let seven priests bear seven trumpets of rams' horns before the ark of the LORD." JOSHUA 6:6  
**TRUE OR FALSE**
5. "Now Joshua had commanded the people, saying, 'You shall not shout or make any noise with your voice, nor shall a word proceed out of your mouth, until the day I say to you, "Whisper"! Then you shall whisper.' " JOSHUA 6:10  
**TRUE OR FALSE**

### FILL IN THE BLANKS:

6. "So the people \_\_\_\_\_ when the priests blew their trumpets. And it happened when the people heard the sound of the trumpet, and the people shouted with a great shout, that the wall fell down flat. Then the people went up into the city, every man straight before him, and they \_\_\_\_\_." JOSHUA 6:20
7. "And Joshua spared \_\_\_\_\_ the harlot, her father's household, and all that she had. So she dwells in Israel to this day, because she hid the messengers whom Joshua sent to spy out Jericho." JOSHUA 6:25

### TRUE OF FALSE:

8. "So the LORD was with Joshua, and his fame spread throughout all the country." JOSHUA 6:27  
**TRUE OR FALSE**

# YOU SOLVE IT!

1. Answer all of the definitions you can. 2. Transfer the letters of the words to the solution blanks according to matching numbers.

## DEFINITIONS

To do as we are commanded

○ \_\_\_\_\_  
47 1 45 67

A fight between soldiers

\_\_\_\_\_ \_\_\_\_\_  
56 66 6 8 27 36

Men who fight wars

\_\_\_\_\_ \_\_\_\_\_ \_\_\_\_\_ \_\_\_\_\_  
60 57 28 54 21 53 20 15

The winning of a battle

\_\_\_\_\_ \_\_\_\_\_ \_\_\_\_\_  
62 5 22 59 30 37 41

Loyal

\_\_\_\_\_ \_\_\_\_\_ \_\_\_\_\_ \_\_\_\_\_  
17 4 21 38 39 34 58 14

A hole dug for water

\_\_\_\_\_ \_\_\_\_\_ \_\_\_\_\_ \_\_\_\_\_  
11 40 13 28

A husband's companion

\_\_\_\_\_ \_\_\_\_\_ \_\_\_\_\_ \_\_\_\_\_  
42 5 3 43

Conquered

\_\_\_\_\_ \_\_\_\_\_ \_\_\_\_\_ \_\_\_\_\_ \_\_\_\_\_  
65 10 25 63 12 35 61 29

Leader in the battle of Jericho

\_\_\_\_\_ \_\_\_\_\_ \_\_\_\_\_ \_\_\_\_\_  
18 24 60 7 58 66

Man who hid a stolen treasure in his tent

\_\_\_\_\_ \_\_\_\_\_ \_\_\_\_\_ \_\_\_\_\_  
4 22 39 12 32

Promised land

\_\_\_\_\_ \_\_\_\_\_ \_\_\_\_\_ \_\_\_\_\_ \_\_\_\_\_  
46 33 64 55 50 32

Truthfulness

\_\_\_\_\_ \_\_\_\_\_ \_\_\_\_\_ \_\_\_\_\_ \_\_\_\_\_  
39 30 64 26 51 35 2

Ruler of Egypt

\_\_\_\_\_ \_\_\_\_\_ \_\_\_\_\_ \_\_\_\_\_ \_\_\_\_\_  
49 9 33 37 50 57 23

City where Israel lost a battle

\_\_\_\_\_ \_\_\_\_\_  
55 5

Leader before Joshua

\_\_\_\_\_ \_\_\_\_\_ \_\_\_\_\_ \_\_\_\_\_  
48 16 68 19 52

Bow down and \_\_\_\_\_ God

\_\_\_\_\_ \_\_\_\_\_ \_\_\_\_\_ \_\_\_\_\_ \_\_\_\_\_  
31 24 44 15 7 21 49

## SOLUTION

\_\_\_\_\_ \_\_\_\_\_ \_\_\_\_\_ \_\_\_\_\_ \_\_\_\_\_  
1 2 3 4 5 6 7

\_\_\_\_\_ \_\_\_\_\_ \_\_\_\_\_ \_\_\_\_\_ \_\_\_\_\_  
8 9 10 11 12 13 14 15

\_\_\_\_\_ \_\_\_\_\_ \_\_\_\_\_ \_\_\_\_\_ \_\_\_\_\_  
16 17 18 19 20 21 22 23 24

\_\_\_\_\_ \_\_\_\_\_ \_\_\_\_\_ \_\_\_\_\_ \_\_\_\_\_  
25 26 27 28 29 30 31 32

\_\_\_\_\_ \_\_\_\_\_ \_\_\_\_\_ \_\_\_\_\_ \_\_\_\_\_  
33 34 35 36 37 38 39 40 41

\_\_\_\_\_ \_\_\_\_\_ \_\_\_\_\_ \_\_\_\_\_  
42 43 44 45

○ \_\_\_\_\_  
46 47 48 49 50 51 52 53 54

\_\_\_\_\_ \_\_\_\_\_ \_\_\_\_\_ \_\_\_\_\_ \_\_\_\_\_  
55 56 57 58 59 60 61 62 63 64

\_\_\_\_\_ \_\_\_\_\_ \_\_\_\_\_ \_\_\_\_\_  
65 66 67 68

# Wall Breaker

A catapult was usually used to help break down the walls around a city. However, the children of Israel had a different kind of wall breaker. Solve the problems to discover the strange way the Israelites broke down the walls of Jericho.

**A.**  $(3 \times 4) + 2 =$

**C.**  $(6 \times 8) + 2 =$

**D.**  $(4 \times 9) + 7 =$

**E.**  $(9 \times 9) + 9 =$

**G.**  $(7 \times 3) + 4 =$

**H.**  $(5 \times 6) + 4 =$

**I.**  $(8 \times 5) + 7 =$

**K.**  $(6 \times 7) + 9 =$

**L.**  $(2 \times 5) + 1 =$

**M.**  $(3 \times 9) + 4 =$

**N.**  $(8 \times 9) + 3 =$

**O.**  $(4 \times 4) + 2 =$

**P.**  $(7 \times 5) + 4 =$

**R.**  $(9 \times 9) + 4 =$

**S.**  $(2 \times 7) + 7 =$

**T.**  $(8 \times 8) + 3 =$

**U.**  $(9 \times 6) + 2 =$

**V.**  $(4 \times 2) + 2 =$

**W.**  $(7 \times 6) + 3 =$

**Y.**  $(4 \times 6) + 5 =$

45 34 90 75

67 34 90

67 85 56 31 39 90 67 21

21 18 56 75 43 90 43

67 34 90

39 90 18 39 11 90

21 34 18 56 67 90 43

45 34 90 75

67 34 90

39 90 18 39 11 90

25 14 10 90

14

11 18 56 43

21 34 18 56 67

67 34 90

45 14 11 11

50 18 11 11 14 39 21 90 43

21 18

90 10 90 85 29

31 14 75

50 34 14 85 25 90 43

21 67 85 14 47 25 34 67

47 75

14 75 43

67 34 90 29

67 18 18 51

67 34 90

50 47 67 29



# 13. The Twelve Tribes of Israel

Each of the twelve tribes lived in a different area in Israel. Write the name of each tribe in the proper location on the map. The code and your Bible map will help you.

- x Asher
- ◇ Benjamin
- Ω Dan
- Ephraim
- Gad
- ∞ Issachar
- Σ Judah
- ≠ Manasseh
- + Naphtali
- √ Reuben
- » Simeon
- ± Zebulun

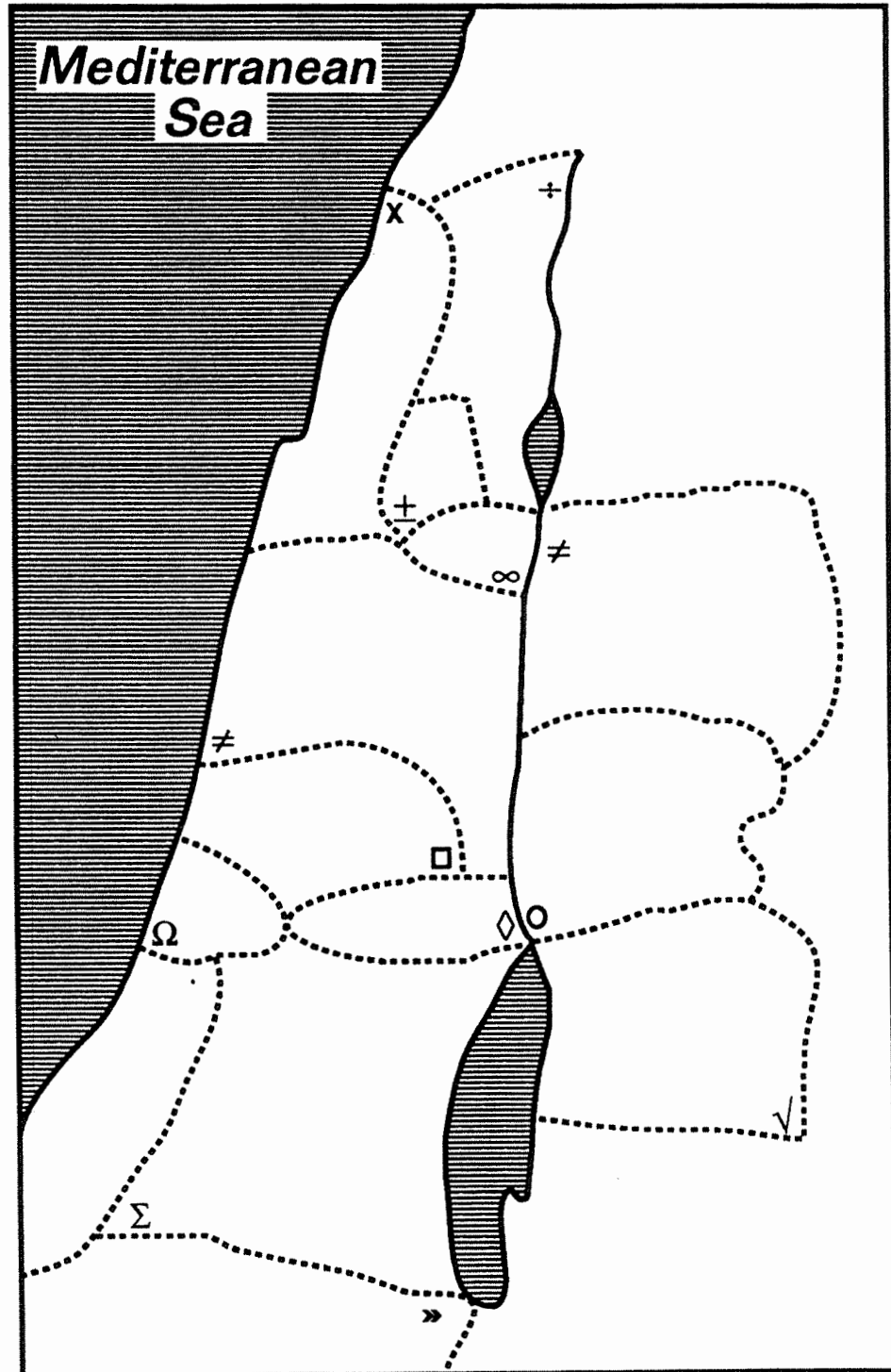

**Year 2**

**Week 53**

## **Gibeonites Fool Joshua**

**Scriptures: Joshua 9**

**Key Verse: Joshua 9:14** Then the men of Israel took some of their provisions; but they did not ask counsel of the LORD.

### **Key Points:**

1. The Gibeonites had heard about the God of Israel and they were afraid for their lives.
2. A group of Gibeonites went to see Joshua to try to make peace with the Israelites.
3. They lied to the Israelites, saying they had traveled from a great distance. Their worn out clothes, tattered wineskins and moldy bread made the lie seem possible.
4. The Israelites made an agreement with the Gibeonites without asking God.
5. Three days later, the Israelites realized they had been tricked.
6. The Israelites kept their promise not to harm the Gibeonites, and they became woodcutters and water carriers to serve Israel.

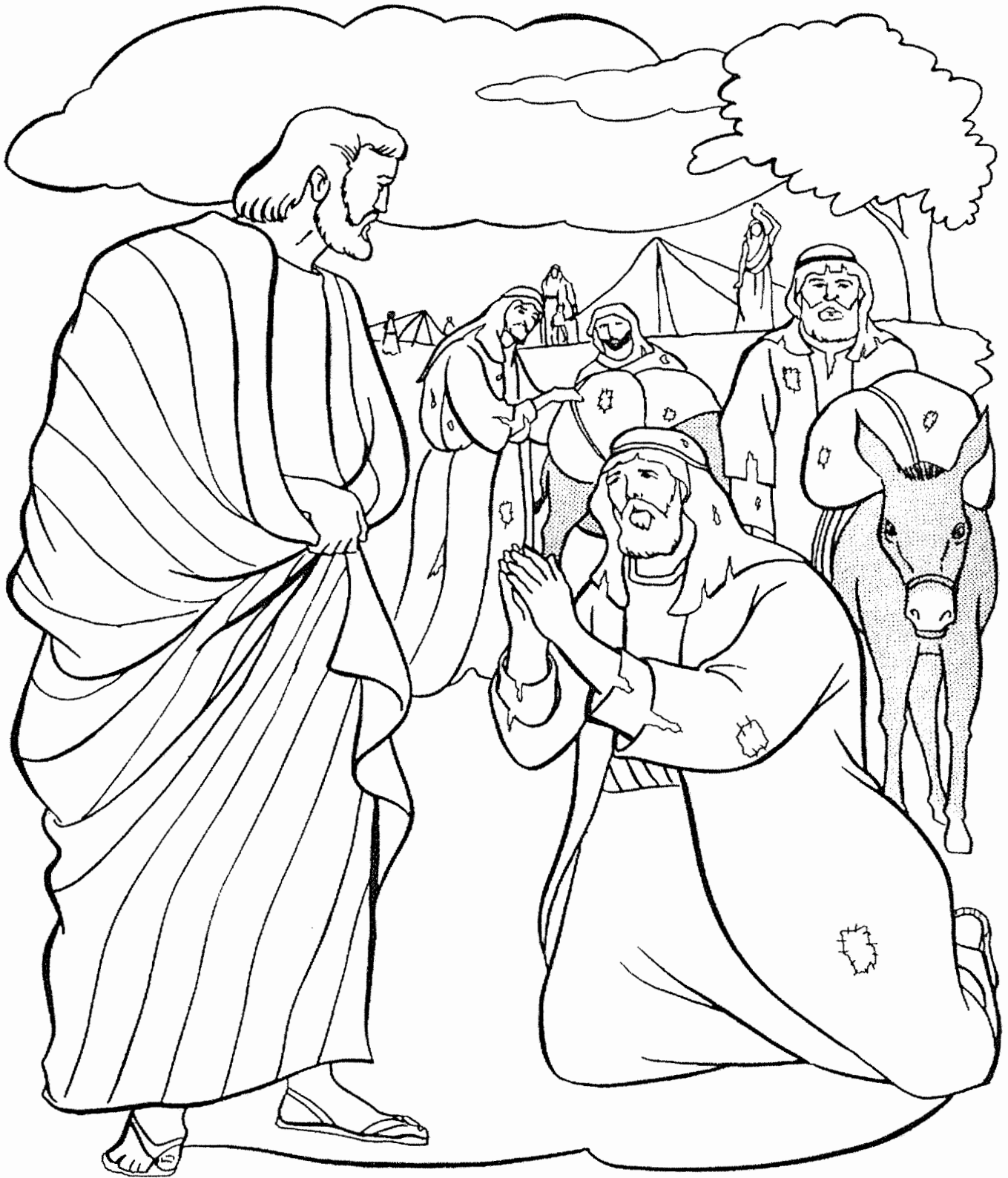

# The Gibeonites Deceive Joshua

# JOSHUA IS TRICKED

*Joshua 9:3-27*



*Some Gibeonite men dressed in ragged clothes trick Joshua*



# THE GIBEONITES TRICK JOSHUA

(JOSHUA 9)



“And when the inhabitants of Gibeon heard what Joshua had done unto Jericho and to Ai, They did work wily, and went and made as if they had been ambassadors, and took old sacks upon their donkeys, and wine bottles, old, and rent, and bound up; and old shoes and clouted upon their feet, and old garments upon them; and all the bread of their provision was dry *and* mouldy.”

**JOSHUA 9:3-5**

The men of Gibeon pretended to come from a far off land to trick the children of Israel. Josh. 9

Help the Gibeonites pack their moldy bread, torn wineskins, and worn-out clothes.

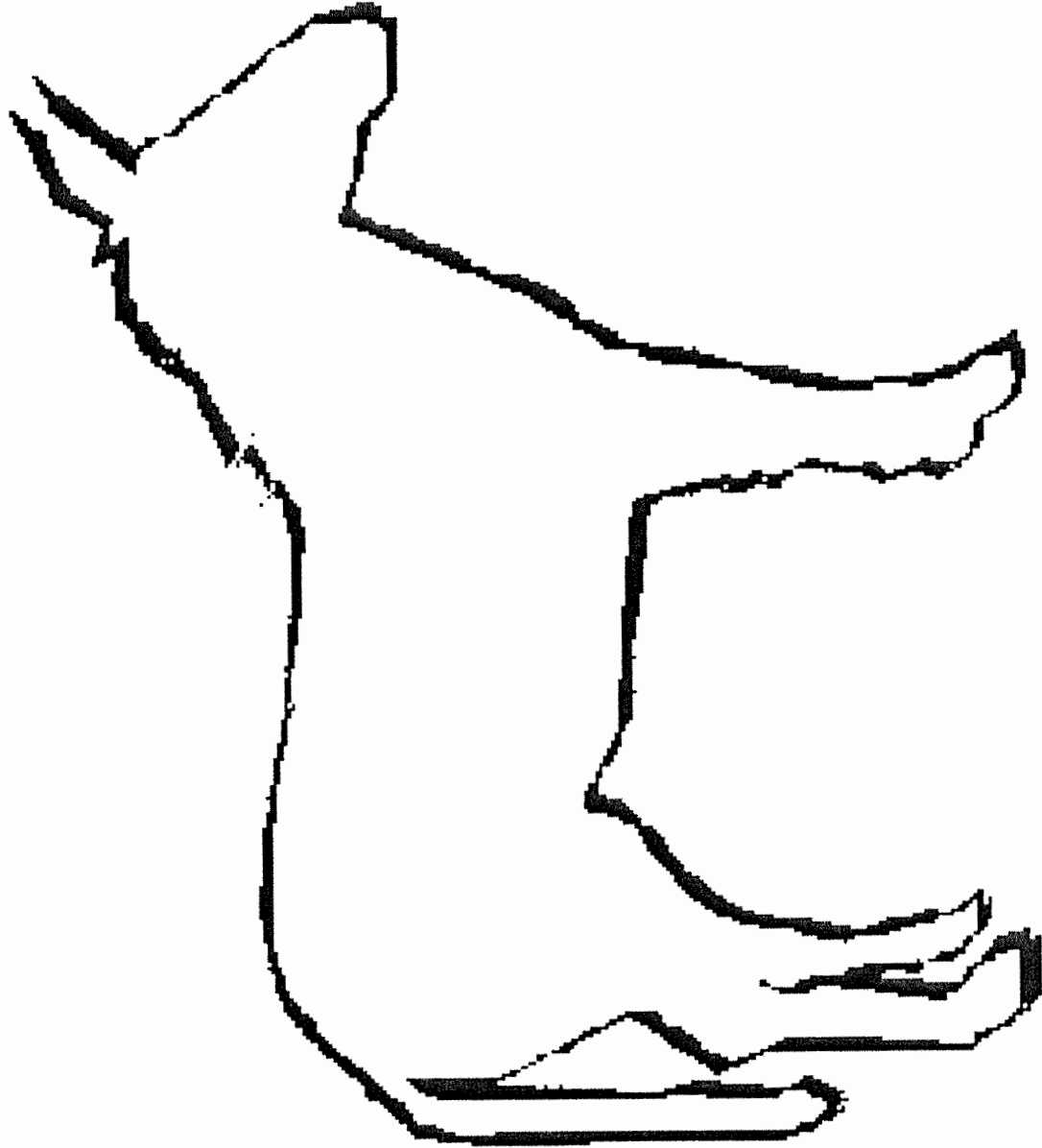
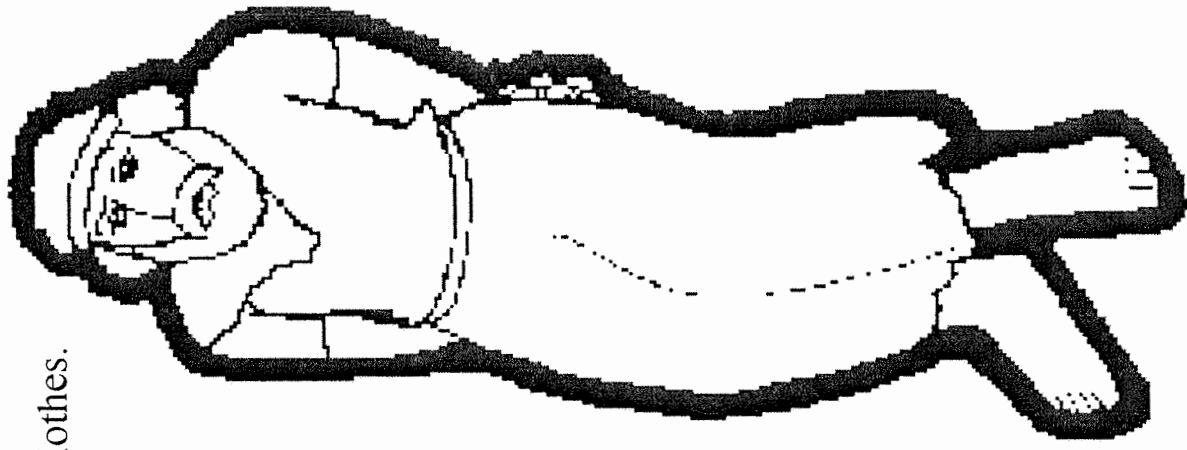

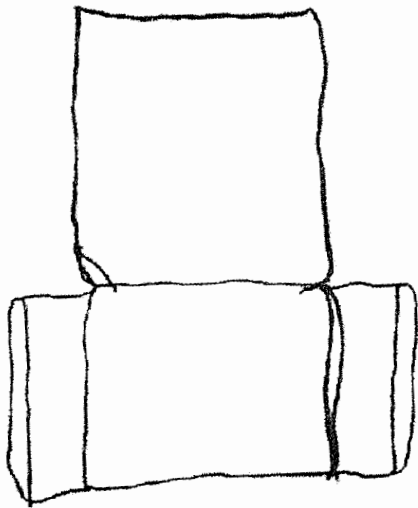

donkey sack  
pattern



shirt pattern

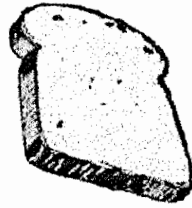

wine-skin  
pattern

For donkey pack on other side



# How Did the Gibeonites Deceive Joshua?

Draw a line from the picture to the description

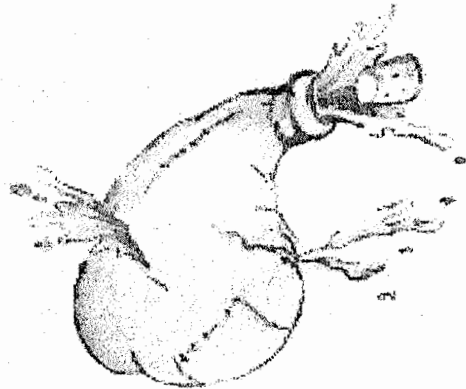

**Moldy Bread**

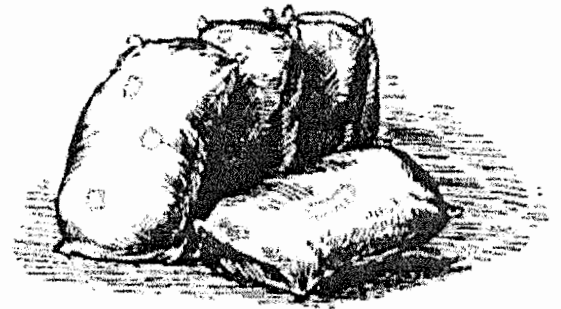

**Old Sacks**

**Old Wine Skins**

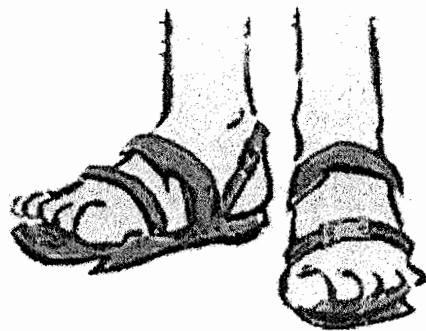

**Old Clothes**

**Old Shoes**

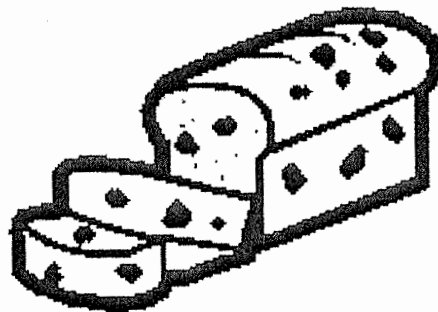

# Fill in the Blanks: The



\_\_\_\_\_

deceived \_\_\_\_\_



by pretending to be from a



But they lied!

\_\_\_\_\_.

The \_\_\_\_\_



became servants to the people of



\_\_\_\_\_.

Use These Words

Israel far Gibeonites country Joshua

# Tricked by the Gibeonites Joshua 9

When they found out they had been tricked, the Israelites kept their promise and did not destroy the Gibeonites, but instead made them vassal-carriers and wood cutters for the camp.

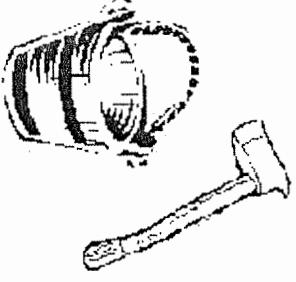

The Israelite leaders did not ask God what to do, but made a promise to the Gibeonites not to destroy them.

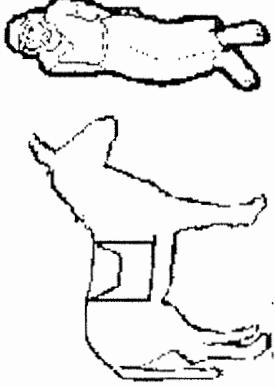

The Gibeonites came to the camp at Gilgal and said they were from a very far place and wanted to make a treaty of peace with the Israelites.

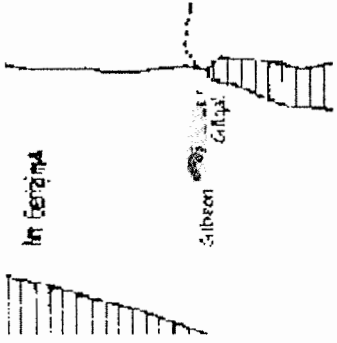

The Gibeonites lived near where the Israelites were camped. They were afraid, so they made a plan to trick the Israelites.

# THE GIBEONITES TRICK JOSHUA

(JOSHUA 9)

W I F T J F H I P W T C K D Y  
I T A P H S S B E J C N L L D  
N E H L Q R Q K V U S Q W O E  
E J A J A W S T N E M R A G S  
S K D E D N E T E R P L K U R  
K K L C O U O S A O C K I E U  
I P H V A D J O S H U A J A C  
N Z Z T W S E N O E B I G V D  
S S R E I R R A C R E T A W J  
W Y Y W V T N A N E V O C D I  
J Y Y L I T F A R C H D N Q P  
U B R E A D W U R E U D R E T  
W O O D C U T T E R S O O N V  
K O N H M J E H L P E K T R R  
O J J P S L A D N A S Q S Y F

BREAD

GARMENTS

OLD

WATER CARRIERS

COVENANT

GIBEON

PRETENDED

WINESKINS

CRAFTILY

ISRAEL

SANDALS

WOODCUTTERS

CURSED

JOSHUA

TORN



# THE GIBEONITES TRICK JOSHUA

## (JOSHUA 9)

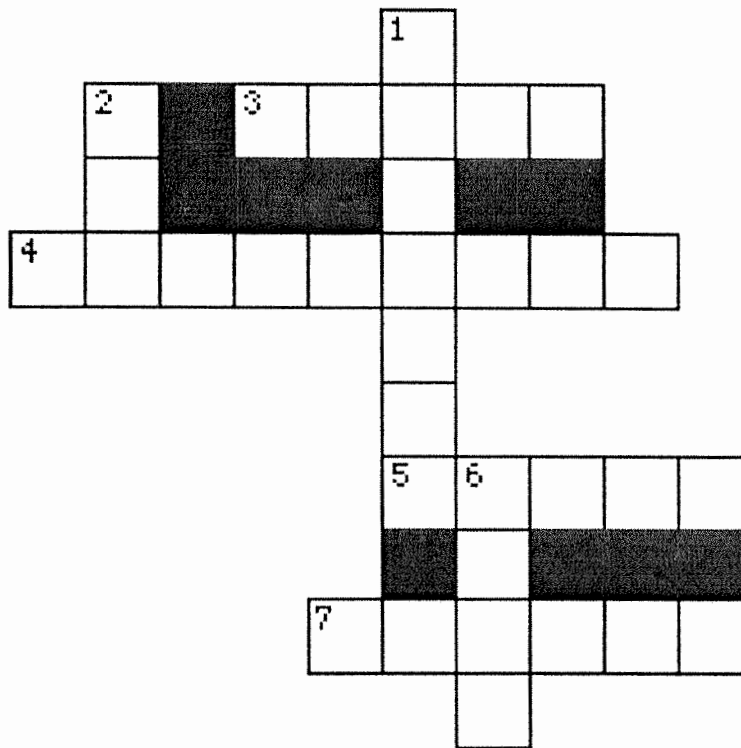

- 5 ACROSS "There are many plans in a man's heart, nevertheless the \_\_\_\_\_ counsel - that will stand." **PROVERBS 19:21**
- 4 ACROSS "When the inhabitants of Gibeon heard what Joshua had done to Jericho and Ai, they worked craftily and went and \_\_\_\_\_ to be ambassadors." **JOSHUA 9:3-5**
- 2 DOWN "And they went to Joshua, to the camp at Gilgal, and said to him and to the men of Israel, 'We have come from a \_\_\_\_\_ country; now therefore, make a covenant with us.'" **JOSHUA 9:6**
- 1 DOWN "The men of Israel took some of their provisions, but they did not ask \_\_\_\_\_ of the LORD." **JOSHUA 9:14**
- 7 ACROSS "The children of Israel did not \_\_\_\_\_ them, because the rulers of the congregation had sworn to them by the LORD God of Israel. And all the congregation murmured against the rulers." **JOSHUA 9:18**
- 3 ACROSS "Then all the rulers said to all the congregation, 'We have \_\_\_\_\_ to them by the LORD God of Israel; now therefore, we may not touch them.'" **JOSHUA 9:19**
- 6 DOWN "This we will do to them: we will let them live, lest wrath be upon us because of the \_\_\_\_\_ which we swore to them." **JOSHUA 9:20**

# THE GIBEONITES TRICK JOSHUA

## (JOSHUA 9)

### MEMORY VERSE:

*"There are many plans in a man's heart, nevertheless the LORD'S counsel - that will stand."* PROVERBS 19:21

### UNDERLINE ALL THE TRUE STATEMENTS:

1. "When the inhabitants of Gibeon heard what Joshua had done to Jericho and Ai,..." **JOSHUA 9:3-5**
  - \* they worked craftily
  - \* they pretended to be ambassadors
  - \* they attacked the camp
  - \* they took old sacks on their donkeys
  - \* they took old wineskins torn and mended
  - \* they had old and patched sandals on their feet
  - \* they had old garments on themselves
  - \* and all the bread of their provision was very fresh

### FILL IN THE BLANK:

2. "And they went to Joshua, to the camp at Gilgal, and said to him and to the men of Israel, 'We have come from a \_\_\_\_\_ country; now therefore, make a covenant with us.'" **JOSHUA 9:6**

### TRUE OR FALSE:

3. The men of Israel took some of their provisions and they asked counsel of the LORD. **JOSHUA 9:14**

TRUE OR FALSE

### FILL IN THE BLANKS:

4. "The children of Israel did not attack them, because the \_\_\_\_\_ of the congregation had sworn to them by the LORD God of Israel. And all the congregation \_\_\_\_\_ against the rulers." **JOSHUA 9:18**
5. "Then all the rulers said to all the congregation, 'We have sworn to them by the LORD God of Israel; now therefore, we may not \_\_\_\_\_ them. This we will do to them: we will let them live, lest \_\_\_\_\_ be upon us because of the oath which we swore to them.'" **JOSHUA 9:19-20**
6. The Gibeonites said to Joshua, "And now, here we are, in your hands; do with us as it seems (GOOD, BAD) and (RIGHT, WRONG) to do to us." **JOSHUA 9:25**



# THE GIBEONITES TRICK JOSHUA

## (JOSHUA 9)

B F Q V E E Q M J P F J N W J D Y A L S P Z M P P  
 Y S L A D N A S H Y P U J U U D Y T U M P A P J G  
 N H T Q P F D A G B G K T D O C D W T O U U O P C  
 M N A Z Z J J Z E D K O P S G S R L M A Z E E Q J  
 H G Q U C T Q S U R B I L J I O T A O T V F A X N  
 L X O L D E R H W C U T J H B K J N F M F P Y Q H  
 D C F A C J I M D G K E C Q E Q I A E T R T U F E  
 R G O S N I K S E N I W V O O K P P E M I O H G D  
 E R H V Q Z L M W R C J T E N L T T M Z R L A A B  
 U Q P N E Z S S Y G U K W W E W V O M J K A Y M Y  
 W I J M I N T V P N M K H E P K R R N S K N G M K  
 I P T G W K A O Z G D P W B T I F N O M Y I E A K  
 S H B F Z C F N W Z L Z P A C J E P B X R J C O J  
 R Z I H K T A J T J S Y J K T S J A U P G J N K M  
 A I S R E T T U C D O O W S S E O X L C I Y A C V  
 E V A A K I Y J B P V Y H U C U R V P D K T I Y W  
 L V M W Q O Y E M N R O Q H H E U C M T B H Z U Z  
 J B X X J T O A W U C J O P U A G Q A X U R S D F  
 N Q T P B A F W U O M F A E E V F D C R A G E Y I  
 S Y Y E B N V L F F L A W V C D E D C X R F N A Z  
 P R E T E N D E D L B H V A N S K V V G V I C G D  
 Z E L S R R L Z I L X A M R R Q D S Z E P Y E T T  
 K L I G B P S M H M A H F U Q E B M Y I O Q Z R M  
 B N A U H S O J G S C Z C L L N P C F T M D X I S  
 Z V O D K I V P Y Z W Y S W K R L Z L L V C R I G

BREAD	GARMENTS	OLD	WATER CARRIERS
COVENANT	GIBEON	PRETENDED	WINESKINS
CRAFTILY	ISRAEL	SANDALS	WOODCUTTERS
CURSED	JOSHUA	TORN	





# Joshua Leads God's People

Before Moses died, God chose Joshua to lead His people into the Promised Land. When the people obeyed Him, God helped Joshua and the Israelites defeat their enemies, and God gave the people homes and lands in the Promised Land. Use the clues to fill in the correct words in the crossword puzzle. The Bible verses will help you if you get stuck.

## ACROSS

1. Rahab did this to save the two spies; to tell an untruth. (Hint: Read 2:3-6)
3. Achan was from this tribe. (7:1)
9. Rahab took the spies \_\_\_\_\_ to hide them; a direction. (2:6)
10. Joshua and Caleb saw the Red \_\_\_\_\_ dry up so the people could cross. (Exodus 14:21-22)
12. Joshua told the people to go in and possess the \_\_\_\_\_ God had given them. (1:11)
13. Where the tabernacle was set up. (18:1)
16. God said, "Moses my servant is dead; now therefore arise, \_\_\_\_\_ over this Jordan." (1:2)
18. Woman saved from Jericho. (6:25)
20. What the manna did after the people had eaten Passover in Canaan: \_\_\_\_\_ d. (5:11-12)
23. Joshua's relation to Nun. (1:1)
24. City that was able to defeat Israel because of Achan's sin. (7:5)
25. Describes the clothes and wine skins of the Gibeonites; the Bible uses the word rent. (9:4)
27. Took Moses' place. (Deuteronomy 34:9)
31. Joshua told it to stand still until the people avenged themselves on their enemies. (10:12-13)
32. City that fooled Israel into thinking they came from far away: \_\_\_\_\_ n. (9:3-4)
35. Joshua was to do this to the land by lots among the tribes. (13:6)
38. What Joshua did for Israel; he \_\_\_\_\_ them into the promised land. (1:2)
40. Achan's sin; to covet or have sinful desire for wealth. (7:19-21)
43. Pronoun used to refer to a male.
44. A supernatural event.

## DOWN

2. Where Joshua built an altar and read the law to the people. (8:30-34)
3. These men stood beside the ark as Joshua read the law; one who hears court cases. (8:33)
4. God said, "Fear not . . . go \_\_\_\_\_ to Ai." (8:1)

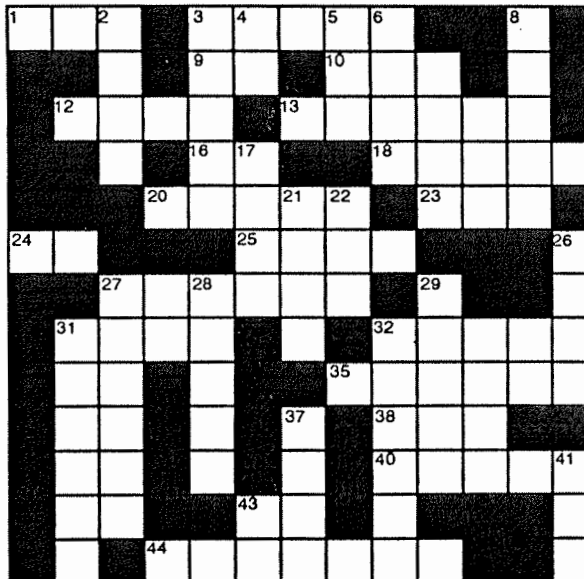

5. Left after a fire.
6. Zelophehad had no male \_\_\_\_\_, so his daughters inherited his land. (17:3-4)
8. Who took forbidden valuables from Jericho? (7:1)
17. Promise the spies made to Rahab. (2:17)
21. Joshua said, "Love the Lord . . . serve Him with all your heart and with all your \_\_\_\_\_." (22:5)
22. A period of time.
26. Like Moses, Joshua was told to remove this because he stood on holy ground. (5:15)
27. River the Israelites crossed. (1:2)
28. God warned that if the Israelites did not defeat the nations, they would become a \_\_\_\_\_ to Israel. (23:10-13)
29. The Jordan \_\_\_\_\_ stopped when the priests stepped into it. (3:15-16)
31. Describes the bread of the Gibeonites. (9:5)
32. Heap of stones from the river were placed here. (4:20)
37. Request, such as the Gibeonites made for their lives.
41. Joshua did this at 110 years; \_\_\_\_\_ d. (24:29)
43. Abbreviation of hour.

**Year 2**

**Week 54**

## **Time Stands Still**

**Scriptures: Joshua 10**

**Key Verse: Joshua 10:14 And there has been no day like that, before it or after it,...for the LORD fought for Israel**

### **Key Points:**

1. Five kings joined together with their armies to attack Gibeon and stop the Israelites.
2. God reassured Joshua that Israel would win a victory.
3. God took over the battle and sent large hailstones to kill many.
4. Joshua wanted daylight to last longer, so God caused the sun to stand still for about a day.
5. The kings ran and hid in a cave, but the Israelites rolled large stones over the cave opening to keep them inside.
6. After the battle, the Israelites returned to the cave and killed the kings. Israel was again victorious with God's help.



After the death of Moses, Joshua led the Hebrews in their battles for the Promised Land.

# The Sun Stands Still

Joshua 10:1 - 10:28



# Sun Paper Plate Craft

Joshua 10:1-28

The sun stands still for Joshua and his army

## Materials Needed:

1 paper plate (for each child)  
Yellow construction paper  
Scissors  
Glue (or a stapler)  
Crayons, paint or markers  
Googly eyes



1. Paint the back side of a paper plate yellow.



2. Trace your children's hand on yellow construction paper about 7 times.

3. Cut out the tracings.

4. Glue or staple the handprint tracings to the paper plate - The fingers are the sun's rays.



5. Color in the sun, drawing a mouth and a nose, and then glue on googly eyes.

Calvary Kids Pages [www.calvarywilliamsport.com/kids-index](http://www.calvarywilliamsport.com/kids-index)

# Joshua story line for preschool

Cut apart the different stories, have the children color them, then help them glue them on a sheet of construction paper in order.

copy for each child (Optional – colored paper)

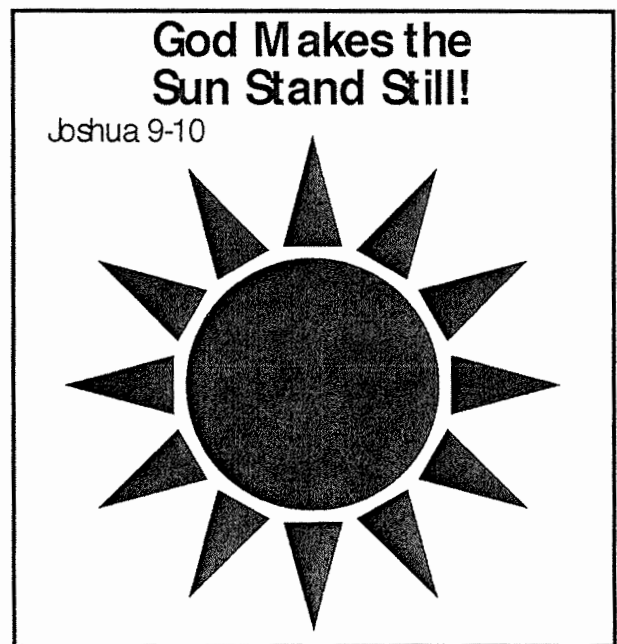
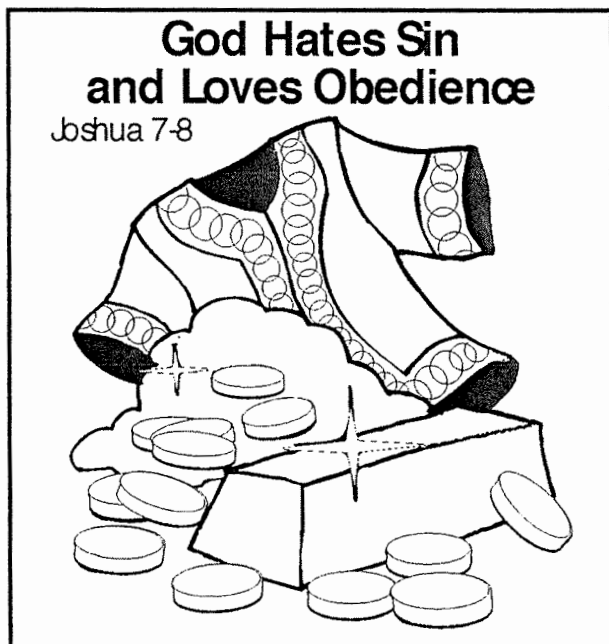
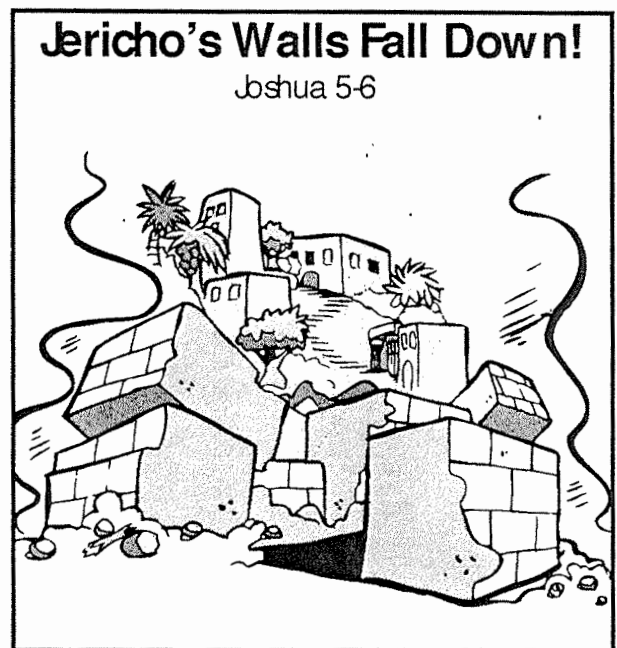
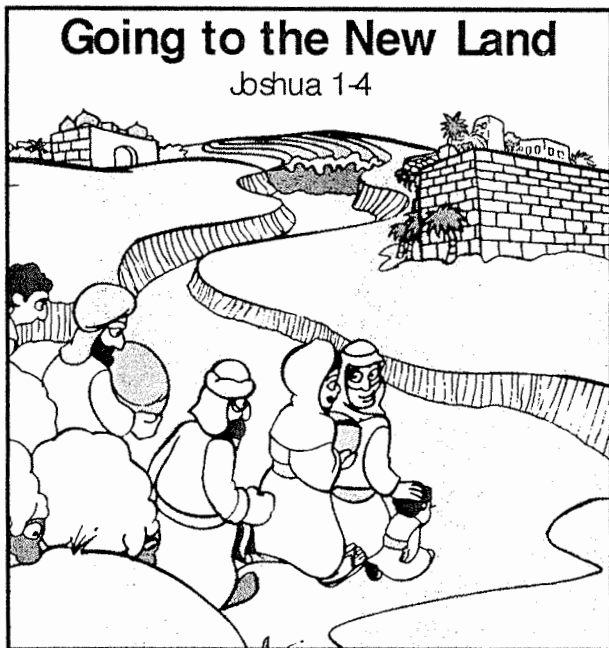

Joshua went to battle against the A \_ \_ \_ \_ \_.

Joshua asked God to make the \_ u \_ stand still.

God made the sun stand still for about one full \_ \_ y.

God helped Joshua's army to w \_ \_ the battle against the Amorites.

God was \_ \_ \_ \_ \_ ing for the Israelites!

God's p \_ \_ \_ r is greater than anything else!

day

Amorites

power

win

sun

fighting

# The Sun Stands Still

## Joshua 10

Joshua and the Israelites were fighting a major battle against five kings of Canaan. The Israelites needed more time to finish the fight. Joshua prayed to God for help.

Solve the puzzle to see how God answered Joshua's prayer.

Cross out the letters of the alphabet in order. The remaining letters spell out the answer.

A A N D T B H E S C U N D S T E O O D F  
S G T I H L L A I N D J T H E M K O O N  
S T A L Y E M D U N N T I O L T H P E P  
E O Q P L E H R A D A V E S N G E T D T  
H E U M S V E L V E S W U P O N T X H E  
Y I R E N Z E M I E S

---

---

---

---

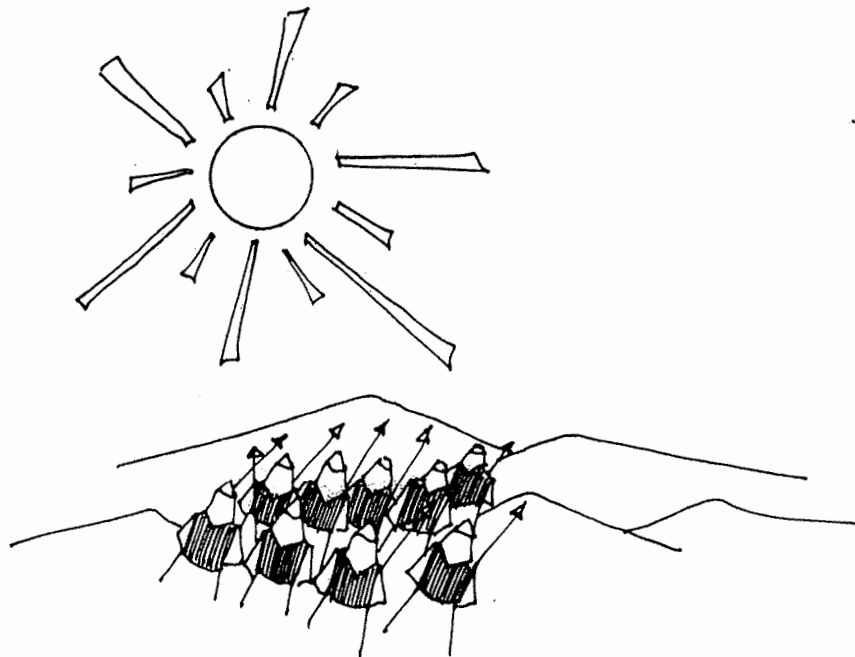



# Sun stands still

✓ or X?

Cross out the wrong answers below:

1. The people of Gibeon / Gilead decided to play a trick on the Israelites in order to make peace with them.
2. They sent a delegation with donkeys loaded with worn-out / new sacks and wineskins.
3. They tried to fool the Israelites into thinking they were from a long distance away / a poor people.
4. God had warned the people of Israel to make / not to make a truce with the people of the Promised Land.
5. The Gibeonites / Ammonites sent word to Joshua to come up quickly and save them.
6. God helped Joshua by throwing large hailstones / rocks down on them killing them.
7. Joshua prayed that God might stop the sun / the moon from going down so that they would have more time.

## An important truth

Join up the circles to find a very important truth.

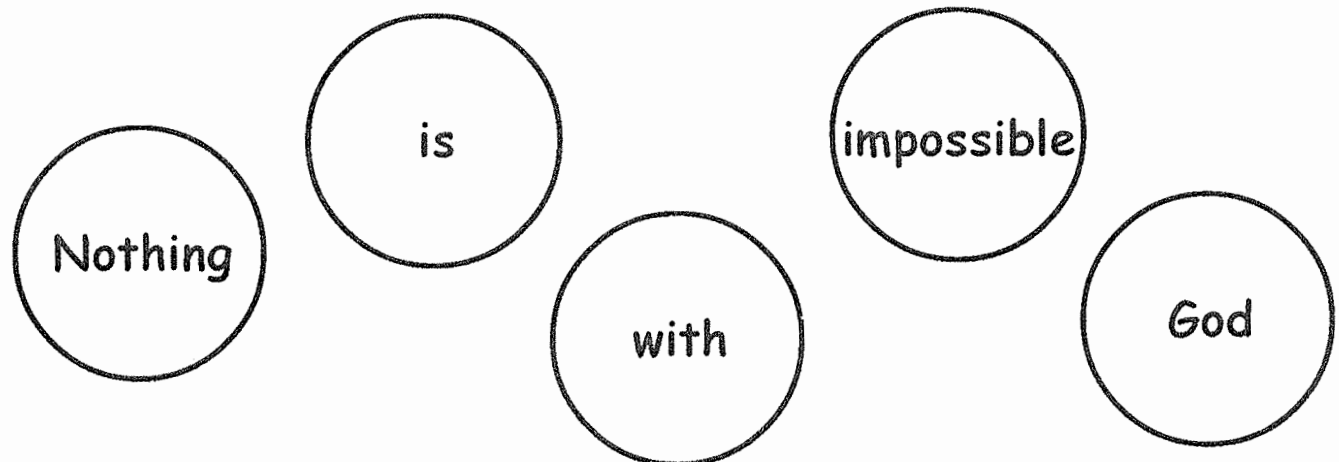



1. **Although I didn't live the way that I should, I helped God's people when I could. Who am I? Joshua 2:1**
  
2. **The ground opened up and swallowed me, my men, and my family. Who am I? Numbers 16:31-32**
  
3. **I was once in a tree before God used me as a sign to the Israelites. Who am I? Number 17:8**
  
4. **I was 120 years old when I died but I was still strong and had good eye sight. Who am I? Duet 34:7**
  
5. **I used to protect those inside until I was shouted down from those on the outside. Who am I? Josh 6:20**
  
6. **We are 2 of the 12 spies who brought back a good report, when we were sent out by Moses to spy out the Promised Land. Who are we? Numbers 14: 6-7**
  
7. **I saw the angel that my master could not see and that is why he spoke harshly to me. Who am I? Numbers 22:25,29,30**
  
8. **I took that which was forbidden and under my tent it was hidden. Who am I? Joshua 7:20-22**
  
9. **I was lifted up for the people to see, who in the New Testament is like unto me? Numbers 21:9 John 3:14-15**

**Aaron's rod**

**Bronze snake**

**Moses**

**Korah**

**Walls of Jericho**

**Joshua**

**Rahab**

**Caleb**

**Jesus**

**Balaam's Donkey**

**Wall's of Jericho**

**Achan**

**Year 2**

**Week 55**

## **Israel Ruled by Judges**

**Scriptures: Judges 1, 2, 3**

**Key Verse: Judges 3:15** But when the children of Israel cried out to the Lord, the Lord raised up a deliverer for them.

*The nation of Israel was divided into twelve tribes, descended from the twelve sons of Jacob. Before his death, Joshua divided the land so that each tribe possessed its own section of the Promised Land.*

### **Key Points:**

1. After Joshua died, the people failed to remove the idols from the land, and began to worship other gods of the nations around them.
2. Because they had disobeyed God, He allowed the Israelites to become slaves.
3. When Israel repented, God raised up a judge to lead them, and gave them peace from their enemies while the judge lived. When the judge died, the Israelites would forget God and worship idols.
4. Othniel and Ehud were the first judges. Ehud went to pay tribute to the king of Moab, who ruled over Israel. Ehud killed the king, and God helped the Israelites defeat the Moabites. Israel then had peace for 80 years.

"Again the Israelites cried out to the Lord, and he gave them a deliverer— Ehud."



# DEBORAH

Judge Over Israel



## Judges 4:4-5

Now Deborah, a prophetess, the wife of Lapidoth, was judging Israel at that time. And she would sit under the palm tree of Deborah between Ramah and Bethel in the mountains of Ephraim. And the children of Israel came up to her for judgment.





## THE JUDGES



For years the Hebrews had no kings but were ruled by Judges. One of the Judges was Samson, who was so strong that he killed a lion with his bare hands.

"The Lord was with the men of Judah.  
They took possession of the hill country, but  
they were unable to drive the people from the  
plains, because they had iron chariots."

(Judges 1:19)

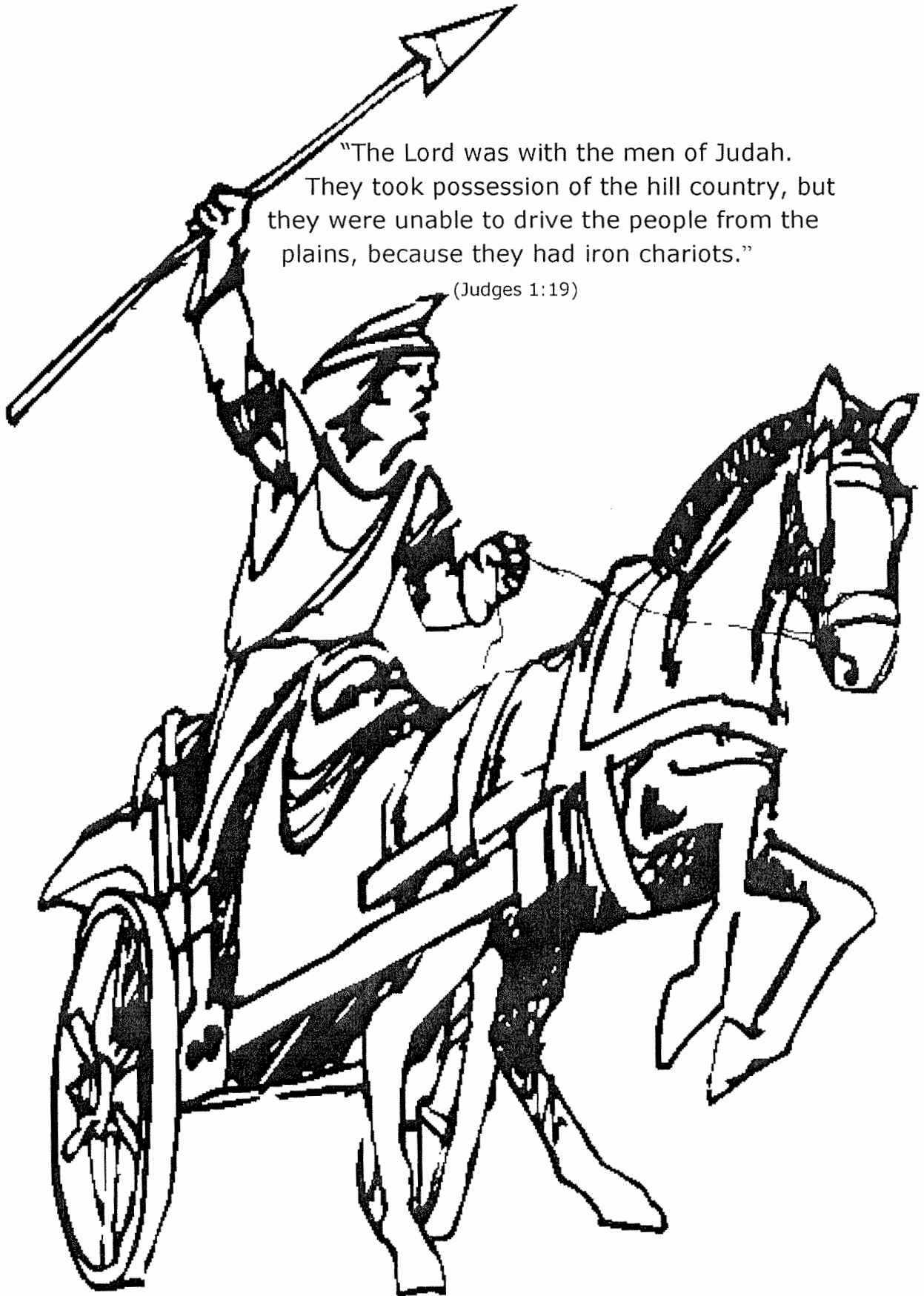

# Judges in the Bible

H L S H A M G A R C  
A E R A A B D O N V  
H I Q V M U W T G S  
T N Q D H S N T I A  
H H N E E O O R D M  
P T Q A L B T N E U  
E O W E Z B O T O E  
J Q K K L B O R N L  
R I A J Q L I R A Z  
Y D X D A C H Y W H

[www.churchhousepuzzles.com](http://www.churchhousepuzzles.com) © 2011

Abdon

Jephthah

Deborah

Othniel

Ehud

Samson

Elon

Samuel

Gideon

Shamgar

Ibzan

Tola

Jair

*Can you name the judges?*

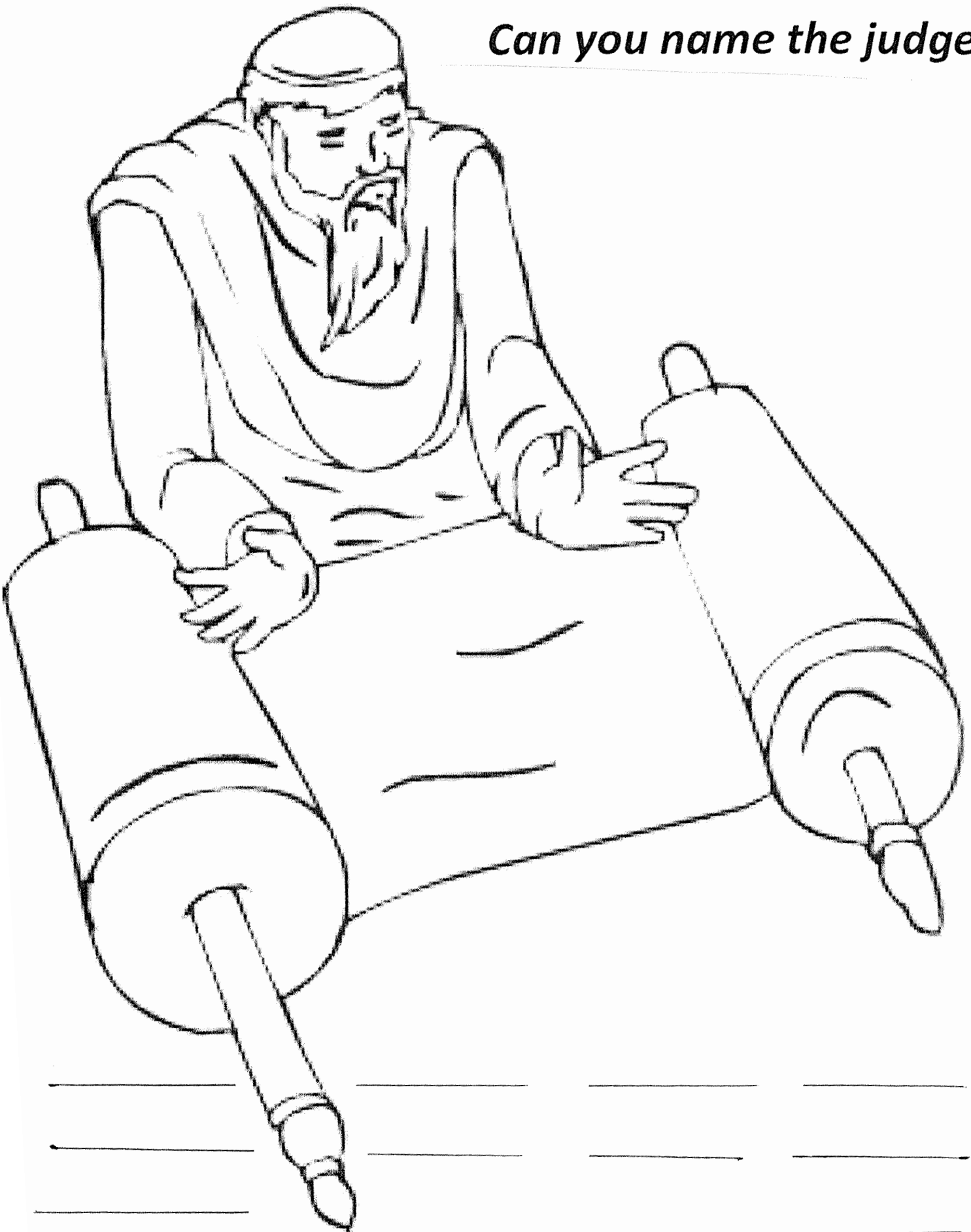

---

---

---

---

---

---

---

---

---

---

## The Judges



1			2					3		4			5
					6								
	7												
				8									

**Across**

1. Gideon asked for a \_\_\_\_ for proof.
7. Samson's enemy
8. the woman who tricked Samson

**Down**

2. Samson was bound by a \_\_\_\_ vow.
3. The people displeased God when they began to \_\_\_\_.
4. the messenger sent to Gideon
5. the number of soldiers in Gideon's army
6. Israel's enemy in Gideon's time
7. Each man was armed with a trumpet and a \_\_\_\_.

WORD BANK: WORSHIP IDOLS, MIDIANITES, AN ANGEL, SIGN, PITCHER, THREE HUNDRED, NAZARITE, PHILISTINES, DELILAH

Fill in the blanks

- 1.) The \_\_\_\_\_ Box was brought back to Israel
- 2.) The Israelites won a battle against the \_\_\_\_\_
- 3.) \_\_\_\_\_ told the people to follow God

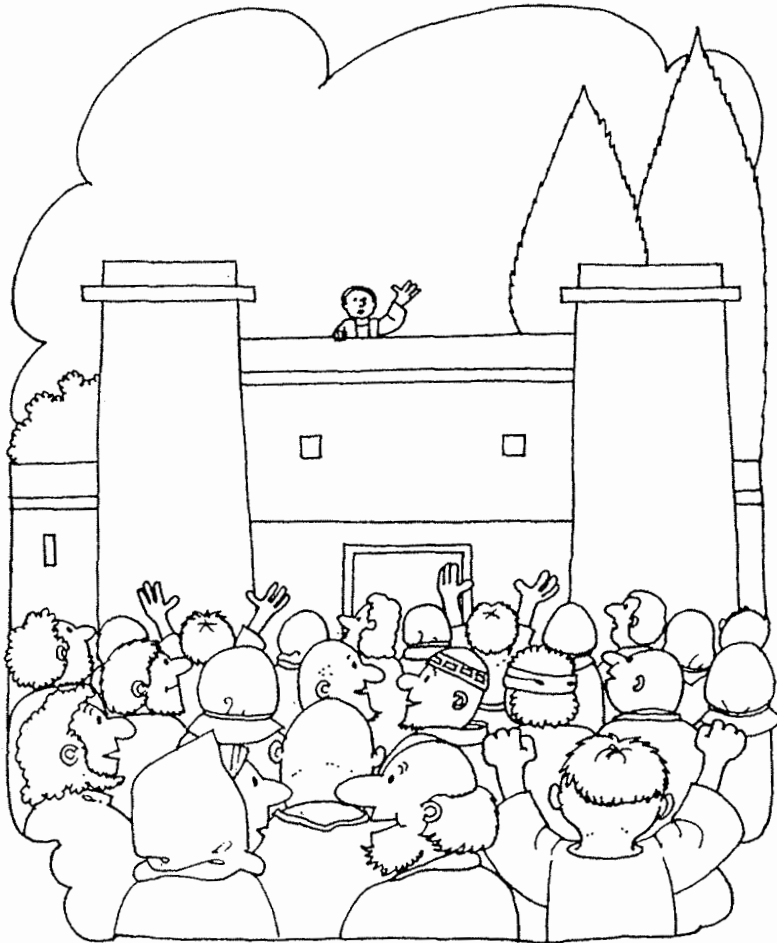
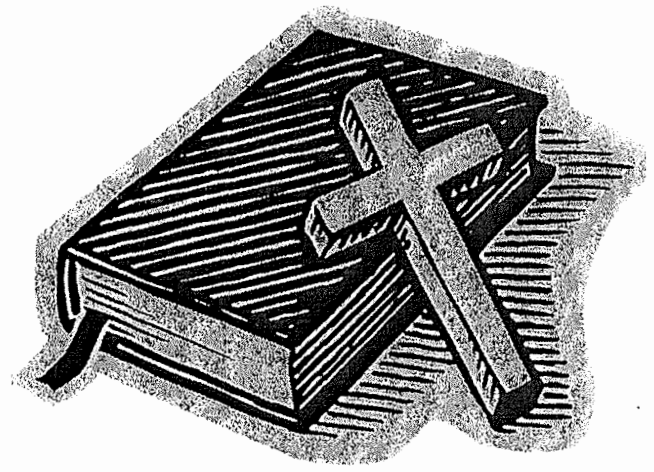

Be on your guard,  
stand firm in the faith;  
be men of courage;  
be strong.

1 Corinthians 16 verse 13

### Samuel rules Israel

C R G R B H B B J Z H T S P O  
 B M G A B O E Y G E X A B H I  
 N K L I D Y A R P L C A R I V  
 H T E R O T H S A R T E E L L  
 K V I T O V H M I T D G L I V  
 Y R F R N V B F L N D C P S Y  
 T L A E V A I E U U R E V T R  
 N P H Z X C N H J T K M M I E  
 E B O E E M T E I L I Q V N G  
 W A P N R I M O V S A M U E L  
 T A K E P Z W X Y O R L M S M  
 C L A B S P E A C E C A O O C  
 S U O E G A R E D A E L E R C  
 P Q W Y N H A D H K T L F L D  
 N C O P E W F V L R I E H H Y

Crack the code to find out what Samuel told the people to do

ABC DEFGHIJ KLMNOPQRSTUVWXYZ  
 ZYXWVUTSRQ PONMLKJIHG FED CBA

TVG IRW LU ZOO ULIVRTM TLWH ZMW

-----

WVWRXZGV BLFIHVOU XLNKOVGOB GL GSV

-----

OLIW

-----

ARK  
 BATTLE  
 EBENEZER  
 LAMB  
 MIZPAH  
 PRAY  
 THUNDER

ASHTORETH  
 COMMIT  
 ISRAEL  
 LEADER  
 PEACE  
 SACRIFICE  
 TWENTY

BAAL  
 COVENANT  
 JUDGE  
 LORD  
 PHILISTINES  
 SAMUEL

## The 12 Judges Of Israel

NAME	TRIBE	OPPRESSED BY	YEARS	REFERENCE
Othniel	Judah	Mesopotamia	8 Oppressed 40 At Peace	Judges 3:7-11
Ehud	Benjamin	Moabites	18 Oppressed 80 At Peace	Judges 3:12-30
Shamger	Judah		?	Judges 3:31
Deborah & Barak	Ephraim Nephtali	Canaanites	20 Oppressed 40 At Peace	Judges 4:1-5:31
Gideon	Manasseh	Midianites	7 Oppressed 40 At Peace	Judges 6:1-8:35
Tola	Issachar		23 At Peace	Judges 10:1-2
Jair	Gad		22 At Peace	Judges 10:3-5
Jephthah	Gad	Ammonites	6 At Peace	Judges 10:6-12:7
Ibzan	Judah		7 At Peace	Judges 12:8-10
Elon	Zebulun		10 At Peace	Judges 12:11-12
Abdon	Ephraim		8 At Peace	Judges 12:13-15
Samson	Dan	Philistines	40 Oppressed 20 At Peace	Judges 13:1-16:31

## A Comparison Of The Books Of Joshua And Judges

THE BOOK OF JOSHUA	THE BOOK OF JUDGES
Victory	Defeat
The People were Free	The People were Servants
The Land was full of Faith	The Land was full of Unbelief
Progress	Decline
Spiritual Vision	Earthly Emphasis
Committed to the Lord	Not Committed to the Lord
Joy	Sorrow
Strength	Weakness
Unity in Propose	Anarchy
Sin was to be Avoided at all Cost	Sin was to be Tolerated

# The Book of Judges

Focus	Deterioration	Deliverance						Depravity									
	Divisions	1	2	3	5	6	8	9	12	13	16	17	21				
Topics	Situation	Introduction to the Judges						Gideon, the Hesitant Hero			Gideon's Son & Six Judges			Samson the Carnal Champion		The Example of National Degradation	
	Religious Laxity	Sin, Servitude & Salvation						Political Uncertainty						Shocking Decline		Moral Anarchy	
Place	Canaan & Transjordan																
Time	About 350 Years																
Author	Probably the Prophet Samuel																



**Year 2**

**Week 56**

## **Deborah and Barak**

**Scriptures: Judges 4, 5**

**Key Verse: Judges 4:15 And the LORD routed Sisera and all his chariots and all his army with the edge of the sword before Barak**

### **Key Points:**

1. The Israelites worshipped idols after Ehud died, so God allowed Jabin, king of Canaan, to oppress the Israelites for twenty years.
2. Deborah was the judge who helped them return to God.
3. Deborah called for Barak and told him that the Lord would deliver Jabin's army into the hands of Barak and his 10,000 men.
4. Barak wanted Deborah to come with him. She agreed to go, but predicted that Sisera, the leader of the Canaanite army, would be killed by a woman.
5. After God helped Israel destroy the Canaanites, Deborah and Barak sang a song to praise God for their deliverance.



# Deborah Judges Israel

# DEBORAH THE JUDGE & BARAK THE COMMANDER





Deborah Helps Barak  
*Judges 4*

Judges 4—Deborah Helps Barak Obey  
**Shield Scenes**

**Supplies**

copies of the Shield Scenes for each child  
crayons or markers  
scissors  
dark-colored card stock (*optional*)  
glue or glue sticks (*optional*)

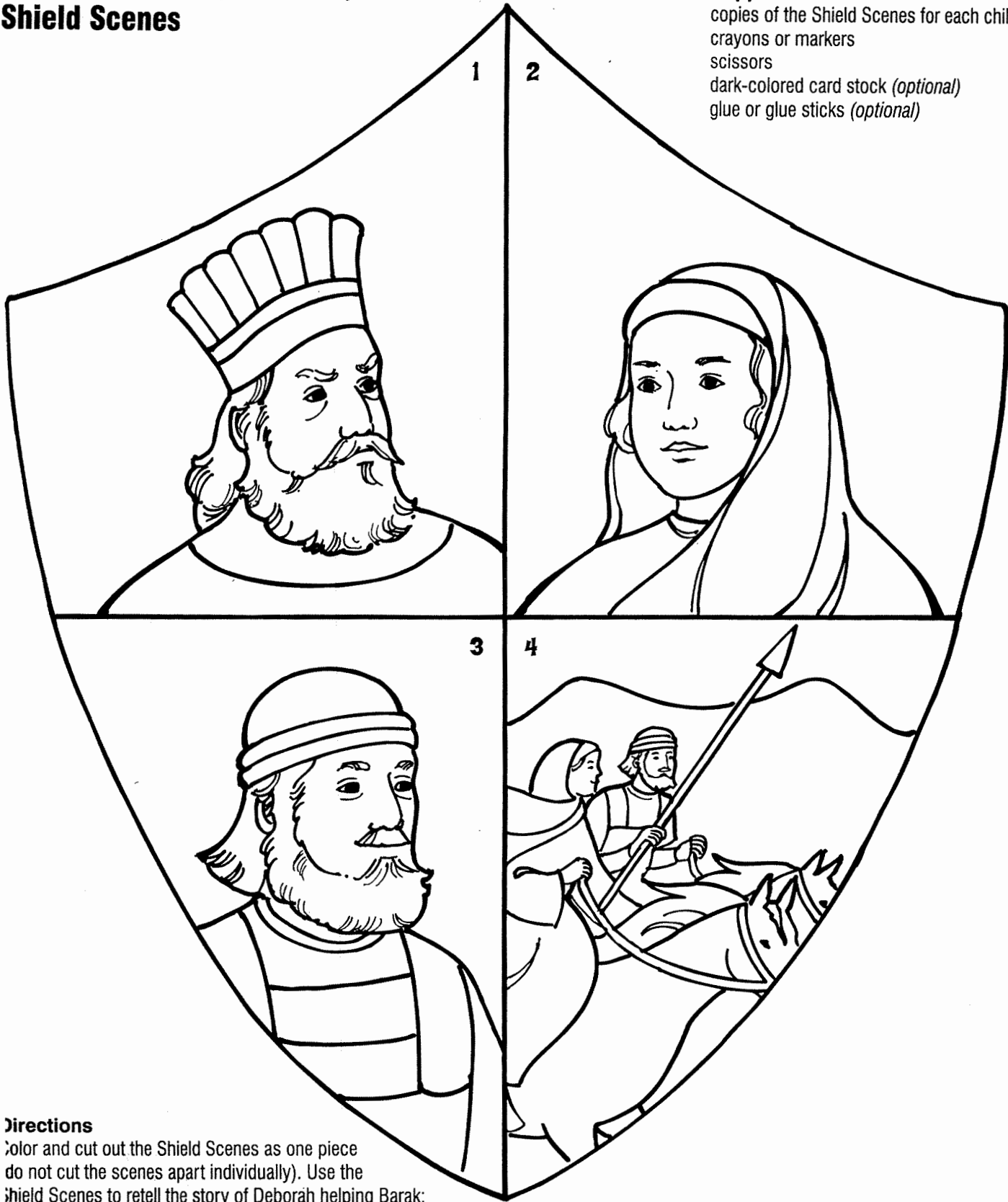

**Directions**

Color and cut out the Shield Scenes as one piece (do not cut the scenes apart individually). Use the Shield Scenes to retell the story of Deborah helping Barak:

- 1) King Jabin was cruel to God's people.
- 2) God sent a message to Deborah who was a judge.
- 3) Deborah sent a message to Barak telling him what God said.
- 4) Deborah and Barak went together to defeat King Jabin's army.

*Optional: Mount the shield on a piece of card stock for a more durable shield.*

To make a scene of Deborah, a prophetess, copy the items and then glue them onto cardstock or colored paper. Make the tree trunk and palm leaves out of colored paper, then glue on to complete the scene.

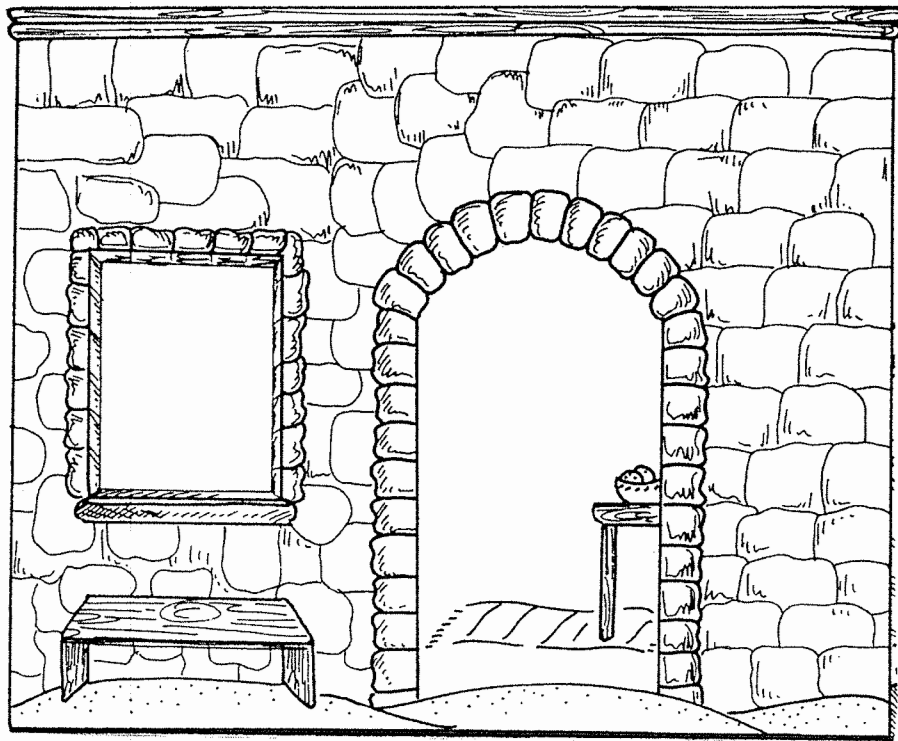

**Judges 4:4-5**  
Now Deborah, a prophetess, the wife of Lapidoth, was judging Israel at that time. And she would sit under the palm tree of Deborah between Ramah and Bethel in the mountains of Ephraim. And the children of Israel came up to her for judgment.

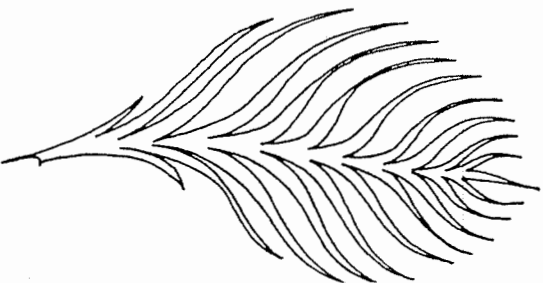
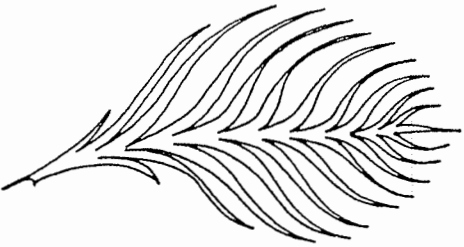
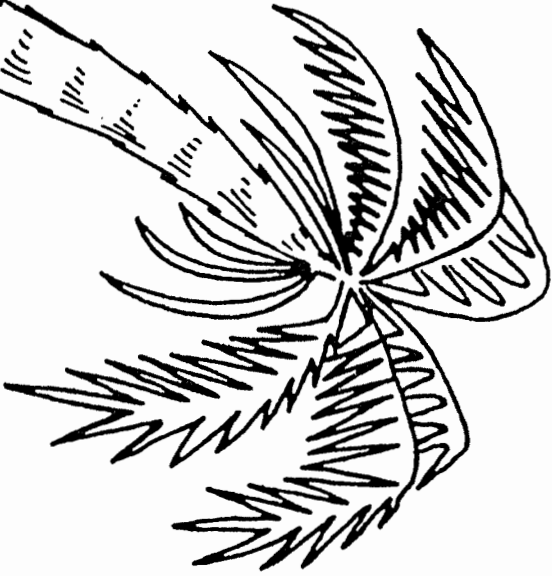
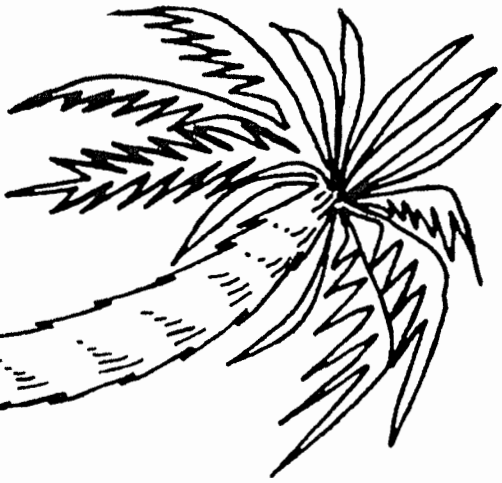
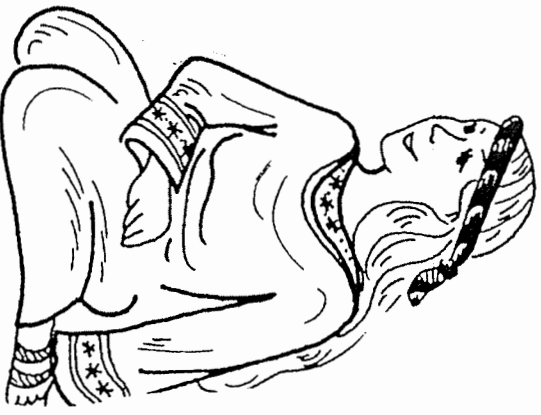
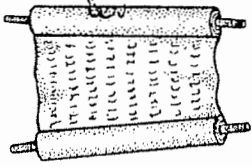

Deborah was judging Israel. She used to sit under a palm and the people of Israel came up to her for judgment. She summoned Barak...

Go, gather your men at Mount Tabor. And the Lord will give General Sisera into your hand.

If you will go with me, I will go, but if you will not go with me, I will not go.

I will go with you. Nevertheless, the road on which you are going will not lead to your glory, for the Lord will sell Sisera into the hand of a woman.





When Sisera was told that Barak had gone up to Mount Tabor, he called out all 900 of his chariots of iron. Deborah said to Barak, "Up! For this is the day in which the Lord has given Sisera into your hand." So Barak went down from Mount Tabor with 10,000 men following him.



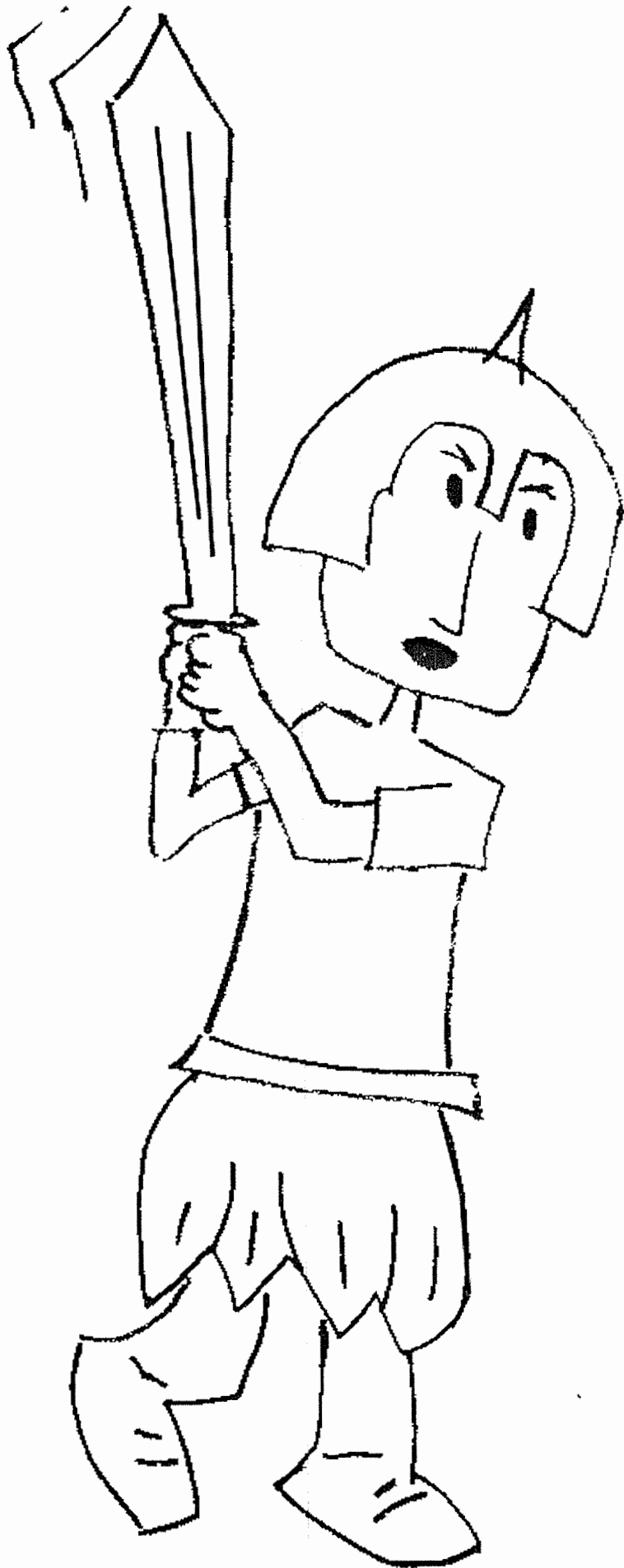

The Lord  
routed Sisera  
and all his  
chariots  
before Barak  
by the edge  
of the sword

Sisera got down  
from his  
chariot and  
fled away.  
Barak pursued  
the chariots  
and all the army  
of Sisera fell  
by the edge of  
the sword.

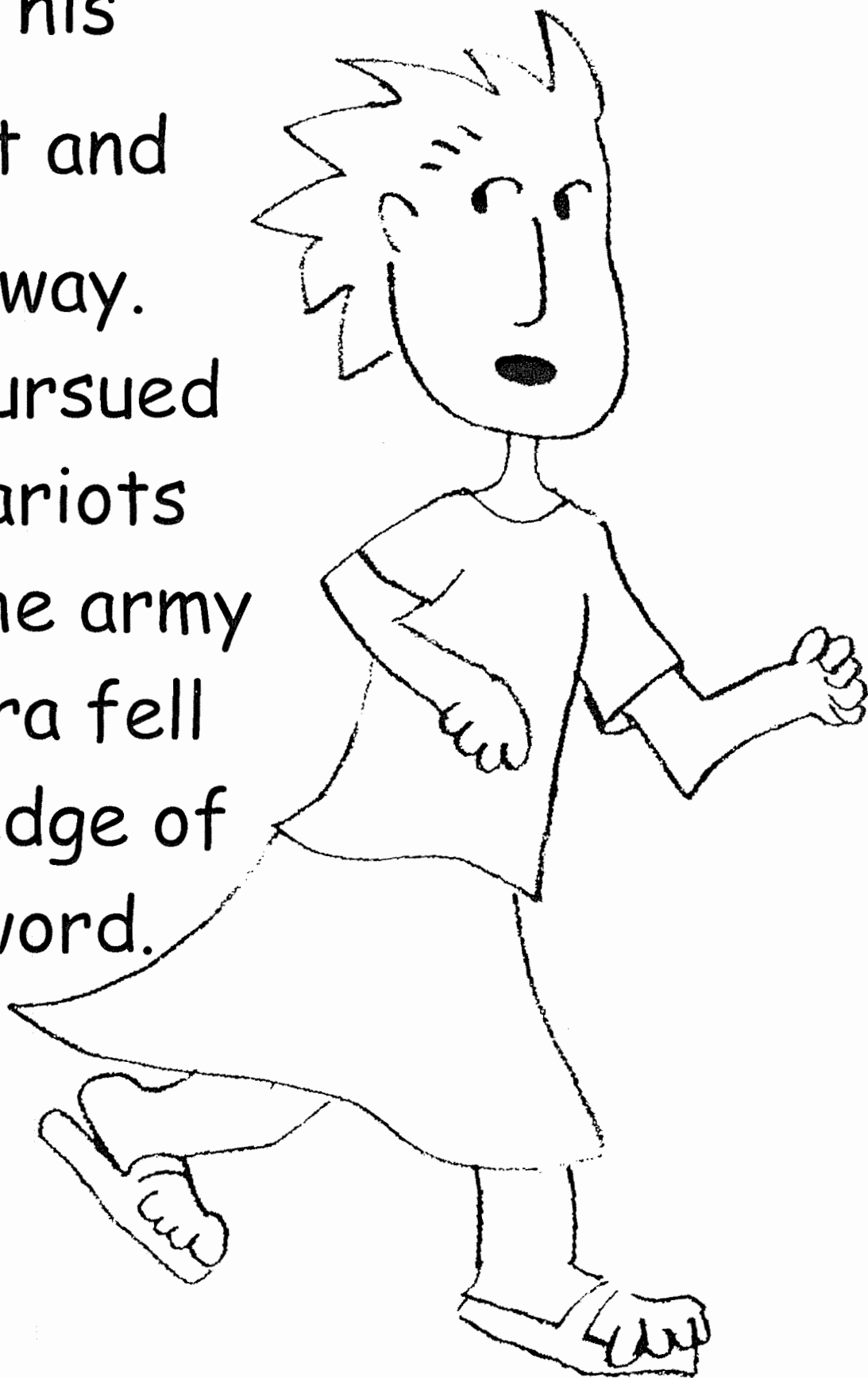

Sisera fled on foot to the tent of Jael. She took him in, gave him a drink of milk and covered him with a rug.



But Jael took a tent peg and with a hammer she went softly to him and drove the peg into his temple while he was fast asleep. As Barak pursued Sisera, Jael went out to meet him and said "Come, and I will show you the man whom you are seeking." And there lay Sisera dead



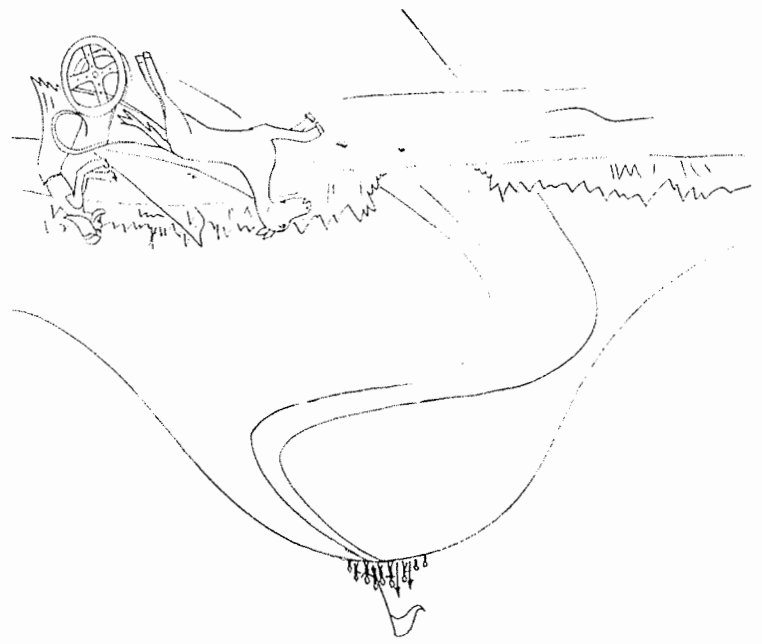

When Sisera was told that Barak had gone up to Mount Tabor, he called out all 900 of his chariots of iron. Deborah said to Barak, "Up! For this is the day in which the Lord has given Sisera into your hand." So Barak went down from Mount Tabor with 10,000 men following him

Sisera got down from his chariot and fled away. Barak pursued the chariots and all the army of Sisera fell by the edge of the sword.

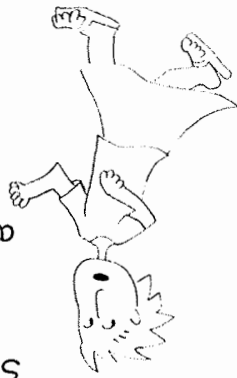

But Jael took a tent peg and with a hammer she went softly to him and drove the peg into his temple while he was fast asleep. As Barak pursued Sisera, Jael went out to meet him and said "Come, and I will show you the man whom you are seeking." And there lay Sisera dead.

## Deborah the Judge and Barak's Victory

Judges 4 and 5

Mini Book  
By

Deborah was judging Israel. She used to sit under a palm and the people of Israel came up to her for judgment. She summoned Barak to go to battle against Sisera.





# Deborah Leads Israel



people



Israel



obey



pray



judge



name



Deborah



army



music

Often the  of  did not  God. When they didn't , they lost their wars. Then they came to God. They ed to God for help. God sent s. The s helped the ites fight their enemies. When the ites ed God, they won. One  was a woman. Her  was . Her helper's  was Barak. Barak led 's . 's enemies were the  of Canaan. The Canaanites came to fight . God told  what to do.  told Barak. Barak told the . The  ed. Because they ed, God helped them. God gave them the land of Canaan.  and Barak sang a poem with  to God.



**Deborah  
and Barak  
Judges 4**

# Deborah Goes to Battle!

Circle the words that tell about Deborah. Look in Judges 4 if you need help. Then, starting with "prophetess," follow the arrow around the circle of words. Take every big, bold letter and copy them in order onto the lines below.



sat under a palm tree

was a judge of Israel

was a prophetess

was a princess

baked bread

was wife of Lappidoth

was very old

liked to sing







settled arguments

sent a message to **B**arak

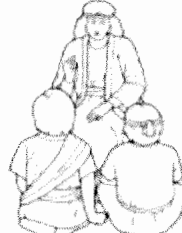
never married

Deborah \_\_\_\_\_ .

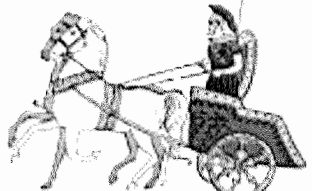
## UNSCRAMBLE THE WORDS FROM THE STORY

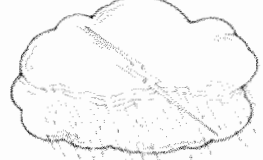
 <p><b>REASIS</b> _____</p>	<p><b>OHDEBAR</b></p>  <p>_____</p>	<p><b>KABRA</b></p>  <p>_____</p>
 <p><b>ETNT</b> _____</p>	<p><b>ABAL</b></p>  <p>_____</p>	 <p><b>CHATROI</b></p> <p>_____</p>
 <p><b>PAML</b> <b>ETRE</b></p> <p>_____</p>	 <p><b>EJAL</b></p> <p>_____</p>	 <p><b>ARIN &amp; IHAL</b></p> <p>_____ &amp; _____</p>

### WORD BANK

**JAE**L      **SISER**A      **DEBOR**AH      **TEN**T  
**CHARI**OT      **RAIN & HAIL**      **BARAK**  
**PALM TREE**      **BAAL**

# Deborah

The story of Deborah is found in Judges 4 and 5. Deborah is the only female judge mentioned in the Bible. She was also a prophetess.

Deborah helped Barak go to battle against Sisera, the captain of the Canaanite army.

Sisera and his men ran away. Sisera hid in the tent of a woman named Jael. She gave him a drink and let him sleep. Then she killed him.

When Barak came he found Sisera dead.

Judges 5 is the song that Deborah sang about the battle.

Fit the underlined words into the acrostic puzzle.

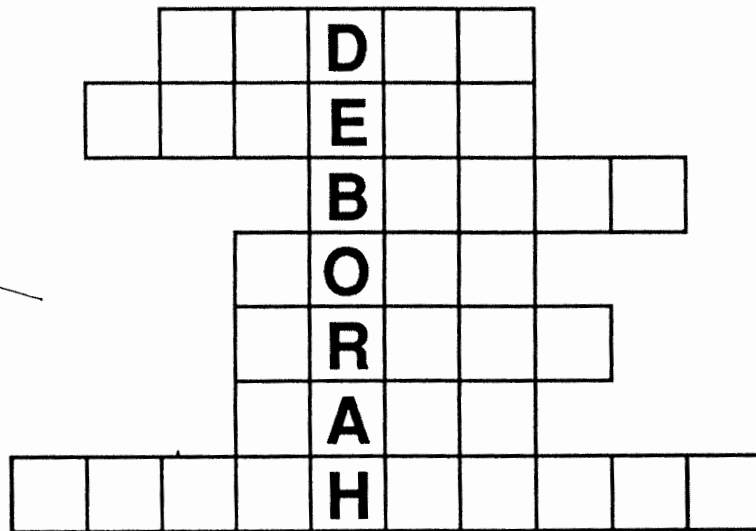

# Lead the Way

Read these statements from Judges 4. If the statement is true, follow the T path. If it is false, follow the F path. Write the word at the end of each path in the blank space.

1. The Israelites once again did evil (4:1).
2. The Lord sold them into the hands of Jabin (4:2).
3. Jabin cruelly oppressed them for 100 years (4:3).
4. Deborah was leading Israel at that time (4:4).
5. Sisera was the commander of Jabin's army (4:7).
6. Israelites came to Deborah to decide their disputes (4:5).
7. Barak led 10,000 men against Sisera (4:6).
8. Barak said he would never go (4:8).
9. All the troops of Sisera fell by the sword. Only two men were left (4:16).

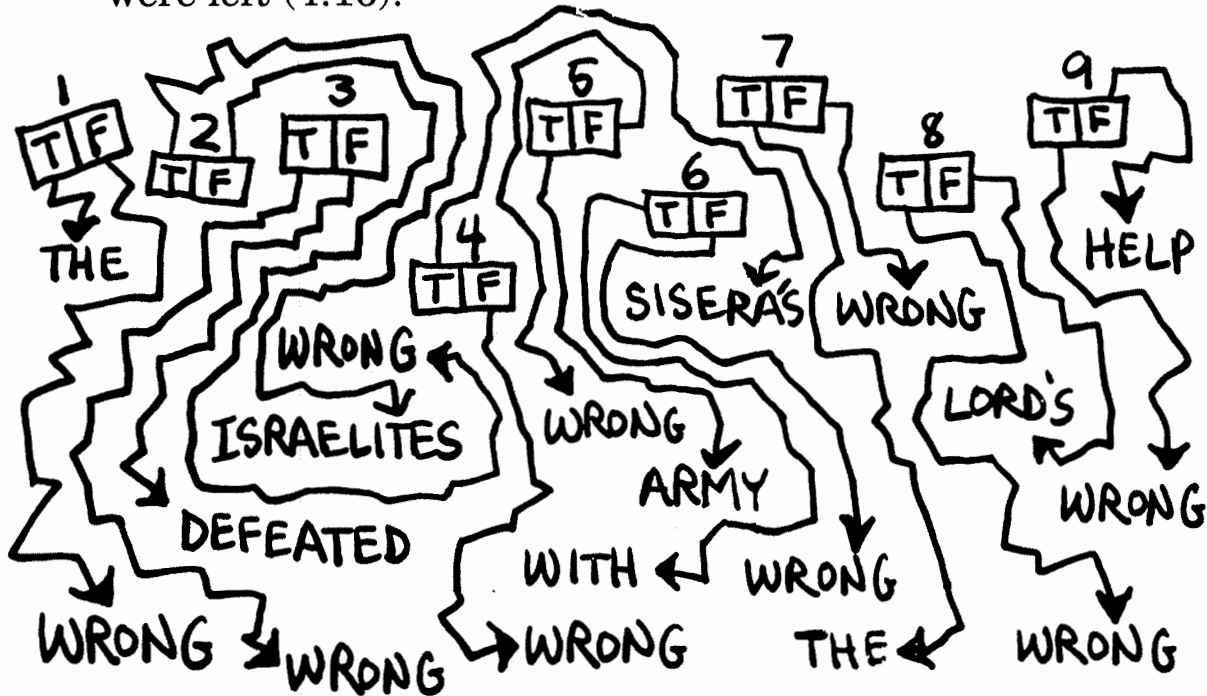

---



---



---



---



# 61. DEBORAH

## (JUDGES 4:1-23)

### MEMORY VERSE:

*"When the leaders lead in Israel, when the people willingly offer themselves, bless the LORD!" JUDGES 5:2*

### FILL IN THE BLANK:

1. "The children of Israel cried out to the LORD; for Jabin had nine hundred \_\_\_\_\_ of iron, and for twenty years he harshly oppressed the children of Israel." **JUDGES 4:3**

### CIRCLE THE CORRECT WORDS:

2. "Now (**DANDELION, DEBORAH**), a prophetess, the wife of Lapidoth, was (**JUDGING, VISITING**) Israel at that time." **JUDGES 4:4**
3. "And she would sit under the (**PINE, PALM**) tree of Deborah between Ramah and Bethel in the mountains of Ephraim." **JUDGES 4:5**
4. "And the children of Israel came up to her for (**JUDGMENT, FOOD**)." **JUDGES 4:5**
5. "She sent and called for (**BARBAR, BARAK**) the son of Abinoam from Kedesh in Naphtali, and said to him, 'Has not the LORD God of Israel commanded, saying, "Go and deploy troops at Mount Tabor; take with you ten thousand men of the sons of (**THUNDER, NAPHTALI**) and the sons of Zebulun?" ' " **JUDGES 4:6**
6. "And against you I will deploy (**SISSY, SISERA**), the commander of Jabin's army, with his chariots and his multitude at the River Kishon; and I will deliver him into your hand?" **JUDGES 4:7**

### TRUE OR FALSE:

7. "Barak said to her, 'If you will go with me, then I will go; but if you will not go with me, I will not go.'" **JUDGES 4:8**

TRUE OR FALSE

8. So she said, "I surely will not go with you!" **JUDGES 4:9**
- TRUE OR FALSE

### FILL IN THE BLANK:

9. "So on that day \_\_\_\_\_ subdued Jabin king of Canaan in the presence of the children of Israel." **JUDGES 4:23**

# Deborah

Judges 4:4-10

Deborah, a \_\_\_\_\_, the wife of Lappidoth, was leading \_\_\_\_\_ at that time. She held \_\_\_\_\_ under the Palm of \_\_\_\_\_ between Ramah and Bethel in the hill \_\_\_\_\_ of Ephraim, and the \_\_\_\_\_ came to her to have their \_\_\_\_\_ decided. She sent for Barak son of Abinoam from Kedesh in \_\_\_\_\_ and said to him, "The \_\_\_\_\_, the God of Israel, \_\_\_\_\_ and said to him, you: 'Go, take with you ten thousand men of Naphtali and \_\_\_\_\_ and lead the way to Mount \_\_\_\_\_ I will lure Sisera, the \_\_\_\_\_ of Jabin's \_\_\_\_\_, with his chariots and his troops to the \_\_\_\_\_ River and give him into your hands.'" \_\_\_\_\_ said to her, "If you go with me, I will go; but if you don't go with me, I won't go."

"Very \_\_\_\_\_," Deborah said, "I will go with you. But \_\_\_\_\_ of the way you are going about this, the \_\_\_\_\_ will not be yours, for the Lord will hand \_\_\_\_\_ over to a woman." So Deborah went with Barak to \_\_\_\_\_, where he \_\_\_\_\_ Zebulun and Naphtali. Ten \_\_\_\_\_ men followed him, and Deborah also \_\_\_\_\_ with him.

R L Q A R E D N A M O C P  
 P E O R N M L K K I S H O N  
 R A B E C A U S E J I S H W G  
 O R F S E D S E T U P S I D  
 P S C I C B A Z Y X W D L V  
 H I U S O W E N T N K L S  
 E T I S U R M Q P A O E C E  
 T N L M N L Y M S K J D O T  
 E D A I T M H U A G F E U I  
 S R T E R C O Z A N B S R L  
 S O H A Y H L A A Z D H T E  
 Y L P X T W L U B V T S B A  
 S R A Q O D E B O R A H A R S  
 H O N O R P W N R M L K R S  
 J I H G F N U L U B E Z A I  
 E S U M G F N U L E D D C B K A







# 61. DEBORAH

(JUDGES 4:1-23)

N A P H T A L I J U D G E W G  
 B N J C U J Z E B U L U N J R  
 L G L V L K H R B K I C A X K  
 L I E G S S L O W E O B X L Z  
 N C O B T M S J B O I U M A L  
 M N R A O D D E V N V V R R X  
 Z E I R I O I L T J M E G Q I  
 S B Y A R F P L B E S N Q C V  
 S P S K A P M A D I H V O R V  
 O U Y W H Q W G S E G P T H T  
 N M D H C R L H H S B M O N L  
 G R Y H Y K G G C Z D O H R C  
 V J B B L D S N O N O U R N P  
 M Z O X H F Z W Y W T O K A M  
 O F J B B S U B D U E D W V H

BARAK	JUDGE	SONG
CHARIOTS	NAPHTALI	SUBDUED
DEBORAH	PROPHETESS	ZEBULUN
JABIN	SISERA	

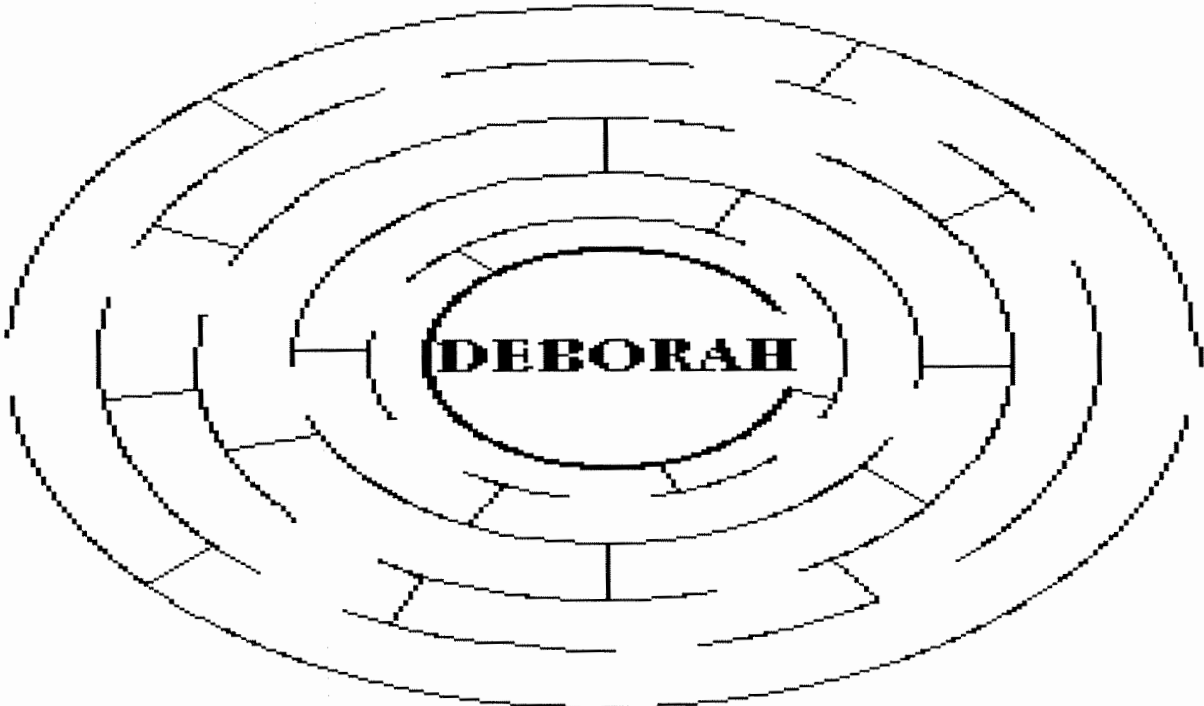

# 61. DEBORAH

## (JUDGES 4:1-23)

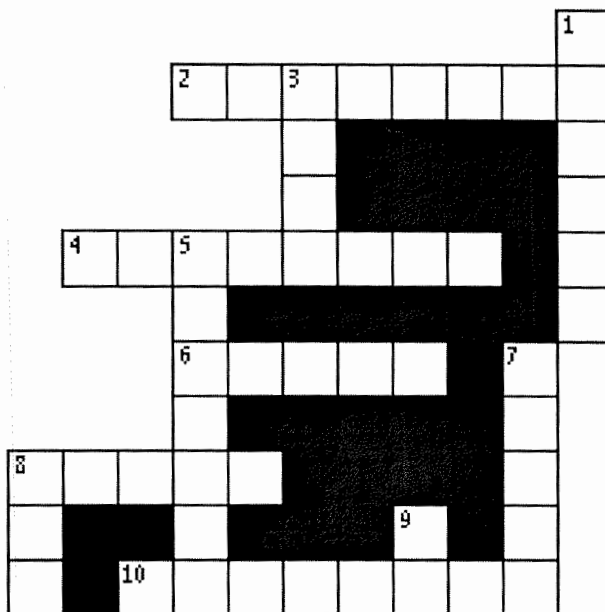

- 10 ACROSS "The children of Israel cried out to the LORD; for Jabin had nine hundred \_\_\_\_\_ of iron, and for twenty years he harshly oppressed the children of Israel." **JUDGES 4:3**
- 5 DOWN "Now \_\_\_\_\_, a prophetess, the wife of Lapidoth, was judging Israel at that time." **JUDGES 4:4**
- 3 DOWN "And she would sit under the \_\_\_\_\_ tree of Deborah between Ramah and Bethel in the mountains of Ephraim." **JUDGES 4:5**
- 4 ACROSS "And the children of Israel came up to her for \_\_\_\_\_." **JUDGES 4:5**
- 6 ACROSS "She sent and called for \_\_\_\_\_ the son of Abinoam from Kedesh in Naphtali." **JUDGES 4:6**
- 2 ACROSS She said to him, "Has not the LORD God of Israel commanded, saying, 'Go and deploy troops at Mount Tabor; take with you ten thousand men of the sons of \_\_\_\_\_ and the sons of Zebulun?' " **JUDGES 4:6**
- 1 DOWN "And against you I will deploy \_\_\_\_\_, the commander of Jabin's army, with his chariots and his multitude at the River Kishon; and I will deliver him into your hand?" **JUDGES 4:7**
- 9 DOWN "Barak said to her, 'If you will \_\_\_\_\_ with me, then I will go; but if you will not go with me, I will not go.' " **JUDGES 4:8**
- 8 ACROSS "So she said, 'I surely will go with you; nevertheless there will be no \_\_\_\_\_ for you in the journey you are taking.' " **JUDGES 4:9**
- 8 DOWN "So on that day \_\_\_\_\_ subdued Jabin king of Canaan in the presence of the children of Israel." **JUDGES 4:23**
- 7 DOWN "When the leaders lead in Israel, when the people willingly offer themselves, \_\_\_\_\_ the LORD!" **JUDGES 5:2**

**Year 2**

**Week 57**

## **Gideon and the Angel**

**Scriptures: Judges 6**

**Key Verse: Judges 6:12** **And the angel of the LORD appeared to him and said, “The LORD is with you, you mighty man of valor!”**

### **Key Points:**

1. The Midianites were enemies of Israel who came and destroyed the crops of the Israelites. The Israelites were starving, and tried to hide their remaining food supplies. They cried out to the Lord.
2. God sent an angel to Gideon while he was threshing wheat in a winepress. He told Gideon that God had chosen him to defeat the Midianites.
3. Gideon asked for a sign and prepared an offering of meat and unleavened bread. Fire consumed the offering and the angel disappeared.
4. God instructed Gideon to tear down the idol of Baal that the people worshipped and build an altar to God. Because he was afraid of the people, Gideon did this at night. Afterwards the people wanted to kill Gideon. Joash, Gideon's father reminded them that if Baal was a real god, he could punish Gideon himself.
5. Gideon asked God for another sign. He put a piece of fleece (wool) on the ground. The first time he asked for it to be wet and the ground around it to be dry. The next time he asked for the fleece to be dry while the ground was wet. God did so. Gideon was convinced and ready to fight.

## 62. THE CALLING OF GIDEON

(JUDGES 6:11-40)



"And Gideon said unto God, If thou wilt save Israel by mine hand, as thou hast said, behold, I will put a fleece of wool in the floor; *and* if the dew be on the fleece only, and *it be* dry upon all the earth *beside*, then shall I know that thou wilt save Israel by mine hand, as thou hast said."

**JUDGES 6:36-37**

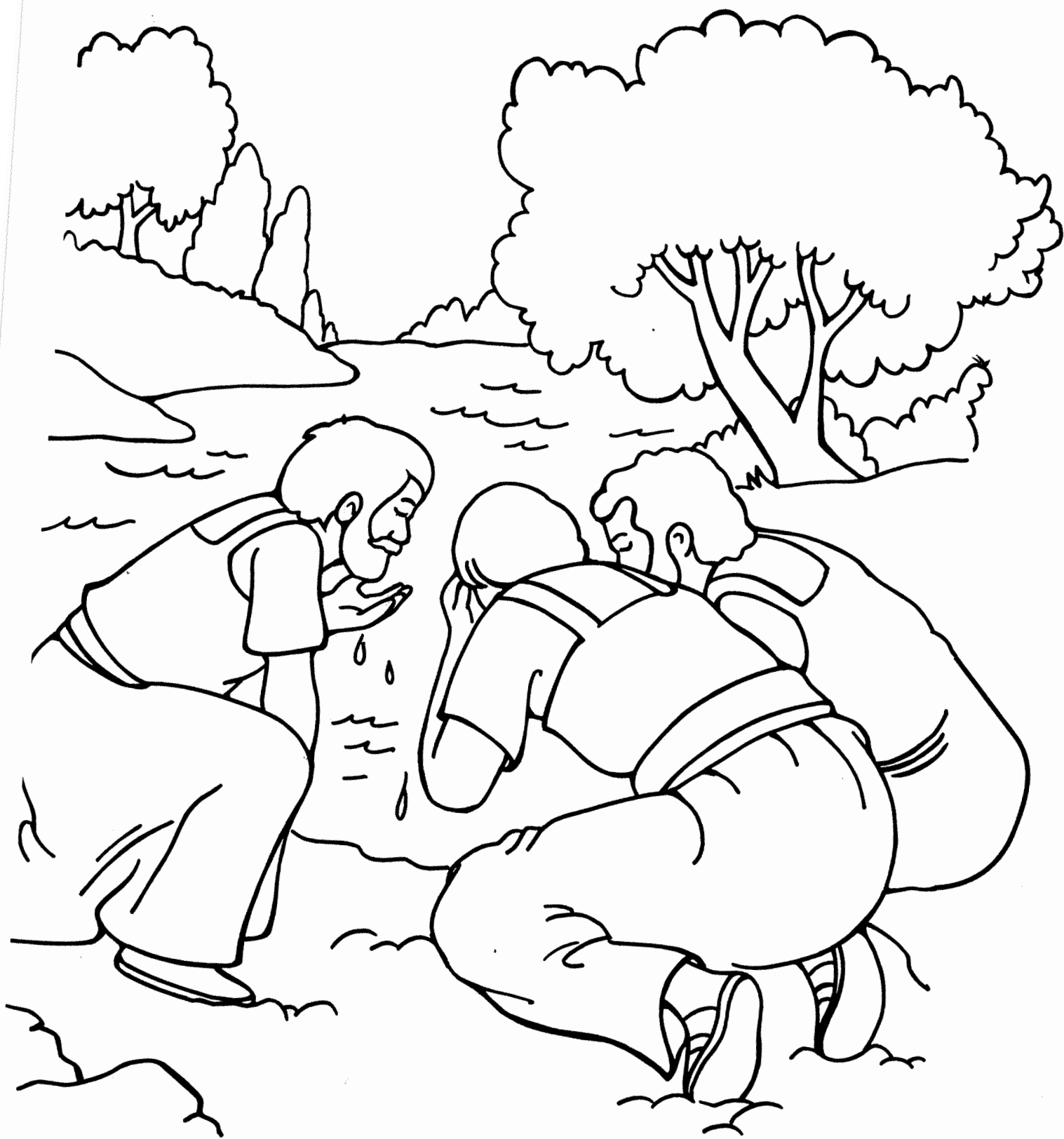

Gideon Is Brave  
Judges 6, 7



Even though God had chosen him, Gideon was scared.  
An angel came to him and said, "Don't be afraid.  
God is with you, mighty warrior!"

Judges 6:11-12

The angel of the LORD came and sat down under the oak in Ophrah that belonged to Joash the Abiezrite, where his son Gideon was threshing wheat in a winepress to keep it from the Midianites. When the angel of the LORD appeared to Gideon, he said, "The LORD is with you, mighty warrior."

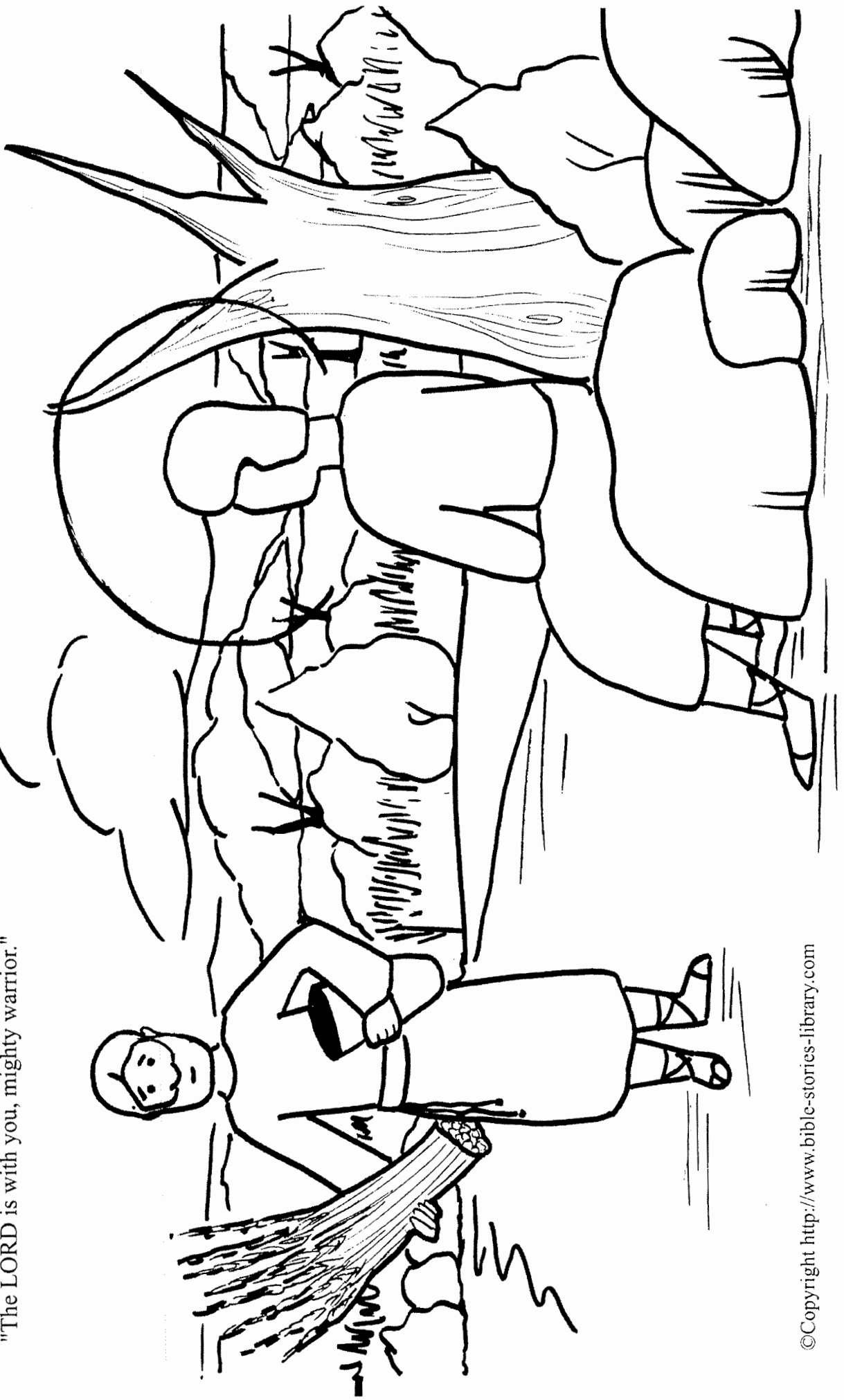

## Angel Paper Heart Craft

Print out template. Cut template pieces out. Cut heart shapes out of construction paper. Color angel face and glue pieces together as shown. Decorate with ribbons, glitter, etc.



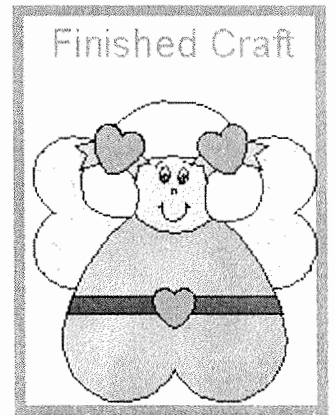
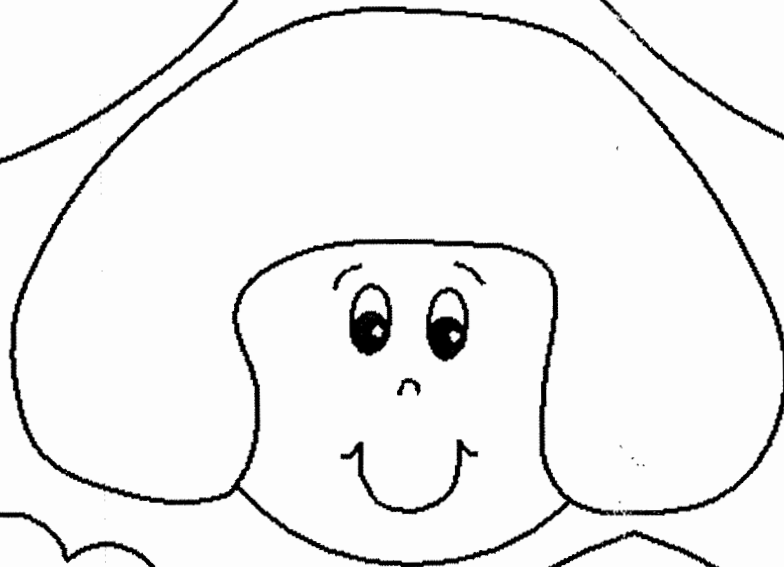
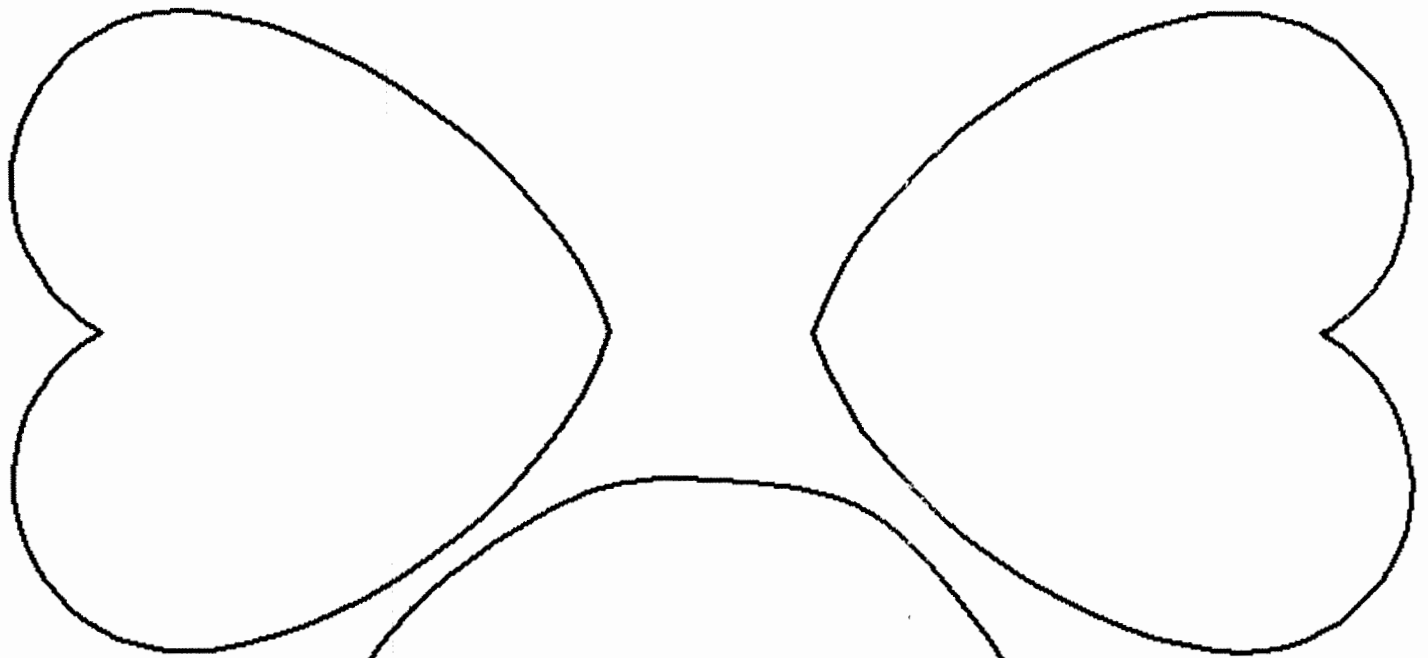

Finished Craft

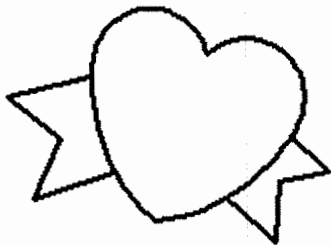

hair ribbons

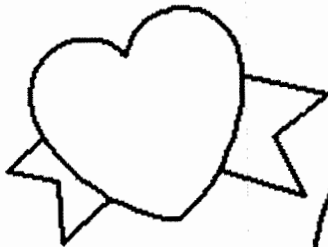

belt

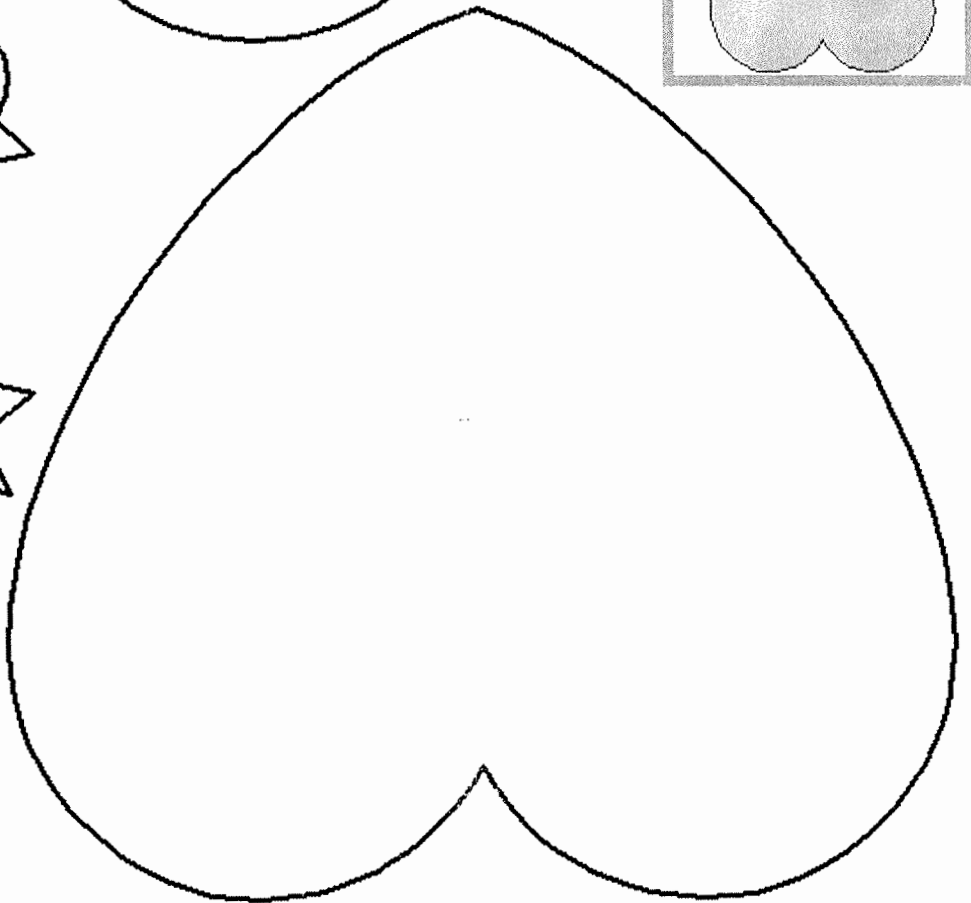

# Gideon

d	j	a	r	s	u	d	p	d	g	s	z	d	w	t
t	r	u	m	p	e	t	s	n	r	t	s	e	i	u
h	i	c	a	l	t	a	r	p	o	y	g	r	o	n
g	a	b	m	a	n	a	s	s	e	h	i	d	i	e
d	r	o	w	s	r	b	s	f	j	a	d	n	z	s
z	m	z	i	q	u	f	r	v	e	s	e	u	y	e
c	y	w	o	o	l	q	d	c	i	i	o	h	k	h
y	k	j	n	g	z	c	e	a	w	z	n	e	w	c
q	z	n	r	v	l	e	d	l	z	g	v	e	a	r
j	k	a	v	z	l	p	w	f	r	z	n	r	r	o
i	t	i	r	f	a	n	g	e	l	e	b	h	r	t
j	o	d	b	a	w	d	p	g	e	z	z	t	i	f
d	r	i	q	d	e	a	s	i	g	n	l	j	o	n
e	z	m	u	z	l	f	b	k	n	i	r	d	r	j
w	u	v	d	r	e	a	m	f	c	g	p	t	l	v

**Gideon**

**Angel**

**Warrior**

**Midian**

**Manasseh**

**Sign**

**Altar**

**Wool**

**Fleece**

**Dew**

**Dry**

**Fear**

**Lap**

**Drink**

**Dream**

**Sword**

**Trumpets**

**Jars**

**Torches**

**Three hundred**

## 62. THE CALLING OF GIDEON (JUDGES 6:11-40)

A V A L O R I L K Q W U Y W D  
 S N T K D Y E G R N W F L Q W  
 M Q G B W A A H E Y Z L D N T  
 J X T E R F R R N M O Y F I L  
 T N R S L O W D C F L E E C E  
 A A I E K O I V V A A D E W A  
 R Y R T I J F G C S K H B S O  
 A Q W I E W F T N V U R E V A  
 T U P N P E U B H I N O H U P  
 L Y N A I G T G C E R L A A B  
 A R T I B A I C H Y L E T U A  
 A D S D B M O D R K U O F A D  
 U Q A I B I M Z E W D I R F Y  
 E T E M P S J H E O L R L D O  
 N H L C P S K K M L N F U D S

ALTAR  
 ANGEL OF THE LORD  
 BAAL  
 DEW  
 DRY

FLEECE  
 GIDEON  
 IMAGE  
 ISRAEL

LEAST  
 MIDIANITES  
 OFFERING  
 VALOR

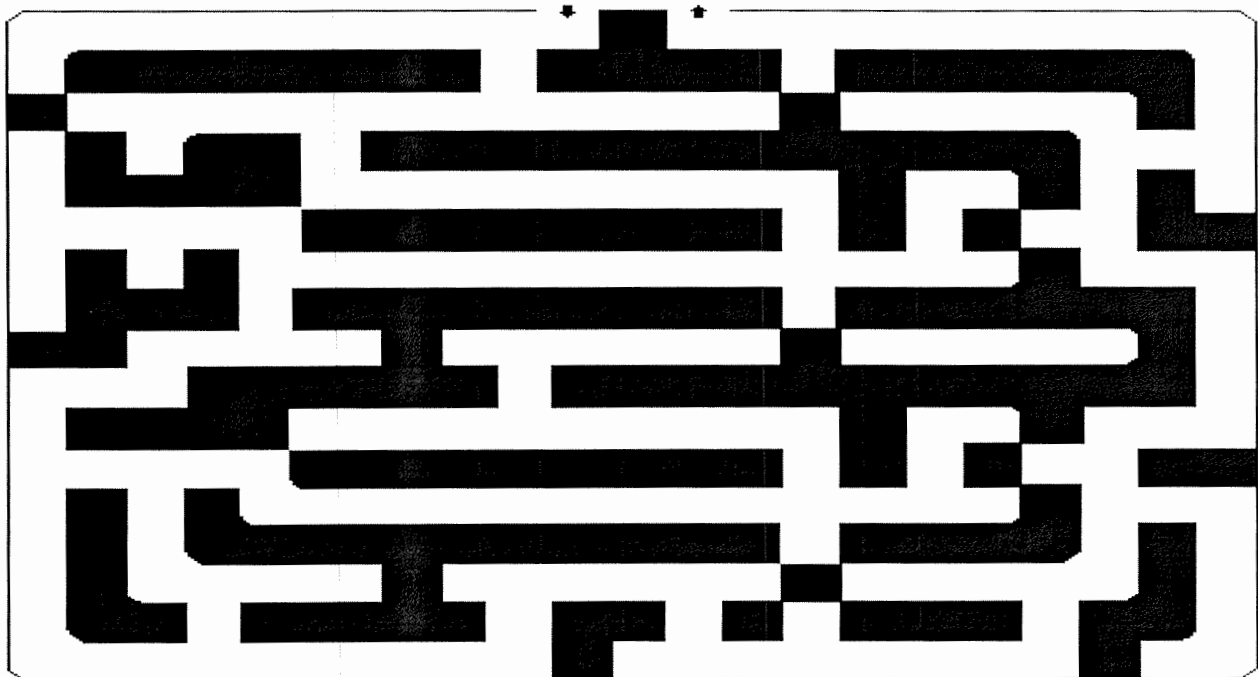

# Gideon

DENS  
CAVES  
GRASSHOPPERS  
OAK  
BASKET

ROCK  
FIRE  
FLEECE  
DEW  
TENT

BREAD  
LAMP  
PITCHERS  
TRUMPETS  
SWORDS

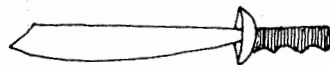

What a strange list of words! See how these words fit together by reading the story of Gideon in Judges 6, 7, and 8. Then fit the words in the puzzle.

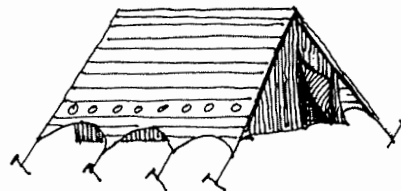
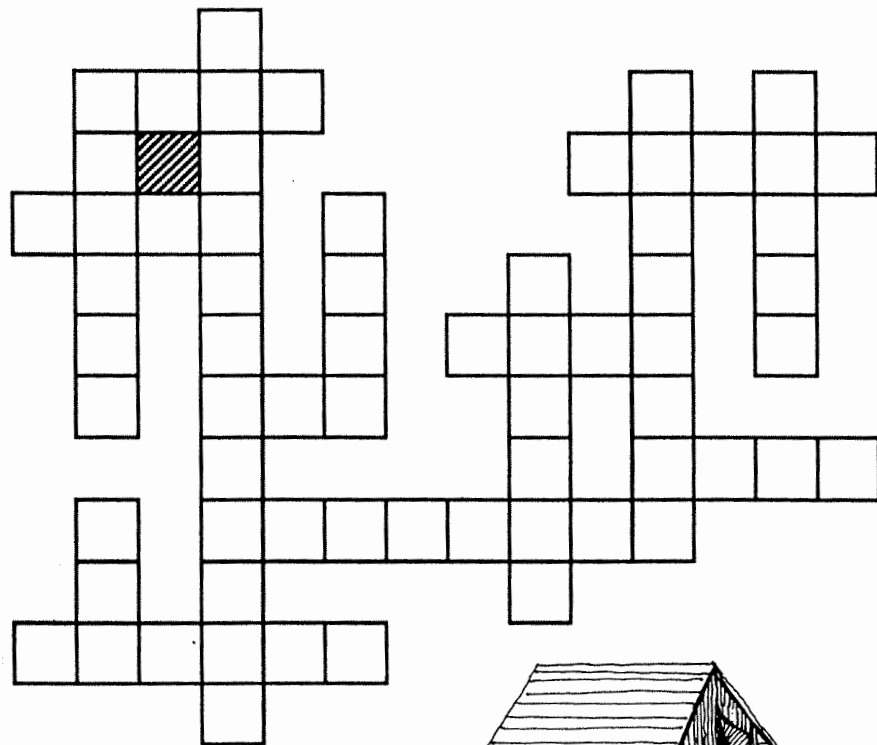

**Gideon**  
**Judges 6, 7**

# Impossible Odds

The Midianites invaded the land of Israel with so many men and camels that it was impossible to count them. Gideon had an army of only three hundred men. Use the missing alphabet puzzle to discover how Gideon was able to defeat such a mighty enemy. Find which letter is missing from each line and write it in the spaces below.

ABCDEF GHIJKLMNOPQRSUVWXYZ  
 ABCDEF GHIJKLMNOPQRSTUUVWXYZ  
 ABCDEF GHIJKLMNOPQRSTUUVWXYZ

ABCDEF GHIJKMNOPQRSTUVWXYZ  
 ABCDEF GHIJKLMNPQRSTUVWXYZ  
 ABCDEF GHIJKLMNOPQRSTUVWXYZ  
 ABCDEF GHIJKLMNOPQRSTUVWXYZ

ABDEF GHIJKLMNOPQRSTUVWXYZ  
 ABCDEF GHIJKLMNPQRSTUVWXYZ  
 ABCDEF GHIJKLMOPQRSTUVWXYZ  
 ABCDE GHIJKLMNOPQRSTUVWXYZ  
 ABCDEF GHIJKLMNOPQRSTVWXYZ  
 ABCDEF GHIJKLMNOPQRTUUVWXYZ  
 ABCDF GHIJKLMNOPQRSTUVWXYZ  
 ABCDEF GHIJKLMNOPQRSTUVWXYZ

ABCDEF GHIJKLMNOPQRSUVWXYZ  
 ABCDEF GHIJKLMNOPQRSTUUVWXYZ  
 ABCDF GHIJKLMNOPQRSTUUVWXYZ

ABCDF GHIJKLMNOPQRSTUVWXYZ  
 ABCDEF GHIJKLMOPQRSTUVWXYZ  
 ABCDF GHIJKLMNOPQRSTUVWXYZ  
 ABCDEF GHIJKLNOPQRSTUVWXYZ  
 ABCDEF GHIJKLMNOPQRSTUVWXYZ

ABCDEF GHIJKLMNOPQRTUUVWXYZ  
 ABCDEF GHIJKLMNPQRSTUVWXYZ  
 ABCDEF GHIJKMNOPQRSTUVWXYZ  
 ABCDEF GHIJKLMNOPQRSTUVWXYZ  
 ABCDEF GHIJKLMNOPQRSTUVWXYZ  
 ABCDEF GHIJKLMNOPQRSTUVWXYZ  
 ABCDEF GHIJKLMNOPQRSTUVWXYZ  
 ABCDEF GHIJKLMNOPQRSTUVWXYZ

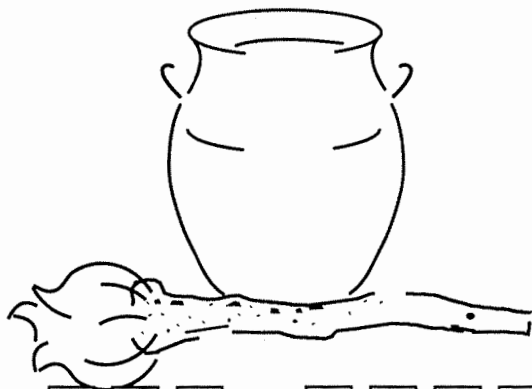

# What Should You Do?

God chose Gideon to save his people. This seemed like a hard thing to Gideon, but he did something that helped him trust in God.

In the word pairs below, one word has a letter that is not in the other word. Write the extra letters you find in the squares. They will spell three words that will tell you what Gideon did, and what you can do when you are facing a tough job.

1. You can find me in PINK but not in KIN.

1	2	3	4
---	---	---	---

2. You can see me in DROP but not in POD.

5	6
---	---

3. I'm right there in READ but not in RED.

4. See me in YOWL but not in LOW.

7	8	9
---	---	---

5. Find me in THEN but not in HEN.

6. I am in COAT, but not in CAT.

7. Here I am in GEAR but not in ARE.

8. I'm found in BOAT but not in BAT.

9. Now I'm in DONE but not in ONE.



## 62. THE CALLING OF GIDEON (JUDGES 6:11-40)

### MEMORY VERSE:

"And the LORD said to him, 'Surely I will be with you, and you shall defeat the Midianites as one man.'" JUDGES 6:16

### FILL IN THE BLANK:

1. "Now the Angel of the LORD came and sat under the terebinth tree which was in Ophrah, which belonged to Joash the Abiezrite, while his son \_\_\_\_\_ threshed wheat in the winepress, in order to hide it from the Midianites." JUDGES 6:11

### TRUE OR FALSE:

2. "And the Angel of the LORD appeared to him, and said to him, 'The LORD is with you, you mighty man of valor!'" JUDGES 6:12

TRUE OR FALSE

### CIRCLE THE CORRECT WORDS:

3. "Then the LORD turned to him and said, 'Go in this (**MIGHT, SIGHT**) of yours, and you shall (**SAVE, LOSE**) Israel from the hand of the Midianites. Have I not sent you?' " JUDGES 6:14
4. "So he said to Him, 'O my Lord, how can I save Israel? Indeed my clan is the (**STRONGEST, WEAKEST**) in Manasseh, and I am the (**LEAST, GREATEST**) in my father's house.'" JUDGES 6:15
5. "And the LORD said to him, 'Surely I will be with you, and you shall (**SEE, DEFEAT**) the Midianites as one man.'" JUDGES 6:16

### TRUE OR FALSE:

6. "Now it came to pass the same night that the LORD said to him, 'Take your father's young bull, the second bull of seven years old, and tear down the altar of Baal that your father has, and cut down the wooden image that is beside it.'" JUDGES 6:25

TRUE OR FALSE

### FILL IN THE BLANK:

7. The LORD also said, "Build an altar to the LORD your God on top of this rock in the proper arrangement, and take the second bull and offer a burnt \_\_\_\_\_ with the wood of the image which you shall cut down." JUDGES 6:26

### CIRCLE THE CORRECT WORDS:

8. "Gideon said to God, 'If You will save Israel by my hand as You have said-- look, I shall put a (**PIECE, FLEECE**) of wool on the threshing floor.'" JUDGES 6:36-37
9. "If there is dew on the fleece (**ONLY, ALSO**), and it is dry on the ground, then I shall (**KNOW, GUESS**) that You will save Israel by my hand, as You have said.'" JUDGES 6:37
10. "And it was so. When he rose early the next morning and squeezed the fleece together, he wrung the dew out of the fleece, a bowl (**FULL, EMPTY**) of water." JUDGES 6:38
11. "Then Gideon said to God, 'Do not be angry with me, and let me speak just once more: Let me test, I pray, just once more with the fleece; let it now be (**DRY, DUSTY**) only on the fleece, but on the ground let there be dew.'" JUDGES 6:39
12. "And God did so that night. It was dry on the fleece only, but there was (**DIRT, DEW**) on all the ground." JUDGES 6:40

## 62. THE CALLING OF GIDEON (JUDGES 6:11-40)

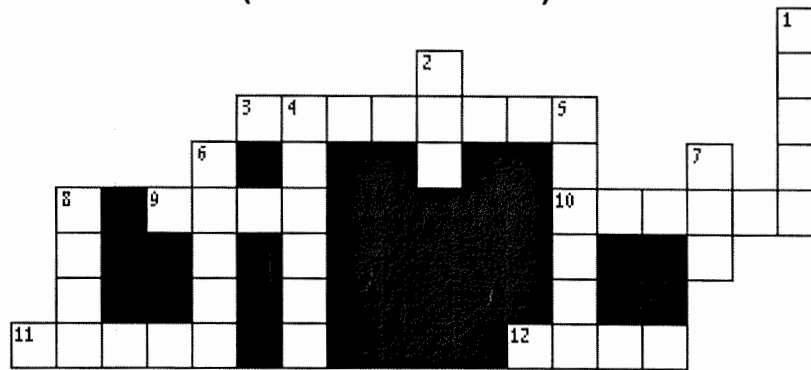

- 5 DOWN "Now the Angel of the LORD came and sat under the terebinth tree which was in Ophrah, which belonged to Joash the Abiezrite, while his son \_\_\_\_\_ threshed wheat in the winepress, in order to hide it from the Midianites." **JUDGES 6:11**
- 6 DOWN "And the Angel of the LORD appeared to him, and said to him, 'The LORD is with you, you mighty man of \_\_\_\_\_!' " **JUDGES 6:12**
- 9 ACROSS "Then the LORD turned to him and said, 'Go in this might of yours, and you shall \_\_\_\_\_ Israel from the hand of the Midianites. Have I not sent you?' " **JUDGES 6:14**
- 1 DOWN "So he said to Him, 'O my Lord, how can I save Israel? Indeed my clan is the strongest in Manasseh, and I am the \_\_\_\_\_ in my father's house.' " **JUDGES 6:15**
- 10 ACROSS "And the LORD said to him, 'Surely I will be with you, and you shall \_\_\_\_\_ the Midianites as one man.' " **JUDGES 6:16**
- 11 ACROSS "Now it came to pass the same night that the LORD said to him, 'Take your father's young bull, the second bull of seven years old, and tear down the \_\_\_\_\_ of Baal that your father has, and cut down the wooden image that is beside it.' " **JUDGES 6:25**
- 3 ACROSS The LORD also said, "Build an altar to the LORD your God on top of this rock in the proper arrangement, and take the second bull and offer a burnt \_\_\_\_\_ with the wood of the image which you shall cut down." **JUDGES 6:26**
- 4 DOWN "Gideon said to God, 'If You will save Israel by my hand as You have said-- look, I shall put a \_\_\_\_\_ of wool on the threshing floor.' " **JUDGES 6:36-37**
- 12 ACROSS "If there is dew on the fleece only, and it is dry on the ground, then I shall \_\_\_\_\_ that You will save Israel by my hand, as You have said.' " **JUDGES 6:37**
- 8 DOWN "And it was so. When he rose early the next morning and squeezed the fleece together, he wrung the dew out of the fleece, a bowl \_\_\_\_\_ of water." **JUDGES 6:38**
- 2 DOWN "Then Gideon said to God, 'Do not be angry with me, and let me speak just once more: Let me test, I pray, just once more with the fleece; let it now be \_\_\_\_\_ only on the fleece, but on the ground let there be dew.' " **JUDGES 6:39**
- 7 DOWN "It was dry on the fleece only, but there was \_\_\_\_\_ on all the ground." **JUDGES 6:40**



**Year 2**

**Week 58**

## **Gideon and God Win**

**Scriptures: Judges 7**

**Key Verse: Judges 7:20 Then the three companies blew the trumpets and broke the pitchers...and they cried, "The sword of the LORD and of Gideon!"**

### **Key Points:**

1. Finally convinced that God was with him, Gideon began to lead Israel.
2. The Lord cut about 30,000 men from Gideon's army, leaving him with 300 men to fight the Midianites.
3. God sent Gideon and his servant to the camp of the Midianites, where they overheard a man telling his dream to a friend. The friend interpreted the dream to mean that God would deliver the whole camp to Gideon's army.
4. Gideon divided his men into three groups and gave them trumpets and torches hidden inside empty pitchers. At Gideon's signal, every man blew his trumpet and broke the pitchers covering the lamps.
5. The Midianites panicked and started killing each other and running away, and the Israelites were able to follow and defeat the large army.

# GOD'S MIGHTY WARRIOR



God's people had to fight many battles in the Promised Land. A farmer named Gideon led the people to fight for God.



God told Gideon to sneak into the enemy camp with only trumpets and torches covered with jars.



When Gideon's army blew their trumpets and smashed their jars, the enemy woke up, got scared, and ran away!

## 63. GIDEON'S ARMY OF 300 (JUDGES 7:1-25)



“And the three companies blew the trumpets, and brake the pitchers, and held the lamps in their left hands, and the trumpets in their right hands to blow *withal*: and they cried, The sword of the LORD, and of Gideon.”

**JUDGES 7:20**

# Choosing an Army

Gideon was chosen to lead the Israelites in battle against the Midianites. Such a great army of Israelites came together that every man who was afraid of the Midianites was allowed to return to his home. Two out of every three men left, but the army was still too large. So God arranged another test. Read about it in Judges 7:1-7 and you will know which of the soldiers in the picture stayed in the army. Color red the robes of those who stayed. Color the others green.

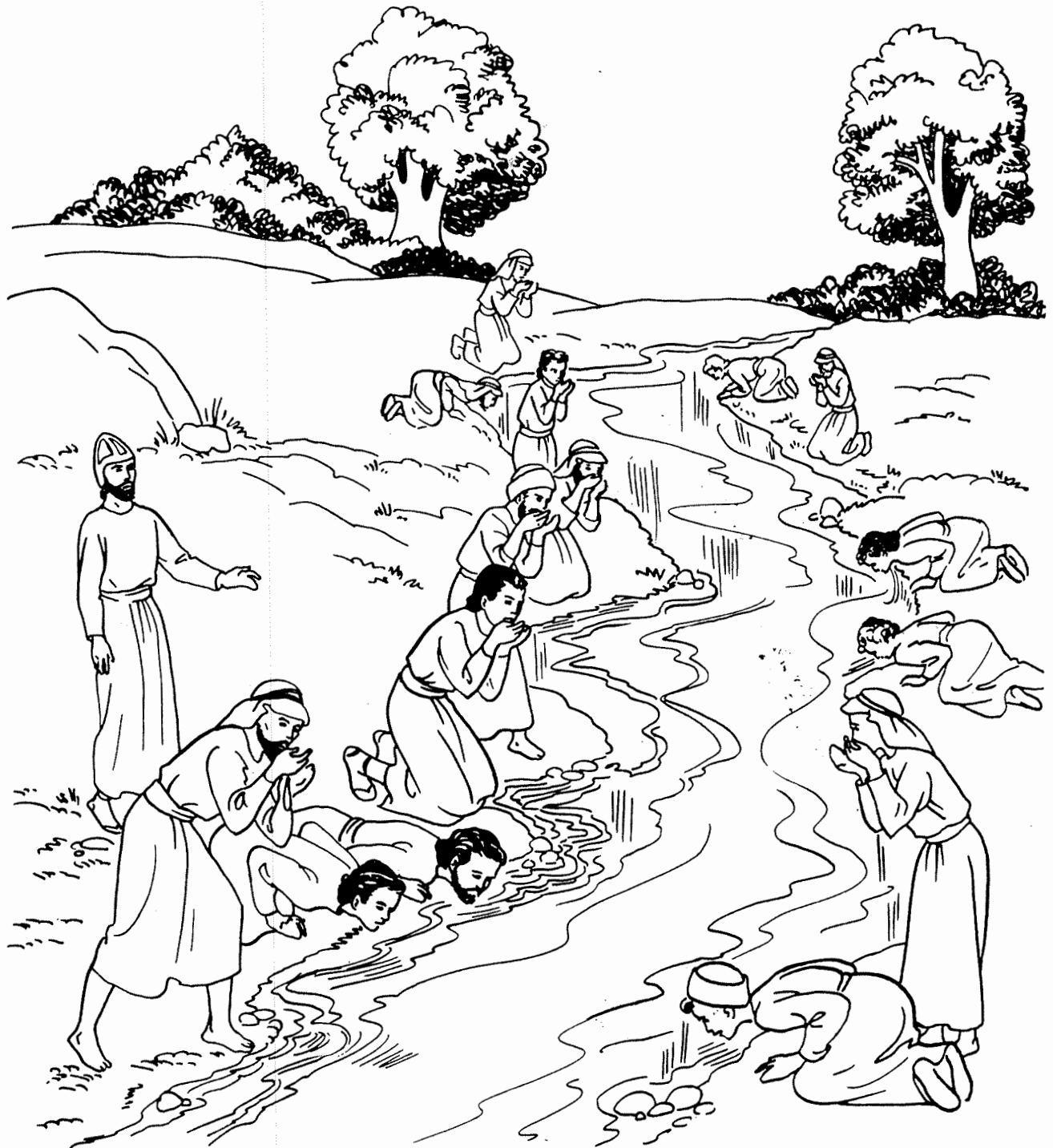

# Important Tools

Circle the three things God told Gideon's army to bring.

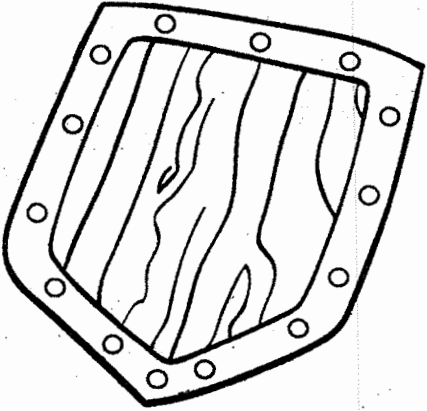
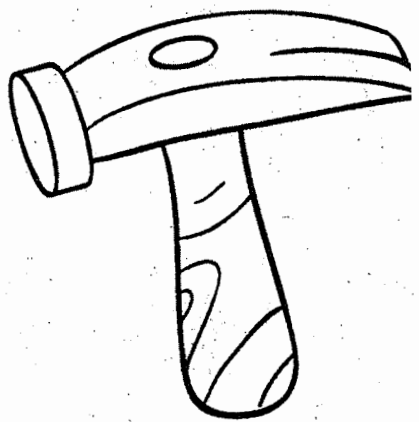
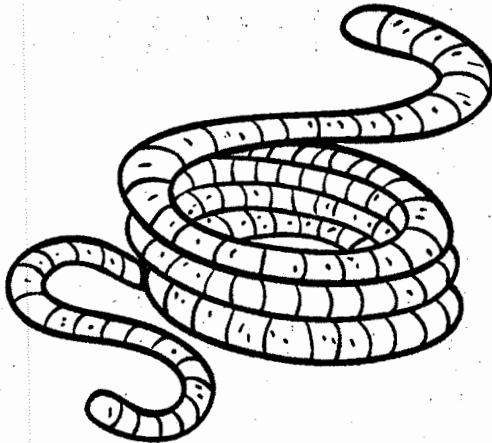





Judges 7:20

The three companies blew the trumpets and smashed the jars. Grasping the torches in their left hands and holding in their right hands the trumpets they were to blow, they shouted, "A sword for the LORD and for Gideon!"

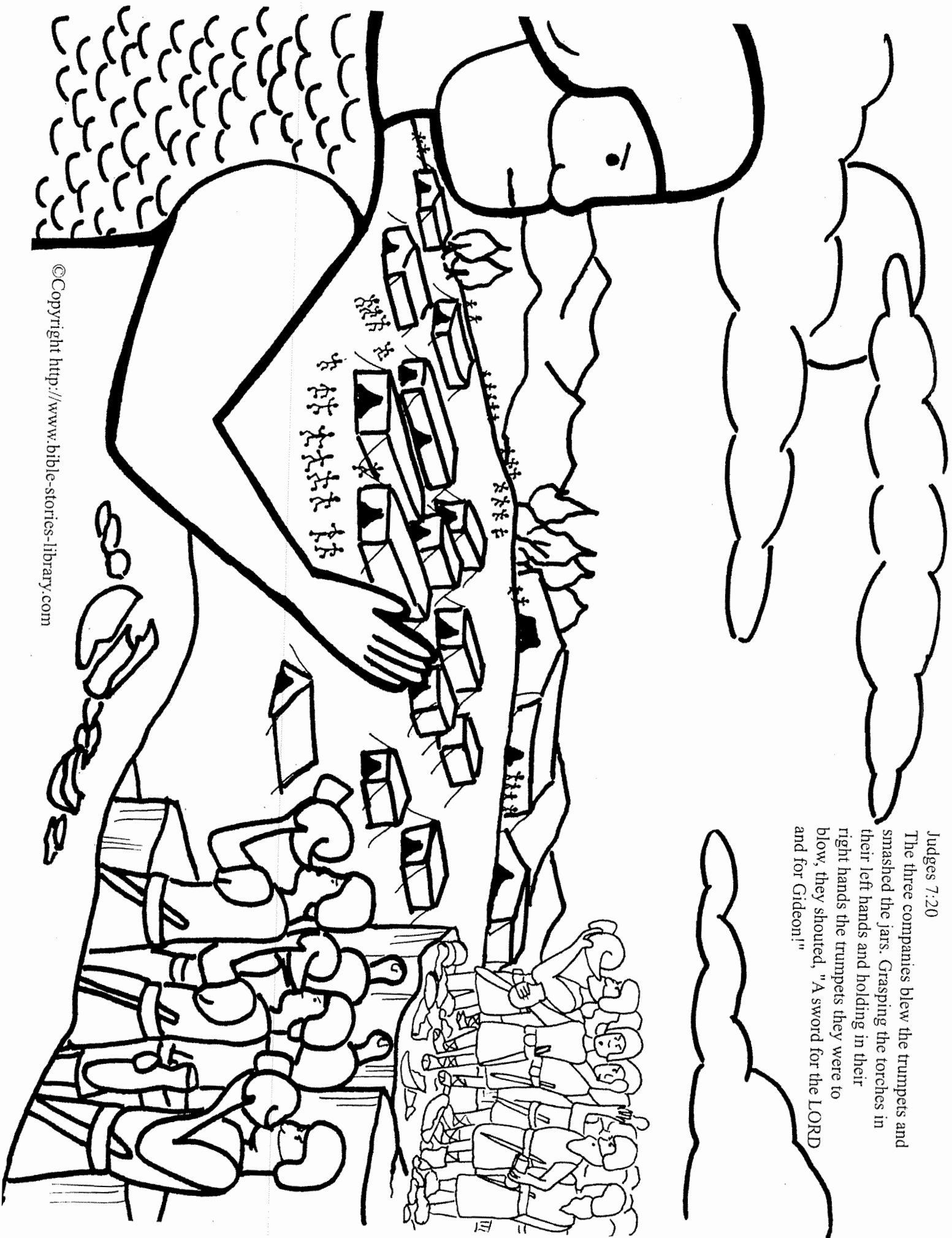

## Judges 6, 7—Gideon Is Brave

# Gideon's Horn

### Directions

Color and cut out Gideon's Horn as one piece. Roll the horn into the shape of a megaphone and tape the tab behind the first scene. Use the horn to act out the Bible story, or retell the story of Gideon's bravery using the three scenes as a guide:

- 1) An angel appeared to Gideon to tell him to save God's people from the Midianites.
- 2) Gideon took an army of just 300 men to fight with him.
- 3) Gideon's army blew their trumpets, broke their jars, held their torches, and won the battle.

### Supplies

copies of Gideon's Horn for each child  
crayons or markers  
scissors  
tape

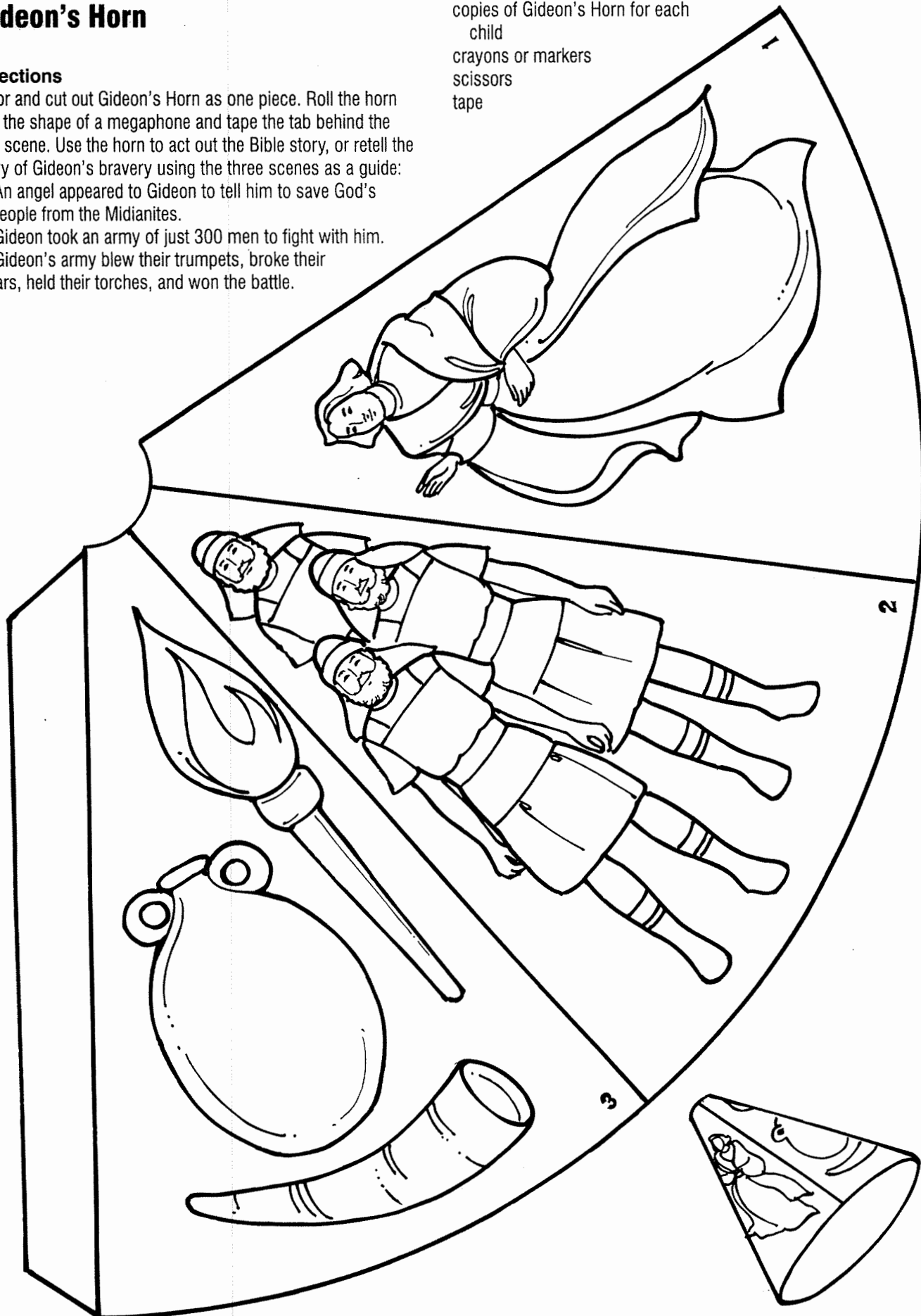

Bible for Children

presents

GIDEON'S  
LITTLE  
ARMY

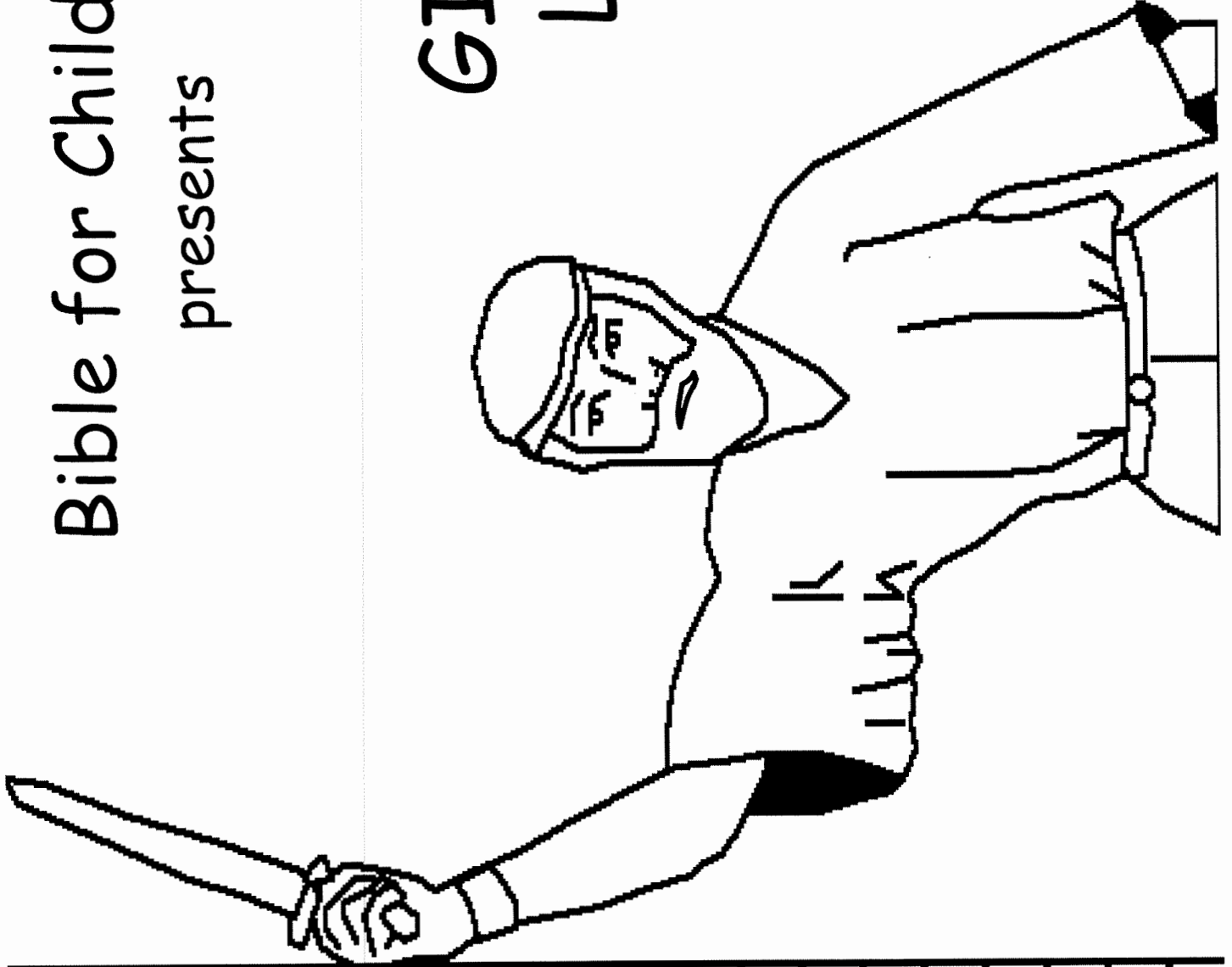

After Joshua died, all the people of Israel disobeyed God and left Him out of their lives.

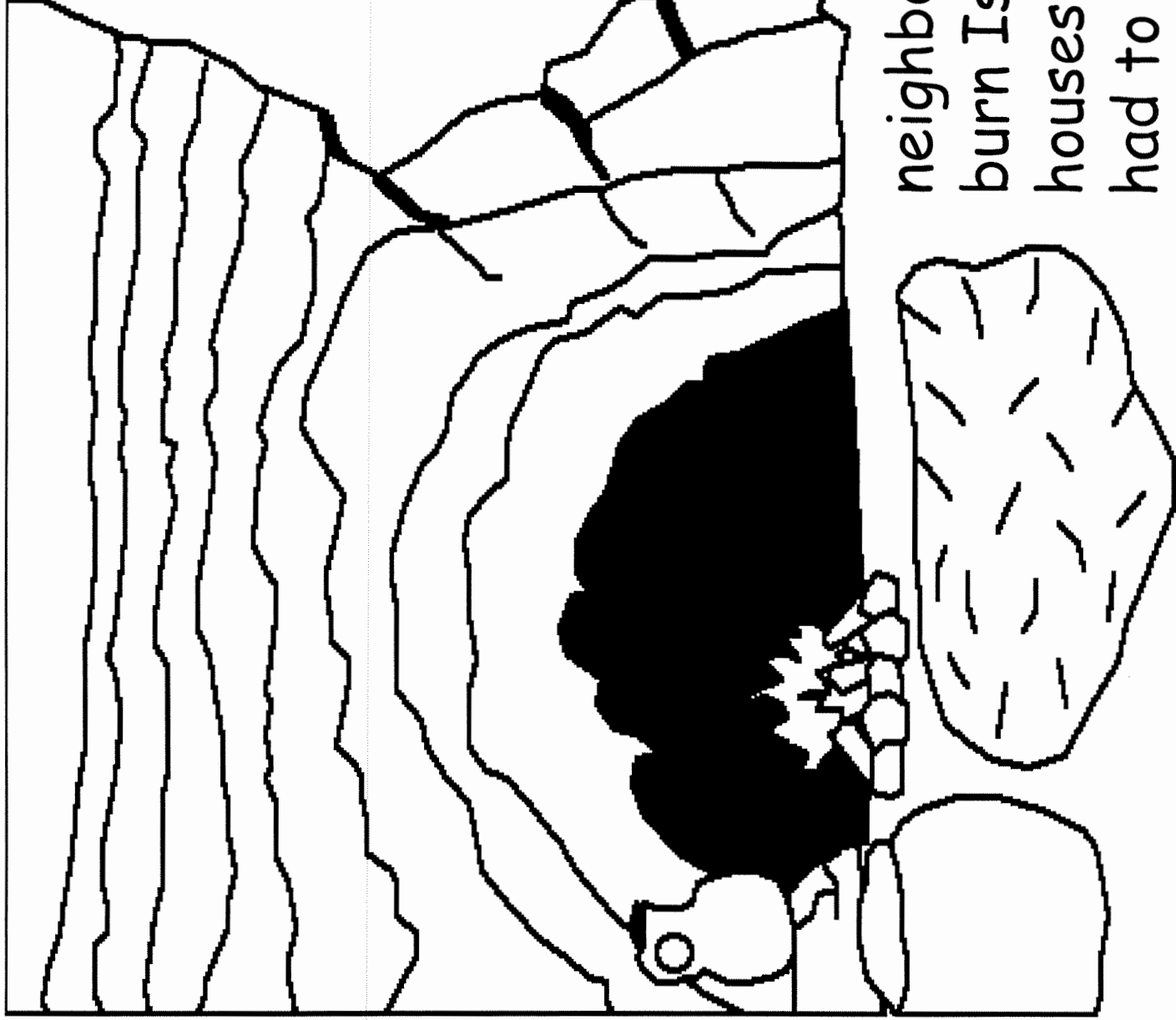

God let the neighboring Midianites burn Israel's crops and houses. The Israelites had to live in caves.



One Israelite, Gideon, must have had a secret place to grow wheat. He threshed the grain by a hidden winepress, under a large tree.

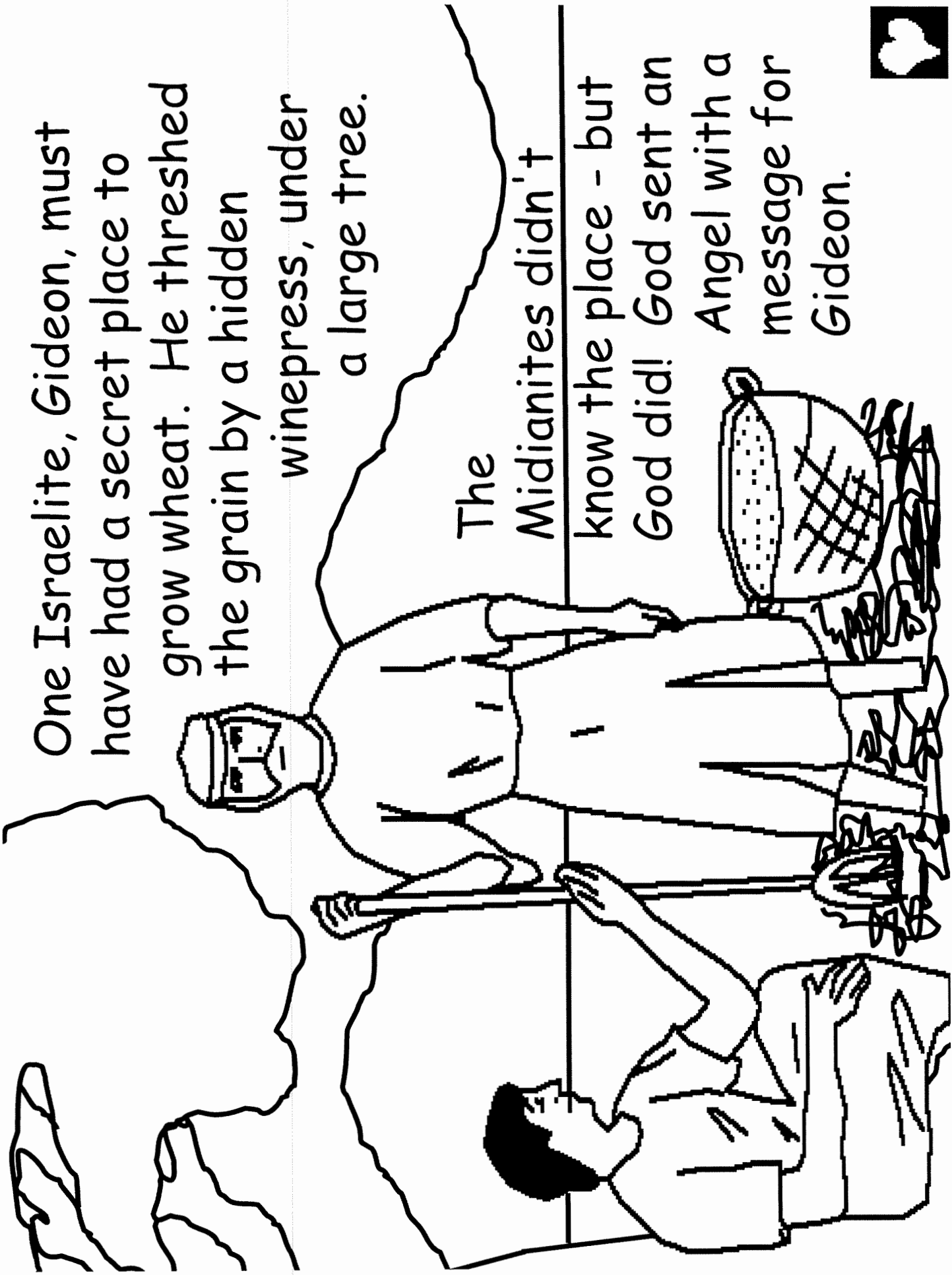

The Midianites didn't know the place - but God did! God sent an Angel with a message for Gideon.



God wanted Gideon to destroy his own father's image of a false god and build an altar to the true God. Though Gideon was afraid his countrymen would kill him, he did what God commanded.

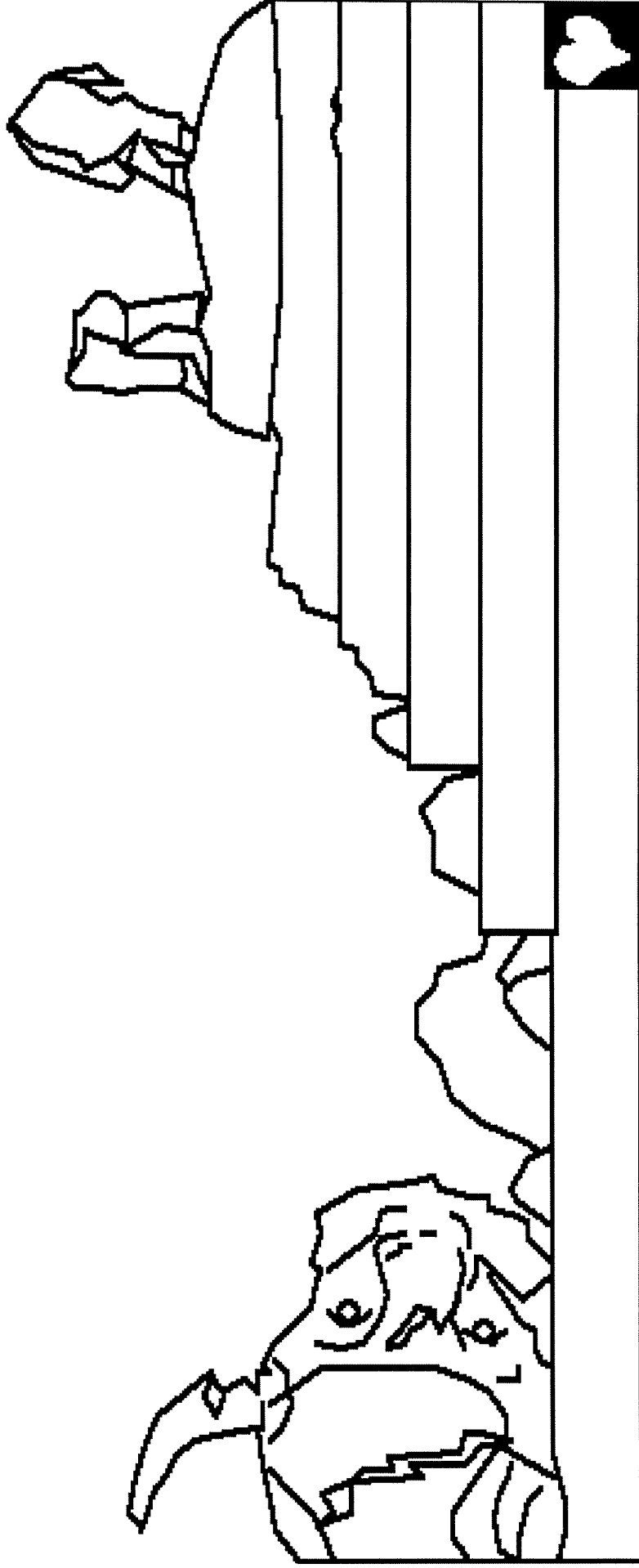

God also wanted Gideon to lead Israel's army against the wicked Midianites. But Gideon was afraid. He asked for a special sign that God was with him. Then he laid a fleecy sheepskin on the ground.

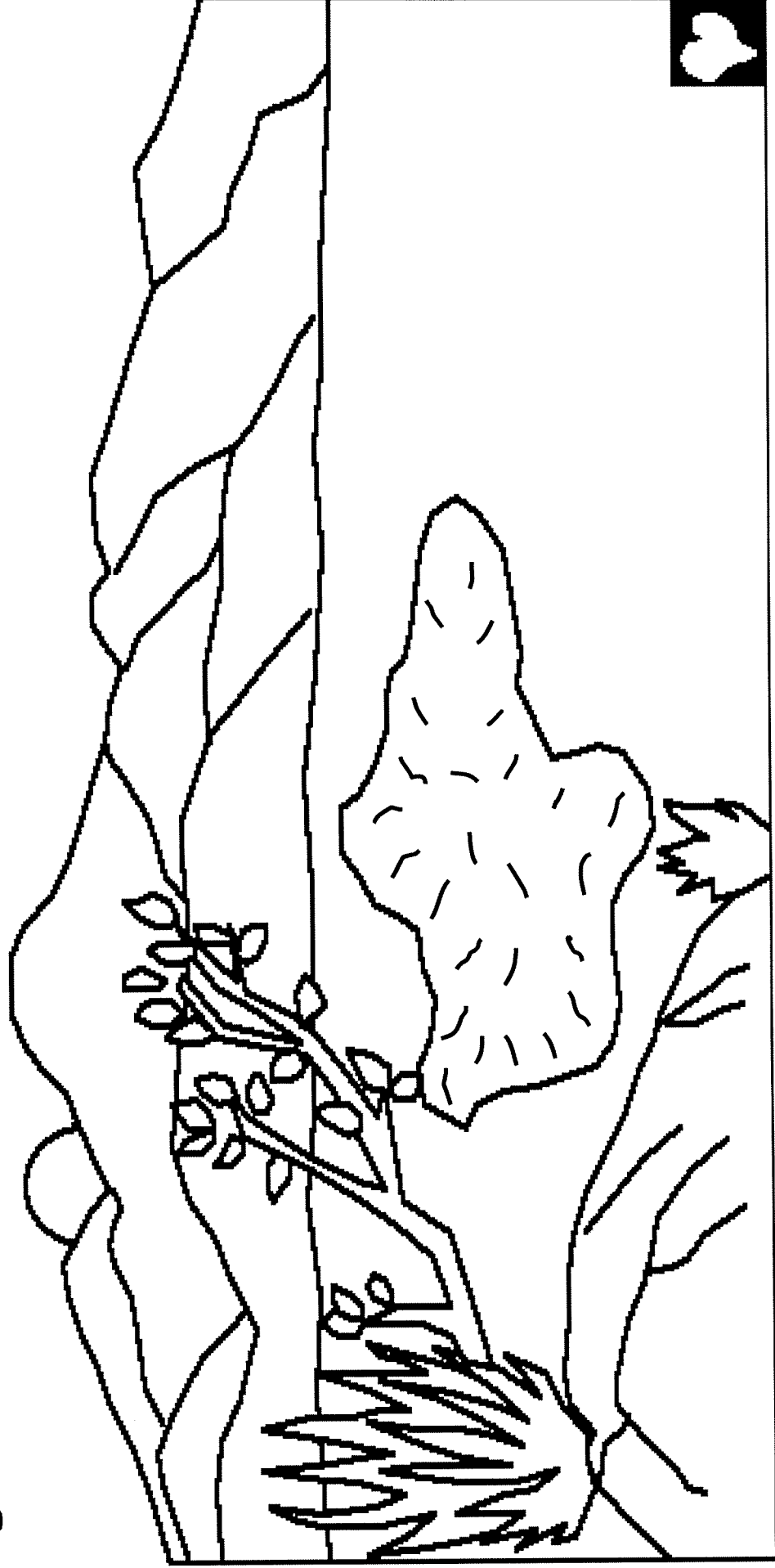

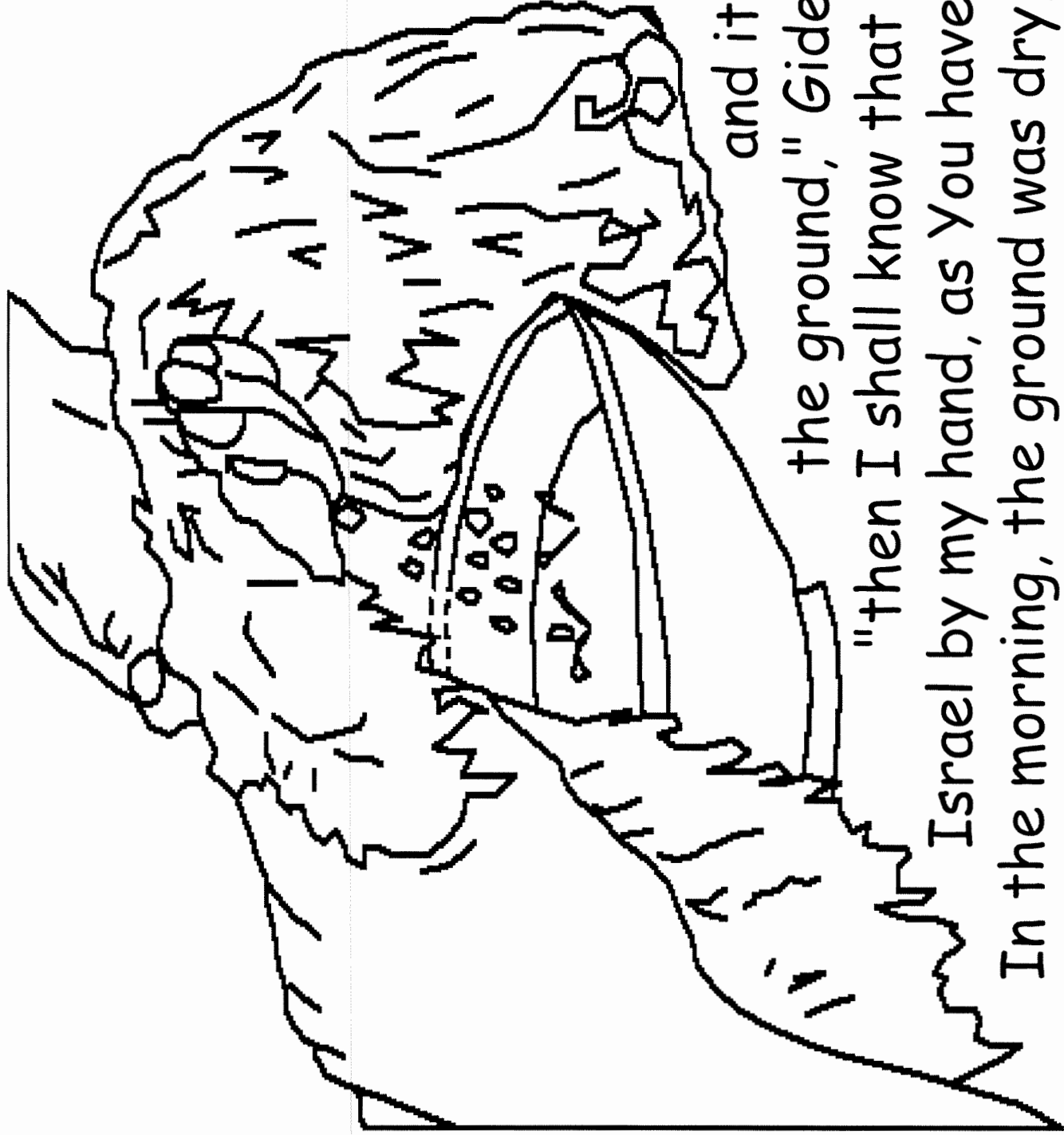

"If there is  
dew on the  
fleece only,  
and it is dry on all

the ground," Gideon prayed,

"then I shall know that You will save  
Israel by my hand, as You have said."

In the morning, the ground was dry, but

**THE FLEECE WAS SOAKING WET!**





Gideon still doubted. Now he wanted  
God to send dew on the ground but not  
on the fleece. Next morning - the  
ground was soggy, but **THE FLEECE**  
**WAS DRY!**

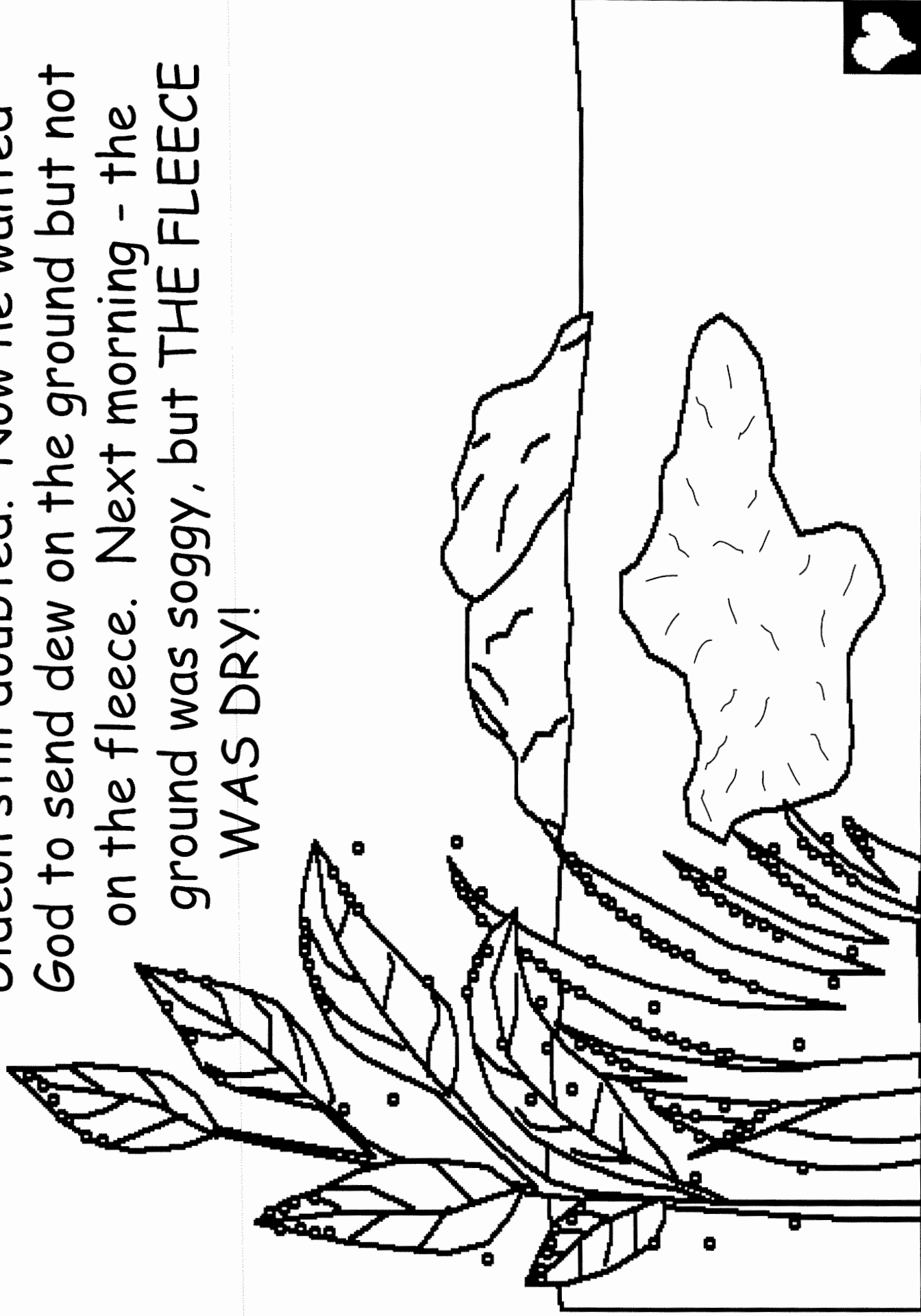



Knowing Gideon was still afraid, God let him secretly overhear one Midianite soldier tell another about a strange dream. In the dream, a loaf of bread tumbled against a Midianite tent and destroyed it.

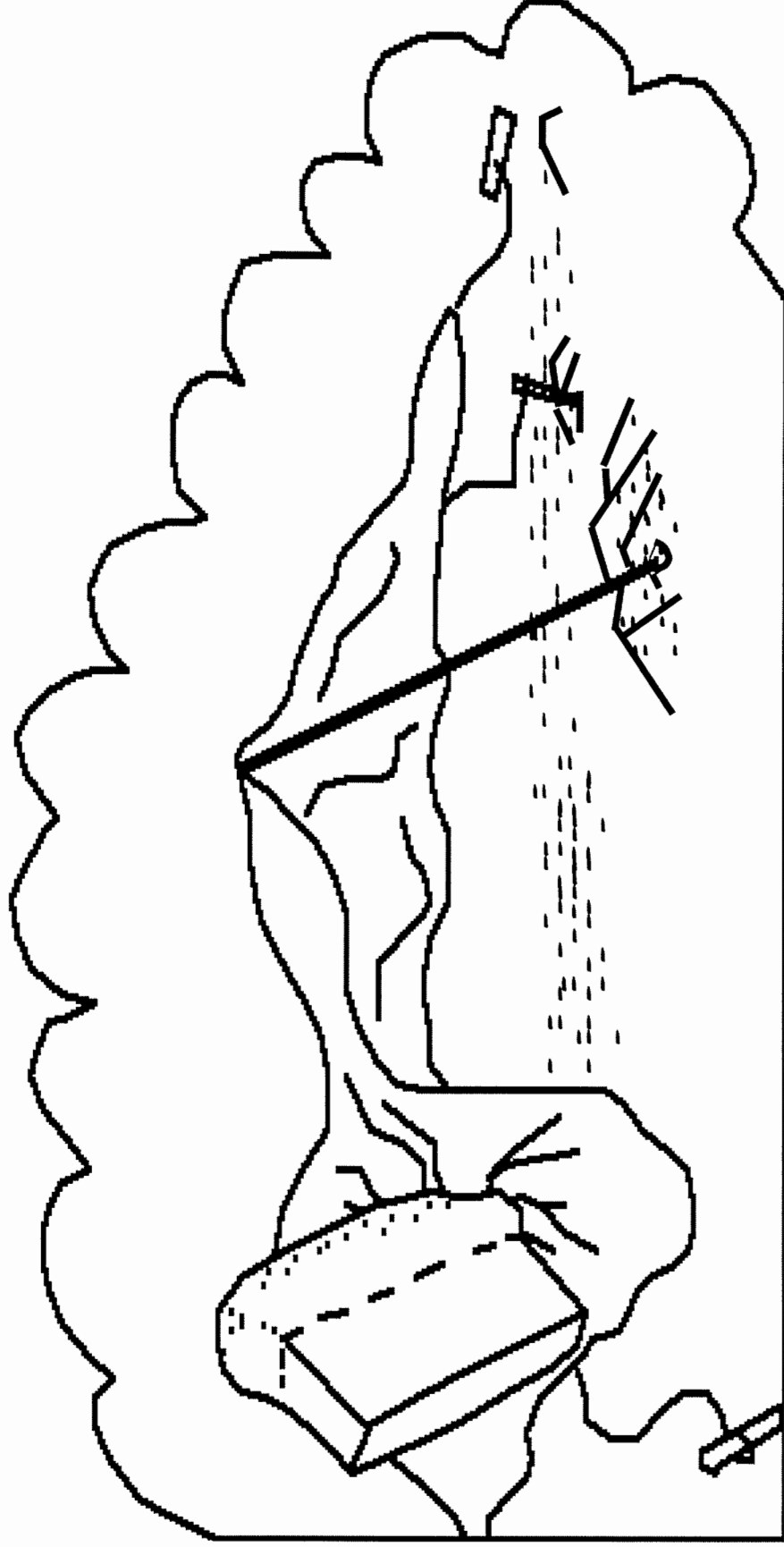

The other guard was terrified. "This is ... the sword of Gideon ..." he cried. When Gideon heard the dream and its meaning, he knew God was going to give him the victory.

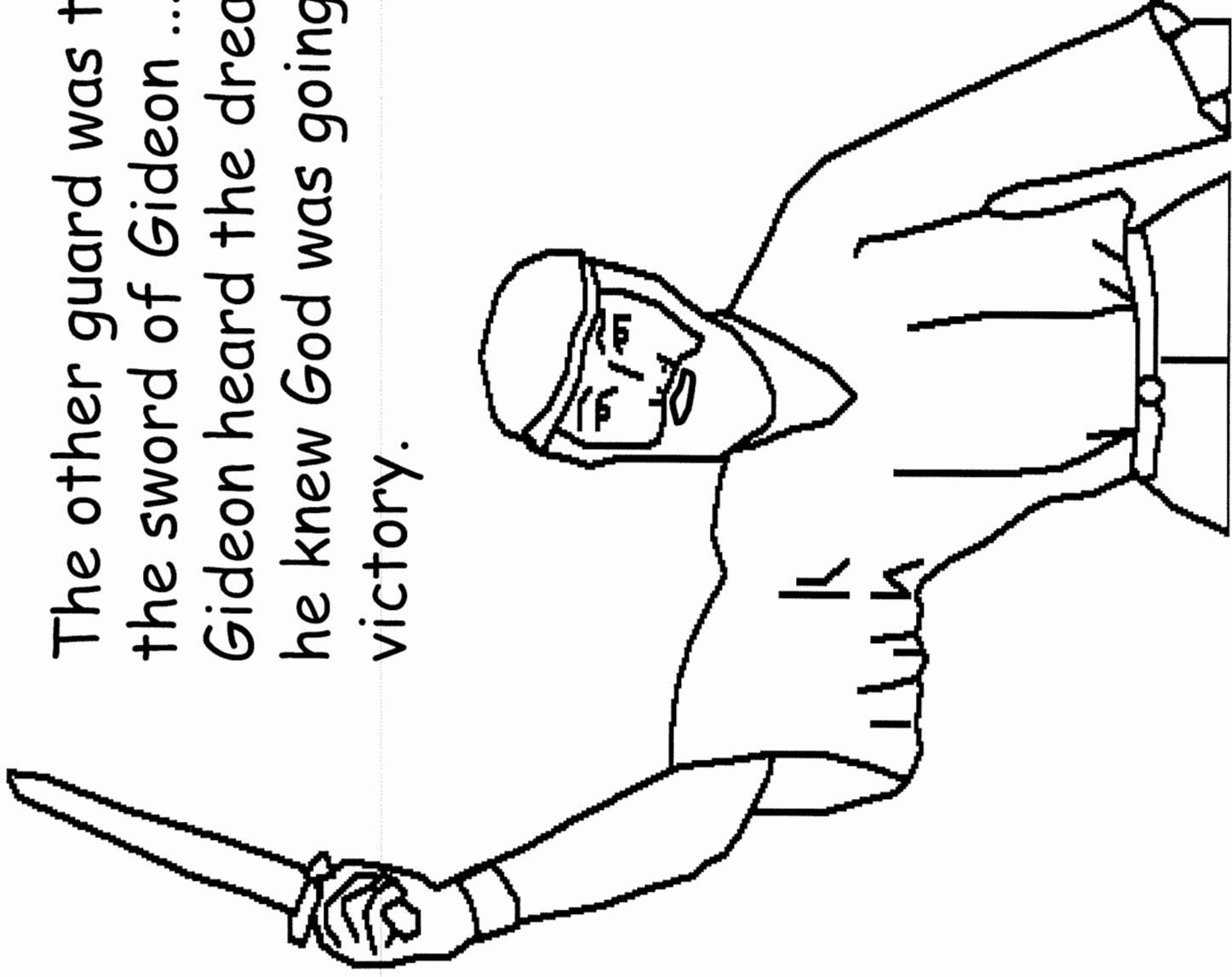

Gideon planned a night attack. He gave each soldier a trumpet, and empty pitchers with torches inside.

They surrounded the Midianite army.

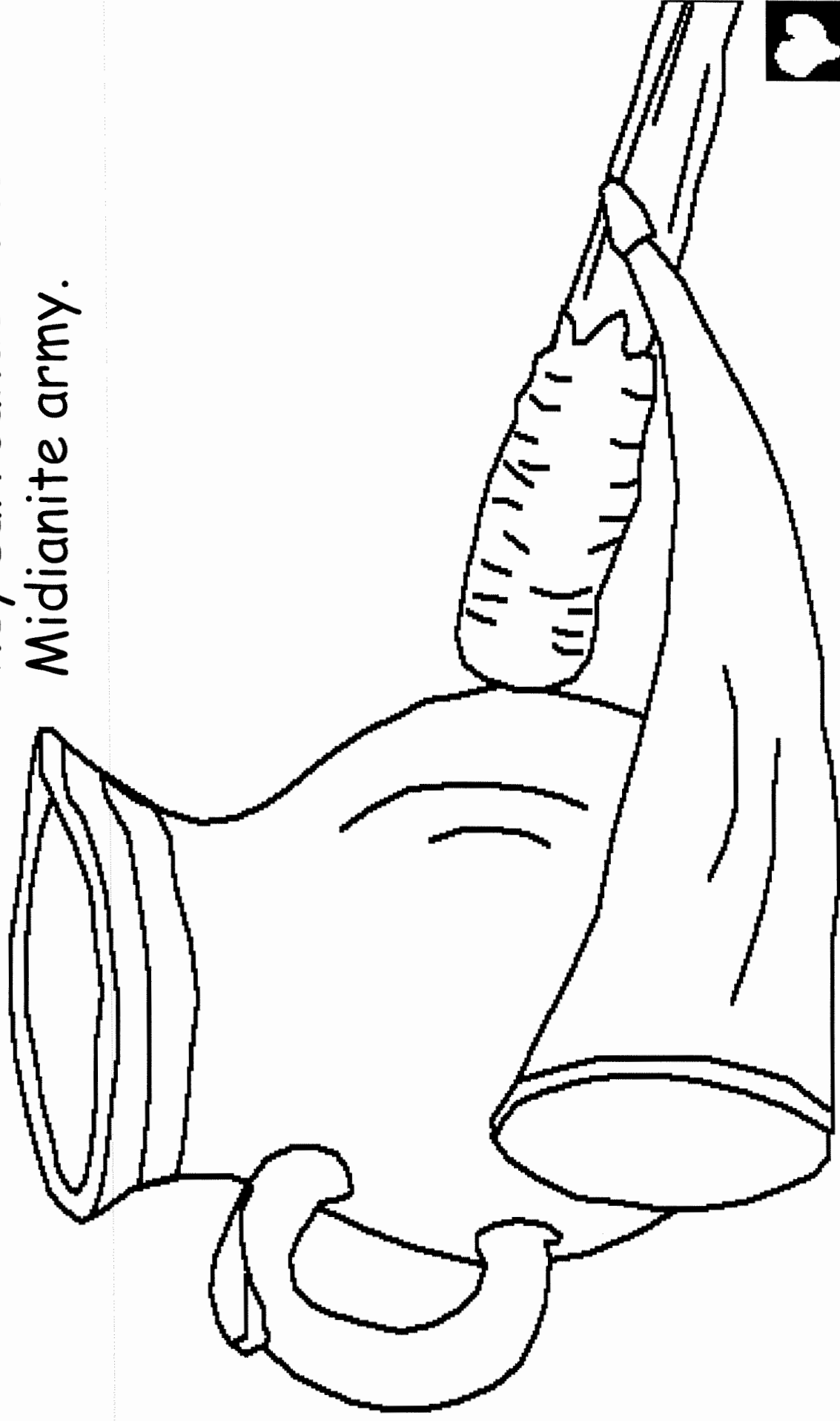

At Gideon's signal, the soldiers blew their trumpets, smashed their pitchers and lit their torches. What noise! What confusion! The scared Midianites got up and ran away.

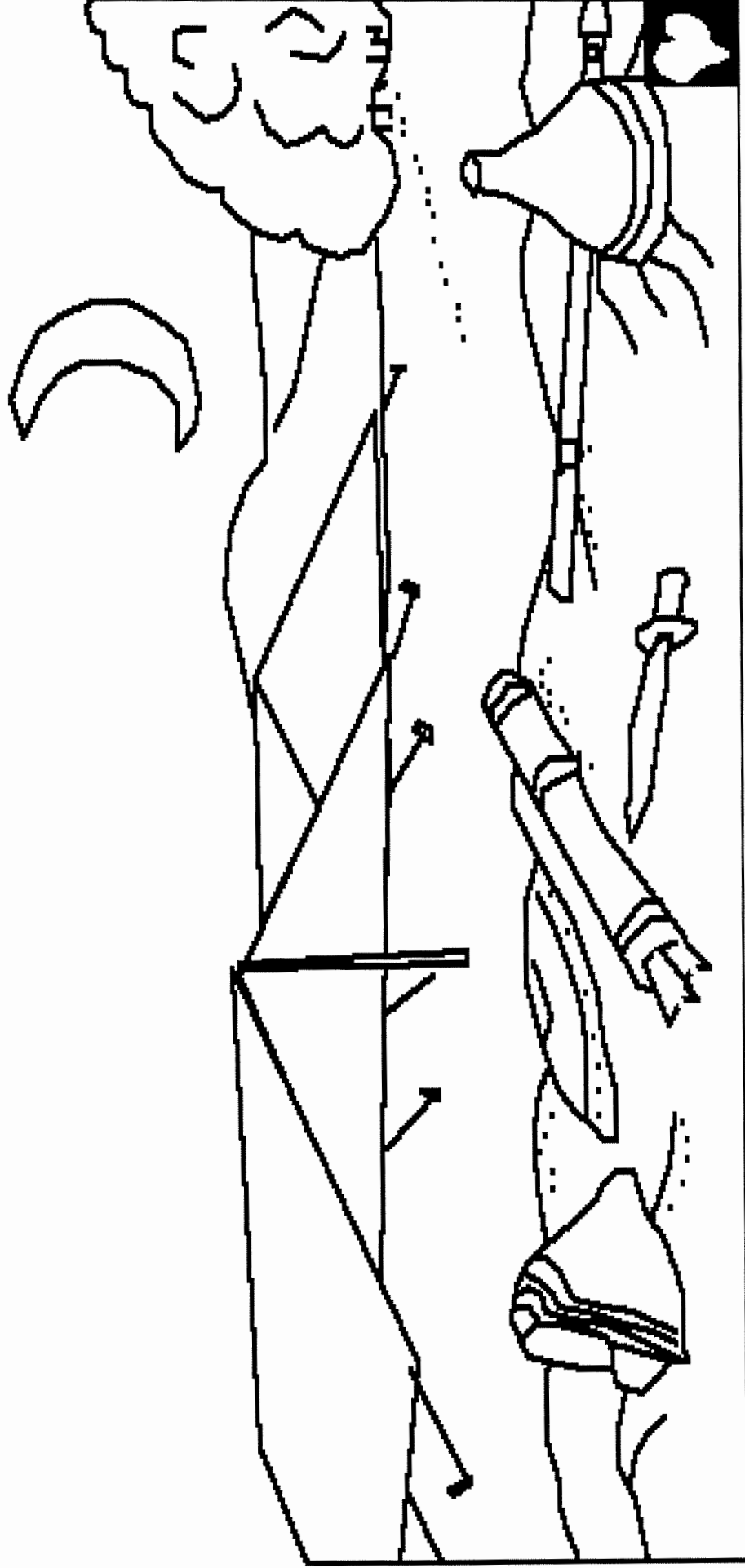

After this great victory, the men of Israel asked Gideon to rule over them. "I will not rule over you.. the Lord shall rule over you," Gideon replied. He knew that only God has the right to rule

in people's lives.

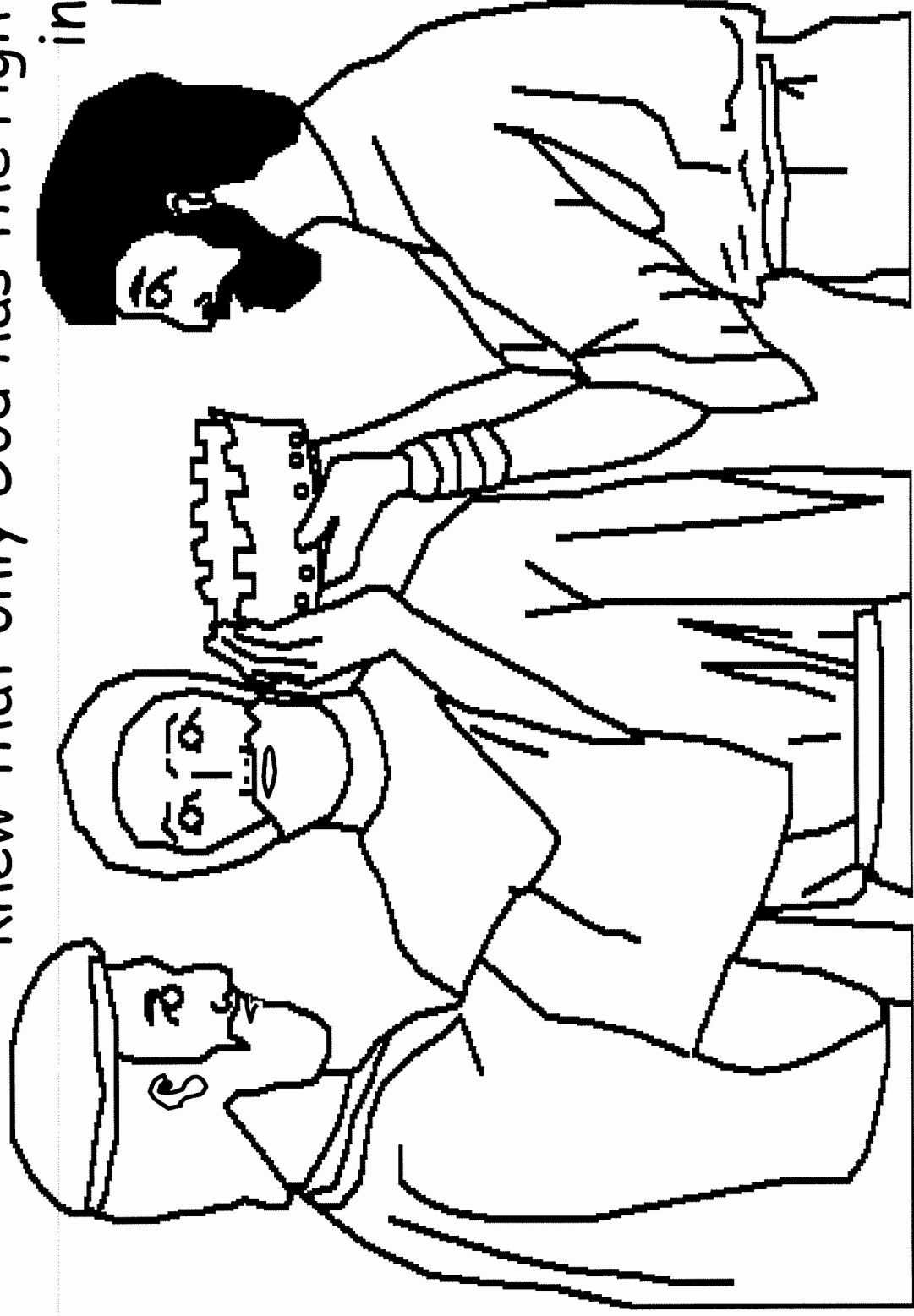

# Gideon

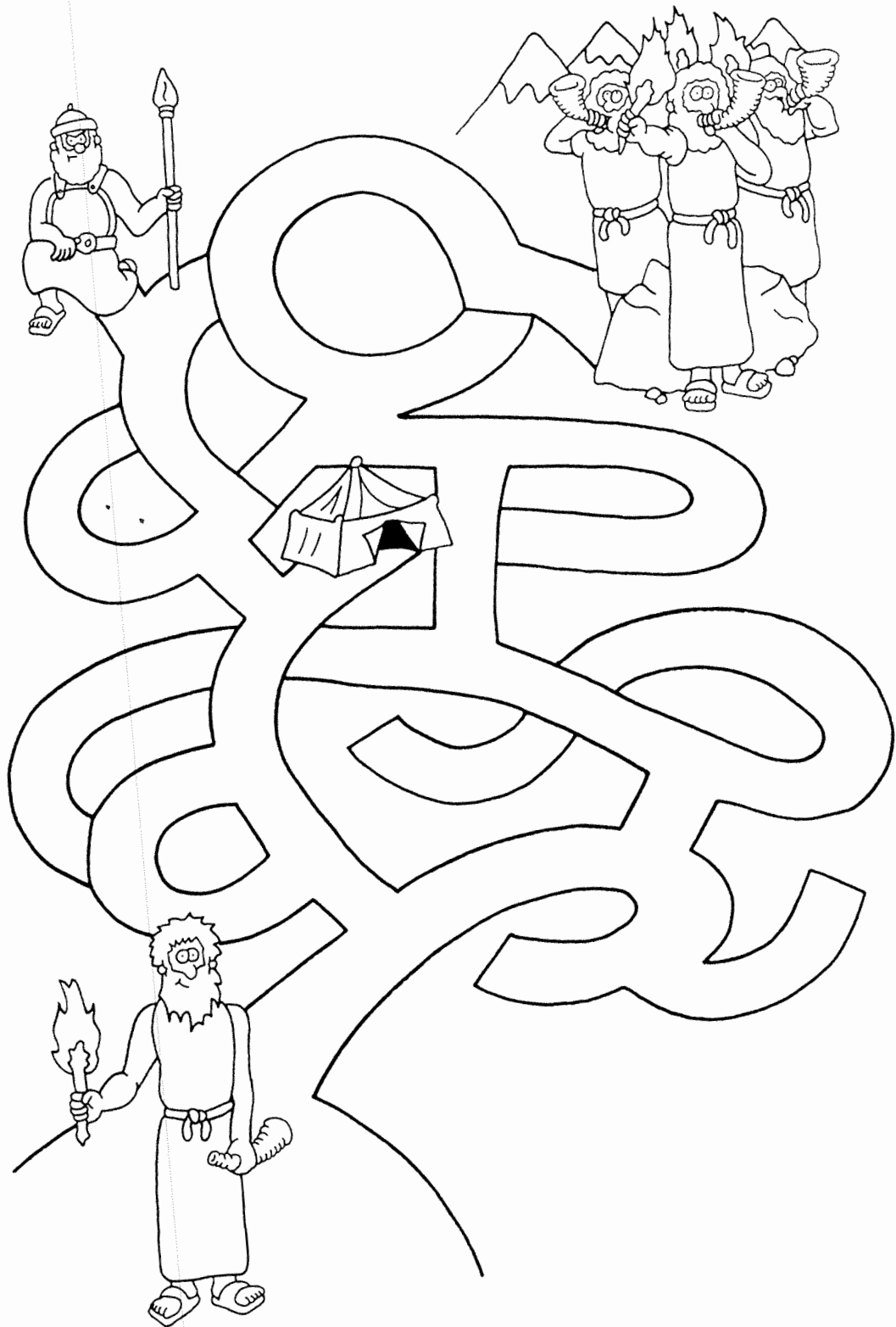

Gideon was chosen by God to be a leader of his people.  
Help Gideon find his army.



# ***Gideon Word Search***

C A M P S R A J  
P R O O F G L Z  
E M T D R O W S  
M K N I R D T T

camp  
drink  
jars  
proof  
sword



# Trumpets and Torches



Israel



altar



men



army



afraid



trumpet

















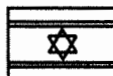





torch

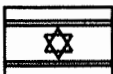

jar

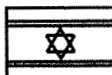

shout

Enemies took 's sheep, cows and food. The ites prayed to God for help. Gideon was a brave man from . God said to him, "Tear down the s of the false gods." Gideon obeyed. Gideon got  from  to make an . God said, "You have too many ." Gideon sent home the  who were . God said, "There are still too many ." Gideon kept only 300 . What a small ! Each man took a . Each man had a  in a . 's  circled the enemy . They blew their s. They broke their s and ed. The enemy 's soldiers got mixed up. They killed each other. God helped  win.

# Whos and Whats

Read the story "Trumpets and Torches." Then read the Questions. Match them with the Answers.

Draw a line between each correct match.

## Questions

What the enemies took

What Gideon tore down

Who was sent home

What they broke

How many Gideon kept

What was in the jars

What Gideon made

Who helped Israel

Who prayed to God

What the soldiers did

## Answers



sheep

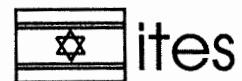

men



300

got mixed up

God

# Gideon in Battle

When Gideon led his soldiers against the Midianites it was very dark. Use a black crayon or pencil and color each space that has a dot in it. Do not color the empty spaces. Then see what you have left.

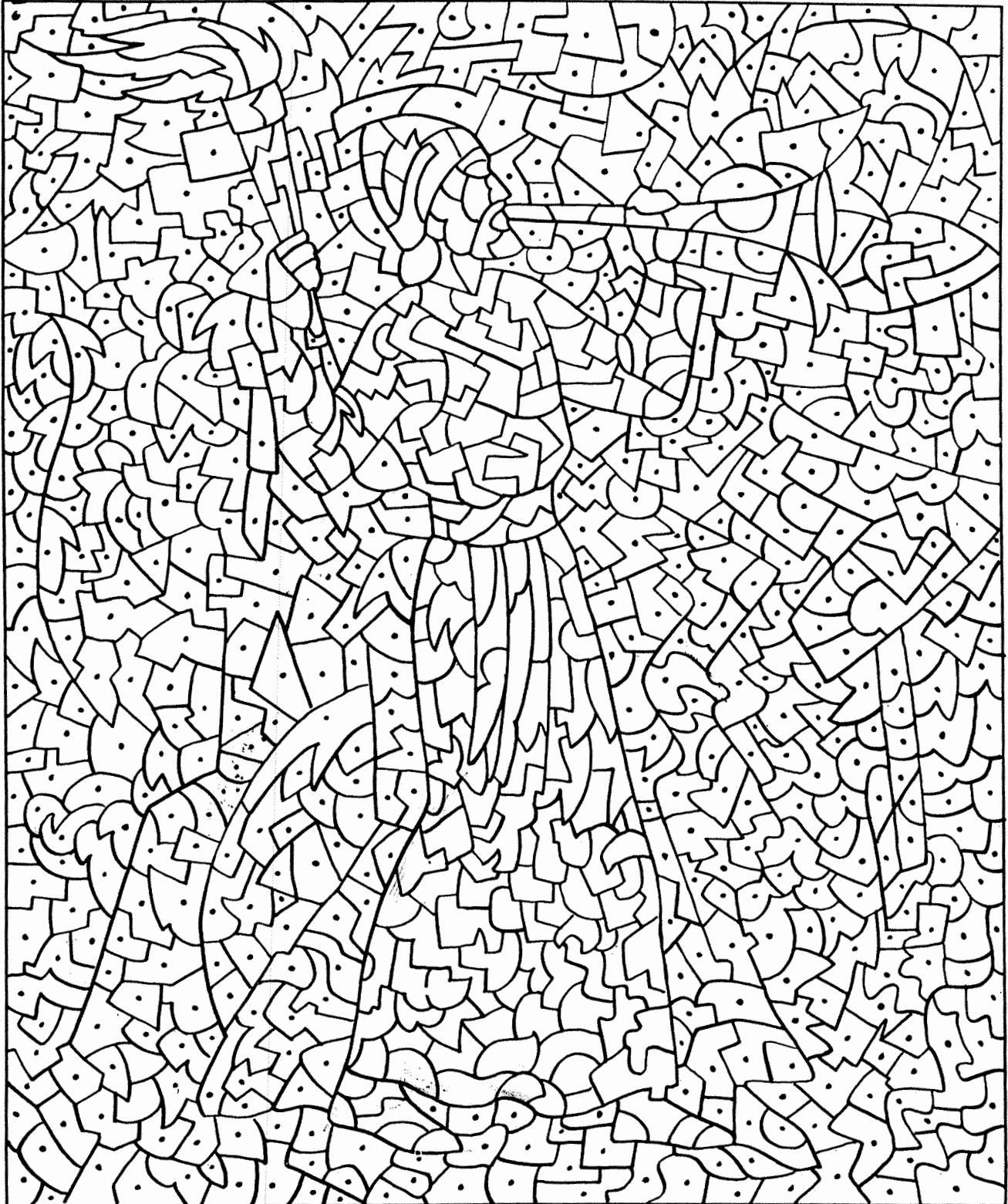

# GIDEON'S VICTORY

God helped Gideon defeat the mighty Midianite army with only a few men.  
Judges 7 tells his story.

Find the words from Gideon's story hidden in the puzzle.



ANGEL

ARMY

DRY

FLEECE

GOD

JAR

TORCH

TRUMPET

WET

Answers on page 16

# Gideon Word Search

P M A C D T W Y S V M K D T A  
 S A B R T A B R H I S C E O N  
 F D I H R W A T D D M A P R G  
 P N R R U J G I F R L T I C E  
 K E I S D N A S U O H T H H L  
 E O M R E N D B Y W F A S E I  
 R I S R I H I R N S T O R S J  
 W V T T R U M P E T S E O J K  
 T S E K A E W T Z D M M W R N  
 A S F L E E C E S D N A H T P

angel	strength
attack	sword
camp	thousands
drink	three hundred
fleece	torches
hands	trumpets
jars	warrior
Midianites	weakest
proof	worshiped



# Gideon

## Judges 6-8

Read the Scripture, then circle each word from the word bank hidden in the puzzle. Words may appear forward or backwards, moving up, down, or diagonally.

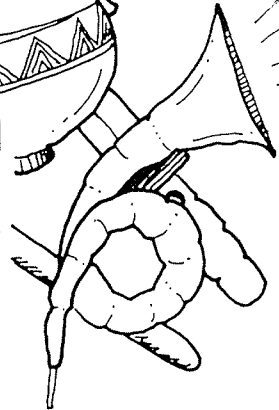
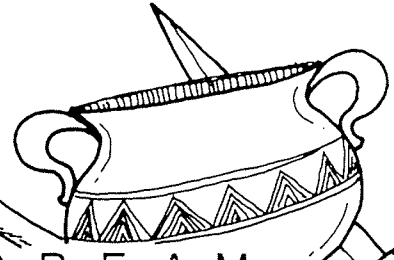
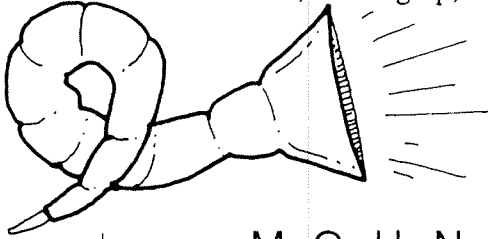

M O U N T G I L E A D D R E A M  
 C A V E S E R E H F O S S A P  
 M O R E H I L L C O U N T R Y  
 D E A R B D E N E V A E L N U  
 M O U N R B L A V H S J R E Z  
 A N D T O R R D A T W B H T E  
 S O N G T O E R L O U R A T E  
 H E L I H H T I E C R E B A B  
 E S O A E E A N L C D A E W E  
 R U F D R R W K Y U F D Z L R  
 H L L I S T T L E S C W O O  
 V A L L E Y O F J E Z R E E L  
 S G N I R D L O G N O E D I G  
 S W O R D S E T I N A I D I M  
 B A T T L E C E E L F L O O W

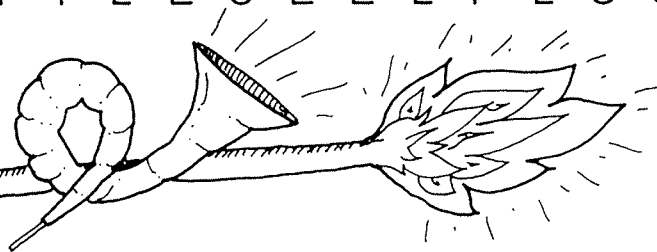
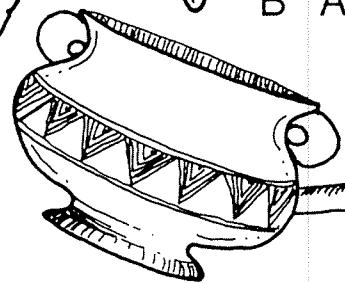
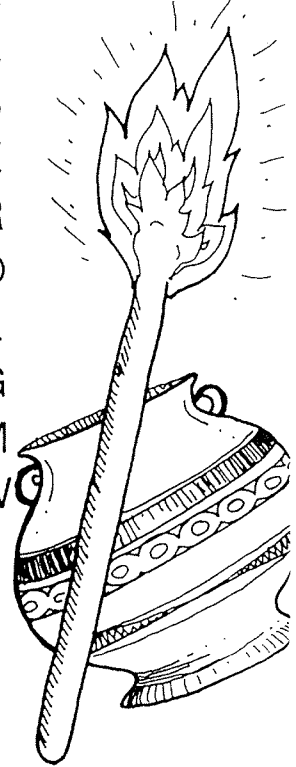
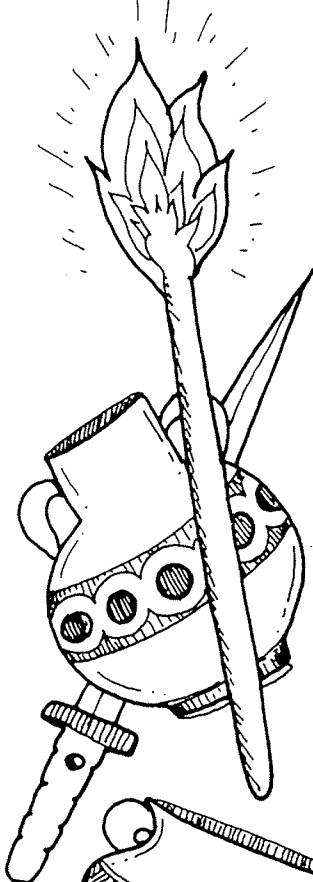

### Word Bank

Valley of Jezreel  
 dream  
 wool fleece  
 swords  
 drink  
 us (2)

hill country  
 unleavened bread  
 brothers  
 Midianites  
 Gideon  
 of (3)

caves  
 gold rings  
 Zeeb  
 Oreb  
 Mount Gilead

battle  
 Pass of Heres  
 succoth  
 bread  
 Zebah

asher  
 water  
 Moreh  
 son  
 and

**Bonus:** To discover how many men Gideon took with him, shade in the uncircled letters.

# Gideon's Army

In the Book of Judges (chapters 6, 7, 8) is the story of Gideon and how he won a battle over the enemies of Israel. Read the story and fill in the blanks below. Then in the big picture find little pictures of the words you have filled in.

There were so many enemies that they seemed to be like \_\_\_\_\_ in the valley. They had so many \_\_\_\_\_ that the Israelites couldn't begin to count them. God told Gideon to use only three hundred men to fight that large army. Gideon chose his men by watching how they drank water from the stream. Every man who lapped water like a \_\_\_\_\_ was chosen to be one of Gideon's men. Their weapons were a \_\_\_\_\_, an empty \_\_\_\_\_, and a \_\_\_\_\_.

All the soldiers were told to shout, "The \_\_\_\_\_ of the Lord and Gideon." God was with Gideon and his men. The Israelites won the battle. (KJV)

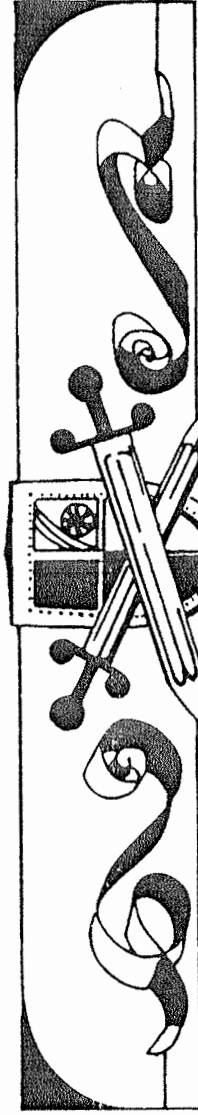

What did the angel of the Lord say to Gideon at the winepress? Unscramble the letters below.

EHT DRLO SI HIWT EHT E, UHOT GHYMTI AMN FO URVOLA.

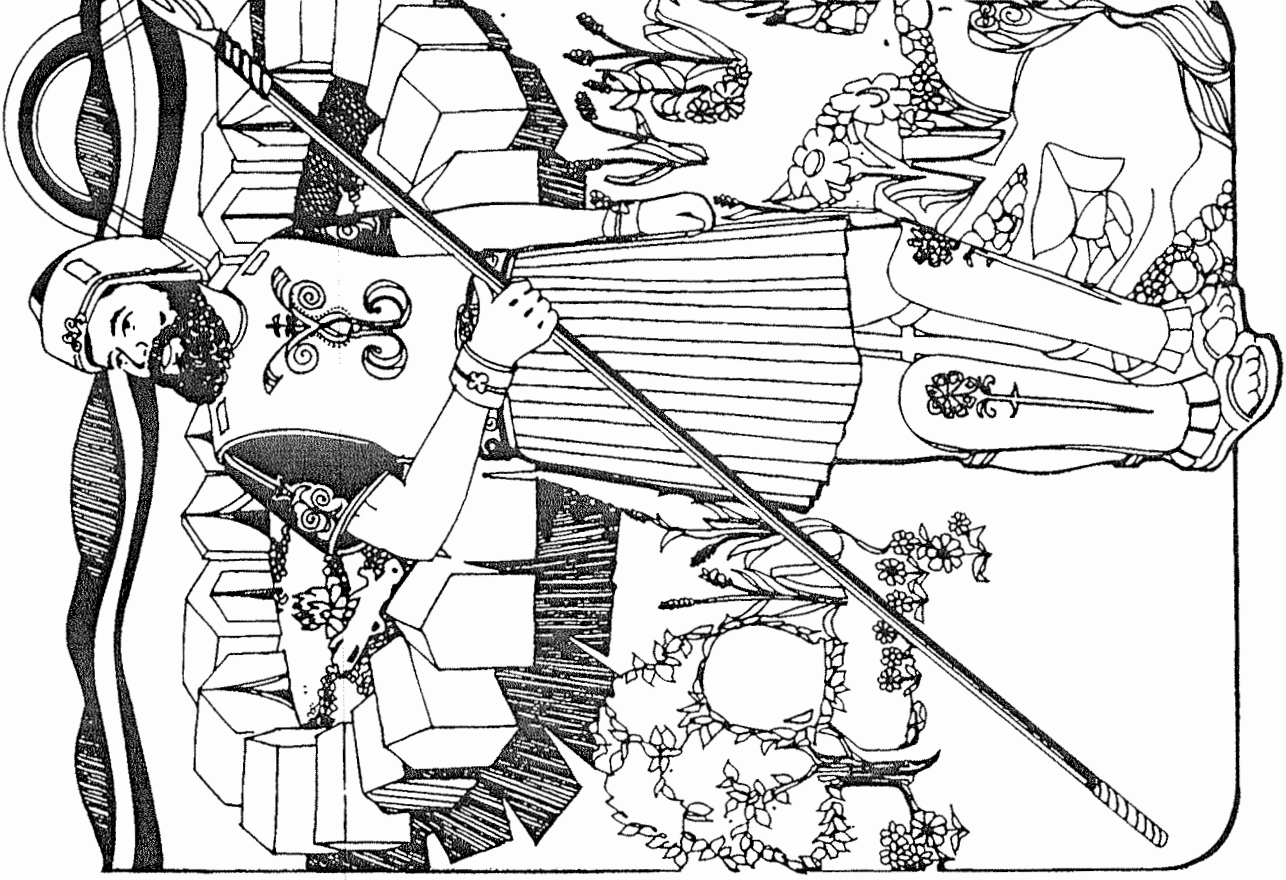



# Gideon Crossword

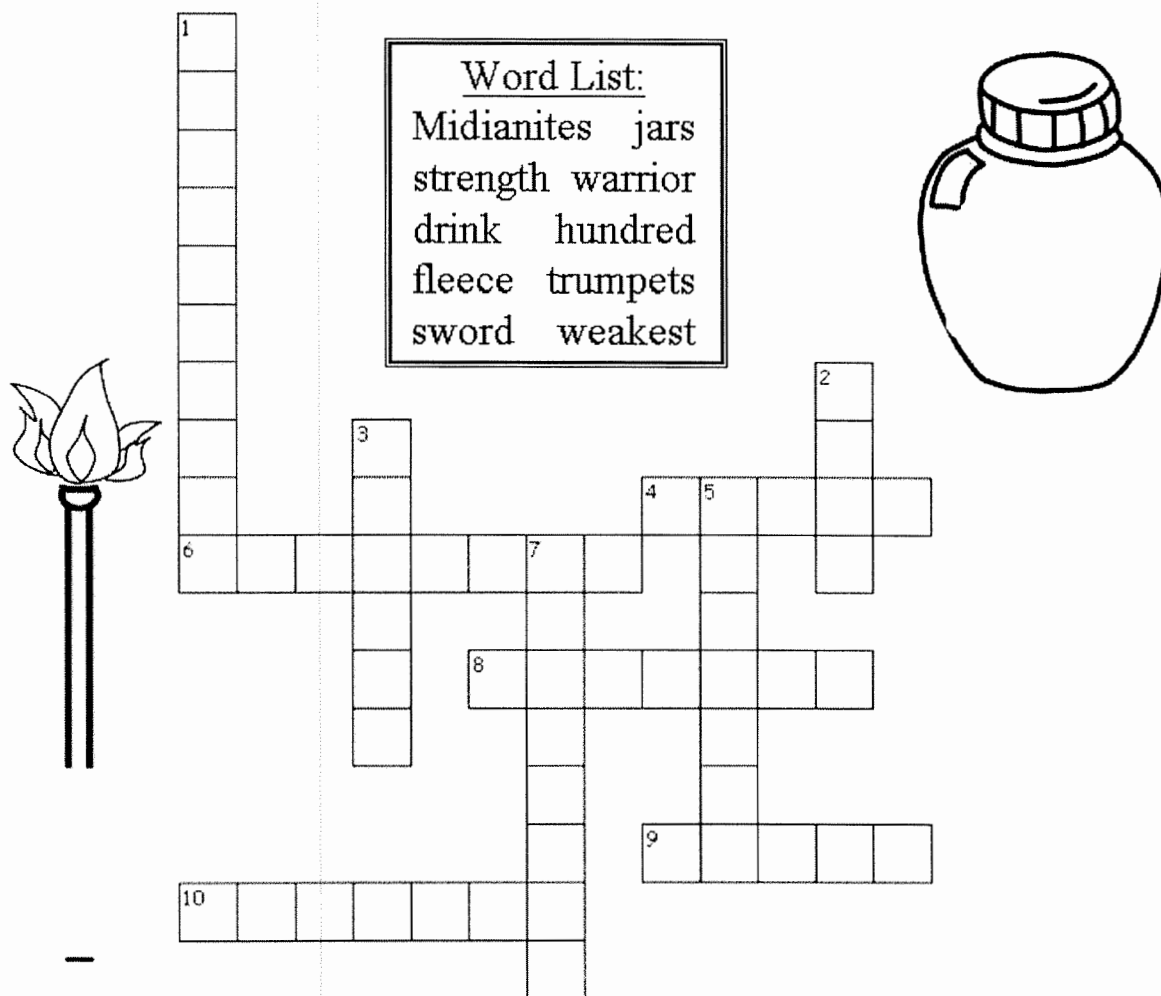

## Across

- The Israelite army chanted: The \_\_\_\_ of the Lord and of Gideon.
- It was God's \_\_\_\_ that won the battle for the Israelites.
- The army started out being thousands and ended up being three \_\_\_\_.
- The army got smaller after God asked Gideon to watch the men do this.
- Gideon thought he was the \_\_\_\_ in his clan, but God didn't see him that way.

## Down

- These were the people that God helped Gideon defeat.
- The army carried trumpets and broke these to scare the Midians.
- Gideon wanted to see if this was wet and the ground was dry.
- When the angel approached Gideon he called him a mighty \_\_\_\_.
- There was no fighting. The army blew these and scared the Midian's away.

Unscramble the letters to find the words in our

# Gideon Anagram

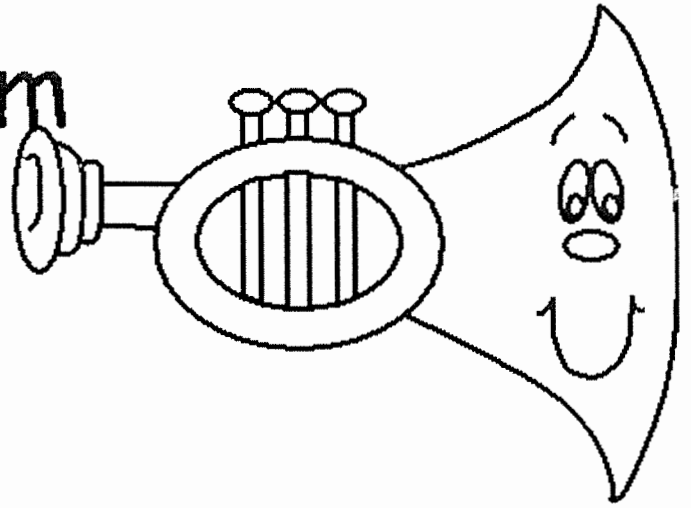

ceeefl \_\_\_\_\_

dehioprsw \_\_\_\_\_

adhnosstu \_\_\_\_\_

aekstw \_\_\_\_\_

aiorrrw \_\_\_\_\_

adeiiimnst \_\_\_\_\_

aacktt \_\_\_\_\_

emprsttu \_\_\_\_\_

eghnrstt \_\_\_\_\_

cehorst \_\_\_\_\_

# SURPRISE

Israel's army was very small, but they followed God's directions. Find their battle cry from Judges 7:20 by filling in the boxes. All the boxes connect with a box containing the same letter.

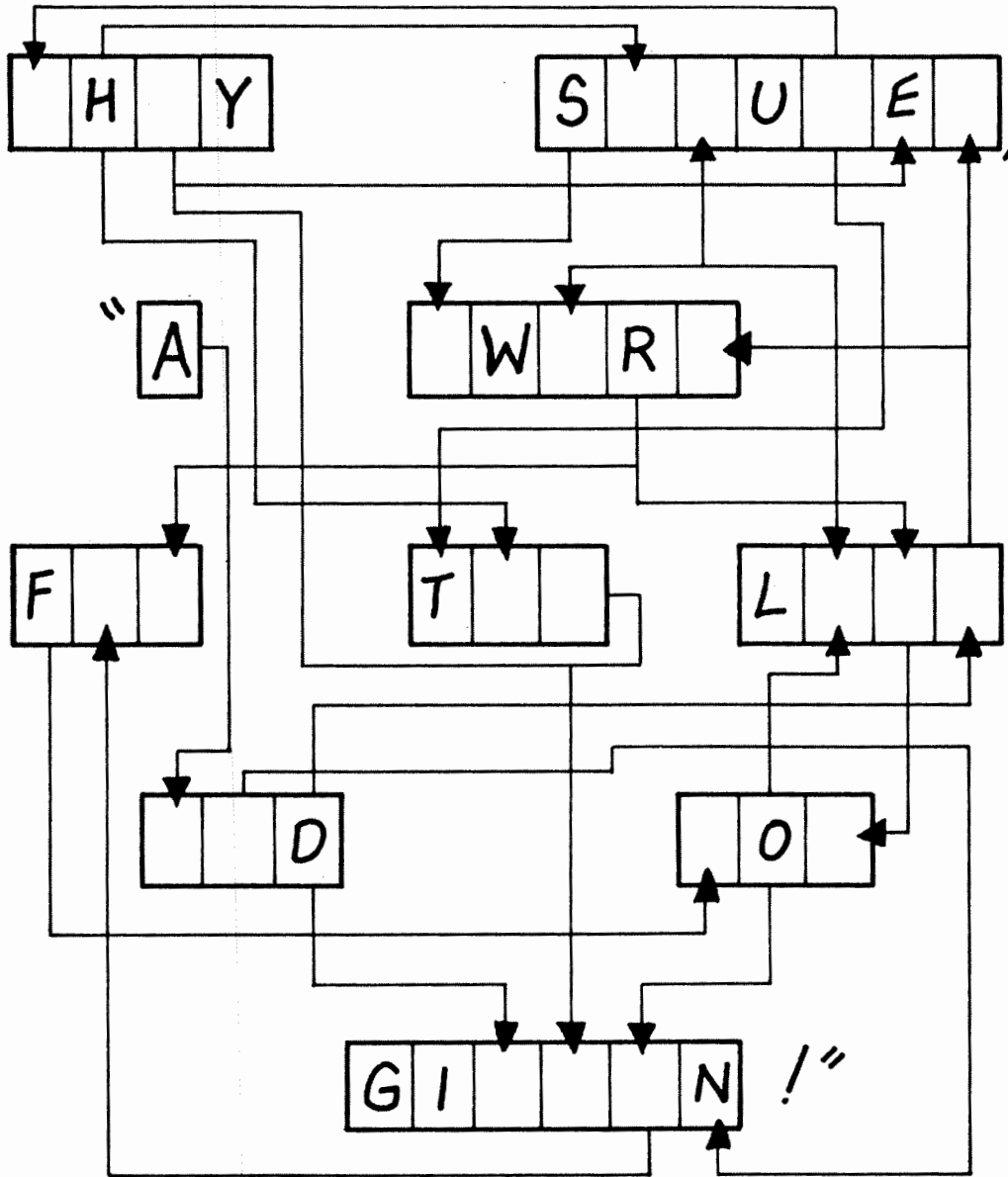

# 63. GIDEON'S ARMY OF 300

## (JUDGES 7:1-25)

### MEMORY VERSE:

"Then it will be, that of whom I say to you, 'This one shall go with you,' the same shall go with you; and of whomever I say to you, 'This one shall not go with you,' the same shall not go." JUDGES 7:4

### CIRCLE THE CORRECT WORDS:

1. "The LORD said to Gideon, 'The people who are with you are too (**MANY, FEW**) for Me to give to the Midianites into their hands, lest Israel claim glory for itself against Me, saying, 'My own hand has saved me.' " " JUDGES 7:2
2. The LORD then said to Gideon, "Now therefore proclaim in the hearing of the people, saying, 'Whoever is fearful and afraid, let him turn and (**FIGHT, DEPART**) at once from Mount Gilead.'" JUDGES 7:3

### TRUE OR FALSE:

3. "And twenty-two thousand of the people returned, and ten thousand remained." JUDGES 7:3  
TRUE OR FALSE
4. And the LORD said to Gideon, "Now the people are too few!" JUDGES 7:4  
TRUE OR FALSE

### MATCHING:

**DRAW A LINE FROM WHAT THE LORD HAS SAID TO DO TO THE CORRECT RESPONSE ON THE RIGHT-**

5. The LORD said, "Bring them down to the water, and I will test them for you there. Then it will be, that of whom I say to you..." JUDGES 7:4

THIS ONE SHALL GO WITH YOU

THE SAME SHALL NOT GO

THIS ONE SHALL NOT GO WITH YOU

THE SAME SHALL GO WITH YOU

### TRUE OR FALSE:

6. "So he brought the people down to the water. And the LORD said to Gideon, 'Everyone who laps from the water with his tongue, as a dog laps, you shall set apart by himself.' " JUDGES 7:5  
TRUE OR FALSE
7. "Likewise everyone who gets down on his knees to drink." JUDGES 7:5  
TRUE OR FALSE

### FILL IN THE BLANK:

8. "And the number of those who lapped, putting their hand to their mouth, was three \_\_\_\_\_ men; but all the rest of the people got down on their knees to drink water." JUDGES 7:6

### TRUE OR FALSE:

9. "Then the LORD said, 'By the three hundred men who lapped I will save you, and deliver the Midianites into your hand.'" JUDGES 7:7  
TRUE OR FALSE

### CIRCLE THE CORRECT WORDS:

10. "And it happened on the same night that the LORD said to him, 'Arise, go down against the camp, for I have (**DELIVERED, REMOVED**) it into your hand.'" JUDGES 7:9
11. Gideon's "three companies blew the (**FLUTES, TRUMPETS**) and broke the (**PITCHERS, ARROWS**)- they held the torches in their left hands and the trumpets in their right hands for blowing-- and they cried, 'The sword of the LORD and of Gideon!' And every man stood in his place all around the camp; \_\_\_\_\_ and the whole army ran and cried out and fled." JUDGES 7:20-21

## 63. GIDEON'S ARMY OF 300 (JUDGES 7:1-25)

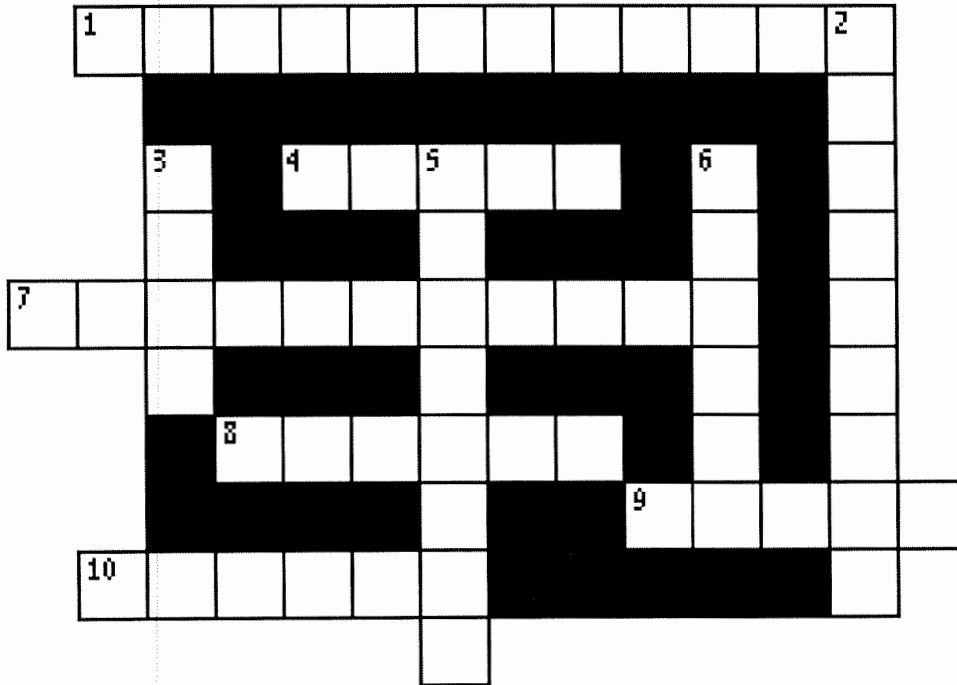

- 3 DOWN "The LORD said to Gideon, 'The people who are with you are too \_\_\_\_\_ for Me to give to the Midianites into their hands.'" **JUDGES 7:2**
- 10 ACROSS The LORD then said to Gideon, "Now therefore proclaim in the hearing of the people, saying, 'Whoever is fearful and afraid, let him turn and \_\_\_\_\_ at once from Mount Gilead.'" **JUDGES 7:3**
- 7 ACROSS "And twenty-two thousand of the people returned, and \_\_\_\_\_ \_\_\_\_\_ remained." **JUDGES 7:3**
- 6 DOWN "And the LORD said to \_\_\_\_\_, 'The people are still too many.'" **JUDGES 7:4**
- 4 ACROSS "So he brought the people down to the \_\_\_\_\_. And the LORD said to Gideon, 'Everyone who laps from the water with his tongue, as a dog laps, you shall set apart by himself.'" **JUDGES 7:5**
- 9 ACROSS "Likewise everyone who gets down on his \_\_\_\_\_ to drink." **JUDGES 7:5**
- 1 ACROSS "And the number of those who lapped, putting their hand to their mouth, was \_\_\_\_\_ \_\_\_\_\_ men; but all the rest of the people got down on their knees to drink water." **JUDGES 7:6**
- 8 ACROSS "Then the LORD said, 'By the three hundred men who \_\_\_\_\_ I will save you, and deliver the Midianites into your hand.'" **JUDGES 7:7**
- 2 DOWN "And it happened on the same night that the LORD said to him, 'Arise, go down against the camp, for I have \_\_\_\_\_ it into your hand.'" **JUDGES 7:9**
- 5 DOWN Gideon's "three companies blew the \_\_\_\_\_ and broke the pitchers- they held the torches in their left hands and the trumpets in their right hands for blowing." **JUDGES 7:20-21**

# 63. GIDEON'S ARMY OF 300 (JUDGES 7:1-25)

N Q T Y A I J P Y O W B P C O A J U A Q  
 S S E H C R O T O J Y D N U I H C D R L  
 Z I A L W W T I F J P T S M T A V S L K  
 K P Q I T Z E Q V E Z O U R E H T J W D  
 B K N E E S J D X A W O O D E Z W H J D  
 Z H S E T I N A I D I M F L J H H Q U O  
 F Z F O P K Z J S W B A L S D Y C O O K  
 H I H V E K Z Q V L M N L V R N P T E Q  
 N V P Q S Q K R M Z W Y M R I J J E I K  
 G V J Z G J C I A X P R S C N T H W P P  
 I B T U D B T L Z P F C Z M K P Q E T L  
 D D E R D N U H E E R H T L K S O B C W  
 E Q B A E B I S S J I G F B K T A K S K  
 O Y I N P R O T H H X R P P P E W S C I  
 N E A M Z B T L M G G G G A Z P V U H J  
 G L M G C K A F E E Y N K C Y M M H U S  
 M O U N T G I L E A D G B W Y U F P E U  
 Y N P F C E N A R U R Z U J O R E T A W  
 G V D E P P A L S W P S G L J T S E C E  
 R Q T H Q F R Y V D Y J I M F L W V N A

DRINK  
 GIDEON  
 ISRAEL  
 KNEES  
 LAPPED

MIDIANITES  
 MOUNT GILEAD  
 PITCHERS  
 THREE HUNDRED

TOO MANY  
 TORCHES  
 TRUMPETS  
 WATER

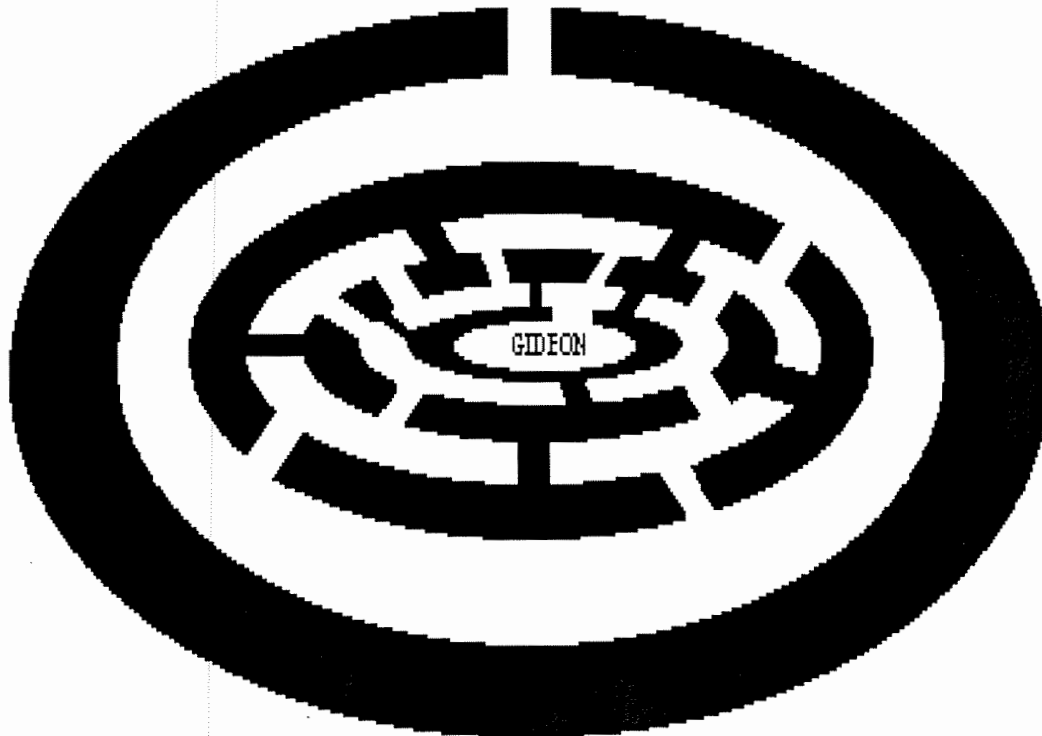

# Gideon Obeyes God

Judges 6 — 7

The Midianites were enemies of God's people. God chose Gideon to lead an army to defeat the Midianites. Because Gideon obeyed God, his little army of only 300 men won a great victory.

The hidden words come from this story in Judges 6-7. The code following each word tells the coordinates where one of the letters of the word is hidden in the puzzle. After you have found all the hidden words, start at the upper left and use all the leftover letters to fill in the blanks at the bottom of the page with a Bible verse that tells us how we can learn about God.

AFRAID (4K)		A	B	C	D	E	F	G	H	I	J	K	L	M	N		NOTHING (6F)
AMALEKITES (14C)	1	B	B	E	S	D	N	M	I	A	L	C	O	R	P	1	OUTSIDE (4B)
BLOW (2A)	2	L	N	D	O	O	T	S	V	A	U	N	T	T	P	2	PEOPLE (12E)
BRAKE (13K)	3	O	I	O	E	W	O	L	L	E	F	L	L	L	S	3	PITCHERS (5H)
CAMP (8J)	4	W	U	D	T	N	A	N	D	T	R	R	A	K	A	4	PLACE (5K)
DEPART (12B)	5	P	I	T	C	H	E	R	S	H	A	C	A	L	V	5	PROCLAIM (1N)
DOWN (4E)	6	G	N	R	S	O	I	W	A	G	E	T	C	I	E	6	ROSE (11K)
FEARFUL (7J)	7	A	D	U	H	I	A	N	T	I	F	A	I	K	D	7	ROUND (12H)
FELLOW (3F)	8	T	E	M	A	M	D	G	G	N	M	O	R	E	S	8	SAVED (3N)
GATHERED (7A)	9	H	P	P	D	S	S	E	R	P	E	N	I	W	D	9	STOOD (2G)
GIDEON (3D)	10	E	A	E	R	H	P	S	O	A	L	B	O	I	R	10	SWORD (12J)
GOD (12I)	11	R	R	T	O	M	W	F	U	O	G	R	O	S	E	11	TRUMPETS (9C)
HANDS (6H)	12	E	T	S	L	P	E	R	N	O	D	A	T	E	T	12	TUMBLED (13E)
HEAR (8L)	13	D	T	U	M	B	L	E	D	Y	S	K	I	X	A	13	VAUNT (2K)
HOST (10E)	14	T	E	A	M	A	L	E	K	I	T	E	S	N	W	14	WATER (14N)
LIKEWISE (5M)		A	B	C	D	E	F	G	H	I	J	K	L	M	N		WELL (11F)
LORD (9D)																	WINEPRESS (9J)
NIGHT (7I)																	

HIDDEN VERSE: \_\_\_\_\_, \_\_\_\_\_  
 \_\_\_\_\_ . \_\_\_\_\_ - \_\_\_\_\_ :

**Year 2**

**Week 59**

## **Jepthah's Daughter**

**Scriptures: Judges 10, 11**

**Key Verse: Judges 11:36 “My father, if you have given your word to the LORD, do to me according to what has gone out of your mouth”**

### **Key Points:**

1. Jepthah was forced out of his home by his brothers because he had a different mother.
2. Later, when the people of Ammon made war against Israel, the leaders asked Jepthah to lead them in battle. He agreed, but with the understanding that he would become their judge if the Lord gave him victory over Ammon.
3. Jepthah tried to reason with the king of Ammon that God had given the lands of the Moabites and the Amorites to Israel hundreds of years ago, and that Ammon had no claim to them. The king refused to listen.
4. Before going into battle, Jepthah promised God that if Israel won he would dedicate to God whoever met him on his return.
5. When Jepthah came home, his only child met him to celebrate the victory. Sadly, he told her his promise.
6. She asked for two months to mourn that she would never marry or have children. Then she was dedicated to serve God the rest of her life.



## **A noble, but unnecessary Vow!**

“If you give the Ammonites into my hands, whatever comes out of the door of my house when I return in triumph from the Ammonites will be the Lord’s, and I will sacrifice it as a burnt offering.”

(Judges 11:30-31)

The battle was God’s.  
It was already won!





My father," she replied, "you have given your word to the Lord. Do to me just as you promised, now that the Lord has avenged you of your enemies, the Ammonites. But grant me this one request," she said. "Give me two months to roam the hills and weep with my friends, because I will never marry."

Judges 11:36-37



# Jeptha's Daughter

Fill in the blank

**Judges 11**

**NKJV**

**29** Then the \_\_\_\_\_ of the Lord came upon Jephthah, and he passed through \_\_\_\_\_ and Manasseh, and passed through \_\_\_\_\_ of Gilead; and from Mizpah of Gilead he advanced *toward* the people of \_\_\_\_\_.

**30** And Jephthah made a vow to the Lord, and said, "If You will indeed \_\_\_\_\_ the people of Ammon into my hands, **31** then it will be that whatever comes out of the doors of my \_\_\_\_\_ to meet me, when I return in peace from the people of Ammon, shall surely be the Lord's, and I will offer it up as a \_\_\_\_\_."

**32** So Jephthah advanced toward the people of Ammon to fight against them, and the Lord delivered them into his hands. **33** And he defeated them from Aroer as far as Minnith— \_\_\_\_\_ —and to Abel Keramim,<sup>[a]</sup> with a very great slaughter. Thus the people of Ammon were \_\_\_\_\_ before the children of \_\_\_\_\_. **31** then it will be that whatever comes out of the doors of my house to meet me, when I return in \_\_\_\_\_ from the people of Ammon, shall surely be the Lord's, and I will offer it up as a burnt offering."**34** When Jephthah came to his house at \_\_\_\_\_, there was his daughter, coming out to meet him with \_\_\_\_\_ and dancing; and she *was his* only child. Besides her he had neither son nor \_\_\_\_\_. **35** And it came to pass, when he saw her, that he tore his \_\_\_\_\_, and said, "Alas, my daughter! You have \_\_\_\_\_ me very low! You are among those who \_\_\_\_\_ me! For I have given my \_\_\_\_\_ to the \_\_\_\_\_, and I cannot go back on it."

# Jepthah's Vow

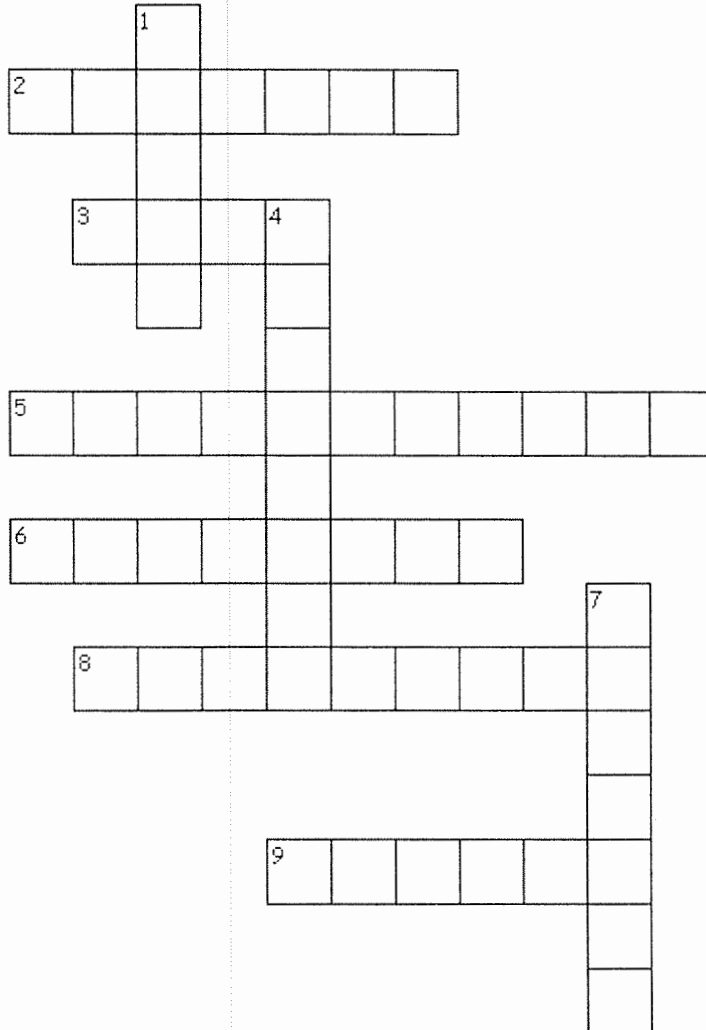

## Across

2. What the daughter danced with
3. Who Jepthah made the vow with
5. What happened to the people of Ammon
6. Where Jepthah's daughter went to mourn
8. What Jepthah vowed to do to his daughter
9. Where Jepthah lived

## Down

1. People Jepthah wanted to defeat
4. The relative who mourned 2 years
7. Man who made vow

9 of 9 words were placed into the puzzle.

Created by Puzzlemaker at DiscoveryEducation.com

**Year 2**

**Week 60**

## **Samson's Super Strength**

**Scriptures: Judges 13, 14**

**Key Verse: Judges 14:6 And the Spirit of the LORD came mightily upon him, and he tore the lion apart... though he had nothing in his hand.**

### **Key Points:**

1. Again, the Israelites served idols and were oppressed by the Philistines for forty years.
2. God sent an angel to the wife of Manoah, who was barren, and promised her a son. She was told not to drink wine or eat anything unclean because her son would be a Nazirite all his life.
3. Manoah asked God for confirmation, and the angel returned to his wife. Manoah prepared a sacrifice and when the man ascended in the fire, Manoah realized he was an angel of the Lord.
4. Samson was born and grew strong. He selected a wife from the Philistines, although his parents wanted him to marry an Israelite.
5. On his way to make wedding arrangements, Samson killed a lion with his bare hands. On a second trip, Samson found honey inside the lion's carcass. He made a riddle about this event.
6. The Philistines could not solve the riddle, so they threatened Samson's wife. She begged Samson to tell her the answer. When he did, she told the Philistines.
7. Samson left in anger, and his wife was given to another man.

# 64. SAMSON IS BORN

(JUDGES 13)

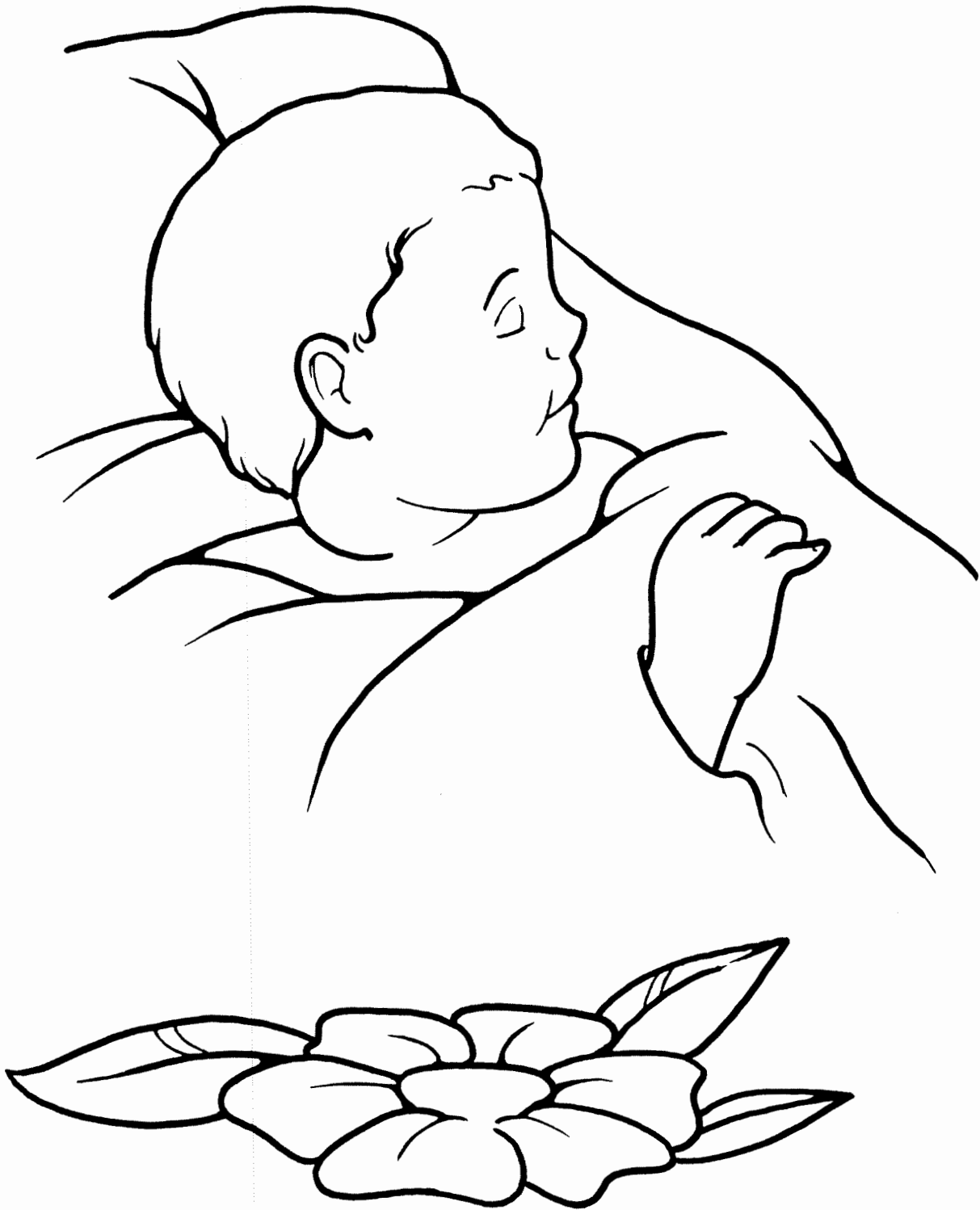

"So the woman bore a son and called his name Samson;  
and the child grew, and the LORD blessed him."

**JUDGES 13:24**

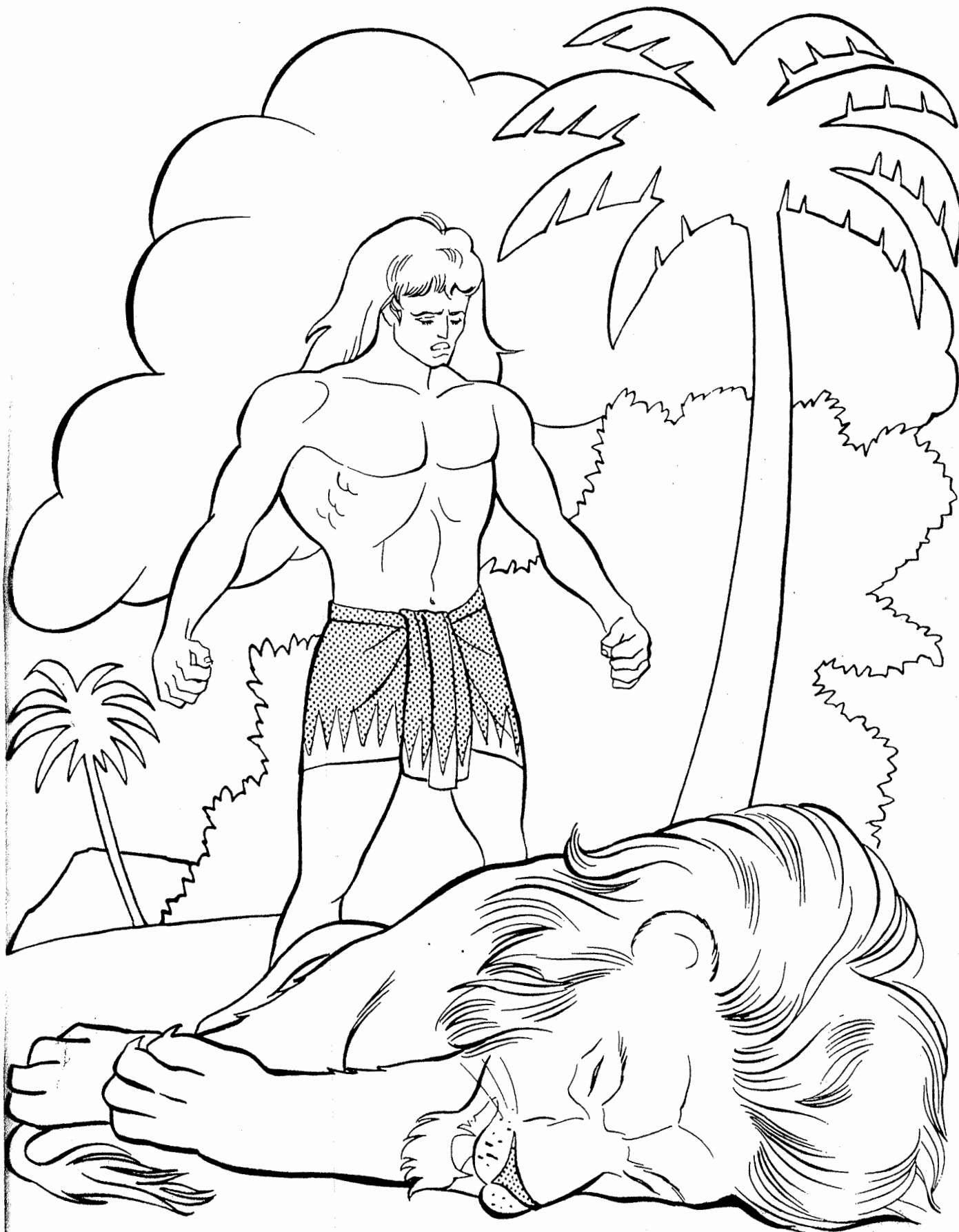

Samson was given the gift of tremendous strength by God. He could tear a lion in half with his bare hands.



“Out of the eater something to eat;  
out of the strong something sweet.”

(Judges 14:14)





When Samson obeyed God, he became very, very strong.  
He could lift logs as big as trees and rip strong  
ropes into little pieces of string.

## **Year 2**

### **Week 61**

#### **Samson Fights Philistines**

**Scriptures: Judges 15, 16**

**Key Verse: Judges 16:28 “Oh Lord God, remember me, I pray! Strengthen me, I pray, just this once.”**

#### **Key Points:**

1. When Samson found out his wife had been given to someone else, he burned the fields, vineyards and the groves of the Philistines.
2. Samson’s own people delivered him to the Philistines to stop the fighting. But Samson broke free and killed 1000 men using a donkey’s jawbone as a weapon.
3. Samson then ruled Israel for twenty years.
4. Samson fell in love with Delilah. The Philistine leaders promised her a large amount of money if she would tell them the secret of Samson’s strength. She made him miserable until he finally told her. While he was sleeping, she had his hair cut.
5. Samson was captured and blinded, and forced to grind corn for the Philistines. While Samson was in prison, his hair grew.
6. The Philistines called for Samson to entertain them at a great feast.
7. God answered Samson’s prayer for strength, and Samson was able to bring down the entire temple. About three thousand men and women were killed with Samson.

# 65. SAMSON AND DELILAH

(JUDGES 16:4-21)



"And it came to pass afterward, that he loved a woman in the valley of Sorek, whose name was Delilah."

**JUDGES 16:4**

“The Spirit of the Lord came  
on him with power...”

“Finding a fresh jawbone of a donkey,  
he grabbed it and struck down  
1,000 men.”

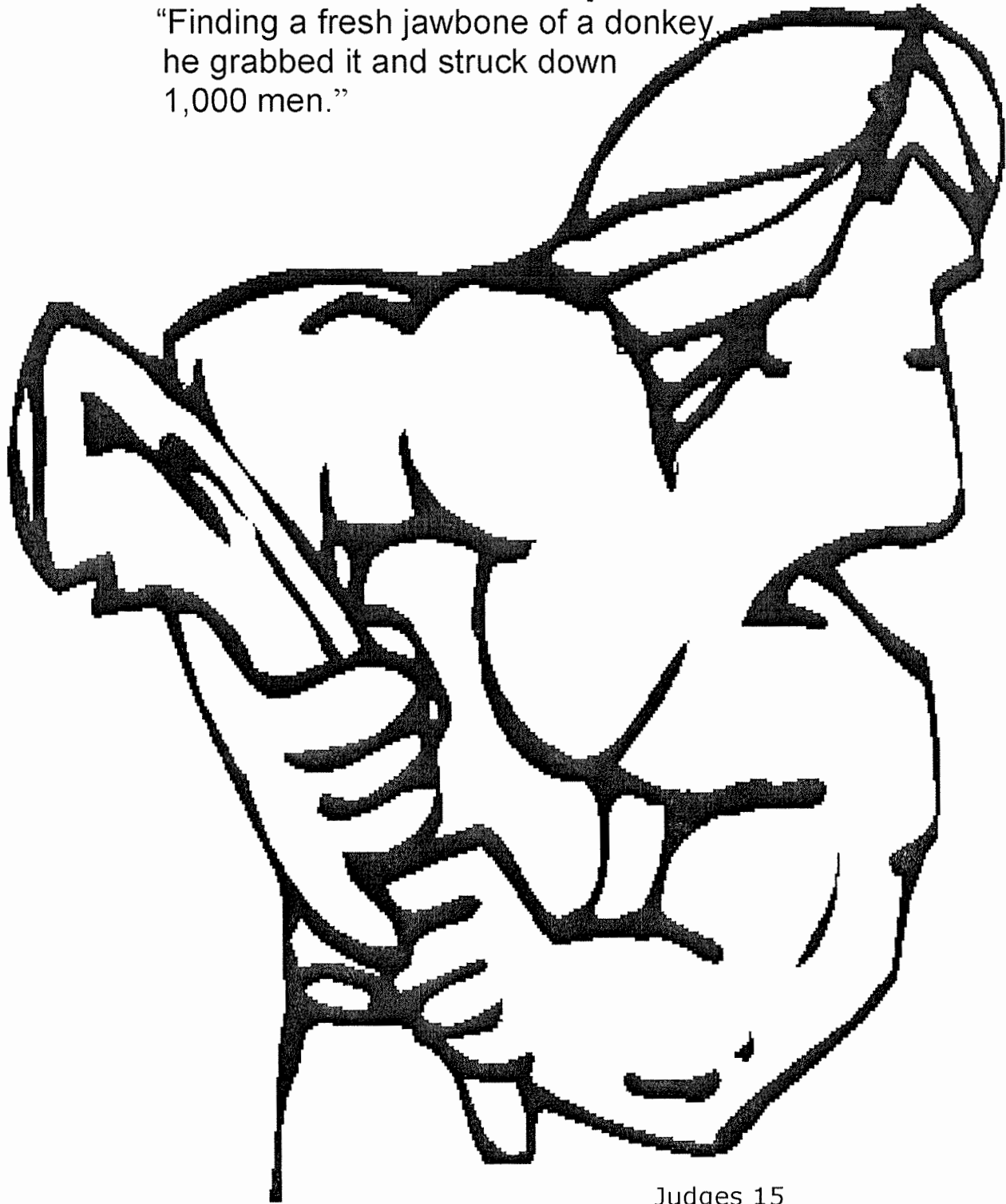

Judges 15

## 66. SAMSON PULLS DOWN A TEMPLE

(JUDGES 16:22-31)



"Then Samson called to the LORD, saying, 'O Lord GOD, remember me, I pray!' "

**JUDGES 16:28**

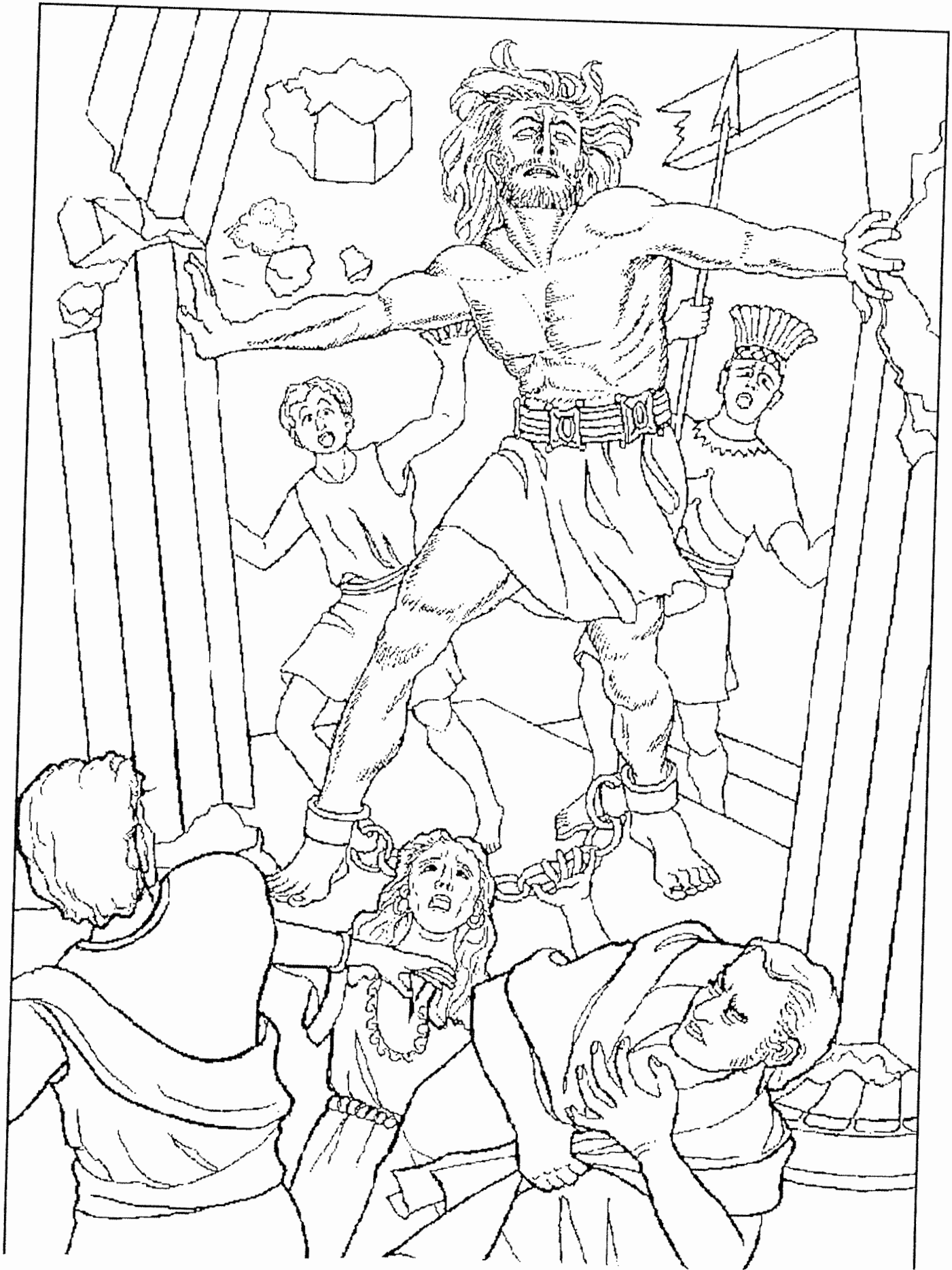

Then Samson prayed to the Lord, "Sovereign Lord, remember me. Please, God, strengthen me just once more, and let me with one blow get revenge on the Philistines for my two eyes." Judges 16:28

Samson, God's Strong Man

A story from God's Word, the Bible,

is found in

Judges 13-16

"The entrance of Your Word gives light."

Psalm 119:130





Bible for Children

presents

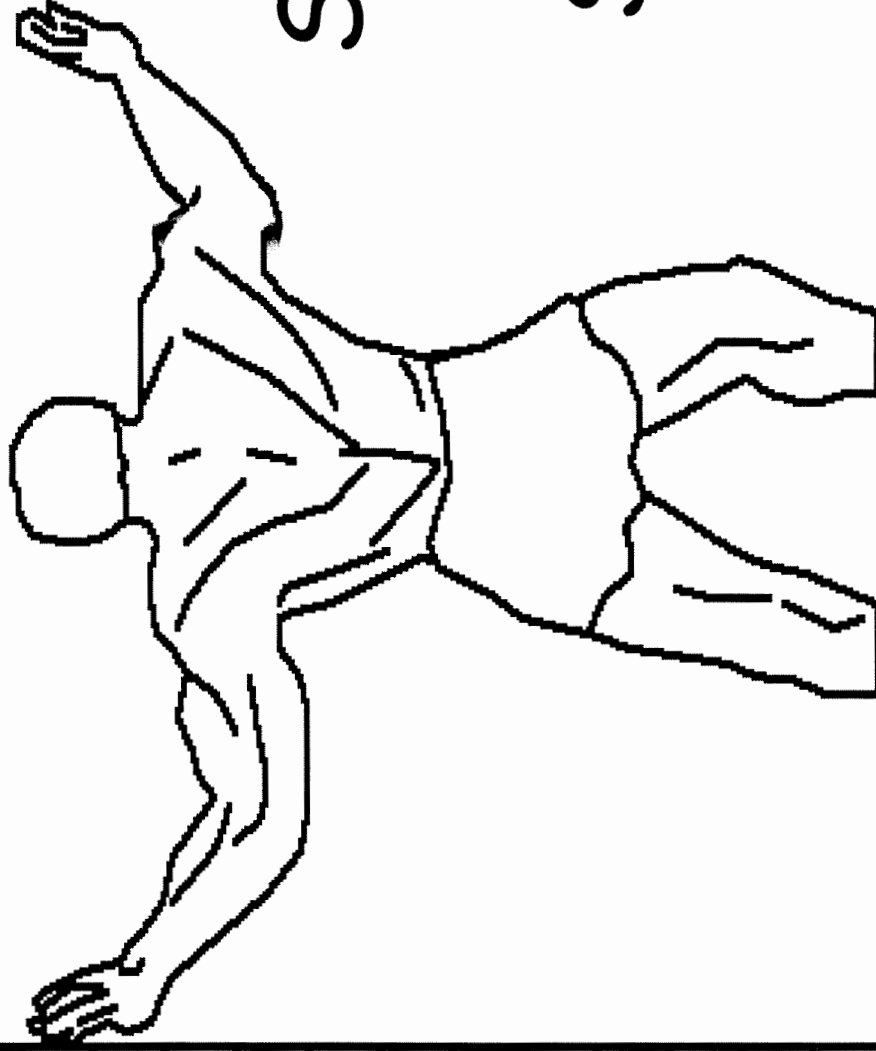

SAMSON,  
GOD'S  
STRONG  
MAN



Long ago, in the land of Israel, lived a man named Manoah. He and his wife had no children. One day the Angel of the LORD appeared to Mrs. Manoah. "You will have a very special baby," He said.

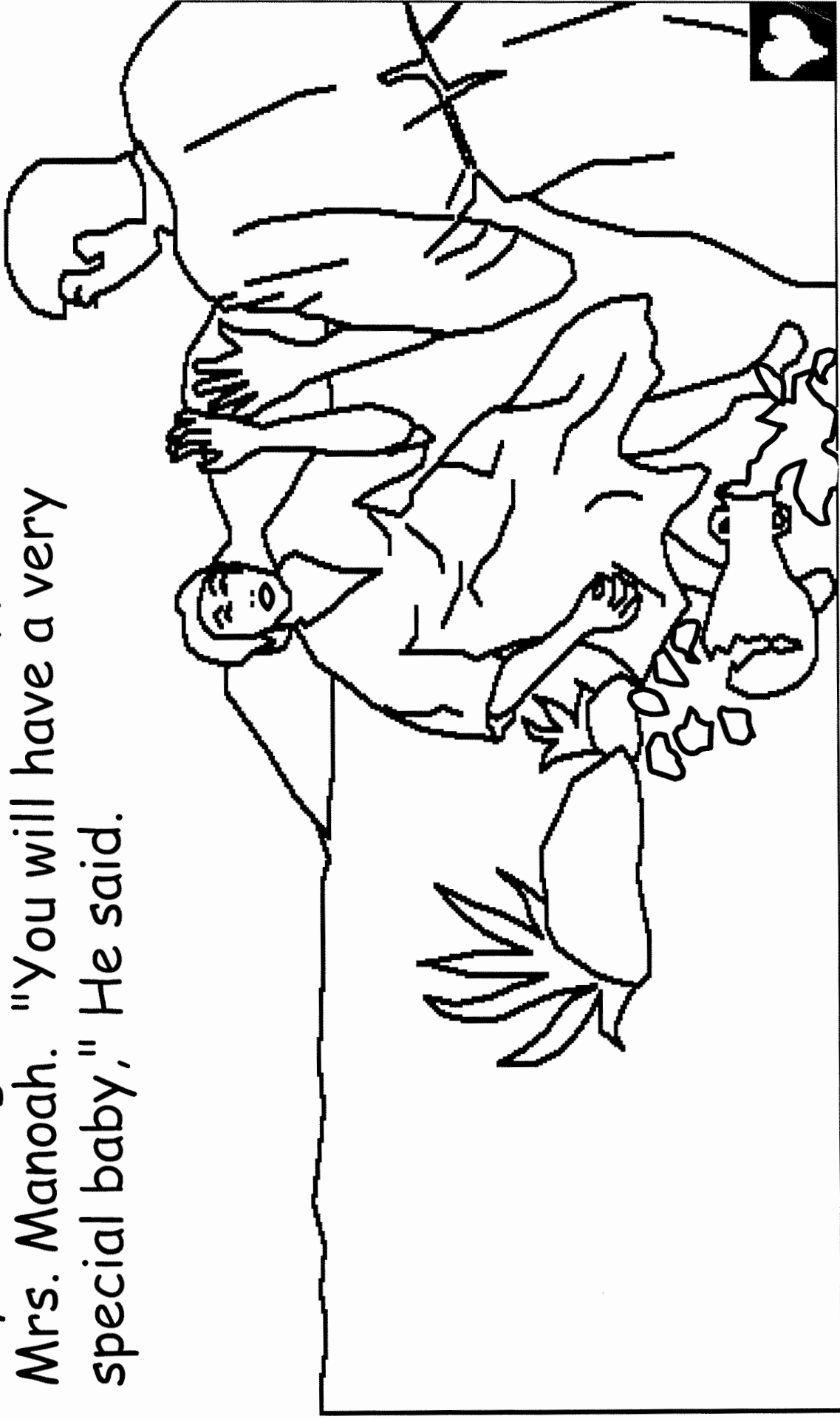

She told her husband the wonderful news. Manoah  
prayed, "Oh my Lord . . . come to us again. Teach  
us what we shall do for the child."

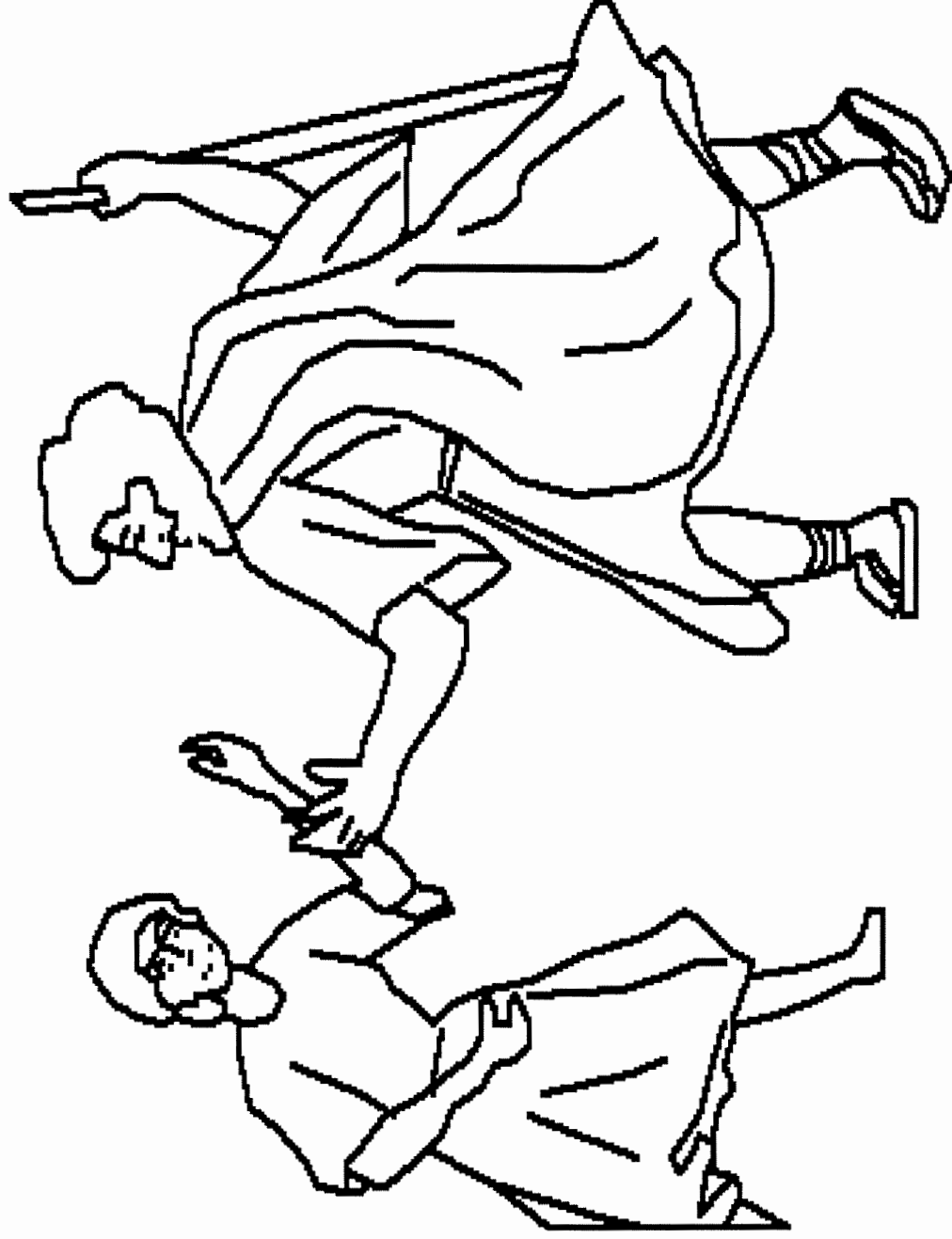

The Angel told Manoah the child must never have his hair cut, must never drink alcohol, and must never eat certain foods. God had chosen this child to be a judge. He would lead Israel.

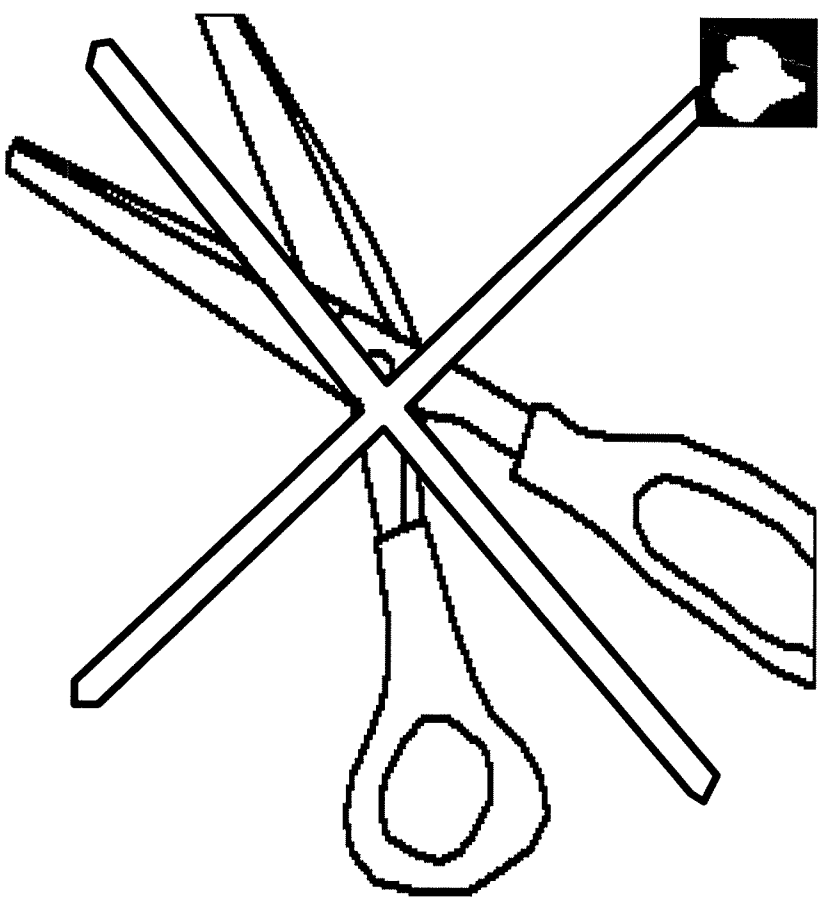
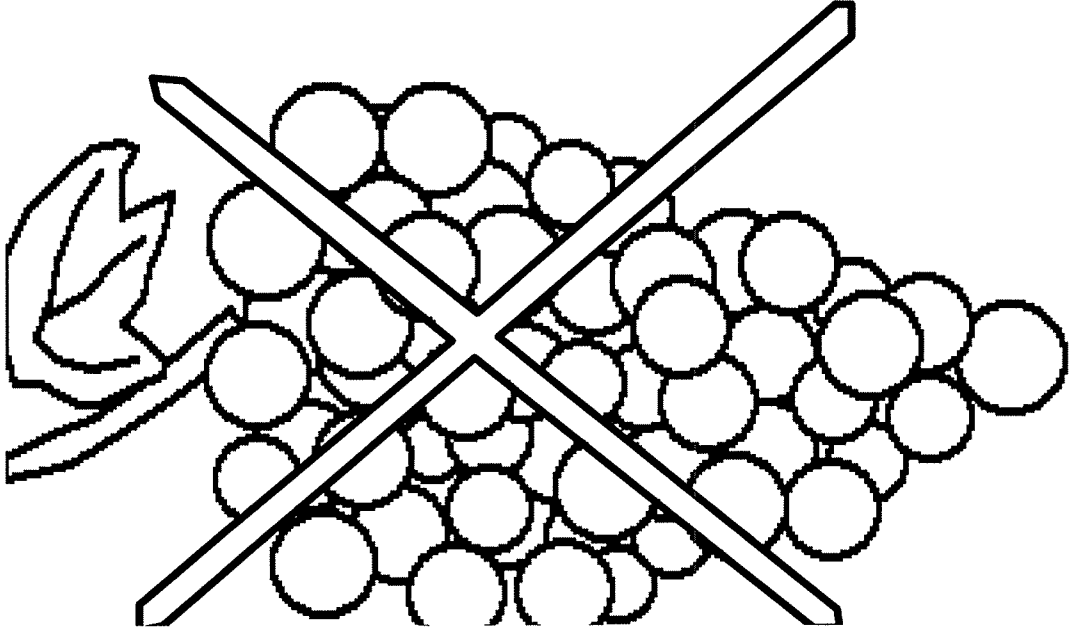

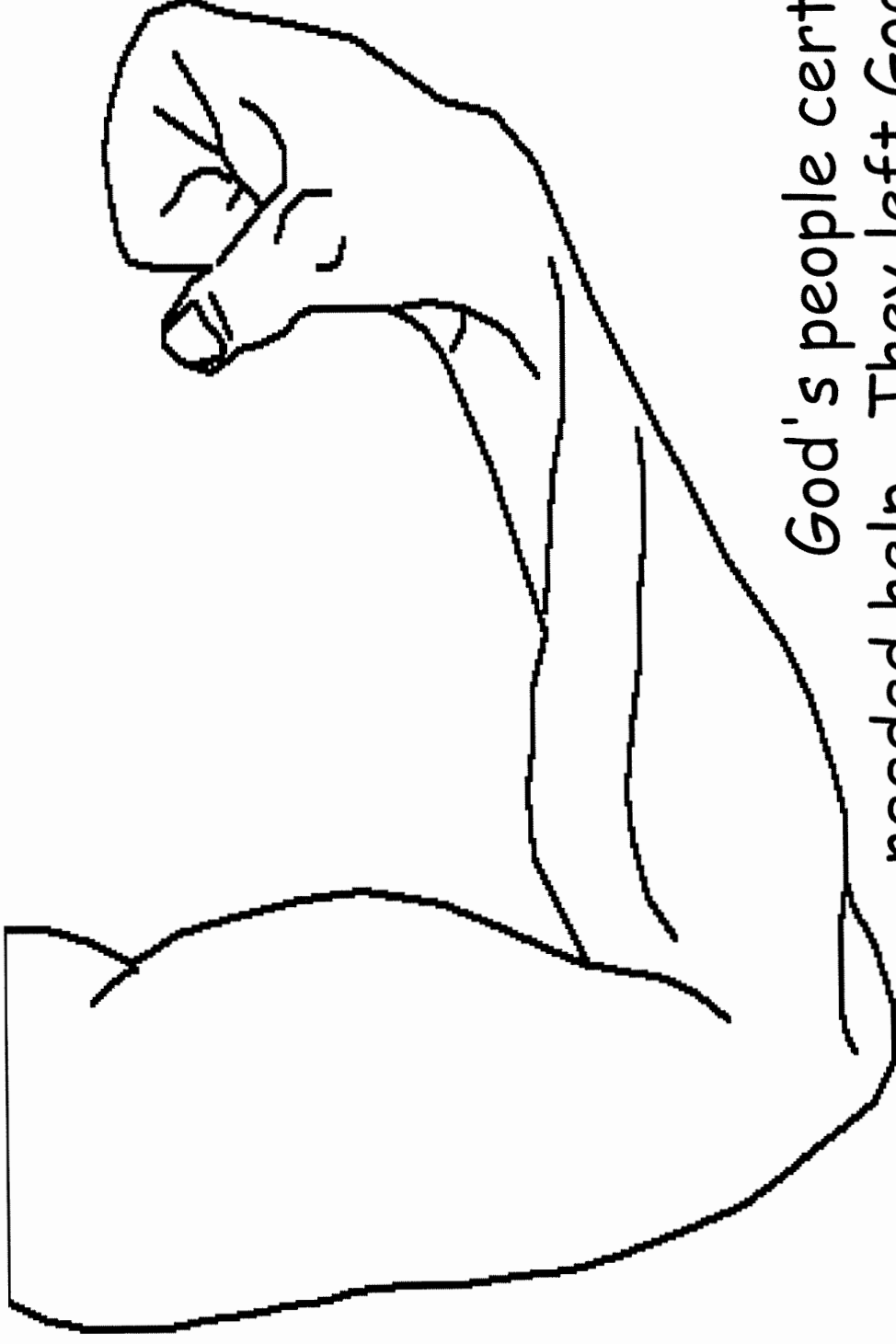

God's people certainly needed help. They left God out of their lives, and then were bullied by their enemies, the Philistines. But when they prayed, God heard. He sent this baby who would become the world's strongest man.



"So the woman bore a son and called his name Samson: and the child grew, and the LORD blessed him. And the spirit of the LORD began to move upon him." Samson became very strong. One day he fought a young lion with his bare hands - and killed it!

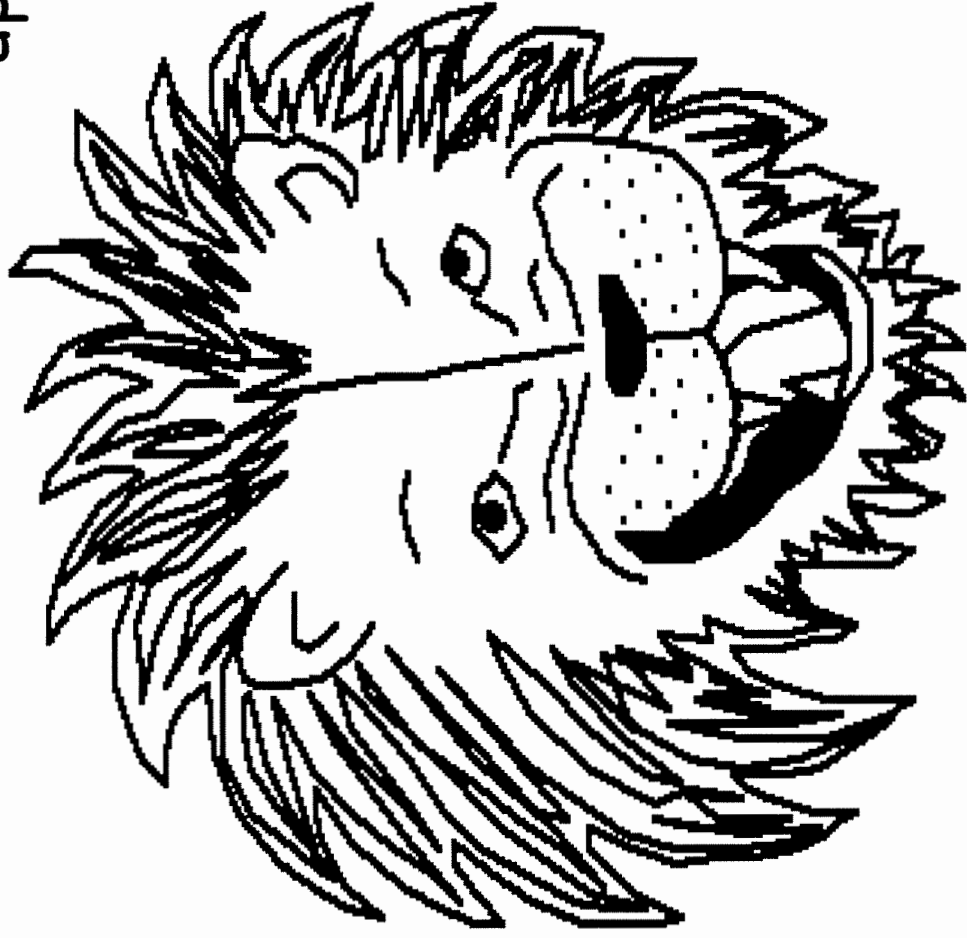

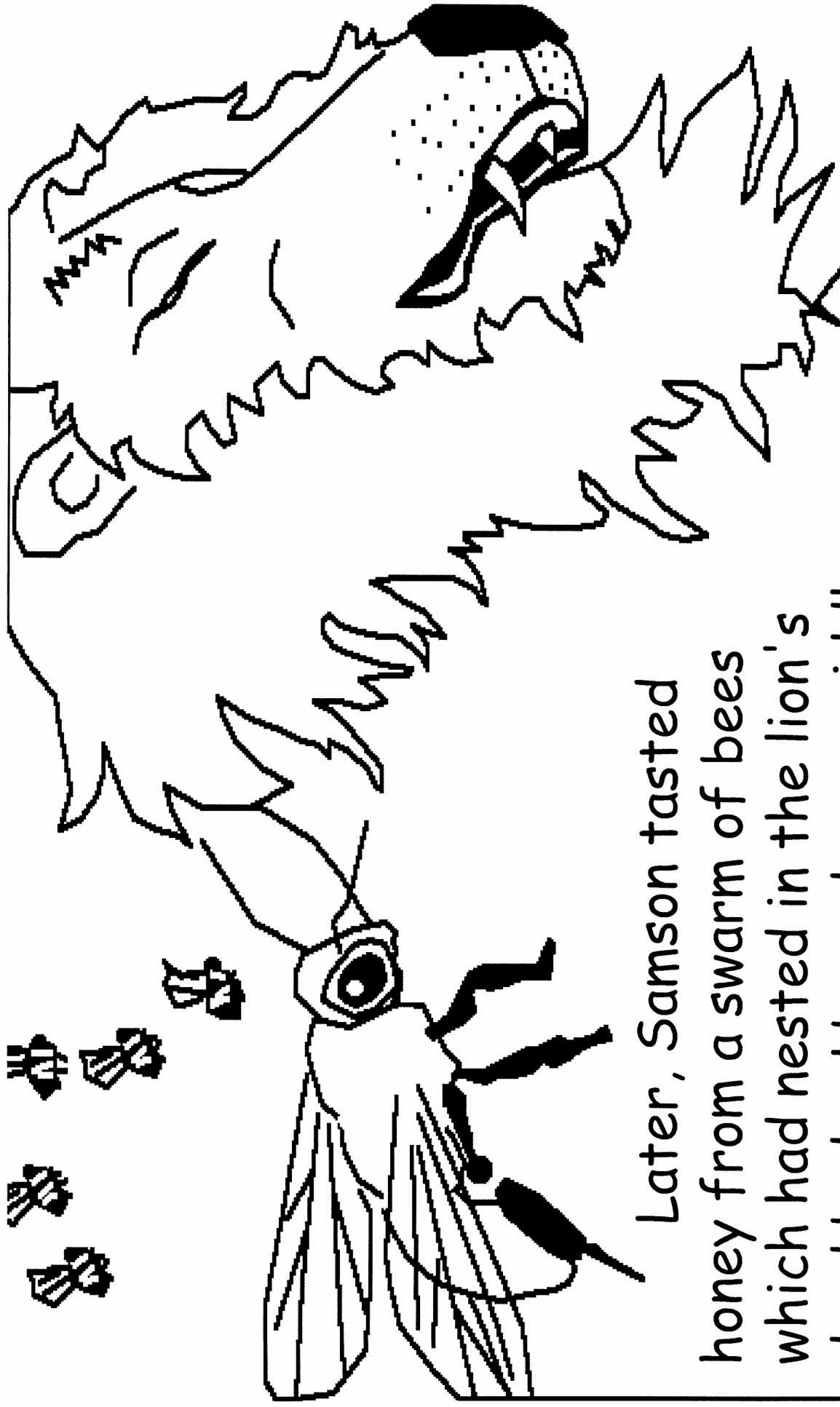

Later, Samson tasted honey from a swarm of bees which had nested in the lion's dead body. He made up a riddle: "Out of the eater Came something to eat And out of the strong Came something sweet."

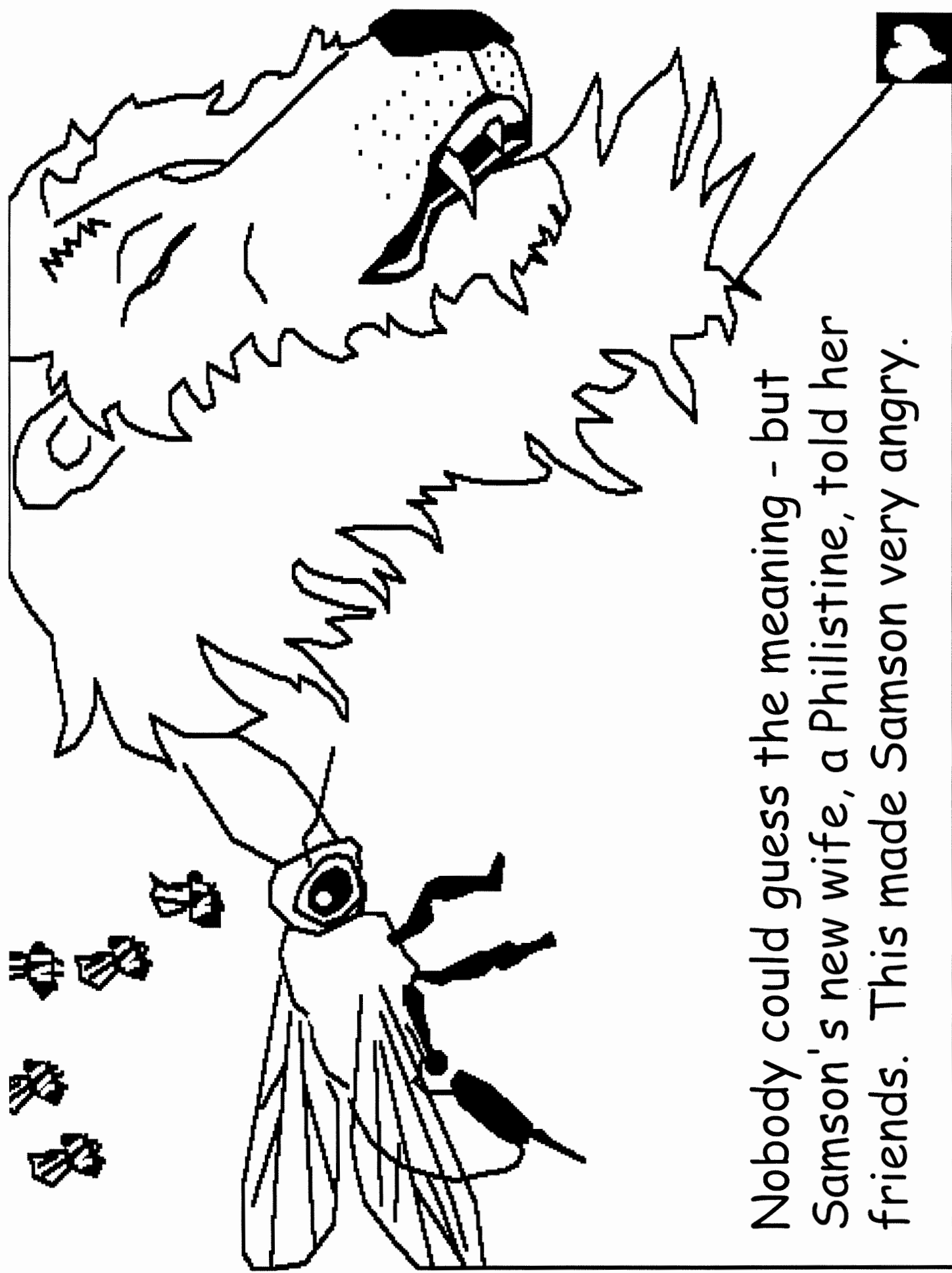

Nobody could guess the meaning - but Samson's new wife, a Philistine, told her friends. This made Samson very angry.



Samson was even more angry when the Philistines gave his wife to be wife of his best friend. He planned revenge. But how? First, Samson caught 300 foxes. Then he tied their tails together, two by two, and placed flaming torches between them.



Then Samson released the foxes in the Philistines' grain fields!

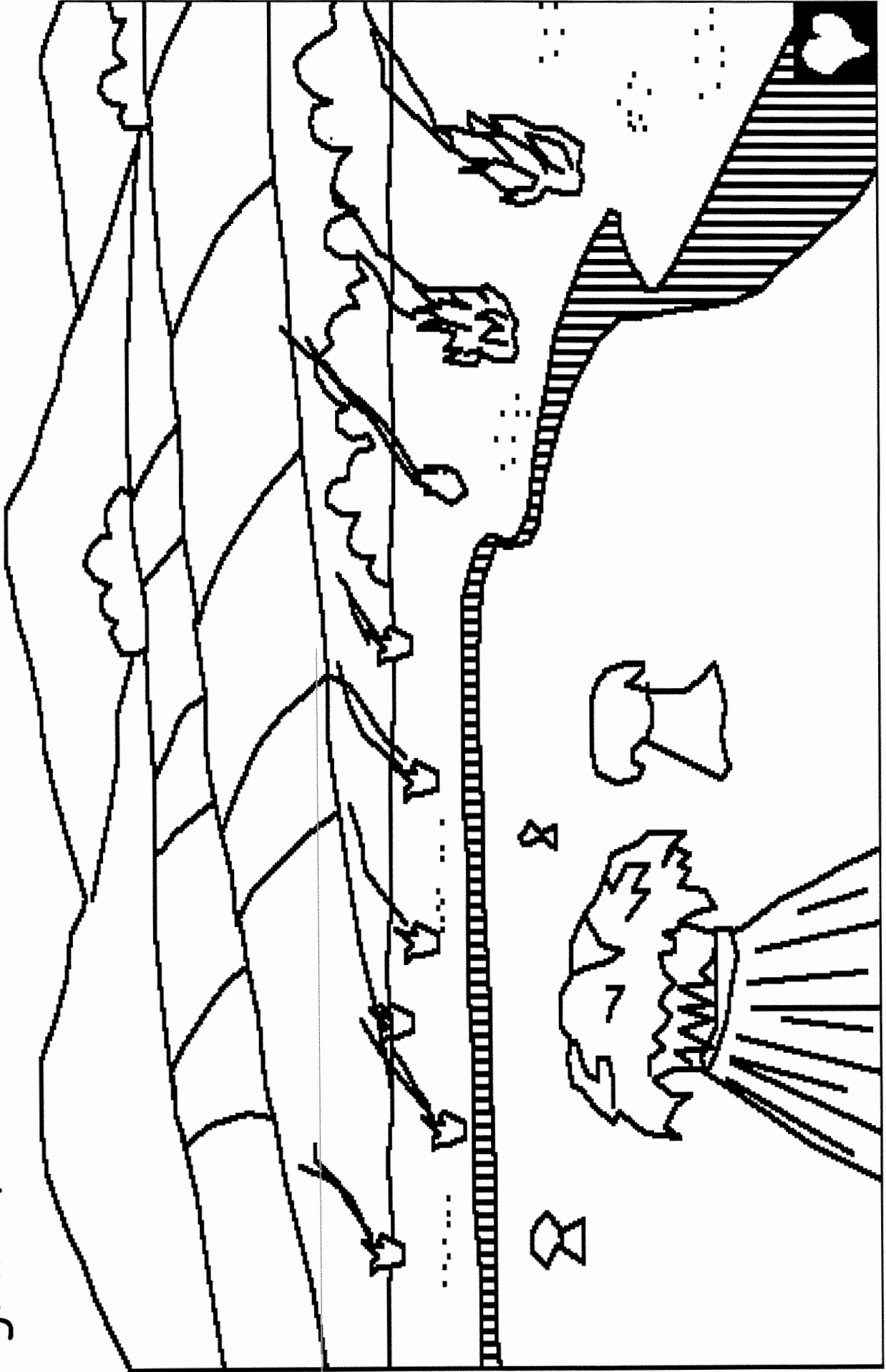

Now the Philistines wanted revenge. Samson let himself be caught, tied up and handed over to be killed by the Philistines.

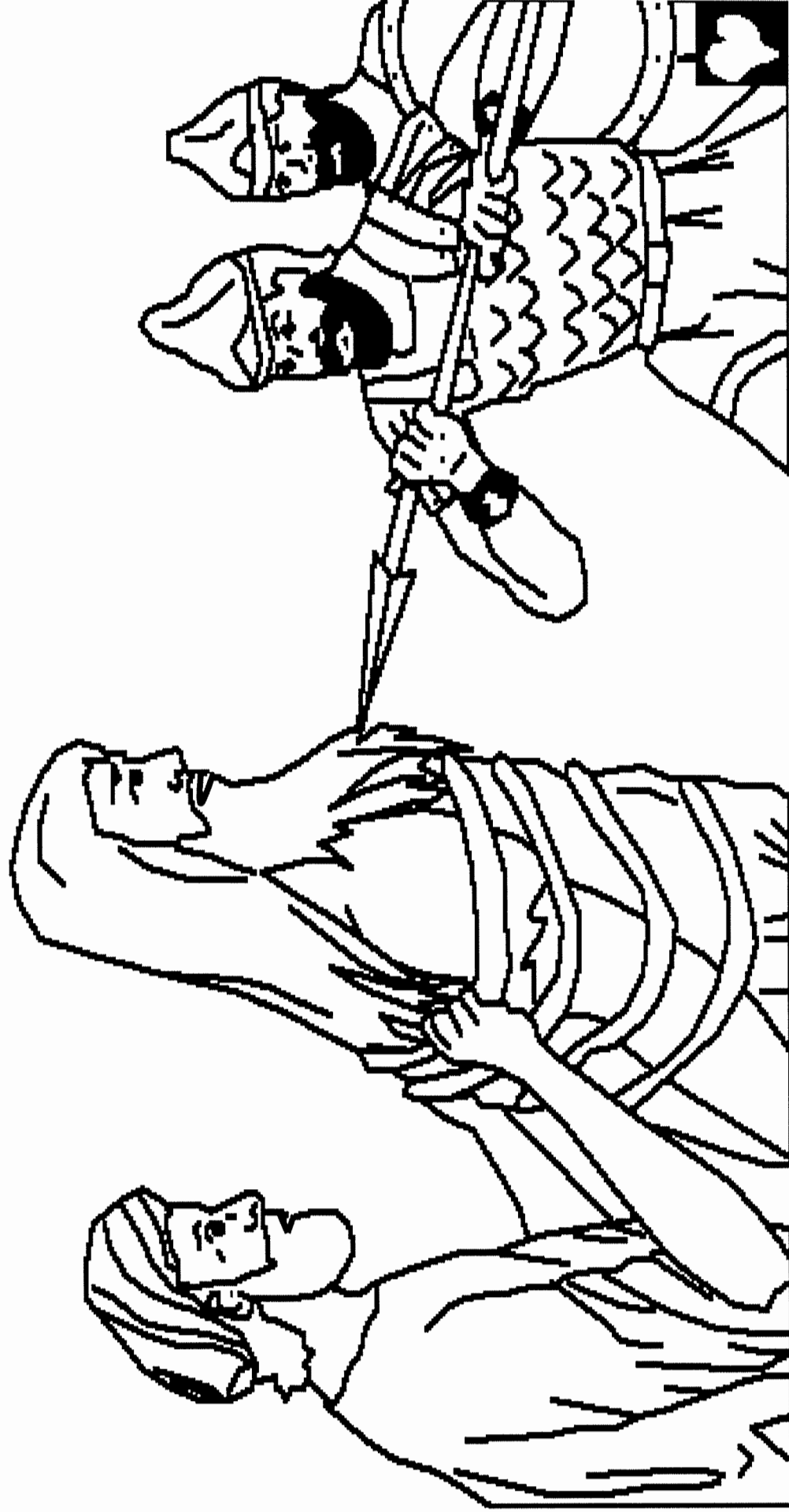

But the Spirit of the Lord  
came upon Samson. He broke  
the ropes, picked up a fresh  
jawbone from a dead donkey,  
and killed 1000 enemies.

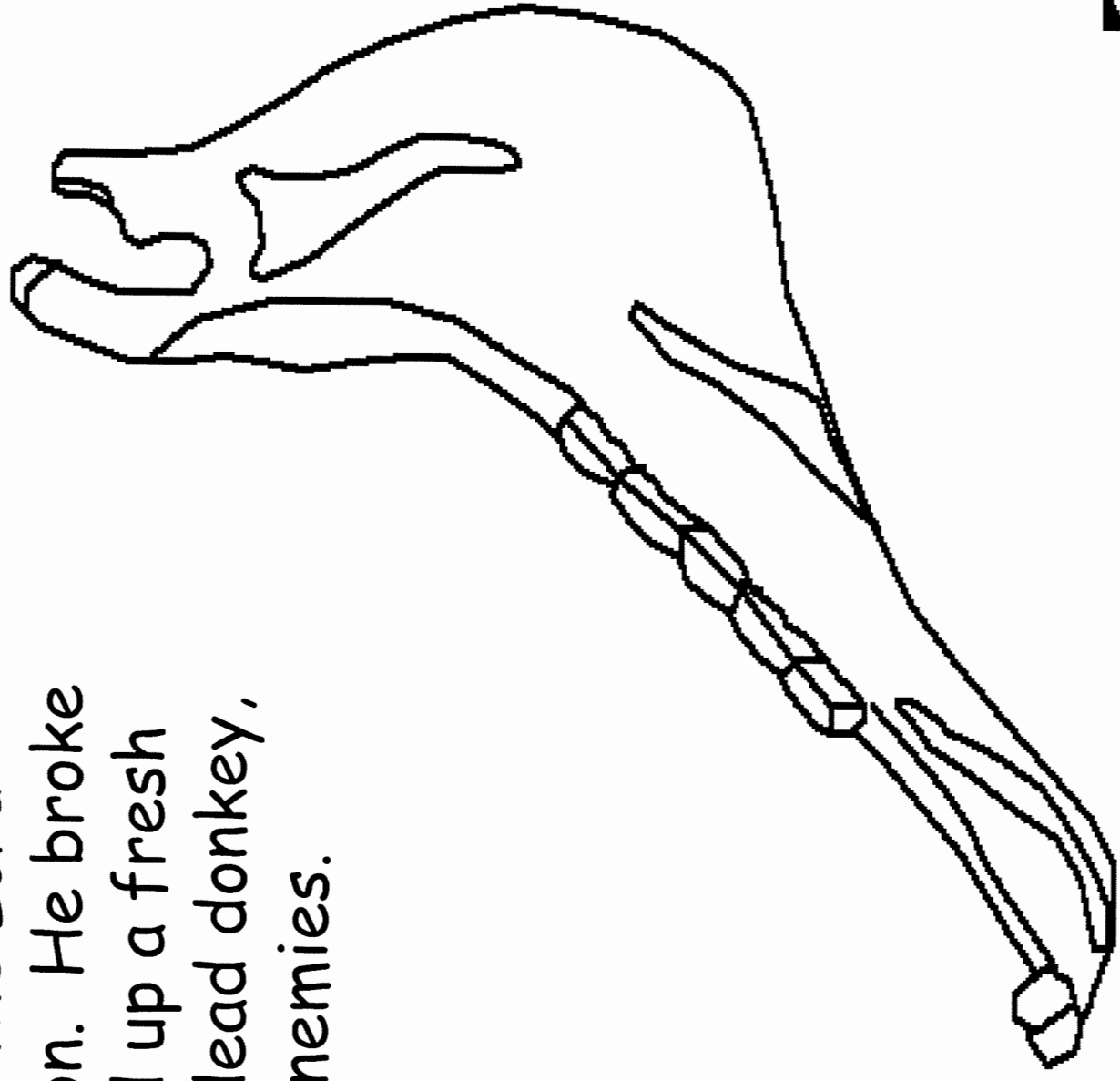

Philistine search parties looked for Samson. One night, they trapped him in a city and locked the city gates. But Samson walked out - carrying the city gates on his shoulders!

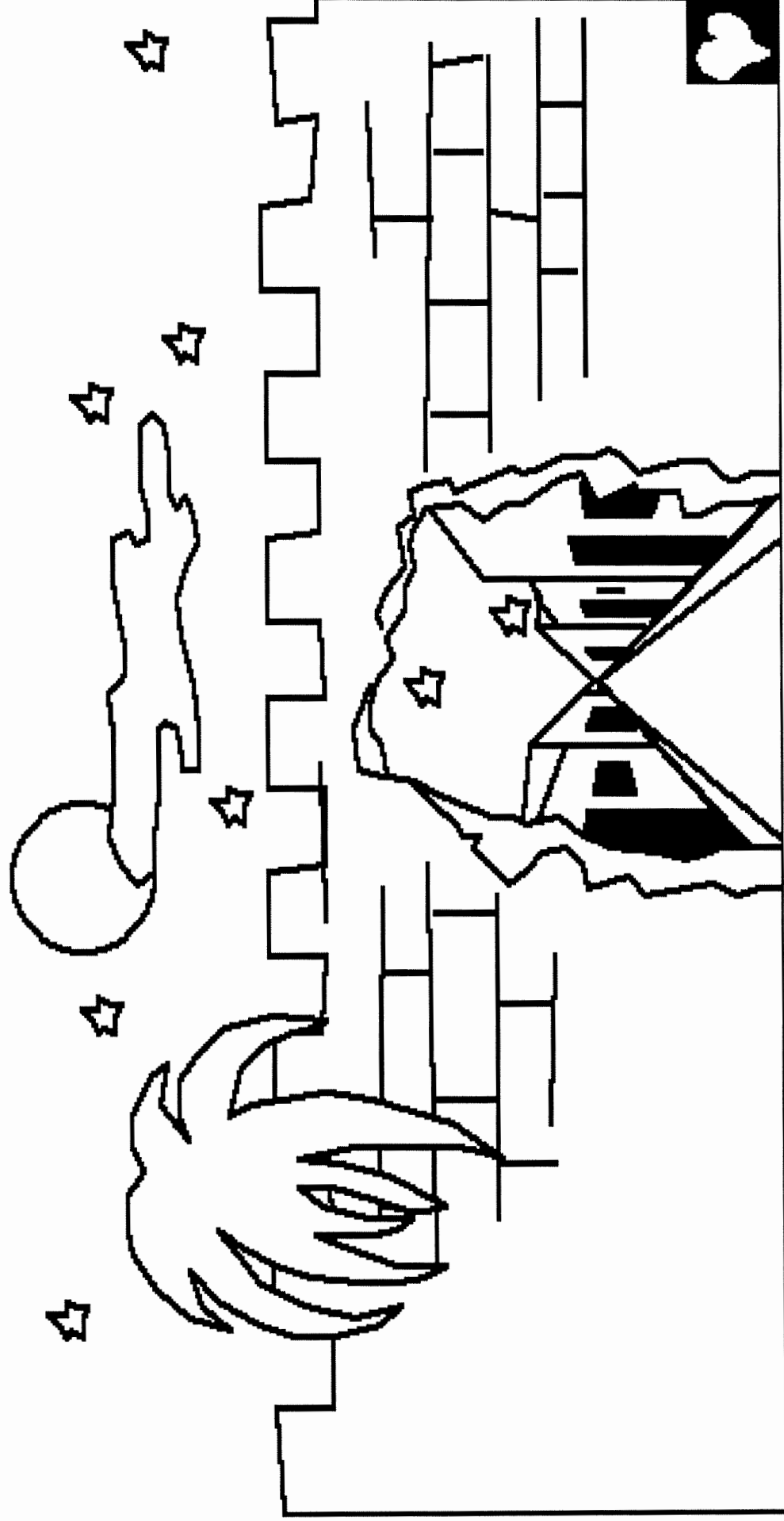

But Samson failed God. God gave him strength as long as he obeyed. One day, Samson shared the secret of his strength with Delilah, a beautiful Philistine spy. She had a man shave off Samson's hair while he slept.

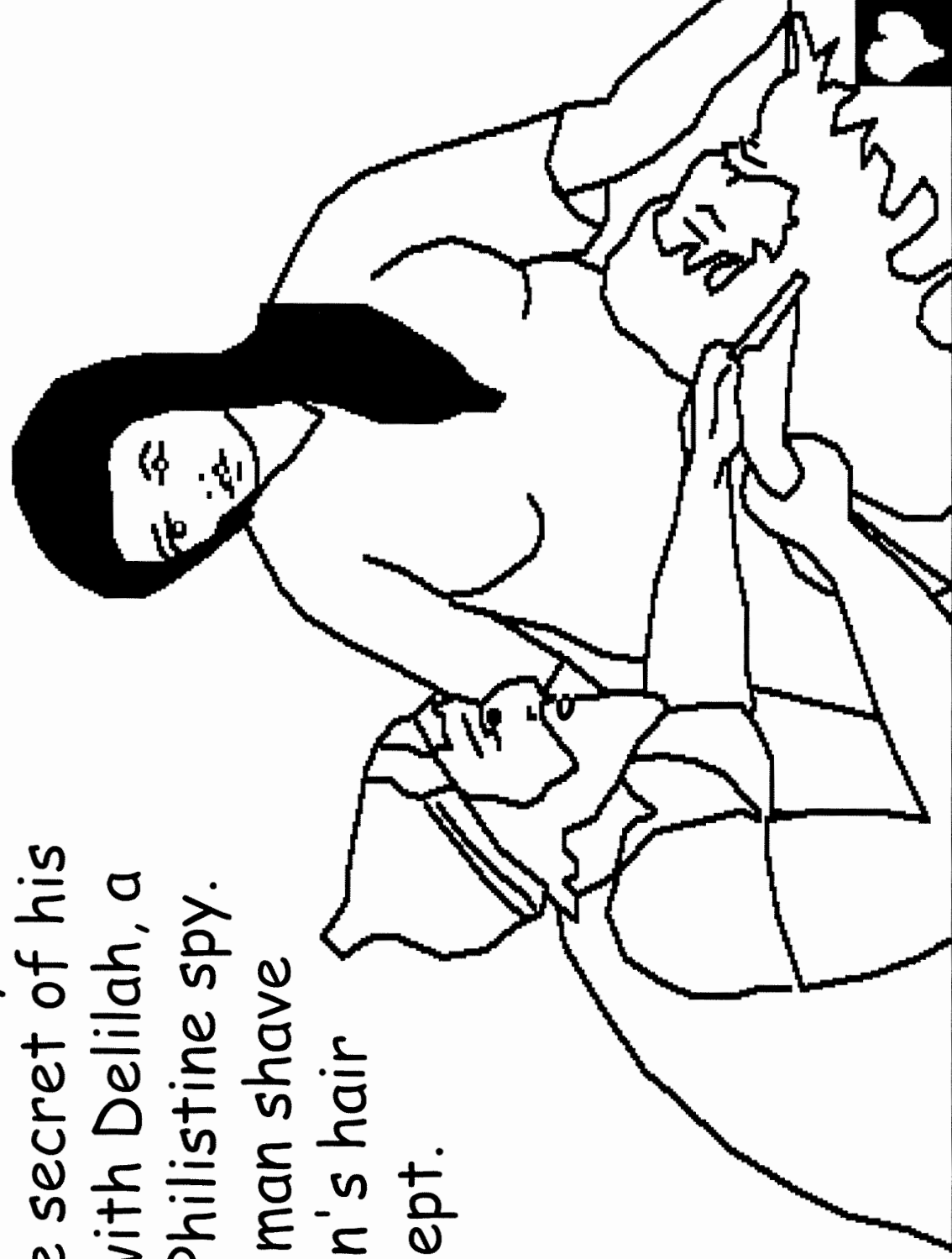

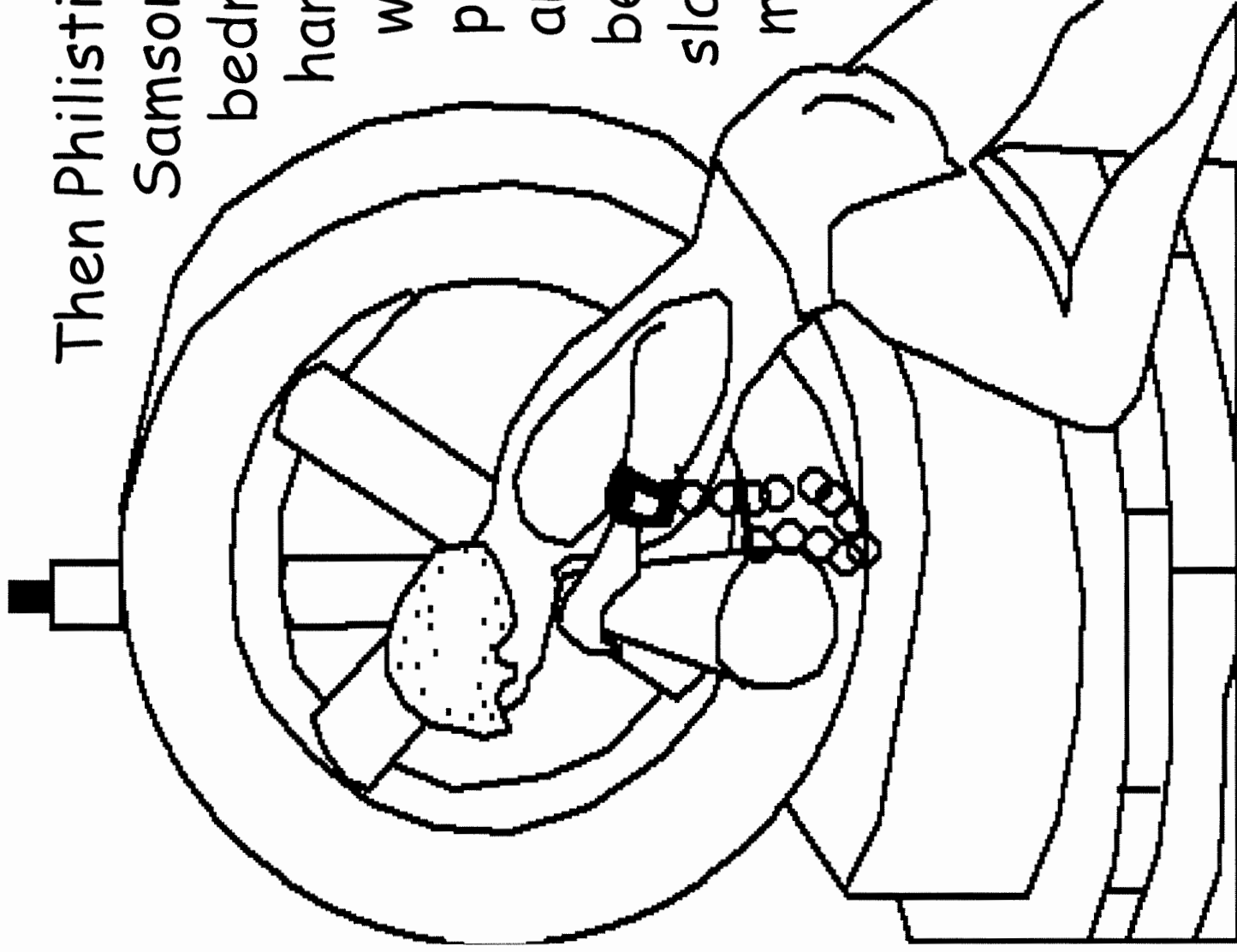

Then Philistine soldiers attacked Samson in Delilah's bedroom. Samson fought hard - but his strength was gone. His enemies put out his eyes. Blind and weak, Samson became the Philistines' slave. They laughed and mocked God's servant.

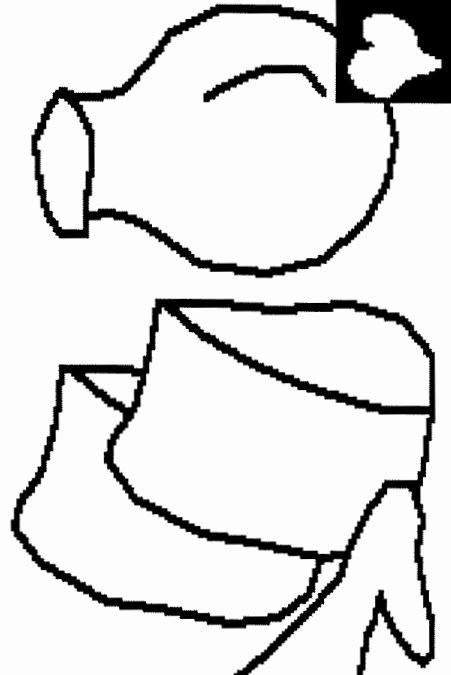

The Philistines had a feast. They praised their fish-god, Dagon, for giving Samson into their hands. They drank and rejoiced in Dagon's temple. Then they called for Samson to perform for them.

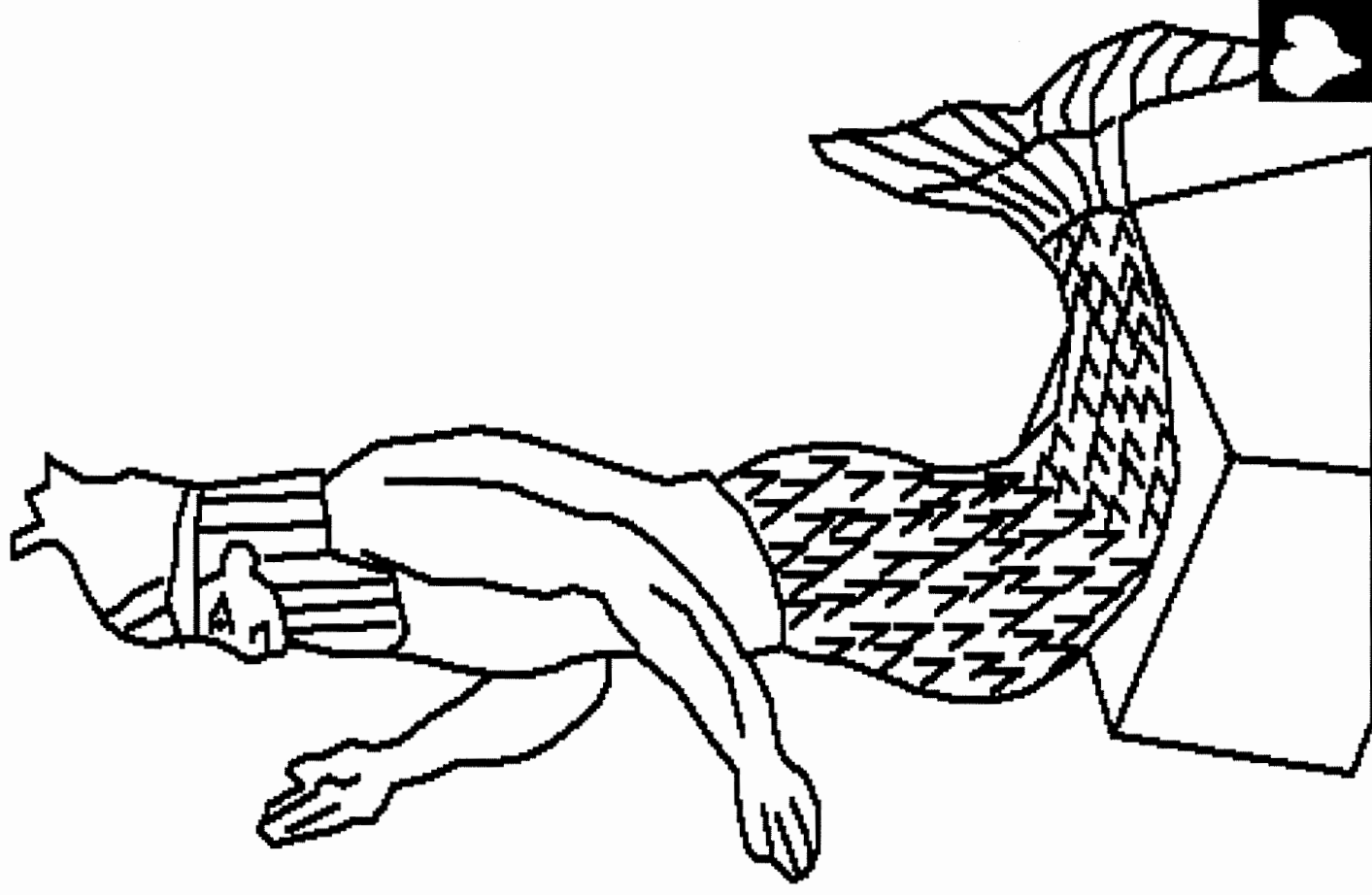



A boy brought Samson, and let him lean on the pillars which held up the temple. There were 3000 Philistines on the roof, and many more in the temple, all mocking him.

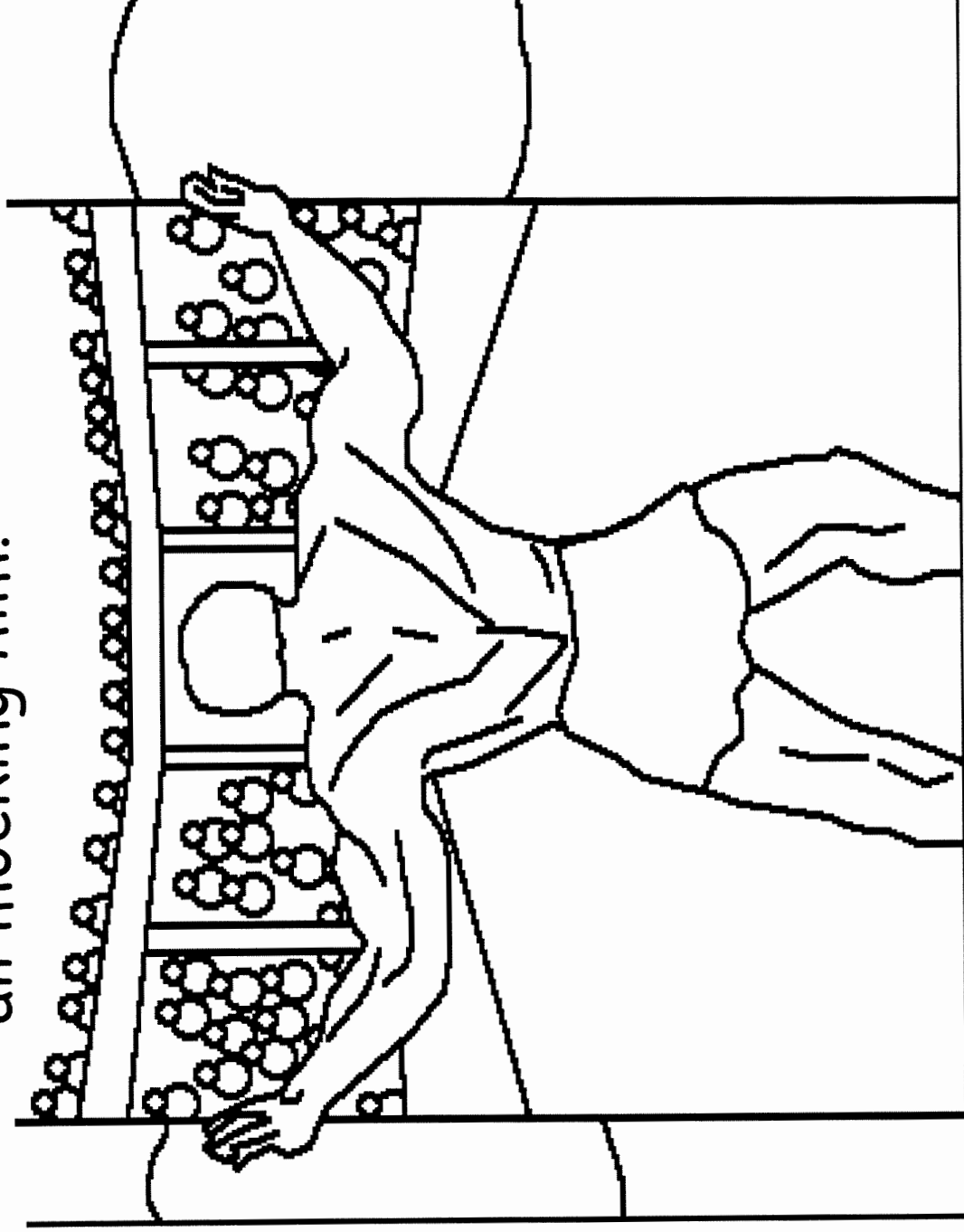

But Samson's hair had begun to grow in the prison. Now he prayed, "O Lord GOD, strengthen me just this once, that I may take revenge for my two eyes."



Would God give Samson strength again? Could Samson do the impossible? YES! YES! Straining and heaving, Samson forced the mighty pillars apart.

Dagon's temple crashed to ruins, killing thousands of Philistines - and Samson!

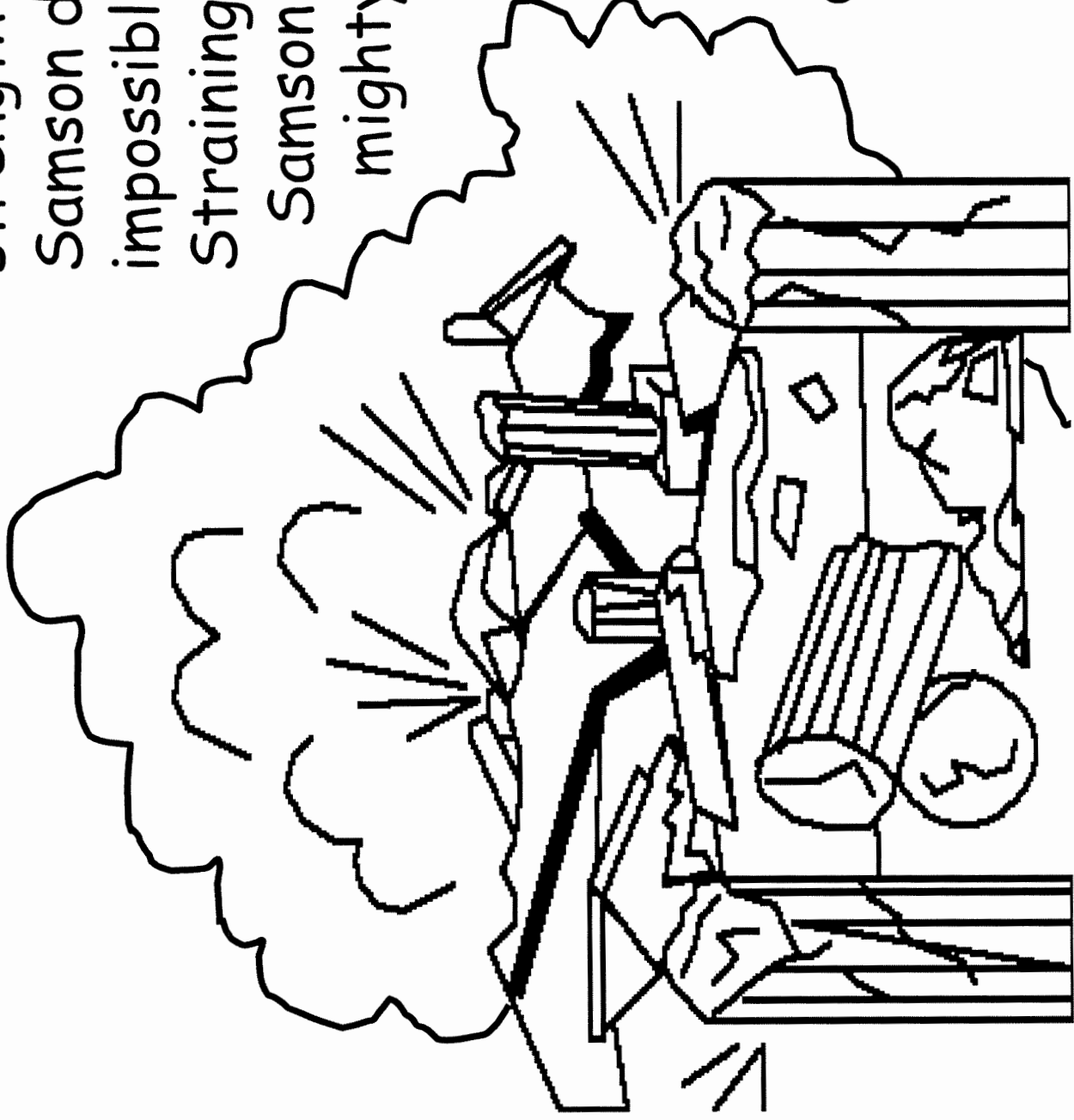

# Samson & Delilah Crossword

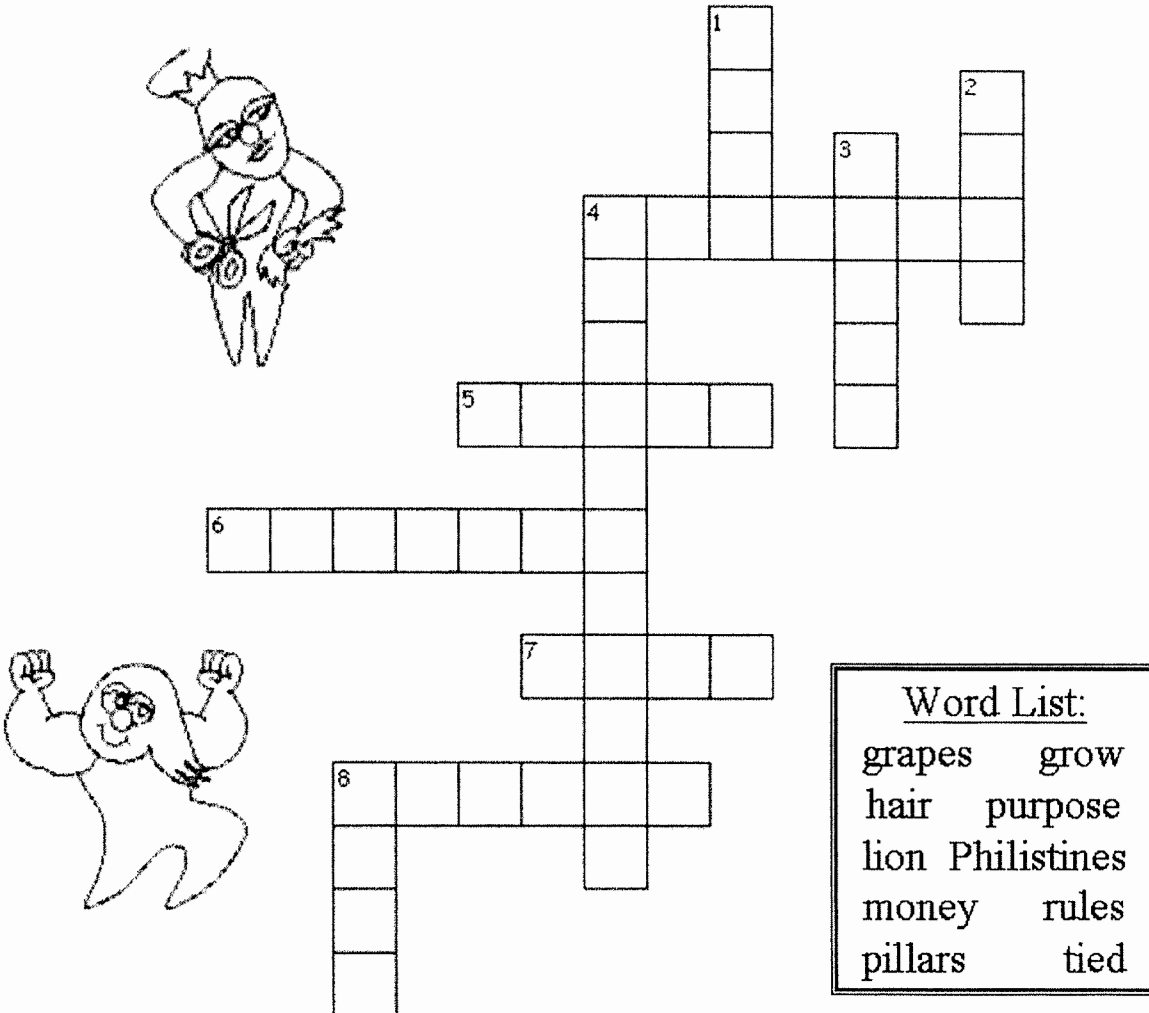

## Across

4. Samson wasn't perfect but God still gave him a \_\_\_\_ to fulfill.
5. Samson had to follow 3 specific \_\_\_\_ given from God before he was born.
6. Samson was tied to two of these and brought them down on himself and the Philistines.
7. Because of Samson's special strength he was able to kill this animal with his bare hands.
8. Samson wasn't allowed to eat or drink anything made from this fruit.

## Down

1. Samson's secret strength really came from God but he only had strength if he didn't cut this.
2. Delilah did this to Samson's hands when he was sleeping to see if she knew the secret.
3. Delilah tried to trick Samson in giving up his secret so she could get some of this.
4. God chose Samson to free the Israelites from these people.
8. The Philistines captured Samson but his hair started to \_\_\_\_ and he got his strength back.

# Samson and Delilah

M P E T I R A Z A N G  
R H W R T X L S K N V  
D I H A I R E I Q H T  
E L P F N P D L O J G  
N I I Y O Y G N U N H  
O S L R S R E D U A W  
B T L L M Y G K L O R  
W I A M A E R I N G B  
A N R C S Y L V J O H  
J E S H M E K R R Y D  
N S E G D U J M R W X

[www.churchhousepuzzles.com](http://www.churchhousepuzzles.com) © 2011

Bound	Judges
Delilah	Lion
Donkey	Nazarite
Hair	Philistines
Honey	Pillars
Jawbone	Ropes
Judges	Samson

# 65. SAMSON AND DELILAH

## (JUDGES 16:4-21)

### MEMORY VERSE:

*"No razor has ever come upon my head, for I have been a Nazirite to God from my mother's womb."*  
JUDGES 16:17

### FILL IN THE BLANK:

1. Samson "loved a woman in the Valley of Sorek, whose name was \_\_\_\_\_." JUDGES 16:4

### TRUE OR FALSE:

2. Now the lords of the Philistines said to her, "Find out where his great strength lies, and by what means may we overpower him, that we may bind him to afflict him." JUDGES 16:5  
TRUE OR FALSE
3. They said to her, "Every one of us will give you eleven hundred pieces of silver." JUDGES 16:5  
TRUE OR FALSE
4. But Delilah said to them, "I will not do this thing for you." JUDGES 16:6  
TRUE OR FALSE

### CIRCLE THE CORRECT WORDS:

5. "Samson said to her, 'If they bind me with seven fresh (**PIANO STRINGS, BOWSTRINGS**), not yet dried, then I shall become weak, and be like any other man.'" JUDGES 16:7
6. "But he broke the (**PIANO STRINGS, BOWSTRINGS**) as a strand of yarn breaks when it touches fire. So the secret of his strength was not known." JUDGES 16:9
7. Samson then said to Delilah, "If they bind me securely with new (**ROCKS, ROPES**) that have never been used, then I shall become weak, and be like any other man." JUDGES 16:11
8. But Samson "broke them off his arms like a (**THREAD, SHIRT**)." JUDGES 16:12
9. Then Samson said to her, " 'If you weave the seven locks of my (**HEAD, BEARD**) into the web of the loom'-- So she wove it tightly with the batten of the loom, and said to him, 'The Philistines are upon you, Samson!' But he awoke from his sleep, and pulled out the batten and the web from the loom." JUDGES 16:13-14
10. Then "he told her all his heart, and said to her, 'No (**HAT, RAZOR**) has ever come upon my head, for I have been a Nazirite to God from my mother's womb. If I am shaven, then my strength will leave me, and I shall become weak, and be like any other man.'" JUDGES 16:17

### TRUE OR FALSE:

11. "Then she lulled him to sleep on her knees, and called for a man and had him shave off the seven locks of his head. Then she began to torment him, and his strength left him." JUDGES 16:19  
TRUE OR FALSE
12. "And she said, 'The Philistines are upon you, Samson!' So he awoke from his sleep, and said, 'I will go out as before, at other times, and shake myself free!' But he did not know that the LORD had departed from him." JUDGES 16:20  
TRUE OR FALSE
13. Then the Philistines let Samson go and gave him great rewards. JUDGES 16:21  
TRUE OR FALSE

# 65. SAMSON AND DELILAH

## (JUDGES 16:4-21)

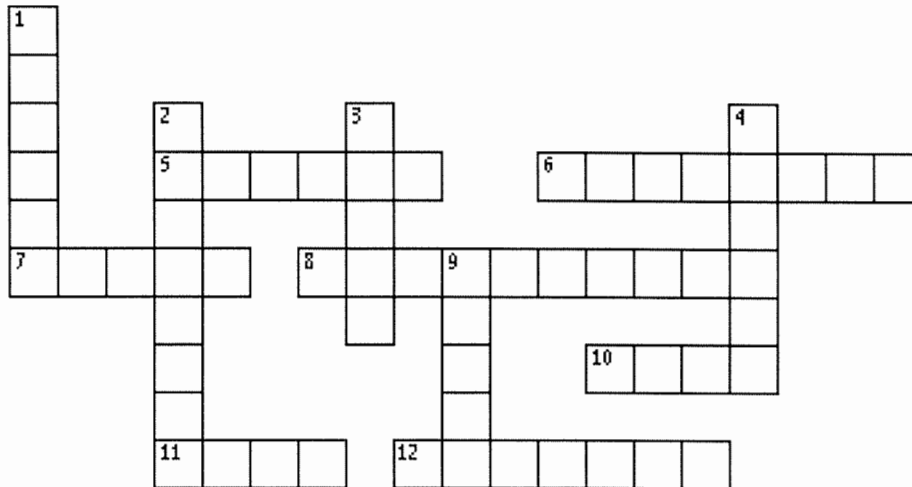

- 12 ACROSS Samson "loved a woman in the Valley of Sorek, whose name was \_\_\_\_." **JUDGES 16:4**
- 2 DOWN Now the lords of the Philistines said to her, "Find out where his great \_\_\_\_ lies, and by what means may we overpower him, that we may bind him to afflict him." **JUDGES 16:5**
- 1 DOWN They said to her, "Every one of us will give you eleven hundred pieces of \_\_\_\_." **JUDGES 16:5**
- 8 ACROSS "Samson said to her, 'If they bind me with seven fresh \_\_\_\_, not yet dried, then I shall become weak, and be like any other man.' " **JUDGES 16:7**
- 10 ACROSS "But he broke the bowstrings as a strand of \_\_\_\_ breaks when it touches fire. So the secret of his strength was not known." **JUDGES 16:9**
- 7 ACROSS Samson then said to Delilah, "If they bind me securely with new \_\_\_\_ that have never been used, then I shall become weak, and be like any other man." **JUDGES 16:11**
- 5 ACROSS But Samson "broke them off his arms like a \_\_\_\_." **JUDGES 16:12**
- 11 ACROSS Samson said to her, "If you weave the seven locks of my \_\_\_\_ into the web of the loom-" **JUDGES 16:13**
- 3 DOWN "He told her all his heart, and said to her, 'No \_\_\_\_ has ever come upon my head.' " **JUDGES 16:17**
- 9 DOWN "Then she lulled him to sleep on her knees, and called for a man and had him \_\_\_\_ off the seven locks of his head." **JUDGES 16:19**
- 6 ACROSS "He did not know that the LORD had \_\_\_\_ from him." **JUDGES 16:20**
- 4 DOWN "They bound him with bronze fetters, and he became a grinder in the \_\_\_\_." **JUDGES 16:21**

# 65. SAMSON AND DELILAH

(JUDGES 16:4-21)

I X W L T B I D X R G W L U W B G J S T  
O Y G O L D F G Y A R N K H J V X C H J  
X L F U M V B P C Y Y D I I V B W R P L  
K N Z P E N L C X R Q K Q P H W E X W J  
E D A W Z P A R E D N I R G Y A D V J T  
Y N O S M A S V P E D B S K D Y I D H B  
T C N C I S E U R P O A P R G U C I N V  
E V S R I Y E I E W O R S E M K P M F Q  
Z O H E D G Z N S V I G O N T Y S O G O  
Q S U V Z N C T I S O S E A U T L O I V  
V K S L P W R P O T K A Z I R H R F E Y  
L L Y I Z I L N M T S U P E V F O U G X  
S S J S N R W N H O P I N P E Q Z D W C  
R D H G V Y I S Y J Z G L Q Z L A I K J  
S F S A U Z C A Y Q T K E I U H R V O N  
B A N P V U A C H H S S U F H M O E I R  
B B D R D E H A L I L E D R U P P M L O  
Z R Y F W G D N M L T Y V C I G D N D P  
F N I M E F Z P B P V P F G X Q Q B S E  
W E B E E Y S C P V G F I O Q W J A U S

BOWSTRINGS  
DELILAH  
GRINDER  
HAIR  
PHILISTINES

PRISON  
RAZOR  
ROPES  
SAMSON  
SHAVED

SILVER  
STRENGTH  
THREAD  
YARN



# 66. SAMSON PULLS DOWN A TEMPLE

(JUDGES 16:22-31)

P X W E I J Y M V X W I B O P  
E P Z F O Q Y A O P Y X D F G  
R E K J T R O Z J J P G R S K  
F S K T A I N O S I R P C R B  
O G E C I F I R C A S Y G A U  
R D Q E N L F S J F Z P R L K  
M E J J R S V H E H E Y G L C  
N P B Z P T L M A G W L N I U  
M S E N I T S I L I H P L P M  
G Z B Z I N O S M A S N G L D  
F C E L P M E T W E B E Z L L  
H C R K Q F S M L U M V J M Y  
S T R E N G T H E N W A P S A  
A Q B C D A V S Z W U H N Z R  
W I K T N O G A D D F S U F P

DAGON

PILLARS

SAMSON

FELL

PRAY

SHAVEN

PERFORM

PRISON

STRENGTHEN

PHILISTINES

SACRIFICE

TEMPLE



# 66. SAMSON PULLS DOWN A TEMPLE

## (JUDGES 16:22-31)

### MEMORY VERSE:

*"Then Samson called to the LORD, saying, 'O Lord GOD, remember me, I pray!*  
**JUDGES 16:28**

### TRUE OR FALSE:

1. Now the hair of Samson's head "began to grow again after it had been shaven." **JUDGES 16:22**  
**TRUE OR FALSE**
2. "Now the lords of the Philistines gathered together to offer a great sacrifice to Dagon their god, and to rejoice." **JUDGES 16:23**  
**TRUE OR FALSE**

### CIRCLE THE CORRECT WORDS:

3. "So it happened, when their hearts were merry, that they said, 'Call for Samson, that he may perform for us.' So they called for Samson from the (**PALACE**, **PRISON**), and he performed for them." **JUDGES 16:25**
4. "They stationed him between two (**PILLARS**, **PEOPLE**)." **JUDGES 16:25**

### FILL IN THE BLANKS:

5. "Then Samson said to the lad who held him by the hand, 'Let me feel the pillars which support the \_\_\_\_\_, so that I can lean on them.'" **JUDGES 16:26**
6. "There were about \_\_\_\_\_ men and women on the roof who watched while Samson performed." **JUDGES 16:27**
7. "Then Samson called to the LORD, saying, 'O Lord GOD, remember me, I pray! \_\_\_\_\_ me, I pray, just this once, O God, that I might with one blow take vengeance on the Philistines for my two eyes!' " **JUDGES 16:28**

### TRUE OR FALSE:

8. "And Samson took hold of the two middle pillars which supported the temple, and he braced himself against them, one on his right and the other on his left." **JUDGES 16:29**  
**TRUE OR FALSE**
9. Samson "pushed with all his might, and the temple fell on the lords and all the people who were in it. So the dead that he killed at his death were more than he killed in his life." **JUDGES 16:30**  
**TRUE OR FALSE**

## 66. SAMSON PULLS DOWN A TEMPLE (JUDGES 16:22-31)

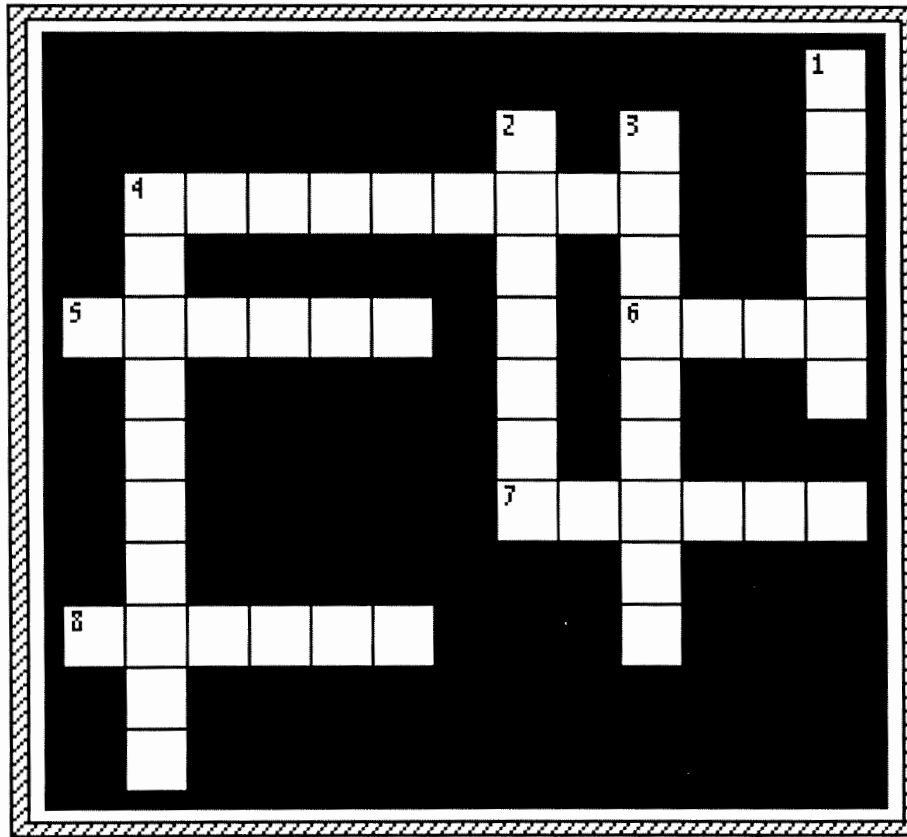

- 8 ACROSS Now the hair of Samson's head "began to grow again after it had been \_\_\_\_."  
**JUDGES 16:22**
- 4 ACROSS "Now the lords of the Philistines gathered together to offer a great \_\_\_\_ to Dagon their god, and to rejoice." **JUDGES 16:23**
- 5 ACROSS "They called for Samson from the \_\_\_\_, and he performed for them." **JUDGES 16:25**
- 2 DOWN "They stationed him between two \_\_\_\_." **JUDGES 16:25**
- 1 DOWN "Then Samson said to the lad who held him by the hand, 'Let me feel the pillars which support the \_\_\_\_, so that I can lean on them.'" **JUDGES 16:26**
- 3 DOWN "There were about three thousand men and women on the roof who watched while Samson \_\_\_\_." **JUDGES 16:27**
- 4 DOWN "Then Samson called to the LORD, saying, 'O Lord GOD, remember me, I pray! \_\_\_\_ me, I pray, just this once, O God, that I might with one blow take vengeance on the Philistines for my two eyes!' " **JUDGES 16:28**
- 7 ACROSS "And \_\_\_\_ took hold of the two middle pillars which supported the temple, and he braced himself against them, one on his right and the other on his left." **JUDGES 16:29**
- 6 ACROSS Samson "pushed with all his might, and the temple \_\_\_\_ on the lords and all the people who were in it. So the dead that he killed at his death were more than he killed in his life." **JUDGES 16:30**

**Puzzle Seven**

**JUDGES 16:25-31**

S B D L Q P E O U A S P Q L W Z  
 L L F N A M I H T E S Y E H T J  
 E L P O E P A M N H D T P J A D  
 W N G J G H E I R E M E M B E R  
 W L H E A R T S B E N I W N X O  
 H P Y L R S I G D M Y T W O V L  
 E S I Y I X L I N O S M A S B E  
 R F U L M S E Q N E Q C H I Q H  
 E L I F L R H H O B R B O R N T  
 U H O H F A T S P O R T U P L A  
 P C T R T E R R U C D D S F N K  
 O A D H D A R S N E A I E D A N  
 N M J N T S E M A L H L T L H T  
 P E A M A I A D E L M H L L V A  
 C T M M B H W H L D E G N E V A  
 S O C J I N T A B Y T O V F D L

WHEREUPON  
 the HOUSE  
 STANDETH, that  
 I may  
 LEAN UPON  
 them  
 and Samson  
 CALLED unto  
 THE LORD, and  
 said, O Lord God,  
 REMEMBER me, I  
 pray thee,  
 and  
 STRENGTHEN  
 me,  
 that I may be at  
 once AVENGED  
 of  
 the PHILISTINES  
 for MY TWO eyes.  
 And Samson said,  
 LET ME DIE  
 WITH THE  
 Philistines.  
 And he BOWED  
 himself  
 with ALL HIS  
 might;  
 and the house  
 FELL upon  
 the LORDS, and  
 upon all  
 the PEOPLE that  
 were therein.  
 So the DEAD  
 which he  
 SLEW at his  
 DEATH were  
 more than  
 they which he  
 slew in his LIFE.

It CAME TO pass  
 when their  
 HEARTS  
 were MERRY, that  
 they said,  
 call for SAMSON,  
 that he may make  
 us SPORT.  
 AND THEY called  
 for Samson  
 out of the PRISON

house  
 and THEY SET  
 HIM between  
 the PILLARS.  
 And Samson said  
 unto THE LAD  
 that held him by  
 the HAND,  
 SUFFER ME that I  
 may feel the  
 pillars

# Samson's Big Mistake

Judges 13 — 16

God gave Samson his great strength. Samson's parents promised to never cut his hair. When Samson's hair was cut, he lost his strength. Samson became friends with people who were enemies of God. They paid Delilah to find out why Samson was so strong. Because Samson loved Delilah, he told her. His enemies cut off his hair and made him blind. When Samson's hair grew back, he pushed down the pillars of a building filled with enemies. Samson and thousands of his enemies died.

The hidden words are from this story in Judges 16:4-21. The code following each word tells the coordinates where one of the letters of the word is found in the puzzle. After you have found all the hidden words, start at the upper left and use all the leftover letters to fill in the blanks at the bottom of the page with a Bible verse which tells what can happen when we become friends with evil people.

	A	B	C	D	E	F	G	H	I	J	K	L	M	N		
AFFLICT (2F)	1	B	K	E	R	O	S	F	O	Y	E	L	L	A	V	1
BEAM (10L)	2	E	A	F	F	L	I	C	T	N	L	S	O	T	S	2
BRASS (9D)	3	D	D	E	E	A	C	E	A	I	V	I	E	H	T	3
CAUSED (3H)	4	D	E	E	E	V	S	I	L	U	C	L	A	H	R	4
DAILY (5M)	5	O	P	M	L	M	U	T	S	N	S	V	R	D	E	5
DELILAH (12A)	6	I	A	O	W	W	C	S	E	Y	E	E	G	A	N	6
DEPARTED (6B)	7	T	R	I	O	O	A	N	C	N	A	R	D	S	G	7
DRIED (14N)	8	D	T	C	O	R	M	R	I	D	E	R	U	P	T	8
ENTICE (8H)	9	E	E	M	B	D	T	A	T	E	G	D	O	O	H	9
EYES (6I)	10	L	D	I	D	S	E	E	N	K	M	F	B	A	N	10
FASTENED (5G)	11	I	N	G	P	E	R	W	E	C	S	E	I	C	O	11
FETTERS (11K)	12	L	R	H	I	U	I	N	T	O	A	T	H	I	A	12
FIRE (13M)	13	A	N	T	S	T	C	F	I	M	F	T	T	F	E	13
GREEN WITHS (12F)	14	H	E	E	H	N	T	C	H	I	D	E	I	R	D	14
KNEES (10F)	15	R	E	S	U	O	H	N	O	S	I	R	P	T	Y	15
	16	T	H	T	N	E	W	R	O	P	E	S	R	E	E	16
	A	B	C	D	E	F	G	H	I	J	K	L	M	N		

- LORD (6C)
- MIGHTEST (16C)
- MOCKED (9I)
- NEW ROPES (16D)
- OCCUPIED (14G)
- PRISON HOUSE (15J)
- SHAVEN (7I)
- SILVER (2K)
- SLEEP (4C)
- STRENGTH (5N)
- THREAD (8I)
- VALLEY OF SOREK (1B)
- WOMAN (9G)
- WORDS (6E)

HIDDEN VERSE: \_\_\_\_\_ : \_\_\_\_\_  
 \_\_\_\_\_  
 \_\_\_\_\_  
 \_\_\_\_\_ : \_\_\_\_\_

## **Year 2**

### **Week 62**

#### **Ruth**

#### **Scriptures: Ruth 1 & 2**

**Key Verse: Ruth 1:16 But Ruth said “Entreat me not to leave you, or to turn back from following after you; For wherever you go , I will go and wherever you lodge, I will lodge, Your people shall be my people, And your God, my God.”**

#### **Key Points:**

- 1.** Elimelech and Naomi were from Bethlehem, Judah. A famine in the land caused them to travel to Moab with their two sons, Mahlon and Chilion. Elimelech died leaving Naomi alone with her two sons. They took wives from Moab, Orpah and Ruth. After about 10 years the sons died as well.
- 2.** Naomi decided to return to her homeland of Judah. She begged Ruth and Orpah to stay in Moab and return to their families, telling them she had no more sons for them to marry. Orpah did go back but Ruth refused, wanting to stay with Naomi. They returned to Bethlehem.
- 3.** Naomi had a relative of her husband, Boaz. He was very wealthy. Ruth was able to glean grain from his fields after the reapers had gone through. This supplied food and money for Naomi and Ruth to live on.
- 4.** Boaz noticed Ruth and asked who she was. He told her she could glean in his field only, and his servants could keep an eye on her. Boaz instructed his men to leave grain behind so that Ruth could glean more grain. Ruth asked him why he was so kind, he told her he heard how well she had treated her mother-in-law, how she left her family to care for her.
- 5.** Naomi was surprised Ruth gathered so much grain and that she was working in the field of one of her husband’s kinsman. God had been with them and blessed them.

# RUTH CHOOSES TO STAY WITH NAOMI

(RUTH 1:1-18)



"Ruth said: 'Entreat me not to leave you, or turn back from following after you; for wherever you go, I will go; and wherever you lodge, I will lodge; your people shall be my people, and your God, my God.' "

**RUTH 1:16**



Entreat me not to leave you, or to turn back from following after you; for wherever you go, I will go; and wherever you lodge, I will lodge; your people shall be my people, and your God will be my God.

*Ruth 1:16*







So she kept fast by the maidens of Boaz to glean unto the end of barley harvest and of wheat harvest; and dwelt with her mother in law.

*Ruth 2:23*

# RUTH GLEANS IN THE FIELD

(RUTH 2)



"And Ruth the Moabitess said unto Naomi, Let me now go to the field, and glean ears of corn after *him* in whose sight I shall find grace. And she said unto her, Go, my daughter."

**RUTH 2:2**

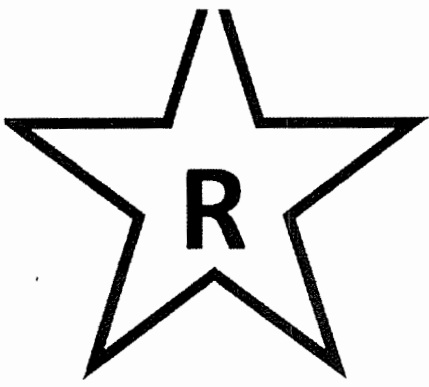

is for

Ruth



**Book of  
Ruth**



www.supercoloring.com



Ruth gleaned in the fields and won the heart of Boaz. Her son was the grandfather of King David.



# Make a Ruth Basket

Copy and cut out basket. Glue together and add pieces of wheat or color sheaves and paste.

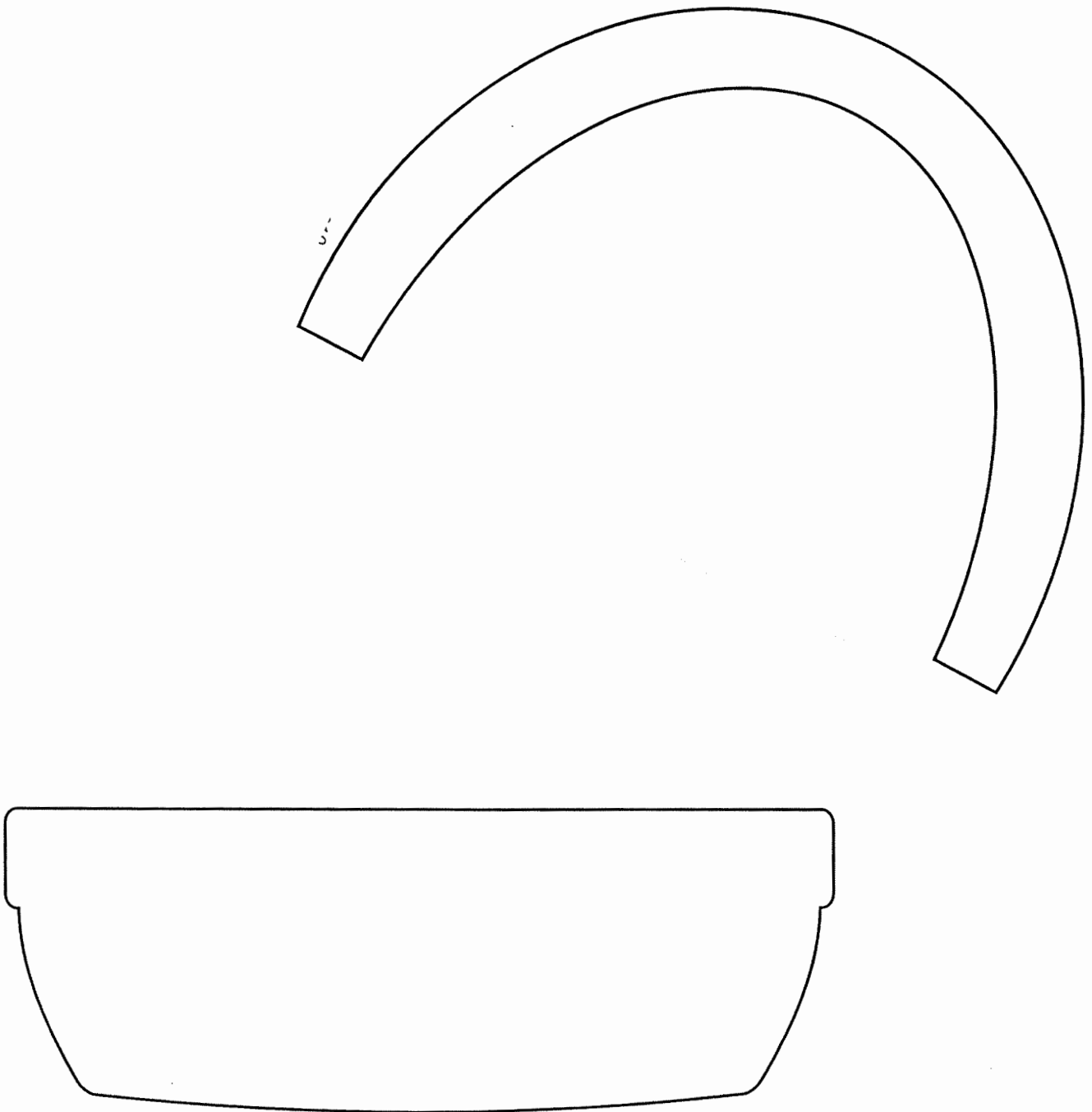

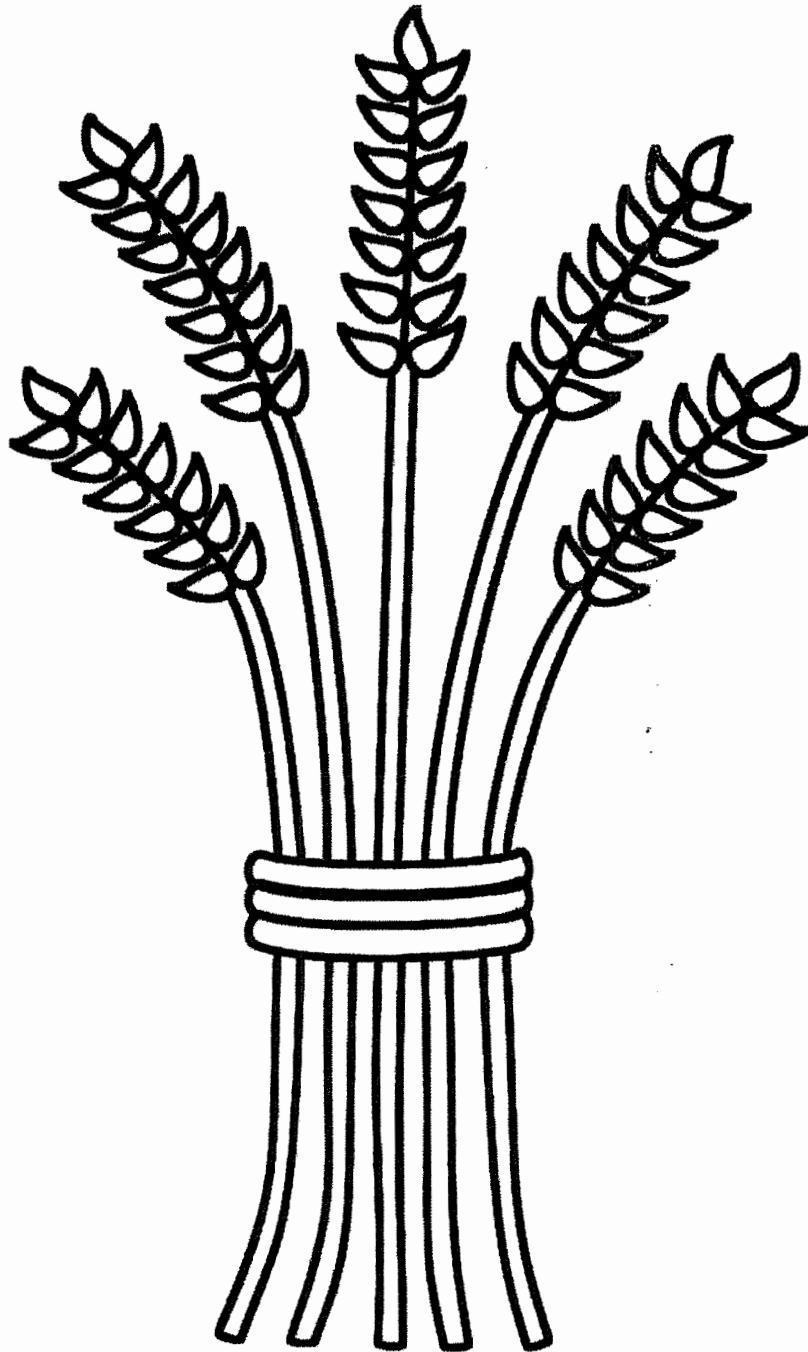



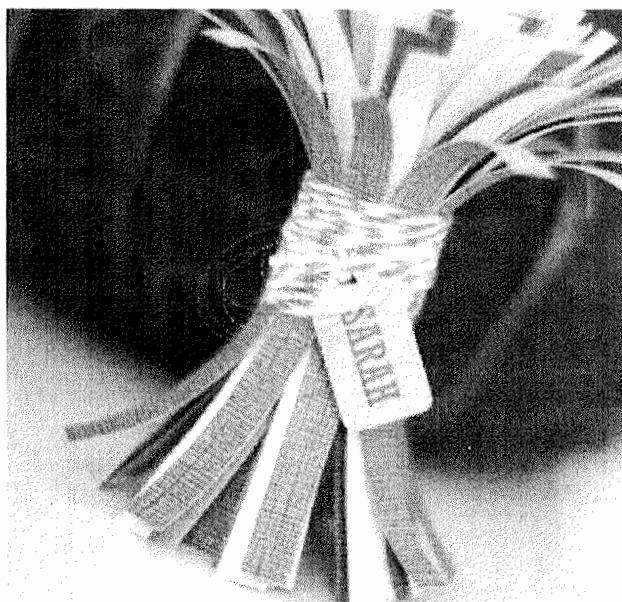
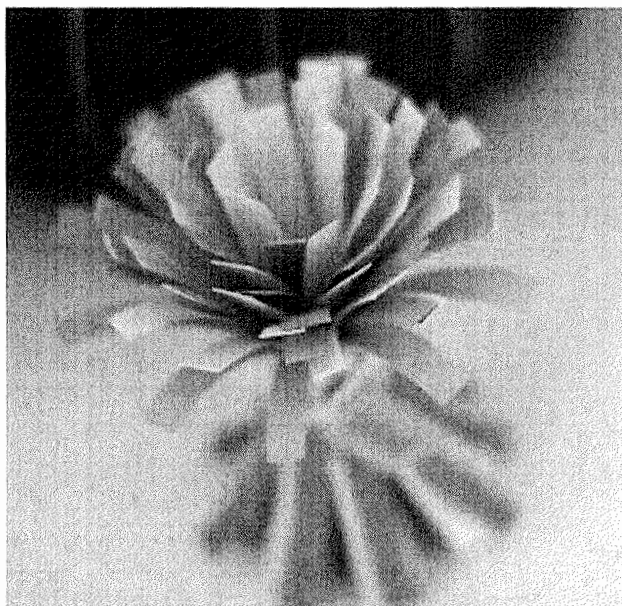
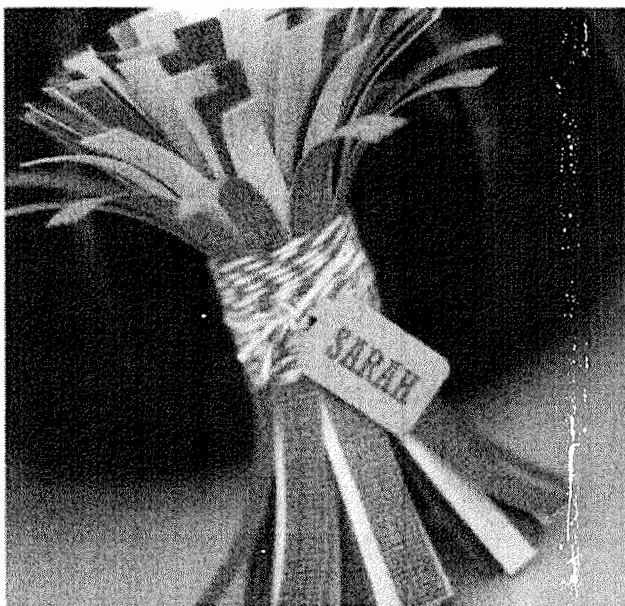

We printed names on card stock (*but you could also easily use alphabet stamps*), then used a **mini gift tag paper punch** to punch out the names.

Be sure to fan out the hay bundles to create a fun, finished look!

**Recipe for creating these Hay Bundle Place Cards:**

2 sheets of Card Stock (*each measure 4.5" x 12"*) - *wheat colors*

Adhesive (*double sided tape or adhesive runner works best*)

Baker's Twine – *we used our twine in Lemondrop, Cappuccino & Mandarin*

Mini Gift Tags

Scissors

Bone Folder (*used to create the score lines*)

*+ p. rolls – put them in the middle to hold the circle –*

We hope you enjoyed this fun, holiday-esque idea for Fall!

# Naomi's Loyal Friend

**PARENTS:** Help your children learn about Ruth and Naomi. As you read the Illustrated Bible Story "Ruth Is a Loyal Friend," hold up (or have your child hold up) the correct puppet to show which character is speaking. Emphasize how Ruth remained loyal to Naomi.

**Color the Bible character puppets.**



**RUTH**



**NAOMI**

**Cut out the puppets along the dotted line. Attach the puppet to a pencil or a pen.**

Your finished puppets will look like this!

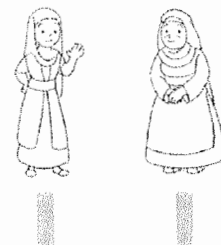

Orpah



Naomi

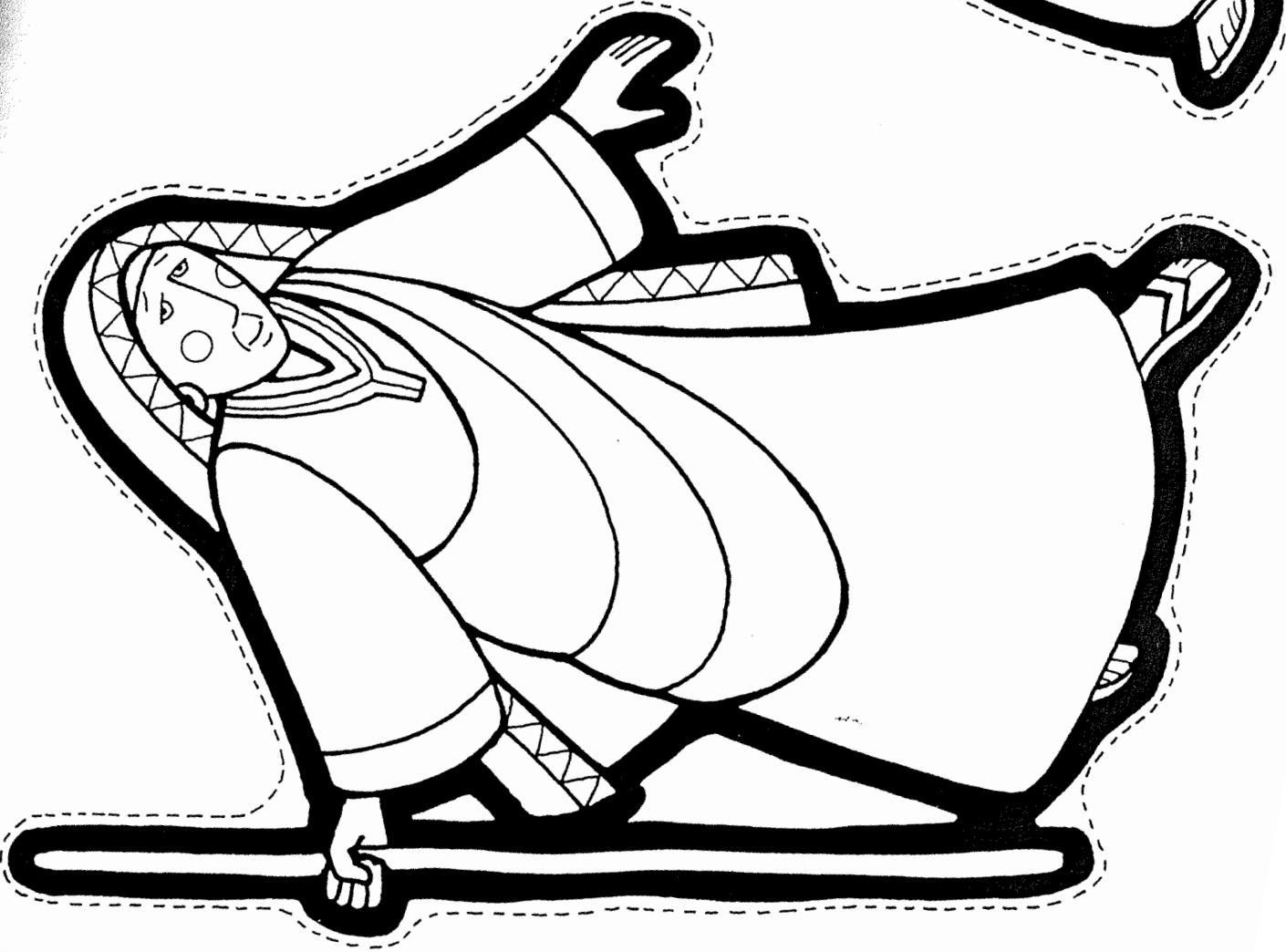

## Ruth Story Puppets

### Supplies

- copies of the Ruth Story Puppets (1 per child)
- crayons or washable markers
- scissors
- craft sticks (4 per child)
- glue

### Directions

Help children color and cut out the puppets along the solid lines. Attach each puppet to a craft stick. Use the puppets to retell the story of Ruth:

- 1) Orpah left Naomi but Ruth stayed.
- 2) Ruth went to the fields to gather grain, and there she met Boaz.
- 3) Ruth brought back grain for herself and Naomi.

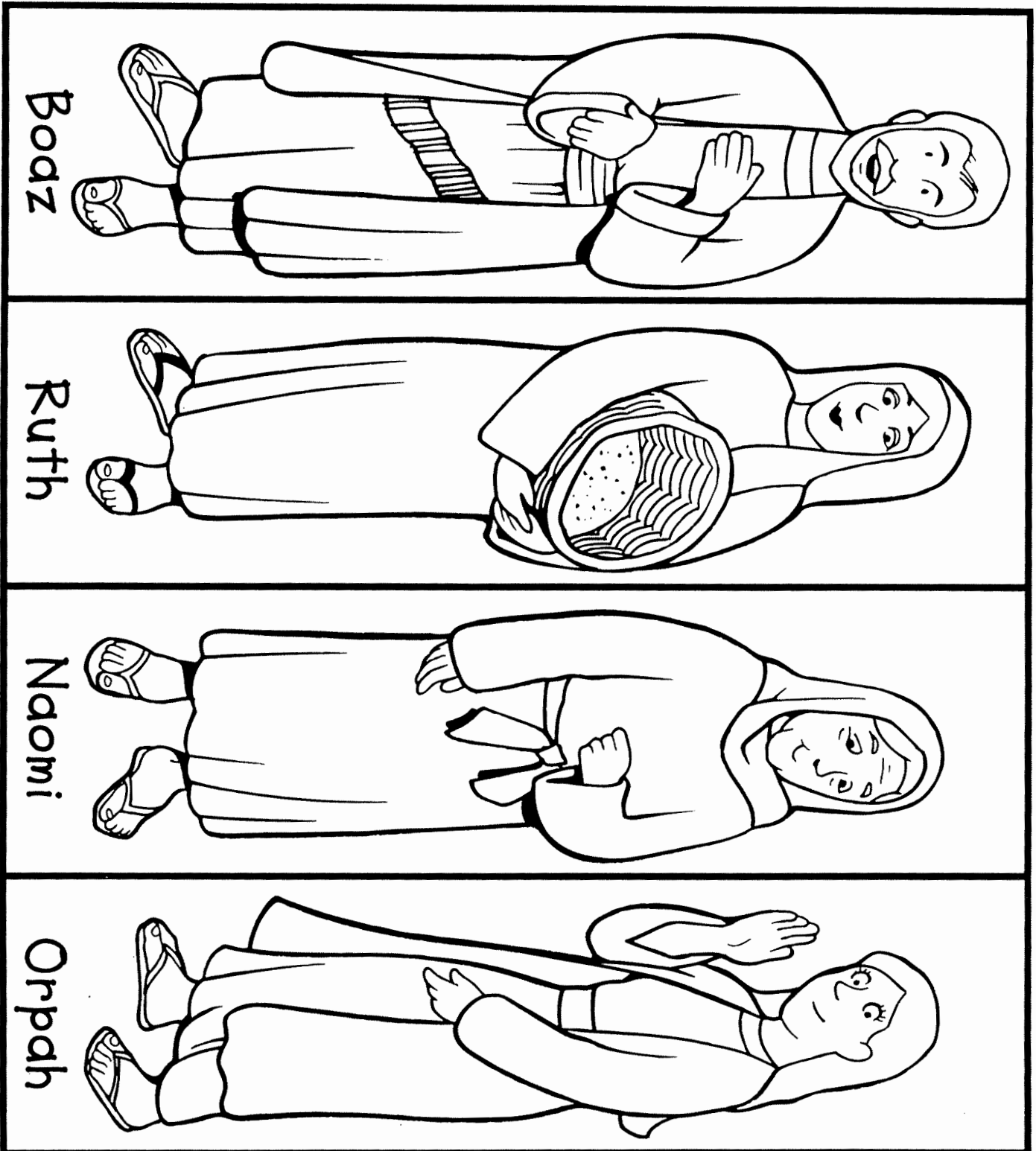

# Bible for Children

presents



## RUTH: A LOVE STORY



Written by: Edward Hughes

Illustrated by: Janie Forest

Adapted by: Lyn Doerksen

Story 16 of 60

[www.M1914.org](http://www.M1914.org)

*Bible for Children, PO Box 3, Winnipeg, MB R3C 2G1 Canada*

License: You have the right to copy or print this story, as long as you do not sell it.

English

If you could meet your great-grandparents, their parents, and all the people who came before you in your family, you might be surprised by what kind of people they were. In the Bible, one of Jesus' human ancestors was Ruth - a Moabite lady who used to worship idols.

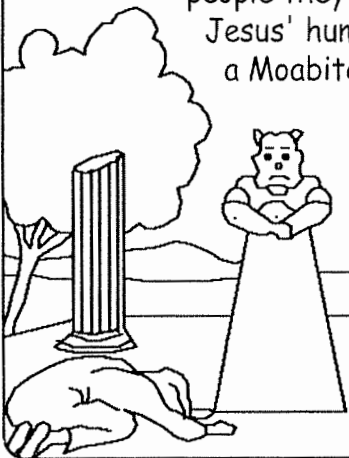

1

The story of Ruth starts in Israel after the time of Samson, when God's people stopped trusting and obeying God. A terrible famine struck the land. Do you know what a famine is? That's right! A famine is when no fruit or crops grow, and animals and sometimes even people die from hunger.



2

One man, Elimelech, left Bethlehem with his wife and two sons, looking for food. He went to Moab, a country where people worshipped idols.



3

Things did not go well for Elimelech and his family in Moab. He died, followed by his two sons.

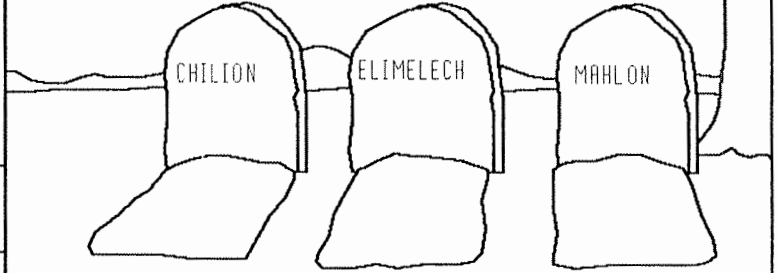

His wife, Naomi, was left, along with the sons' two wives, Ruth and Orpah. Both girls were from Moab.

4

Naomi, now a widow, heard that the LORD had visited His people, giving them bread. She decided to return to her homeland. But what would the two girls do? Naomi advised them to stay in Moab and marry again.

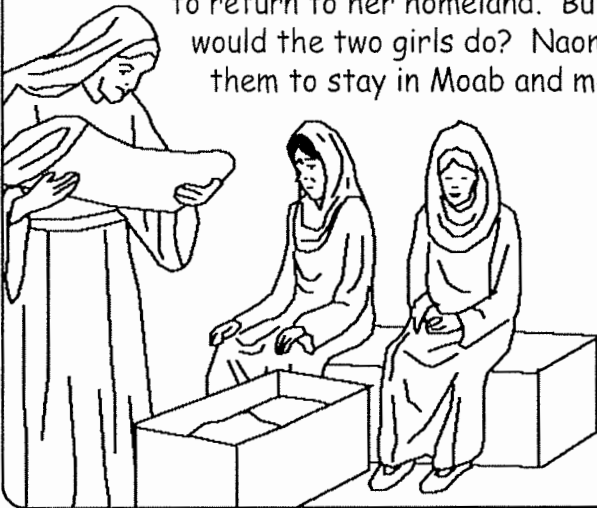

5

Orpah went back to her own family. But Ruth refused. Instead, Ruth said a lovely poem which promised she would never leave her mother-in-law.



6

Naomi's old friends were glad that she had come home to Bethlehem. But she asked them to call her "Marah" (bitter) instead of Naomi (pleasant). "For the Almighty has dealt very bitterly with me." Naomi had returned with nothing - except Ruth.



7

Although Ruth had worshipped idols like most people in Moab, she had turned from that to worship the Living God of Israel. Ruth worked hard to make sure Naomi had enough to eat. Every day she followed the harvesters in the field and picked up the left-over grain.

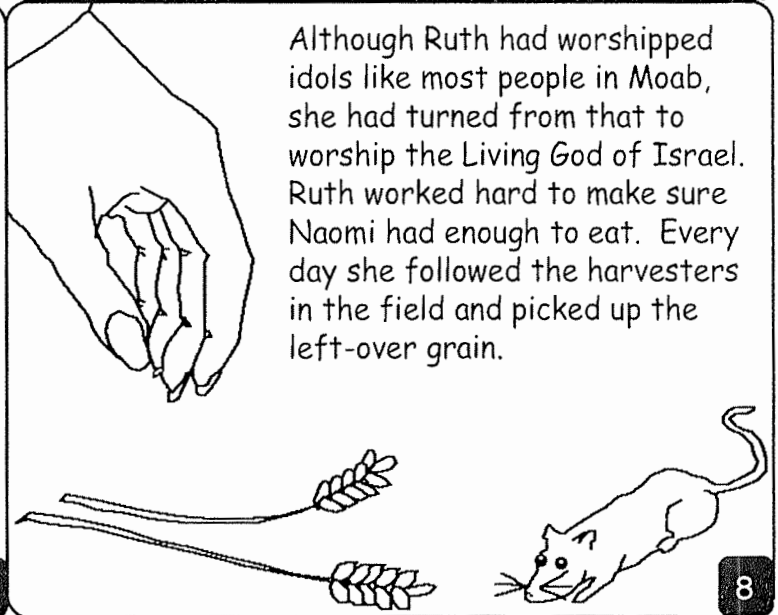

8

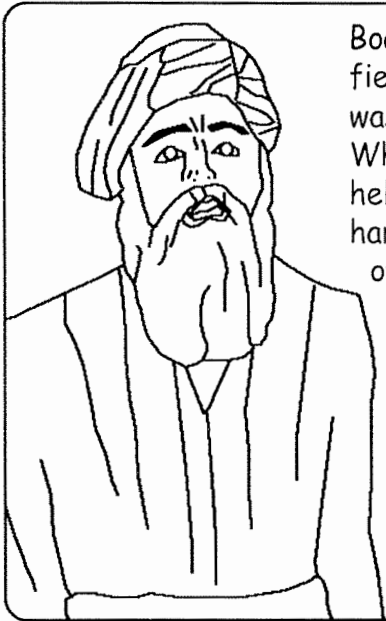

Boaz, the owner of the field, heard how good Ruth was to her mother-in-law. When he met her, Boaz helped her by ordering his harvesters to leave handfuls of grain behind on purpose. Boaz began to like Ruth.

9

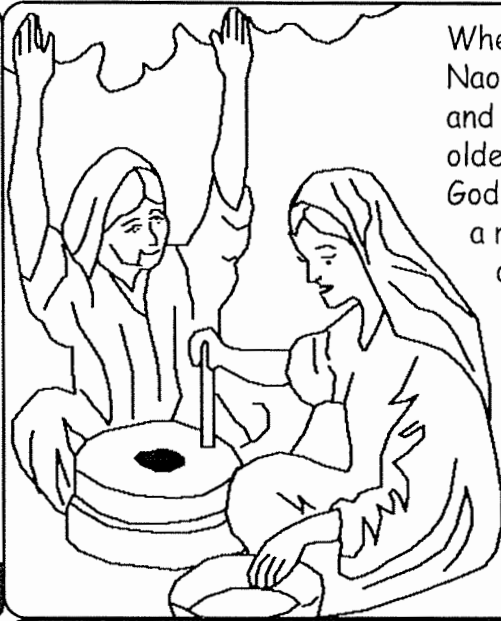

When Ruth told Naomi about Boaz and his kindness, the older lady praised God. "The man is a relative of ours, one of our near kinsmen."

10



As time passed, Boaz wanted to marry Ruth and look after Naomi and her family's land. But another near relative had the first chance. This man wanted the land - but he didn't want Ruth for his wife. The law said he could not have one without the other.



11

In those days, people didn't shake hands to settle a deal. Boaz took off a sandal and publicly gave it to the other man.

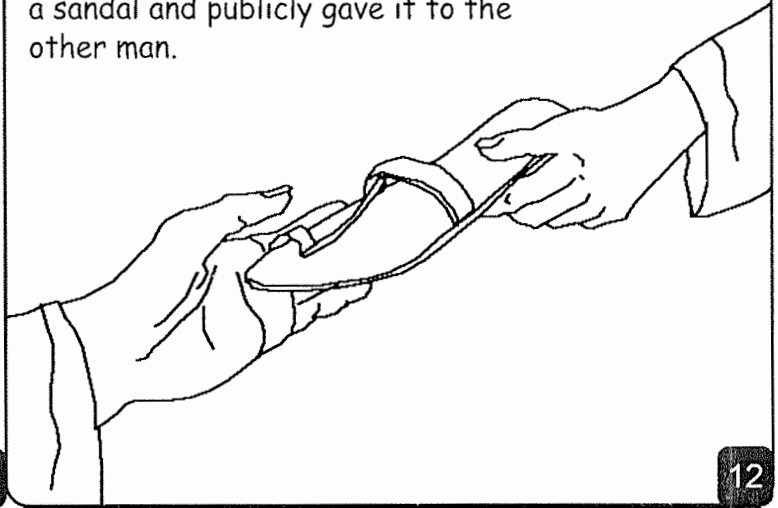

12

The business was settled. Ruth would become his wife. Now she and Naomi were part of Boaz' family.

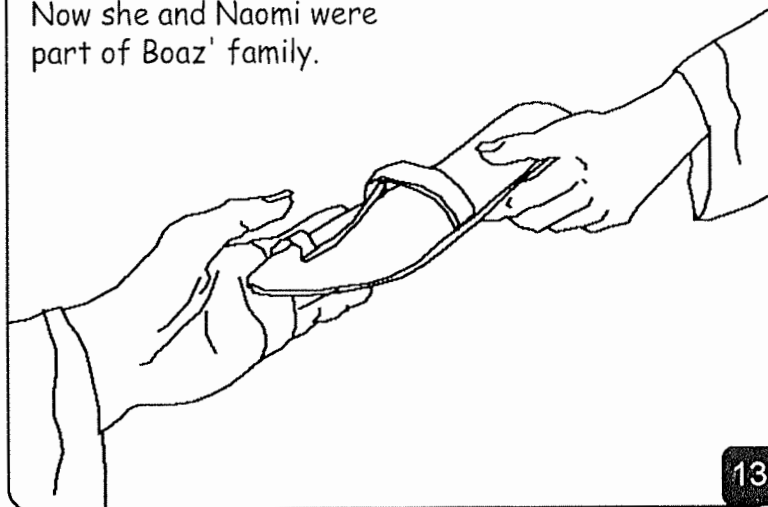

13



Boaz and Ruth called their first son Obed. He became grandfather to David, the great King of Israel.

14



But even more wonderfully, baby Obed was ancestor to the Lord Jesus Christ. Jesus came through David's family line to be King of kings and the Savior of the world.

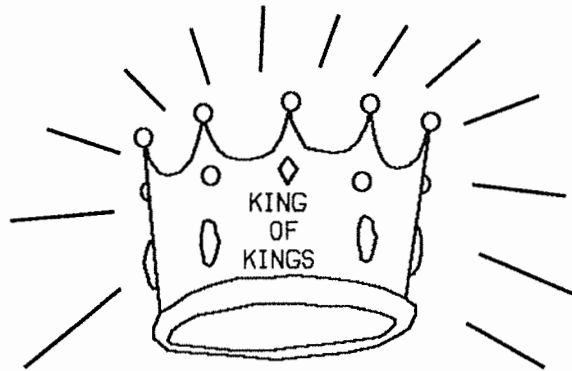

15

Ruth: A Love Story

A story from God's Word, the Bible,

is found in

The Book of Ruth

"The entrance of Your Words gives light."  
Psalm 119:130





# Help Ruth Glean

All the fields were gleaned by the farmers in the center of the field. The utmost corners were for the poor to gather some food. Help Ruth glean!

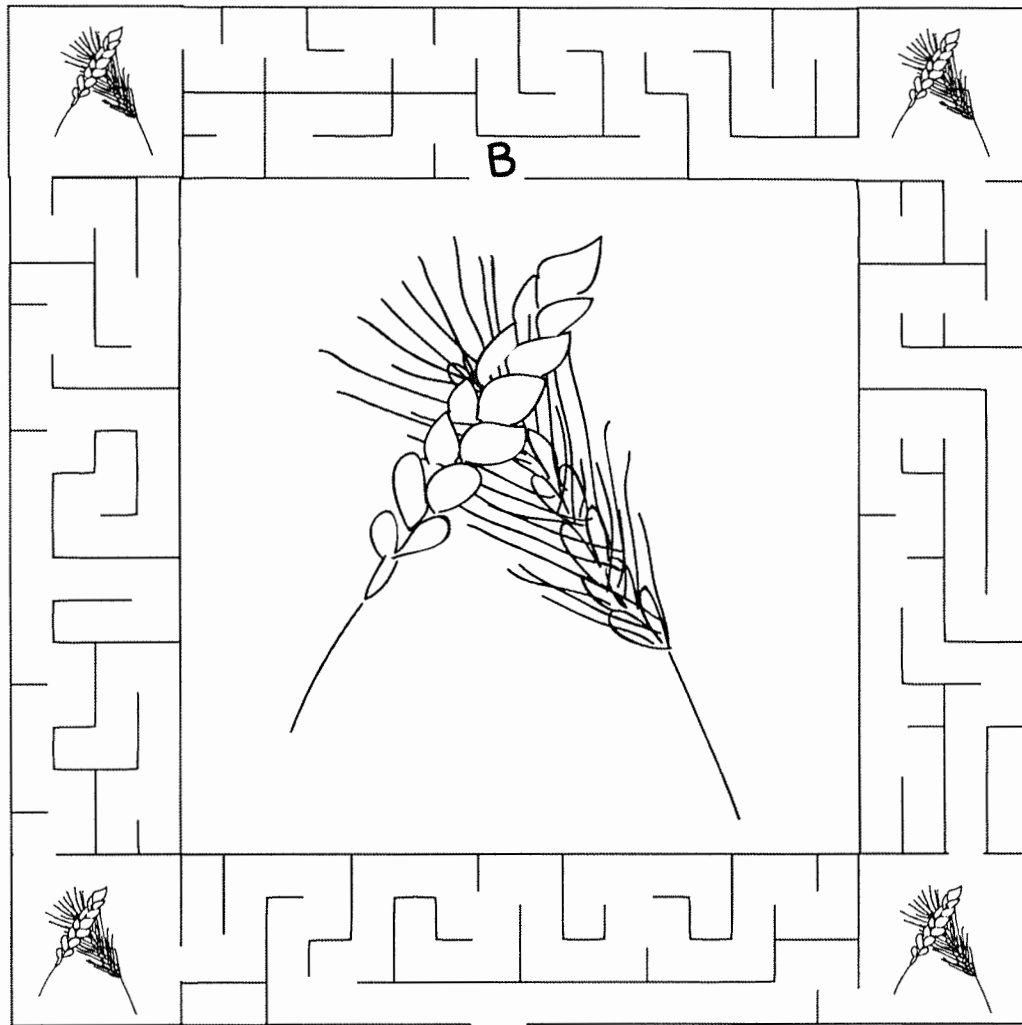

START

First trace the path of the poor and Ruth. But when Ruth meets Boaz (B) her direction changes. Use a BLUE crayon to mark the path of the poor where they can gather their food, and use a RED crayon to follow Ruth to finding food for Naomi and herself.

Copyright © 2013, BibleWise. All Rights Reserved. Drawing by Kathryn Wojno .



# Ruth & Naomi Word Search

R E H T O M U P

R U T H A U V O

T R O P P U S R

F A M I L Y W D

DROP  
FAMILY  
MOTHER  
RUTH  
SUPPORT



## Ruth 1:16-17

Fill in the blanks using the New King James Version of the Bible.

“ Entreat me not to \_\_\_\_\_ you,  
Or to turn back from \_\_\_\_\_ after  
you;  
For wherever you \_\_\_\_\_, I will  
\_\_\_\_\_;  
And wherever you \_\_\_\_\_, I will  
\_\_\_\_\_;  
Your \_\_\_\_\_ *shall be* my  
\_\_\_\_\_,  
And your \_\_\_\_\_, my \_\_\_\_\_.  
Where you die, I will \_\_\_\_\_,  
And there will I be \_\_\_\_\_.  
The \_\_\_\_\_ do so to me, and more  
also,  
If *anything but* \_\_\_\_\_ parts you and  
me.”

"Scripture taken from the New King James Version. Copyright © 1982 by Thomas Nelson,

Inc. Used by permission. All rights reserved."

# RUTH GLEANS IN THE FIELD

(RUTH 2)

K R K Z H F H F H U U N O V Y  
I C O Y I J Q S Q H O Q K D R  
N M I E Z C O W O P E L Q D O  
S L L Y Y V S E V A E H S E V  
M D T S E V R A H E P K K N A  
A B T O N T A U E W T D L A F  
N X E J J W B O A Z H D W E D  
C A J F T H W D W V C E K L J  
U W A L N I R E H T O M A G I  
M C K A P I M O A N S Y I T P  
D W D R A W E R E A C E J Q E  
L R U T H P V S B R H L S E P  
R E L A T I V E K L U R U N H  
S J K H L J M J S W E A E R A  
V U P A N E M O W J C B A Y H

BARLEY  
BOAZ  
EPHAH  
FAVOR

FIELD  
GLEANED  
HARVEST  
KINSMAN

MOTHER-IN-LAW  
NAOMI  
RELATIVE  
REWARD

RUTH  
SHEAVES  
WHEAT  
WOMEN



# Ruth and Naomi Crossword

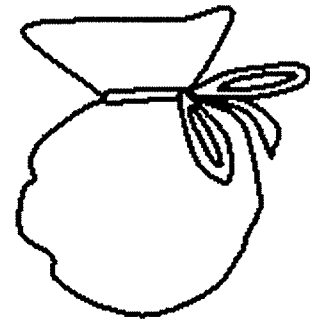
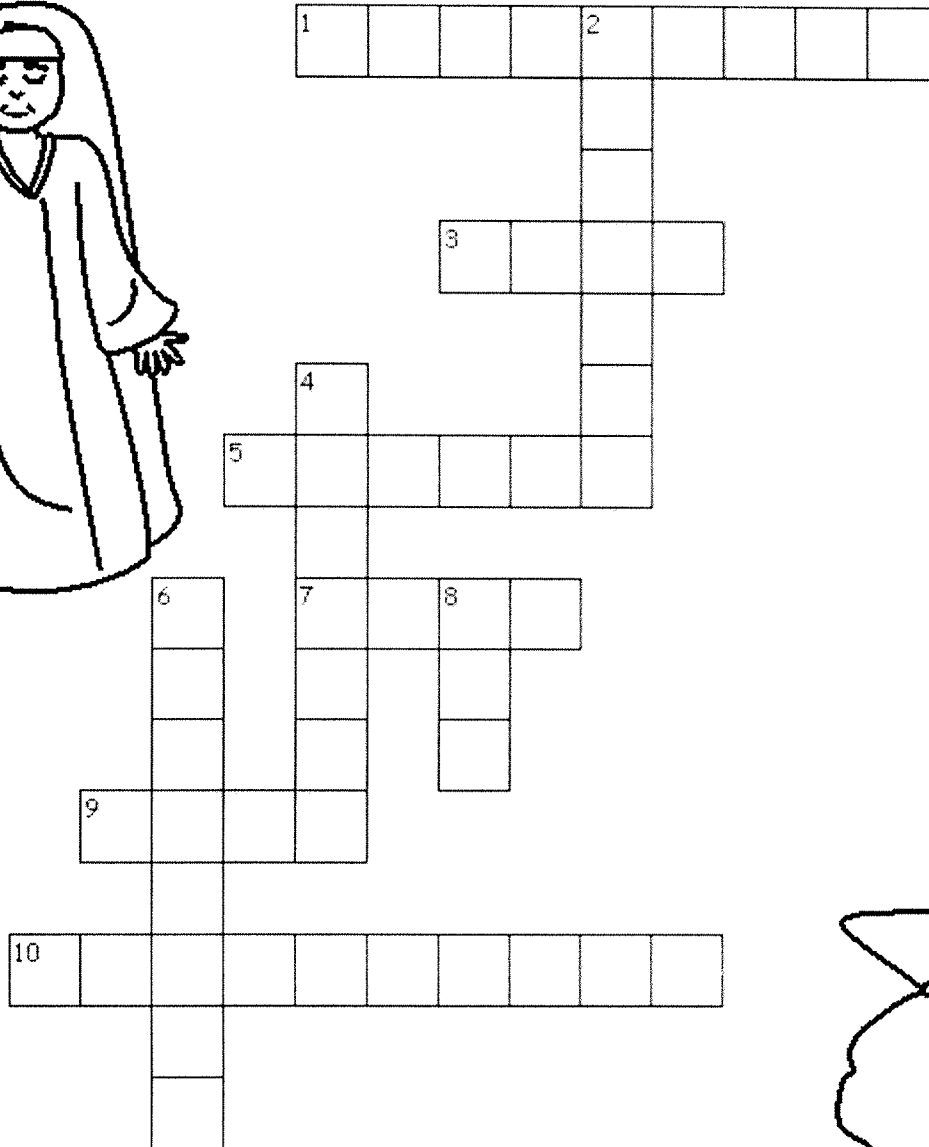
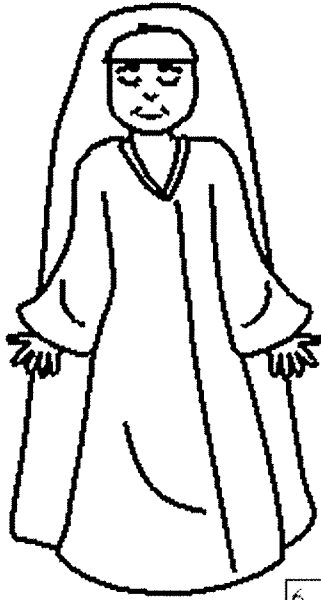

## Across

1. This is the place that Naomi wanted to move back to.
3. The name of the kind man that owned the field where Ruth worked.
5. The type of grain that Ruth would pick up after the harvesters.
7. This was the name of Naomi's daughter-in-law who stayed with her.
9. All of Ruth's immediate family \_\_\_\_ so she decided to move back to her hometown.
10. Ruth and Naomi's story is a story about \_\_\_\_.

## Down

2. This is the act of putting someone's interests before your own.
4. Boaz and Ruth later fell in love and were \_\_\_\_.
6. Naomi encouraged Ruth and Orpah to move back to their own \_\_\_\_.
8. The number of sons Naomi had.

## Bible Puzzle

# Ruth's Family Word Find

RUTH lived in MOAB with her mother-in-law NAOMI and her sister-in-law ORPAH.

Their husbands, ELIMELECH, MAHLON and CHILION had died, and Naomi, Orpah, and Ruth were all alone and SAD.

Naomi went back to live in her hometown, BETHLEHEM, and Ruth decided to go with her. Ruth gathered GRAIN for them to eat. BOAZ saw Ruth working in his FIELD.

Boaz married Ruth, and they had a son named OBED. Now Naomi was HAPPY. Obed later had a son, JESSE, who was the father of King DAVID.

Find all the words in the puzzle.

G	B	E	T	H	L	E	H	E	M	F
R	P	L	D	F	I	D	A	S	A	I
A	E	I	G	A	H	M	Y	M	H	E
I	N	M	H	D	V	P	O	O	L	L
N	J	E	X	A	P	I	S	A	O	D
Z	E	L	L	A	P	O	D	B	N	E
A	S	E	H	C	U	R	A	B	R	B
O	S	C	H	I	L	I	O	N	T	O
B	E	H	T	U	R	H	A	P	P	Y

Ruth helped Naomi by gathering grain. How do you help your family?

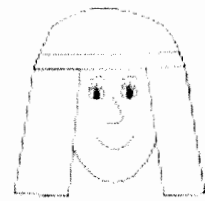
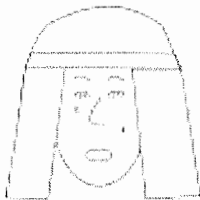

Name: \_\_\_\_\_

Date: \_\_\_\_\_

## Ruth and Naomi

---

Naomi was the wife of a Jew named \_\_\_\_\_, who left his own city of Bethlehem to go into the land of \_\_\_\_\_, because there was a famine in Canaan. Some time afterwards he died, leaving Naomi a \_\_\_\_\_ with two sons, all dwellers in a strange land. Her sons married two young women belonging to Moab, whose names were \_\_\_\_\_ and Ruth.

After living there about ten years Naomi's sons died also, leaving Orpah and \_\_\_\_\_ widows, along with their widowed mother-in-law. Then Naomi determined to return to her own land. Orpah and Ruth accompanied Naomi some distance on her \_\_\_\_\_; then she bade them to leave her, telling each to go back to her mother's house in Moab, while she would pursue her way alone to the land of \_\_\_\_\_. They were unwilling to do so, saying they would go with her to her land and people; but she urged them to depart, assuring them that they would gain nothing by leaving their own country to accompany her, and that they had better return to their own \_\_\_\_\_. So Orpah kissed her mother-in-law and \_\_\_\_\_; but Ruth clung to her, saying, "Where you go, I will go; ... your \_\_\_\_\_ shall be my people, and your God shall be my \_\_\_\_\_."

So Ruth journeyed with Naomi until they reached Canaan. Then they both dwelt in the city of \_\_\_\_\_, in the land of Judah.

1. Bethlehem  
2. departed  
3. Elimelech

4. God  
5. homes  
6. journey

7. Judah  
8. Moab  
9. Orpah

10. people  
11. Ruth  
12. widow

# RUTH CHOOSES TO STAY WITH NAOMI

(RUTH 1:1-18)

A N R U T E R M V H W G D U B  
W P Q J T I S S O M B H T U R  
B Z J B A O M V J E A Y R O U  
P D I E D Q T M J G N H C F B  
E C R E V E R E H W M I L L W  
S C B T I D F A E E O P M O U  
N Q B E O J A Z A U R Y G A N  
A I R J T Q Y S W S P B R L F  
O M E H E L H T E B A N G M M  
M W B Z A R Y V L W H O N S D  
I Z K Z N I I H Z D W I G Z L  
G K E K R W O M X W U L Z F S  
E L I M E L E C H Y F I J P V  
D K F C P L F L P P I H P G R  
E D A E R B V S J Z X C N K C

BETHLEHEM  
BREAD  
CHILION  
DIED  
ELIMELECH

FAMINE  
MAHLON  
MOAB  
NAOMI  
ORPAH

RETURN  
RUTH  
WHEREVER  
WIVES

WRITE DOWN THE LETTERS AS YOU COME TO THEM ON THE LINES BELOW

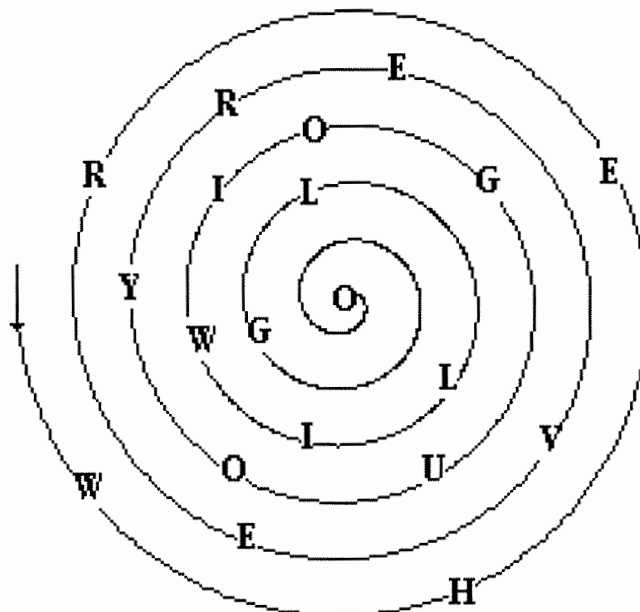

-----



# RUTH CHOOSES TO STAY WITH NAOMI

## (RUTH 1:1-18)

### MEMORY VERSE:

*"Ruth said: 'Entreat me not to leave you, or turn back from following after you; for wherever you go, I will go; and wherever you lodge, I will lodge; your people shall be my people, and your God, my God.' "* RUTH 1:16

### TRUE OR FALSE:

1. "A certain man of Bethlehem, Judah, went to sojourn in the country of Moab, he and his wife and his two sons." RUTH 1:1

TRUE OR FALSE

2. "Then Elimelech, Naomi's husband died; and she was left, and her two sons." RUTH 1:3

TRUE OR FALSE

### CIRCLE THE CORRECT WORDS:

3. "Now they took wives of the women of Moab: the name of the one was Orpah, and the name of the other Ruth. And they dwelt there about ( **TWO, TEN** ) years." RUTH 1:4

4. "Then both Mahlon and Chilion also ( **DIED, LIVED** ); so the woman survived her two sons and her husband." RUTH 1:5

5. "Then she arose with her daughters-in-law that she might return from the country of Moab, for she had heard in the country of Moab that the LORD had visited His people in giving them ( **BREAD, BEARDS** )." RUTH 1:6

### TRUE OR FALSE:

6. Naomi said, "Come with me my daughters, for it is good that you will go with me." RUTH 1:11

TRUE OR FALSE

7. "Ruth said: 'Entreat me not to leave you, or turn back from following after you; for wherever you go, I will go; and wherever you lodge, I will lodge; your people shall be my people, and your God, my God.' " RUTH 1:16

TRUE OR FALSE

Name: \_\_\_\_\_ Date: \_\_\_\_\_

# Ruth and Naomi

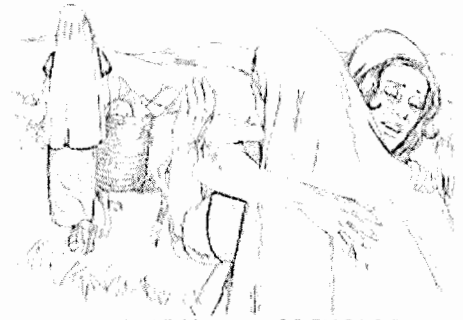

sweetpublishing.com (CC BY-SA 3.0)

d	e	p	a	r	t	e	d	n	u	z	r	q	k
k	y	c	i	w	n	g	w	w	i	r	x	r	q
n	w	u	g	x	a	d	j	i	g	e	k	s	p
t	d	b	e	j	o	v	l	u	d	a	i	y	e
b	l	p	e	k	m	z	x	m	d	o	x	w	o
z	r	o	s	t	i	h	u	n	o	a	w	v	p
x	y	u	g	v	h	k	c	a	u	a	h	f	l
a	g	o	d	v	c	l	h	z	z	s	b	l	e
z	k	q	y	o	x	q	e	s	r	u	t	h	f
z	o	r	p	a	h	y	v	h	e	c	o	z	l
j	o	u	r	n	e	y	o	t	e	z	a	i	s
t	y	d	a	p	h	o	m	e	s	m	x	g	q
a	x	m	o	t	h	e	r	i	n	l	a	w	s
i	e	l	i	m	e	l	e	c	h	m	m	m	o

- |              |              |            |                   |
|--------------|--------------|------------|-------------------|
| 1. Ruth      | 5. Elimelech | 9. Judah   | 13. widow         |
| 2. Naomi     | 6. God       | 10. Moab   | 14. mother-in-law |
| 3. Bethlehem | 7. homes     | 11. Orpah  |                   |
| 4. departed  | 8. journey   | 12. people |                   |

# RUTH GLEANS IN THE FIELD

## (RUTH 2)

### MEMORY VERSE:

*"The LORD repay your work, and a full reward be given you by the LORD God of Israel, under whose wings you have come for refuge." RUTH 2:12*

### FILL IN THE BLANKS:

1. Ruth "went and \_\_\_\_\_ in the field after the \_\_\_\_\_. And she happened to come to the part of the field belonging to Boaz, who was of the family of Elimelech." **RUTH 2:3**
2. "Boaz said to Ruth, 'You will listen, my daughter, will you not? Do not glean in another field, nor go from here, but stay \_\_\_\_\_ my young women.'" **RUTH 2:8**
3. Ruth "gleaned in the \_\_\_\_\_ until evening, and beat out what she had gleaned, and it was about an ephah of \_\_\_\_\_." **RUTH 2:17**

### UNDERLINE THE CORRECT ANSWER:

4. "And her mother-in-law said to her,..." **RUTH 2:19**
  - a. Where have you gleaned today?
  - b. And where did you work?
  - c. Blessed be the one who took notice of you.
  - d. All of the above

### TRUE OR FALSE:

5. "So she told her mother-in-law with whom she had worked, and said, 'The man's name with whom I worked today is Boaz.'" **RUTH 2:19**

**TRUE OR FALSE**

### FILL IN THE BLANK:

6. "Then Naomi said to her daughter-in-law, '\_\_\_\_\_ be he of the LORD, who has not forsaken His \_\_\_\_\_ to the living and the dead!' And Naomi said to her, 'The man is a relative of ours, one of our near kinsmen.'" **RUTH 2:20**
7. "So she stayed close by the young women of \_\_\_\_\_, to glean until the end of the barley harvest and wheat harvest; and she dwelt with her mother-in-law." **RUTH 2:23**

# RUTH GLEANS IN THE FIELD

## (RUTH 2)

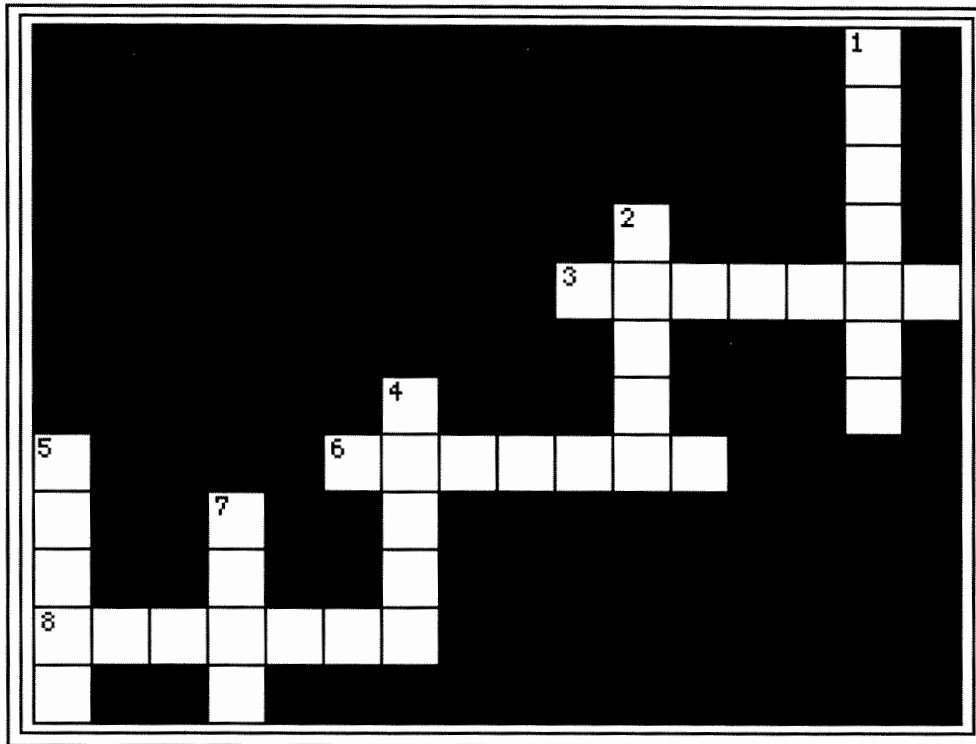

- 5 DOWN "The LORD repay your work, and a full reward be given you by the LORD God of Israel, under whose \_\_\_\_\_ you have come for refuge." **RUTH 2:12**
- 8 ACROSS Ruth "went and \_\_\_\_\_ in the field after the reapers. And she happened to come to the part of the field belonging to Boaz, who was of the family of Elimelech." **RUTH 2:3**
- 2 DOWN "Boaz said to Ruth, 'You will listen, my daughter, will you not? Do not glean in another field, nor go from here, but stay \_\_\_\_\_ by my young women.'" **RUTH 2:8**
- 4 DOWN Ruth "gleaned in the \_\_\_\_\_ until evening, and beat out what she had gleaned, and it was about an ephah of barley." **RUTH 2:17**
- 3 ACROSS "And her mother-in-law said to her, 'Where have you gleaned today? And where did you work? \_\_\_\_\_ be the one who took notice of you.'" **RUTH 2:19**
- 7 DOWN "So she told her mother-in-law with whom she had worked, and said, 'The man's name with whom I worked today is \_\_\_\_\_.'" **RUTH 2:19**
- 6 ACROSS "Then Naomi said to her daughter-in-law, 'Blessed be he of the LORD, who has not forsaken His kindness to the living and the dead!' And Naomi said to her, 'The man is a relative of ours, one of our near \_\_\_\_\_.'" **RUTH 2:20**
- 1 DOWN "So she stayed close by the young women of Boaz, to glean until the end of the barley \_\_\_\_\_ and wheat harvest; and she dwelt with her mother-in-law." **RUTH 2:23**

# Ruth

Read the Bible story at <http://gardenofpraise.com/bibl13s.htm>

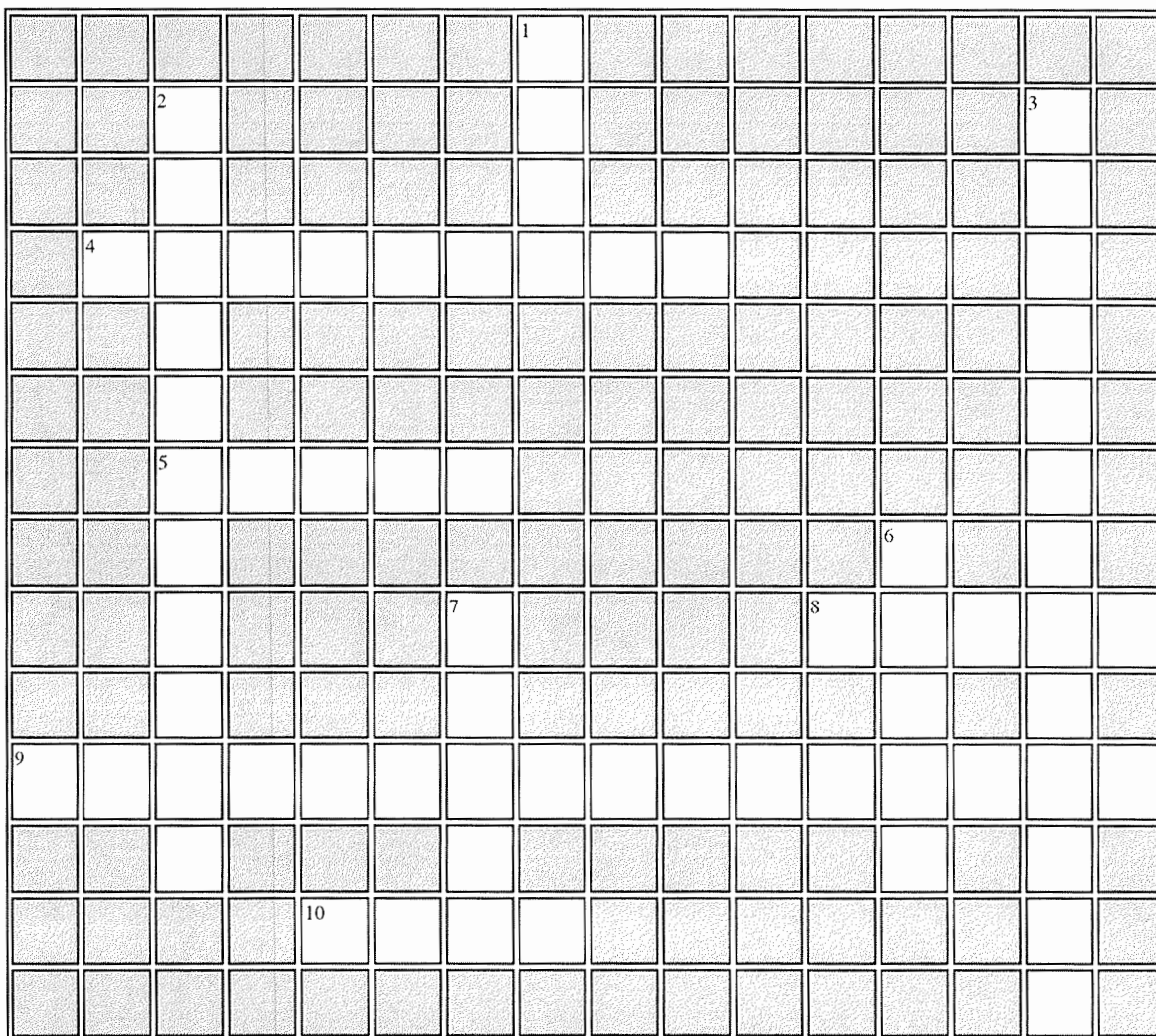

### Across

4. destination of Ruth and Naomi
5. Ruth's sister-in-law
8. Boaz wanted to \_\_\_\_ Ruth.
9. The kinsman took off his sandal to \_\_\_\_.
10. a word describing Ruth

### Down

1. King David was the great-grandson of \_\_\_\_.
2. Ruth gathered grain in the \_\_\_\_.
3. relationship of Ruth to Naomi
6. widow of Elimelech
7. To gather leftover grain is to \_\_\_\_.

WORD BANK: NAOMI, DAUGHTER IN LAW, ORPAH, BETHLEHEM, GLEAN, KIND,  
FIELD OF BOAZ, MARRY, SEAL THE AGREEMENT, RUTH

# Ruth

<http://gardenofpraise.com/bibl13s.htm>

M F W M J S D E H U V R  
U E O O A N V E U Z Y U  
M A H N D I J T B N P T  
B A D E T I G N A O R H  
K A R A L N W E S K O K  
L E L R I H L M D F T D  
X E F K Y G T E S S E L  
R D K I N D N E S S C E  
V I M O A N Y R B H T I  
G R A I N U B G Q J U F  
Z A O B J Z A A E V B Q  
B V A V G Z B X B D U E

AGREEMENT

BOAZ

GRAIN

MARRY

OBED

RUTH

BABY

FIELD

KINDNESS

MOAB

PROTECT

SANDAL

BETHLEHEM

GLEAN

KING

NAOMI

RELATIVE

WIDOW

## The Story of Ruth

Directions: Underline the words in the story as you find them, unscramble them and write them in the boxes below. During the time when the judges ruled, there was a famine in the land. A man named Elimelech took his wife Naomi and his two sons to the country of Moab because there was food in that land. Elimelech died, and Naomi was left as a widow with two sons. The sons married. One married a woman named Orpah, and the other married Ruth. After about ten years, the two sons died also. Naomi decided to go back to her home country, to the town of Bethlehem. Both of her daughters-in-law wanted to go with her, but she told them that they should stay in the land of Moab. Ruth insisted on going with her mother-in-law. The two of them went to Bethlehem. Naomi's friends were so glad to see her again! In those days, according to God's command, when a farmer harvested his field, he had to leave the grain that fell for the poor people to pick up. This gathering of the left-over grain was called "gleaning". Ruth went to "glean" in the field of a man named Boaz. He was a relative of Naomi's family. Ruth worked hard gathering grain to feed herself and Naomi. Boaz noticed how hard she was working and told her to stay in his field to glean. He invited her to eat with him and he said he would protect her from harm. Boaz wanted to marry Ruth, but there was another relative who had first choice of taking care of Ruth. The two men had a meeting. The other man decided that he couldn't take care of Ruth, so he took off his sandal, as the custom was, to seal an agreement. He told Boaz to buy the land and marry Ruth. They were married and later had a son named Obed. Obed, when he was grown, had a son named Jesse. Jesse's son was David. The great-grandson of Ruth became king of Israel, King David!

haOrp	<input type="text"/>
frmae	<input type="text"/>
aNimo	<input type="text"/>
eObd	<input type="text"/>
efmina	<input type="text"/>
mrayr	<input type="text"/>
iwowd	<input type="text"/>
cortpte	<input type="text"/>
verelati	<input type="text"/>
Beehmlhet	<input type="text"/>
aasndl	<input type="text"/>
kngi	<input type="text"/>
ivdDa	<input type="text"/>
garin	<input type="text"/>
nlgea	<input type="text"/>
tuhR	<input type="text"/>

## Ruth

E	P	H	A	H	Y	L	T	S	A	F	D	E	T	S
C	L	A	V	E	S	S	E	L	S	T	A	R	R	Y
A	K	I	Z	A	U	L	O	D	G	E	S	T	T	M
R	N	A	M	R	I	C	H	H	O	U	S	E	N	E
G	O	D	T	E	N	L	N	A	O	M	I	M	I	E
B	W	O	M	B	L	I	F	E	O	H	S	A	O	D
T	L	D	R	A	W	E	R	F	A	S	T	N	N	E
S	E	D	R	O	L	E	C	A	F	S	E	A	A	R
E	G	E	D	L	A	K	A	H	E	S	R	M	M	E
O	E	B	E	P	I	B	U	R	I	E	D	O	A	G
G	Y	O	E	N	I	S	R	A	E	L	A	W	H	N
L	E	R	S	D	Y	E	L	R	A	B	I	A	L	A
E	S	M	E	V	A	E	L	P	O	E	P	O	O	R
A	A	N	R	U	O	J	O	S	E	R	V	A	N	T
N	O	S	H	E	A	V	E	S	O	P	R	U	P	S

ABIDE	GLEAN	MOAB	SERVANT
ANJOINT	GOD	NAME	SHEAVES
BARLEY	GOEST	NAOMI	SHOE
BLESS	GRACE	OBED	SISTER
BOAZ	HOUSE	ORPAH	SOJOURN
BURIED	ISRAEL	PEOPLE	SON
CHILION	KINSMAN	POOR	STEDFASTLY
CLAVE	KNOWLEGE	PURPOSE	STRANGER
DIEST	LAW	REAPERS	TARRY
ELIMELECH	LEAVE	REDEEM	TEN
EPHAH	LIFE	REST	TRUST
EYES	LODGEST	REWARD	VAIL
FACE	LORD	RICH	VESSELS
FAST	MAHLON	SEED	WOMAN
FELL			WOMB



## **Year 2**

### **Week 63**

#### **God Blesses Ruth and Naomi**

#### **Scriptures: Ruth 3 & 4**

**Key Verse: Ruth 3:10** Then he said, “Blessed are you of the Lord, my daughter! For you have shown more kindness at the end than at the beginning, in all that you did not go after young men, whether poor or rich.

#### **Key Points:**

1. Naomi wished to find someone to care for Ruth. She instructed Ruth to wash and anoint herself, then go down to the threshing floor where Boaz would be. After he laid down to sleep, Naomi was to lay at his feet. At midnight, he was startled by her and asked who she was. When she told him, Boaz was happy that Ruth had shown him this kindness. He knew her reputation and knew she was a virtuous woman.

2. Boaz knew there was a relative closer to her than he. That relative had the right to buy Ruth’s former husband’s land and also take her for his wife. Boaz went to the city gates to find this relative. He also gave Ruth 6 ephahs of barley to take home to Naomi.

3. Boaz went to the elders at the city gate. He told the relative about the land, the relative wanted to redeem it. However, when he was told about Ruth, he changed his mind and did not want to redeem it. He did not want to risk his own inheritance for it would go to the family of Malhon. The kinsman-redeemer was to raise his firstborn son as Malhon’s and his inheritance would go to that child as well. The relative took off his sandal and handed it to Boaz to show he passed this right to Boaz.

4. Boaz took Ruth for his wife. They had a son, named him Obed. He was the grandfather of David. Naomi cared for the child and raised him as her son’s. Ruth and Naomi were blessed by God for following God’s plan for them.



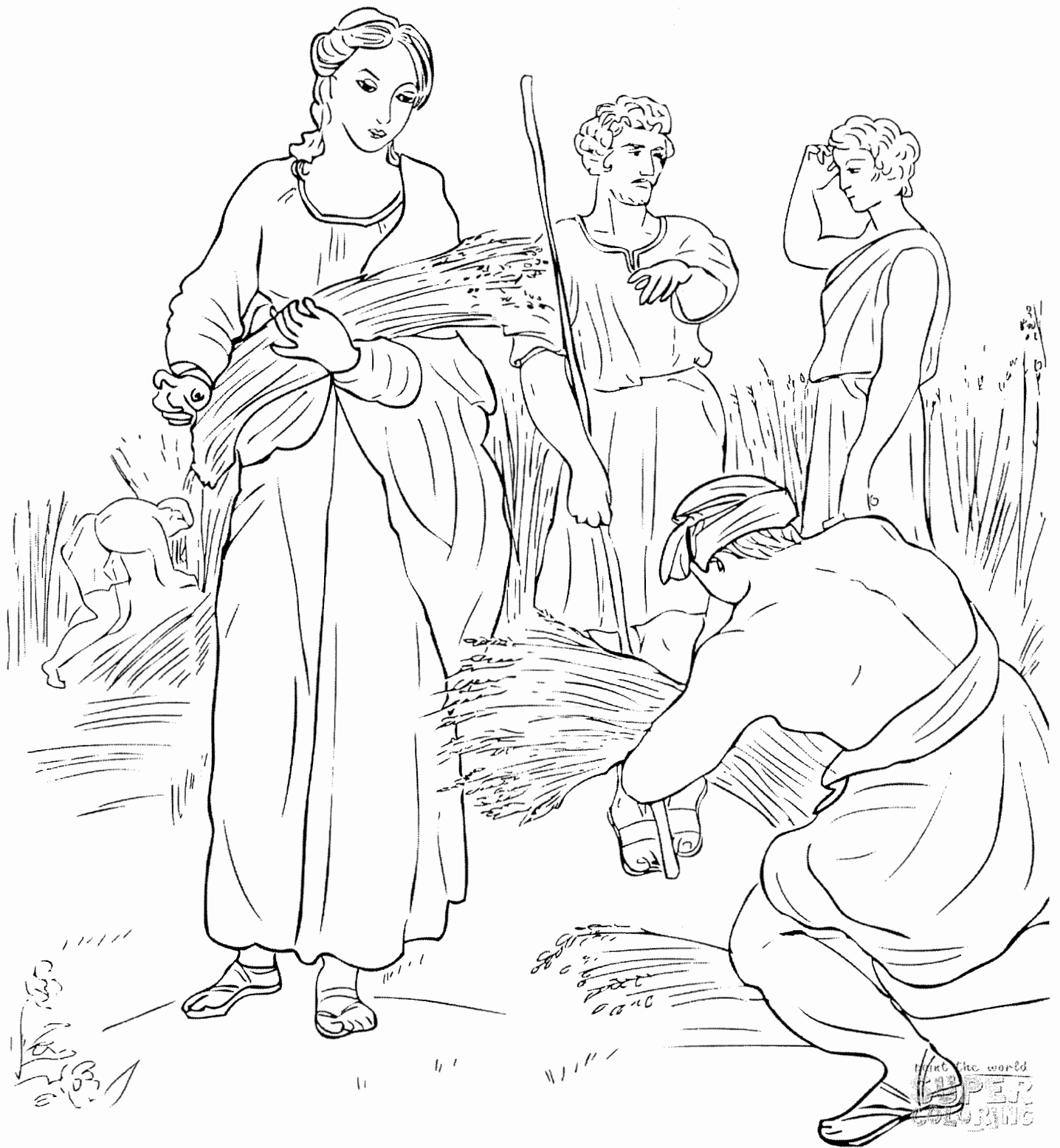

# BOAZ REDEEMS RUTH

(RUTH 4:1-13)



"Moreover Ruth the Moabitess, the wife of Mahlon, have I purchased to be my wife, to raise up the name of the dead upon his inheritance, that the name of the dead be not cut off from among his brethren, and from the gate of his place: ye *are* witnesses this day."

**RUTH 4:10**

Eccl 12:13

...Fear God, and keep his commandments: for this is the whole duty of man.



Ruth 4:8-10 Therefore the kinsman said unto Boaz, Buy it for thee. So he drew off his shoe. And Boaz said unto the elders, and unto all the people, Ye are witnesses this day, that I have bought all that was Elimelech's, and all that was Chilion's and Mahlon's, of the hand of Naomi. Moreover Ruth the Moabitess, the wife of Mahlon, have I purchased to be my wife, to raise up the name of the dead upon his inheritance, that the name of the dead be not cut off from among his brethren, and from the gate of his place: ye are witnesses this day







RaisingOurKids.com

**Ruth and Boaz had a son named Obed.**





**Ruth's Barley  
Threading Craft**

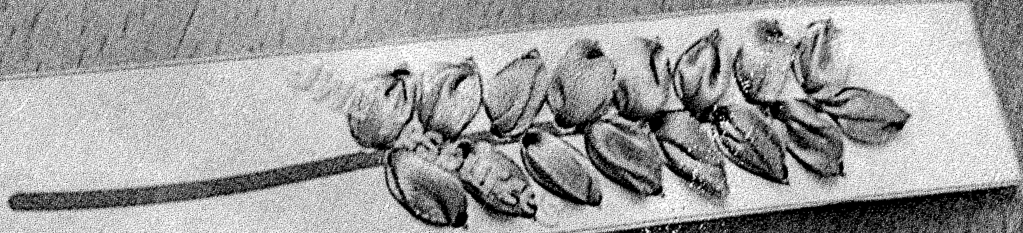

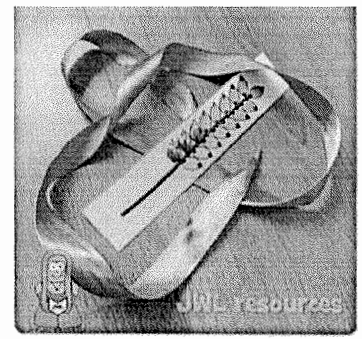
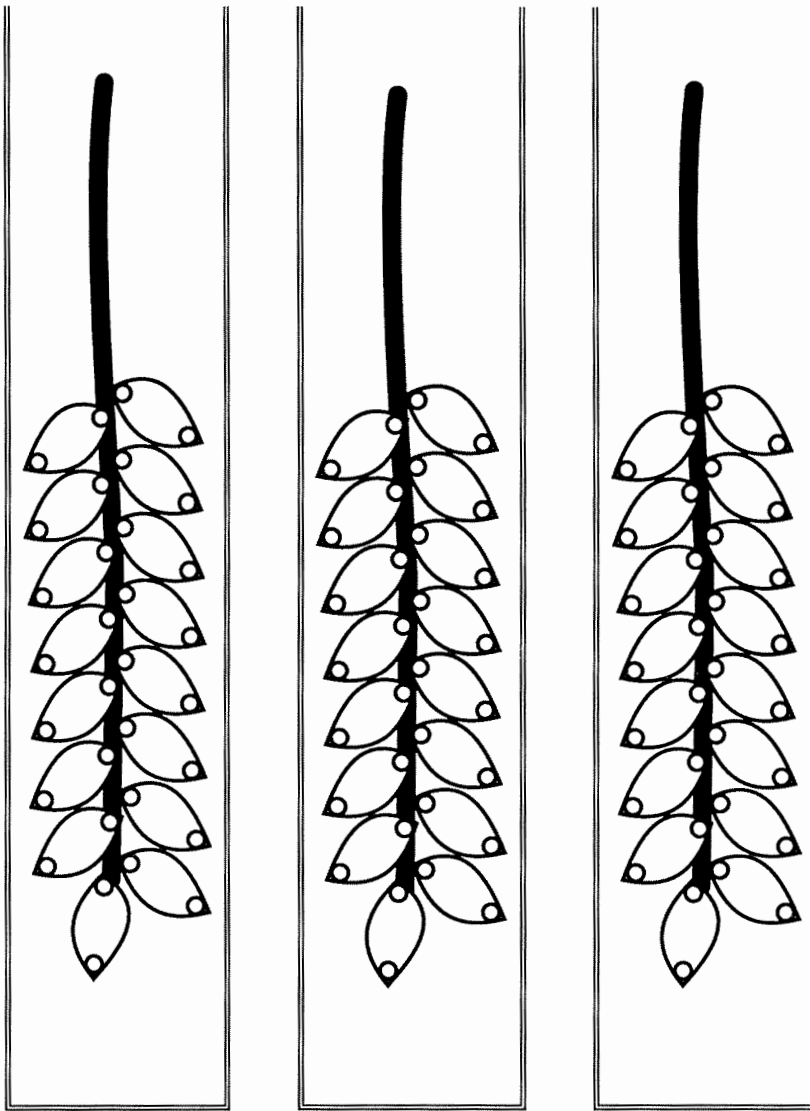

## Instructions

Cut out, punch holes where circles are. thread ribbon through bottom hole and stick with tape to secure. thread round the whole piece of barley. snip off excess ribbon and stick end down.

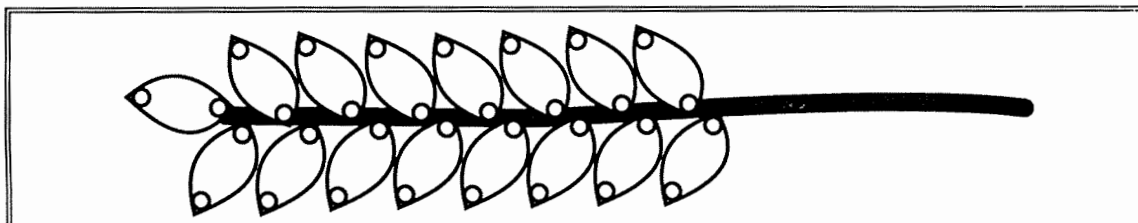
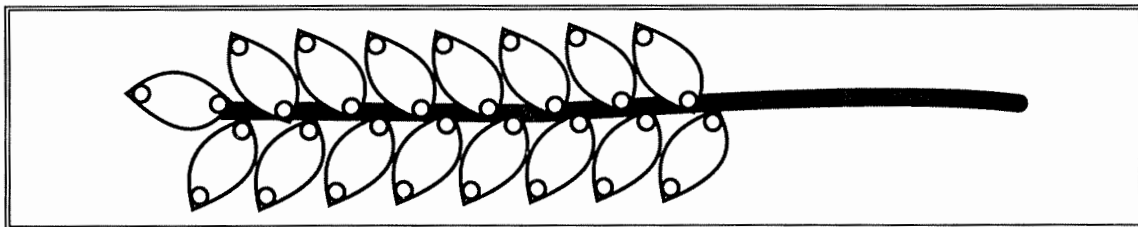
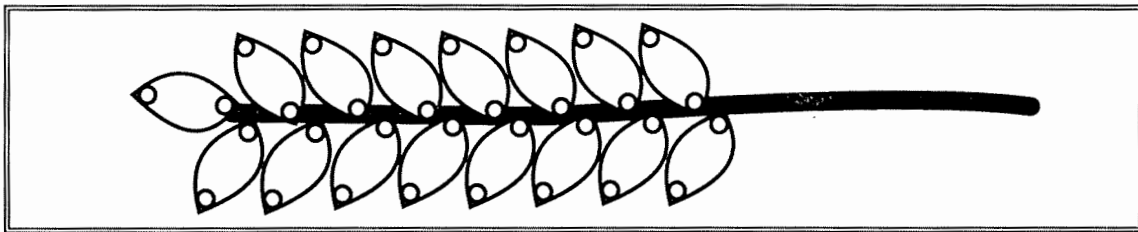

Ruth

Boaz

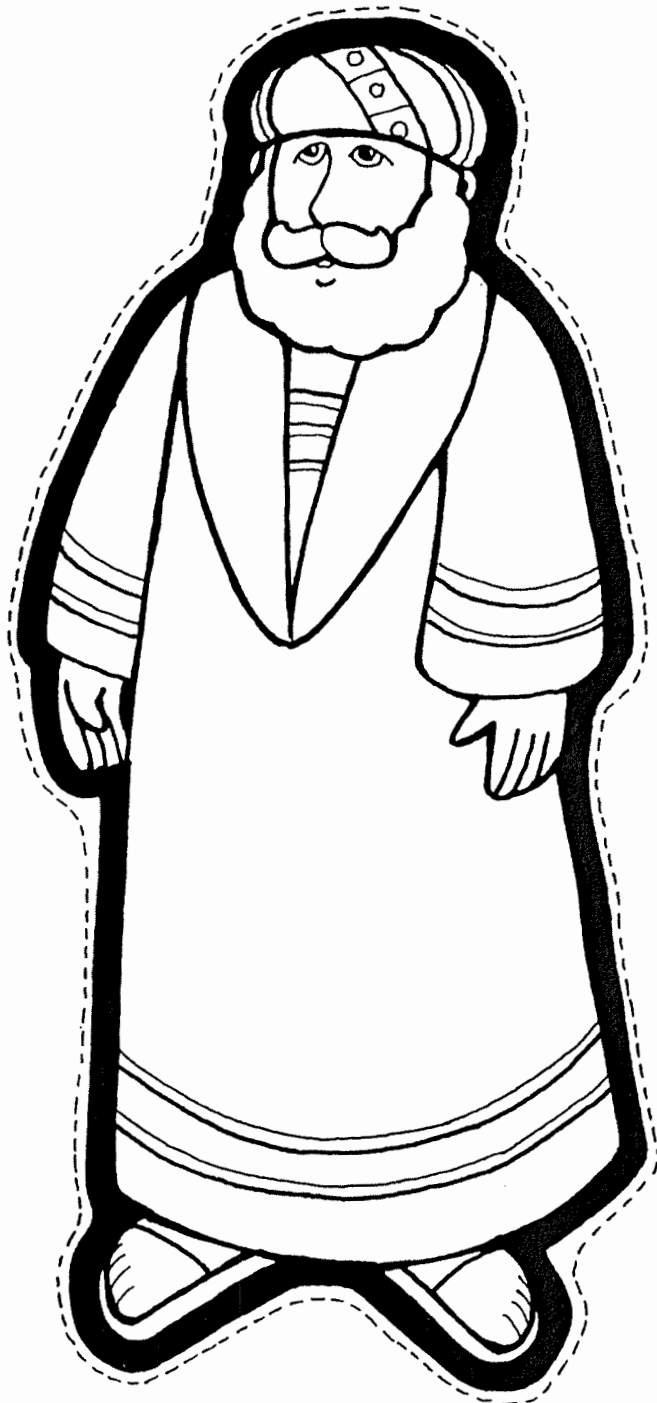

Baby Obed

# Ruth and Boaz Coded Words

Each number stands for a letter of the alphabet. Write the correct letter in the blank to find the coded words and phrase.

## Code key

A 1	J 10	S 19
B 2	K 11	T 20
C 3	L 12	U 21
D 4	M 13	V 22
E 5	N 14	W 23
F 6	O 15	X 24
G 7	P 16	Y 25
H 8	Q 17	Z 26
I 9	R 18	

7 18 1 9 14

14 1 15 13 9

8 1 18 22 5 19 20

6 9 5 12 4 19

13 1 18 18 25

2 5 20 8 12 5 8 5 13

RUTH WAS NAOMI'S

4 1 21 7 8 20 5 18 9 14 12 1 23

Name: \_\_\_\_\_

Date: \_\_\_\_\_

## Ruth and Boaz

---

When Naomi returned to \_\_\_\_\_ she was poor. The poor were allowed at \_\_\_\_\_ time to follow the reapers, gleaning or gathering up the stray ears of corn. One day, Ruth obtained permission from her mother-in-law to go \_\_\_\_\_, and went to glean in the field of a rich man named Boaz, who happened to be a kinsman, or \_\_\_\_\_ of Elimelech. But Ruth did not know of this relationship.

\_\_\_\_\_ saw Ruth gleaning, and asked one of his servants who she was. The servant replied, "She is the Moabite who came back with Naomi out of the country of \_\_\_\_\_." Then Boaz spoke kindly to Ruth, telling her not to go to any other field to glean, but to stay with his women workers and glean in his \_\_\_\_\_. Boaz was pleased with her because of her \_\_\_\_\_ to Naomi, so he bade her to eat and drink with his servants, and told his reapers to let some handfuls of \_\_\_\_\_ fall on purpose for her. So Ruth gleaned that day quite a large quantity of barley, which she took home to Naomi. Then she learned that Boaz was her kinsman.

She continued gleaning until the end of harvest; and afterwards became the \_\_\_\_\_ of Boaz and \_\_\_\_\_ of Jesse, the father of \_\_\_\_\_. Jesus Christ descended from David; so we see what high honour was bestowed upon Ruth for her kindness to her mother-in-law.

- |              |             |                |              |
|--------------|-------------|----------------|--------------|
| 1. Bethlehem | 4. field    | 7. grandmother | 10. Moab     |
| 2. Boaz      | 5. gleaning | 8. harvest     | 11. relative |
| 3. David     | 6. grain    | 9. kindness    | 12. wife     |



# Bible Pathway Adventures

BIBLE QUIZ

## RUTH & BOAZ

Match the question with the  
answer on the right.

### Questions

- \_\_\_\_\_ Where was Ruth born?
- \_\_\_\_\_ What was the name of Ruth's sister-in-law?
- \_\_\_\_\_ With whom did Ruth move to Bethlehem?
- \_\_\_\_\_ Where did Ruth and Boaz first meet?
- \_\_\_\_\_ What did Boaz offer Ruth to eat?
- \_\_\_\_\_ On the threshing floor, where did Ruth sleep?
- \_\_\_\_\_ The next morning, what did Boaz give Ruth?
- \_\_\_\_\_ Boaz was of which tribe of Israel? (1 Chronicles 2)
- \_\_\_\_\_ Which of God's Appointed Times (Feasts) celebrates the wheat harvest?
- \_\_\_\_\_ After Ruth and Boaz were married, what did they name their son?

### Answers

1. Feast of Shavuot (Pentecost)
2. Boaz's field
3. Six measures of wheat
4. Land of Moab
5. At Boaz's feet
6. Judah
7. Naomi
8. Obed
9. Orpah
10. Bread and roasted



# Ruth and Boaz Word Search

Find the words on the list that are hidden in the puzzle.  
The words can be left to right, up and down, or diagonally.

I	T	N	I	A	T	B	H	F	S	M	O	D
H	A	R	V	E	S	T	G	O	A	M	V	E
L	A	I	Q	U	N	O	N	O	E	C	T	B
T	U	E	D	E	R	E	D	D	L	I	Q	O
Z	B	E	T	H	L	E	H	E	M	T	V	A
L	A	O	R	E	M	I	R	S	I	T	E	Z
F	I	E	L	D	S	R	M	T	A	T	V	E
L	I	M	A	R	R	Y	G	E	A	C	I	D
U	N	N	A	L	U	Q	R	A	L	R	I	T
L	O	A	E	R	T	E	A	M	D	E	T	O
N	M	O	A	B	H	C	I	E	Q	U	C	S
N	O	M	S	E	Q	U	N	I	L	L	A	H
D	R	I	V	E	L	E	B	A	R	L	E	Y

BARLEY  
BETHLEHEM  
BOAZ  
ELIMELECH

FIELDS  
FOOD  
GRAIN  
HARVEST

MARRY  
MOAB  
NAOMI  
RUTH

# THE BIBLE TIMES HERALD

A SPECIAL REPORT ON RUTH 4:1-17

## BOAZ MARRIES RUTH



Witnesses saw Boaz speaking with Naomi's kinsman-redeemer. The kinsman-redeemer was supposed to buy

Naomi's land. One witness said he heard the kinsman-redeemer say that he would not buy Naomi's land. This meant that Naomi would not have her land to live on.

Boaz was next in line to become Naomi's kinsman-redeemer. He would be the one to buy her land. That way, she would always be taken care of. Boaz would also get to marry Ruth.

Later, witnesses saw Ruth and Boaz get married! How exciting it was for Ruth!

Many months later, Ruth had a baby boy. His name was Obed. Obed would be the father of Jesse. And Jesse would be the father of David.

For more details, please read Ruth 4:1-17 in the Bible.

## QUESTIONS

1. What did the first kinsman-redeemer say about buying Naomi's land?
2. Who was next in line to buy the land?
3. What did Ruth and Boaz do?
4. Do you think Naomi was excited about Boaz buying her land? Why or why not?

## MEMORY VERSE

"A wife of noble character who can find? She is worth far more than rubies." Proverbs 31:10

## MAZE MESSAGE

Write down each word as you come to it to find the hidden message.

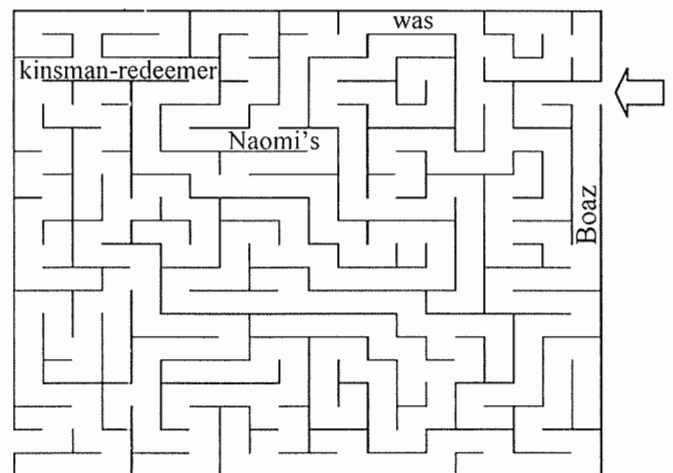

Hidden message: \_\_\_\_\_



# RUTH MARRIES BOAZ

*Ruth 4:1-17*

.....

Lawyers today write detailed contracts to complete a legal matter. In Bible times, there was a different way to seal a legal transaction. Write the letter that comes two letters after the letter given to discover this strange legal transaction.

.....

L M U   G L   C Y P J G C P   R G K C Q   G L   G Q P Y C J

D M P   R F C   P C B C K N R G M L   Y L B   R P Y L Q D C P

M D   N P M N C P R W   R M   Z C A M K C   D G L Y J   M L C

N Y P R W   R M M I   M D D   F G Q   Q Y L B Y J   Y L B

E Y T C   G R   R M   R F C   M R F C P   R F G Q   U Y Q

R F C   K C R F M B   M D   J C E Y J G X G L E

R P Y L Q Y A R G M L Q   G L   G Q P Y C J

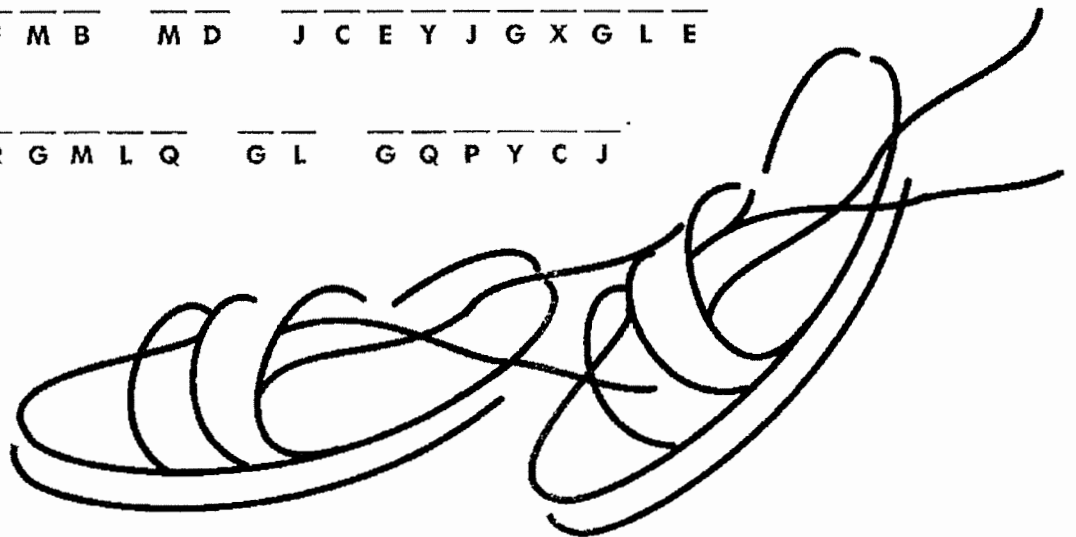

# BOAZ REDEEMS RUTH

## (RUTH 4:1-13)

### MEMORY VERSE:

*"As for our Redeemer, the LORD of hosts is His name, the Holy One of Israel." ISAIAH 47:4*

### FILL IN THE BLANKS:

1. Now Boaz "took ten men of the elders of the city, and said, 'Sit down here.' So they sat down. Then he said to the near \_\_\_\_\_, 'Naomi, who has come back from the country of Moab, \_\_\_\_\_ the piece of land which belonged to our brother Elimelech.'" **RUTH 4:2-3**

### TRUE OR FALSE:

2. "Boaz said, 'On the day you buy the field from the hand of Naomi, you must also buy it from Ruth the Moabitess, the wife of the dead, to raise up the name of the dead on his inheritance.'" **RUTH 4:5**

**TRUE OR FALSE**

### CIRCLE THE CORRECT WORDS:

3. "And the near kinsman said, 'I (**CAN, CANNOT**) redeem it for myself, lest I ruin my own inheritance. You redeem my right of redemption for yourself, for I (**CAN, CANNOT**) redeem it.'" **RUTH 4:6**
4. "Now this was the custom in former times in Israel concerning redeeming and exchanging, to confirm anything: one man took off his (**SANDAL, COAT**) and gave it to the other." **RUTH 4:7**

### FILL IN THE BLANK:

5. "Therefore the near kinsman said to Boaz, 'Buy it for yourself.' So he took off his \_\_\_\_\_." **RUTH 4:8**

### TRUE OR FALSE:

6. "So Boaz took Ruth and she became his wife." **RUTH 4:13**  
**TRUE OR FALSE**
7. "Then the women said to Naomi, 'Blessed be the LORD, who has not left you this day without a near kinsman; and may his name be famous in Israel.'" **RUTH 4:14**  
**TRUE OR FALSE**

# BOAZ REDEEMS RUTH

## (RUTH 4:1-13)

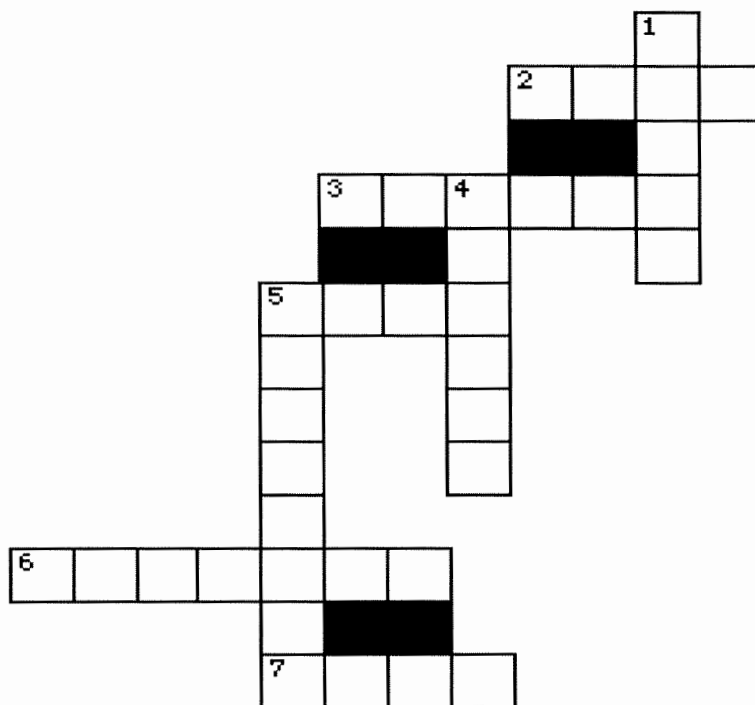

- 5 DOWN "As for our \_\_\_\_\_, the LORD of hosts is His name, the Holy One of Israel." **ISAIAH 47:4**
- 6 ACROSS Now Boaz "took ten men of the elders of the city, and said, 'Sit down here.' So they sat down. Then he said to the near \_\_\_\_\_, 'Naomi, who has come back from the country of Moab, sold the piece of land which belonged to our brother Elimelech.'" **RUTH 4:2-3**
- 2 ACROSS "\_\_\_\_\_ said, 'On the day you buy the field from the hand of Naomi, you must also buy it from Ruth the Moabitess, the wife of the dead, to raise up the name of the dead on his inheritance.'" **RUTH 4:5**
- 5 ACROSS "And the near kinsman said, 'I cannot redeem it for myself, lest I \_\_\_\_\_ my own inheritance. You redeem my right of redemption for yourself, for I cannot redeem it.'" **RUTH 4:6**
- 3 ACROSS "Now this was the \_\_\_\_\_ in former times in Israel concerning redeeming and exchanging, to confirm anything: one man took off his sandal and gave it to the other." **RUTH 4:7**
- 4 DOWN "Therefore the near kinsman said to Boaz, 'Buy it for yourself.' So he took off his \_\_\_\_\_." **RUTH 4:8**
- 7 ACROSS "So Boaz took \_\_\_\_\_ and she became his wife." **RUTH 4:13**
- 1 DOWN "Then the women said to \_\_\_\_\_, 'Blessed be the LORD, who has not left you this day without a near kinsman; and may his name be famous in Israel.'" **RUTH 4:14**

# BOAZ REDEEMS RUTH

## (RUTH 4:1-13)

E G R V F P N T A E T V Z X W T O U P K I E M L U  
 L M V D M U K T Y P O C O D T W U M L M S E J J W  
 M Q N D Q T O D M I M C A F L B I F J L G J Q B I  
 G H G E S I B D R O J S A N D A L O B U J A V B A  
 M V M Z Q N N U Q Y T H K B A H I E J G P V E K C  
 B A D Z V D T H U B K S U E O J B Z A O B K V J L  
 N V P O P H H Q E B G R U H A Y R P S R E D L E P  
 P G K W B R F C Q R H E N C P K W K H C Z U V K A  
 M S S H Q A V U T P I M U T A P K J T V F O L U I  
 W N P Q J Z I J H P G T D L D G I F J M B Z A M E  
 N B P I I E O K T Y D Q A U Y K N Y Y E X X I X Y  
 G K R L C M N S T F D N L N S G S T R E K A L Y A  
 K K X H T D H M R O V N A W C P M W D D M M R R Q  
 B O G T C W I J R J B Y U L M E A U C E Z Z U T A  
 Y J O A J Q U B W W G M F Q U S N G G R X B U T O  
 K Q S Y T X A T R S C A L N M O G H S U I T C C Y  
 P S L O W E F A P O Z S Y I S T T L Q B Z P Q M E  
 U P K A Y I F A N S T V H S E W I V U N F Z N P A  
 Y M W V J T T U K I H H X V J I M S M H Z F R M E  
 F B V C T A Q E B A K Y E U M H O U J X X V U L Q  
 K B J A N L H N C G K K O R G J A X Q A D F K C U  
 T O N L A B A N D W R W I U O D N H L U K H B S T  
 G H W O S Z I Q W A E L R A V U K U J V X N I G V  
 E S E Z L U U N M F N W F D S O W Q T A U E F E S  
 Y S L M R Z U N I M C W Y D P L I T W E Y E W Y E

**BOAZ**  
**BROTHER**  
**CUSTOM**  
**ELDERS**  
**GATE**

**INHERITANCE**  
**KINSMAN**  
**LAND**  
**NAME**  
**NAOMI**

**REDEEM**  
**RUIN**  
**RUTH**  
**SANDAL**

WRITE DOWN THE LETTERS IN THE BOXES AS YOU COME TO THEM ON THE LINES BELOW

→	B		L								O
		E						D	E		
				S					R		L
								B	D		E
		S								E	
										T	H

"-----"

**Year 2**

**Week 64**

## **God Answers Hannah's Prayer**

**Scriptures: I Samuel 1 & I Samuel 2:18-21**

**Key Verse: I Samuel 1:27 "For this child I prayed, and the lord has granted my petition which I asked of him."**

### **Key Points:**

- 1.** Elkanah had two wives, Hannah and Peninnah. Peninnah had children but Hannah did not.
- 2.** Yearly they would go to worship at Shilo to worship and sacrifice. Elkanah would give portions of meat to Peninnah and her children but gave Hannah a double portion because of his deep love for her. Peninnah would provoke her because she had no children so Hannah would not eat or drink in her distress.
- 3.** One day, when at the tabernacle for sacrifice, Hannah was earnestly praying. With many tears, she prayed for a child, promising God that if she had a child, she would give him to the Lord and never cut his hair. Eli, the priest, was in the doorway watching her. He thought she was drunk and asked her why she was acting that way. She told him she was in sorrow and not drunk.
- 4.** Eli told her to "Go in peace" and that god would grant her prayer. She went home and in time gave birth to a son. She called him Samuel. When he was weaned, Hannah took him and presented him to the Lord.
- 5.** Samuel worked in the tabernacle before the Lord, learning from Eli the priest. His mother would bring him a new robe each year as they came for the yearly sacrifice. Eli would bless them for giving Samuel to the Lord. Hannah kept her promise to the Lord and He blessed her. She had 3 more sons and 2 daughters.
- 6.** Our prayers are important to God. He listens and blesses us as we follow His directions for our lives.

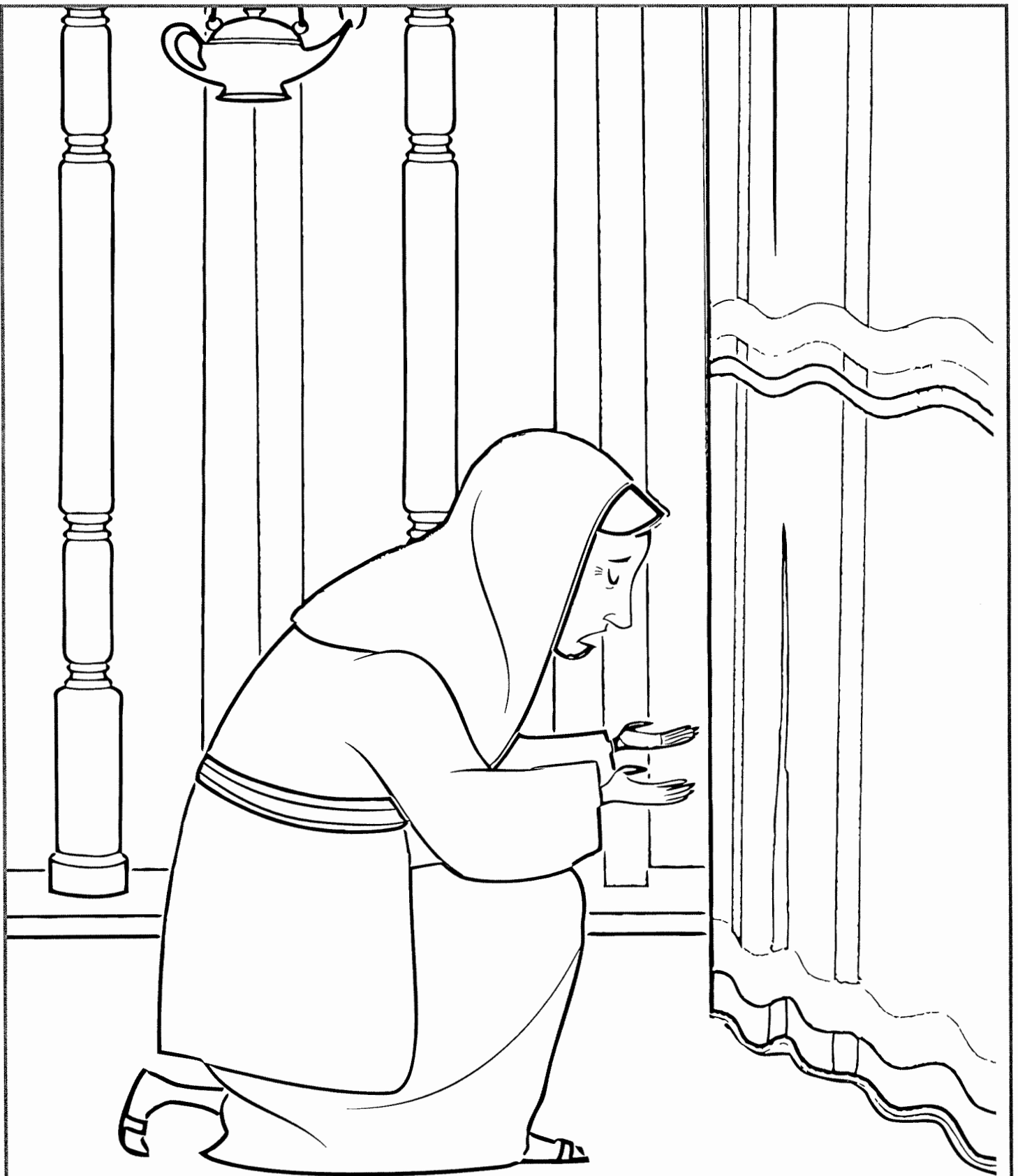

Hannah prayed for a baby.

**HANNAH**  
(1 SAMUEL 1:1-19)



"She was in bitterness of soul, and prayed to the LORD and wept in anguish."  
**1 SAMUEL 1:10**

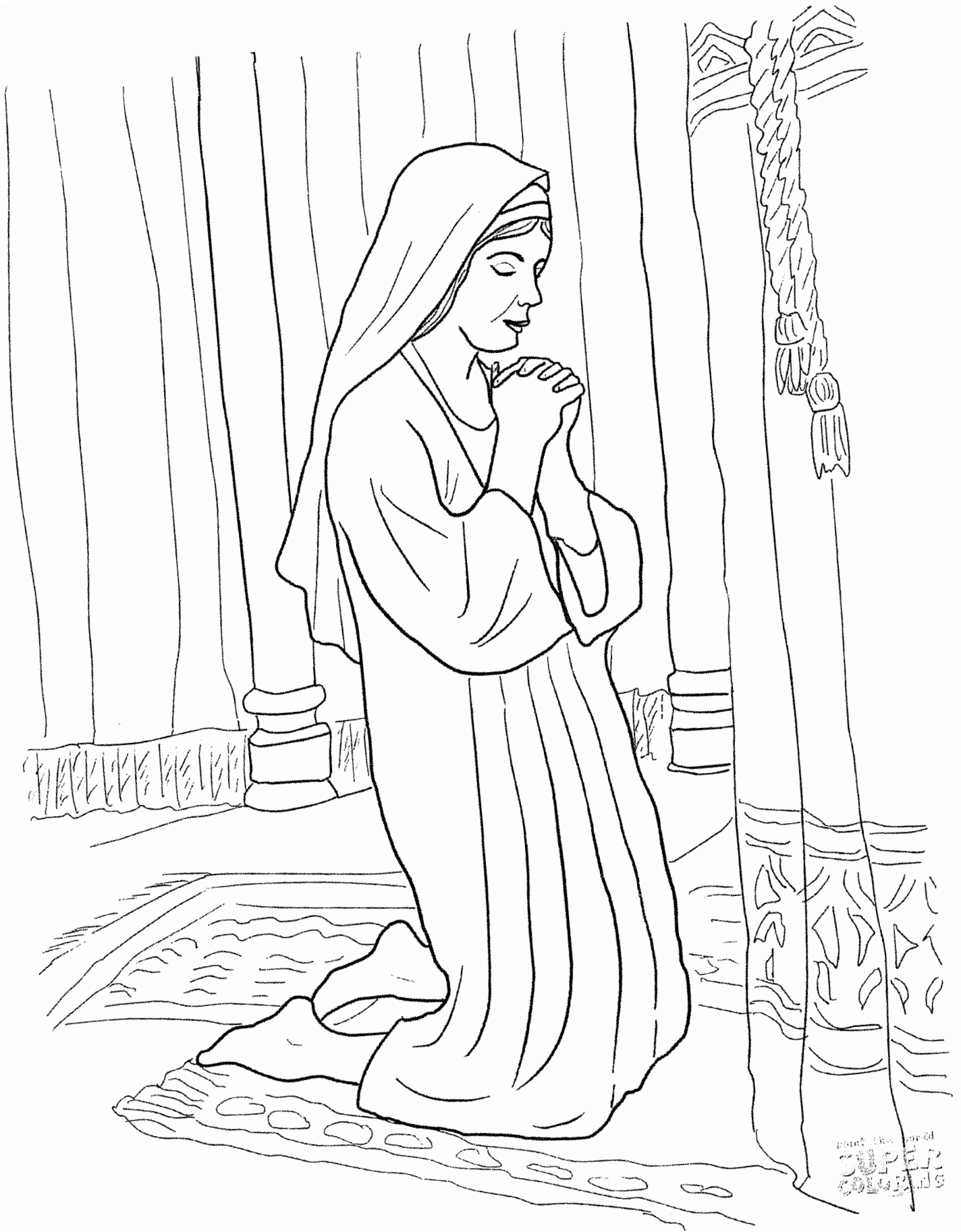

**HANNAH PRAYS FOR A SON**



# SAMUEL IS BORN

(1 SAMUEL 1:20-28)

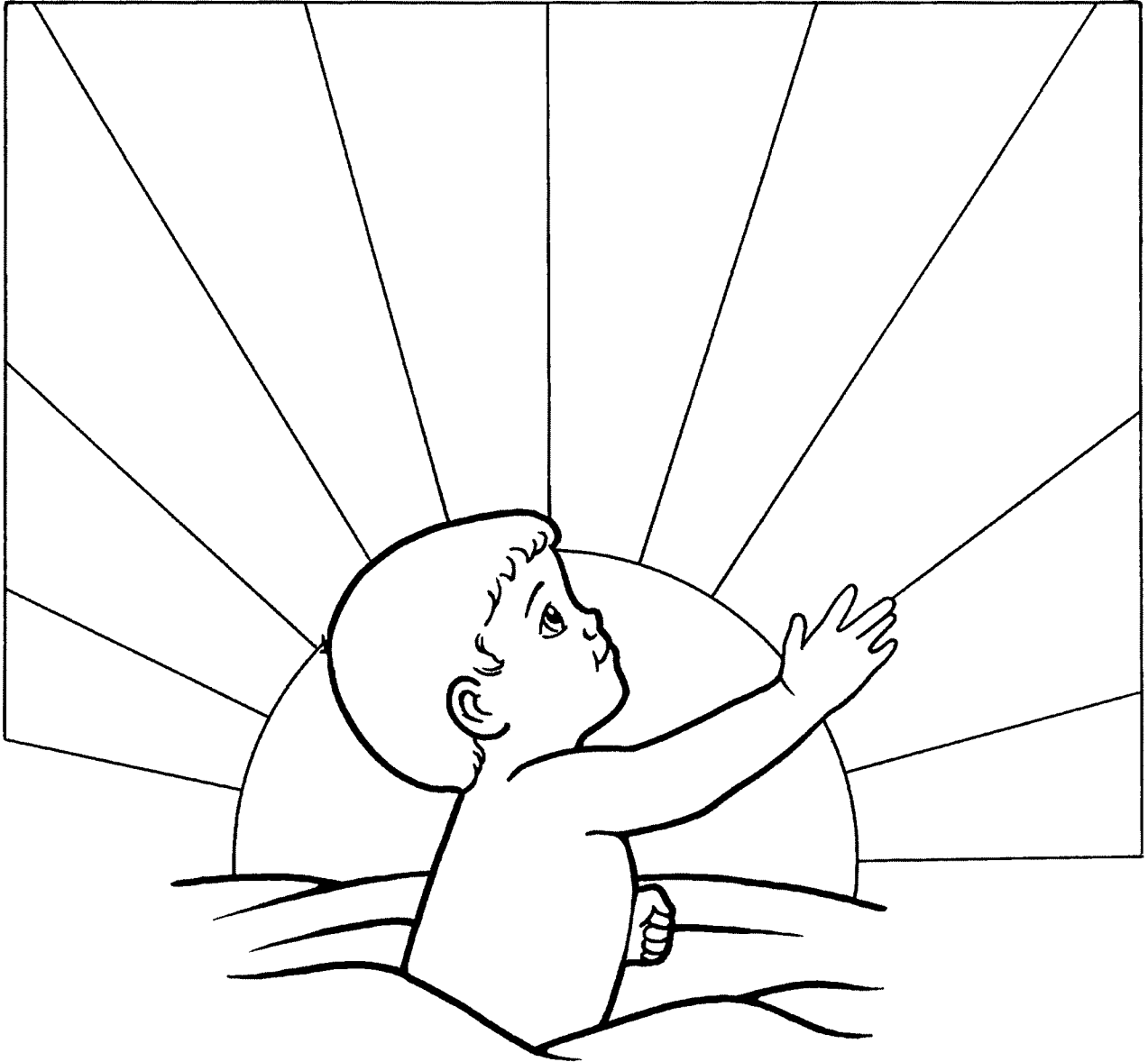

“Wherefore it came to pass, when the time was come about after Hannah had conceived, that she bare a son, and called his name Samuel, *saying*, Because I have asked him of the LORD.”  
**1 SAMUEL 1:20**

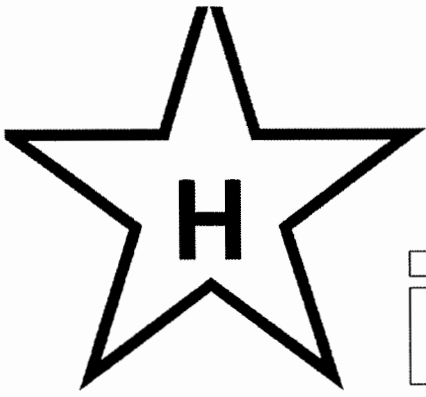

is for

Hannah

**Hannah had a son  
named Samuel  
1 Samuel 1:19-21**

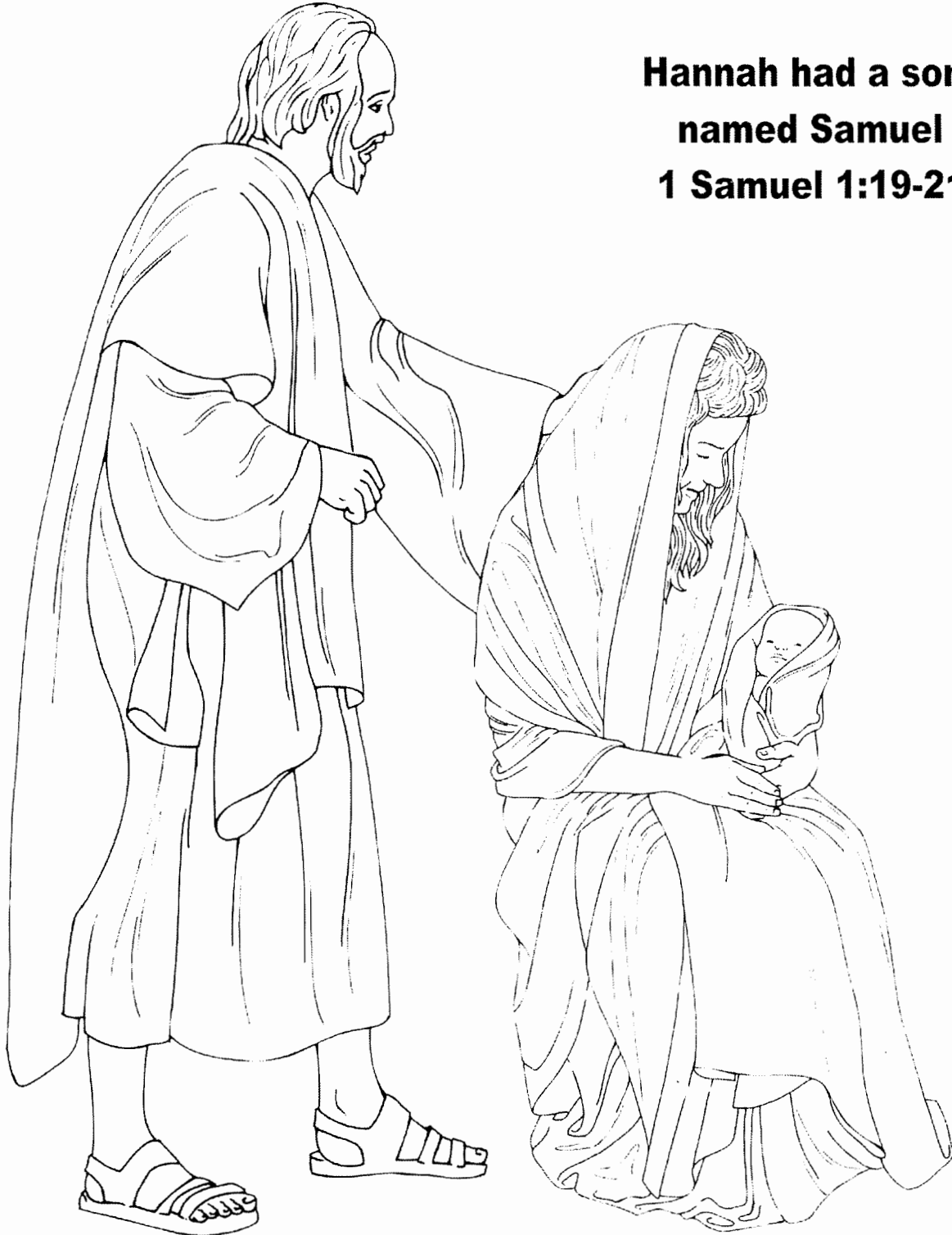

# Hannah's Gift From God

The Bible tells about a woman named Hannah who lived many, many years ago. Hannah loved God. But Hannah was not happy. She wanted a little boy to love. Hannah asked God to send her a baby boy. She said, "If You will send me a little boy, I will give him back to You when he is old enough."

God heard Hannah's prayer. It was not long before God gave Hannah and her husband a baby boy. They named the baby Samuel. Hannah loved her little boy very much.

Hannah kept her promise to God. As soon as Samuel was old enough she took him to God's house. Eli took care of God's house. Hannah said to Eli, "This is the little boy God sent to me. I promised God I would bring him here when he was old enough. I want him to learn to serve God."

Every year Hannah came to God's house to worship and to see her little boy. She always brought him a new coat. Samuel was happy in God's house. He worked hard. Eli taught him to serve God.

**Memory Verse:** "The boy Samuel kept growing. He pleased God and the people" (1 Samuel 2:26, ICB).

**Activity Instructions:** Connect the dots to see what Samuel's mother made for him. Color the picture. *Optional:* Cut cloth to fit the coat, then glue it to the picture.

Hannah's Gift From God

1 Samuel 1:1-28; 2:18, 19

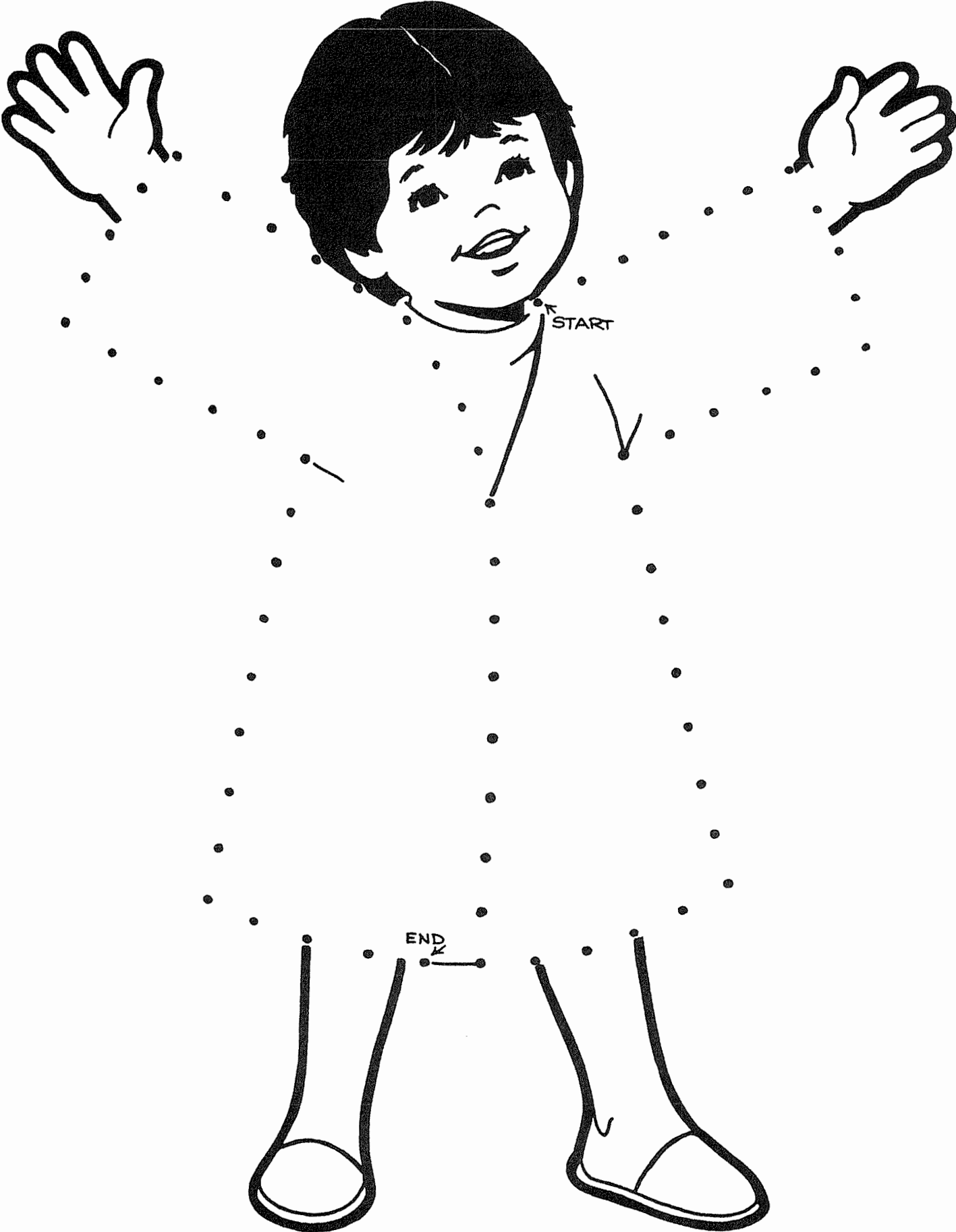

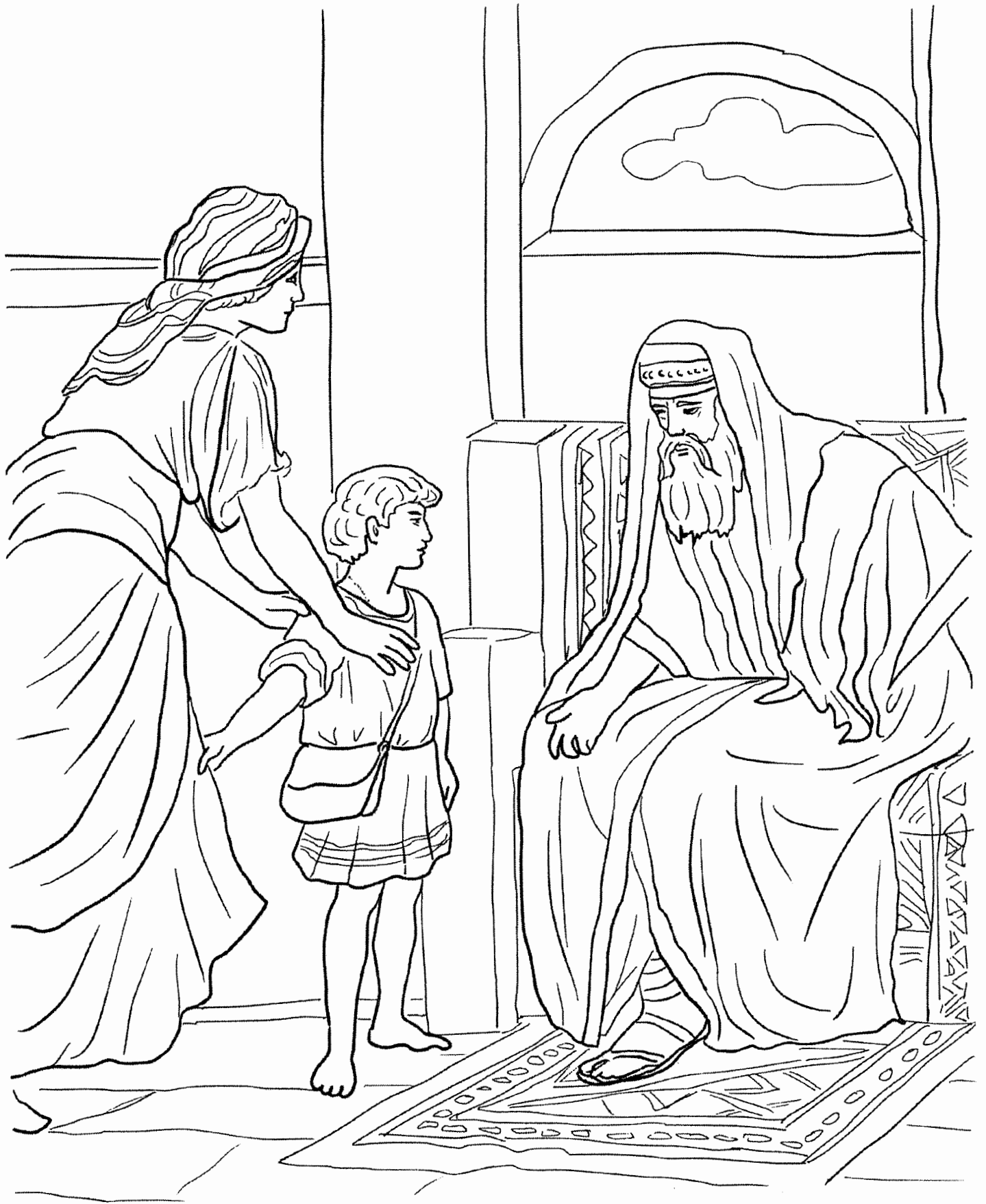

**HANNAH DEDICATES SAMUEL TO WORK FOR GOD**

## Quiz – Hannah’s Prayer for Samuel

**Write the verse where you found the answer next to the number.**

1. Where in the scriptures in this story found? \_\_\_\_\_
2. And Elkahah had two wives; the name of the one was \_\_\_\_\_, the other was Penninah.
3. Then said \_\_\_\_\_ her husband to her, her, “Hannah, why do you weep? Why do you not eat? And why is your heart grieved? *Am* I not better to you than ten sons?”
4. And she had bitterness of the \_\_\_\_\_, and prayed unto the Lord, and wept in anguish.
5. Then Eli answered and said, “Go in peace and the God of \_\_\_\_\_ grant your petition.”
6. So it came to pass in the process of time that Hannah conceived and bore a son, and called his name \_\_\_\_\_ *saying*, “Because I have asked for him from the Lord.”
7. And she said, “O my lord! As your soul lives, my lord, I *am* the woman who stood by you here, \_\_\_\_\_ to the Lord. “
8. “Therefore I also have \_\_\_\_\_ him to the Lord; as long as he lives he shall be lent to the Lord.” So they worshiped the Lord there.
9. But Samuel ministered before the Lord, *even as* a child, wearing a linen \_\_\_\_\_.
10. And the child Samuel grew in stature, and in \_\_\_\_\_ both with the Lord and men

# Hannah Prays for a Son



And she made a vow, saying, "O LORD Almighty, if you will only look upon your servant's misery and remember me, and not forget your servant but give her a son, then I will give him to the LORD for all the days of his life, and no razor will ever be used on his head." 1 Samuel 1:11 (NIV)

Words are taken from 1 Samuel 1:4-20 (NIV).

S C H P R I E S T T N S M Q W  
 S H C M E H M Q K Z L A U W I  
 A Y V H A S O R R O W M D C N  
 D T X N I I M I O J T U Q R E  
 N H N W U L V E S X U E Q Y N  
 B A S Z N O D G O N L L U I M  
 H S O N K H R R D F L Y F N U  
 M P E A C E Z E E X C K R G P  
 O K C B W Y K I O N L V L I R  
 R T F S C C H F M J K H H E H  
 N C N A I D W L F U N S Y C E  
 I A Z W M U H B Y E R A D W D  
 N S G S Q I V S V O R A W R Z  
 G T Q F S W L I W P T T O U R  
 L B I R T H G Y R B T L Q X F

answer	family	Lord	priest	sorrow
birth	fun	morning	sad	wicked
children	give	peace	Samuel	wine
crying	Hannah	prayer	son	worship

# Hannah Prays for a Son



And she made a vow, saying, "O LORD Almighty, if you will only look upon your servant's misery and remember me, and not forget your servant but give her a son, then I will give him to the LORD for all the days of his life, and no razor will ever be used on his head." 1 Samuel 1:11 (NIV)

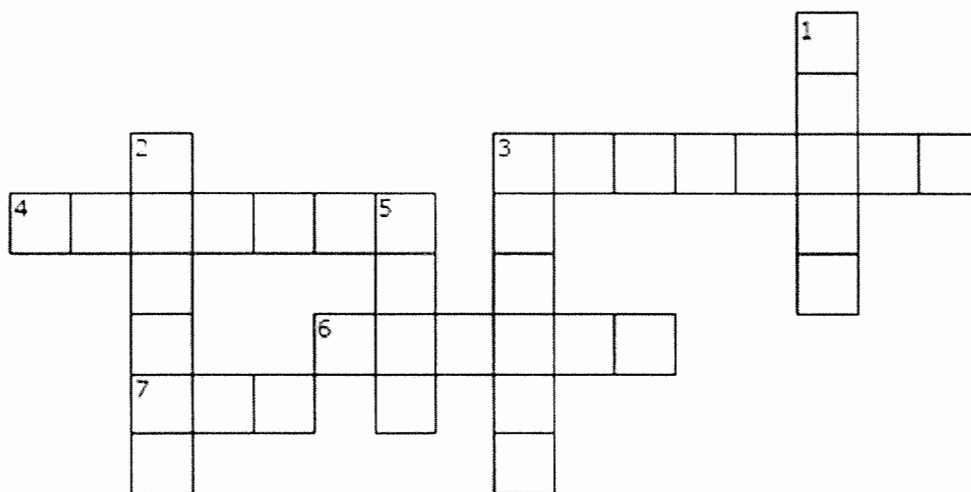

## ACROSS

3. Young people between birth and teenage years
4. The love, devotion, and adoration shown to God
6. The members of a household; parents and their children
7. Unhappy or sorrowful

## DOWN

1. The process of giving life to a child
2. A person who has authority to conduct religious ceremonies
3. Shedding tears, usually accompanied by sobs
5. To make a request to God

children  
crying

pray  
sad

birth  
priest

family  
worship



**HANNAH**  
(1 SAMUEL 1:1-19)

S W U B S C E R J D G K S U Q  
T O G L D N H E A R T S O H F  
L E U A G P M Y Q O W Y E I R  
M E F L P D E P I H S R O W C  
E B Y E T H A N N A H M Z P G  
Z D N Z E N H R L O D F P K T  
I V O C C L A E P K K L M P D  
I N I E V C K V V P A A E R O  
D P T L U M Y A R Z L W O R W  
Z Y I I D C Y X N E G L E E J  
P G T L I E M V C A S K U N V  
Z N E W P L Y H G S H D V A H  
V W P C N P I A Y T S I I I Y  
U Y I A S L B T R V A Q F A N  
D Z F Z D R P O Q P M S I P M

ELI

LORD

PRAYED

ELKANAH

MAIDSERVANT

SOUL

HANNAH

MALE CHILD

WEPT

HEART

PETITION

WORSHIPED

# HANNAH

(1 SAMUEL 1:1-19)

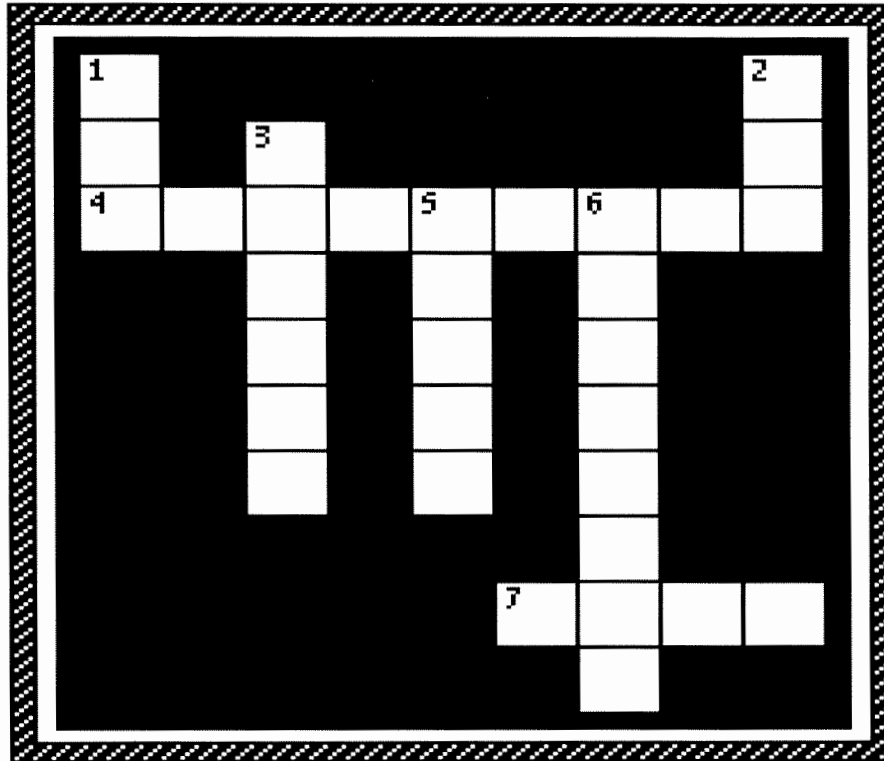

- 3 DOWN "She was in bitterness of soul, and \_\_\_\_\_ to the LORD and wept in anguish." **1 SAMUEL 1:10**
- 1 DOWN Hannah "made a \_\_\_\_\_ and said, 'O LORD of hosts, if You will indeed look on the affliction of Your maidservant and remember me, and not forget Your maidservant, but will give your maidservant a male child, then I will give him to the LORD all the days of his life, and no razor shall come upon his head.'" **1 SAMUEL 1:11**
- 5 DOWN "Now Hannah spoke in her \_\_\_\_\_; only her lips moved, but her voice was not heard. Therefore Eli thought she was drunk." **1 SAMUEL 1:13**
- 7 ACROSS "And Hannah answered and said, "No, my lord, I am a woman of sorrowful spirit. I have drunk neither wine nor intoxicating drink, but have poured out my \_\_\_\_\_ before the LORD." **1 SAMUEL 1:15**
- 6 DOWN "Eli answered and said, "Go in peace and the God of Israel grant your \_\_\_\_\_ which you have asked of Him." **1 SAMUEL 1:17**
- 2 DOWN Hannah "went her way and ate, and her face was no longer \_\_\_\_\_." **1 SAMUEL 1:18**
- 4 ACROSS Then Elkanah and Hannah "rose early in the morning and \_\_\_\_\_ before the LORD, and returned and came to their house." **1 SAMUEL 1:19**

# HANNAH

## (1 SAMUEL 1:1-19)

### MEMORY VERSE:

*"She was in bitterness of soul, and prayed to the LORD and wept in anguish."* 1 SAMUEL 1:10

### FILL IN THE BLANK:

1. Hannah "made a vow and said, 'O LORD of hosts, if You will indeed look on the affliction of Your maidservant and remember me, and not forget Your maidservant, but will give your maidservant a male child, then I will \_\_\_\_\_ him to the LORD all the days of his life, and no razor shall come upon his head.'" 1 SAMUEL 1:11

### CIRCLE THE CORRECT WORDS:

2. "Now Hannah spoke in her \_\_\_\_\_; only her lips moved, but her voice was not heard. Therefore Eli thought she was drunk." 1 SAMUEL 1:13  
HEAD HEART
3. "And Hannah answered and said, "No, my lord, I am a woman of sorrowful spirit. I have drunk neither wine nor intoxicating drink, but have poured out my \_\_\_\_\_ before the LORD." 1 SAMUEL 1:15  
CUP SOUL
4. "Eli answered and said, "Go in \_\_\_\_\_ and the God of Israel grant your petition which you have asked of Him." 1 SAMUEL 1:17  
PEACE HASTE

### TRUE OR FALSE:

5. Hannah went on her way and was still sad. 1 SAMUEL 1:18  
TRUE OR FALSE
6. Then Elkanah and Hannah "rose early in the morning and worshiped before the LORD, and returned and came to their house." 1 SAMUEL 1:19  
TRUE OR FALSE

# SAMUEL IS BORN

(1 SAMUEL 1:20-28)

F D E Y A R P A G K T O I Y H  
 O B J G V T M N D S E T Q Y M  
 P Y N X V A X M E H A A D O L  
 E N S G B Q T G H Q A M J F S  
 O M H A N A K L E O J N U V V  
 O H Z R Q P Y P P J L N N E O  
 C L K Q Y H L H Z B E I Q A L  
 H D B I E P I A C B N R H F H  
 I D E P I H S R O W T D R S J  
 L R Z P L J O W C R Z E I S J  
 D E F H N T V X Q B Z N L V E  
 C U H Z V B Q P I J J A S M A  
 P E T I T I O N W E C E T A W  
 F W N I Q I Z E Z F T W F Z L  
 K D R O L A U S K J I P A S Z

CHILD  
 ELKANAH  
 HANNAH  
 LENT

LORD  
 PETITION  
 PRAYED  
 SAMUEL

SHILOH  
 WEANED  
 WORSHIPED

WRITE DOWN THE LETTERS AS YOU COME TO THEM ON THE LINES BELOW

F O R T  
 S H  
 C H I L  
 A R P I D  
 Y E D

\_\_\_\_\_  
 \_\_\_\_\_  
 \_\_\_\_\_  
 \_\_\_\_\_

" \_\_\_\_\_ "



# SAMUEL IS BORN

## (1 SAMUEL 1:20-28)

### MEMORY VERSE:

*"For this child I prayed, and the LORD has granted me my petition which I asked of Him." 1 SAMUEL 1:27*

### UNDERLINE THE CORRECT ANSWER:

1. "So it came to pass in the process of time that Hannah conceived and bore a son, and called his name Samuel, saying..." **1 SAMUEL 1:20**
  - a. Because I have asked for him from the LORD
  - b. Because I deserve him

### TRUE OR FALSE:

2. "Elkanah and all his house went up to offer to the LORD the yearly sacrifice and his vow." **1 SAMUEL 1:21**

**TRUE OR FALSE**

3. And Hannah went with her husband and brought with her Samuel. **1 SAMUEL 1:22**

**TRUE OR FALSE**

### FILL IN THE BLANKS:

4. "Now when she had weaned him, she took him up with her, with three bulls, one ephah of flour, and a skin of wine, and brought him to the house of the LORD in \_\_\_\_\_. And the child was young." **1 SAMUEL 1:24**
5. "Then they slaughtered a \_\_\_\_\_, and brought the child to Eli." **1 SAMUEL 1:25**
6. "And she said, "O my lord! As your soul lives, my lord, I am the woman who stood by you here, \_\_\_\_\_ to the LORD." **1 SAMUEL 1:26**
7. "For this child I \_\_\_\_\_, and the LORD has granted me my petition which I asked of Him." **1 SAMUEL 1:27**
8. "Therefore I also have lent him to the LORD; \_\_\_\_\_ he shall be lent to the LORD." **1 SAMUEL 1:28**

### TRUE OR FALSE:

9. "So they worshiped the LORD there." **1 SAMUEL 1:28**

**TRUE OR FALSE**

# SAMUEL IS BORN

## (1 SAMUEL 1:20-28)

U Y S V X O Q T Z A N P P P W H E U F W  
 Y K N N W A J N Z F T N N Y A K M N B T  
 Y P B D E V H D N S A M U E L K Q U E L  
 R U R G W C I A K F J A N F F R N D H A  
 R O M D L O C R N T M Y B O U E Y L T O  
 L Y K P V A R A O N S Q C J H O L I H S  
 H R O K D L T S B Q A U D E T N M U L A  
 E K J S D O C Z H H M H W L O G A F U P  
 L T Q P Z Z J E D I J Q K K M N S L W A  
 M G S P Z M W M H E P T I A J I V E L I  
 G C P R O F Y D S A N E E N K Y Y Y Q D  
 M E H X W P J W V U T A D A G A K H N Y  
 B Y M I H M E Q I U A H E H H R W X I S  
 P G B O L Q T T T N E L P W G P L O S M  
 M M B S Q D N X I T A T I W D C W I V U  
 W Q O L I S A I O T U T Y S V V W R U N  
 N H H K L Q S T N T I R B S B C Z F U S  
 G V S W H V L A H D E O B I L W O Y A E  
 K V S V T P P L I D N R N A C H A X D J  
 B G R J Y B U B U Q Q W P G Z R K D D M

CHILD  
 ELI  
 ELKANAH  
 HANNAH

LENT  
 LORD  
 PETITION  
 PRAYING

SAMUEL  
 SHILOH  
 WEANED  
 WORSHIPED

WRITE DOWN THE LETTERS AS YOU COME TO THEM ON THE LINES BELOW

F O R T  
 S I H  
 C H I L  
 A R P I D  
 Y E D

"-----"

**Year 2**

**Week 65**

## **God Calls Samuel**

**Scriptures: I Samuel 3 (I Samuel 2:27 prophecy against the house of Eli)**

**Key Verse: I Samuel 3:10 Then the Lord came and stood and called as at other times, “Samuel, Samuel!”, And Samuel answered, “Speak for your servant hears.”**

### **Key Points:**

**1.** The boy Samuel served with Eli in the tabernacle. One night after they had laid down to sleep, God called out to Samuel. Samuel, thinking it was Eli, went to Eli and said, “Here I am!”

**2.** Eli told him to go back to sleep, that he had not called him. This happened 3 times before Eli realized it was the Lord calling. He told Samuel when it happened again, to say “Speak Lord for Your servant is listening.” The Lord calls again and Samuel answered him just as instructed.

**3.** The Lord tells Samuel about the wickedness of Eli’s sons. (explain how they did not follow the rules God had set for priests) God was going to punish his family because Hophni and Phinehas were disobedient and wild. This is a prophecy of what is to come to the house of Eli. Eli had been warned of what would come if his sons continued in their sin (I Samuel 2:27-36)

**4.** Eli had not disciplined his sons as he should. Samuel did not want to tell Eli about the vision. But Eli told him not to hide it from him so Samuel told him. Eli said that the Lord will do what is good in His own eyes.

**5.** The Lord continued to be with Samuel and he grew. All Israel recognized him as a prophet of the Lord.





Samuel was called by God and served in the temple from childhood. He was the last of the Judges.

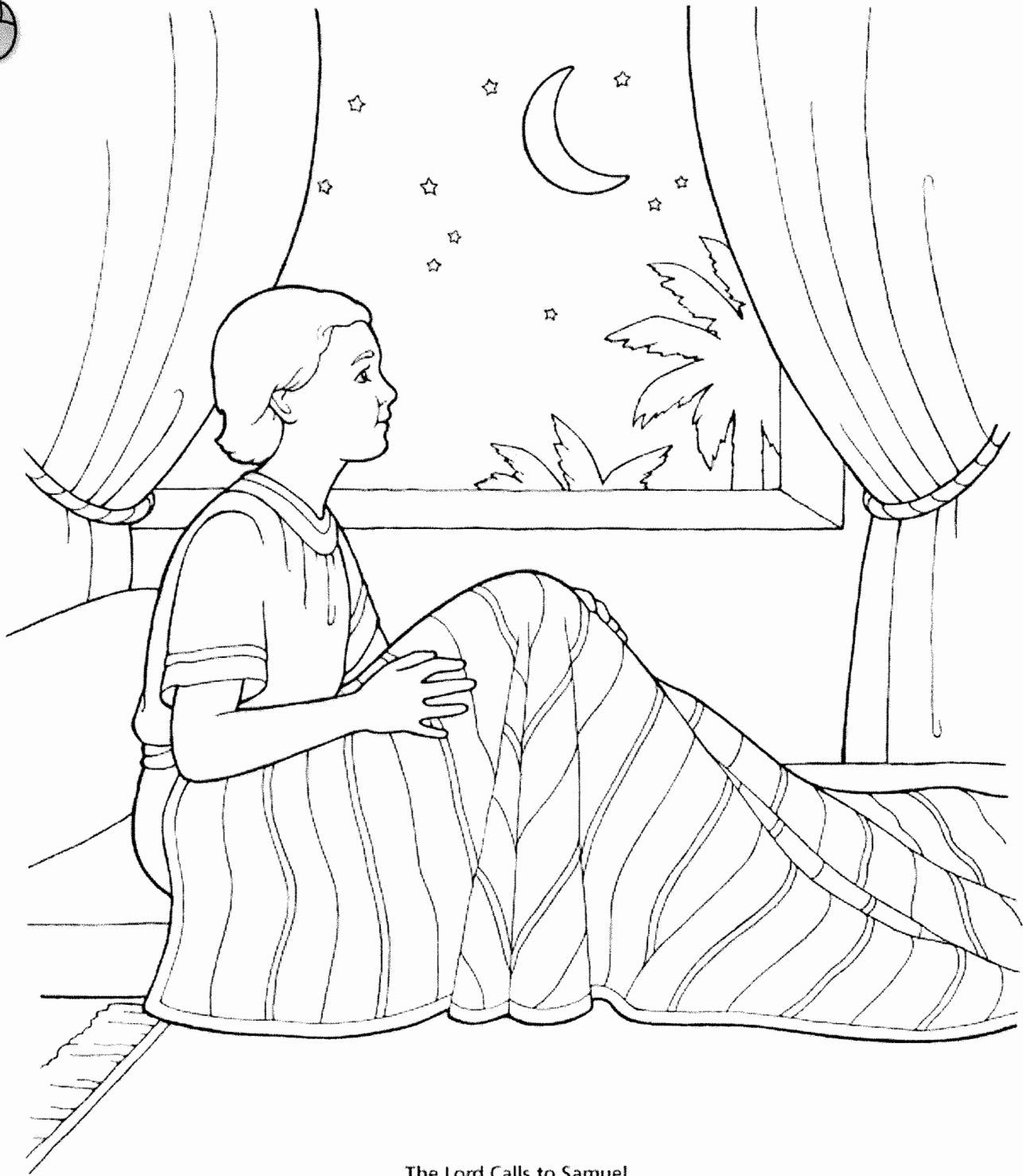

**The Lord Calls to Samuel**

*The Lord called Samuel, and he answered, Here am I*  
(1 Samuel 3:4)

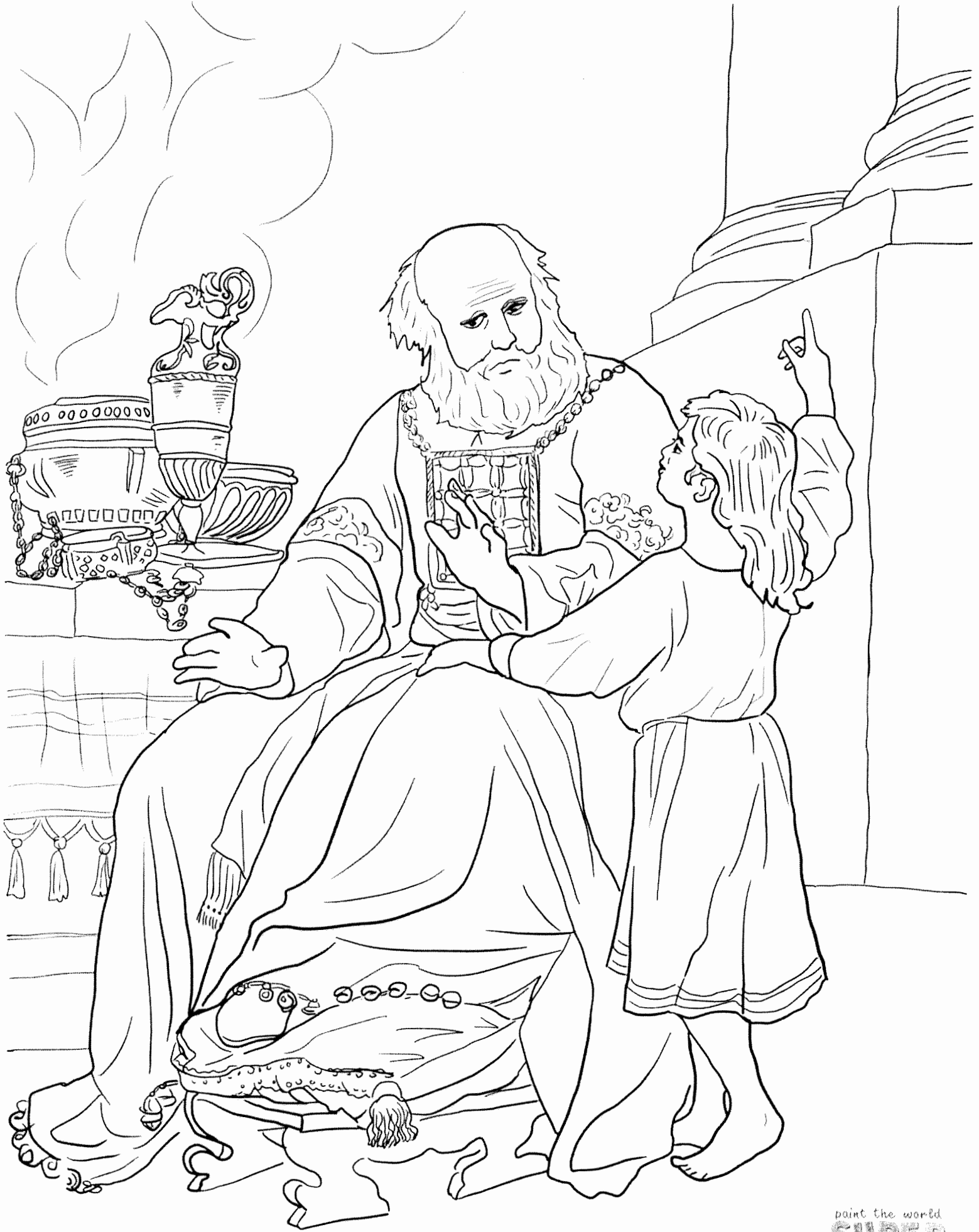

# Samuel Hears God



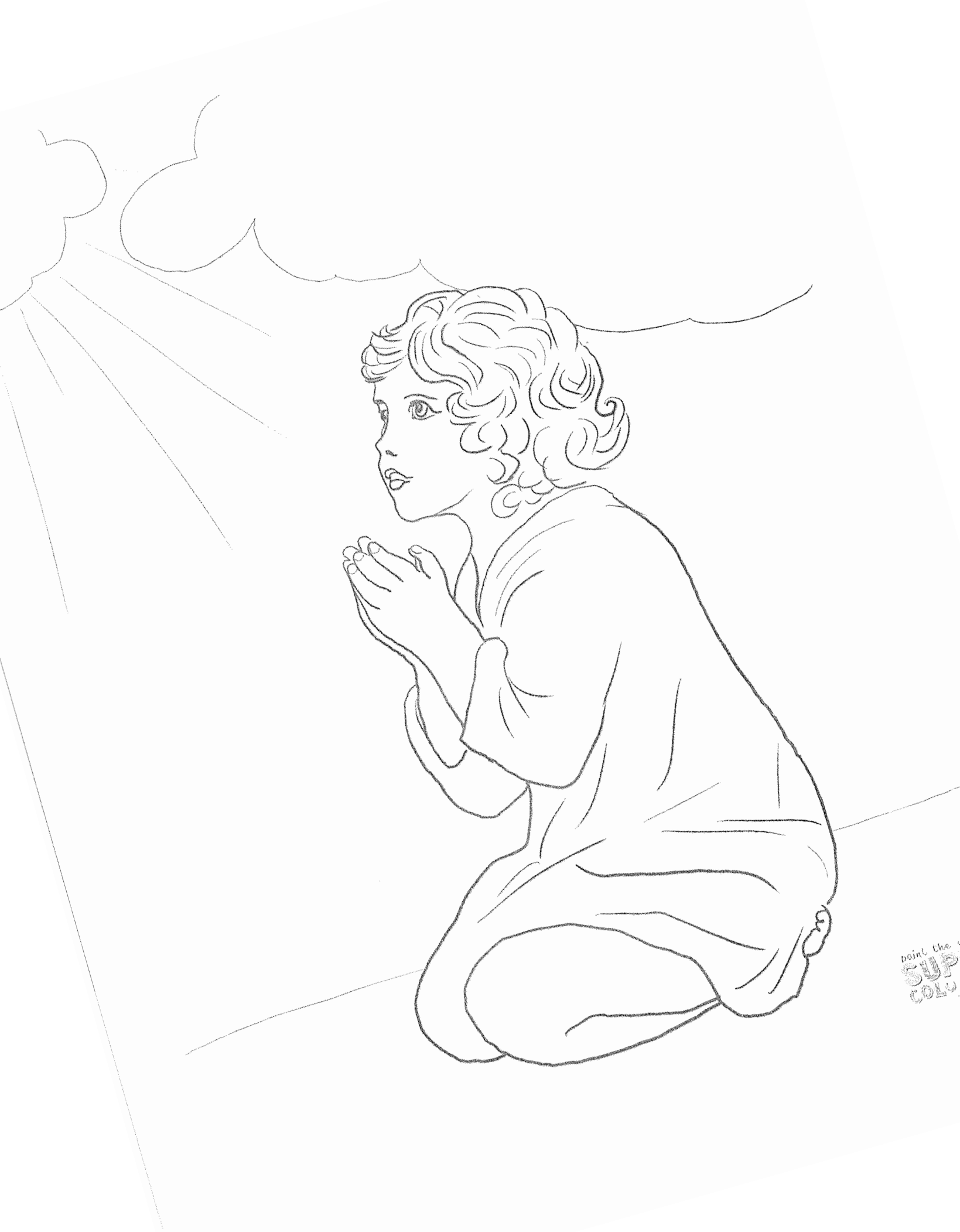

Point the  
**SUP**  
COLOR

# SAMUEL IS CALLED

(1 SAMUEL 3:1-20)



"So Samuel grew, and the LORD was with him and let none of his words  
fall to the ground." 1 **SAMUEL 3:19**

Samuel

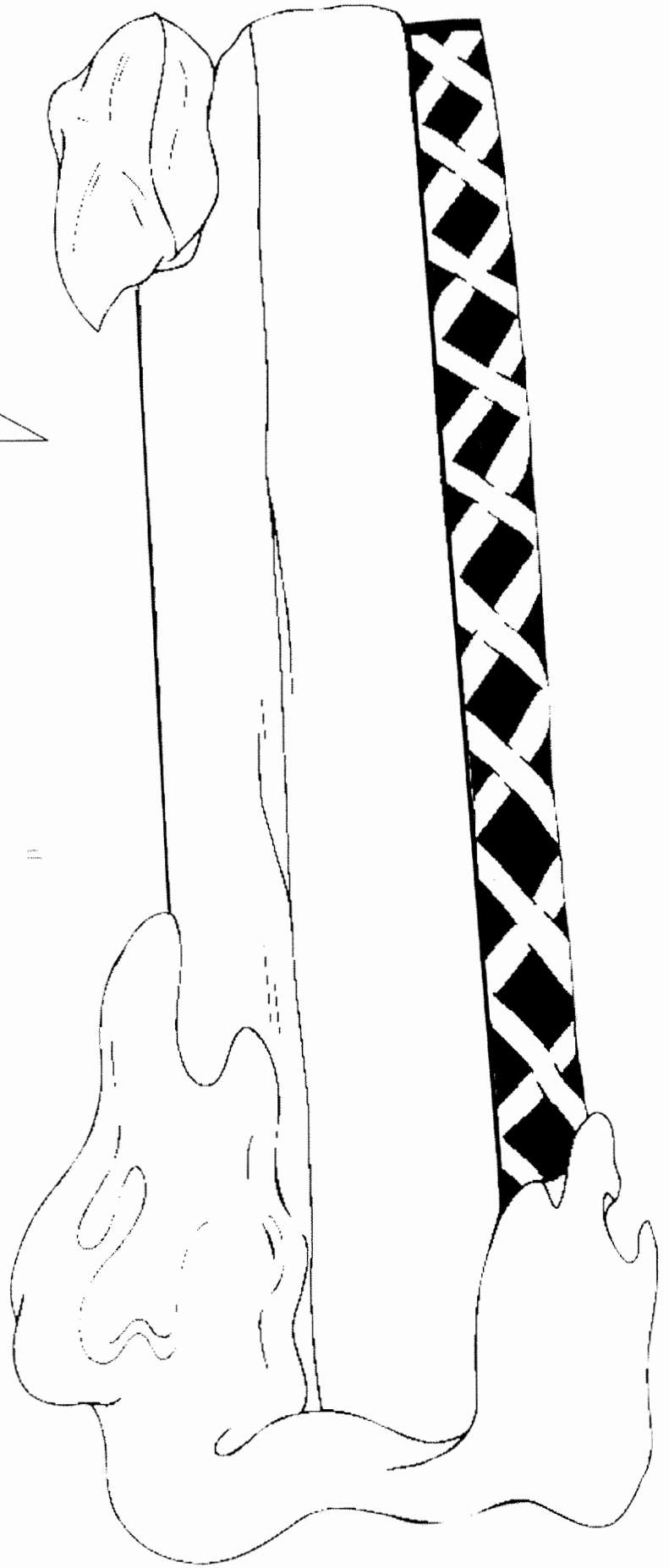

Cut, Color and glue to large craft stick

Add small piece of fabric at the end of the bed

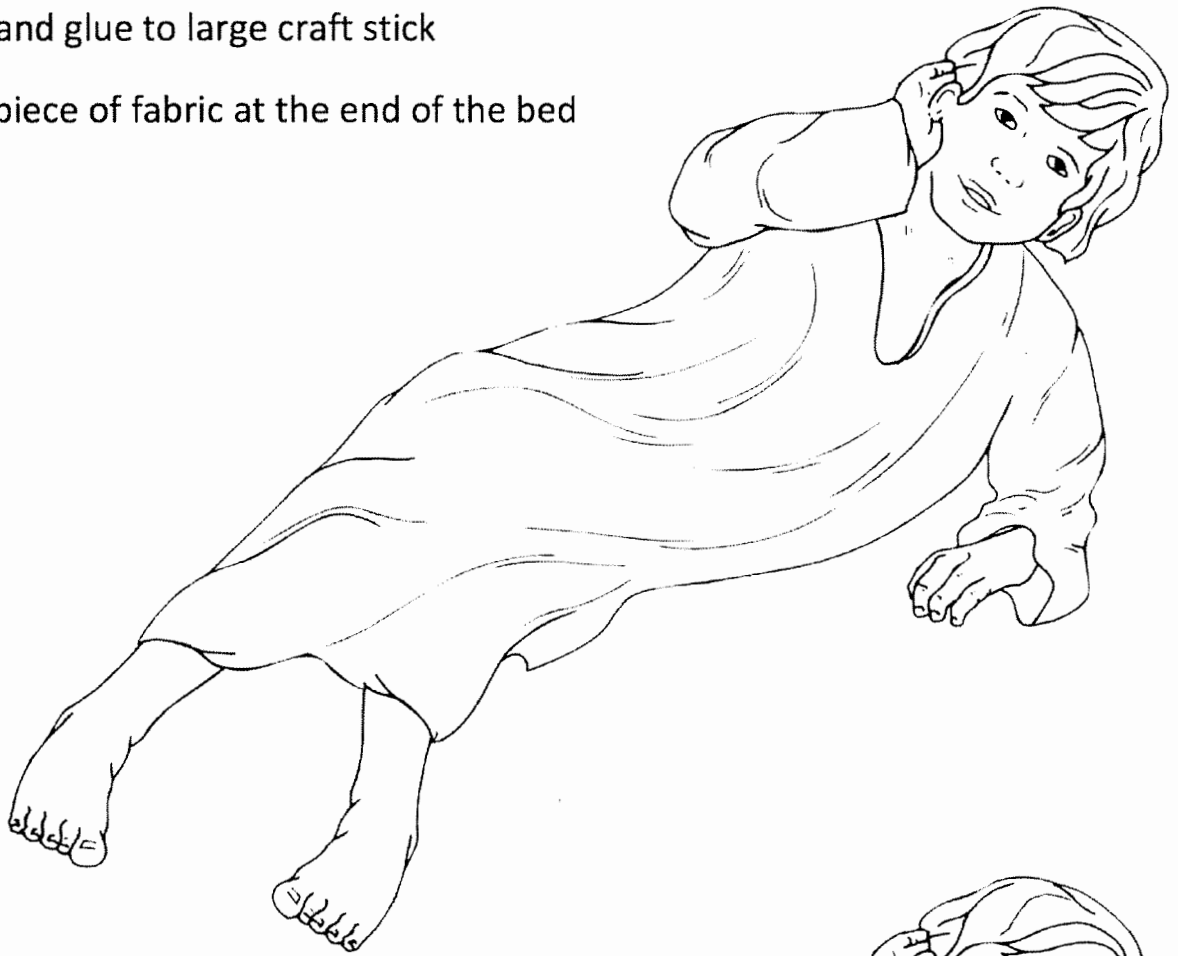



## Samuel and Eli Hand Puppets

### Supplies

- copies of the Samuel and Eli Hand Puppets (1 per child)
- crayons or washable markers
- scissors
- tape

### Directions

Help children color and cut apart the Samuel and Eli Hand Puppets. Fold the two pieces in half on the dotted lines and tape the sides together so each puppet fits on a child's hand like a mitten. Help each child put the Samuel puppet on one hand and the Eli puppet on the other hand. Children can use the puppets to retell the story of Samuel:

- 1) Samuel heard a voice calling his name (hold up Samuel).
- 2) Samuel went to Eli (hold up both Samuel and Eli and bring them together together).
- 3) Samuel heard the voice again and he answered God as Eli had told him to (hold up Samuel).

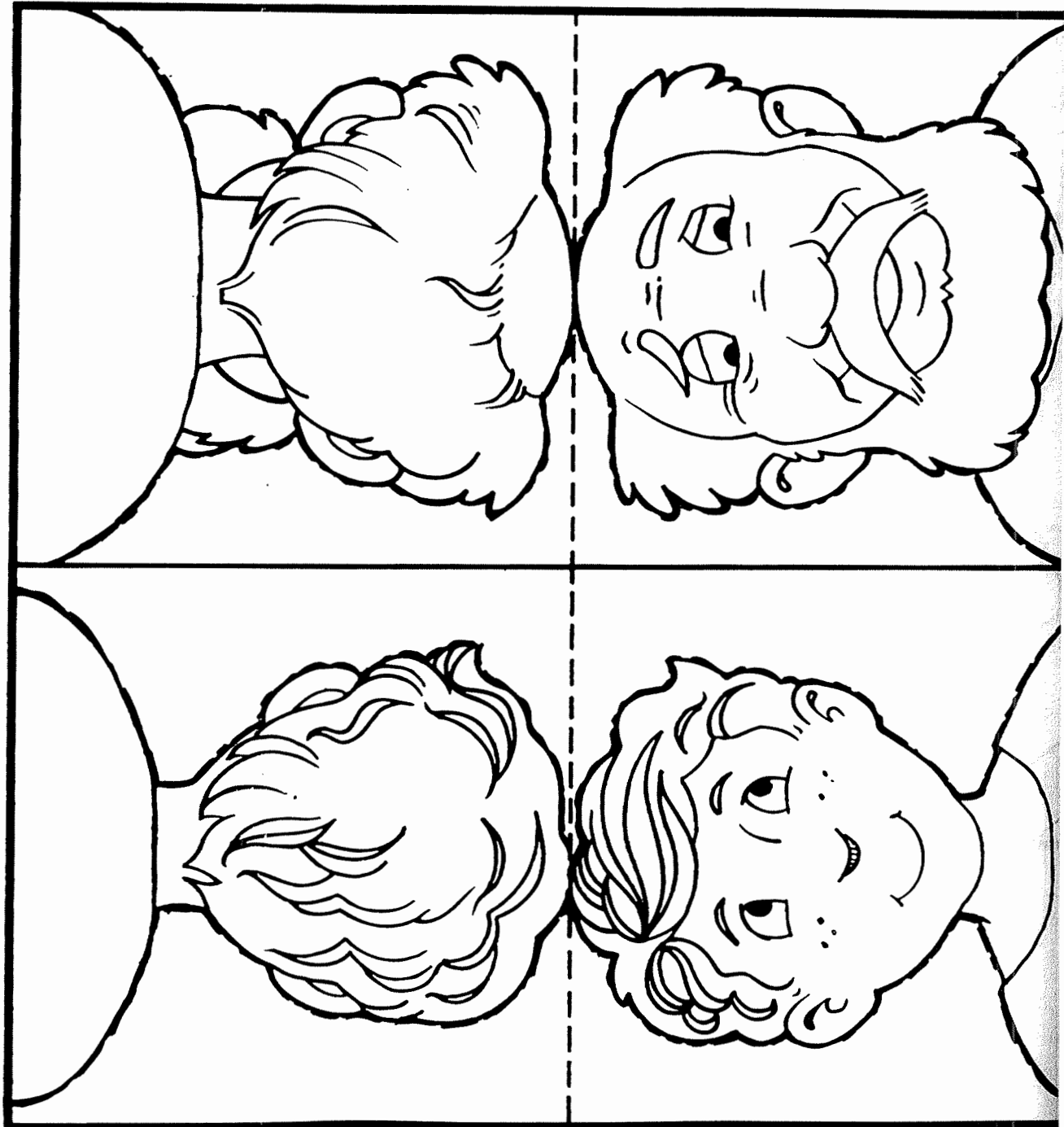

# Samuel Served in God's House Word Search



Find the words on the list that are hidden in the puzzle.  
The words can be left to right, up and down, or diagonally.

I	T	N	I	H	E	N	I	S	M	O	S
P	R	O	M	I	S	E	H	E	M	V	A
L	A	I	Q	N	O	N	A	R	C	T	M
T	M	E	D	O	N	D	N	V	I	Q	U
Z	O	U	F	P	U	G	N	E	E	V	E
L	T	A	B	E	R	N	A	C	L	E	L
S	H	M	I	L	R	I	H	A	I	V	E
L	E	S	I	K	L	A	E	A	C	I	D
U	R	T	A	A	A	T	U	S	R	I	T
L	O	R	E	N	T	E	M	D	T	T	O
R	O	B	E	A	N	S	E	Q	U	I	S
N	O	N	S	H	I	L	O	H	L	A	N

ELI  
ELKANAH  
HANNAH  
MOTHER

PRIEST  
PROMISE  
ROBE  
SAMUEL

SERVE  
SHILOH  
SON  
TABERNACLE

**Year 2**

**Week 66**

## **The Ark of God is Stolen**

**Scriptures: I Samuel 4**

**Key Verse: I Samuel 4:17** The man who brought news replied, “Israel fled before the Philistines, the army suffered heavy losses, also, your two sons, Hophni and Phinehas are dead and the ark of God has been captured.”

### **Key Points:**

1. The Israelites fought against the Philistines. They lost the battle because God had been displeased with them. The elders decided to go get the ark at the tabernacle at Shilo. They brought it to the battlefield for good luck, hoping it would help them win their battles. This was sinful idolatry. Eli’s sons, Hophni and Phinehas were with the ark.

2. When the ark came into camp there was great shouting. This made the Philistines afraid at first. They remembered how powerful the Israelite God was in Egypt (remind them of the plagues, etc) So they gathered their strength and defeated the Israelites in battle. The losses were great, 30,000 soldiers were killed.

3. The ark was captured in the battle, Hophni and Phinehas were killed as well. A messenger was sent to tell Eli about the battle.

5. Eli was 98 years old and very feeble. The messenger told him about the great number of soldiers killed, that his sons had died, and that the ark had been captured. Eli was sitting in a chair and was a heavy man. When the ark being captured was mentioned, he fell back in his chair, broke his neck and died.

6. Eli led Israel for 40 years before he died. Eli’s sons died because of their wickedness. We learn here that our sin draws us away from God.

# THE ARK OF GOD IS CAPTURED

*1 Samuel 4:1-18*



*The Philistines capture the Ark of the Lord's Covenant*

# THE CAPTURE & RETURN OF THE ARK (1 SAMUEL 4:1-7:2)

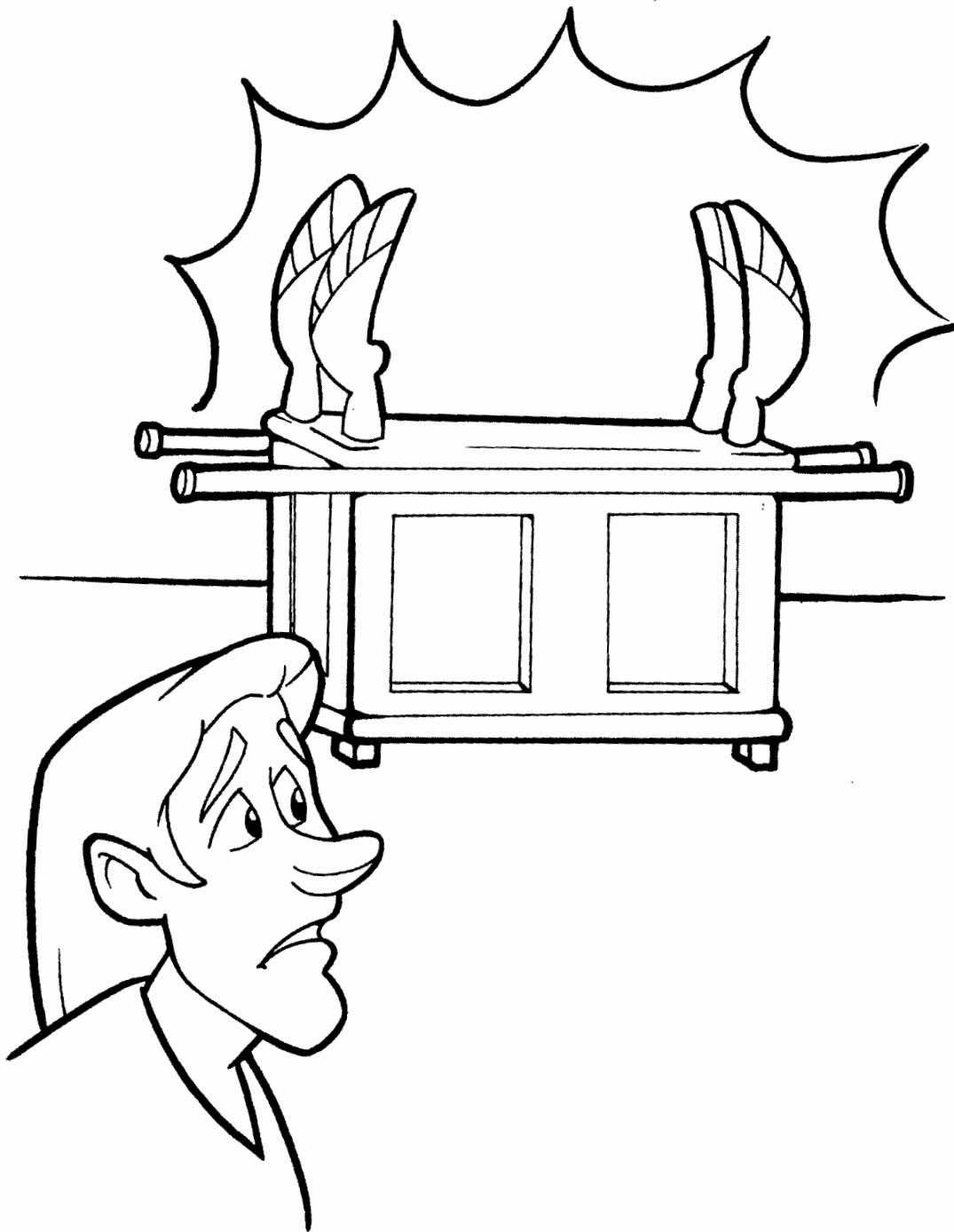

“And when they of Ashdod arose early on the morrow, behold, Dagon was fallen upon his face to the earth before the ark of the LORD. And they took Dagon, and set him in his place again.”  
1 SAMUEL 5:3



**ELI HEARS HIS SONS HAVE DIED IN BATTLE AND  
THE ARK OF THE COVENANT WAS CAPTURED**

*! SAMUEL 4:17*

*And he said, "What happened, my son?"*

*"So the messenger answered and said, "Israel has fled before the Philistines, and there has been a great slaughter among the people. Also your two sons, Hophni and Phinehas, are dead; and the ark of God has been captured."*

# THE ARK OF GOD IS CAPTURED

*1 Samuel 4:1-18*

## ARK PATTERN

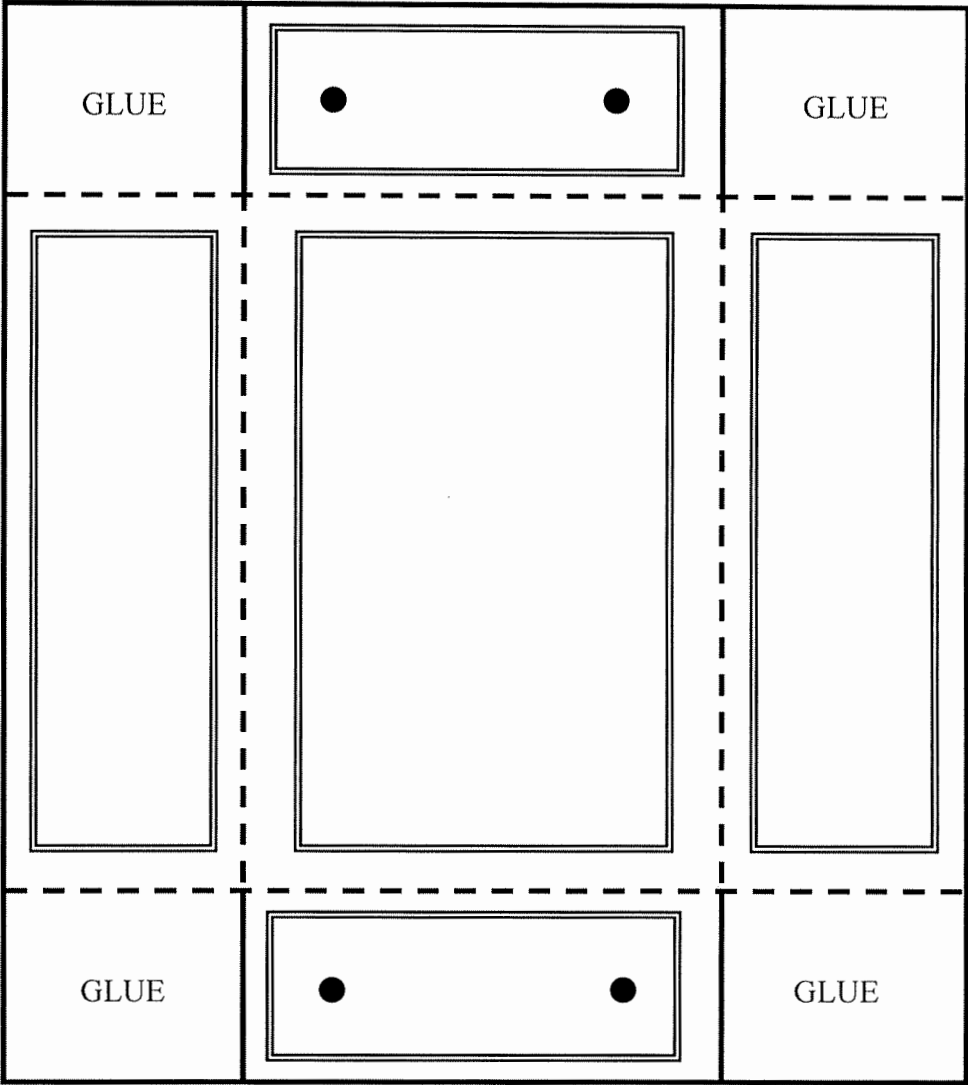

# ***CRAFT-STICK ARK OF COVENANT***

1. Print the template on card stock or construction paper.
2. Color and cut out the ark of the covenant template. Skip the coloring step by printing the template on gold construction paper.
3. Glue yellow colored popsicle sticks onto the template. You can also paint regular wooden popsicle sticks yellow using markers or paint.
4. If you desire, decorate the ark of the covenant using glitter.

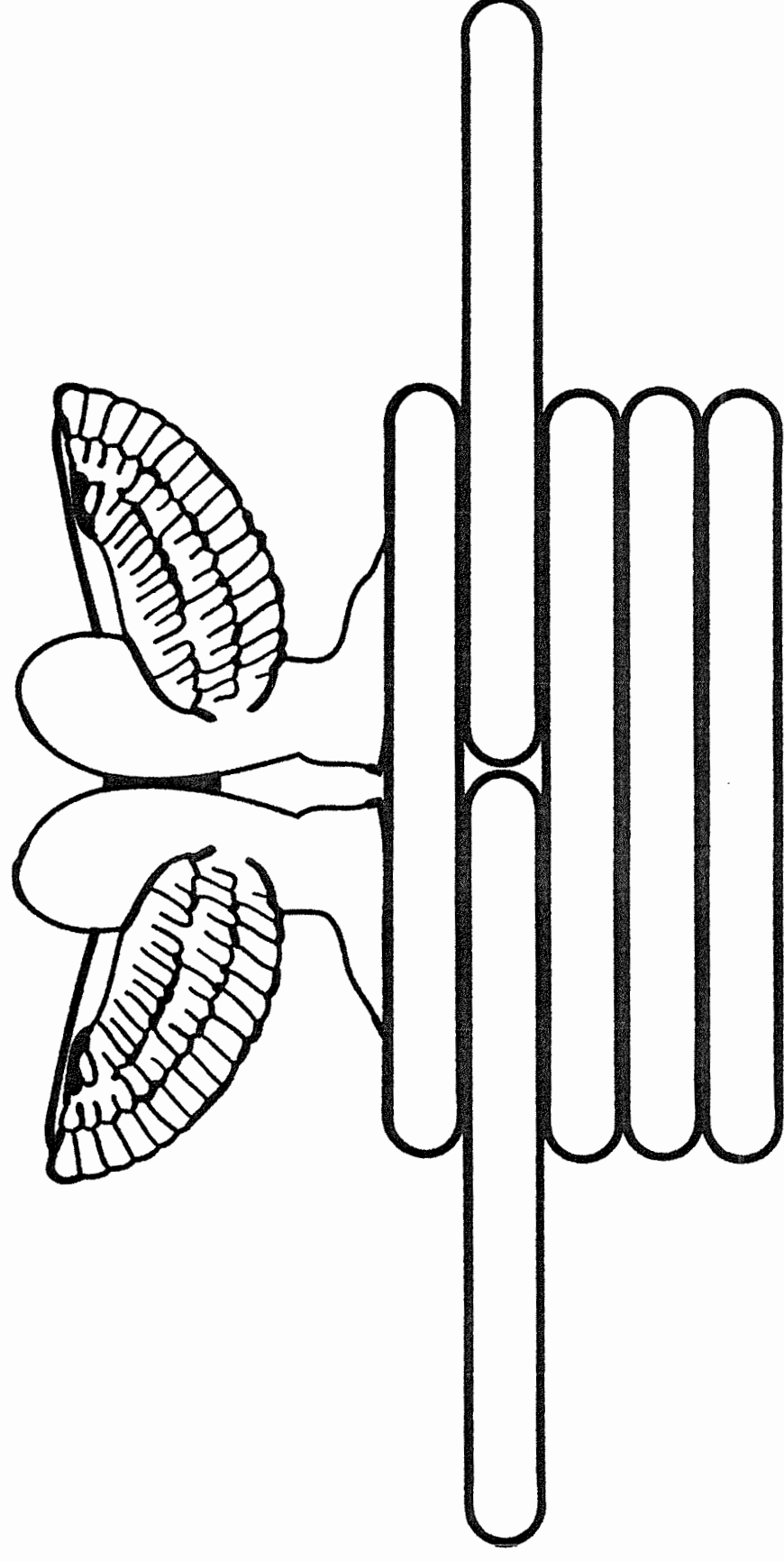



# Ark of the Covenant is Captured

## FILL IN THE BLANKS

The Philistines and the Israelites were \_\_\_\_\_ each other. About 4,000 \_\_\_\_\_ died. The leaders of Israel sent men to get the \_\_\_\_\_. The Philistines \_\_\_\_\_ the ark from the Israelites. Many more soldiers \_\_\_\_\_. When \_\_\_\_\_ found out what \_\_\_\_\_ happened, he died too.

Key: soldiers    fighting    took    died    Eli    ark

## QUESTIONS

When the Philistines and Israelites fought, who won?

What did the Israelites bring with them into battle?

Why do you think the Philistines took the ark of the covenant?

Why do you think the Lord allowed the Israelites to lose the battles?

# THE CAPTURE & RETURN OF THE ARK

(1 SAMUEL 4:1-7:2)

R L Z C Z B Y T W N H U K Q T  
V K O A S Q J N Q K I U S P R  
N D W P M R T D N O U T M N R  
G W E L H J E I S R A E L A W  
D V H T F I N G I B A T J Y P  
P J Q O A I L R N H F D T Q N  
K L I D M E D I T E F D A U K  
S W L D A C F E S S S Q A Q B  
P E H E Q G A E N T R S U T C  
P L T R S T O A D R I O E H D  
R V Y U A C S N A F U N M M W  
X D O T Q R L Z L V T T E U K  
O D A P V J K E B I Q C E S T  
A F R A I D P M Z O H U E R I  
S Z V C P W U D Z N A J N T E

AFRAID  
ARK  
CAPTURED  
DAGON

DEFEATED  
ISRAEL  
MESSENGERS

PHILISTINES  
RETURNED  
TUMORS





# THE CAPTURE & RETURN OF THE ARK

## (1 SAMUEL 4:1-7:2)

### MEMORY VERSE:

"And the men of Beth Shemesh said, 'Who is able to stand before this holy LORD God?' " 1 SAMUEL 6:20

### FILL IN THE BLANKS:

1. "Now Israel went out to battle against the \_\_\_\_\_." 1 SAMUEL 4:1
2. "And when they joined battle, Israel was \_\_\_\_\_ by the Philistines." 1 SAMUEL 4:2
3. The elders of Israel said, "Let us bring the \_\_\_\_\_ of the covenant of the LORD from Shiloh to us, that when it comes among us it may save us from the hand of our enemies." 1 SAMUEL 4:3
4. "When the ark of the covenant of the LORD came into the camp, all Israel shouted so loudly that the \_\_\_\_\_ shook." 1 SAMUEL 4:5

### TRUE OR FALSE:

5. "So the Philistines were afraid, for they said, 'God has come into the camp!' And they said, 'Woe to us! For such a thing has never happened before.'" 1 SAMUEL 4:7  
TRUE OR FALSE
6. So the Philistines gave up and ran for their lives. 1 SAMUEL 4:9-10  
TRUE OR FALSE
7. "The ark of God was captured; and the two sons of Eli, Hophni and Phinehas, died." 1 SAMUEL 4:11  
TRUE OR FALSE
8. "And when the Philistines took the ark of God, they brought it into the house of Dagon and set it by Dagon." 1 SAMUEL 5:2  
TRUE OR FALSE

### FILL IN THE BLANKS:

9. "When the people of Ashod arose early in the morning, there was Dagon, fallen on its \_\_\_\_\_ to the earth before the ark of the LORD. So they took Dagon and set it in its place again." 1 SAMUEL 5:3
10. "The hand of the LORD was heavy on the people of Ashod, and He ravaged them and struck them with \_\_\_\_\_, both Ashod and its territory." 1 SAMUEL 5:6
11. After the ark brought destruction upon Gath, it was sent to Ekron and the people "sent and gathered together all the lords of the Philistines, and said, "Send away the ark of the God of Israel, and let it go back to its own place, so that it does not \_\_\_\_\_ us or our people." 1 SAMUEL 5:11

### TRUE OR FALSE:

12. "So they sent messengers to the inhabitants of Kirjath Jearim, saying, 'The Philistines have brought back the ark of the LORD; come down and take it up with you.'" 1 SAMUEL 6:21  
TRUE OR FALSE

# THE CAPTURE & RETURN OF THE ARK

## (1 SAMUEL 4:1-7:2)

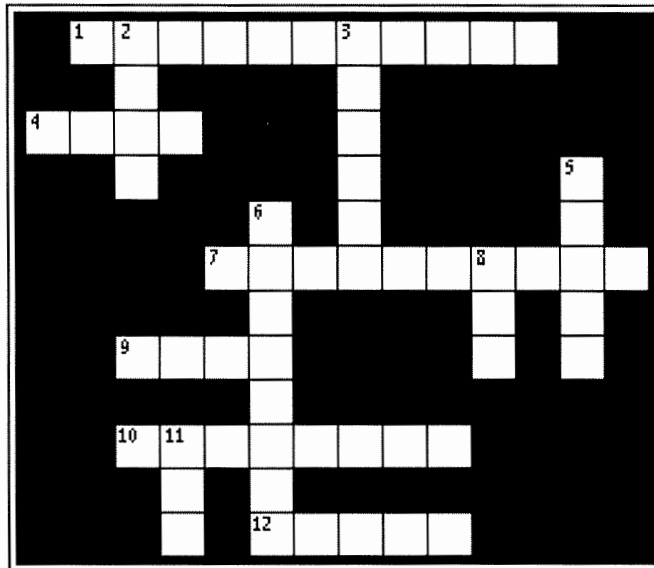

- 1 ACROSS "Now Israel went out to battle against the \_\_\_\_." **1 SAMUEL 4:1**
- 6 DOWN "And when they joined battle, Israel was \_\_\_\_ by the Philistines." **1 SAMUEL 4:2**
- 11 DOWN The elders of Israel said, "Let us bring the \_\_\_\_ of the covenant of the LORD from Shiloh to us, that when it comes among us it may save us from the hand of our enemies." **1 SAMUEL 4:3**
- 5 DOWN "When the ark of the covenant of the LORD came into the camp, all Israel shouted so loudly that the \_\_\_\_ shook." **1 SAMUEL 4:5**
- 8 DOWN "So the Philistines were afraid, for they said, '\_\_\_\_ has come into the camp!' And they said, 'Woe to us! For such a thing has never happened before.'" **1 SAMUEL 4:7**
- 10 ACROSS "The ark of God was \_\_\_\_; and the two sons of Eli, Hophni and Phinehas, died." **1 SAMUEL 4:11**
- 12 ACROSS "And when the Philistines took the ark of God, they brought it into the house of \_\_\_\_ and set it by Dagon." **1 SAMUEL 5:2**
- 9 ACROSS "When the people of Ashod arose early in the morning, there was Dagon, fallen on its \_\_\_\_ to the earth before the ark of the LORD." **1 SAMUEL 5:3**
- 3 DOWN "The hand of the LORD was heavy on the people of Ashod, and He ravaged them and struck them with \_\_\_\_, both Ashod and its territory." **1 SAMUEL 5:6**
- 4 ACROSS "Send away the ark of the God of Israel, and let it go back to its own place, so that it does not \_\_\_\_ us or our people." **1 SAMUEL 5:11**
- 2 DOWN "And the men of Beth Shemesh said, 'Who is able to stand before this \_\_\_\_ LORD God?'" **1 SAMUEL 6:20**
- 7 ACROSS "So they sent \_\_\_\_ to the inhabitants of Kirjath Jearim" **1 SAMUEL 6:21**

# THE ARK OF GOD IS CAPTURED

## *1 Samuel 4:1-18*

Read the story below about how the ark of the Lord's covenant was stolen. Then find and circle the capitalized words in the word search. Look across, down, and diagonally. Circle the word TRIP twice.

The ISRAELITES were at WAR with the PHILISTINES. At that time, the Israelites did not LOVE GOD as they should. They did not HEAR His words and obey them. Because of their SIN, God did not help them fight. The Philistines DEFEATED them in a BATTLE, killing 4,000 of their soldiers. At their CAMP, the Israelites said, "Let's take the ARK of God WITH us to battle. IT will help us fight."

The Israelites took the ark into the next battle, which was wrong. The ark belonged in the TABERNACLE. Again, the Israelites LOST, and 30,000 of their men were killed. Their ENEMIES TOOK the ark with them. That was ONE SAD DAY for the Israelites.

"We captured the ark of God of the Israelites!" the Philistines cried with GLEE. Then the ark took a long TRIP. It went to one of the Philistine's cities. They put it NEXT to their IDOL god, DAGON. Dagon fell down that NIGHT. They SET it up again. The next night, Dagon fell again, and its HANDS and HEAD broke off. Soon, many Philistines in that city got very SICK. "Take the ark away," they begged. "It brings TERRIBLE TROUBLE."

Then the ark took a TRIP to two other cities. Those people became very sick, too. "What shall we do?" they cried.

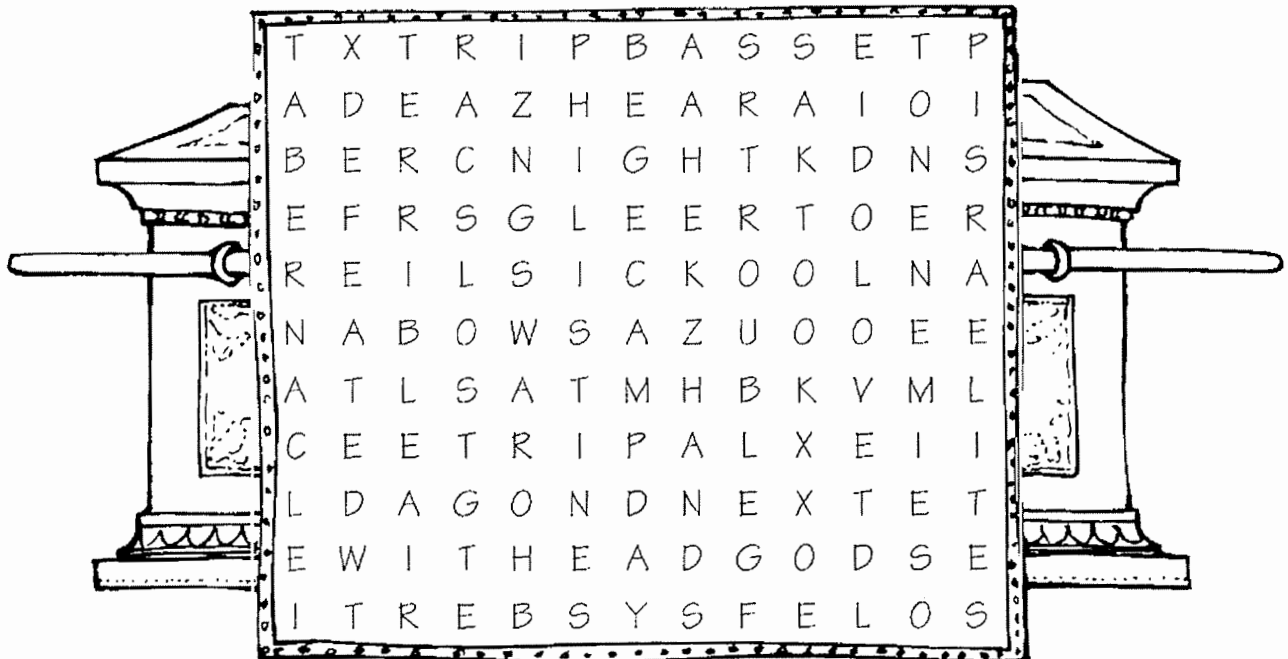

The ark did not take care of the sinning Israelites. If we sin, wearing a cross will not help us. To have Jesus' protection and help, He tells us to love Him truly and obey Him.

## **Year 2**

### **Week 67**

#### **The Ark is Returned**

**Scriptures: I Samuel 5, 6, 7**

**Key Verse: I Samuel 7:3** Samuel said, “If you are returning to the Lord with all your hearts, then rid yourselves of the foreign gods and the Ashtoreths and commit yourselves to the Lord and serve him only and he will deliver you out of the hand of the Philistines.

#### **Key Points:**

1. Philistines took the ark of the covenant, thinking it would help them in battle. They brought the ark to their idol’s temple of Dagon. Early the next day, Dagon had fallen on its face before the ark. They set it up again, the next day it had fallen again, breaking off its head and palms of its hands. The people of that city were struck with tumors and rats destroyed their fields, proving God was more powerful than their god, Dagon.

2. Philistines sent the ark away to other cities, each city being struck with tumors and rats. It had been in Philistine territory for seven months when the priests decided to get rid of the ark and the trouble it was causing.

3. They put golden tumors and gold rats in the ark as a trespass offering (apology) for taking the ark. They built a new cart for the ark and put the cart on two milk cows that had never been yoked. Sending it on its way, they watched to see that it went toward the land of the Israelites.

4. The ark came to Beth Shemesh. People looked inside and saw the tumors and rats. The cart was cut for firewood and cows sacrificed as burnt offerings to the Lord, along with the golden tumors and rats. 70 men died looking into the ark.

5. The ark was taken to Abinadab’s house where Eleazar, his son, was consecrated to watch over it. It remained there for many years.

6. Samuel told the Israelites to repent from their idolatry and evil ways. They did so, serving the Lord only. God then gave them victory over the Philistines.

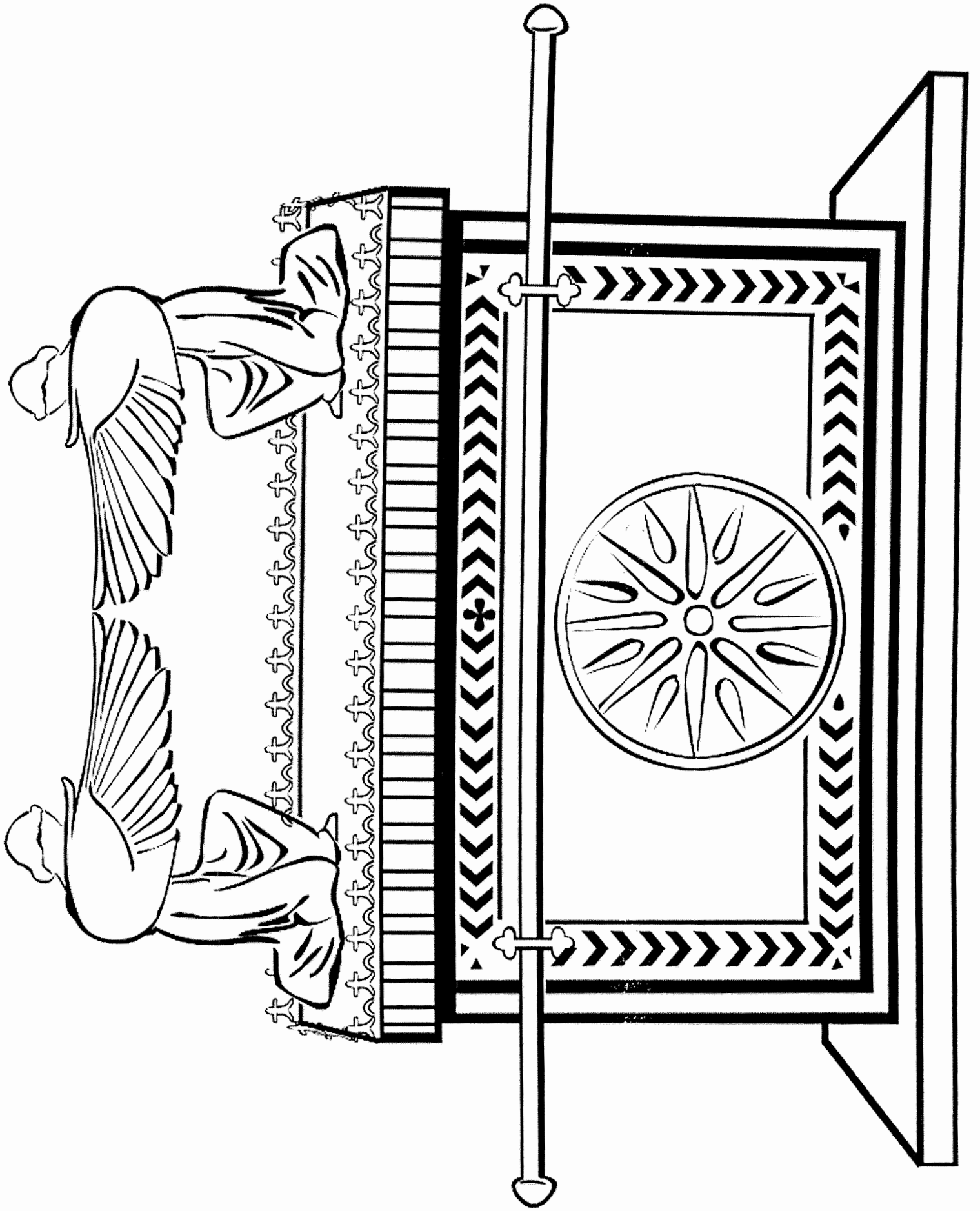





GOSPEL  
FRONT

1 SAMUEL 6:13

Now *the people of Beth Shemesh* were reaping their wheat harvest in the valley; and they lifted their eyes and saw the ark, and rejoiced to see *it*.

---

# DAGON vs. GOD

(1 Samuel 5:1-5)

The Philistines took the ark of God and brought it to the house of Dagon and set it by Dagon.

The next morning, Dagon had fallen on his face before the ark

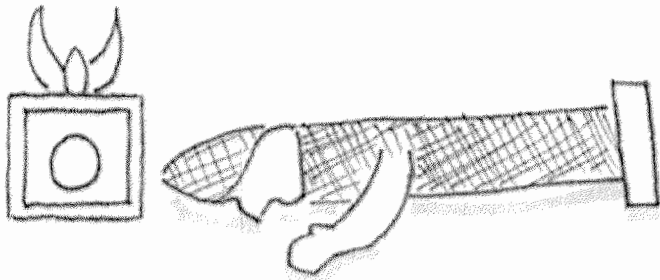

The next morning, after righting Dagon, the head and hands were cut

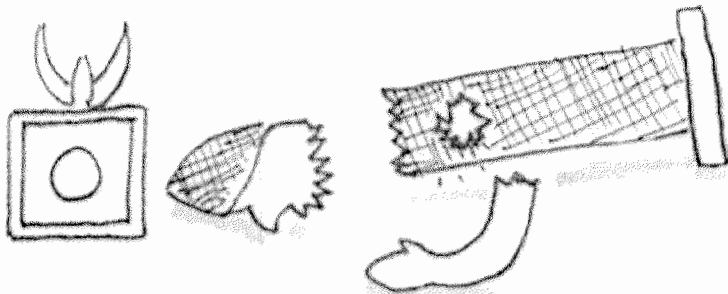

# GIVING BACK THE ARK

(1 Samuel 6:10-12)

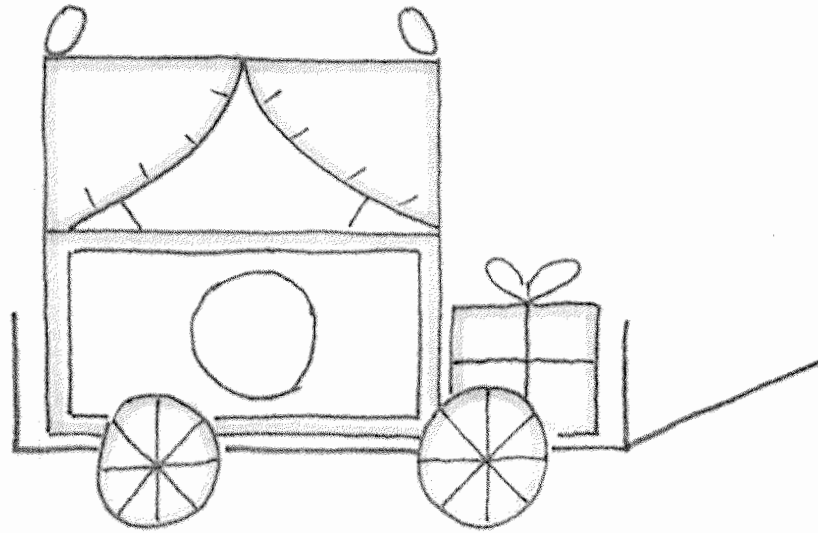

- They put the ark of the Lord on the cart along with the guilt offering
- And the cart went from Ekron to Beth-Shemesh,

which means  
House of the  
Sun

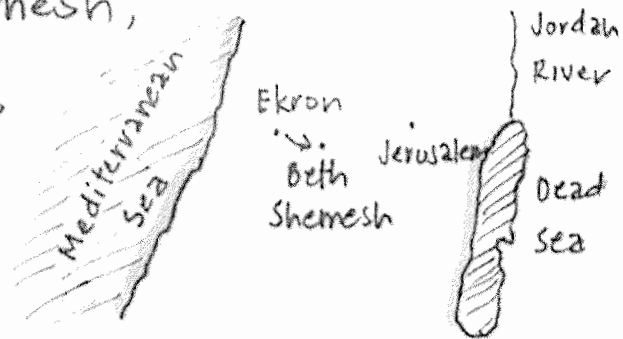

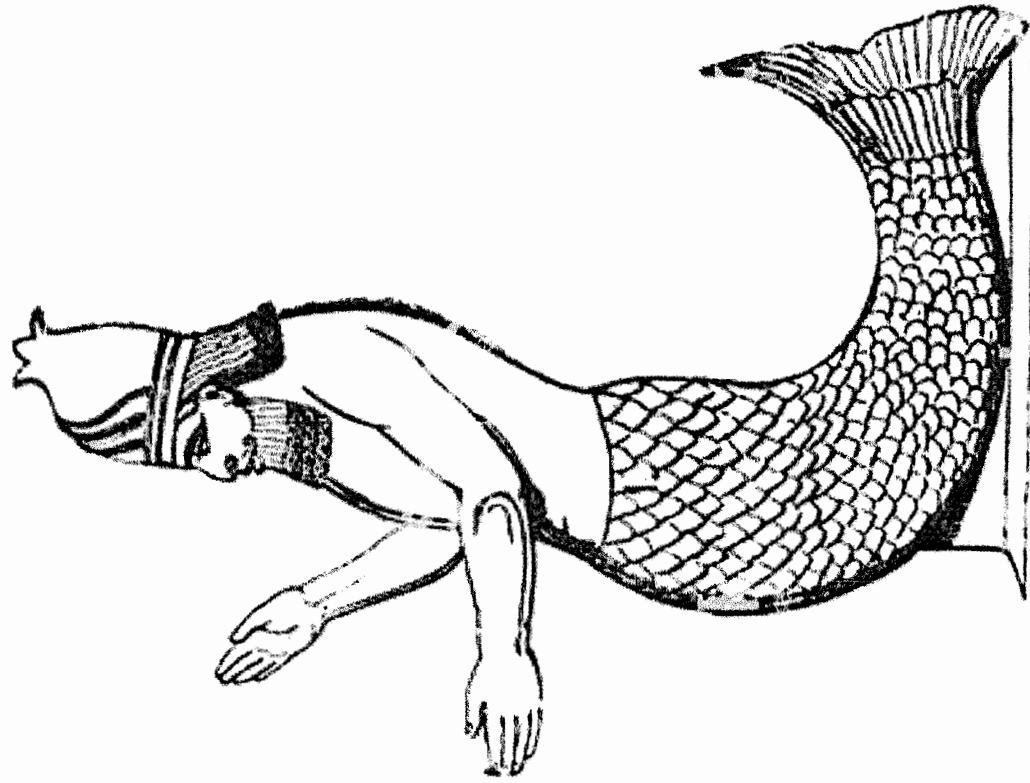
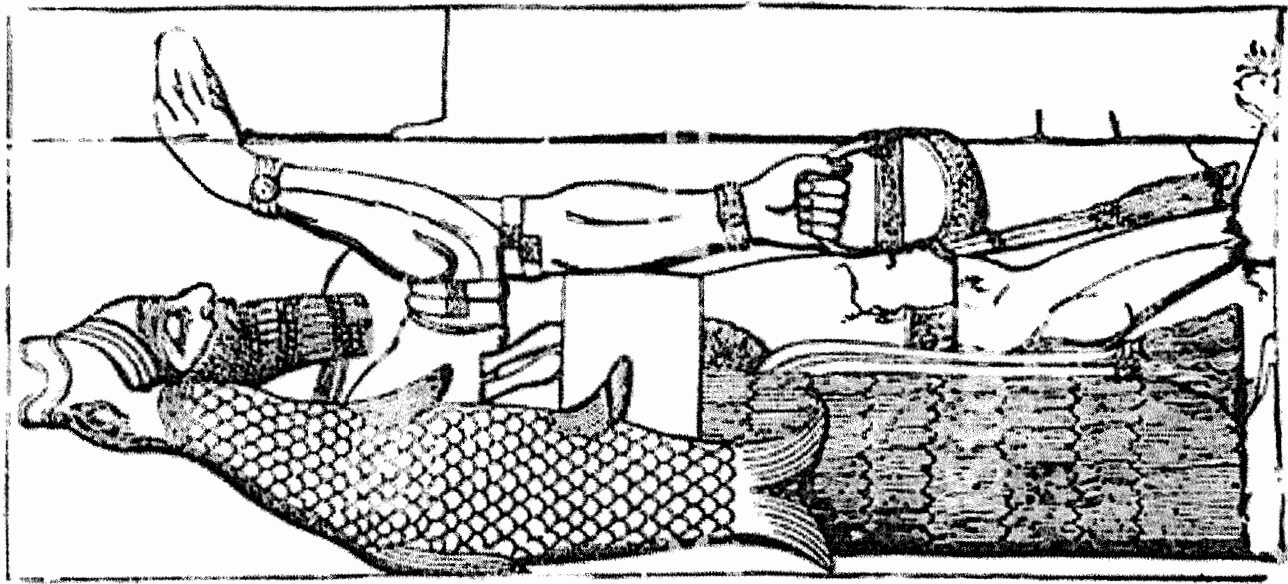
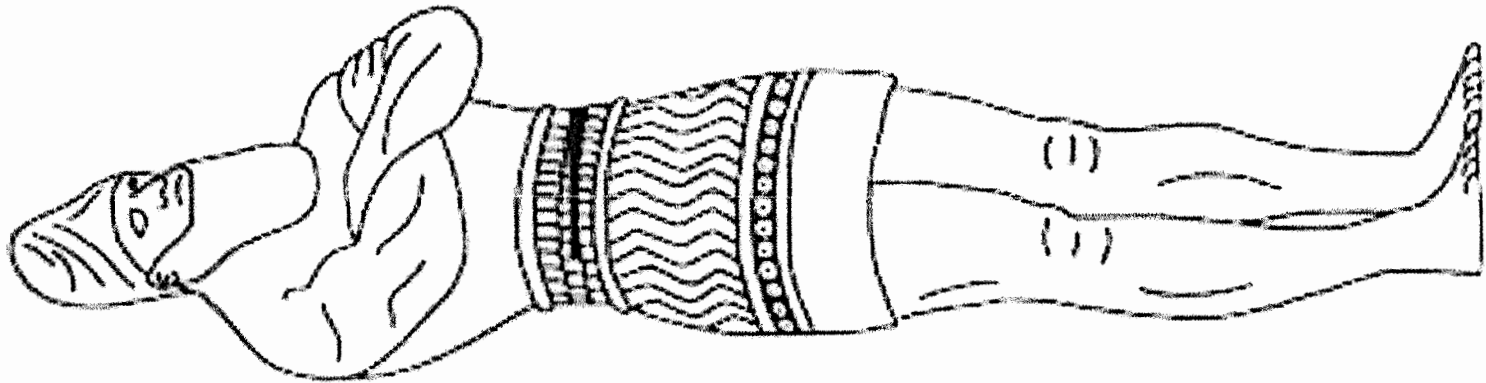

REPRESENTATIONS OF DAGON, THE FISH-GOD.

**Dagon, a god of the Philistines,  
falls on its face before the Ark of the Lord**



Help the Ark get back from the Philistines to Kirjath Jearim!!

Kirjath Jearim

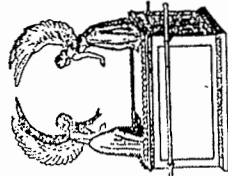
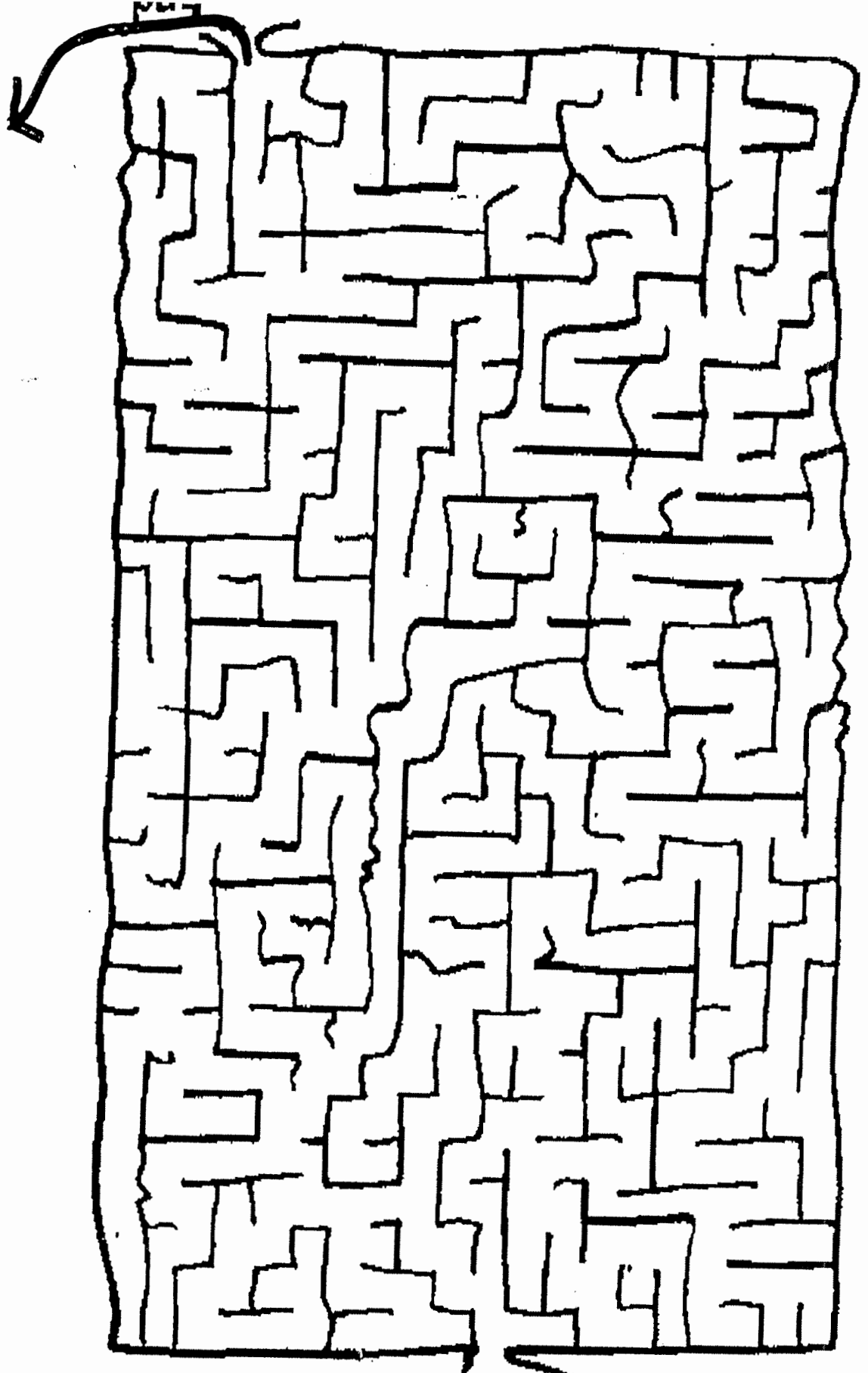

Start

## Ark is Returned to Israel

1 Samuel 7:1, 2

Then the men of Kirjath- Jearim came and took the ark of the Lord, and brought it into the house of Abinadab on the hill, and consecrated Eleazar his son to keep the ark of the Lord. So it was that the ark remained in Kirjath Jearim a long time; it was there twenty years. And all the house of Israel lamented after the Lord.

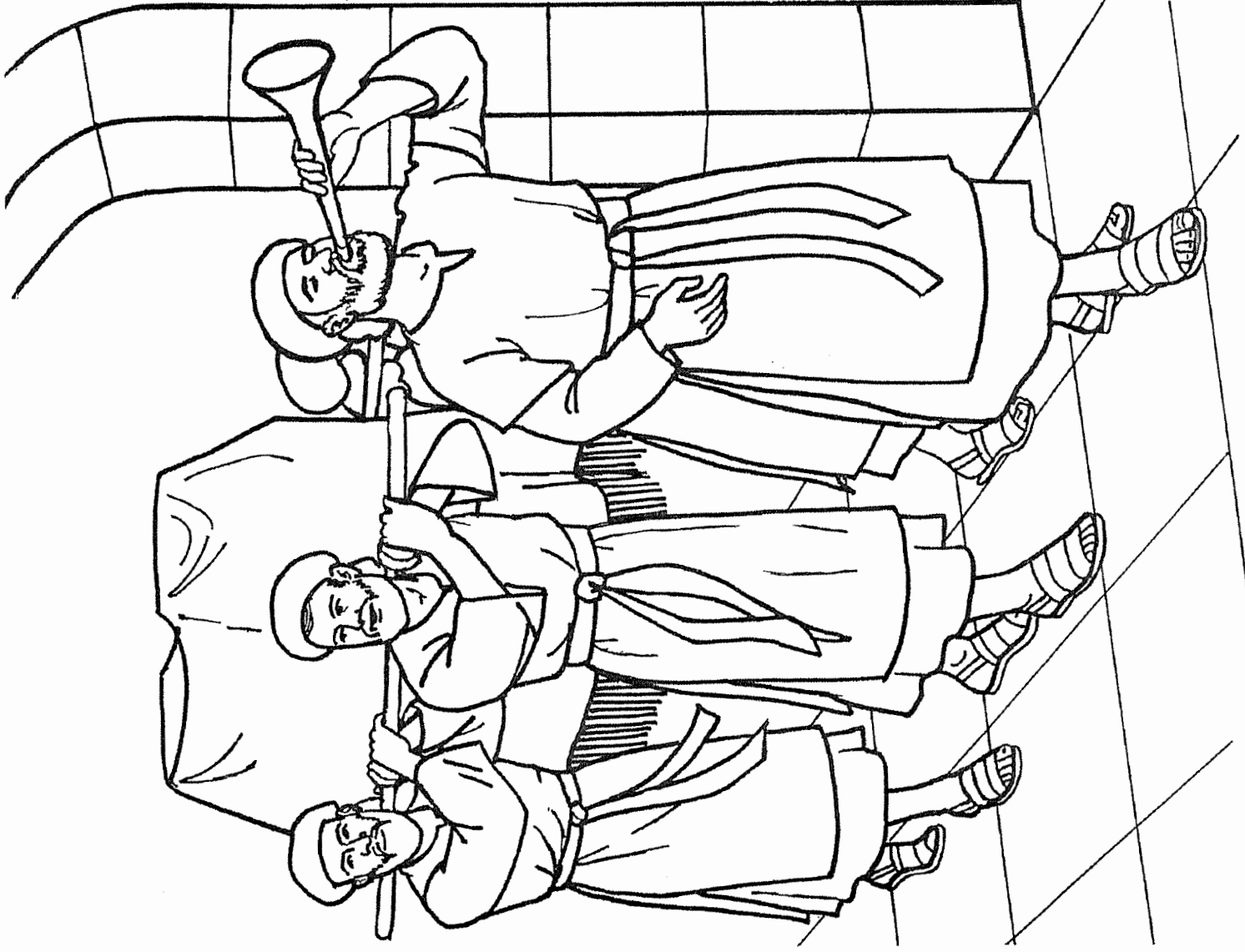



# The Return of the Ark

1 SAMUEL 6

ELI      ARK      GOD      BATTLE      SAMUEL

PHILISTINE      SICKNESS      ISRAELITE

DAGON      STATUE

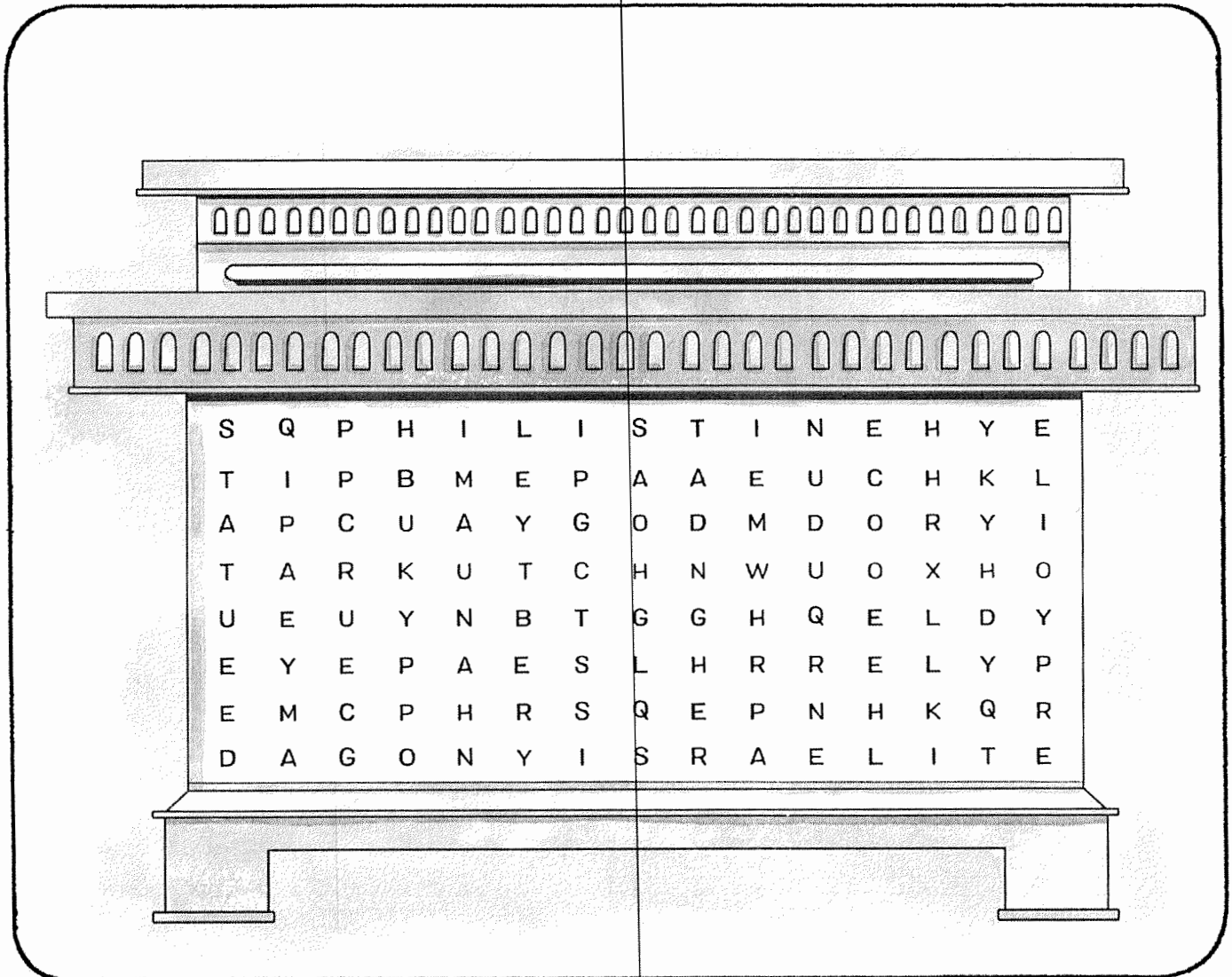



Name: \_\_\_\_\_

Date: \_\_\_\_\_

# Ark of the covenant

U Q D U H D G S C Y B I B L E J D Q J R L T S H  
A N C C C J B N C P I J J K B R J O S H U A C P  
W C T O P J G O G F W P R K E V P Y N X V L Y U  
F C E R E M E G O Y G G Z P C Z K Z Y Z O I O F  
D C A U Y N S A D J C R X U C Y T U C N Z X U Z  
T J A N C C C D K H V U M E K Z X Z R X O C P W  
Z I F U E L C A N R E B A T W X T H A P M K A O  
U U U R N J I T X C K H Q Z W M E A X L P G F I  
S U N O W O A E K Q A I C A C A K A N E F T M W  
R X L M N R O Q C Y W Z M O N I R Q B E O N B J  
N I D W Y F M G B T V E I T N K O R E L U H E B  
P C Q E F C A O F D W F C B C R N J L J R B S H  
F S K H R T W C Z R L U E O R U V G N L P I E W  
V V G R E Z I R Y A C F Q V A N Y Y Z S S A X D  
O A C A L V E S Z X A D Y N V Z L Q D T H Q T R  
Z B P A C S E L O P R F D T G R Q Q P S I Y H T  
W M C Z P T I V J D T E I V E T D S B E L R G M  
Y S O O G E H G T A L P R A K T K P D S O S Q S  
S E C P I Z X O L E A R S I P B R G M O H U Y R  
R V R I N K C L P T I A H C U L K U Y M A A W J  
X E R D E T X D F S E A K Z T H H V Q S K R A Q  
Z N G L U H B J N C B J Q J E L D E R S X R U S  
S R O M U T R I N G S A A L K F T C D W Q S L E  
N L J E H I K H O Z B K B V L O H M J C N M R H

Cart	Calves	Mice	Tumors
Israel	Ekron	Dagon	Shiloh
Joshua	Elders	Seven	Moses
Poles	Rings	Four	Gold
Acacia	Bible	Ark	Tabernacle

## The Ark is Returned to Israel!!

Answer the questions:

1. Why did the Philistines want to capture the Ark?
2. After it's capture, what city did the Philistines take the Ark?
3. What was the name of the idol they sat the Ark next to and what happened when they put it there?
4. What happened to the Philistines as a result of taking the Ark?
5. How long was the Ark in the territory of the Philistines?
6. What was the offering they put in the Ark because of their guilt?
7. What did they Israelites do with the cart/cows that carried the Ark?
8. How many men died for looking into the Ark and at its contents?

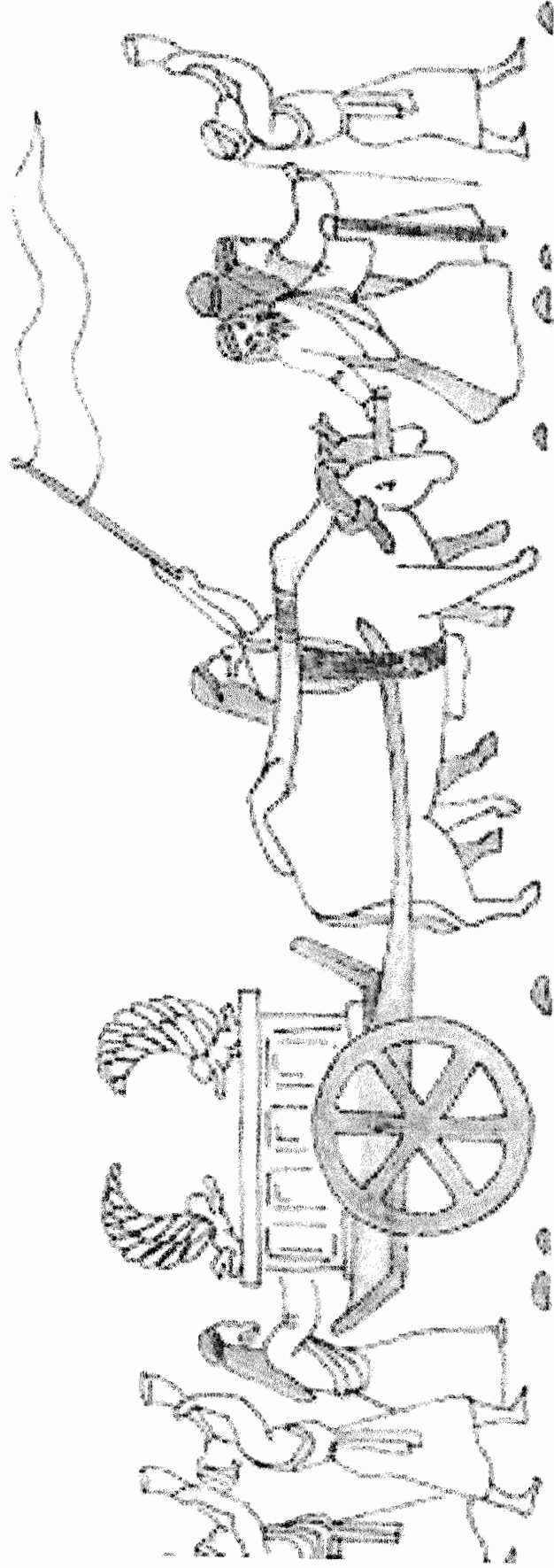

## **Year 2**

### **Week 68**

### **God Gives His People a King**

**Scriptures: I Samuel 8, 9, 10**

**Key Verse: I Samuel 10:19** ‘But you have now rejected your God, who saves you out of all your calamities and distresses. And you have said “No, set us a king over us.” So now present yourselves by your tribes and clans.’

#### **Key Points:**

**1.** When Samuel grew old he appointed his sons, Joel and Abijah, as judges. They did not walk with God, they were unruly and dishonest. Because of this, the elders of Israel begged for a king. They wanted a king as all the other nations had. This displeased Samuel, thinking they were rejecting him, but God told him it was HIM they were rejecting.

**2.** Samuel made it clear to the people what would happen if they had a king. (go over ch. 8:10-17) The people refused to listen. He went to the Lord and He told Samuel to let them have their way, give them a king.

**3.** A Benjamite man, named Kish, was an upstanding man. He had a son, Saul, an impressive man who stood head and shoulders taller than any others. His father sent him and his servants to search for some lost donkeys. They traveled a long way, searching. Fearing his father would be worried about them, Saul decided to return home but did not know which way to go. Hearing a man of God was in town, they went to Samuel for advice.

**4.** God had told Samuel he would send a man from the town of Benjamin, a few days before. Saul came to Samuel. As he sees him, he knows this is the man God had been talking about. He took him to a hall and gave him the seat of honor where about 30 were seated. He gave him meat to eat and Saul dined with Samuel.

**5.** They left the hall and walked down the edge of town. Samuel sent his servants on so he could give Saul a message from God. He took a flask of oil and poured it on Saul’s head, kissed him, anointing him as king. Saul was 30 years old.

**6.** Samuel told Saul all that would happen to him. God would change his heart and His Spirit would come to Saul in power, in prophesying, that he would be a different person. He told him when these things were fulfilled, he was to do whatever his hand found to do, for God would be with him.

**7.** Samuel gathered all the people of Israel together. He told them God had brought them out of Egypt and delivered them but they had rejected Him as their God. They had asked for a king so God was going to deliver one. Samuel had the tribes of Israel to present themselves. He called out the tribe of Benjamin. Then Saul, son of Kish was chosen. When they called him, he was not to be found. He was hiding in the baggage. They ran and brought him out and when he stood up, he was head and shoulders taller. The people shouted, "Long live the king!" There were some men who were troublemakers who despised Saul, they brought him no gifts but Saul kept silent.

**8.** God knew a king would not be good for Israel but they would not listen. We should be willing to read God's word and listen to what he has for us to do.



Saul was anointed by Samuel and became the first king of the Hebrews.

# SAUL IS MADE KING OF ISRAEL

(1 SAMUEL 9:1-12:25)



“And he had a son, whose name was Saul, a choice young man, and a goodly:  
and *there was not* among the children of Israel a goodlier person than he:  
from his shoulders and upward *he was higher* than any of the people.”

**1:SAMUEL 9:2**

# Samuel chooses a king.

1 Samuel 8:1—10:24



Bible Pathway  
Adventures

KING SAUL WORKSHEET



# SAMUEL ANOINTS SAUL

Fill in the blanks. Color the picture.

"Samuel took a flask of \_\_\_\_\_ and poured it on \_\_\_\_\_ head,  
kissed him and said, "Has not \_\_\_\_\_ anointed you to be prince  
over His \_\_\_\_\_ Israel?"

(1 Samuel 10:1)



For more free Bible resources and Teacher Packs including coloring pages,  
worksheets, quizzes and more visit our website at: [www.biblepathwayadventures.com](http://www.biblepathwayadventures.com)



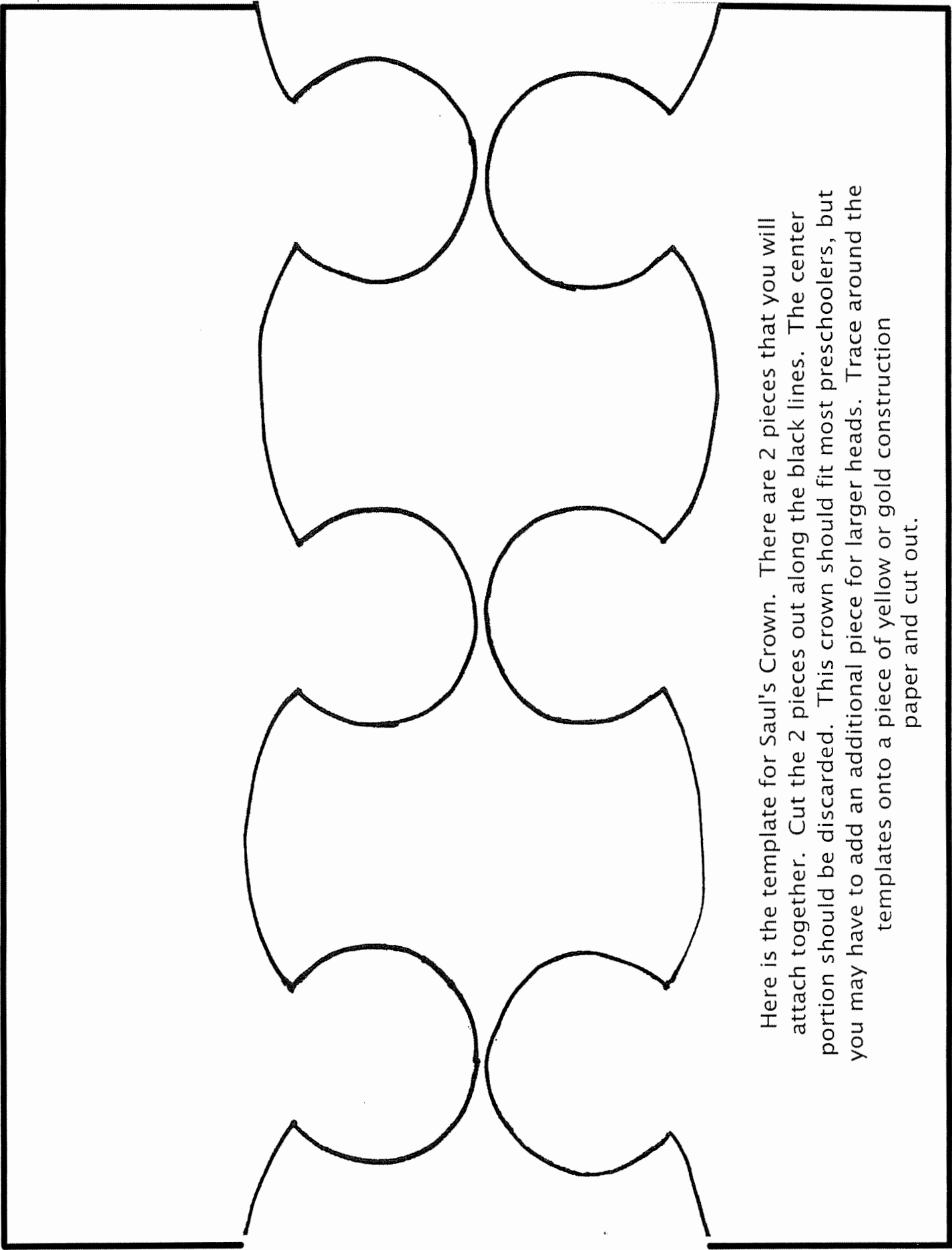

Here is the template for Saul's Crown. There are 2 pieces that you will attach together. Cut the 2 pieces out along the black lines. The center portion should be discarded. This crown should fit most preschoolers, but you may have to add an additional piece for larger heads. Trace around the templates onto a piece of yellow or gold construction paper and cut out.

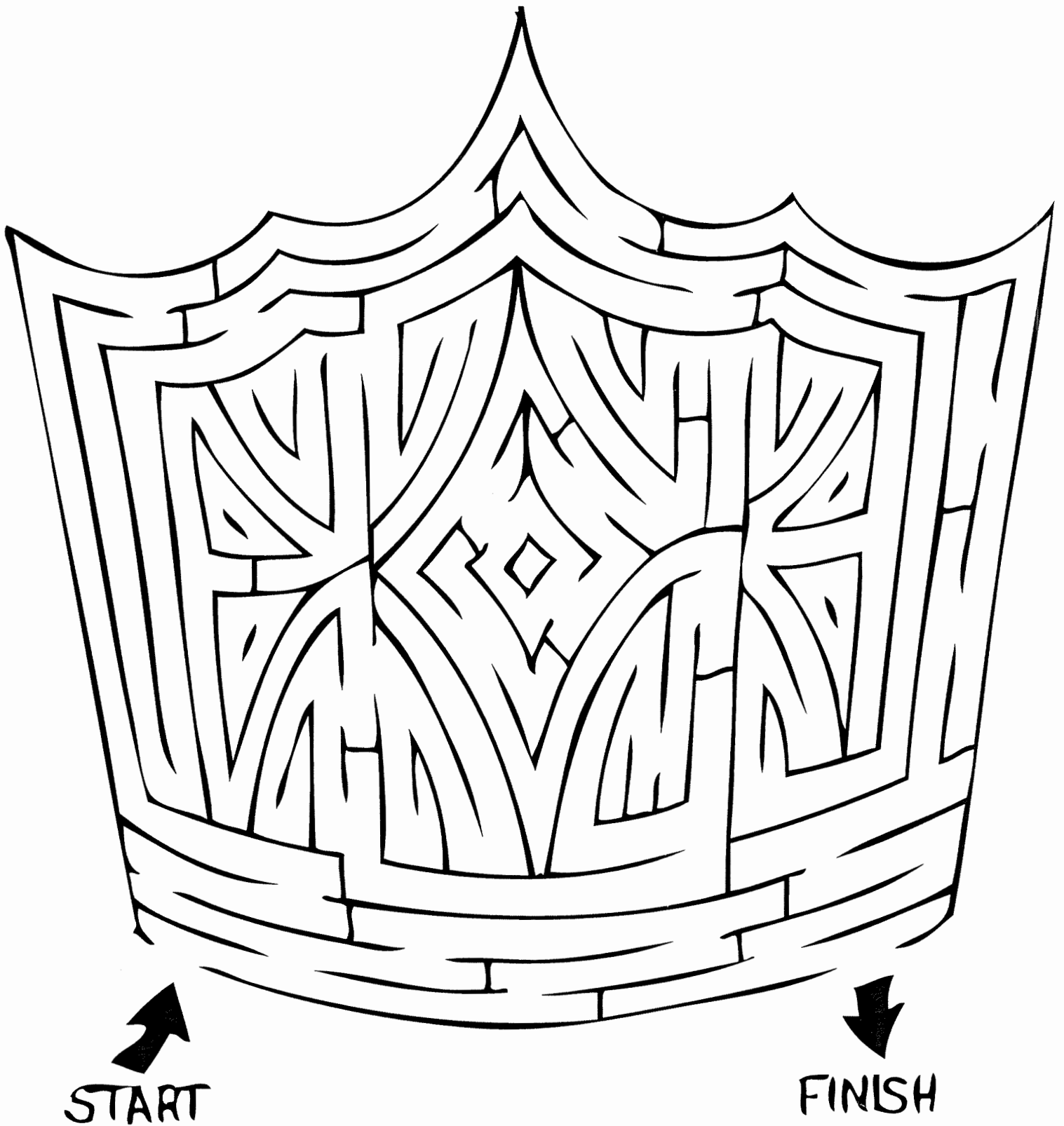

Taken from *Amazing Mazes for Kids* by Steve and Becky Miller, copyright © 1998 and published by Harvest House Publishers, Eugene, OR. Used by permission.



# SAUL IS MADE KING OF ISRAEL

(1 SAMUEL 9:1-12:25)

G W Z A M J J U D Z O Q Q U T  
D V O V E S B E N J A M I T E  
P H W C A M T T W N N H C E H  
K J A M O I O N Q K T S A E L  
S J U P Q M N S M O H A U N T  
P E H C Z C M D D B I U J Q T  
L W Q S S I D A I N U U K X R  
P E I A A T M E N T A T S N R  
R T L L Q U A R D D R H M A W  
X L A O V C L A T E M A J Y P  
O V H L K J S Z A H E E E Q N  
S D T Z L I L E L F A H N H K  
L D Y M P E N M B L F T T T B  
L O R D B W R G I V F D A U C  
K Z O F Q Y P O Z I T D A Q D

BENJAMITE  
COMMANDMENT  
HANDSOME  
HEART  
HEEDED

KING  
LEAST  
LORD  
MIZPAH

OIL  
SAMUEL  
SAUL  
TALLER

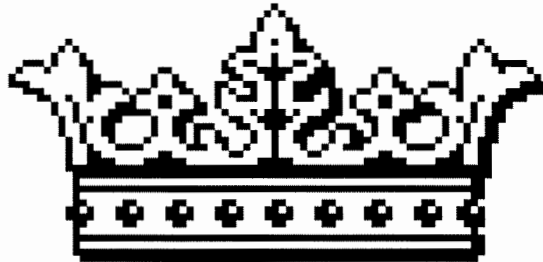

# God Chooses a King

But the LORD said to Samuel, "Do not consider his appearance or his height, for I have rejected him. The LORD does not look at the things people look at. People look at the outward appearance, but the LORD looks at the heart." 1 Samuel 16:7

Based on 1 Samuel 16:1-13



W R E J E C T E D A D X M Z T  
 B Z Q C U L T E B J N L B A H  
 J C A L A G D M I B A O O Z H  
 X E U S N Q C H O S E N I R L  
 P A A I S H E A R T J S S N D  
 S L K P V H C Q Q S Q T S Q T  
 F N D S P K E C W I A H I T I  
 S C O A Q E Q P S P H M U O O  
 Y M T C K O A L H M J D U I E  
 L R S R I J L R U E L F P E Q  
 O D C I S E I T A A R U U E L  
 O R V F R S B Y O N H D X H M  
 W G F I A S W O Z X C K G G I  
 P M G C E E P K O U T E Z Y K  
 R A T E L R H A M D A V I D Q

APPEARANCE	SAMUEL	CHOSEN	HEART	PEACE
REJECTED	DAVID	SHEPHERD	ANOINT	LORD
SAUL	ISRAEL	SACRIFICE	KING	JESSE

# God Chooses a King

But the LORD said to Samuel, "Do not consider his appearance or his height, for I have rejected him. The LORD does not look at the things people look at. People look at the outward appearance, but the LORD looks at the heart." 1 Samuel 16:7

Based on 1 Samuel 16:1-13

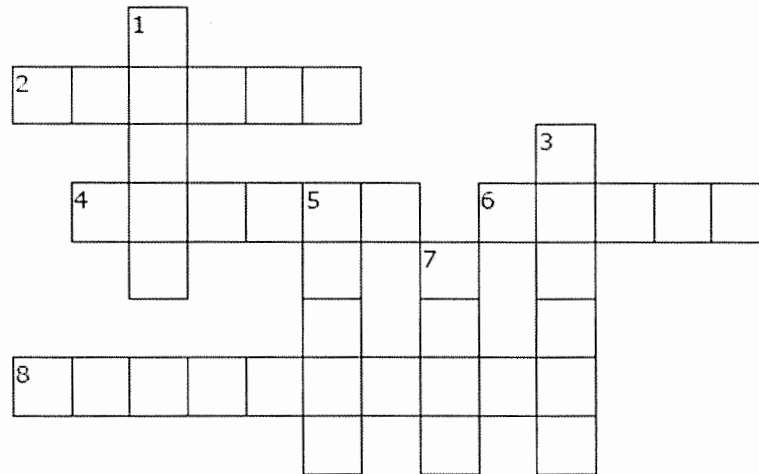

## ACROSS

2. To make someone holy by pouring oil on their head
4. Distance from the top to the bottom of something; how tall someone is
6. The one that God chose to replace Saul as king
8. The way people seem to be, rather than how they are inside

## DOWN

1. Strength, energy, or force
3. The Prophet that God instructed to go Jesse's house in search of the new king
5. The center of a person's emotions or the organ that pumps blood through the body
7. A man who rules a country

APPEARANCE  
SAMUEL

ANOINT  
KING

POWER  
HEIGHT

HEART  
DAVID

# God Chooses A New King

## ACROSS

1. Jesse brought his \_\_\_\_\_ to Samuel.
2. Saul was the king of what country?
3. What did Samuel pour over David's head?
4. Man looks on the outside, God looks on the \_\_\_\_\_?
5. Who was the king God rejected?
6. Who was David's father?
7. God told Samuel to sacrifice a \_\_\_\_\_.

## DOWN

1. God told \_\_\_\_\_ to anoint a new king.
2. God told Samuel to say, "I am come to \_\_\_\_\_ to the Lord."
3. David lived in what city?
4. Who did Samuel anoint as king?
5. Samuel was looking at a man's \_\_\_\_\_.
6. In the first story, Michael won the \_\_\_\_\_.
7. David had been watching the \_\_\_\_\_.
8. David became the new \_\_\_\_\_ of Israel.

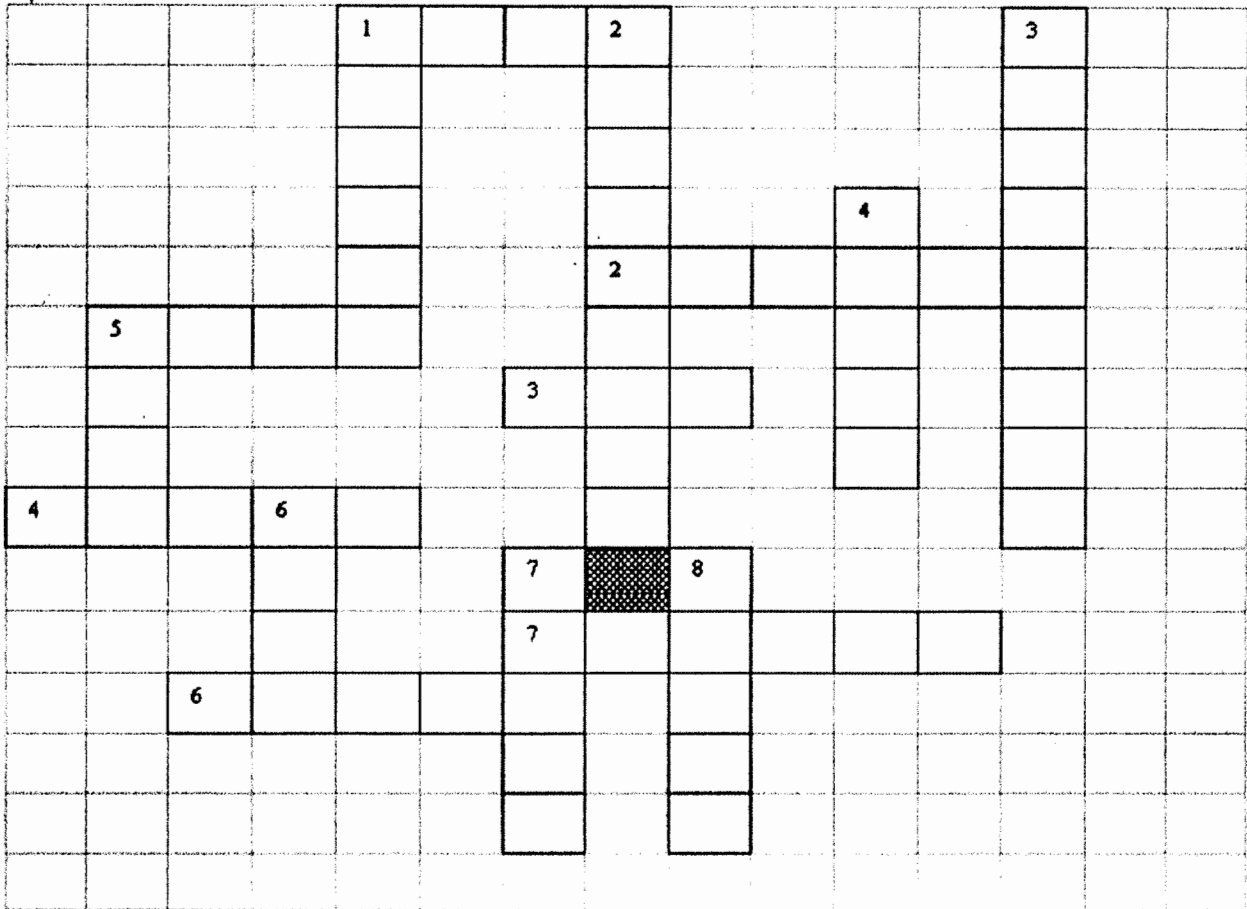

**List of Answers** - David, Jesse, Samuel, Saul, King, Oil, Lamb, Sheep, Size, Heart, Bethlehem, Sons, Israel, Sacrifice, Race

## A King for Israel:

The people of God wanted a king. God had always told them that they were special and that He was their King. But they insisted on having a human king like all the other nations. After being warned, God allowed them to have Saul as their first king. Many of the kings who came after Saul were evil and led the people away from God. The Israelites wanted something that was not good for them – they should have listened to God!

Follow the trail of crowns to get to King Saul – the first one is dark to show where to begin.

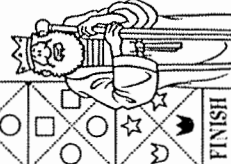
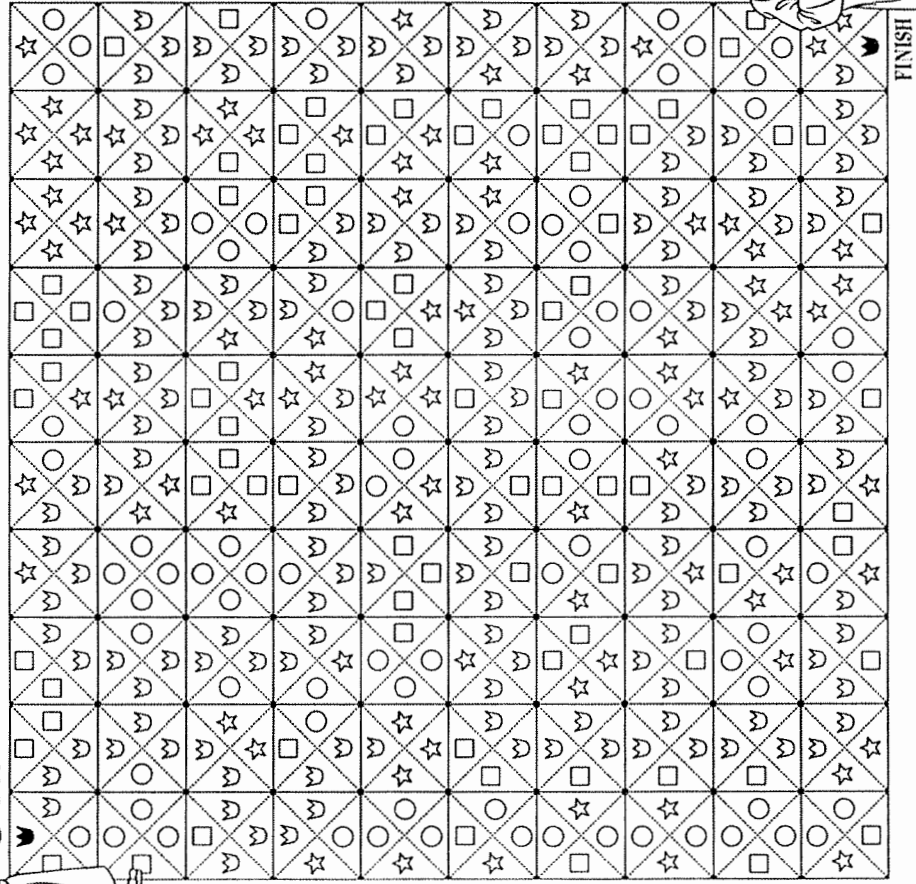
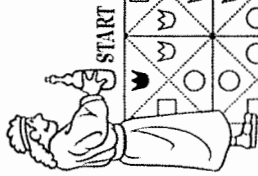

## SAUL IS ANOINTED

Hint: Look for help in I Samuel 10

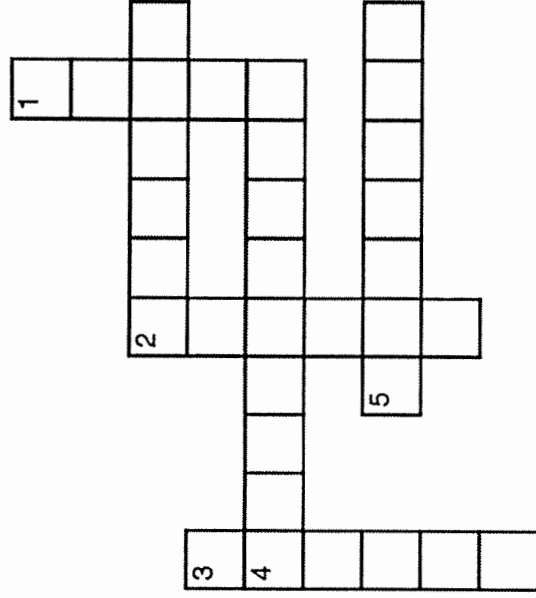

### ACROSS

- 2 \_\_\_ told Saul what he must do
- 4 Samuel \_\_\_ Saul with oil
- 5 Saul joined the prophets who were \_\_\_ and praising God

### DOWN

- 1 Samuel told Saul he would meet three men carrying three loaves of \_\_\_
- 2 Samuel told Saul the Lord's \_\_\_ would fall upon him
- 3 Saul was to go to the tomb where \_\_\_ was buried



# SAUL IS MADE KING OF ISRAEL

## (1 SAMUEL 9:1-12:25)

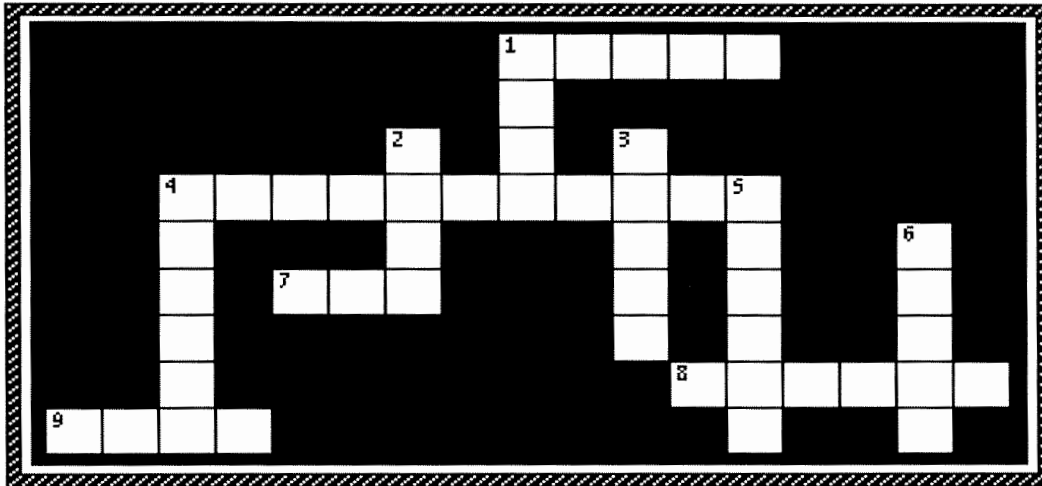

- 5 DOWN "There was not a more handsome person than he among the children of Israel. From his shoulders upward he was \_\_\_\_\_ than any of the people." **1: SAMUEL 9:2**
- 2 DOWN "When Samuel saw \_\_\_\_\_, the LORD said to him, 'There he is, the man of whom I spoke to you. This one shall reign over My people.'" **1 SAMUEL 9:17**
- 1 ACROSS "Saul answered and said, 'Am I not a Benjamite, of the smallest of the tribes of Israel, and my family the \_\_\_\_\_ of all the families of the tribe of Benjamin?'" **1 SAMUEL 9:21**
- 7 ACROSS "Samuel took a flask of \_\_\_\_\_ and poured it on his head." **1 SAMUEL 10:1**
- 1 DOWN "Then Samuel called the people together to the \_\_\_\_\_ at Mizpah." **1 SAMUEL 10:17**
- 9 ACROSS "But you have today rejected your God, who Himself saved you from all your adversities and your tribulations; and you have said to Him, 'No, set a \_\_\_\_\_ over us!' Now therefore, present yourselves before the LORD by your tribes and by your clans." **1 SAMUEL 10:19**
- 4 DOWN "Samuel said to all the people, 'Do you see him whom the LORD has \_\_\_\_\_, that there is no one like him among all the people?' So all the people shouted and said, 'Long live the king!'" **1 SAMUEL 10:24**
- 8 ACROSS "Now Samuel said to all Israel, 'Indeed I have \_\_\_\_\_ your voice in all that you said to me, and have made a king over you.'" **1 SAMUEL 12:1**
- 4 ACROSS Samuel said to the people, "If you fear the LORD and serve Him and obey His voice, and do not rebel against the \_\_\_\_\_ of the LORD, then both you and the king who reigns over you will continue following the LORD your God." **1 SAMUEL 12:14**
- 6 DOWN "However, if you do not obey the voice of the LORD, but \_\_\_\_\_ against the commandment of the LORD, then the hand of the LORD will be against you, as it was against your fathers." **1 SAMUEL 12:15**
- 3 DOWN "Only fear the LORD, and serve Him in truth with all your \_\_\_\_\_; for consider what great things He has done for you." **1 SAMUEL 12:24**

# SAUL IS MADE KING OF ISRAEL

## (1 SAMUEL 9:1-12:25)

### MEMORY VERSE:

*"Only fear the LORD, and serve Him in truth with all your heart; for consider what great things He has done for you." 1 SAMUEL 12:24*

### FILL IN THE BLANKS:

1. Saul was "a choice and handsome young man. There was not a more handsome person than he among the children of Israel. From his shoulders upward he was \_\_\_\_\_ than any of the people." **1:SAMUEL 9:2**
2. "When Samuel saw Saul, the LORD said to him, 'There he is, the man of whom I spoke to you. This one shall \_\_\_\_\_ over My people.'" **1 SAMUEL 9:17**
3. "Saul answered and said, 'Am I not a Benjamite, of the \_\_\_\_\_ of the tribes of Israel, and my family the \_\_\_\_\_ of all the families of the tribe of Benjamin?'" **1 SAMUEL 9:21**

### TRUE OR FALSE:

4. "Samuel took a flask of oil and poured it on his head." **1 SAMUEL 10:1**  
**TRUE OR FALSE**

### FILL IN THE BLANKS:

5. "Then Samuel called the people together to the LORD at Mizpah, and said to the children of Israel, 'I brought up Israel out of Egypt, and delivered you from the hand of the Egyptians and from the hand of \_\_\_\_\_ kingdoms and from those who oppressed you.'" **1 SAMUEL 10:17-18**
6. "But you have today rejected your God, who Himself saved you from all your adversities and your tribulations; and you have said to Him, 'No, set a \_\_\_\_\_ over us!' Now therefore, present yourselves before the LORD by your tribes and by your clans." **1 SAMUEL 10:19**
7. "Samuel said to all the people, 'Do you see him whom the \_\_\_\_\_ has chosen, that there is no one like him among all the people?' So all the people shouted and said, 'Long live the king!'" **1 SAMUEL 10:24**
8. "Now Samuel said to all Israel, 'Indeed I have \_\_\_\_\_ your voice in all that you said to me, and have made a king over you.'" **1 SAMUEL 12:1**

### TRUE OR FALSE:

9. Samuel said to the people, "If you fear the LORD and serve Him and obey His voice, and do not rebel against the commandment of the LORD, then both you and the king who reigns over you will continue following the LORD your God." **1 SAMUEL 12:14**  
**TRUE OR FALSE**
10. "However, if you do not obey the voice of the LORD, but rebel against the commandment of the LORD, then the hand of the LORD will be against you, as it was against your fathers." **1 SAMUEL 12:15**  
**TRUE OR FALSE**

## **Year 2**

### **Week 69**

### **Saul Disobeys God**

#### **Scriptures: I Samuel 13**

**Key Verse: I Samuel 13:13 You have done foolishly. You have not kept the commandment of the Lord your God, which He commanded you. For now the Lord would have established your kingdom over Israel forever.**

#### **Key Points:**

**1.** Shortly after Saul was anointed king, Israelites were challenged by the Ammonites. Saul proclaims that anyone who does not follow Samuel or Saul would be destroyed. Saul mustered his armies and defeated them. This made the people happy with Saul and he was confirmed as king among the people. They had a great celebration. This time, Saul made good choices and was a good king.

**2.** At another time, Saul chose 3000 men. 2000 were with him, 1000 with his son Jonathan at Gibeah. Jonathan attacked the Philistine outpost. Saul had the trumpet blown throughout the land, bragging about the attack. This made the Philistines mad. They assembled 30,000 men to fight Israel. Saul's troops came together at Gilgal with him. Samuel had told him to go there and wait 7 days for him to come (ch. 10:8). They knew they were severely outnumbered and hid in caves and thickets.

**3.** They waited seven days. When Samuel hadn't come, Saul's men began to scatter. So Saul had burnt offerings made. Just as he finished the offerings, Samuel arrived. Samuel told him he had acted foolishly by not waiting for him as he had been told.

**4.** Samuel told Saul his kingdom would not endure because he had not kept God's commands. God was looking for a man after his own heart to lead the people.

**5.** Saul's men counted about 600. They had no spears or swords to fight with for the Philistines had done away with the blacksmiths, only Saul and Jonathan had had them. The Philistines took advantage of Israel's fear and lack of weapons. They plundered the Israelite territory. God was not with Israel for Saul had not obeyed.

# KING SAUL OFFERS A SACRIFICE

*1 Samuel 13:1-22*

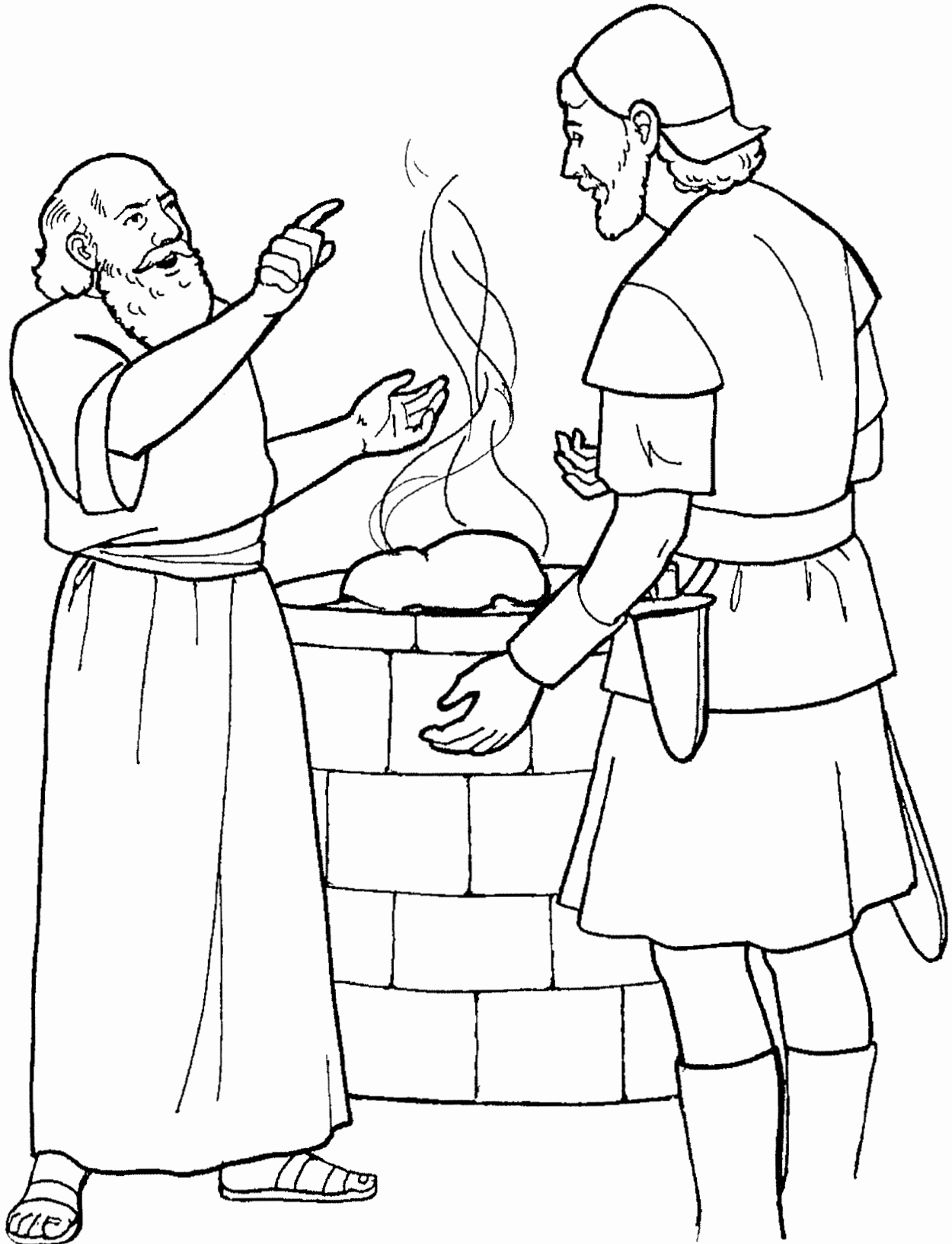

*Samuel tells Saul that he should not have offered a sacrifice to God*

# KING SAUL OFFERS A SACRIFICE

*1 Samuel 13:1-22*

## CRAFT/ACTIVITY: ALTARS

Students will make altars to remind them that King Saul offered a sacrifice to seek God's favor in light of the troubles he faced with the Philistines.

### MATERIALS

1. 67 Lb. White Cardstock
2. Altar Pattern
3. Crayons, Markers, or Colored Pencils
4. Scissors
5. Tape
6. Glue
7. Red, Orange, and Yellow Tissue Paper

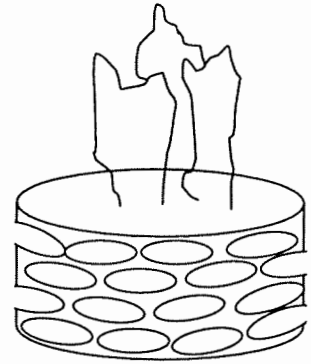

### DIRECTIONS

1. Make a copy of the "Altar" pattern onto 67 lb. cardstock for each student.
2. Have students color the stones with crayons, markers, or colored pencils.
3. Instruct students to cut out the altar on *all the straight solid black lines* (including the small ones between stones).
4. Have students fold on the dotted lines.
5. Help students glue or tape the tab that says "GLUE" to assemble the altar. The top "stones" need to be glued together as well.
6. Allow students to cut strips of red, orange, and yellow tissue paper to make flames.
7. Tape or glue the flames to the top of the altar.

### FOR DISCUSSION

As students are coloring their altars, remind them that King Saul was acting alone when he offered a sacrifice to the Lord. Samuel was the one who was to offer sacrifices to the Lord before the Israelites went to battle (1 Samuel 10:8). Because of Saul's disobedience and disregard for the Lord's prophet Samuel, King Saul would not pass on the throne to his sons. Saul was not supposed to reign independently of the law and the prophets. Help students realize that, as the memory verse states, the Lord would rather hear the prayer of the righteous than to receive sacrifices from them.

**TIME NEEDED TO COMPLETE:** Approximately 15 minutes

### MEMORY VERSE

*"The Lord detests the sacrifice of the wicked, but the prayer of the upright pleases him." Proverbs 15:8*

# KING SAUL OFFERS A SACRIFICE

*1 Samuel 13:1-22*

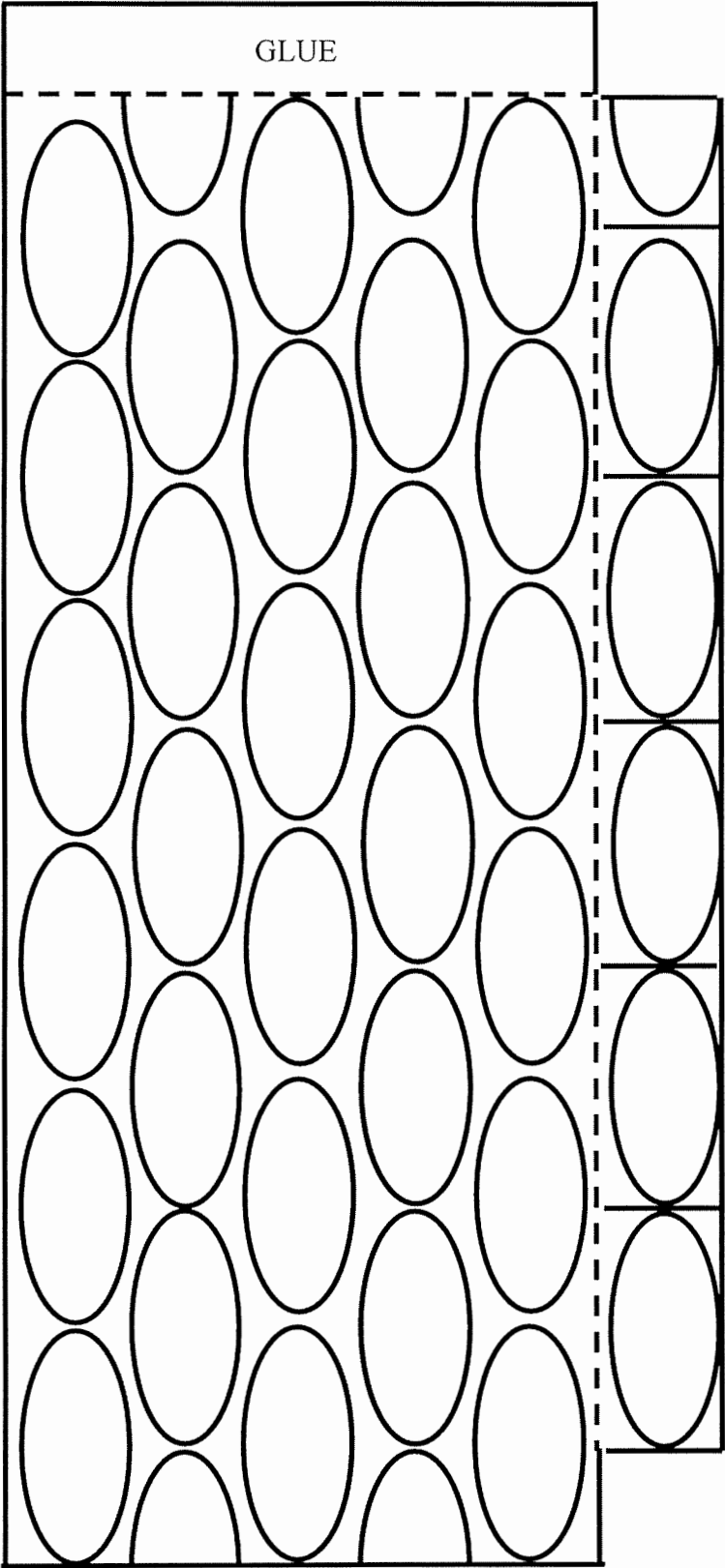

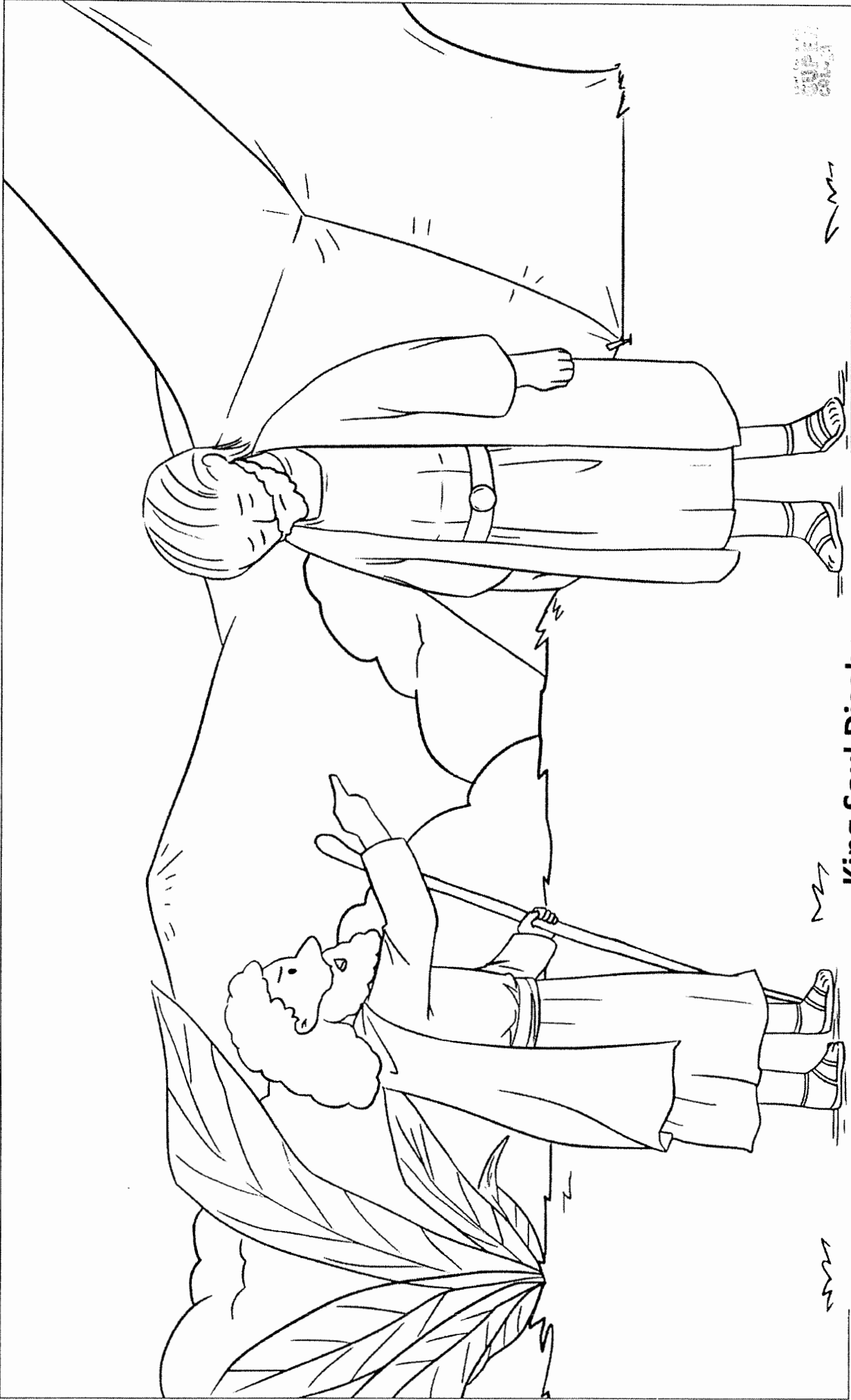

### King Saul Disobeys

Write out what Samuel says to King Saul after his return:

1 Samuel 13: 13

\_\_\_\_\_

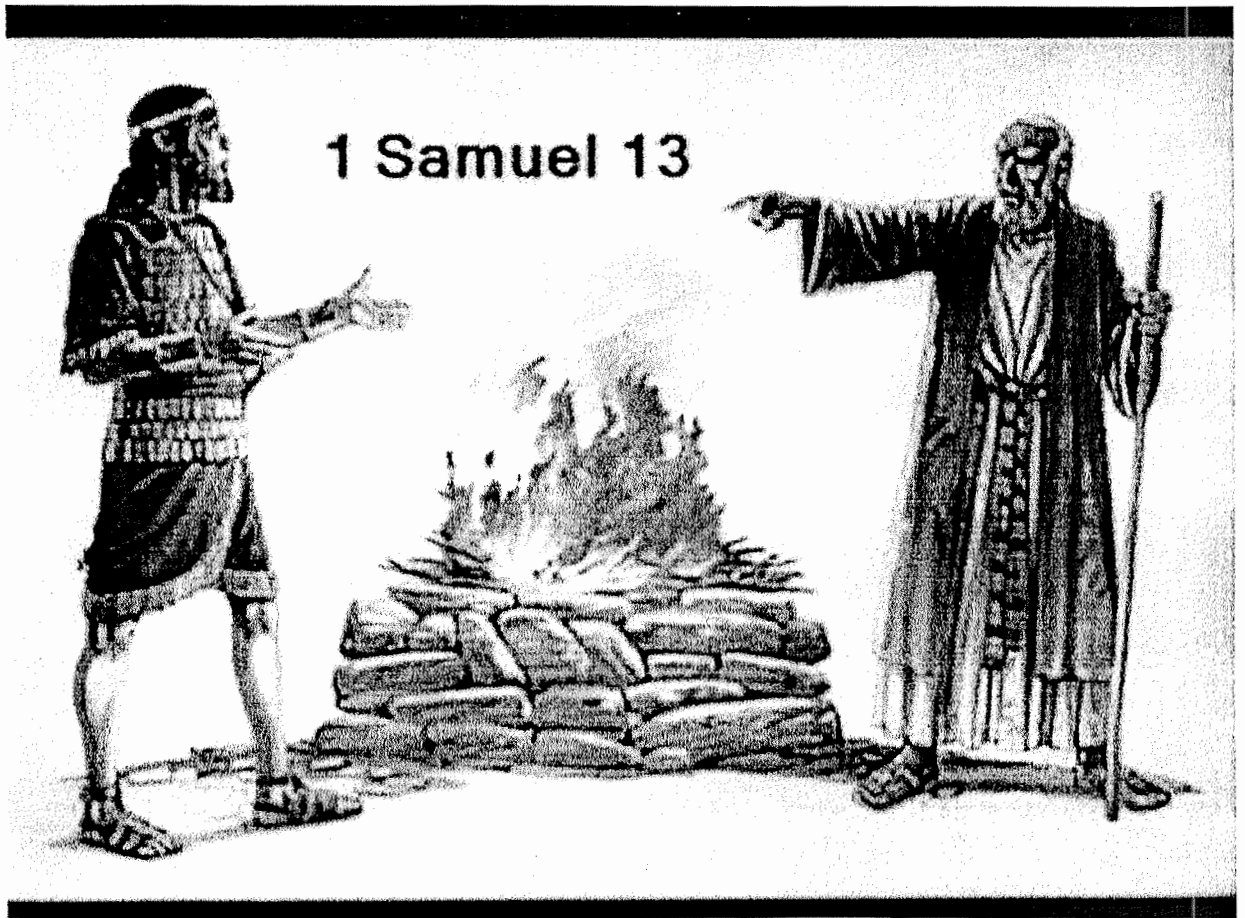

**Write out in your own words why Saul's sacrifice was disobedient.**



# JONATHAN'S FIGHT & SAUL'S OATH

(1 SAMUEL 14:1-46)



“And that first slaughter, which Jonathan and his armourbearer made, was about twenty men, within as it were an half acre of land, *which a yoke of oxen might plow.*” **1 SAMUEL 14:14**

“But Jonathan heard not when his father charged the people with the oath: wherefore he put forth the end of the rod that was in his hand, and dipped it in an honeycomb, and put his hand to his mouth; and his eyes were enlightened.” **1 SAMUEL 14:27**

1 SAMUEL 13:1 — 14:23  
SAUL DISOBEYS THE LORD /  
JONATHAN'S DARING DEED  
File no. 54

King Saul, his son Jonathan  
and their armies  
went out to fight the Philistines.

Jonathan and his soldiers  
attacked and defeated  
the Philistines at Geba.

This made the Philistines angry.  
They called for more soldiers  
and soon there was a huge army  
ready to fight back.

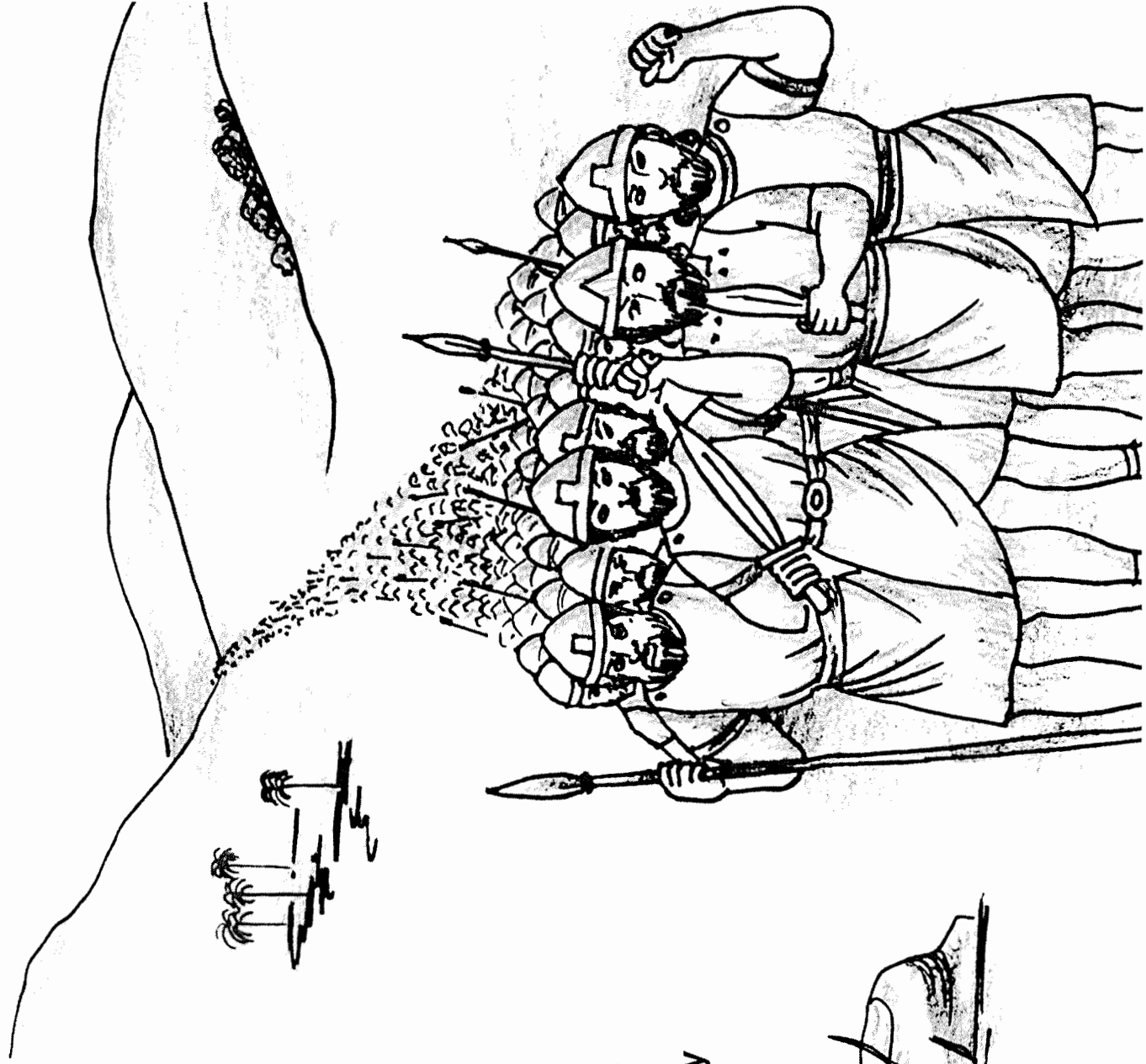

When King Saul's men saw  
how big the Philistine's army was,  
they were afraid.  
Some of them ran away.

Saul was waiting at Gilgal  
for Samuel to come.  
Samuel was to offer  
a sacrifice to the Lord  
and ask for God's help.

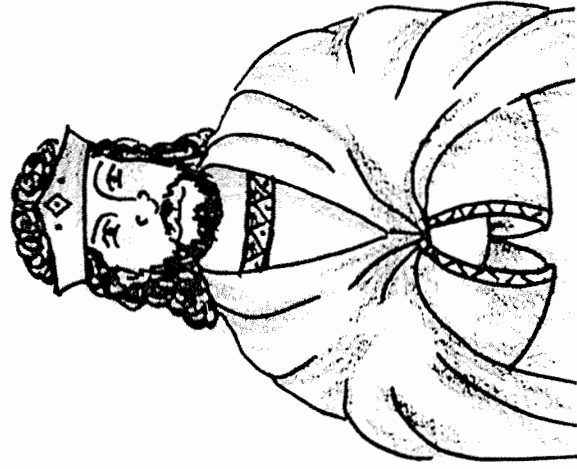
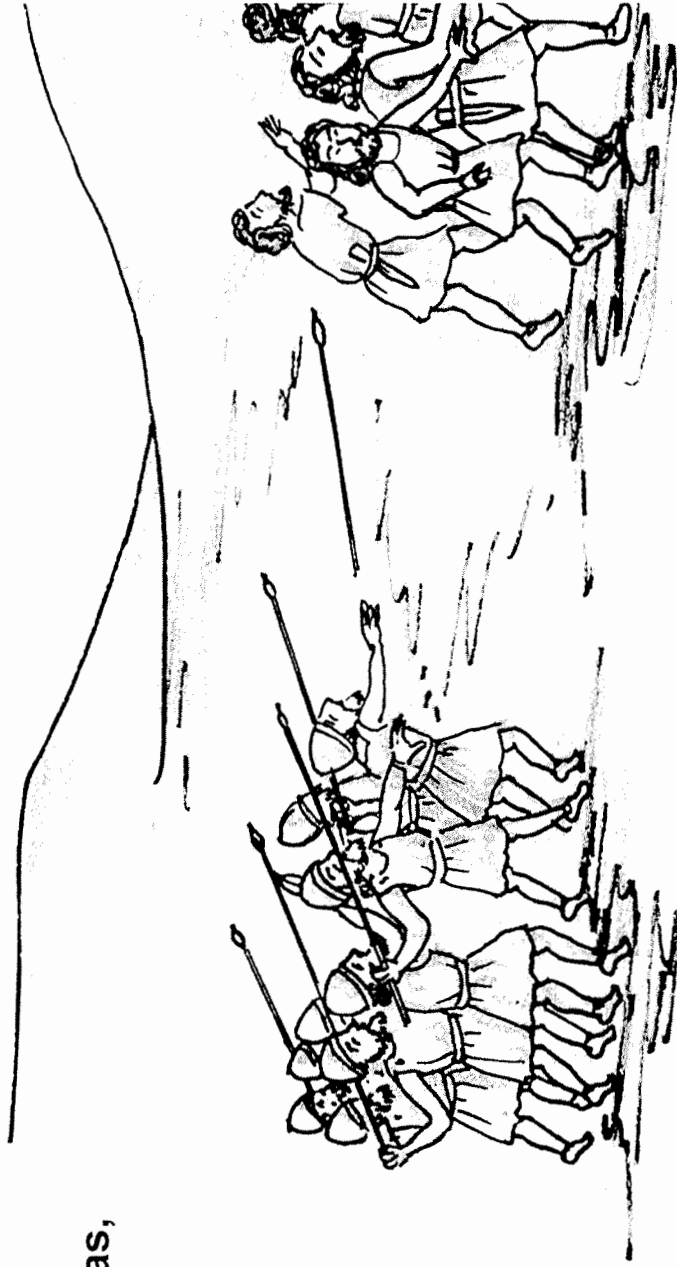

Seven days went by.  
Samuel had not come  
and Saul could not wait any longer.  
He disobeyed God  
and offered the sacrifice,  
which only the priest was to do.

Just as he was finishing  
Samuel came.

Samuel asked,  
'What have you done?'

Saul replied,  
'You did not come,  
so I offered the sacrifice.'

'You have been very foolish  
to disobey God,'  
Samuel said.

'God will find someone else  
whom He can trust  
and will make him king  
over His people forever.'

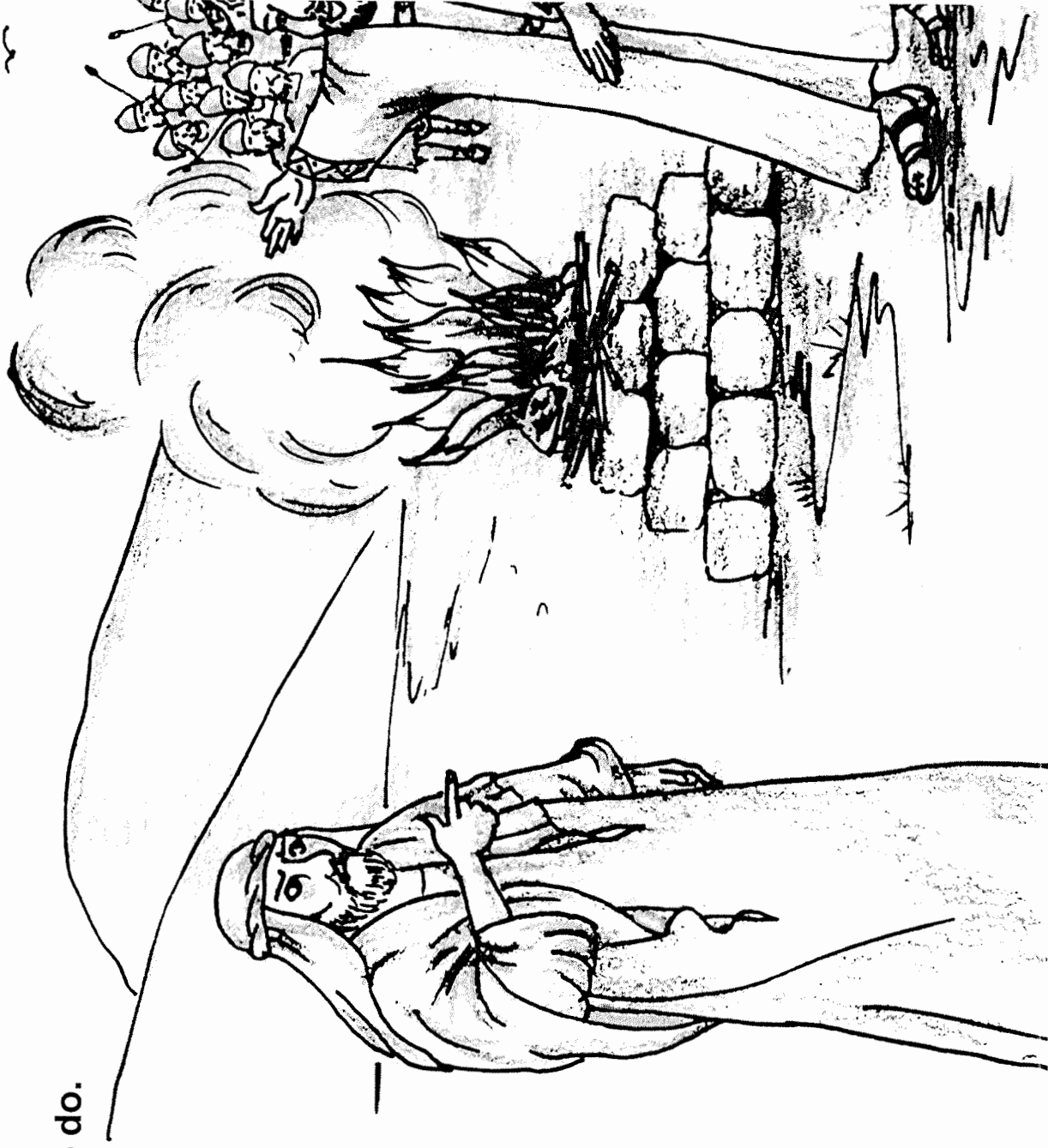

While this was happening  
Jonathan said to his armour bearer,  
'Let us go over to the Philistine camp.  
Perhaps the Lord will help us.  
He can work with many or few.'

'If the Philistines see us and say,  
"Stay there until we come to you,"  
we will stay.

'If they say, "Come up here",  
we will go to them.  
This will be the sign  
that God will fight for us.'

The Philistines saw Jonathan  
and called out,  
'Come up here.'

'Come on!' said Jonathan.  
'That means God will fight for us.'

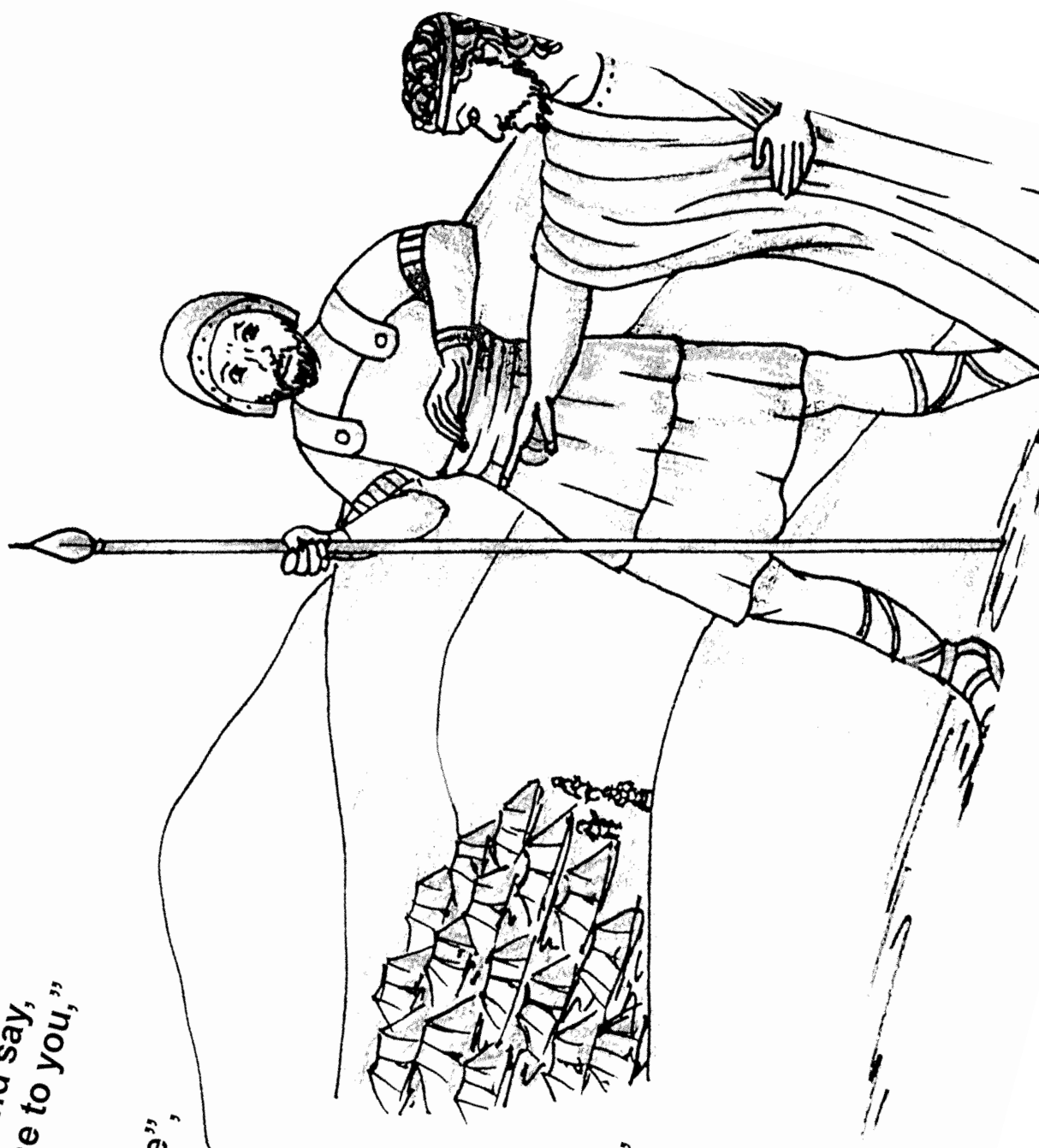

**They climbed the cliff  
and killed about twenty Philistines.**

**Then God sent an earthquake  
to help Jonathan.**

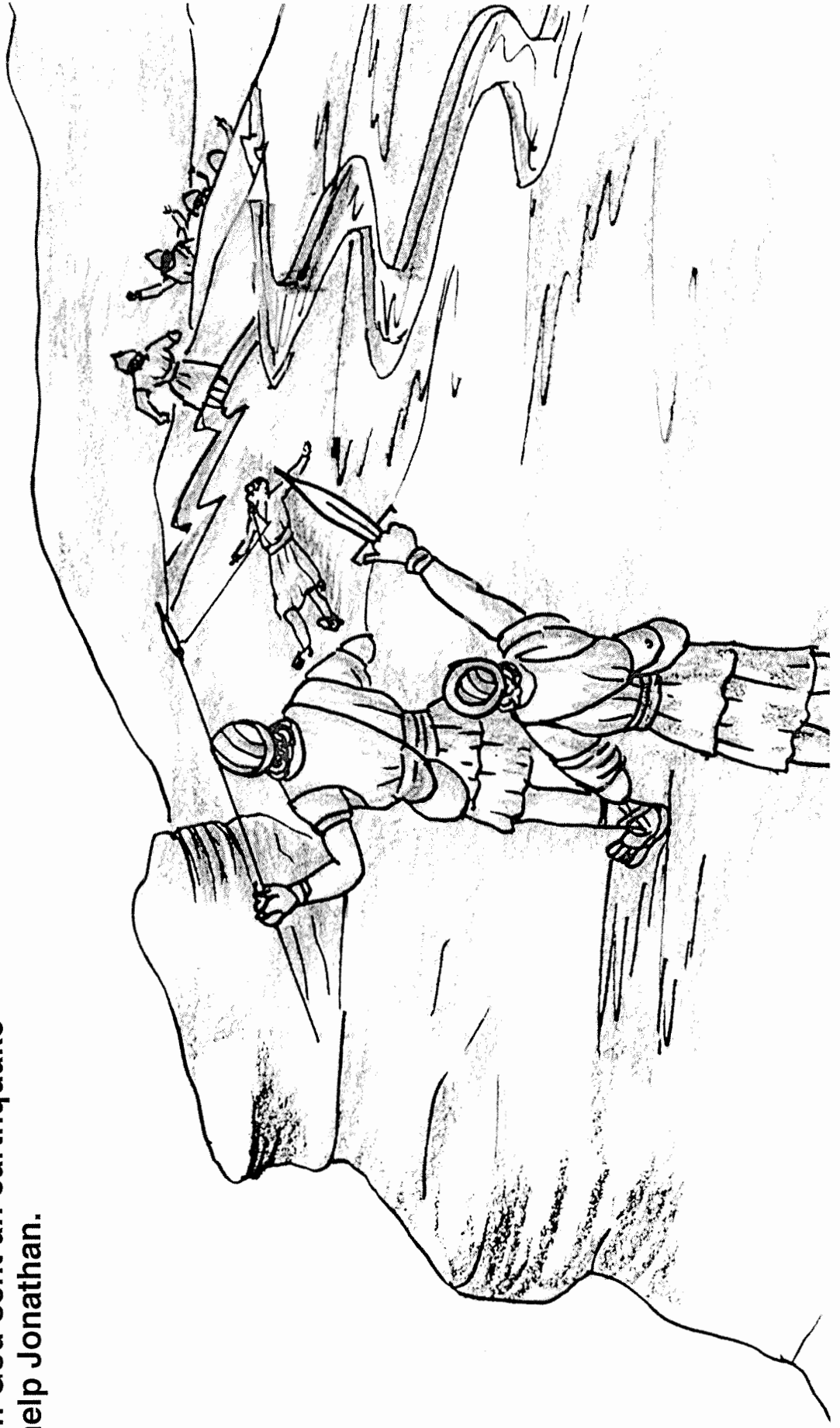

Someone from Saul's camp looked out and saw fighting among the Philistines. Saul also looked and wondered who was fighting the Philistines.

It was Jonathan and his armour-bearer. God was helping them.



The noise from the Philistines  
grew louder and louder.  
Saul couldn't wait  
to ask the Lord what he should do.  
He took his men  
into the battle.  
The Philistines were confused.  
Some began fighting each other  
and others ran away.  
God saved Israel that day.

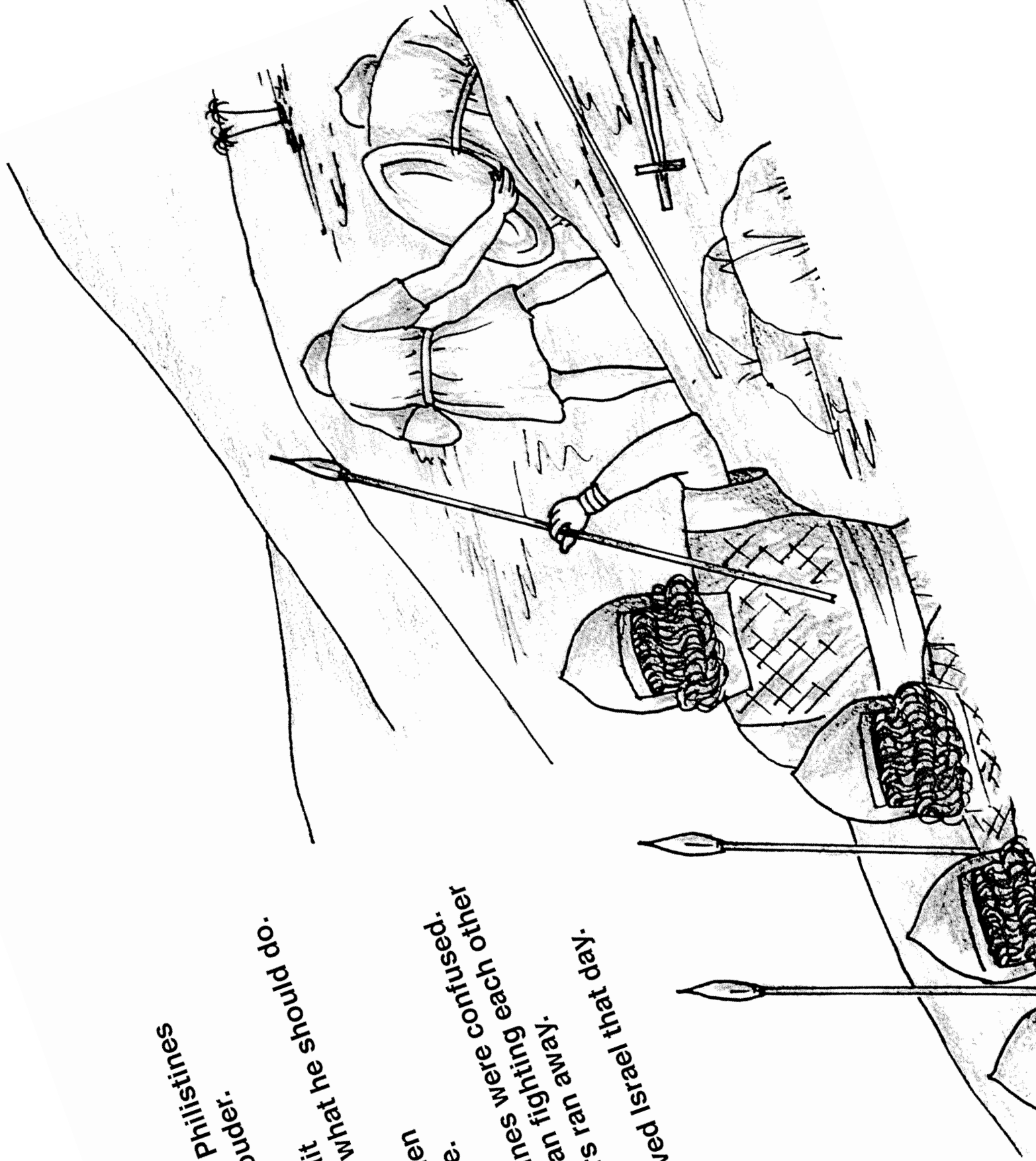



## SAUL DISOBEYS SAUL

### Fill in the blank (New King James Version)

#### 1 Samuel 13: 13-14

And \_\_\_\_\_ said to Saul, "You have done \_\_\_\_\_.  
You have not kept the \_\_\_\_\_ of the \_\_\_\_\_ your \_\_\_\_\_,  
which He \_\_\_\_\_ you. For now the Lord would have  
\_\_\_\_\_ your kingdom over \_\_\_\_\_ forever. <sup>14</sup> But  
now your \_\_\_\_\_ shall not \_\_\_\_\_. The Lord has  
\_\_\_\_\_ for Himself a man after His own \_\_\_\_\_, and  
the Lord has \_\_\_\_\_ him *to be* commander over  
His \_\_\_\_\_, because you have not kept what the  
\_\_\_\_\_ commanded you."

# KING SAUL OFFERS A SACRIFICE

*1 Samuel 13:1-22*

*Today's bible story was about* \_\_\_\_\_  
\_\_\_\_\_  
\_\_\_\_\_  
\_\_\_\_\_  
\_\_\_\_\_

*I learned that I should*  
\_\_\_\_\_  
\_\_\_\_\_  
\_\_\_\_\_  
\_\_\_\_\_

*The memory verse means*  
\_\_\_\_\_  
\_\_\_\_\_  
\_\_\_\_\_  
\_\_\_\_\_

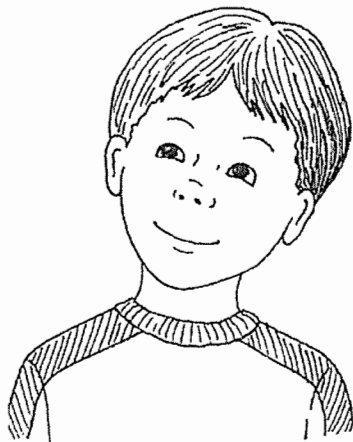

### **Memory Verse:**

*"The LORD detests the sacrifice of the wicked, but the prayer of the upright pleases him."*

*Proverbs 15:8*

Name: \_\_\_\_\_

# Saul Disobeys God

M B H V S D I S O B E Y S E B W A  
J L S A U L H L A F T G Z K L W F  
M Q X J N G P I E P N O M X G Z U  
Q G H F F S Z S J A O D O H E J F  
W K M O R G O R A I N N G S I R D  
O U S P Z B Z A K Y B A I A V Q E  
H H A I M P H E V M A M L M T D T  
M R C E R Q Z L V W T M G U R C A  
Y N R F M V C I A T T O A E T M P  
P V I X X F L T I H L N L L Z E I  
K U F J J Y S E W I E I N Y Q O D  
C M I O X V I S P S Y T P Q F A E  
E K C T H U N D E R Q E P V U J K  
A D E V K V B M M X O S Q C E S I  
C B W W D Q F F W I D Y V F F W N  
R H W A Z O H L N K O G M R Y D G  
P H I L I S T I N E S U D K B A O

<b>Rain</b>	<b>Thunder</b>	<b>King</b>	<b>Gilgal</b>
<b>Battle</b>	<b>Sacrifice</b>	<b>Philistines</b>	<b>Ammonites</b>
<b>Israelites</b>	<b>God</b>	<b>Disobeys</b>	<b>Samuel</b>
<b>Saul</b>			

# Saul's Sinful Sacrifice

H S A M H C I M F C S E A O N  
T R U M P E T O A N L F O H  
W L P G D G O V I T P F S N E  
C X A R B L E A T H E I G E C  
E O O G I S T A I R R R M V I  
S W M S L N B L I R A L G E F  
S E H M U I I N A T T E Q S I  
K P T O A S G G B E T U W J R  
R I M I T N E M D N A M M O C  
L U N I L G D E S X C A D N A  
G O N G E E I E M M K S G A S  
L E R L D U A B R S A U L T A  
S H N D Z O S R E D I A R H P  
S P E A R S M J S A E O H A E  
S C A T T E R E D I H F J N J

ATTACK  
COMMANDER  
GARRISON  
ISRAELITES  
LORD  
OFFERING  
SACRIFICE  
SCATTERED

BATTLE  
COMMANDMENT  
GIBEAH  
JONATHAN  
MICHMASH  
PHILISTINES  
SAMUEL  
SEVEN

CAVES  
FOOLISH  
GILGAL  
KINGDOM  
MOUNTAINS  
RAIDERS  
SAUL  
SPEARS

# SAUL IS REJECTED BY GOD

## (1 SAMUEL 15:10-35)

### MEMORY VERSE:

*"Behold, to obey is better than sacrifice."* 1 SAMUEL 15:22

### FILL IN THE BLANK:

1. "Now the word of the LORD came to Samuel, saying, 'I greatly \_\_\_\_\_ that I have set up Saul as king, for he has turned back from following Me, and has not performed My commandments.' And it grieved Samuel, and he cried out to the LORD all night." 1 SAMUEL 15:10-11

### TRUE OR FALSE:

2. "Then Samuel went to Saul, and Saul said to him, 'Blessed are you of the LORD! I have performed the commandment of the LORD.' " 1 SAMUEL 15:13  
TRUE OR FALSE
3. "But Samuel said, 'What then is this bleating of the sheep in my ears, and the lowing of the oxen which I hear?' " 1 SAMUEL 15:14  
TRUE OR FALSE

### CIRCLE THE CORRECT WORDS:

4. "And Saul said, 'They have brought them from the Amalekites; for the people (**DESTROYED**, **SPARED**) the best of the sheep and the oxen, to sacrifice to the LORD your God; and the rest we have utterly destroyed.' " 1 SAMUEL 15:15
5. "Why then did you not (**OBEY**, **DISOBEY**) the voice of the LORD? Why did you swoop down on the spoil, and do evil in the sight of the LORD?" 1 SAMUEL 15:19
6. "And Saul said to Samuel, 'But I (**HAVE**, **HAVE NOT**) obeyed the voice of the LORD, and gone on the mission on which the LORD sent me, and brought back Agag, king of Amalek; I have utterly destroyed the Amalekites.' " 1 SAMUEL 15:20
7. Then Samuel said, "Behold, to obey is (**BETTER**, **WORSE**) than sacrifice." 1 SAMUEL 15:22

### TRUE OR FALSE:

8. And Samuel also said, "Because you have rejected the word of the LORD, He also has rejected you from being king." 1 SAMUEL 15:23  
TRUE OR FALSE
9. "So Samuel said to him, 'The LORD has torn the kingdom of Israel from you today, and has given it to a neighbor of yours, who is better than you.' " 1 SAMUEL 15:28  
TRUE OR FALSE

### FILL IN THE BLANK:

10. "And Samuel went no more to see Saul until the day of his death. Nevertheless Samuel \_\_\_\_\_ for Saul, and the LORD regretted that He had made Saul king over Israel." 1 SAMUEL 15:35

# JONATHAN'S FIGHT & SAUL'S OATH

(1 SAMUEL 14:1-46)

G F S B D S D L L P Y N X O A  
M K N B N L H O N E Y C O M B  
B H B P O E D H O B J D I B F  
P T T R H L M T Z Q L U A S F  
M G D A P I Z Y M J T R T H T  
W E K O O K L Y T I N A A F Q  
N Y D I E W N I F N A Z L V H  
G G K H K V Z A S C E E B I A  
K R O S S J O O H T S W Z O U  
B M E S P P W A M T I M T N U  
Y Q J S P W D O O F A N Z H T  
K H Q R C E H V Q T L N E I T  
P V S V R U Q C S C P D O S D  
U V P N X L E A Q J U W N J D  
Y G M G O V I D V W T Q K U Q

DIE  
FOOD  
HONEYCOMB  
JONATHAN

LORD  
OATH  
PHILISTINES

RESCUED  
SAUL  
TWENTY MEN

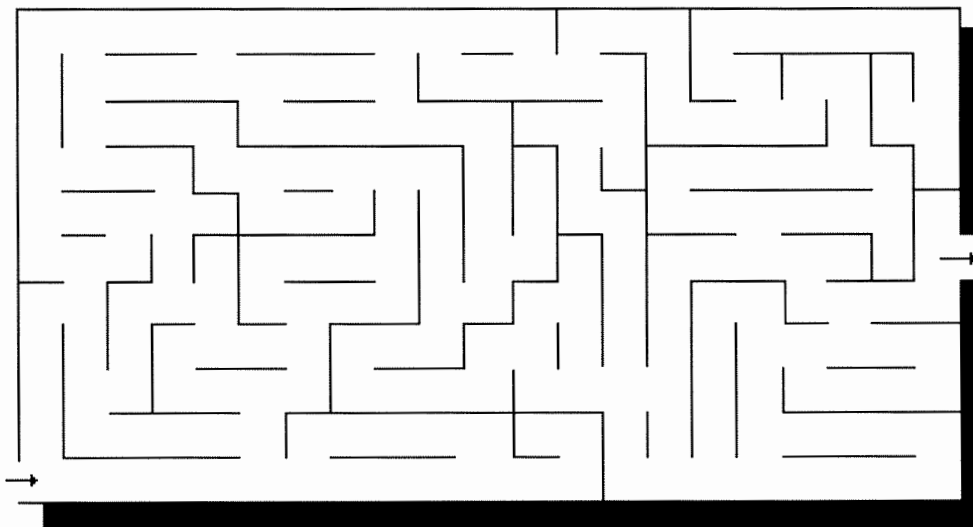

# JONATHAN'S FIGHT & SAUL'S OATH

## (1 SAMUEL 14:1-46)

### MEMORY VERSE:

*"For nothing restrains the LORD from saving by many or by few."* 1 SAMUEL 14:6

### TRUE OR FALSE:

1. "Now it happened one day that Jonathan, the son of Saul, said to the young man who bore his armor, 'Come, let us go over to the Philistines' garrison that is on the other side.' But he did not tell his father." 1 SAMUEL 14:1

TRUE OR FALSE

2. "Then Jonathan said to the young man who bore his armor, 'Come let us go over to the garrison of these uncircumcised; it may be that the LORD will work for us. For nothing restrains the LORD from saving by many or by few.'" 1 SAMUEL 14:6

TRUE OR FALSE

### FILL IN THE BLANK:

3. "That first slaughter which Jonathan and his armorbearer made was about \_\_\_\_\_ men within about half an acre of land." 1 SAMUEL 14:14

### UNDERLINE THE CORRECT ANSWER:

4. "And the men of Israel were distressed that day, for Saul had placed the people under oath, saying 'Cursed is the man who eats any food until evening, before I have taken vengeance on my enemies.'" 1 SAMUEL 14:24
- a. So all the people ate until they could eat no more  
b. So none of the people tasted food

### FILL IN THE BLANKS:

5. "But Jonathan \_\_\_\_\_ his father charge the people with the oath; therefore he stretched out the end of the rod that was in his hand and dipped it in a honeycomb, and put his hand to his mouth, and his countenance brightened." 1 SAMUEL 14:27
6. Now Jonathan said, "How much \_\_\_\_\_ if the people had eaten freely today of the spoil of their enemies which they found! For now would there not have been a much greater slaughter among the Philistines?" 1 SAMUEL 14:30
7. "Saul said to Jonathan, 'Tell me what you have done.' And Jonathan told him, and said, 'I only tasted a little honey with the end of the rod that was in my hand. So now I must \_\_\_\_\_!' " 1 SAMUEL 14:43

### TRUE OR FALSE:

8. Saul answered, "No my son, you shall surely not die!" 1 SAMUEL 14:44

TRUE OR FALSE

### FILL IN THE BLANK:

9. "The people said to Saul, 'Shall Jonathan die, who has accomplished this great salvation in Israel? Certainly not! As the LORD lives, not one hair of his head shall fall to the ground, for he has worked with God this day.' So the people \_\_\_\_\_ Jonathan, and he did not die." 1 SAMUEL 14:45

# JONATHAN'S FIGHT & SAUL'S OATH

(1 SAMUEL 14:1-46)

N C Z F H K D Y D M M Q V Z Z O K P N N  
Z M D W P Y T G O S B Q V S F J K M W W  
C Y C P T T N H F O A H D V J C X W B I  
U S W W Q P Y S O A K V K M F V D L W O  
Z O O V N S B E O L I Z P D E U C S E R  
H J P G O J P S D K Y U S O E G O G T V  
Z I O J N V M Q E B T D H N O W F W B M  
M M R T O A T H M N F F P G R H E S V G  
U O J B C D U O K N I H P I I N M Z B D  
D Y Y G B T C M N M Z T R C T H Q R H O  
D D M J B Y L A J G B G S Y Y B R O C T  
V V G W E T H B Q G C R M I S L K J O C  
V U M N I T N M M T S E B N L B D L Y U  
L P O J A Q Z C Z E N Q N E U I F L K V  
C H U N F F H B P L L J G B A U H A E N  
L S O H A N R B Q S S V B P S L H P O V  
V J O G W F A Y L V N Q L U Y Y L G J M  
N S V B X T A D A P P D L U D L L O R D  
M O V A B H I U L Z M D N R Y H D H S U  
J V R X Y E J W L S N D X J B X I G Z O

DIE  
FOOD  
HONEYCOMB  
JONATHAN

LORD  
OATH  
PHILISTINES

RESCUED  
SAUL  
TWENTY MEN

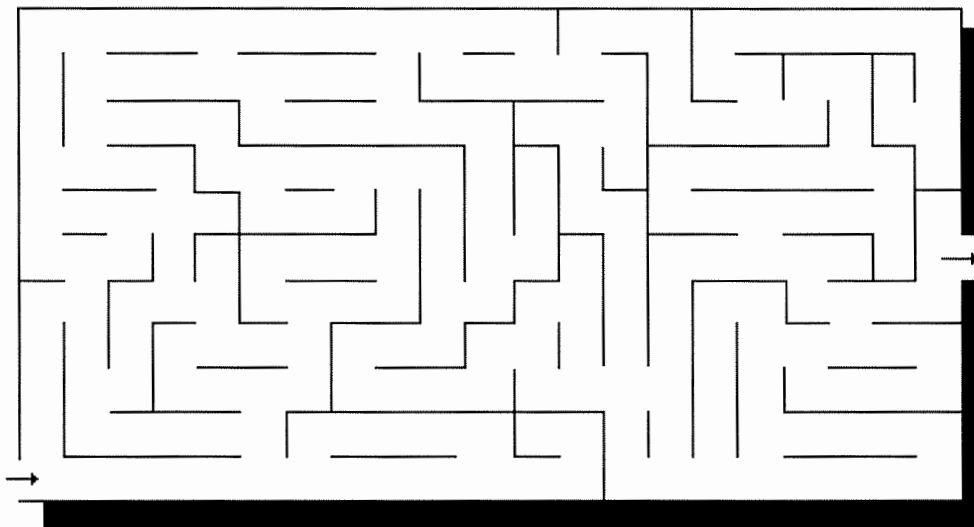



## Year 2

### Week 70

### Saul Loses his Crown

#### Scriptures: I Samuel 15

**Key Verse: I Samuel 15:22 “...to obey is better than sacrifice and to heed than the fat of lambs.”**

#### Key Points:

1. Samuel came to Saul and tells him he is to completely destroy the Amalekites. Nothing was to be spared, all people, animals and possessions were to be destroyed. So Saul gathered all the people together and laid wait in the valley.
2. Saul attacked and destroyed the Amalekite nation but saved King Agag, their king. He also spared the best of the sheep, oxen, lambs, and fatlings. All that was good he spared, but destroyed all that was worthless.
3. God spoke to Samuel and told him he was grieved that he had set up Saul as king. Samuel then went to Saul. Saul was proud of himself but Samuel asked him about the bleating of the sheep that he heard. Saul still insisted he had obeyed the word of the Lord and had kept the animals to sacrifice. Samuel told him to be quiet and listen to what the Lord had told him. Saul then admitted to his sin and asked Samuel to forgive him and go back with him to worship the Lord.
4. Samuel refused to go with him. He had rejected the Lord and now the Lord was rejecting him as king.(fulfills prophecy Samuel makes in ch. 12 & 13). Then Saul reached out for him as he turned to leave. He caught hold of the hem of Samuel’s robe and it tore. Samuel said to him that this was just like the lord “tearing” the kingdom of Israel from him. Saul asked again that Samuel worship with him so he did.
5. Samuel then killed King Agag as God had commanded. Saul went to his home. Samuel never saw Saul again but mourned for him. The Lord grieved he had ever made him king. God did not tolerate Saul’s disobedience and expected him to follow the whole law, not just the parts he wanted to. Obeying is better than the sacrifice.

# SAUL IS REJECTED BY GOD

(1 SAMUEL 15:10-35)



“Then came the word of the LORD unto Samuel, saying, it repenteth me that I have set up Saul *to be* king: for he is turned back from following me, and hath not performed my commandments. And it grieved Samuel; and he cried unto the LORD all night.”

**1 SAMUEL 15:10-11**



# SAUL DISOBEYS GOD

*1 Samuel 15:1-29*



*The Israelites defeat the Amalekites but Saul disobeys God*



# JONATHAN'S FIGHT & SAUL'S OATH

## (1 SAMUEL 14:1-46)

### MEMORY VERSE:

*"For nothing restrains the LORD from saving by many or by few."* 1 SAMUEL 14:6

### TRUE OR FALSE:

1. "Now it happened one day that Jonathan, the son of Saul, said to the young man who bore his armor, 'Come, let us go over to the Philistines' garrison that is on the other side.' But he did not tell his father." 1 SAMUEL 14:1

TRUE OR FALSE

2. "Then Jonathan said to the young man who bore his armor, 'Come let us go over to the garrison of these uncircumcised; it may be that the LORD will work for us. For nothing restrains the LORD from saving by many or by few.'" 1 SAMUEL 14:6

TRUE OR FALSE

### CIRCLE THE CORRECT WORD:

3. "That first slaughter which Jonathan and his armorbearer made was about (TEN, TWENTY) men within about half an acre of land." 1 SAMUEL 14:14

### TRUE OR FALSE:

4. "And the men of Israel were distressed that day, for Saul had placed the people under oath, saying 'Cursed is the man who eats any food until evening, before I have taken vengeance on my enemies.' So none of the people tasted food." 1 SAMUEL 14:24

TRUE OR FALSE

### CIRCLE THE CORRECT WORDS:

5. "But (JONAH, JONATHAN) had not heard his father charge the people with the oath; therefore he stretched out the end of the rod that was in his hand and dipped it in a honeycomb, and put his hand to his mouth, and his countenance brightened." 1 SAMUEL 14:27
6. Now Jonathan said, "How much (BETTER, WORSE) if the people had eaten freely today of the spoil of their enemies which they found! For now would there not have been a much greater slaughter among the Philistines?" 1 SAMUEL 14:30
7. "Saul said to Jonathan, 'Tell me what you have done.' And Jonathan told him, and said, 'I only tasted a little honey with the end of the rod that was in my hand. So now I must (LIVE, DIE)!' " 1 SAMUEL 14:43

### TRUE OR FALSE:

8. Saul answered, "No my son, you shall surely not die!" 1 SAMUEL 14:44

TRUE OR FALSE

### FILL IN THE BLANK:

9. "The people said to Saul, 'Shall Jonathan die, who has accomplished this great salvation in Israel? Certainly not! As the LORD lives, not one hair of his head shall fall to the ground, for he has worked with God this day.' So the people \_\_\_\_\_ Jonathan, and he did not die." 1 SAMUEL 14:45

# God rejected Saul as King

W U Y P F H B V P M P O W X I H I  
F H H Y D O T U G V W F G E W X P  
B S A C R I F I C E L G P N L M L  
X Y F O R G I V E P G E V E K X P  
V N D D Y K Y X L K I M B C I W H  
F N R I F K G P H A F E S K B B I  
O E N S Z T N J K H L M P G B Z L  
F U V O R U L E I N U I K U I H I  
F W Z B A W O Q L J S E P Y Y G S  
E I Z E L W K B L D I S Y C T H T  
R S E Y L G L O U M N L N S Z L I  
I R K H O D L F H R Y H G A L I N  
N A H E J R T I A V X I S M N D E  
G E J W J C J G W F P D A U Y O S  
M L S H P O I H T Y G U U E Q M S  
O B E Y V G K T U I G G L L Y O Q  
P A I U W X M G N B X R N B U S O

all	disobey	ememies	fight
forgive	Israel	kill	obey
offering	Philistines	rule	Samuel
Saul	sacrifice		

# SAUL IS REJECTED BY GOD

## (1 SAMUEL 15:10-35)

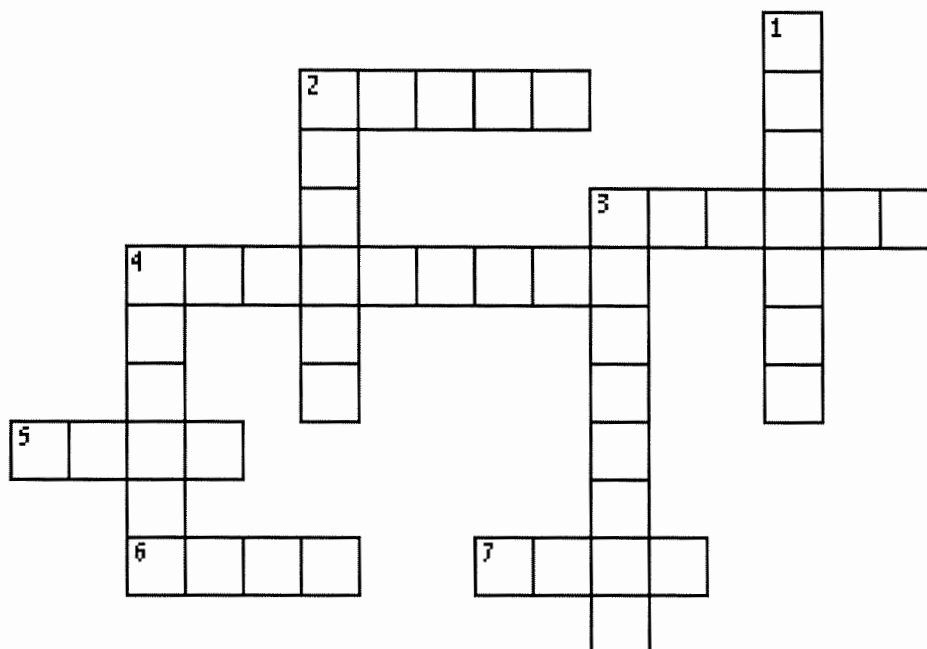

- 3 ACROSS "Now the word of the LORD came to Samuel, saying, 'I greatly \_\_\_\_\_ that I have set up Saul as king.'" **1 SAMUEL 15:10**
- 4 DOWN "Then \_\_\_\_\_ went to Saul, and Saul said to him, 'Blessed are you of the LORD! I have performed the commandment of the LORD.'" **1 SAMUEL 15:13**
- 2 ACROSS "But Samuel said, 'What then is this bleating of the \_\_\_\_\_ in my ears, and the lowing of the oxen which I hear?'" **1 SAMUEL 15:14**
- 2 DOWN "And Saul said, 'They have brought them from the Amalekites; for the people \_\_\_\_\_ the best of the sheep and the oxen, to sacrifice to the LORD your God.'" **1 SAMUEL 15:15**
- 7 ACROSS "Why then did you not \_\_\_\_\_ the voice of the LORD?" **1 SAMUEL 15:19**
- 5 ACROSS "And \_\_\_\_\_ said to Samuel, 'But I have obeyed the voice of the LORD.'" **1 SAMUEL 15:20**
- 4 ACROSS Then Samuel said, "Behold, to obey is better than \_\_\_\_\_." **1 SAMUEL 15:22**
- 3 DOWN And Samuel also said, "Because you have \_\_\_\_\_ the word of the LORD, He also has rejected you from being king." **1 SAMUEL 15:23**
- 6 ACROSS "So Samuel said to him, 'The \_\_\_\_\_ has torn the kingdom of Israel from you today, and has given it to a neighbor of yours, who is better than you.'" **1 SAMUEL 15:28**
- 1 DOWN "And Samuel went no more to see Saul until the day of his death. Nevertheless Samuel \_\_\_\_\_ for Saul, and the LORD regretted that He had made Saul king over Israel." **1 SAMUEL 15:35**



# SAUL IS REJECTED BY GOD

(1 SAMUEL 15:10-35)

I B K E D P Z U N U B D P M J  
 O B L W Y R A G A G L G C H Q  
 X Z D G I F I D P G A P P Y L  
 K N E L O D E N R U O M S Y P  
 E F F F E S A U L L E C A M V  
 Y W T Z S C I W Y O Z V M B G  
 T M E A B H I E G R C B B P Y  
 E Y R N L M E F N D L I E R Q  
 Z L G S O E D E I F W P L Y D  
 Q N E H U T Z E P R C N C R O  
 V D R U D E R A P S C S P E O  
 L C A S P L P B W Y A A P D O  
 S V B Y D E T C E J E R S V B  
 R O R J W M Z D Y I Z C R T E  
 S S L N C E V V Z F S N E O Y

AGAG  
 LORD  
 MOURNED  
 OBEY

OXEN  
 REGRET  
 REJECTED  
 SACRIFICE

SAMUEL  
 SAUL  
 SHEEP  
 SPARED

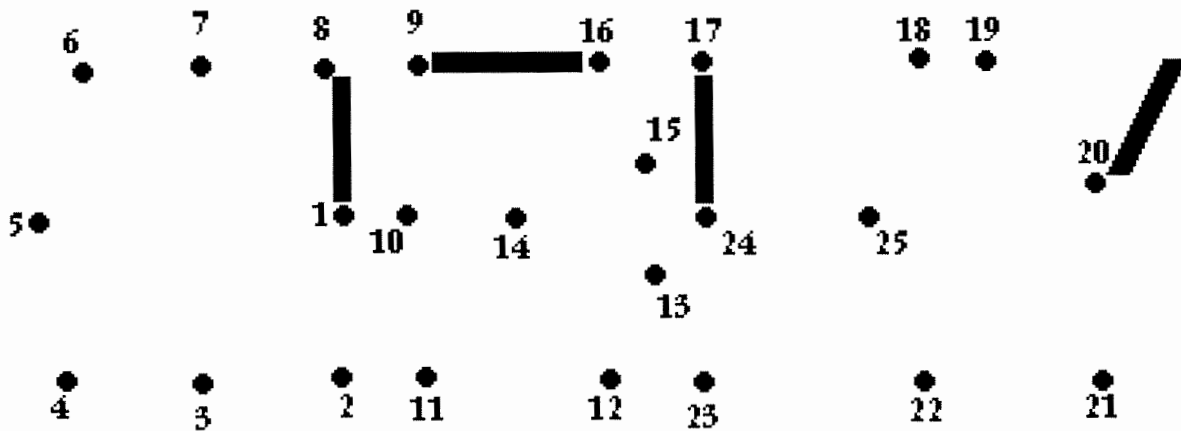



# Bible Pathway Adventures

BIBLE QUIZ

## KING SAUL

Match the question with the  
answer on the right.

### Questions

- \_\_\_ Saul was of which tribe of Israel?
- \_\_\_ Which group of enemies did Saul fight many times?
- \_\_\_ Which Hebrew prophet anointed Saul as king?
- \_\_\_ In which town did Saul live while he was king?
- \_\_\_ Who was Saul's father?
- \_\_\_ Which son of Saul was good friends with David?
- \_\_\_ Who told Saul to fight the Amalekites?
- \_\_\_ Which son-in-law did Saul try to kill many times?
- \_\_\_ Whenever Saul was troubled by an evil spirit, what did David do?
- \_\_\_ Saul disobeyed Yah and visited which witch?
- \_\_\_ For how many years did Saul reign as king?
- \_\_\_ Saul died during which battle?

### Answers

1. Samuel
2. Battle at Moun
3. Samuel
4. Forty
5. Witch of Endor
6. David
7. Philistines
8. Kish
9. Play his harp
10. Benjamin
11. Jonathan
12. Gibeah

**Saul  
Disobeys  
1 Samuel 15**

# Listen to Good Advice

King Saul was a good king as long as he listened to God and did what God said. But when Saul decided to stop listening to God, he got into big trouble. Samuel, God's prophet, came to Saul and gave him some good advice. You will get out of the maze only by following good advice. See what happens if you follow bad advice.

➔ MAKE YOUR OWN DECISIONS

➔ IT IS BETTER TO OBEY GOD

➔ LISTEN TO GOD

➔ THINK YOU KNOW BEST

➔ DO YOUR OWN THING



# SAUL IS REJECTED BY GOD

## (1 SAMUEL 15:10-35)

### MEMORY VERSE:

*"Behold, to obey is better than sacrifice."* 1 SAMUEL 15:22

### FILL IN THE BLANK:

1. "Now the word of the LORD came to Samuel, saying, 'I greatly \_\_\_\_\_ that I have set up Saul as king, for he has turned back from following Me, and has not performed My commandments.' And it grieved Samuel, and he cried out to the LORD all night." 1 SAMUEL 15:10-11

### TRUE OR FALSE:

2. "Then Samuel went to Saul, and Saul said to him, 'Blessed are you of the LORD! I have performed the commandment of the LORD.'" 1 SAMUEL 15:13  
TRUE OR FALSE
3. "But Samuel said, 'What then is this bleating of the sheep in my ears, and the lowing of the oxen which I hear?' " 1 SAMUEL 15:14  
TRUE OR FALSE

### FILL IN THE BLANKS:

4. "And Saul said, 'They have brought them from the Amalekites; for the people \_\_\_\_\_ the best of the sheep and the oxen, to sacrifice to the LORD your God; and the rest we have utterly destroyed.'" 1 SAMUEL 15:15
5. "Why then did you not \_\_\_\_\_ the voice of the LORD? Why did you swoop down on the spoil, and do evil in the sight of the LORD?" 1 SAMUEL 15:19
6. "And Saul said to Samuel, 'But I \_\_\_\_\_ obeyed the voice of the LORD, and gone on the mission on which the LORD sent me, and brought back Agag, king of Amalek; I have utterly destroyed the Amalekites.'" 1 SAMUEL 15:20
7. Then Samuel said, "Behold, to obey is \_\_\_\_\_ than sacrifice." 1 SAMUEL 15:22

### TRUE OR FALSE:

8. And Samuel also said, "Because you have rejected the word of the LORD, He also has rejected you from being king." 1 SAMUEL 15:23  
TRUE OR FALSE
9. "So Samuel said to him, 'The LORD has torn the kingdom of Israel from you today, and has given it to a neighbor of yours, who is better than you.'" 1 SAMUEL 15:28  
TRUE OR FALSE

### FILL IN THE BLANK:

10. "And Samuel went no more to see Saul until the day of his death. Nevertheless Samuel \_\_\_\_\_ for Saul, and the LORD regretted that He had made Saul king over Israel." 1 SAMUEL 15:35

Saul Loses his Crown  
I Samuel 15

**Memory Verse:**

**“Has the LORD as great delight in burnt offerings and sacrifices as in obeying the voice of the LORD? Behold, to obey is better than sacrifice, and to listen than the fat of rams.” I Sam 15:22**

**Choose the best answer:**

God commanded Saul to strike Amelek and devote \_\_\_\_\_ to destruction.

- a. Some things
- b. Most things
- c. Everything

Saul disobeyed God’s commands and only destroyed:

- a. The idols
- b. All that was good
- c. All that was bad

When Samuel asked Saul what had happened, who did he say was responsible for keeping the cattle?

- a. Himself
- b. Samuel
- c. The people

How many times did Saul deny his own disobedience?

- a. Once
- b. Twice
- c. Three times

As a result of Saul’s sin:

- a. God rejected Saul as king.
- b. Samuel rejected Saul as king.
- c. The people rejected Saul as king.

In an attempt to repent from his sin, Saul:

- a. Sacrificed the cattle.
- b. Donated the gold to orphans and widows.
- c. Killed Agag.

“The LORD \_\_\_\_\_ that he had made Saul king over Israel.”

- a. Was glad.
- b. Regretted.
- c. Feared.

**Answer the following question in your own words:**

Saul states that the best of the cattle were meant as a sacrifice to God. Do you think Saul truly believed he had done the right thing? Why do you think God did not see this as good?

## Saul Loses his Crown I Samuel 15

### Memory Verse:

**“Behold, to obey is better than sacrifice, and to listen than the fat of rams.” I Sam 15:22b**

### Choose the best answer:

God commanded Saul to strike Amelek and devote \_\_\_\_\_ to destruction. (15:3)

- a. Some things
- b. Most things
- c. Everything

Saul disobeyed God’s commands and only destroyed: (15:9)

- a. The idols
- b. All that was good
- c. All that was bad

When Samuel asked Saul what had happened, who did he say was responsible for keeping the cattle? (15:15)

- a. Himself
- b. Samuel
- c. The people

As a result of Saul’s sin: (15:26)

- a. God rejected Saul as king.
- b. Samuel rejected Saul as king.
- c. The people rejected Saul as king.

### Answer the following question in your own words:

Saul chose to not obey God completely, but to only do part of what He asked. Can you think of a time when we might be tempted to only do part of what is right? Give an example of a time when you might want to only do part of what you’re asked and tell how you can make sure you don’t make the same mistake as Saul!

1. Saul had been rejected by God. That means God didn't want Saul to be king anymore because he was naughty and didn't listen to God.
  - a. Have you ever gotten punished by your parents because you didn't listen to them or you did something they told you not to do?
  - b. What were some things that Saul did that God told him not to do?
    - i. God told Saul to kill king Agag of Amalek, but he didn't
    - ii. Saul sacrificed animals and didn't wait for Samuel at Gilgal
2. Who am I?
  - a. I am the first king of Israel. I disobeyed God and so God rejected me as king. Who am I? (Saul)
  - b. I am God's prophet. He sent me to find a new king at the house of Jesse. Who am I? (Samuel)
  - c. I am the youngest of eight brothers. Jesse is my dad. Who am I? (David)
  - d. I didn't kill king Agag when God told me to kill him. I didn't listen to God, so God told me I couldn't be the king anymore. Who am I? (Saul)
  - e. I was told by God to anoint a new king. I went to Jesse's house with an animal to sacrifice and to find a new king. Who am I? (Samuel)
  - f. Samuel came and told me I was going to be the new king. He poured oil over my head. Who am I? (David)
  - g. When Samuel came to my house, my father did not show me to Samuel at first. I was off taking care of the sheep. (David)
  - h. When I went to Jesse's house, I looked at seven different men. They all looked strong to me. God said he looked not on the outside but at the heart and said that David was the one who would be the best king. Who am I? (Samuel)
  - i. After looking at all of my brothers who were older and stronger, Samuel told me I was to be the next king. The Bible says I am healthy, strong, and good looking. Who am I? (David)



# SAUL IS REJECTED BY GOD

## (1 SAMUEL 15:10-35)

W H G J M T Q J P O F V D L B W U Q V S  
 X D H Q G F Q V R N J G O G W I O C T N  
 B T S P G Z H Q B G F W F S B O X R L U  
 Y N E Z T B V D N I E H X Z V V M H C W  
 K Y Q P E C G D G C O H Q M O D G N I K  
 Y B M Q L N A S B P R B R R B M G N R S  
 T P B L S E G D T E E R K O H G Q E M C  
 P B B A V X A V C N I E D J C D J N G T  
 S N C L P O Z I L N E B H L O E O V K P  
 J L B L Z S F V D E Y M F S C O T G M M  
 V N B M S I U E L S S U D T Y T H R P S  
 D Z Y S R L N D P B T L E N K D K K E D  
 T H N C M R D A N E Y D H L A C R L I Q  
 T R A O U S R K R P D Y L A E M E O P H  
 Q S W O B E F G L U Y L D G O U M Z L E  
 F A M A D N E R Z U B H I H M U W O L N  
 N A D L A R H S S R O R P A J V W L C P  
 L U A S K P G O B E Y K S G S N B B E T  
 F J O K I M U H V J J K M N Z V L I N L  
 T Y K N Y N Q P M Z C J W W N M R V K Z

AGAG  
 COMMANDMENTS  
 KINGDOM  
 LORD

OBEY  
 OXEN  
 REGRET  
 REJECTED

SAMUEL  
 SAUL  
 SHEEP  
 SPARED

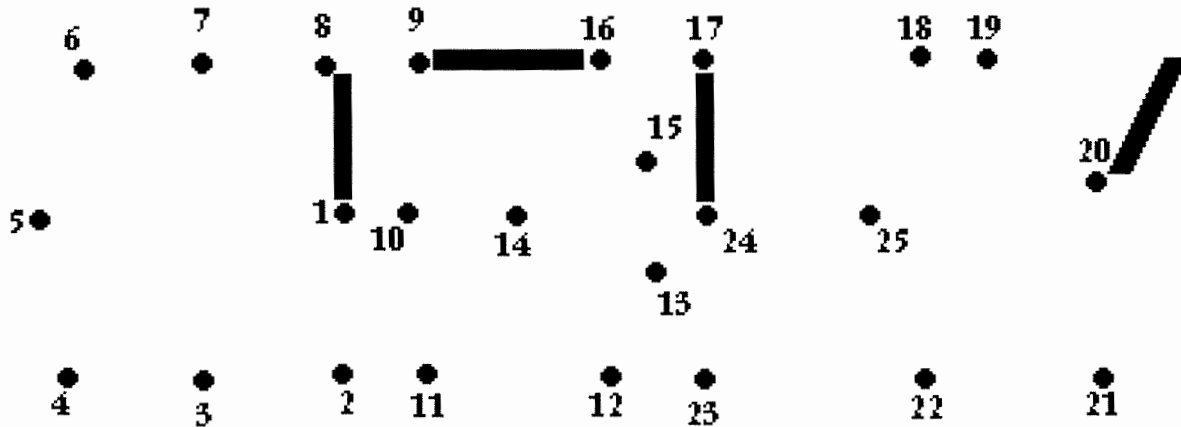

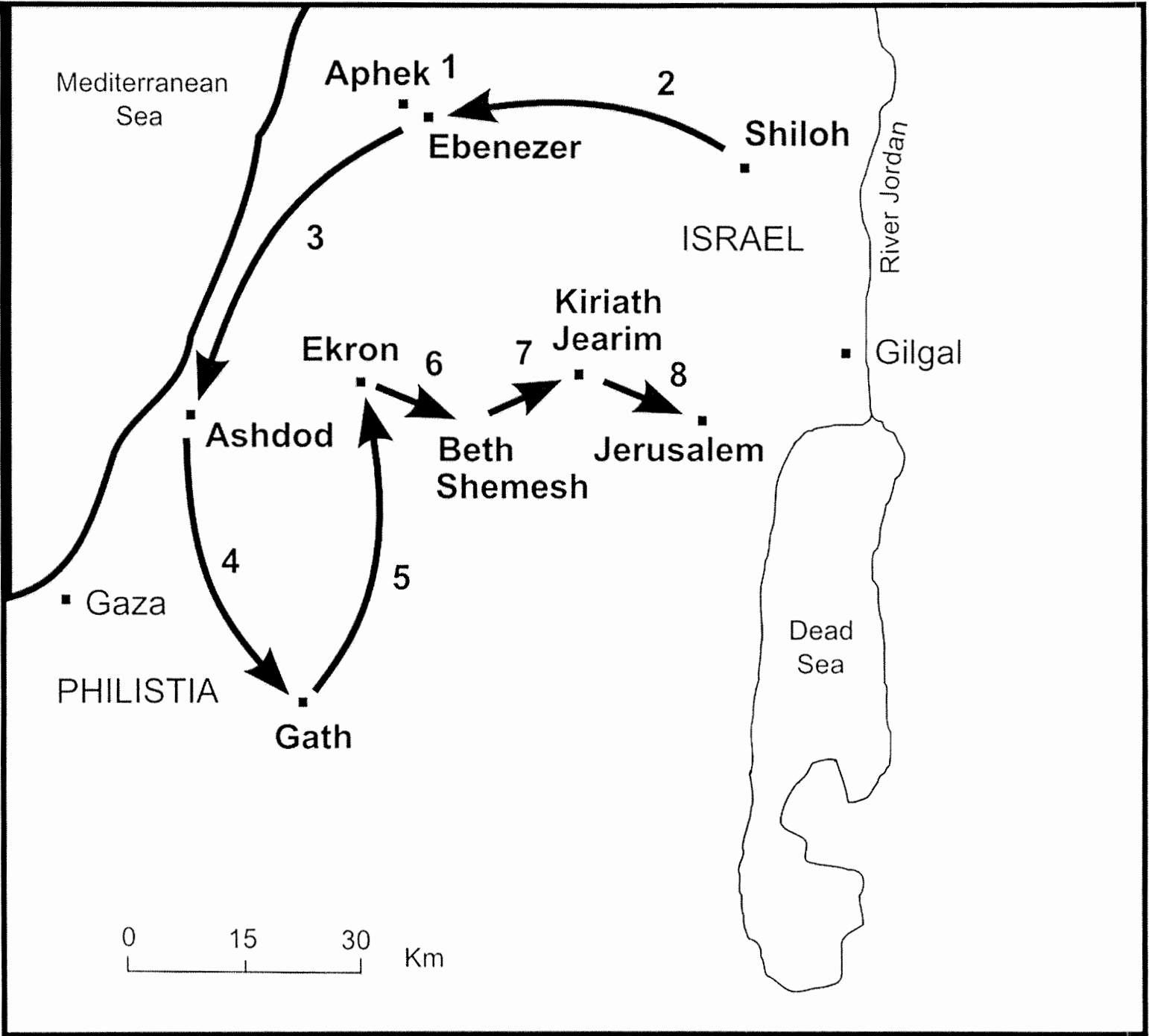

**Year 2**

**Week 71**

## **God Chooses A New King**

**Scriptures: 1 Samuel 16**

**Key Verse: 1 Samuel 16:1** “Now the Lord said to Samuel, ‘How long will you mourn for Saul, seeing I have rejected him from reigning over Israel? Fill your horn with oil, and go; I am sending you to Jesse the Bethlehemite. For I have provided Myself a king among his sons.’”

**Key Points:**

1. Saul, the first king of Israel had been rejected by God. God told the prophet, Samuel, to fill his horn with oil, travel to Bethlehem, and anoint one of Jesse’s eight sons, whom God would select.
2. Samuel obeyed and met with Jesse and his 7 older sons at a sacrifice to God. All 7 of the older sons passed by Samuel, but God did not choose any of them. God told Samuel that man looked on the outward appearance, but God looked on the heart.
3. Jesse told Samuel that the youngest son was out tending the sheep. David was quickly brought in before Samuel. He was healthy, strong, and good-looking. God said, “Arise, anoint him for this is the one.” David’s heart (mind/will) was superior in God’s sight (see Acts 13:22).
4. Samuel poured the oil out on David’s head in the presence of his father and all 7 of his brothers. The Spirit of the Lord came upon David from that day forward. Anointing was pouring of fine oil on the head and letting it flow down on the body. God’s royal blessings flowed down on David and covered him while he reigned as king of Judah and then all of Israel.

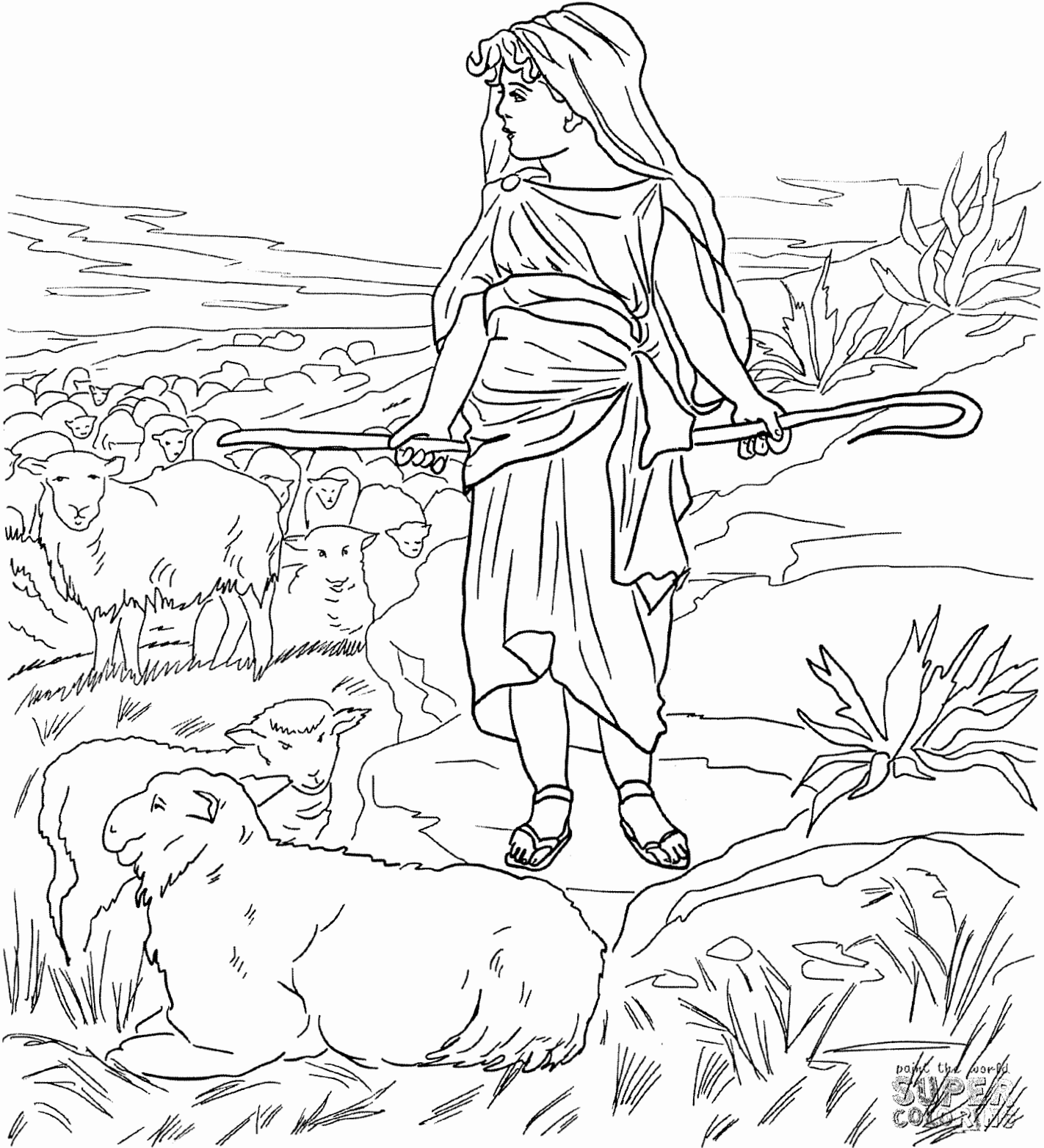

Done the World  
**SUPER**  
COLORING

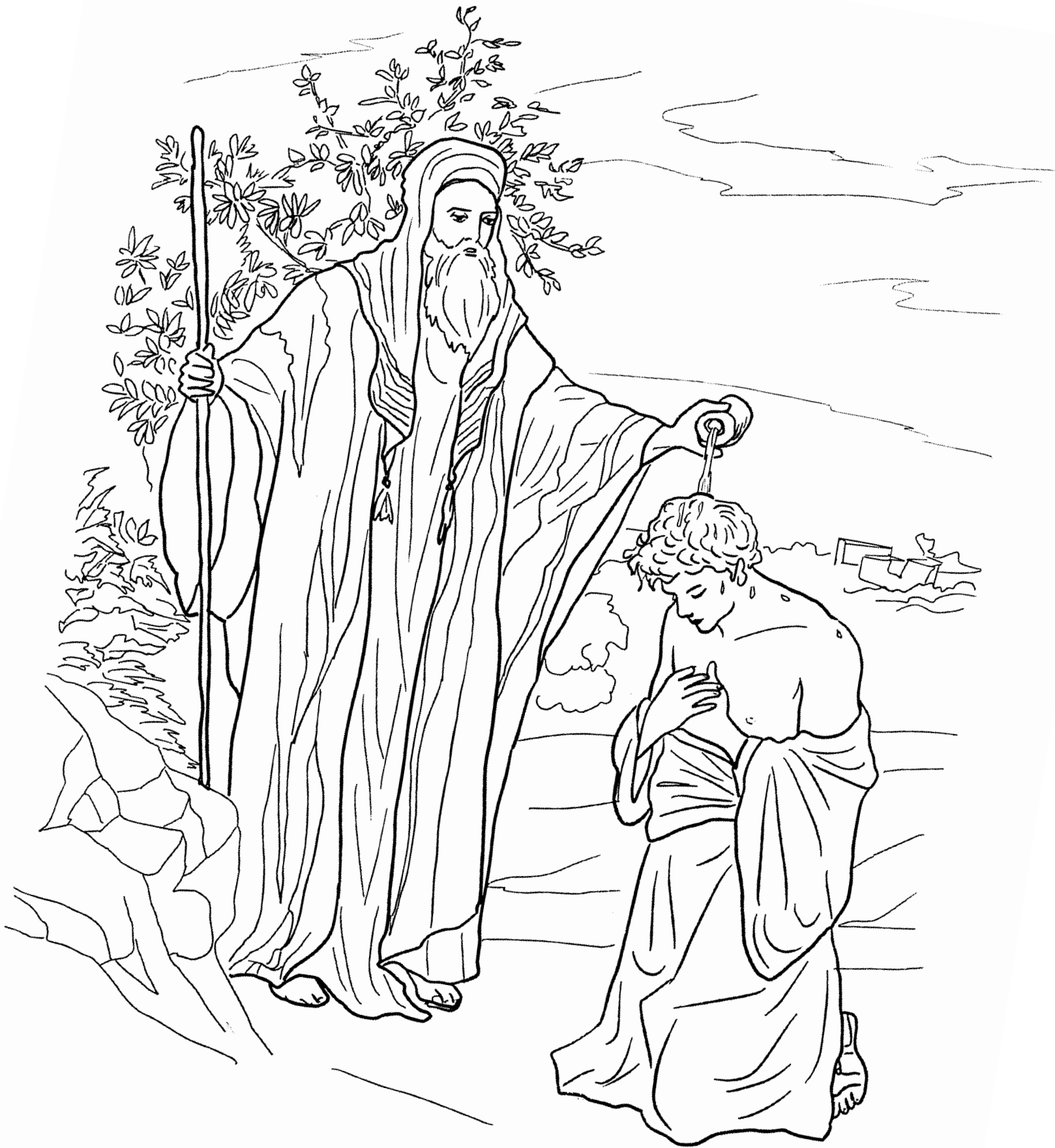

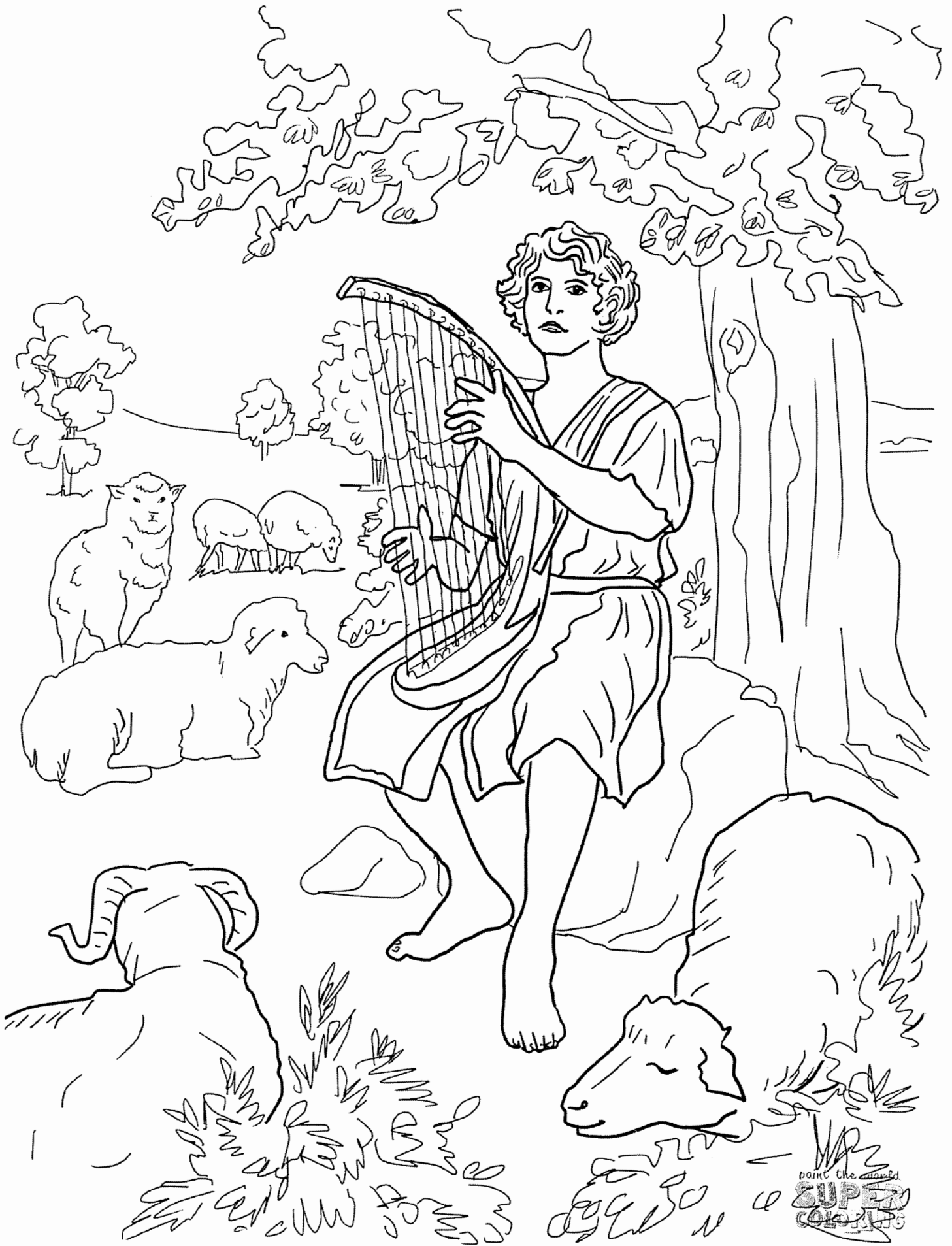

Paint the world  
**CUPED**  
COMING

**1.**

---

David was a  
shepherd boy.

---

**2.**

---

David was  
brave and strong.

---

**3.**

---

David fought  
for God.

---

**4.**

---

God chose  
David to be  
a king!

---



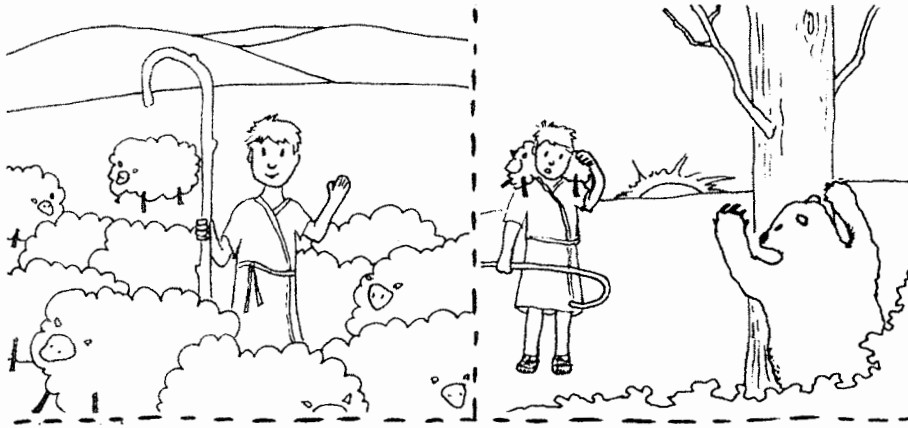

God grows and chooses David...

1 Samuel, 2 Samuel

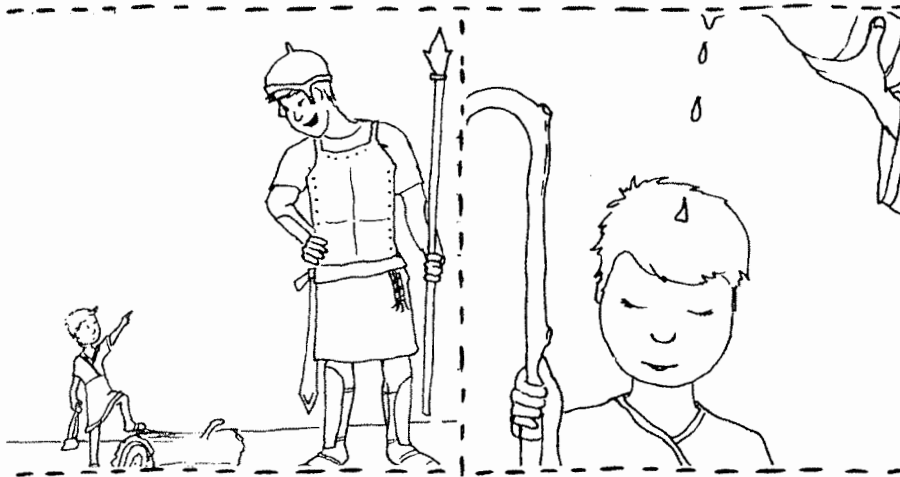

Mandy Groce '11

[ministry-to-children.com](http://ministry-to-children.com)

# SAMUEL ANOINTS DAVID

1 Samuel 16:1-13 (NIV)

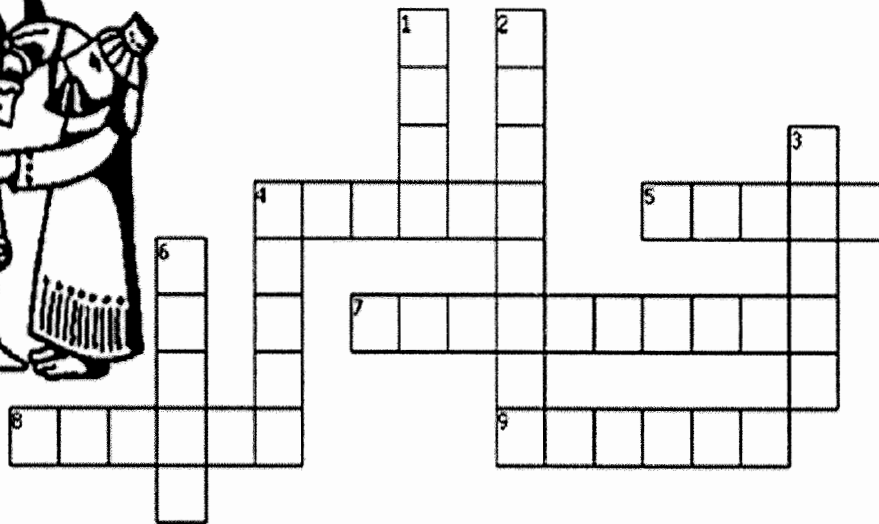

## ACROSS

4. Distance from the top to the bottom of something; how tall someone is
5. Strength, energy, or force
7. The way people seem to be, rather than how they are inside
8. To make someone holy by pouring oil on their head
9. The Prophet that God instructed to go Jesse's house in search of the new king

## DOWN

1. A man who rules a country
2. Males who have the same parents as another person; male siblings
3. The number of sons Jesse had in addition to David
4. The center of a person's emotions or the organ that pumps blood through the body
6. The one that God chose to replace Saul as king

## WORDS USED

Samuel	appearance	David	seven
king	heart	power	
height	anoint	brothers	

# David Is Chosen

1 Samuel 15, 16

# Chosen by God

This rhyme tells the story of how David became king, but all the rhyming words are missing! Choose a word from the word list that will help each line make sense. When you are finished, read the poem out loud together.

God said, "Samuel, I have chosen one  
to take the place of \_\_\_\_\_.  
He has disappointed me  
and can't be king at \_\_\_\_\_."

"Go to Bethlehem to see  
all eight of Jesse's \_\_\_\_\_.  
When the new king stands before you  
I'll say, 'Samuel, he's the \_\_\_\_\_.'"

Samuel looked at seven boys  
but let them each \_\_\_\_\_.  
"You're judging by their looks," said God,  
but I judge by the \_\_\_\_\_."

The last of Jesse's boys was David,  
a brave, young shepherd \_\_\_\_\_  
The Lord said, "Go! Appoint him,  
for he will bring you \_\_\_\_\_."

Samuel appointed David—  
he would later be the \_\_\_\_\_.  
When God give us a job to do,  
it is a splendid \_\_\_\_\_!

*all  
mall  
Saul  
call*

*run  
sun  
sons  
one*

*depart  
heart  
apart  
chart*

*toy  
boy  
joy  
annoy*

*swing  
ring  
king  
thing*



God Chooses a New King  
I Samuel 16

**Memory Verse:**

**“For the LORD sees not as man sees: man looks on the outward appearance, but the LORD looks on the heart.” I Sam 16:7b**

**Choose the best answer:**

God told Samuel he had chosen a new king from the household of \_\_\_\_\_.  
(v. 1)

- a. Saul
- b. Jesse
- c. David

Samuel and Jesse were both considering outward appearance, but God was more interested in: (v. 7)

- a. The heart.
- b. The mind.
- c. The body.

What came upon David as he was anointed? (v. 13)

- a. A feeling of joy.
- b. The ability to sing.
- c. The Spirit of the LORD.

David was called to enter Saul’s service to help soothe Saul by playing his: (v. 23)

- a. Flute.
- b. Violin.
- c. Lyre.

Saul \_\_\_\_\_ David. (v. 21)

- a. Loved.
- b. Hated.
- c. Despised.

God Chooses a New King  
I Samuel 16

**Memory Verse:**

**“But the LORD said to Samuel, ‘Do not look on his appearance or on the height of his stature, because I have rejected him. For the LORD sees not as man sees: man looks on the outward appearance, but the LORD looks on the heart.’” I Sam 16:7**

**Choose the best answer:**

God told Samuel he had chosen a new king from the household of \_\_\_\_\_.

- a. Saul
- b. Jesse
- c. David

The new king would come from the town of:

- a. Jerusalem.
- b. Bethany.
- c. Bethlehem.

Samuel and Jesse were both considering outward appearance, but God was more interested in:

- a. The heart.
- b. The mind.
- c. The body.

What came upon David as he was anointed?

- a. A feeling of joy.
- b. The ability to sing.
- c. The Spirit of the LORD.

After David was anointed, a \_\_\_\_\_ spirit tormented Saul.

- a. Evil.
- b. Harmful.
- c. Annoying.

David was called to enter Saul's service to help soothe Saul by playing his:

- a. Flute.
- b. Violin.
- c. Lyre.

Saul \_\_\_\_\_ David.

- a. Loved.
- b. Hated.
- c. Despised.

**Answer the following question in your own words:**

Samuel wanted to anoint a man as king because of how he looked without even knowing anything about him, but God judges based on what we look like inside! Make a list of qualities that God likes to see in our hearts and keep it with you this week to remind you what is most important.

# God Chooses a King

## Crossword

### God Chooses a King

But the LORD said to Samuel, "Do not consider his appearance or his height, for I have rejected him. The LORD does not look at the things people look at. People look at the outward appearance, but the LORD looks at the heart." 1 Samuel 16:7

The activity is based on 1 Samuel 16:1-13



*From the words provided for each clue, provide the letter of the word which best matches the clue.*

- \_\_\_ Distance from the top to the bottom of something; how tall someone is  
A. WIDTH B. HEIGHT C. APPEARANCE D. ANOINT
- \_\_\_ The way people seem to be, rather than how they are inside  
A. HEIGHT B. APPEARANCE C. POWER D. HEART
- \_\_\_ A man who rules a country  
A. DAVID B. KING C. SAMUEL D. JESSE
- \_\_\_ Strength, energy, or force  
A. HEIGHT B. POWER C. SAMUEL D. APPEARANCE
- \_\_\_ To make someone holy by pouring oil on their head  
A. ANOINT B. HEIGHT C. KING D. HEART
- \_\_\_ The Prophet that God instructed to go Jesse's house in search of the new king  
A. DAVID B. SAUL C. SAMUEL D. JESSE
- \_\_\_ The one that God chose to replace Saul as king  
A. SAMUEL B. JESSE C. DAVID D. ANOINT
- \_\_\_ The organ that pumps blood through the body  
A. HEIGHT B. POWER C. APPEARANCE D. HEART

## LESSON 1

# DAVID ANOINTED KING

I Sam. 16

**INTRODUCTION.** Because Saul disobeyed God in his expedition against the Amalekites by sparing Agag, the king, and the best of the animals, the Lord rejected him as king over Israel. Saul and Samuel each went to their own homes after the battle, and Samuel went to see Saul no more in his lifetime.

The Lord told Samuel to mourn no longer for Saul but to go on a secret mission to Bethlehem. There He instructed Samuel to anoint David, the youngest son of Jesse of the tribe of Judah, as the next king of Israel. Although God "rent" the kingdom from Saul, David did not actually become king until after Saul's death.

### A. DAVID ANOINTED KING (I Sam. 16:1-13)

1. The Lord told Samuel to mourn no longer for Saul since He had \_\_\_\_\_ him from reigning over Israel. (I Sam. 16:1)
2. The Lord told Samuel to fill his horn with \_\_\_\_\_ and go to Bethlehem. (I Sam. 16:1)
3. There He had provided himself a king among the \_\_\_\_\_ of Jesse. (I Sam. 16:1)
4. The Lord told Samuel to take a \_\_\_\_\_ with him for a sacrifice and call Jesse to the sacrifice. (I Sam. 16:2-3)
5. Samuel should \_\_\_\_\_ whom the Lord named. (I Sam. 16:3)
6. The elders of Bethlehem asked Samuel if he came \_\_\_\_\_. (I Sam. 16:4)
7. When Samuel said he came peaceably, he \_\_\_\_\_ Jesse and his sons, calling them to the sacrifice. (I Sam. 16:5)



8. When Samuel would have anointed Eliab, Jesse's oldest son, the Lord told him not to look on his \_\_\_\_\_ or \_\_\_\_\_. (I Sam. 16:6-7)
9. A man looks on the \_\_\_\_\_ appearance, but the Lord looks at the \_\_\_\_\_. (I Sam. 16:7)
10. Jesse made \_\_\_\_\_ of his sons pass before Samuel. (I Sam. 16:10)
11. Samuel told Jesse the Lord had not \_\_\_\_\_ these. (I Sam. 16:10)
12. When Samuel asked Jesse if he had more children, he said there remained the \_\_\_\_\_ who was keeping the sheep. (I Sam. 16:11)
13. Samuel told Jesse to send and \_\_\_\_\_ him. (I Sam. 16:11)
14. Describe the youngest son of Jesse. (I Sam. 16:12)
15. The Lord told Samuel to arise and \_\_\_\_\_ him, so Samuel took the horn of oil and anointed him in the midst of his brothers. (I Sam. 16:12-13)
16. The \_\_\_\_\_ came upon David from that day forward. (I Sam. 16:13)

**B. DAVID THE MUSICIAN.** David was a skilled musician. After God rejected Saul, the Spirit of the Lord left Saul and an evil spirit afflicted him. David was summoned from his father's house to play his harp before Saul and soothe his troubled spirit. Saul loved David greatly and made him his armor bearer (I Sam. 16:14-23).

1. Saul's servant described David as: (I Sam. 16:18)
  - a. the son of \_\_\_\_\_ the Bethlehemite
  - b. \_\_\_\_\_ in playing
  - c. a mighty man of \_\_\_\_\_

- d. a man of \_\_\_\_\_
  - e. \_\_\_\_\_ in speech
  - f. \_\_\_\_\_ person
  - g. the \_\_\_\_\_ is with him
2. When David came to Saul and stood before him, Saul \_\_\_\_\_ him greatly. (I Sam. 16:21)
  3. David became Saul's \_\_\_\_\_. (I Sam. 16:21)
  4. When the evil spirit came upon Saul, David played his \_\_\_\_\_, so Saul was refreshed and the evil spirit departed from him. (I Sam. 16:23)

*The Lord seeth not as man seeth;  
for man looketh on the outward appearance,  
but the Lord looketh on the heart.  
I Sam. 16:7*

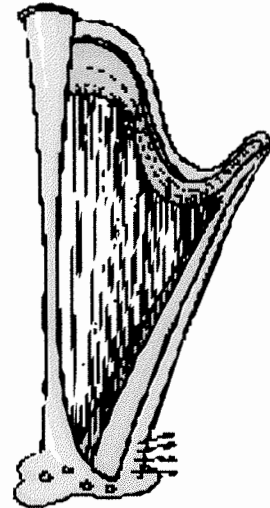

# Bible Pathway Adventures

CROSSWORD

## KING DAVID

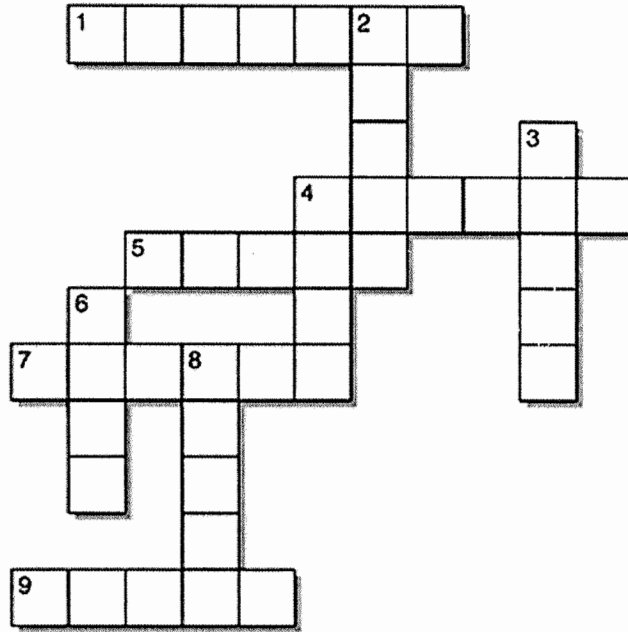

### ACROSS

- 1) Which Philistine did David defeat in battle? (1 Samuel 17:23 ESV)
- 4) Who anointed David as king of Israel? (1 Samuel 16:13 ESV)
- 5) Who did David have killed so he could marry his wife? (2 Samuel 11:6 ESV)
- 7) Saul gave David his daughter \_\_\_\_\_ for a wife. (1 Samuel 18:27 ESV)
- 9) David reigned for \_\_\_\_\_ years. (2 Samuel 5:4 ESV)

### DOWN

- 2) "How I love your \_\_\_\_\_! I meditate on it all day." (Psalm 119:97 CJB)
- 3) Name of David's father. (1 Samuel 16:1 ESV)
- 4) Which king tried to have David killed? (1 Samuel 19:1 ESV)
- 6) David took the stronghold of \_\_\_\_\_ - the city of David. (2 Samuel 5:7 ESV)
- 8) "I have found David, a man after My \_\_\_\_\_, who will do all My will." (Acts 13:22 ESV)

©Bible Pathway Adventures. For free Bible resources and Teacher Packs including coloring pages, worksheets, quizzes and more visit our website at: [biblepathwayadventures.com](http://biblepathwayadventures.com)

# Samuel Anoints David

## Word Search

### God Chooses a King

But the LORD said to Samuel, "Do not consider his appearance or his height, for I have rejected him. The LORD does not look at the things people look at. People look at the outward appearance, but the LORD looks at the heart." 1 Samuel 16:7

Based on 1 Samuel 16:1-13



W R E J E C T E D A D X M Z T  
 B Z Q C U L T E B J N L B A H  
 J C A L A G D M I B A O O Z H  
 X E U S N Q C H O S E N I R L  
 P A A I S H E A R T J S S N D  
 S L K P V H C Q Q S Q T S Q T  
 F N D S P K E C W I A H I T I  
 S C O A Q E Q P S P H M U O O  
 Y M T C K O A L H M J D U I E  
 L R S R I J L R U E L F P E Q  
 O D C I S E I T A A R U U E L  
 O R V F R S B Y O N H D X H M  
 W G F I A S W O Z X C K G G I  
 P M G C E E P K O U T E Z Y K  
 R A T E L R H A M D A V I D Q

APPEARANCE	SAMUEL	CHOSEN	HEART	PEACE
REJECTED	DAVID	SHEPHERD	ANOINT	LORD
SAUL	ISRAEL	SACRIFICE	KING	JESSE

Copyright © Sermons 4 Kids, Inc. • All Rights Reserved • [www.sermons4kids.com](http://www.sermons4kids.com)

# Samuel Anoints David

## Decoder

### God Chooses a King

But the LORD said to Samuel, "Do not consider his appearance or his height, for I have rejected him. The LORD does not look at the things people look at. People look at the outward appearance, but the LORD looks at the heart." 1 Samuel 16:7

Each number represents a letter of the alphabet. Substitute the correct letter for the numbers to reveal the coded words.



Ó	W	A	T	I	R	E	O	É	N	M	L	C	G	P	A
1	2	3	4	5	6	7	8	9	10	11	12	13	14	15	16
Z	Ñ	V	J	D	S	U	B	H	F	Q	X	Ú	Y	K	I
17	18	19	20	21	22	23	24	25	26	27	28	29	30	31	32

- 22-3-11-23-7-12 \_\_\_\_\_
- 20-7-22-22-7 \_\_\_\_\_
- 21-3-19-32-21 \_\_\_\_\_
- 25-7-3-6-4 \_\_\_\_\_
- 22-25-7-15-25-7-6-21 \_\_\_\_\_
- 3-10-8-32-10-4 \_\_\_\_\_
- 31-32-10-14 \_\_\_\_\_
- 32-22-6-3-7-12 \_\_\_\_\_

ISRAEL	KING	JESSE	HEART
SAMUEL	DAVID	SHEPHERD	ANOINT

Copyright © Sermons 4 Kids, Inc. • All rights reserved • [www.sermons4kids.com](http://www.sermons4kids.com)

**Year 2**

**Week 72**

## **David and Goliath**

**Scriptures: 1 Samuel 17**

**Key Verse: 1 Samuel 17:37** “Moreover David said, ‘The Lord, who delivered me from the paw of the lion and from the paw of the bear, He will deliver me from the hand of this Philistine.’ And Saul said to David, ‘Go and the Lord be with you.’”

**Key Points:**

1. A giant Philistine named Goliath challenged God and the Israelite army for 40 days morning and evening to send a man to fight with him. Goliath was a trained warrior and a huge opponent at over 9 feet tall (describe his shield, spear, and armor, etc.). His challenge was for the losing nation to serve the winning nation.
2. David, a young man was taking provisions to his 3 older brothers. He overheard Goliath’s taunts and saw the fearful reactions of the Israelite army. David understood this wasn’t a battle of might but of right. He knew God would deliver Goliath into his hand because Goliath challenged even God.
3. David selected 5 smooth stones from the brook and placed them in his shepherd’s bag. He also took his sling and got closer to Goliath as he thundered his taunt. David, confident in his Father in heaven hurried and slung the first stone at Goliath.
4. The stone sank into Goliath’s forehead and killed him causing all the Philistines to run away in defeat.
5. David was brought before King Saul after the slaughter of the Philistine army. He held the head of Goliath in his hand.

# David's Song

Tune "He is Able to Deliver Thee"

Patsy Stevens



When the shep-erd boy met Go - li - ath tall He was not a - fraid; God was o - ver all.  
How the gi - ant cursed and came out to fight With the shep-herd boy in the bright sun-light.  
So what - ev - er hap - pens to come my way, I am not a - lone, I will think to pray.



He took five smoothstones From the bab-bling broo-k With his sling that's all that he too - k.  
Da - vid took a stone, slung it round and rou-nd, Then the giant came tum-bling to the grou-nd.  
God will hear my pray'r, answer me soon ther - e My God is a - ble to de - liv - er me.

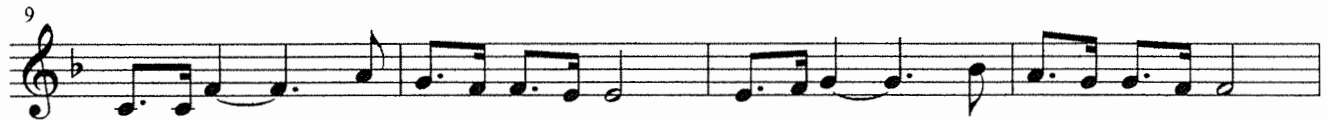

God is a - ble to de-liv - er me. God is a - ble to de-liv - er me.



Though the giant is near I will nev - er fear My God is a - ble to de - liver me.

# 79. DAVID & GOLIATH

(1 SAMUEL 17:1-52)



"Then said David to the Philistine, Thou comest to me with a sword, and with a spear, and with a shield: but I come to thee in the name of the LORD of hosts, the God of the armies of Israel, whom thou hast defied."

**1 SAMUEL 17:45**



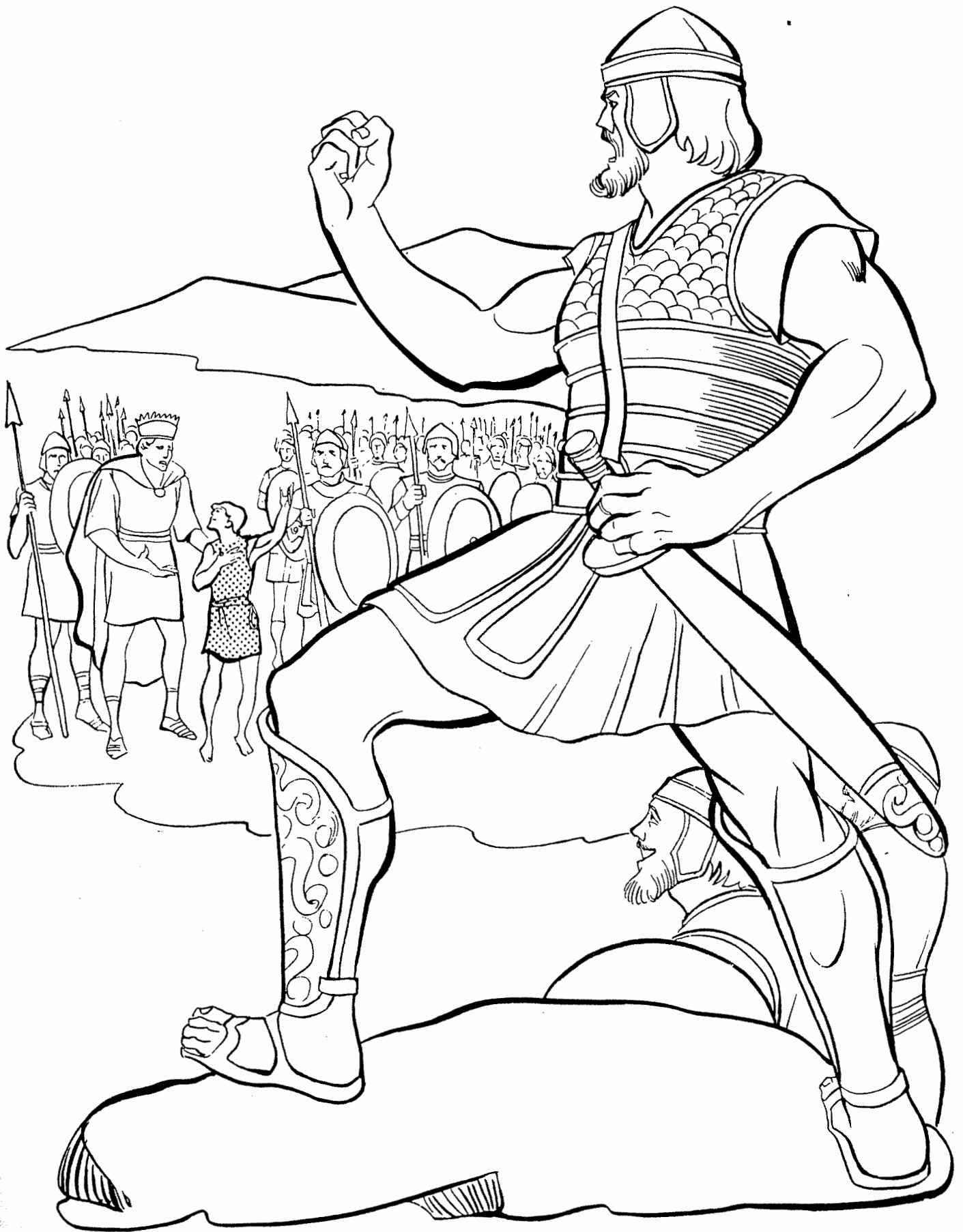

Young David, though small, accepted the challenge to fight the nine-foot giant, Goliath.



In the name of God, David killed the nine-foot . . .



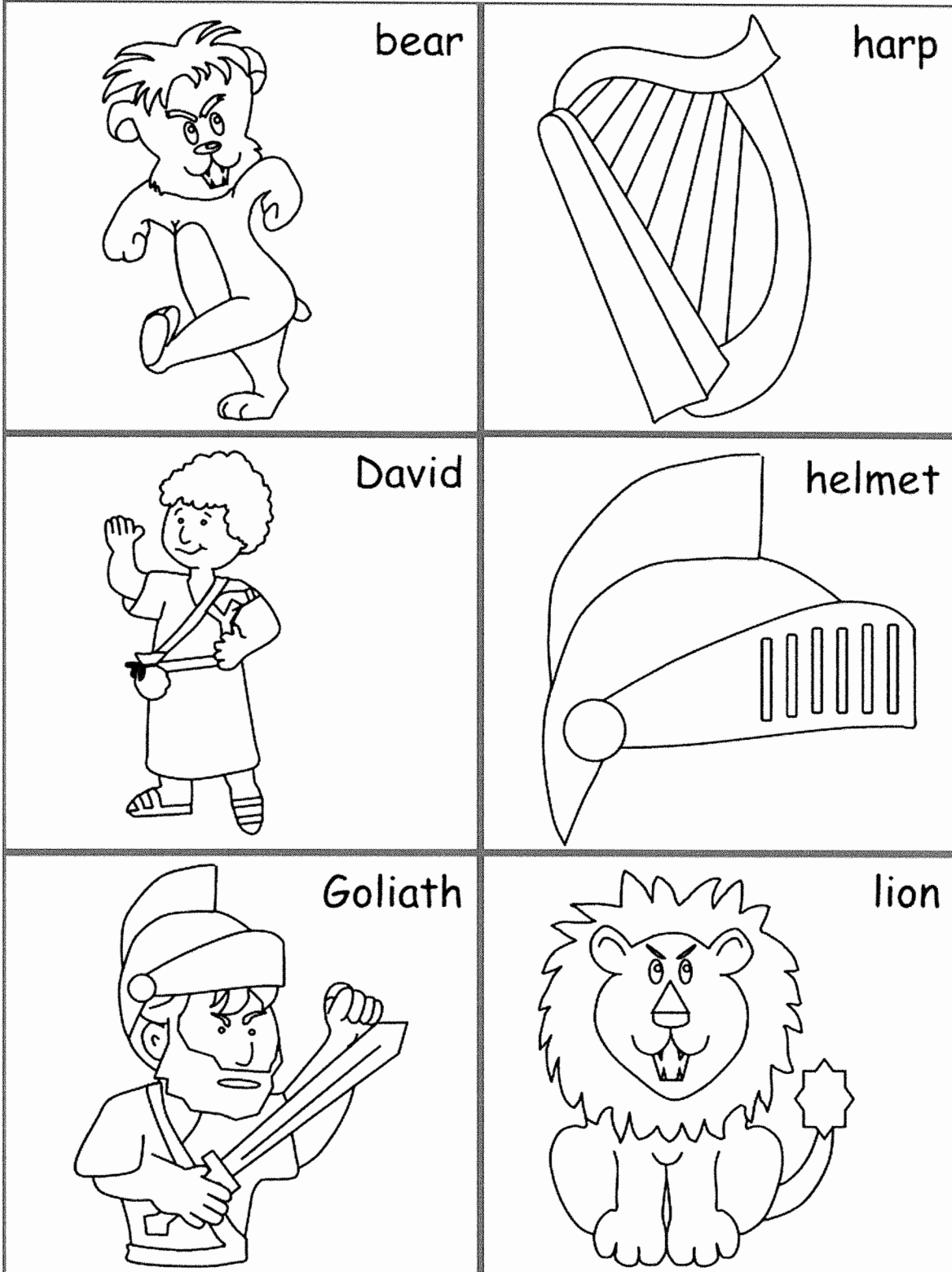

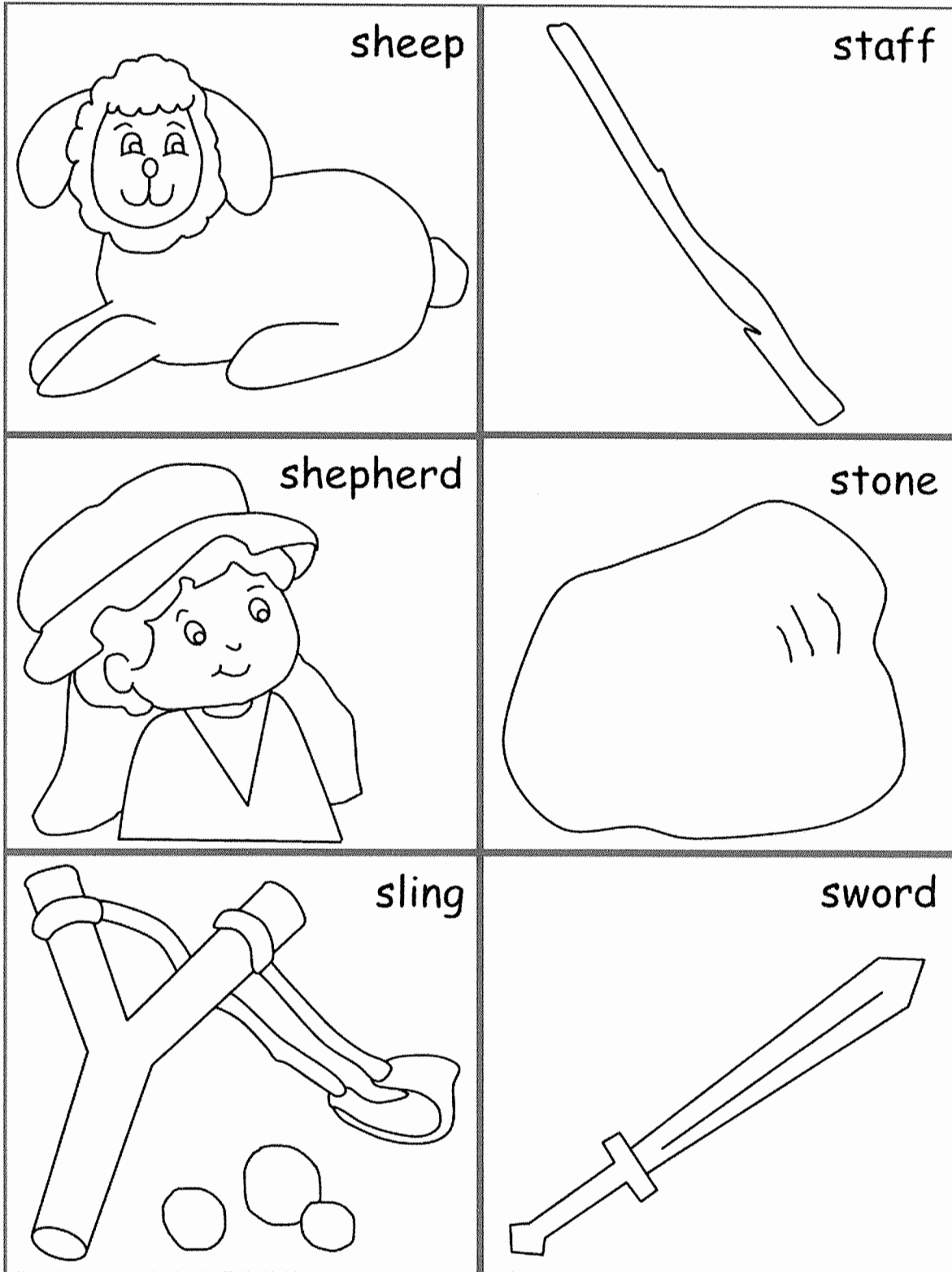

# 1. Free Play

- arrange the cards into piles (you can add coloured backgrounds to make it easier for the children to sort the words into nouns, verbs, etc).
- allow the children to create their own sentences using the cards.
- If you pre-sort the cards for them it makes it simpler. You may not want to provide them with all the sets at once. Here are some set ideas.
  - three piles: helpers, nouns and emotions  
Example sentence: The boy was happy.
  - four piles: helpers, nouns, verbs and nouns  
Example sentence: The boy ate the apple.
  - five piles: helpers, nouns, verbs, colors and nouns.  
Example sentence: The boy ate a red apple.
  - six piles: helpers, emotions, nouns, verbs, colors and nouns.  
Example sentence: The happy boy ate a red apple.
- **Get silly!** It's fun to create silly sentences (like "The angry boy ate a green monster.") Encouraging the children to create silly sentences can help keep them involved and motivated in this activity.
- **ADDITIONAL ACTIVITY:** Have the child spend some time creating their favorite sentence.
  - Once the sentence is completed, encourage them to write (or dictate, depending on their skill level) a short story to go with the sentence.
  - With young children, 3 sentences is a great story length. It helps reinforce the fact that a story has a BEGINNING, a MIDDLE and an END.
  - Let them illustrate their story (draw pictures).
  - Talk about the roles of the author and the illustrator of a story.

# 2. Memory (Guided) Play

- In this activity, we'll use sight (showing), sound (reading) and repetition (memory) to reinforce sentence structure.
- arrange the cards into piles (the verbs have a colored background to make it a tad easier for the kids to sort things) If you pre-sort the cards for them it makes it simpler. You may not want to provide them with all the sets at once. Here are some set ideas.
  - three piles: helpers, nouns and emotions  
Example sentence: The boy was happy.
  - four piles: helpers, nouns, verbs and nouns  
Example sentence: The boy ate the apple.
  - five piles: helpers, nouns, verbs, colors and nouns.  
Example sentence: The boy ate a red apple.
  - six piles: helpers, emotions, nouns, verbs, colors and nouns.  
Example sentence: The happy boy ate a red apple.
- Create a sentence, show it to the child and read it aloud twice.

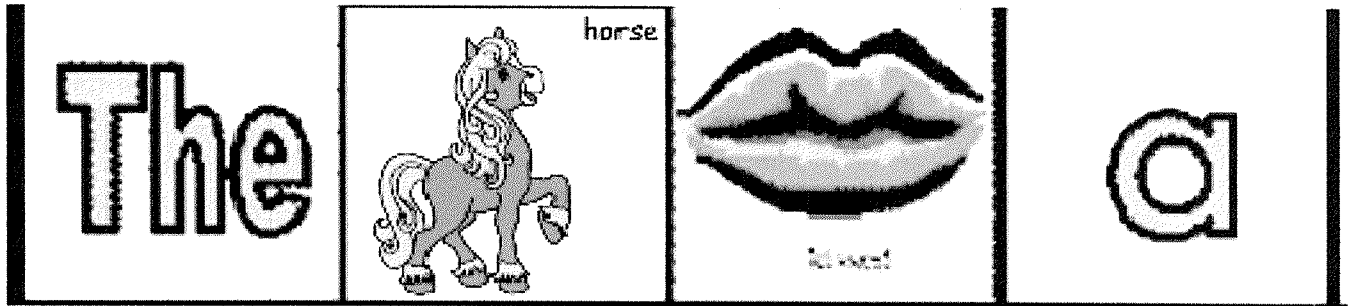

- Now put one of the cards back in the appropriate (noun, verb, emotion, color) pile

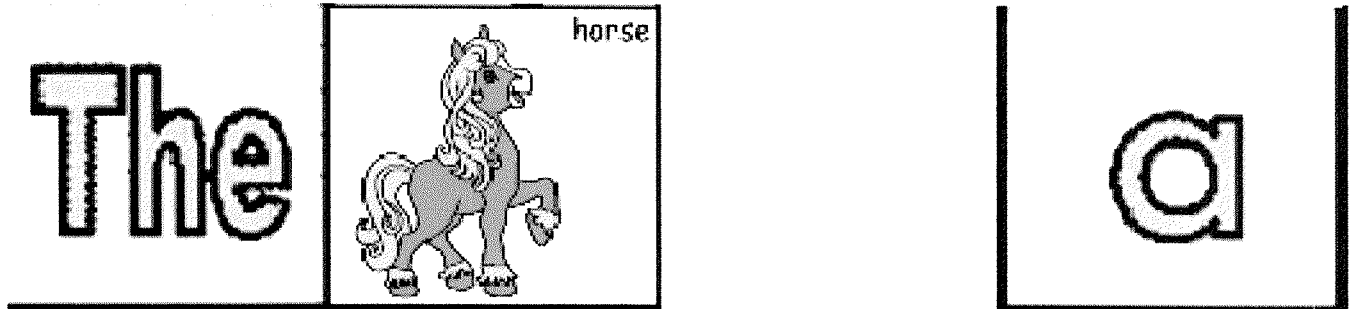

(you may want to mix up the pile and then set some or all the pile out so the child can see their options, like so):

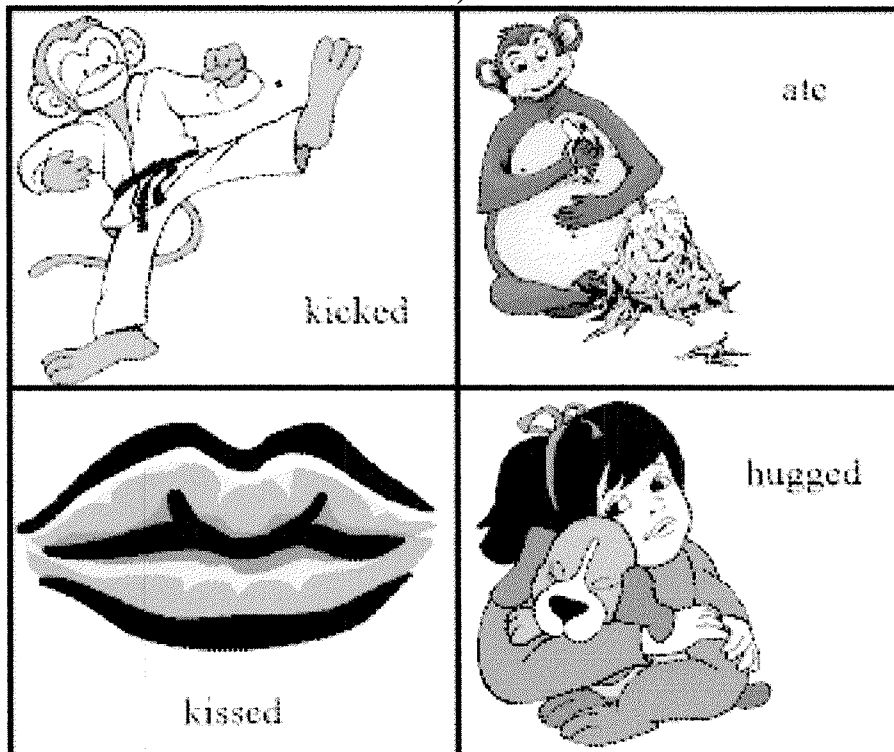

Now have the child chose the correct card from memory to replicate the sentence you showed them.

- When the child has mastered replacing a single card, try removing two of the cards (maybe kissed and dinosaur in our example above). Then remove three, etc. Progressively make the sentences longer until they are successfully replicating complex sentences -- For example, "The happy dinosaur and the green monster ate a red apple."

- 
- Eventually you can move away from showing them the sentence. You can just READ the sentence to them and have them replicate it.
  - Don't forget to throw in some silly sentences to keep the children's energy level up!



Name: \_\_\_\_\_



### Story Comprehension and Memory Worksheet:

After learning about the story of David and Goliath, which of the pictures below do you think belong?

Circle the pictures that belong. Draw an X over the pictures that do not belong.

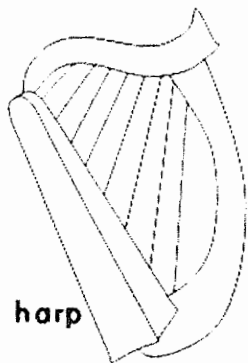

harp

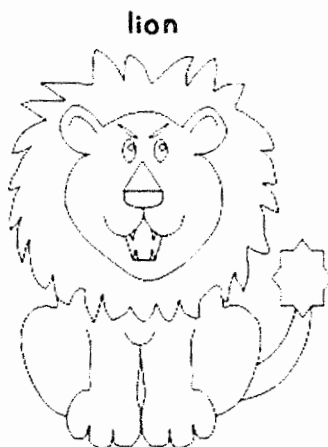

lion

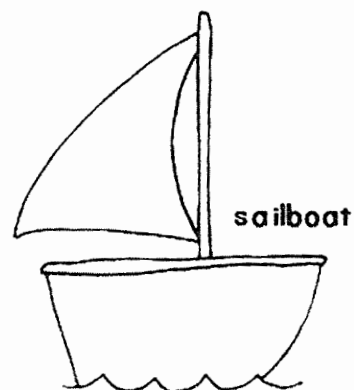

sailboat

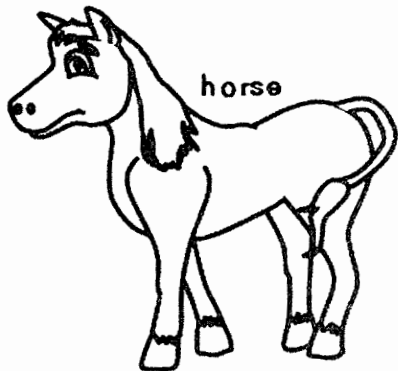

horse



shepherd

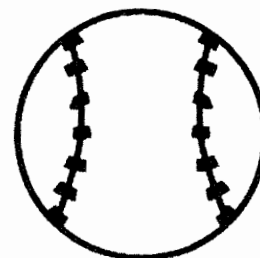

baseball

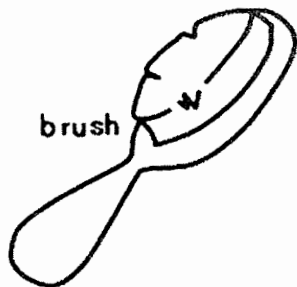

brush

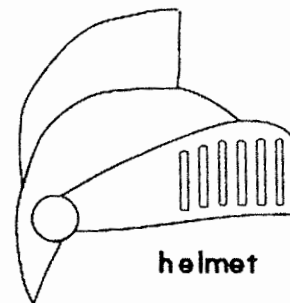

helmet

Name: \_\_\_\_\_



### Story Comprehension and Memory Worksheet:

After learning about the story of David and Goliath, which of the pictures below do you think belong?

Circle the pictures that belong. Draw an X over the pictures that do not belong.



**Year 2**

**Week 73**

### **Saul Tries To Kill David**

**Scriptures: 1 Samuel 18 and 19**

**Key Verse: 1 Samuel 18:12 “Now Saul was afraid of David because the Lord was with him, but had departed from Saul.”**

**Key Points:**

1. The ladies of Israel sang and danced to celebrate David’s great victory over the Philistines. Saul was prideful and fearful and plotted to kill David or place him in harm’s way. Saul was jealous.
2. But, David played his harp faithfully to soothe Saul when a “distressing spirit” came upon Saul. This spirit of trouble was sent from God after God’s Spirit left Saul (see 1 Samuel 16: 14-16). As he was playing, Saul cast his spear at David. This happened twice with David escaping both times. Saul knew that the Lord was with David.
3. Saul promoted David to command 1,000 soldiers hoping he would be killed in battle. The Israelite people loved David and God prospered David in all that he did.
4. Saul went so far with his evil plans as to try to have his servants and son and daughter harm David. Jonathan, Saul’s son, was a dear and beloved friend to David who reminded his father not to sin against David who had defeated the Philistine army.
5. Once again, Saul hurled his spear at David while he played his harp. Michal, Saul’s daughter and David’s wife, helped David escape through a window. David sought safety with Samuel the prophet in Ramah. Instead of capturing David when Saul and his servants went to Ramah, they prophesied and praised God.

And it came to pass, when the evil spirit from God was upon Saul, that David took an harp, and played with his hand: so Saul was refreshed, and was well, and the evil spirit departed from him. *1 Samuel 16:23*

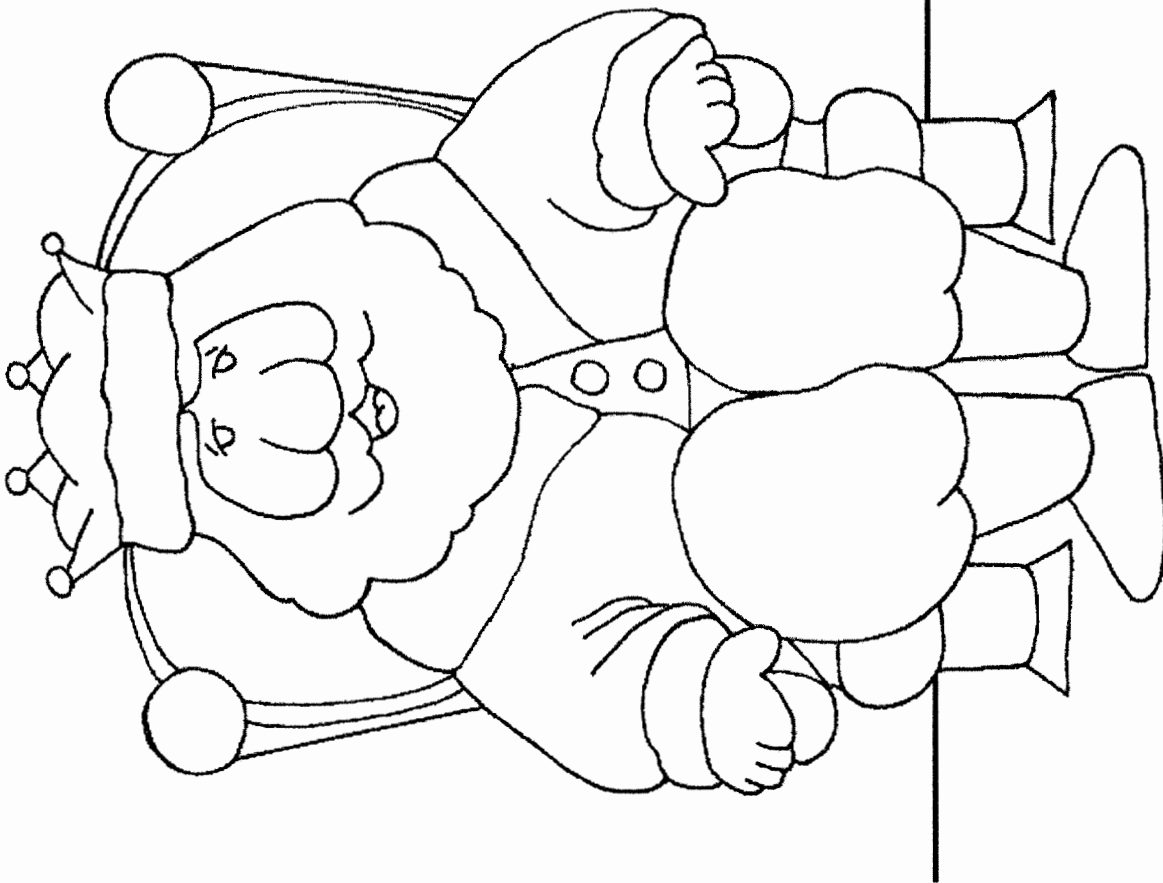



SUPER  
COLORING



# ▶ DAVID

## A GOOD FRIEND

### MEMORY VERSE

1 Samuel 23:16-18; 2 Samuel 9

*I will... show you kindness. ~ 2 Samuel 9:7 NIV*

**INTRODUCTION** David and Jonathan were good friends. They promised each other they would be friends forever. Once when David was going through a hard time, Jonathan made him feel better. Even after Jonathan died, David wanted to show love to his friend. So he found one of Jonathan's sons and showed kindness to him instead.

**A CLAY FOREVER HEART** Do you have a special friend? With the dough your teacher gives you, shape a heart. With the eraser of your pencil, push a hole up through the heart. Carefully take the heart off the pencil and lay it on wax paper to dry. After you make the flag below, stand it in the dried heart. Give the heart to your special friend and promise to be kind to him or her forever.

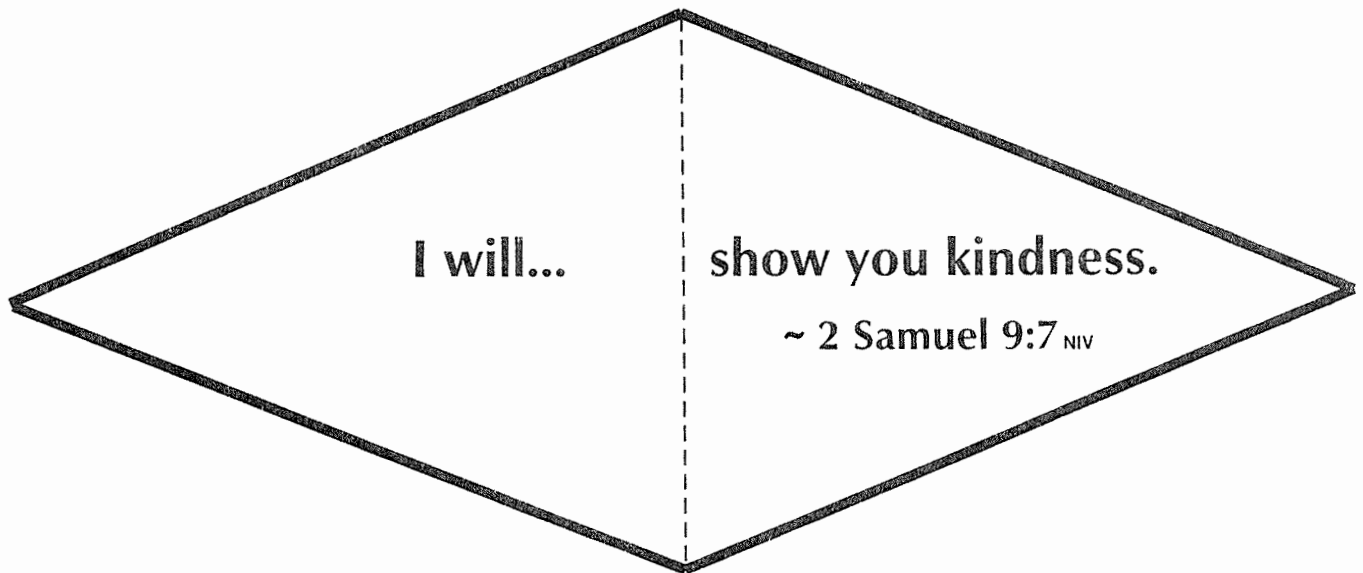

**FOR THE TEACHER** This craft will take several days to dry. Duplicate a pencil flag for each child. Provide a pencil for each child. Mix 2 cups of flour, 1 cup of salt and  $\frac{1}{2}$  cup of water (one batch of dough makes 15 hearts). Give a dough ball to each child and assist in shaping hearts. After the hearts harden, assist in gluing them to the pencil erasers. Discuss what a friend is and how the children can be good friends. Allow each child to tell you something special about one of his or her friends. Share something special about your best friend, Jesus, too.

**BibleWise**  
David Flees from Saul  
1 Samuel 21-37



Taken from Amazing Mazes for Kids by Steve and Becky Miller. Copyright © 1998 and published by Harvest House Publishers, Eugene, OR. Used by permission.



# Jonathan and David

I Samuel 18:3-4; 19:1-7; 20:1-42

King Saul had a son named Jonathan. King Saul was jealous of David. But was Jonathan jealous of David? No. In fact, Jonathan should have been the second King of Israel, but Samuel said God wanted David to follow Saul as king but Jonathan truly loved David as a brother.

**Directions:** To see the present Jonathan gave David to show his love, write the first letter of each picture in the box next to it.

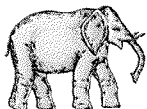
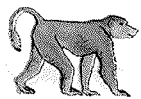
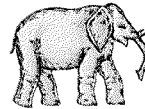
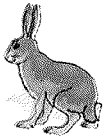

# Jonathan and David

I Samuel 18:3-4; 19:1-7; 20:1-42

King Saul had a son named Jonathan. King Saul was jealous of David. But was Jonathan jealous of David? No. In fact, Jonathan should have been the second King of Israel, but Samuel said God wanted David to follow Saul as king but Jonathan truly loved David as a brother.

**Directions:** To see the present Jonathan gave David to show his love, write the first letter of each picture in the box next to it.

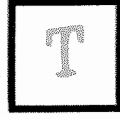
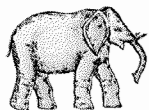
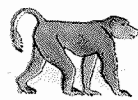
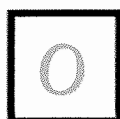
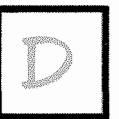
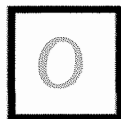
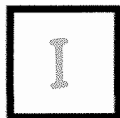
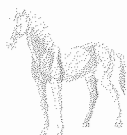
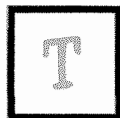
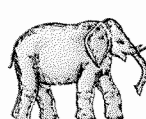

David and  
Jonathan  
1 Samuel 20

# Friends Forever!

When David was serving King Saul, he became good friends with Saul's son, Jonathan. David and Jonathan were such good friends that when Saul decided to try to kill David, Jonathan warned David so he could get away.

To find out what Jonathan said to David, go around the path twice. First, put every letter in a circle on the lines below. Then go back and use every letter in a box.

START →

G	E	O	F	I	R	N	I	P	
B								E	
R								E	
L								R	
E								A	
L								D	
V								C	
I	E	W	R	E	O	W	F	E	S



-----

-----

# Friends Forever

Trace the path to each star to find the scrambled words. Then fill in the sentences about the story from 1 Samuel 19, 20, and 2 Samuel 9.



1. Saul told Jonathan to \_\_\_\_\_ David.
2. Jonathan \_\_\_\_\_ David that Saul wanted to kill David.
3. Jonathan \_\_\_\_\_ his friend David.
4. They swore \_\_\_\_\_ with each other in the name of the Lord.
5. When David became king, he rewarded the \_\_\_\_\_ of Jonathan for his father's kindness.

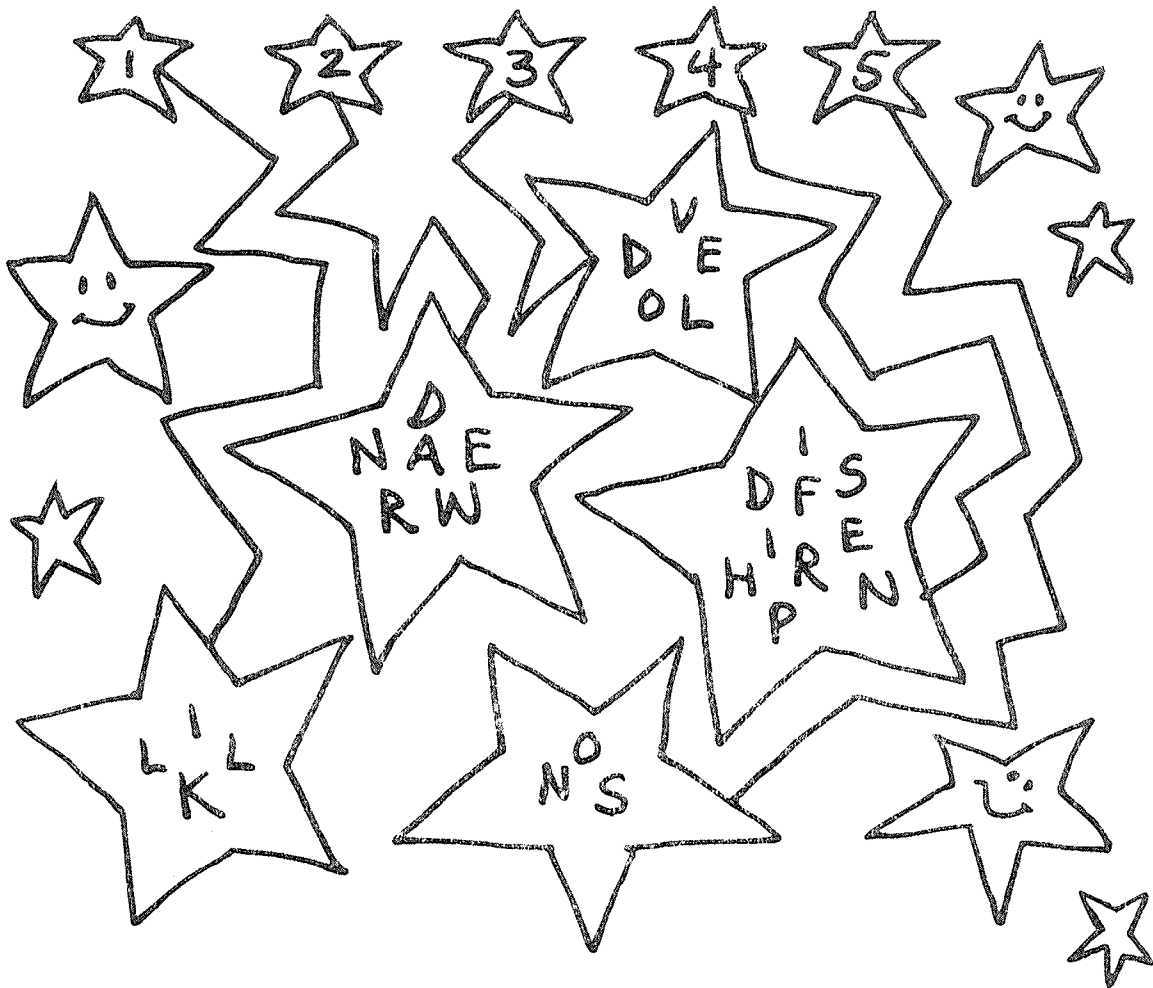

# JONATHAN AND DAVID

Puzzle Forty-four

E

I

O

E

ABNER	H A G Q N C T S U R T R H W F E
BATTLE	T W P Z B A O D Q B O R W K O H
BOND	E D I V A D H V S L P Z E I V V
COUNSELOR	H L H G T H M T E S B A P N K L
COVENANT	S Z S B T P O S A N G E F D B U
DAVID	O G D R L N N L I N A I K N H A
FRIENDSHIP	B O N D E U M Z N C O N I E A S
HERO	I K E P O S O N E A F H T S M L
JEHONATHAN	H L I C N A R R A T I V E S A A
JESSE	P L R N P N S L C H O O T J R C
JONATHAN	E C F P G L Q Q F J T N T R E D
KINDNESS	M T G I L B O A K L A A A H S N
KING	N A O L T U T T Q V D E N L S W
LOVE	Z V A C G N I T R A P A U O E K
MEPHIBOSHETH	C W A T L O R E H S L I J V J X
MT. GILBOA	B P P J P L S M C U X A Z E V A

NAIOTH

PLOT

SPEAR

NARRATIVES

PSALMS

STONE PILE

PACT

RAMAH

TRUST

PARTING

SAUL

VOW

PEACE

SERVANTS

WALL

# 80. THE FRIENDSHIP OF DAVID AND JONATHAN

## (1 SAMUEL 20)

### MEMORY VERSE:

*"May the LORD be between you and me, and between your descendants and my descendants forever." 1 SAMUEL 20:42*

### TRUE OR FALSE:

1. "David fled from Naioth in Ramah, and went and said to Jonathan, 'What have I done? What is my iniquity, and what is my sin before your father, that he seeks my life?' " **1 SAMUEL 20:1**  
**TRUE OR FALSE**
2. "And David said to Jonathan, 'Indeed tomorrow is the New Moon, and I should not fail to sit with the king to eat. But let me go, that I may hide in the field until the third day at evening.' " **1 SAMUEL 20:5**  
**TRUE OR FALSE**

### FILL IN THE BLANKS:

3. "If your father misses me at all, then say, 'David earnestly asked permission of me that he might run over to \_\_\_\_\_, his city, for there is a yearly sacrifice there for all the family.' " **1 SAMUEL 20:6**
4. "If he says thus: 'It is well,' your servant will be safe. But if he is very \_\_\_\_\_, be sure that evil is determined by him." **1 SAMUEL 20:7**
5. "If it pleases my father to do you evil, then I will report it to you and send you away, that you may go in \_\_\_\_\_. And the LORD be with you as He has been with my father." **1 SAMUEL 20:13**

### TRUE OR FALSE:

6. Jonathan would not cause David to vow, because he did not like David. **1 SAMUEL 20:17**  
**TRUE OR FALSE**

### FILL IN THE BLANKS:

7. "Then Jonathan said to David, 'Tomorrow is the New Moon; and you will be missed, because your seat will be \_\_\_\_\_. And when you have stayed three days, go down quickly and come to the place where you hid on the day of the deed; and remain by the \_\_\_\_\_ Ezel.' " **1 SAMUEL 20:18-19**
8. Jonathan said, "I will shoot three \_\_\_\_\_ to the side of it, as though I shot at a target; and there I will send a lad." **1 SAMUEL 20:20-21**
9. Then Jonathan said, "If I expressly say to him, 'Look, the arrows are on this side of you; get them and come' - then, as the LORD lives, there is \_\_\_\_\_ for you and no harm. But if I say thus to the young man, 'Look, the arrows are beyond you' - go your way, for the \_\_\_\_\_ has sent you away." **1 SAMUEL 20:21-22**
10. When it was clear that Saul was indeed after David, "Jonathan said to David, 'Go in \_\_\_\_\_, since we have both sworn in the name of the LORD, saying, "May the LORD be between you and me, and between your descendants and my descendants forever." ' " **1 SAMUEL 20:42**

# 80. THE FRIENDSHIP OF DAVID AND JONATHAN

## (1 SAMUEL 20)

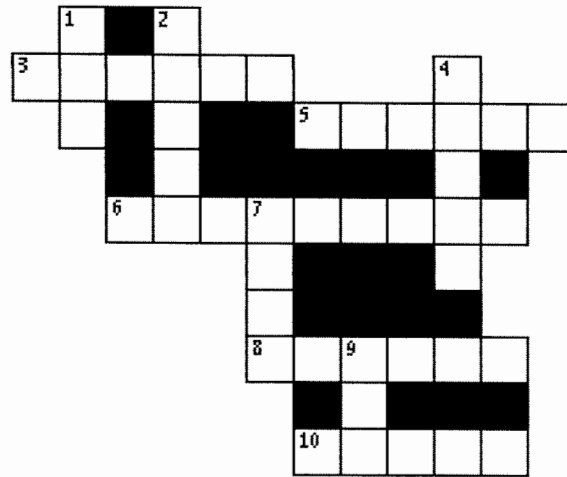

- 9 DOWN "David fled from Naioth in Ramah, and went and said to Jonathan, 'What have I done? What is my iniquity, and what is my \_\_\_\_\_ before your father, that he seeks my life?' " **1 SAMUEL 20:1**
- 1 DOWN "And David said to Jonathan, 'Indeed tomorrow is the New Moon, and I should not fail to sit with the king to \_\_\_\_\_.'" **1 SAMUEL 20:5**
- 6 ACROSS "If your father misses me at all, then say, 'David earnestly asked permission of me that he might run over to \_\_\_\_\_, his city, for there is a yearly sacrifice there for all the family.'" **1 SAMUEL 20:6**
- 10 ACROSS "If he says thus: 'It is well,' your servant will be safe. But if he is very \_\_\_\_\_, be sure that evil is determined by him." **1 SAMUEL 20:7**
- 3 ACROSS "If it pleases my father to do you evil, then I will report it to you and send you away, that you may go in \_\_\_\_\_. And the LORD be with you as He has been with my father." **1 SAM. 20:13**
- 4 DOWN "Jonathan again caused David to vow, because he \_\_\_\_\_him; for he loved him as he loved his own soul." **1 SAMUEL 20:17**
- 8 ACROSS "Then Jonathan said to David, 'Tomorrow is the New Moon; and you will be missed, because your seat will be \_\_\_\_\_.'" **1 SAMUEL 20:18**
- 5 ACROSS Jonathan said, "I will shoot three \_\_\_\_\_ to the side of it, as though I shot at a target; and there I will send a lad." **1 SAMUEL 20:20-21**
- 7 DOWN Then Jonathan said, "If I expressly say to him, 'Look, the arrows are on this side of you; get them and come' - then, as the LORD lives, there is safety for you and no \_\_\_\_\_." **1 SAMUEL 20:21**
- 2 DOWN "Jonathan said to David, 'Go in \_\_\_\_\_.'" **1 SAMUEL 20:42**

Name \_\_\_\_\_

Date \_\_\_\_\_

## SuperKids WordSearch Puzzle

D F T H W D I R R I N R A O D S  
 E O N F S A U L Y R T E F N S I  
 P E E C A V E T R X L G G T M T  
 M G F N S I M I D F F N G L A M  
 N C P S Z D I O D Y L D E S E S  
 A U U R O D H S N A A R W E H L  
 D Y W E Q E C N H I T L R F T O  
 C T I I O A L L L H I H H L B P  
 A P L D A N D R T V M I N X H E  
 E R R S C O R N E R P Q I S B L  
 G D B D O I O S A T O N I Z A F  
 W Y M G S N B H X C S S E D E T  
 X B C C O T E S D U H A R D S R  
 O N I E P E C A L J M V W E S F  
 A A I R H D R F M M R Q S M L E  
 O L D A I N G R C R N N E M P S

Find the following hidden words:

david, saul, cave, robe, corner, harm, anointed, good, evil,

Make your own SuperKids WordSearch Puzzles at: <http://www.superkids.com/aweb/tools/words/search/>

Copyright © 1999 Knowledge Share LLC. May be photocopied for personal or school use only.





# Jonathan's Secret Code

Jonathan and David were good friends. Jonathan's father, King Saul, wanted to kill David, so David had to run away and hide. Jonathan used a secret code to tell David whether it was safe for him to come back to the king's house.

While David hid in the field, Jonathan would shoot three arrows. If Jonathan told his armor bearer that the arrows were closer than the spot where David was hiding it meant:

(Use the Morse code to find the meaning.)

T H A T      T H E R E      W A S  
 -   ●●●● ●-   -      -   ●●●● ● ●●● ●      ●- - ●- ●●●  
P E A C E  
 ●- - ● ●- - ●- ● ●      I Samuel 20:21

If he said that the arrows were farther than where David was it meant:

G O      A W A Y — M Y  
 - - ●   - - -      ●- ●- - ●- - - -      - - - - -  
F A T H E R      W A N T S  
 ●- - ● ●-   -   ●●●● ● ●●●      ●- - ●- ●- - ●●●  
T O      K I L L      Y O U  
 -   - - -      - ●- ●● ●- - ●- - -      - - - - - ●●-      I Samuel 20:22

International Morse Code									
a	●-	b	-●●●	c	-●-●	d	-●●	e	●
f	●●-●	g	-●-●	h	●●●●	i	●●	j	●- - -
k	-●-	l	●-●●	m	- -	n	-●	o	- - -
p	●- - ●	q	- - - ●	r	●-●	s	●●●	t	-
u	●●-	v	●●●-	w	●- -	x	-●- -	y	- - - ●
		z	- - - ●						

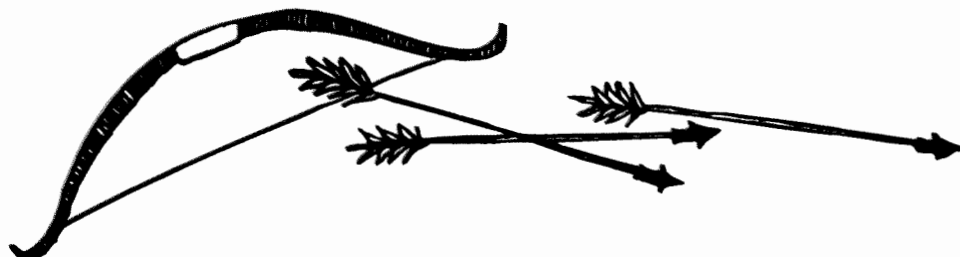

# BibleWise

## Discussion Questions – Jonathan and David's Friendship

Read 1 Samuel 20

- Who was David's best friend?
- How do David and Jonathan get acquainted?
- What is Jonathan's plan to save David if Saul tries to kill David? (1 Samuel 20:12-23)
- Is Jonathan being disloyal to his father, Saul? Why or why not?
- Why does King Saul want to kill David?
- What is jealousy?
- How do we keep ourselves and others from being jealous?
- Which commandment does jealousy break?
- Define "friendship."
  - What qualities are necessary to make a good friend?
  - Describe your best friend?
  - How do you decide to be someone's friend?
  - Are you a good friend?

Saul Tries to Kill David  
I Samuel 18-19

**Memory Verse:**

**“Saul was afraid of David because the LORD was with him but had departed from Saul.” I Sam 18:12**

**Choose the best answer:**

Saul began to dislike David because the people loved David. Saul was:  
(18:8-9)

- a. Glad.
- b. Jealous.
- c. Tired.

Saul tried to kill David with his spear \_\_\_\_\_. (18:11, 19:10)

- a. Once.
- b. Two times.
- c. Three times.

Why was Saul truly afraid of David? (18:12)

- a. David was very strong.
- b. David was very handsome.
- c. David had the Spirit of God.

David was able to escape because Michal: (19:13-14)

- a. Pretended he was sick in bed.
- b. Distracted the guards with a fancy dinner.
- c. Sent the men in the wrong direction.

Each person sent to take David was overcome with the Spirit of God and instead of taking him, they: (19:20-24)

- a. Preached.
- b. Prophesied.
- c. Sang.

**Answer the following question in your own words:**

Saul tried to kill David for two reasons: he was jealous and he was scared. He knew the people loved David and God was with David and not him. What could Saul have done to prevent God from leaving him? Also, list a few positive ways we can deal with jealous feelings.

## LESSON 3

# DAVID AND JONATHAN

I Sam. 18:1-9; 20

**INTRODUCTION.** When David appeared before Saul after he had killed the giant, Saul's son Jonathan was present. This meeting between David and Jonathan was the beginning of a friendship that lasted as long as they both lived. The two young men made their first covenant, and Jonathan gave David his robe, sword, bow, and belt to seal the agreement (I Sam. 18:1-4).

David behaved himself wisely, and Saul set him over the men of war. Saul's servants and the people accepted David and were pleased. When Saul and David returned from the battle with the Philistines, the women came out of the cities singing and dancing to meet the king. They sang to one another, "Saul hath slain his thousands, and David his ten thousands." The saying displeased Saul for the women credited David with ten thousands and himself with only thousands. He feared David would replace him as king, and from that day forward Saul eyed David jealously. The next day when an evil spirit came upon Saul, David played for him as at other times. Saul cast his javelin at David, but David escaped his presence twice. Saul then demoted David to captain over a thousand men, but the Lord was with David and the people of Israel and Judah loved him (I Sam. 18:5-16).

Saul had promised to reward the slayer of Goliath by giving him one of his daughters as his wife. However, when he became jealous of David, he broke his promise and gave his elder daughter Merab to another man. Nevertheless, his honor forced him to offer his younger daughter Michal, but he required David to kill one hundred Philistines as a dowry. He hoped that David would be killed by the Philistines, but instead David killed two hundred Philistines. Saul was forced to keep his promise then and gave Michal to David. Saul knew then that the Lord was with David, and he became more afraid of David (I Sam. 18:17-30).

Saul told Jonathan and his servants to kill David. Jonathan warned David and told him to hide in a secret place until morning. He then formed a plan to speak to his father in the morning in the field where David was hiding. He told his father not to sin against David, for David had not sinned against him. Saul listened to his son and swore David should not be killed. Jonathan then called David from his hiding place and told him all his father had said. So Jonathan brought David back to Saul, and he was in his presence as before (I Sam. 19:1-7).

At a later time as David played his harp, an evil spirit came upon Saul, and he again attempted to smite David with his spear. David managed to escape, but Saul sent messengers to watch David's house and kill him in the morning. Michal loved David and helped him to escape by letting him down through the window. David then fled to Samuel who was in Ramah (I Sam. 19:8-18).

#### A. THE FIRST COVENANT

1. When David and Jonathan met for the first time, Jonathan \_\_\_\_\_ him as his own soul. (I Sam. 18:1)
2. Jonathan and David made a covenant, and to seal the agreement what did Jonathan give to David? (I Sam. 18:3-4)
3. David behaved \_\_\_\_\_, and Saul set him over the men of war. (I Sam. 18:5)
4. When they returned from the battle with the Philistines, the women danced and sang: (I Sam. 18:6-7)  
Saul hath slain his \_\_\_\_\_  
and David his \_\_\_\_\_
5. The saying displeased Saul, and he \_\_\_\_\_ David from that day forward. (I Sam. 18:8-9)

**B. THE SECOND COVENANT.** Sometime after Michal helped David escape from Saul, David met with Jonathan and asked him why his father sought to kill him. Jonathan did not believe his father would kill David but promised to learn the truth. Again, for the second time, the two devised a plan to determine Saul's intentions. The next day, the new moon, David was expected to eat with the king, but instead he would hide in the field. If Saul missed David, Jonathan would tell him David had gone to Bethlehem for a yearly sacrifice with his family. If Saul accepted this explanation, then David would be safe. But if Saul would become angry, then they would know that Saul determined evil against David.

The two young men then made a covenant for the second time. Jonathan asked that David not only show kindness to him while he still lived, but also to his descendants forever. David kept this covenant, proving his loyalty, for many years later when he was king and Jonathan was dead, he showed kindness to Jonathan's son (I Sam. 20; II Sam. 9).

1. Jonathan said David would be missed at the new moon feast, and he should come and hide by the stone Ezel after: (I Sam. 20:18-19)
  - a. one day
  - b. two days
  - c. three days
2. Jonathan said he would shoot as though he shot at a mark: (I Sam. 20:20)
  - a. one arrow
  - b. two arrows
  - c. three arrows
3. Jonathan would send a lad to fetch the arrows. If there was no danger, Jonathan would tell the lad: (I Sam. 20:21)
  - a. the arrows are on this side of you
  - b. the arrows are beyond you
4. If David was in danger, Jonathan would say to the lad who was to fetch the arrows: (I Sam. 20:22)
  - a. the arrows are on this side of you
  - b. the arrows are beyond thee
5. David hid himself in: (I Sam. 20:24)
  - a. the field
  - b. a cave
  - c. the mountains



6. The king sat upon his seat by the wall and: (I Sam. 20:25)
  - a. Jonathan arose
  - b. Abner sat by Saul's side
  - c. David's place was empty
7. Saul asked Jonathan about David's absence the: (I Sam. 20:27)
  - a. first day
  - b. second day
  - c. third day
8. Jonathan told Saul that David asked leave to go to: (I Sam. 20:28)
  - a. Shiloh
  - b. Gilgal
  - c. Bethlehem
9. Jonathan said David was with his family for a: (I Sam. 20:29)
  - a. party
  - b. sacrifice
  - c. funeral
10. Saul became angry and told his son: (I Sam. 20:30-31)
  - a. as long as the son of Jesse lives your kingdom will not be established
  - b. to fetch David
  - c. David should die
11. Saul in his anger: (I Sam. 20:33)
  - a. pounded the table with his fist
  - b. tore his clothes
  - c. cast his spear at Jonathan
12. Jonathan was grieved because: (I Sam. 20:34)
  - a. his father treated David shamefully
  - b. God had chosen David as the next king
  - c. Saul had lost his temper

**Year 2**

**Week 74**

### **Saul Tries To Kill David Again**

**Scriptures: 1 Samuel 21 (verses 1-6) and 1 Samuel 23 and 24**

**Key Verse: 1 Samuel 24:11 “Moreover my father, see! Yes, see the corner of your robe in my hand! For in that I cut off the corner of your robe, and did not kill you, know and see that there is neither evil nor rebellion in my hand, and I have not sinned against you, yet you hunt my life to take it.”**

#### **Key Points:**

1. Saul continued to wage a war campaign against David and the men who had joined him in support as Saul pursued them daily. As David was fleeing from Saul, he went to the tabernacle to ask the priest, Ahimelech, for provisions. The showbread (which was replaced weekly) had just been replaced with hot bread. Ahimelech gave David the 12 older loaves since there was no other bread or food there. Ahimelech also gave David the huge sword of Goliath's. Saul later killed all the priests (except one who escaped) because of Ahimelech's kindness to David.
2. David took to the forests and mountainous wildernesses to escape Saul's grasp. Once, while David and his men hid in the recesses of a cave, Saul entered the cave, unaware of their presence. Even though one of David's men encouraged David to kill Saul, David would not "raise his hand against God's anointed." David merely cut off the corner of Saul's royal robe.
3. David's pure heart made him feel sorry for even cutting off the robe corner. He called out to Saul at a distance to tell him even though he had the opportunity, he would not kill him. He promised Saul not to cut-off his descendants (kill them).

Name: \_\_\_\_\_

Date: \_\_\_\_\_

## David and Saul

E G S A A C I C  
E O A T N O D A  
A O U L O R A V  
A D L A I N V E  
R O B E N E I H  
E V I L T R D A  
I A R R E O A R  
R A O I D A O M

**Word List:**

DAVID  
HARM

SAUL  
ANOINTED

CAVE  
GOOD

ROBE  
EVIL

CORNER

# HAVE MERCY ON ME!

Unscramble the bold letters at the top of the box to spell the name of a main character from 1 Samuel 24:1-17. Then write the bold letters in the correct order in the top of the empty box. Take the columns that appear under each bold letter and write them under the same letter in the empty box. When completed, read from left to right to see what he said to show mercy.

<b>V</b>	<b>D</b>	<b>I</b>	<b>D</b>	<b>A</b>
Lord	May	judge	between	the
me.	you	And	may	and
avenge	the	the	wrongs	Lord
done	you	to	me,	have
hand	but	will	not	my
	touch			you.

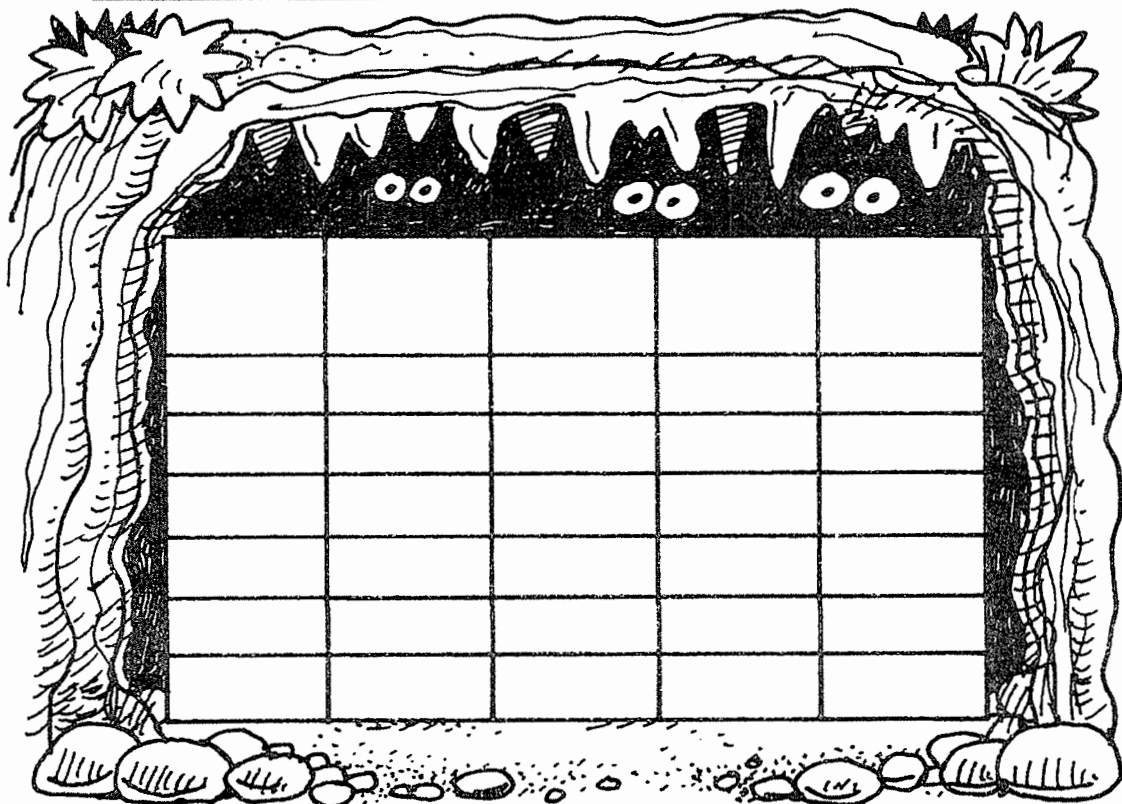

David Spares  
Saul  
1 Samuel 26

# David Is Trustworthy

David hid in the desert because Saul was trying to kill him. But David had done nothing bad to Saul, and he wanted to be friends with Saul again.

At night, Saul slept right in the middle of the army camp. His men were all around him to protect him. One night, David and his friend Abishai walked right past all the sleeping soldiers—right up to King Saul! "This is your chance," said Abishai, "let me kill him."

Cross out all the B's, E's, F's, and G's. Put the leftover letters on the spaces to find out what David said to Abishai.

BDeofng't bkeifl GSeafubl!

\_\_\_\_\_

Later, David talked to King Saul. Cross out all the B's, G's, H's and K's to find out what David said to Saul.



Kl bregshpkehctged  
Byhokugr lbibfe  
thokdhagy.

\_\_\_\_\_

\_\_\_\_\_

\_\_\_\_\_

Saul Tries to Kill David Again  
I Samuel 21, 23, 24

**Memory Verse:**

**“You are more righteous than I, for you have repaid me good, whereas I have repaid you evil.” I Sam 24:17**

**Choose the best answer:**

Ahimelech gave David \_\_\_\_\_ bread. (21: 6)

- a. Holy.
- b. Common.
- c. Uncommon.

David was afraid of Achish, so he pretended to be: (21:12)

- a. Tired.
- b. Insane.
- c. Dead.

Whose sword did David take with him? (21:9)

- a. Saul's.
- b. Jesse's.
- c. Goliath's.

David used his makeshift army to save the town of: (23:5)

- a. Keilah.
- b. Nob.
- c. Bethlehem.

Saul was about to capture David when he turned back to fight the:  
(23:28)

- a. Jebusites.
- b. Amalakites.
- c. Philistines.

When David had opportunity to kill Saul, he: (24:4)

- a. Killed Saul.
- b. Cut off a corner of his robe.
- c. Cut off a piece of his hair.

When Saul saw that David had spared him, he: (24:20)

- a. Attempted to kill him.
- b. Admitted that David would become king.
- c. Begged David to leave the kingdom.

**Answer the following question in your own words:**

Saul was impressed that David had chosen to do good to someone who had been mean towards him. God wants us to do what is right, even to people who are hateful to us. Think about how Saul changed after David did what was right. How do you think our actions affect others? If we are hateful to someone, how might that affect them? What if we are kind to someone who is hateful to us?

## LESSON 4

### DAVID FINDS SAUL IN A CAVE

I Sam. 24

**INTRODUCTION.** After David and Jonathan made their second covenant, David became a fugitive and outlaw, running from Saul for most of the remainder of Saul's life. David first fled to Nob, a town in the territory of Benjamin called, "the city of the priests" (I Sam. 22:19). There the priest Ahimelech gave him some provisions and Goliath's sword, for David was unarmed and without any weapons (I Sam. 21:1-9).

David next went to Achish, the king of the Philistine city of Gath, but he was not welcome there among the Philistines (I Sam. 21:10-15). He escaped then to the cave of Adullam, a large cave in the lowlands of Judah. His father's family joined him there as well as a fighting force of 400 men who were discontented, distressed, and in debt. David removed his family to Moab for safety, then returned to Judah at the advice of the prophet Gad (I Sam. 22:1-5).

Meanwhile an Edomite named Doeg informed Saul that the priest Ahimelech had aided David. Saul called for Ahimelech and all the priests at Nob and commanded his servants to slay them. The servants of the king refused to strike the priests of the Lord, so Saul told Doeg, the Edomite, to kill them. Doeg killed eighty-five priests that day then attacked Nob, killing all in the city. Abiathar, one of the sons of Ahimelech, managed to escape and fled to David (I Sam. 22:6-23).

As David moved from place to place constantly trying to elude Saul and his men, his force of followers increased to 600. David and his 600 men next delivered the city of Keilah, located in the southern lowlands of Judah, from an attack by the Philistines. When Saul heard that David was in Keilah, he sent his army to besiege the city and trap David. However, David was warned by God, and he and his men fled to the wilderness of Ziph. It was at this time while David was in the hill country of Judah in the wilderness of Ziph that Jonathan came to him, and they renewed their covenant for the third time (I Sam. 23:1-18).



After a while the Ziphites betrayed David to Saul, so David and his men moved a little farther south in the wilderness. Saul continued to seek David, but receiving a message that the Philistines were invading his territory, he left his pursuit of David and turned against the Philistines (I Sam. 23:19-29).

David then went to Engedi at the edge of the wilderness on the western shore of the Dead Sea. This was an oasis watered by a hot spring that gushed forth hundreds of feet above the base of a large cliff, and the rocky gorges in the area offered many hideouts. When Saul returned from his encounters with the Philistines, he continued his pursuit of David with 3000 men. Saul went into one of the many caves in the area to rest unaware that David and his men were in the innermost part of the same cave (I Sam. 24).

#### A. DAVID FINDS SAUL

1. When David was in the wilderness of Engedi, Saul took \_\_\_\_\_ and went to seek David. (I Sam. 24:1-2)
2. Saul went into a \_\_\_\_\_ unaware that David and his men were in the innermost part. (I Sam. 24:3)
3. David's men told him the Lord had delivered his \_\_\_\_\_ into his hand. (I Sam. 24:4)
4. David secretly cut off a portion of Saul's \_\_\_\_\_. (I Sam. 24:4)
5. Afterwards David's heart \_\_\_\_\_ him because he had cut off Saul's robe. (I Sam. 24:5)
6. David told his men he could not harm the Lord's \_\_\_\_\_. (I Sam. 24:6)
7. David \_\_\_\_\_ his servants and did not allow them to harm Saul. (I Sam. 24:7)
8. When Saul left the cave, David arose and went out, calling to Saul, saying, \_\_\_\_\_ . (I Sam. 24:8)

9. When Saul looked behind him, David \_\_\_\_\_ with his face to the ground. (I Sam. 24:8)
10. David told Saul that the Lord had delivered Saul into his hand, and though some urged him to kill Saul, he would not put forth his hand against the Lord's \_\_\_\_\_. (I Sam. 24:9-10)
11. He showed to Saul the portion of robe he had cut off, but told him he had not killed him, nor had he \_\_\_\_\_ against him, yet Saul hunted him to take his life. (I Sam. 24:11)
12. David said the Lord would judge between the two of them, but his (David's) \_\_\_\_\_ would not harm Saul. (I Sam. 24:12)
13. What proverb did David speak? (I Sam. 24:13)
14. He asked Saul whom he was pursuing: a dead \_\_\_\_\_ or a \_\_\_\_\_? (I Sam. 24:14)

#### **B. SAUL'S REMORSE**

1. When David finished speaking, Saul \_\_\_\_\_. (I Sam. 24:16)
2. He said David was more \_\_\_\_\_ than he. (I Sam. 24:17)
3. David had rewarded him with \_\_\_\_\_, but he had rewarded David with \_\_\_\_\_. (I Sam. 24:17)
4. Saul said, If a man find his \_\_\_\_\_, will he let him go away? (I Sam. 24:19)
5. Saul said he knew David would one day be \_\_\_\_\_, and the kingdom of Israel would be established in his hand. (I Sam. 24:20)
6. Saul asked David to swear that he would not cut off his \_\_\_\_\_, nor destroy his name from his father's house. (I Sam. 24:21)

# BibleWise

## Discussion Questions – David a Fugitive

Read 1 Samuel 21 - 24:22

- Why did David flee?
- Why didn't David try to kill Saul when he had the chance?
- What is mercy?
- What kind of character did it take to let Saul live?
- Why was David a better person than Saul?
- Why is it important to forgive?
- What was Saul's problem?
- Why couldn't he accept David's goodness?

# BibleWise

## Discussion Questions – Saul's Pursuit of David

Read 1 Samuel 26

- Why is Saul still in pursuit of David?
- What is jealousy? Why is it bad?
- Why wouldn't David kill Saul? (1 Sam 26:9)
- Why does David take Saul's spear and water jug? (1 Sam 26:10-12)
- What was David's message to Saul and his body guard? (1 Sam 26:15-16)
- What is Saul's reaction to David's message?
- Should David return to Saul? Why?
- Would you be as forgiving if someone tried to hurt you?

## David and Saul - 1 Samuel 24

Fill in the missing words:

(v1) Now it happened, when Saul had returned from following the  
\_(a)\_ , that it was told him, saying, "Take note! \_(b)\_ is in the  
Wilderness of En Gedi. (v2) Then \_(c)\_ took \_(d)\_ chosen men from  
all \_(e)\_ , and went to seek David and his men on the Rocks of the  
Wild Goats.

- a) \_\_\_\_\_ b) \_\_\_\_\_  
c) \_\_\_\_\_ d) \_\_\_\_\_  
e) \_\_\_\_\_



### Word Puzzle

D M A L A T J L L X E Z L J A  
A J E K U B I L L G V S D B O  
V N P N G A I G N B A R O B E  
I S V F N K S A V S C E E J Y  
D A E V I S R A E L C G S Z Z  
T J Q N V E F I N K A A L E X  
N I H M I H V Q I R V S R Y H  
T K G L G T E Q U E G T L E O  
Q H D V R X S O D N P D H U D  
T E Z S O M C I X I C B A R D  
Z O E L F Z Z W L X H F C L A  
H I Y F V T V N F I O K U S M  
V I V D E V E C R G H G B L F  
U D D M E P D R D O Y P H Q L  
N A D C K G C N O U O U V Z G

CAVE  
COURAGE  
DAVID  
FORGIVING  
ISRAEL  
KILL  
KNIFE  
MEN  
PHILISTINES  
ROBE  
SAUL  
SAVED  
SCARED

Interesting fact: The caves in the desert of En Gedi were used by the people as a place to stay and it also served as a burial place. The caves were large enough to hold 1000's of people.

**Year 2**

**Week 75**

### **Saul Visits The Witch Of En Dor**

**Scriptures: 1 Samuel 28 and 1 Samuel 31**

**Key Verse: 1 Samuel 28:7** “Then Saul said to his servants, ‘Find me a woman who is a medium, that I may go to her and inquire of her.’ And his servants said to him, ‘In fact, there is a woman who is a medium at En Dor.’”

#### **Key Points:**

1. Samuel, the Lord’s prophet had died. King Saul had put all of the mediums and spiritists (witches, sorcerers, etc.) out of the land of Israel. These people were quite common in idolatrous lands.
2. The Philistines were gathered for battle against Israel. Because Saul had repeatedly rejected God, God was not communicating with Saul via dreams, prophesy, or by the breastplate of judgment (urim). This scenario coupled together for a terrifying situation for Saul.
3. Saul ironically decided to disguise himself and turn to the Devil’s realm for guidance instead of repenting and humbly turning to God. Saul requested that a witch bring Samuel up from the grave. Satan does not have this kind of power. Seeking witchcraft was expressly forbidden by God’s law (see Ex. 22:18 and Lev. 19:31).
4. The witch shrieked when she saw Samuel’s spirit. This had never happened before, but God allowed His Prophet Samuel’s rest to be interrupted to bring Saul a final chilling prophesy. Samuel told Saul that God was Saul’s enemy and that the next day he and his 3 sons would be killed in battle. His words rang true and they were all killed brutally by the Philistines.

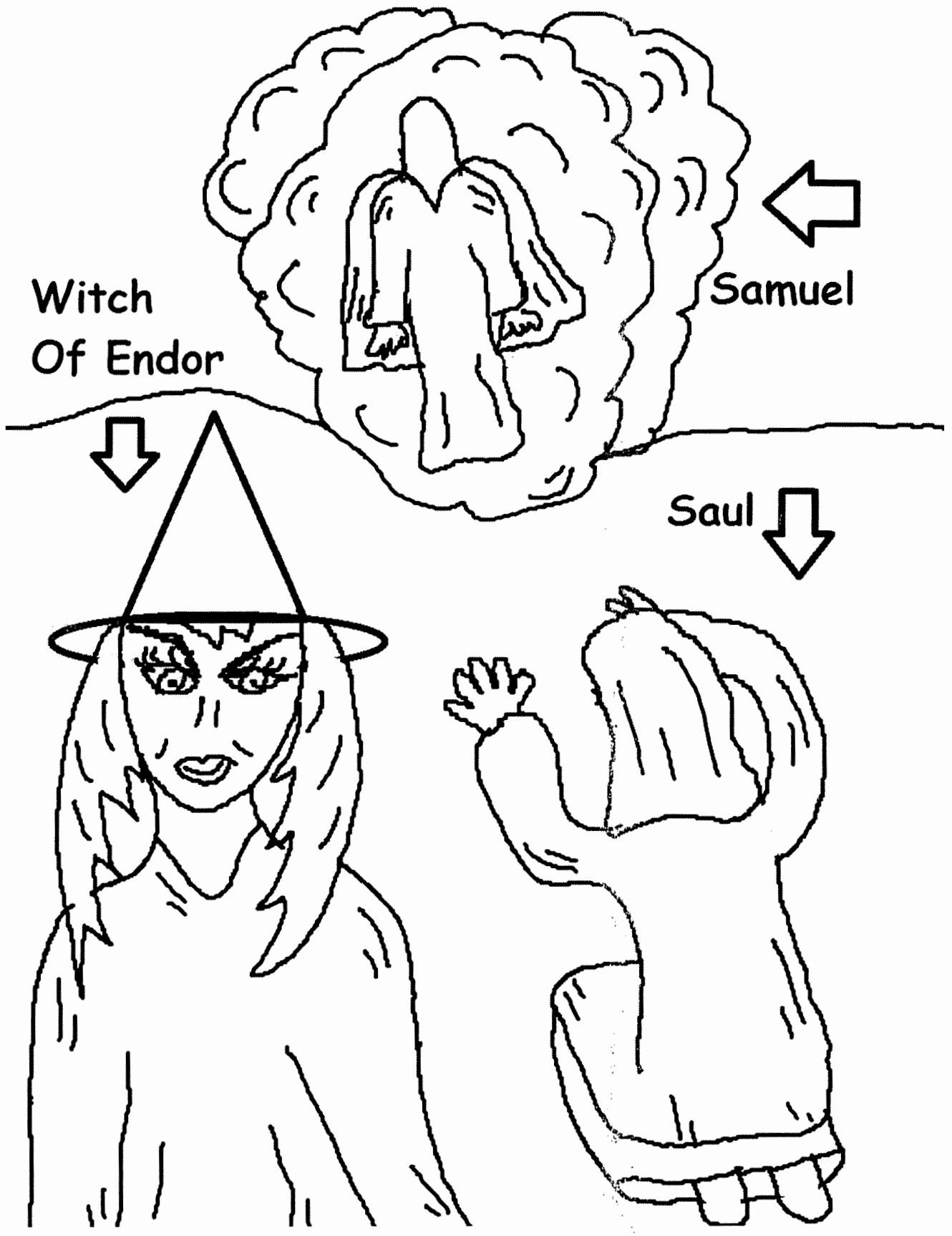

Witch  
Of Endor

Samuel

Saul

1 Sam 28:6 And when Saul inquired of the LORD, the LORD answered him not, neither by dreams, nor by Urim, nor by prophets.7 Then said Saul unto his servants, Seek me a woman that hath a familiar spirit; that I may go to her, and inquire of her. 8 And Saul disguised himself, and put on other raiment, and he went, and two men with him, and they came to the woman by night: and he said, I pray thee, divine unto me by the familiar spirit, and bring me him up, whom I shall name unto thee.11 Then said the woman,

Whom shall I bring up unto thee? And he said, Bring me up Samuel.16 Then said Samuel, Wherefore then dost thou ask of me, seeing the LORD is departed from thee, and is become thine enemy?19 Moreover the LORD will also deliver Israel with thee into the hand of the Philistines: and to morrow shalt thou and thy sons be with me: the LORD also shall deliver the host of Israel into the hand of the Philistines. 20 Then Saul fell straightway all along on the earth, and was sore afraid, because of the words of Samuel: and there was no strength in him; for he had eaten no bread all the day, nor all the night.

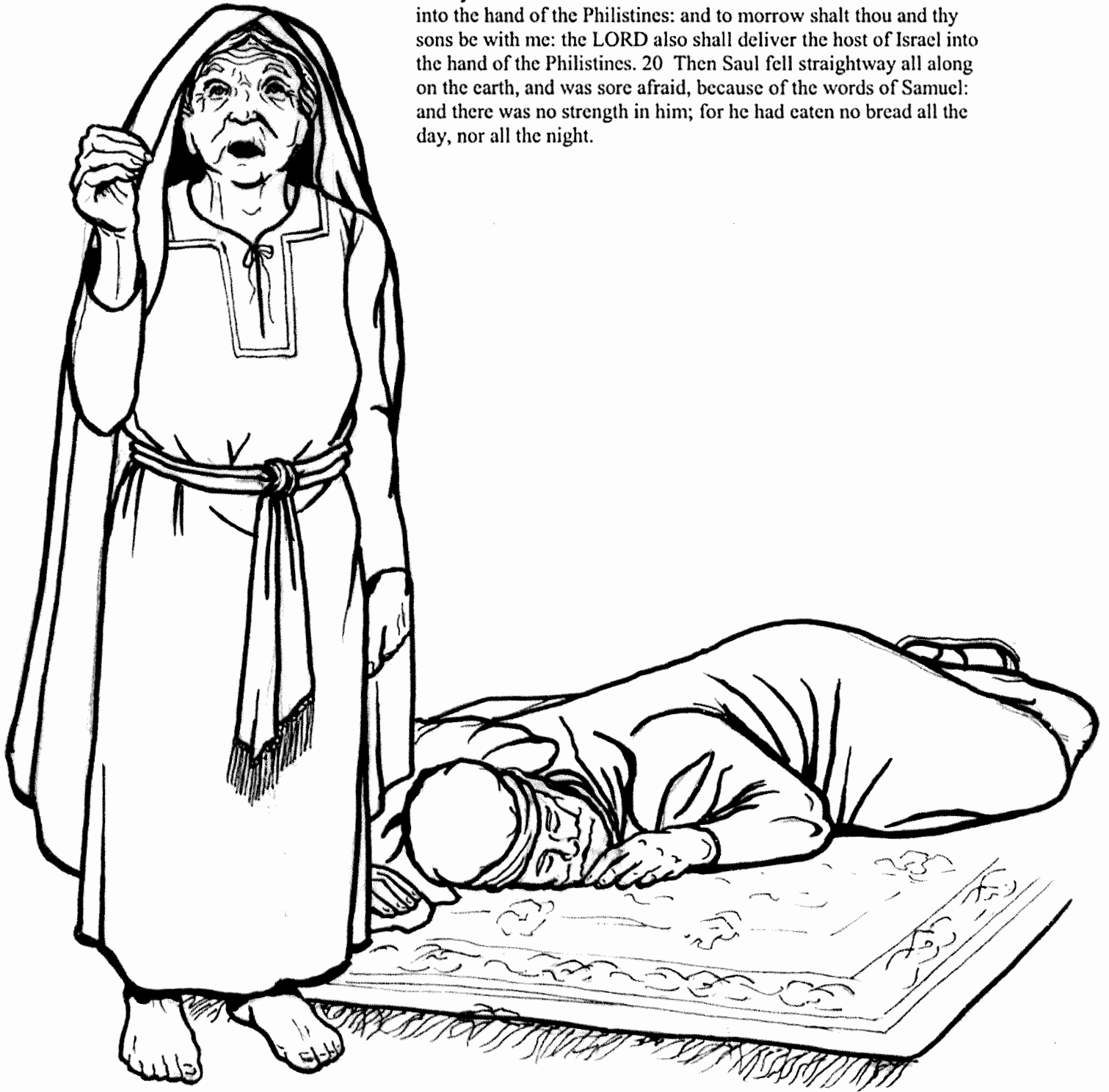

Isa 8:19 And when they shall say unto you, Seek unto them that have familiar spirits, and unto wizards that peep, and that mutter: should not a people seek unto their God? for the living to the dead?





# Bible Pathway Adventures

[www.biblepathwayadventures.com](http://www.biblepathwayadventures.com)

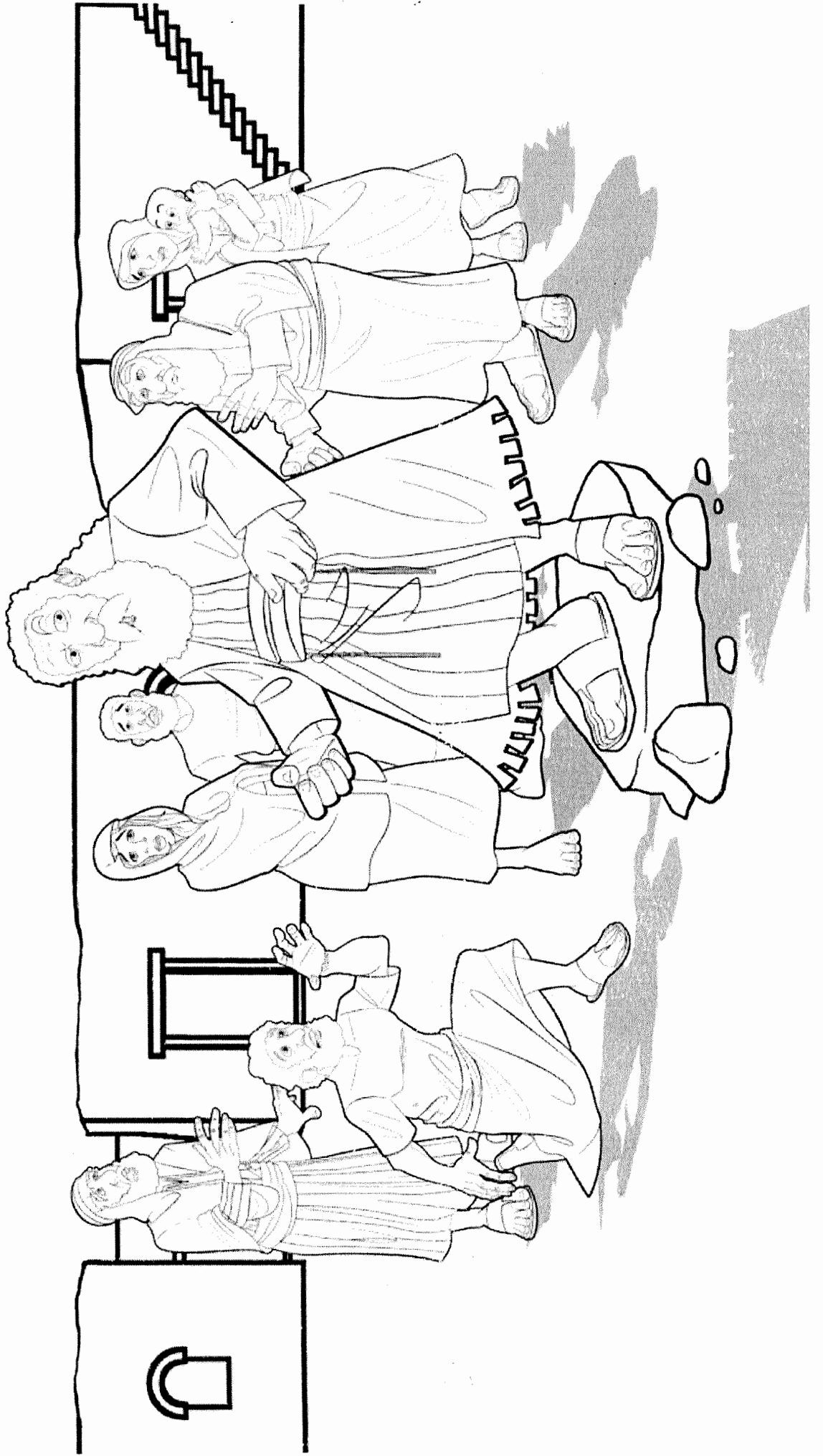

# Saul, a Witch, and a Spirit

(Saul 28:7)

Use the word bank below to fill in the blanks and learn about Saul, the witch of Endor, and a spirit. Some words are used more than once.

\_\_\_\_\_ is afraid of the \_\_\_\_\_.

Saul \_\_\_\_\_ himself to visit a \_\_\_\_\_ for help.

The \_\_\_\_\_ summons the \_\_\_\_\_ of \_\_\_\_\_.

\_\_\_\_\_ tells \_\_\_\_\_ bad news about the future.

\_\_\_\_\_ falls to the ground because he is upset.

The \_\_\_\_\_ cooks for \_\_\_\_\_ so he can make the journey home.

## WORD BANK

SAUL

PHILISTINES

SPIRIT

WITCH

DISGUISES

SAMUEL

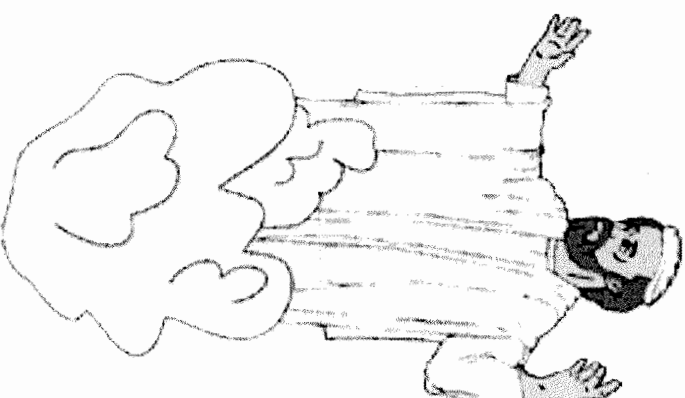

Saul Visits Witch of En-dor  
I Samuel 28, 31

**Memory Verse:**

**“Then Saul fell at once full length on the ground, filled with fear because of the words of Samuel.” I Sam 28:20**

**Choose the best answer:**

Saul was looking for a medium because:

- a. God would not answer him.
- b. Samuel would not answer him.
- c. He could not find David.

The woman did not want to do what Saul asked because she was afraid of:

- a. David.
- b. God
- c. Saul.

The woman was afraid because she saw:

- a. Samuel.
- b. Saul.
- c. God.

Samuel said God had torn the kingdom from Saul's hand because:

- a. Saul had tried to kill David.
- b. Saul had disobeyed by not destroying the Amelikites.
- c. Saul had consulted a medium.

Who did Samuel predict would die in battle the following day?

- a. Saul alone.
- b. Jonathan alone.
- c. Saul and his sons.

Saul was injured by:

- a. The archers.
- b. A swordsman.
- c. His armor bearer.

Saul was killed by:

- a. The Philistines.
- b. His armor bearer.
- c. Himself.

The people of \_\_\_\_\_ took Saul's body back from the Philistines:

- a. Bethlehem.
- b. Jabesh-gilead.
- c. Beth-shan.

Samuel said that all this happened because of Saul's sin in which chapter?

- a. I Samuel 15.
- b. I Samuel 16.
- c. I Samuel 17.



# Bible Pathway Adventures

BIBLE QUIZ

## WITCH OF ENDOR

Match the question with the  
answer on the right.

### QUESTIONS

- \_\_\_ King Saul was king of which people?
- \_\_\_ Which army wanted to fight the Israelites?
- \_\_\_ Why did King Saul want to talk to a witch?
- \_\_\_ In which town did King Saul talk to a witch?
- \_\_\_ Who did King Saul ask the witch to raise from the grave?
- \_\_\_ Why did King Saul want to talk to Samuel?
- \_\_\_ What did Samuel tell King Saul?
- \_\_\_ What happened to King Saul after he visited the witch of Endor?
- \_\_\_ Where in the Bible does Yahweh forbid trying to talk to dead people?
- \_\_\_ How did King Saul lose his life?

### ANSWERS

1. Philistines
2. Endor
3. Deuteronomy 18
4. Saul and his sons w  
their lives
5. Fell on his sword
6. Israelites
7. Went into battle ag  
the Philistines
8. The prophet Samue
9. To understand the f
10. To learn how to de  
Philistines



# Bible Pathway Adventures

WORD SEARCH

## WITCH OF ENDOR

U M X U V P B E N D O R W G Q H M S V S  
D O F T J X M B M S G Z T J W M H O L A  
F O T R I B E S Y I A Q C P P V Z L G M  
B E H Y G R I J A T Z R R B O V C D N U  
F U S O T D X K H H W P R T O Z L I A E  
U B O U R Z O E W S A J A O Q Z K E Z L  
U E P O H S I Q E U E T I H W T E R G L  
K N F H F J E T H E K C K S G F N S L E  
X J H I I W W S Z M D C H T Z N W Q O O  
C A G E K L Q C A I J S V Y V D F M W F  
Q M Q R F G I B W Q T S T S G U L Q D B  
B I R K I N G S W D T S O J Y E N Q N W  
L N I R M T B P T W Z G R U F D J M P I  
T V B J Z S N S Z I R C A X C B T U R T  
S W P P L G P T A N N Z H V O T U U O C  
R I L K I Z R O J A K E Z L V O U O P H  
Z M B F E W M D Z O F B S D A F N X H B  
J U D G E W R O F O F I P T F J M C E V  
Q M E F W V N F Z G A Z S A U L S F T B  
Q R C Z V X M X A U I S R A E L I T E X

JUDGE

TZITZITS

PHILISTINES

ENDOR

PROPHET

SAMUEL

SOLDIERS

TORAH

MIZPAH

ISRAELITE

YAHWEH

TRIBES

ARROW

KING

WITCH

HORSES

SAUL

BENJAMIN

For more free Bible resources and Teacher Packs including coloring pages,  
worksheets, quizzes and more visit our website at:

## LESSON 5

### SAUL AND THE WITCH OF ENDOR

I Sam. 28

**INTRODUCTION.** Sometime during David's fugitive years Samuel died and the people of Israel mourned for him. After David's encounter with Saul in the cave, David married Abigail, a woman of Carmel, and also Ahinoam, a woman of Jezreel. Both of these cities were located in the hill country of Judah where David was hiding. About the same time Saul gave his daughter Michal, who was David's first wife, to another man (I Sam. 25).

Again the Ziphites betrayed David to Saul, and again Saul began his pursuit of David. This time David discovered Saul and his men while they were sleeping in their camp. A deep sleep from the Lord had fallen on them, and David was able to steal into the camp, take Saul's spear, and a jug of water. David then stood on a hill afar off and called to Abner, Saul's captain, chastising him for not guarding the king. Again, Saul, realizing David had spared his life, said he had sinned and would no longer attempt to harm David. David then went on his way and Saul returned to his place, no longer pursuing David (I Sam. 26).

David still did not trust Saul, however, and fled once more to Achish, the Philistine king of Gath. Achish gave David the city of Ziklag as a home, and David, his men, and their families dwelt in the city (I Sam. 27).

Once again the Philistines gathered their army together to fight against Israel. Saul gathered his army, and the two armies camped about five miles apart. When Saul saw the Philistine host, he was frightened. He attempted to communicate with God, but was unsuccessful either by dreams, by the priests, or by the prophets. Saul previously had attempted to rid the land of witchcraft, but because of his fear of the coming battle, he told his servants to find a witch for him to consult. When his servants



advised him there was a medium at Endor, Saul went to seek her advice after disguising himself. He tricked her into calling for Samuel's spirit, and surprisingly Samuel's spirit appeared. Samuel's message, however, was not comforting or encouraging to Saul (I Sam. 28).

**A. SAUL CONSULTS A WITCH (MEDIUM)**

- |                                                                                             |                                                       |
|---------------------------------------------------------------------------------------------|-------------------------------------------------------|
| 1. _____ Samuel died and all Israel (I Sam. 28:3)                                           | a. night                                              |
| 2. _____ Saul had put away (I Sam. 28:3)                                                    | b. dreams, Urim<br>nor prophets                       |
| 3. _____ Israel gathered at Gilboa against the<br>(I Sam. 28:4)                             | c. snare                                              |
| 4. _____ When Saul saw the host of the Philistines,<br>he was (I Sam. 28:5)                 | d. lamented                                           |
| 5. _____ When Saul inquired of the Lord, the Lord<br>answered not, neither by (I Sam. 28:6) | e. loud voice                                         |
| 6. _____ Saul told his servants to find a (I Sam. 28:7)                                     | f. punishment                                         |
| 7. _____ His servants said there was such a woman at<br>(I Sam. 28:7)                       | g. Endor                                              |
| 8. _____ Saul disguised himself and went to see the<br>woman by (I Sam. 28:8)               | h. afraid                                             |
| 9. _____ The woman believed Saul was laying for her a<br>(I Sam. 28:9)                      | i. Philistines                                        |
| 10. _____ Saul swore to her by the Lord that she would<br>receive no (I Sam. 28:10)         | j. familiar spirits, wizards<br>(mediums, spiritists) |
| 11. _____ Saul asked the woman to bring up for him<br>(I Sam. 28:11)                        | k. Samuel                                             |
| 12. _____ When the woman saw Samuel, she cried<br>with a (I Sam. 28:12)                     | l. woman with a familiar<br>spirit (medium)           |
| 13. _____ The woman then recognized (I Sam. 28:12)                                          | m. Saul                                               |

**B. SAMUEL'S MESSAGE TO SAUL**

- |                                                                                                                    |                          |
|--------------------------------------------------------------------------------------------------------------------|--------------------------|
| 1. _____ The woman told Saul she had seen a god (spirit) ascending out of the (I Sam. 28:13)                       | a. eat                   |
| 2. _____ When Saul asked what form the spirit had, she said he was an (I Sam. 28:14)                               | b. Lord                  |
| 3. _____ When Saul perceived it was Samuel, he (I Sam. 28:14)                                                      | c. servants              |
| 4. _____ When Samuel asked Saul why he had disturbed him, Saul said he was (I Sam. 28:15)                          | d. strength              |
| 5. _____ Saul said the Philistines make war and God does not (I Sam. 28:15)                                        | e. David                 |
| 6. _____ Samuel said the Lord had departed from Saul and become his (I Sam. 28:16)                                 | f. old man               |
| 7. _____ Samuel said the Lord had rent the kingdom from Saul and given it to (I Sam. 28:17)                        | g. Amalek                |
| 8. _____ Saul had not obeyed the voice of the (I Sam. 28:18)                                                       | h. fatted calf and bread |
| 9. _____ The Lord had taken the kingdom from Saul because he had not executed the Lord's wrath upon (I Sam. 28:18) | i. answer                |
| 10. _____ Saul and his sons would die the next day, and the Lord would deliver Israel to the (I Sam. 28:19)        | j. bowed                 |
| 11. _____ When Samuel had finished speaking, Saul fell to the earth and had no (I Sam. 28:20)                      | k. earth                 |
| 12. _____ The woman persuaded Saul to (I Sam. 28:21-22)                                                            | l. Philistines           |
| 13. _____ She prepared a (I Sam. 28:24)                                                                            | m. sore distressed       |
| 14. _____ She set food before Saul and his (I Sam. 28:25)                                                          | n. enemy                 |

The story of Saul visiting the medium presents some difficult questions and can be hard to understand. Following is a good discussion on the topic which may be of use when preparing your lessons.

## **Saul & the Witch of Endor**

### **The Question**

Toward the end of King Saul's reign he went to a witch to have her conjure up the Prophet Samuel. I thought that once a person died they were no longer available to those of us still in our bodies and that any so called contact was really demonic. Yet in scripture it seems as though the witch contacted the ACTUAL Prophet Samuel—not just a demon spirit impersonating him. Can you explain this to me?

- Name and location unknown

### **The Answer**

Part 1: Is contacting the dead possible?

Part 2: Handling things that don't fit

## **Is contacting the dead possible? (Part 1)**

Contacting the dead, called necromancy is strictly forbidden activity in the Bible. God does not tell us it is not possible; what he does say is DON'T DO IT. Saul was well aware of the biblical law forbidding it. **"Now a man or a woman who is a medium or a spiritist shall surely be put to death."** (Leviticus 20:27) **"There shall not be found among you anyone...who casts a spell, or a medium, or a spiritist, or one who calls up the dead."** (Deuteronomy 18:11)

King Saul had previously reinforced God's law on this matter and had outlawed mediums and spiritists in the land. Yet when he was in big trouble and couldn't seem to hear from God for himself he broke his own rule. Not surprising. Saul's reign was always marked by compromise and weak character and Samuel had told him early on that God would remove the kingdom from him in favor of David.

I agree that the scripture makes it sound as if this apparition was the real Samuel. The witch's description of the conjured spirit definitely caused Saul to believe it was so. The "ghost" spoke like Samuel and confirmed the things Samuel had already told Saul while he was on earth. So—was it really him? We don't know.

Here are some possibilities. Perhaps it was Samuel. If we accept that we are simply accepting the scripture as stated and cannot be faulted for doing so. If that is true God allowed it yet we may not conclude that God therefore approved it. God allows us to exercise our free will and sin even though he does not approve of sin at all.

Perhaps it was actually a demon disguising itself as Samuel. The witch may have had access to demonic spirits she controlled and who to some degree controlled her. They could have conjured up Samuel's likeness and repeated back all Samuel's words to Saul in his lifetime. Why would they want to confirm God's word to Saul? Demons desire to intersect with our world wherever possible. Perhaps they get something out of doing so that we don't fully understand.

## **Handling things that don't fit (Part 2)**

The story of Saul and the witch or medium of Endor is one of those passages that it is difficult to wrap our minds around. Our theology often sticks things in strict slots that we like so everything stays neat and tidy. What then do we do when there are loose ends and messy details that don't fit our belief system?

Does this passage indicate the dead are accessible to us? If Samuel were God's prophet why would he submit to being called back? Who's in charge, a witch or God? If this happened once, might it happen again, in our modern times? If a person dies and goes immediately to either heaven or hell, how could they be hanging around close enough to be contacted?

All these questions are legitimate but not necessarily answerable because there are times when scripture doesn't give enough information to satisfy our curiosity. We are left with mysteries. But we shouldn't stop

asking questions. We should keep digging into God's Word because often a mystery will surprisingly settle for us over time as we seek God's wisdom.

There is an approach I like to take when I find a hard passage of scripture and I'll share it with you. The first thing I do is look it up and read it in as many other translations as possible. To that I might add a paraphrase such as *The Message*. (A paraphrase is not a strict translation from the original language but a loose rendering which tries to capture the sense of the passage.)

I use every available study note and cross reference that each Bible supplies. Bible scholars who have asked the same questions frequently offer up solutions or possibilities I have never considered. They have taken into consideration customs of the day and archeological finds and word meaning nuances that are extremely helpful.

Beyond the Bible itself there are Bible dictionaries, Topical Bible studies and commentaries with a wealth of information to aid in understanding. Even as I researched this question of yours, I used all of the above. That's how I know it has been much asked and debated over time.

Finally, praying for understanding actually works. In fact, I think it is often the Holy Spirit who inspires our curiosity in the first place. Submit mysteries to him and wait. They WILL be answered, either here or in eternity.

**Year 2**

**Week 76**

### **David Becomes King**

**Scriptures: 2 Samuel 2, and 2 Samuel 5:1-3**

**Key Verse: 2 Samuel 5:3 “Therefore all the elders of Israel came to the king at Hebron, and King David made a covenant with them at Hebron before the Lord. And they anointed David king over Israel.”**

#### **Key Points:**

1. David asked God to which city in Judah he should go and live. God responded for David to go to Hebron where the men of Judah anointed him as king over the house of Judah. He was king in Hebron for 7 ½ years.
2. But there were those who were still loyal to Saul. Abner, Saul’s commander placed Ishbosheth as king over all Israel (except the tribe of Judah) and a physical competition was proposed: 12 young men from the tribe of Benjamin (Saul’s tribe) and 12 young men from the tribe of Judah competed. Each one grasped his opponent by the head and thrust their swords into each one’s sides so that all 24 men died. This led to a very fierce battle that day. Abner and the men of Israel were defeated by the servants of David.
3. Abner called out to Joab to cease fighting brother-against-brother. Joab was head of David’s army. Joab blew the trumpet thus signifying the end of the fighting.
4. At age 30, all of the tribes of Israel finally came to David at Hebron in peace. He made a covenant with them before the Lord. The men of Israel anointed David. This was the third time that David had been anointed. David ruled over the unified kingdom for 33 more years.

KING

DAVID

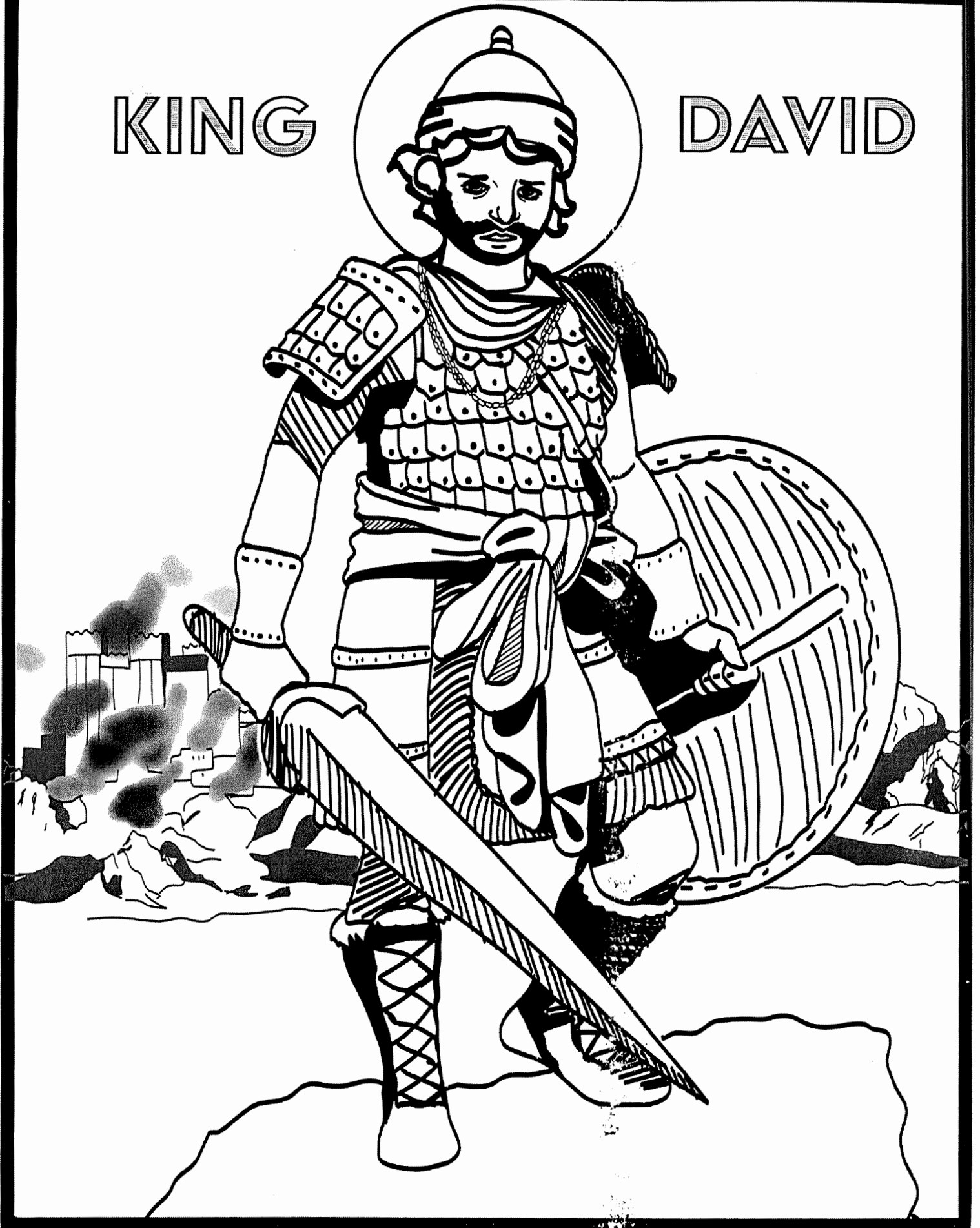

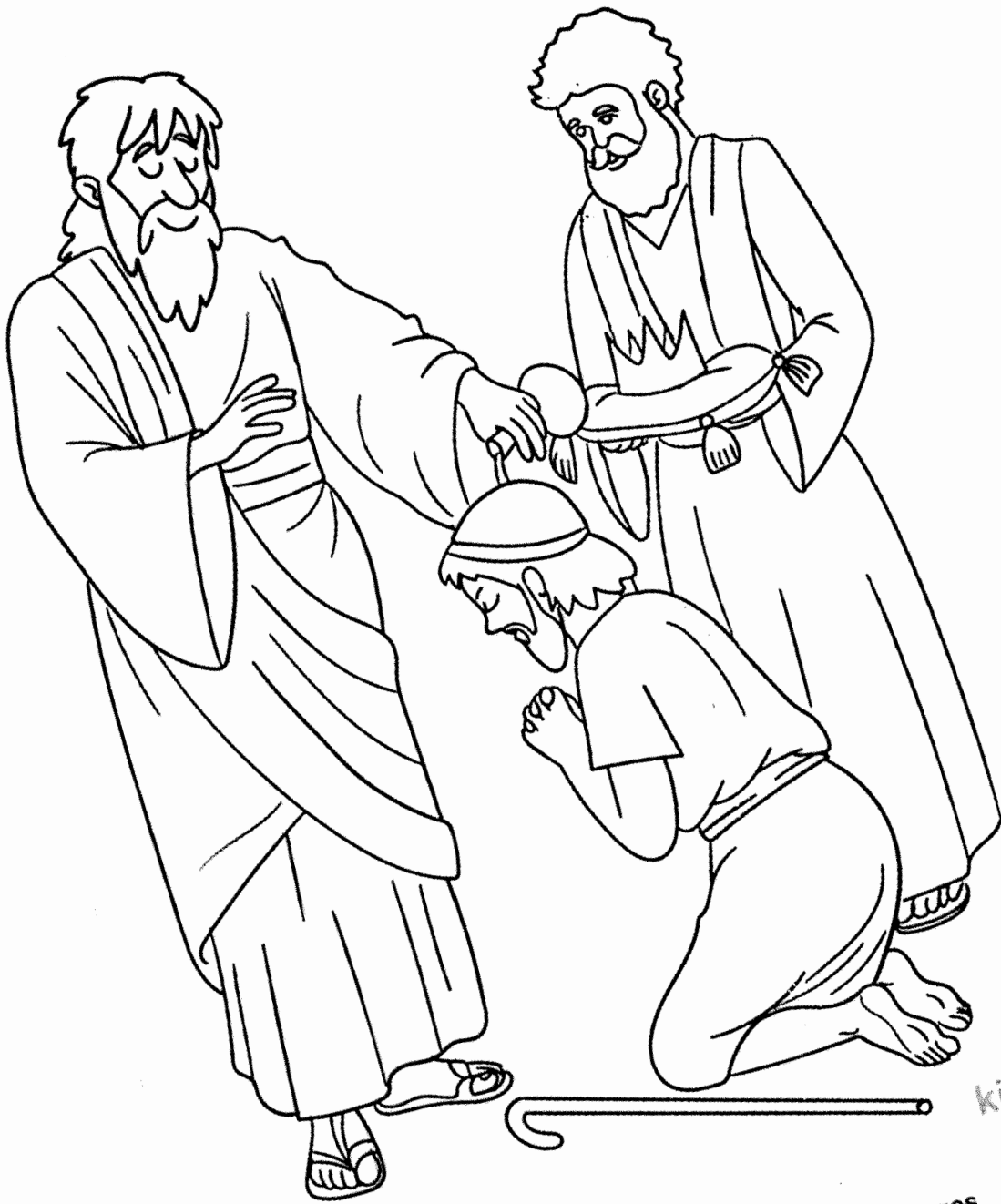

kidadl

Visit [www.kidadl.com](http://www.kidadl.com) for more free coloring pages

**DLTK's Crafts for Kids**

# Paper Crown

This simple project can be worn by the children after it's been created. Great for a multitude of themes and celebrations. Use different colors appropriate for the theme or the child's preferences.

**Materials**

- thin cardboard (poster board or old cereal boxes work well)
- foil gift wrap or construction paper
- Scissors
- Paint, crayons, or felt-tip pens
- glue
- Stapler
- Optional: stickers, markers, glitter, shapes cut from construction paper

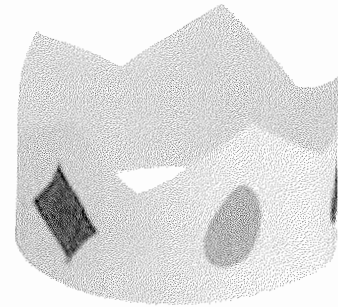
**Instructions**

- Cut a strip of cardboard long enough to go around your head and overlap slightly
  - you may need to staple two pieces together to make it long enough.
  - the strip should be 3 or 4 inches wide and long enough to go around the head



- Cut a piece of construction paper or foil gift wrap the same length but slightly wider (2 inches or so wider)
  - again you might need to staple two pieces together to make it long enough

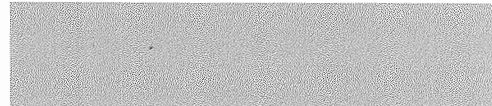

- Glue the construction paper to the cardboard so the bottom edge lines up



- Cut a zigzag in the top edge of the construction paper

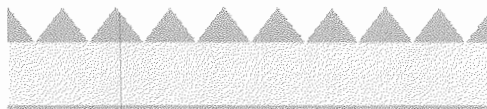

- Note: the reason I make the construction paper wider is that I found it difficult for the



children to cut the zigzag edge from the cardboard. With the wider construction paper, they can just cut the zig zag through the paper

- Decorate the paper side (not the cardboard side) using markers, glitter or stickers

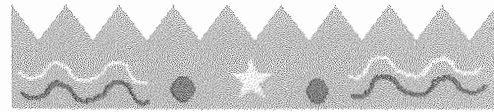

- Make a ring with the cardboard facing in (toward the head) and the paper facing out and staple to make a crown - adult assistance required for this step.

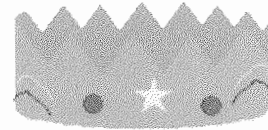

- Ministry-To-Children.com - <http://ministry-to-children.com> -

## Sunday School Lesson: David Becomes King

Posted By [Kelly Henderson](#) On Nov 9th 2010 @ 3:07 pm In [Lesson Plans](#) | [No Comments](#)

### "The Kings of Israel"

Sunday School Lessons for Children

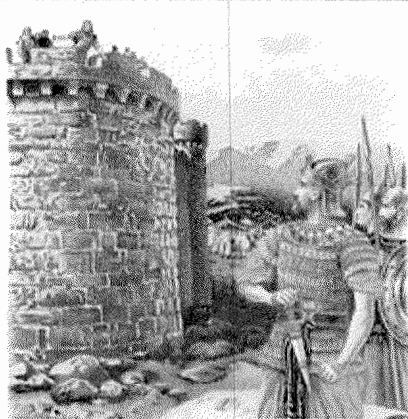

This lesson is a continuation of Israel's Kings. It is the conclusion to the study of David. [Click here](#) to see the lesson index.

The focus of this lesson is how David becomes king in God's timing. The lesson is a reminder that God keeps His promises and as His followers we are to trust Him completely and follow Him faithfully as we wait for His promises to be fulfilled. This lesson can be adapted for individual ministry needs.

**Bible Story:** David Becomes King

**Scripture:** The lesson is based on events taken from [2 Samuel 1-2:1-5](#) and [2 Samuel 5, 7](#)

**Target Age Group:** Age 9 – 11 (U.S. 3rd – 5th Grade)

**Learning Context:** Sunday School

**Target Time Frame:** 60 minutes

**Printer Friendly Bible Lesson:** this lesson plan

**You Can Help:** Please share your feedback and suggestions to improve this children's Bible lesson. [Click here to respond](#)

**Supply List:** Construction paper for footprints, index cards, picture symbolizing heaven, Bibles, Pictures or flannel graphs depicting scenes for the lesson, crown

**Learning Goal:** Students will learn from David's life to trust God to keep His promises and always seek His direction as they make decisions.

**Learning Indicator:** As students participate in the Footprint Activity they will be able to verbalize ways they can seek God's direction in the decisions they have to make. Students will be able to demonstrate their comprehension of the lesson by answering review questions.

**Learning Activity #1:** Create 2 sets of footprints. Make one set out of brown construction paper and the other out of red. The brown footprints will demonstrate how we depart from God's path by following our own wisdom without seeking God's direction. The red footprints will demonstrate following God and His directions in our lives. The footprints will be placed

on the floor of the classroom. On the opposite side of the room place a crown or another object to symbolize the time when believers go to heaven. The red footprints can be taped down heading in the direction of the symbol for heaven. The brown ones will be movable to demonstrate that a person can travel far away from God's path but can return to that path by repenting of sin and turning back to Him. On index cards have decisions that people make (friends, sports, college, marriage, career, etc). As you lead the students through this activity have a student choose a card. As a class discuss what it would take to stay on the red footprints following God's plan. (Walk with God daily by praying and spending time in His Word) What decisions would a person need to make to end up on the brown footprints? (Not seeking God about a decision. An example: Friends-choosing Godly friends that make wise decisions would keep us on God's path. Choosing friends who use bad language, disobey authority etc. would take us off God's path and put us on the brown path. When we are following God on His path we are to share the love of Jesus with the people who use bad language and disobey authority but we don't choose them to be our friends who we spend all our time with.) If believers step off God's path and go down their own path it's not impossible to get back on the right path. Repenting of sin and turning back to God can get you back on His path for your life. The only way we can stay on God's path is to seek His direction for the decisions we make and make sure that what we do is in agreement with what God's word teaches us is true. (The Gospel can be included in this activity by adding a destination that is not heaven. The sign can be titled "Separated from God forever." ([2 Thessalonians 1:8-9](#)) If a person never believes in the Lord Jesus they will always be following the brown footprints that lead to a life separated from God forever.) (A simpler option is to use a hopscotch board made out of tape or squares on the floor. The vertical ones would represent God's plan and the horizontal ones represent going our own ways.)

**Test:** Review Questions

**Memory Verse:** Proverbs 3:5-6 "Trust in the LORD with all your heart and lean not on your own understanding; in all your ways acknowledge Him, and He will make your paths straight." (The Footprint Activity would be helpful to teach the meaning of this verse.)

#### **Bible Lesson:**

Throughout the Bible God has made many promises. Whenever God makes promises He always keeps His promises. Often it takes many years for His promises to be fulfilled. Can you think of any promises God made in the Bible?

- When Adam and Eve sinned God promised to send a Savior. ([Genesis 3:15](#)). How long did it take for this promise to be fulfilled? (thousands of years)
- God promised Noah that He was going to send a flood that would destroy mankind from the earth. ([Genesis 6:13](#)) How long did it take for this promise to be fulfilled? (Somewhere around 100 years [Genesis 5:32](#), [Genesis 7:6](#))
- God promised Abraham he would have a son and would become the father of many nations. ([Genesis 12:2](#), [13:16](#), [16:10](#), [17:4](#)) How long did it take for Abraham to receive God's promise? 25 years ([Genesis 12:4](#), [21:5](#))

These are just a few examples of God's promises and how long it took for them to be fulfilled. When God says He is going to do something He is going to do it.

As we have been studying the life of David what did he know God had anointed him for? (To be the king over Israel) After David was anointed king did he immediately become the new king? (No) What did David do while he waited God's timing to be king? (He was faithful in whatever task he had been given) Was David's life easy while he waited to be king? (No) What made David's life difficult while he waited for God's promise to be fulfilled? (Saul was jealous and tried to have him killed)

Let's turn in our Bible to [2 Samuel 1](#). If you had an enemy that had been trying to kill you for

years how would you respond when you found out that he was dead? David had every reason to celebrate and rejoice when he learns of Saul's death ([2 Samuel 1:1-10](#)). Saul had made his life extremely difficult. Let's read how David responds to the news of Saul and Jonathan in [2 Samuel 1:11-12](#). David models grace and respect toward his enemy after he dies. David sings a song in honor of Saul and his close friend Jonathan ([1 Samuel 1:17-27](#)). From this song you would never know that Saul was David's enemy.

Do you and I respond with the character that David did towards his enemy? ([Proverbs 24:17](#), [Obadiah 1:12, 15](#)) God can enable us to love our enemies and not rejoice over them when they face punishment.

David suffered many years of difficulties while waiting for God's timing to become king and now Saul was dead. Human understanding would make David think now was his time to become king. David could have gathered Israel together and declared that he was the new king because God had anointed him when he was a young shepherd boy. David did not do that. Let's read [2 Samuel 2:1](#). David is a good example of someone who puts our memory verse for today into practice. David asked God's direction before he made any decision. God answered David and gave him clear directions.

It wasn't time for David to be king over all of Israel. Israel was made up of 12 tribes or families. For now it David would be king over one tribe, the tribe of Judah. David didn't lean on his own understanding and by allowing God to direct his paths he was right where he was supposed to be.

Let's flip over to [2 Samuel 5](#). In your spare time you can read the events that took place before David became king over all Israel ([2 Samuel 2:8-4:12](#)). God was working out things in His timing and finally it was time for God's promise for David to be king over Israel to take place. Let's read [2 Samuel 5:1-3](#). (Choose a volunteer to be David and have another student place the crown on his head. The class cheers and thanks God for their king.)

([2 Samuel 5:6-12](#)) After David became king over all Israel he built his palace in Jerusalem and lived there. Because God was with David in all his plans others could see that David was becoming more and more powerful.

As believers the more we obey God's directions in our life the more His Holy Spirit has power in our life. People will see that we live powerful lives for God because we aren't controlled by our sinful natures.

After David became king he still faced difficulties. As Israel's King he led his armies to fight against their enemies. Before he fought a battle he would ask God for his instructions. [2 Samuel 5:18-19, 22-25](#). God told David what to do and he obeyed God's directions. The result was that David won the battles over his enemies.

([2 Samuel 7](#)) God gave David a time of peace as he ruled as king over Israel. David was relaxing in his palace one evening and he began to think about how he lived in a big beautiful palace and the place where God was worshiped was a tent (Tabernacle). That bothered David and he wanted to build a beautiful place for God's people to go and worship Him. David spoke about his desire to a prophet named Nathan.

Later that night God spoke to Nathan about David's desire to build a beautiful place for God. God told Nathan that David would not be the one who would build a house for His name but his son would ([2 Samuel 7:12-13](#)). When God spoke to Nathan about David He made some special promises for David. One of the promises would not take place in David's lifetime but would happen in the future. Let's read about this future promise God made in [2 Samuel 7:16](#). God was promising David that a King would be born from his family who would reign forever.

When David heard what God told Nathan he responded by worshiping Him. [2 Samuel 7:18-29](#) records David's response to God. David was honored that the God of the universe would promise that someone from his family would reign as king forever. David knew that God would keep His promises and one day that King reign. ([2 Samuel 7:28-29](#))

David didn't live to see the day that God's promise would be fulfilled. Even though David never lived to see that promise fulfilled he fully trusted that God would keep his promise. Thousands of years after David's death a King was born. Does anyone know who that King is? (Jesus) The first part of God's promise has taken place for David and even now we as His followers are waiting for that day when Jesus will come back to earth and reign as King of kings forever and ever.

David teaches us to trust God's promises and faithfully obey Him every day. Although David did not live a life free of mistakes God calls him 'a man after His own heart' ([1 Samuel 13:14, Acts 13:22](#)) David repented of his sins before God and God forgave him.

We can live as men, women, boys and girls after God's own heart as well. That doesn't mean we will be perfect. It means that as we live our lives following God's plan for us when we sin against Him we quickly repent. When we repent God forgives us ([1 John 1:9](#)) and we continue following after God and desire to know His heart.

If you have never believed in the Lord Jesus as the Savior for your sins you can repent (turn away from your sins) and believe in Him today. Jesus died on the cross to take the punishment for sin we deserved. He was buried and three days later He rose again. You can be saved today and start following God's perfect plan for your life.

Close in prayer.

#### **Review Questions:**

1. Who always keeps His promises? (God)
2. What promise was David waiting for God to fulfill? (To become king over Israel)
3. True or False David rejoiced and threw a party when he heard Saul was dead. (False)
4. What did David do before making any decision? (Asked God for instructions)
5. Where did David rule as king first? (Over the tribe of Judah)
6. Where did David build his palace? (Jerusalem)
7. What did David want to do for God? (Build Him a beautiful house)
8. What promises did God give to David? (His son would build His House, and someone from his family would reign forever as king)
9. What promise are you waiting for God to fulfill? How will you live your life as you wait?

**Need More Help?** Browse our [Sunday School game ideas](#) or find a [Bible coloring page](#).

---

Article printed from Ministry-To-Children.com: <http://ministry-to-children.com>

URL to article: <http://ministry-to-children.com/david-becomes-king-lesson/>

Copyright © 2007-2012 Ministry-to-Children.com ~ You may use for any offline ministry purpose.





# The King David

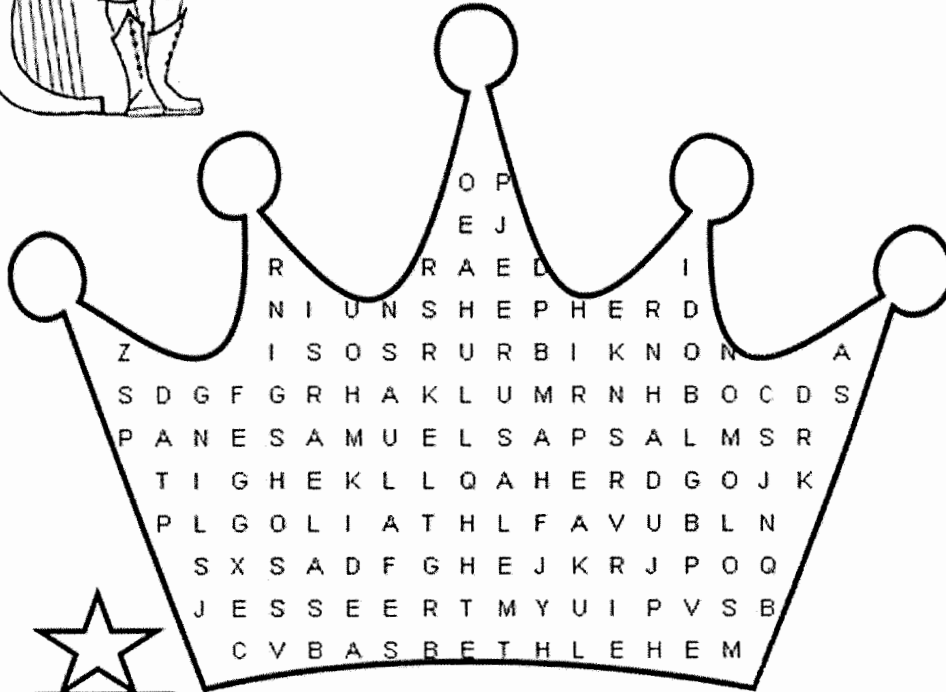
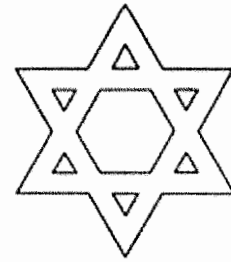

- ★
- Israel
- Saul
- Samuel
- Jesse
- Goliath
- Sling
- Ark
- Jerusalem
- Psalms
- Shepherd
- Solomon
- Judah
- Bethlehem
- Harp

★  
Find the hidden words

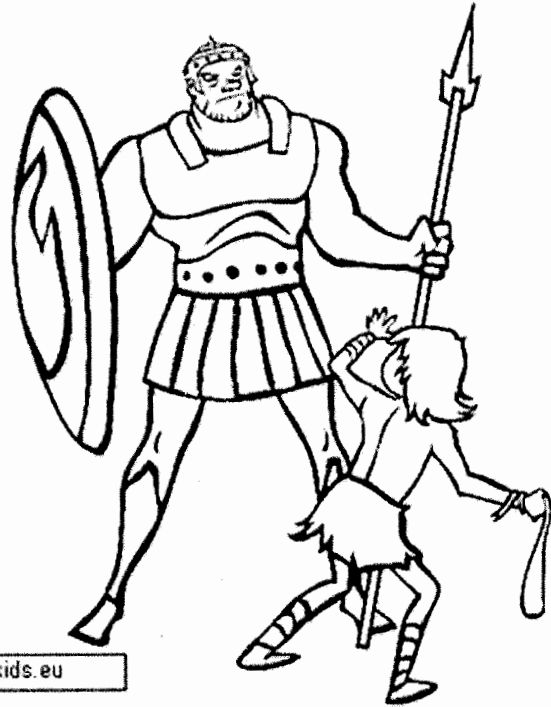

David Becomes King  
II Samuel 2:1-5:3

**Memory Verse:**

**“And the LORD said to you, ‘You shall be shepherd of my people Israel, and you shall be prince over Israel.’” II Sam 5:2**

**Choose the best answer:**

David was made King of Judah, but the King of Israel was: (2:8)

- a. Asahel.
- b. Ish-bosheth.
- c. Abner.

In the battle of Gibeon, Abner lost 360 men while David lost only: (2:30)

- a. 20.
- b. 30.
- c. 40.

Abner came to David in order to:

- a. Spy on him.
- b. Offer his help in becoming king.
- c. Plan a battle.

Who murdered Abner?

- a. Asahel.
- b. David.
- c. Joab.

Rechab and Baanah killed Ish-bosheth, thinking David would be:

- a. Angry.
- b. Pleased.
- c. Sad.

How did David react to the news instead?

- a. He made them princes.
- b. He threw a feast.
- c. He had them killed.



David was anointed king of Israel at:

- a. Bethlehem.
- b. Hebron.
- c. Kiriath-Arba.

David was \_\_\_\_\_ years old when he began to reign.

- a. 20.
- b. 30.
- c. 40.

**Answer the following question in your own words.**

Twice in this story, the enemy of David is murdered. However, each time David reacts by bringing justice on the one who killed his enemy. Think about someone you consider to be your enemy. Based on David's example, what should you want for your enemies? Should you show them justice or mercy? How should we act toward our enemies?

## LESSON 6

# THE DEATH OF SAUL - DAVID BECOMES KING

I Sam. 31; II Sam. 5:1-5

**INTRODUCTION.** As the Philistines prepared for war against Israel, the Philistine king Achish planned to take David and his men with him into battle. However, the other Philistines did not trust David to fight with them and forced Achish to send David back to Ziklag (I Sam. 29).

When David returned to Ziklag, he discovered the city had been attacked and burned by some Amalekites and all the people of the city taken captive including David's two wives. David and his men pursued the Amalekites, and when they discovered the enemy camp, the Amalekites were feasting and celebrating their victory. David and his men attacked the Amalekite raiders, recovered the captives and all the spoil (plunder) the Amalekites had carried away from Ziklag. When David returned to Ziklag, he sent some of the spoil as a gift to the elders in various cities of Judah (I Sam. 30).

Meanwhile the battle between the Philistines and Israel occurred at Mount Gilboa in the north. Saul was mortally wounded in the battle, his three sons including Jonathan were killed, and the Israelite army fled leaving the bodies of their king and his sons behind. When the Philistines discovered the bodies, they cut off the heads and hung the bodies on the wall of the city of Beth Shan as trophies of their victory.

Remember the men of Jabesh Gilead? These were the people of the city whom Saul rescued from the Ammonites when he first became king (I Sam. 11). These men of Jabesh Gilead, in an act demonstrating their gratitude for Saul's earlier bravery to them, stole by night to Beth Shan, removed the bodies of Saul and his sons, and took them back to Jabesh for burial.

**A. SAUL'S DEATH**

1. The Philistines fought against Israel who fell slain in \_\_\_\_\_.  
(I Sam. 31:1)
2. The Philistines slew Saul's three sons, \_\_\_\_\_, \_\_\_\_\_,  
and \_\_\_\_\_. (I Sam. 31:2)
3. Saul was wounded severely by the \_\_\_\_\_. (I Sam. 31:3)
4. Saul asked his armorbearer to draw his \_\_\_\_\_ and thrust  
him through. (I Sam. 31:4)
5. His armorbearer was afraid, so Saul took his own sword and \_\_\_\_\_  
on it. (I Sam. 31:4)
6. Saul's armorbearer fell on his sword and \_\_\_\_\_ with Saul.  
(I Sam. 31:5)
7. The next day the Philistines cut off Saul's \_\_\_\_\_ and stripped him  
of his \_\_\_\_\_. (I Sam. 31:8-9)
8. They put his armor in the house of their idols, and fastened his \_\_\_\_\_  
to the wall of Beth Shan. (I Sam. 31:10)
9. The valiant men of Jabesh Gilead went by \_\_\_\_\_ and  
removed the bodies of Saul and his sons from the wall. (I Sam. 31:11-12)
10. They brought the bodies to Jabesh, burnt them and \_\_\_\_\_  
the bones. (I Sam. 31:12-13)

**B. DAVID BECOMES KING.** After the death of Saul, the Lord instructed David to go to Hebron. There the tribe of Judah anointed David as their king, and he reigned over Judah for seven years in Hebron (II Sam. 1-2). During this time there was civil war between those loyal to David and the remaining descendants of Saul who attempted to claim for themselves the throne of Israel. When the house of Saul was finally vanquished, the elders of all Israel came to David and anointed him king over all Israel. The tribes of Israel for the first time were truly united, and David reigned for another thirty-three years over a united Israel and Judah (II Sam. 3-5:5).

Death of Saul – David Becomes King, 6 - 3

1. After Saul's death, the Lord directed David to go to Hebron. What occurred there? (II Sam. 2:1, 4)
2. After seven years when the elders of all the tribes came to Hebron to anoint David their king, what did they say the Lord had told David? (II Sam. 5:1-2)
3. What did the elders of Israel do then? (II Sam. 5:3)
4. David was \_\_\_\_\_ years old when he began to reign, and he reigned \_\_\_\_\_ years. In Hebron he reigned over Judah for \_\_\_\_\_, and in Jerusalem he reigned \_\_\_\_\_ over all Israel and Judah. (II Sam. 5:4-5)

*...and the Lord said to thee,  
Thou shalt feed my people Israel,  
and thou shalt be a captain over Israel.  
II Sam 5:2*

**Year 2**

**Week 77**

### **David Brings the Ark to Jerusalem**

**Scriptures: 2 Samuel 6 and 1 Chronicles 13-16**

**Key Verse: 2 Samuel 6:15 “So David and all the house of Israel brought up the ark of the Lord with shouting and with the sound of the trumpet”**

**Key Points:**

1. After the ark was returned from the enemy Philistines, King David decided to move it from the home of Abinidab (which was on a hill), to Jerusalem where he had erected a tent for it.
2. Instead of the ark being carried by the priests on poles as God commanded (see Numbers 4: 4-15), they placed the ark on a new cart pulled by oxen. Uzzah was instantly killed by God because he touched the ark to steady it when the ox stumbled. David was first angry, and then the fear of The Lord came over him.
3. After 3 months, the ark was properly carried by the priest with poles to Jerusalem. David and the Israelites rejoiced greatly with dancing, singing, and musical instruments offering sacrifices also. They were careful in their dedication to treat the ark as Most Holy this time.
4. Michal, David’s wife disapproved of the zealous, joyous, exuberant display which David presented as the ark returned from the Philistines to its proper place. He humbled himself by removing his regal robes down to his common linen garments to celebrate just like the rest of the people. Because of her disapproval and judgmental attitude, she was barren the rest of her life (never having any children).



David, now king of Judah, brought the Ark of God to . . .

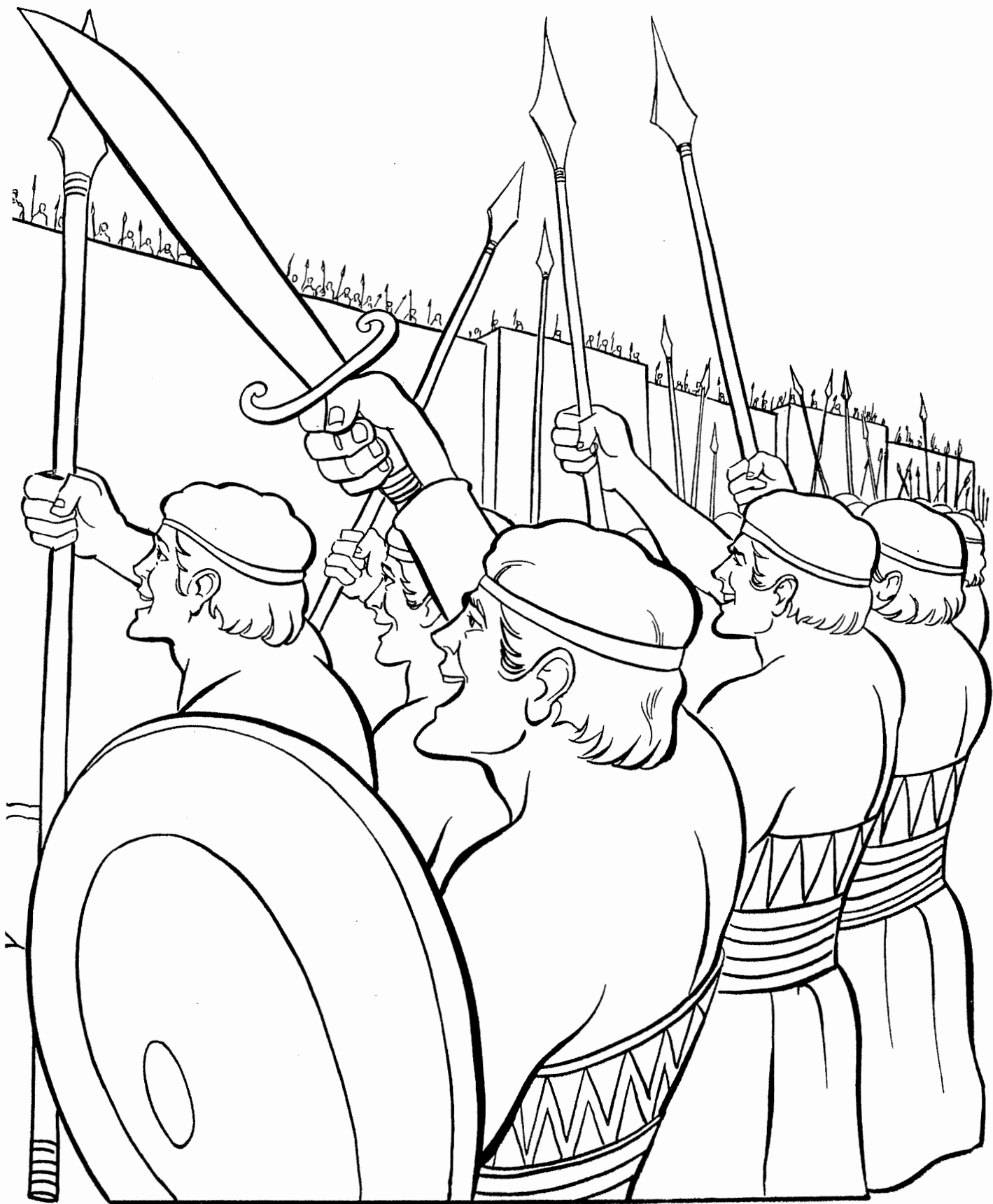

. . . Jerusalem, and there was great joy in the city.

## **MEMORY VERSE**

2 SAMUEL 6:2

“And David arose and went with all the people who were with him from Baale Judah to bring up from there the ark of God, whose name is called the Name, the LORD of Hosts, who dwells between the cherubim.”

## **WHAT YOU WILL NEED:**

Small slips of paper (2”x 4”).

Enough straws for each child in your class, four bowls and masking tape.

Crayons or markers and drawing paper.

## **ATTENTION GRABBER!**

### **Memory Hop**

Prior to class write out today’s theme on small sheets of paper (one word per sheet). Do two sets. For the younger classes try shortening the theme to “Serve God the right way.” Have everyone gather together and explain to them what the theme will be for today’s lesson. Ask them to repeat the theme a couple of times.

Choose two players and have them come to the front of the class. Next tell the two children to turn around and close their eyes (No Peeking!). While they have their eyes closed distribute both sets of the words of the theme in various areas of the classroom. Then have them open their eyes and have them find the words of the theme in order. See which child can put together the theme first. This will test their memory and how well they were listening for the theme. Allow some of the other children also play. God wants us to serve Him in the right way.



# The Ark is Returned to Jerusalem

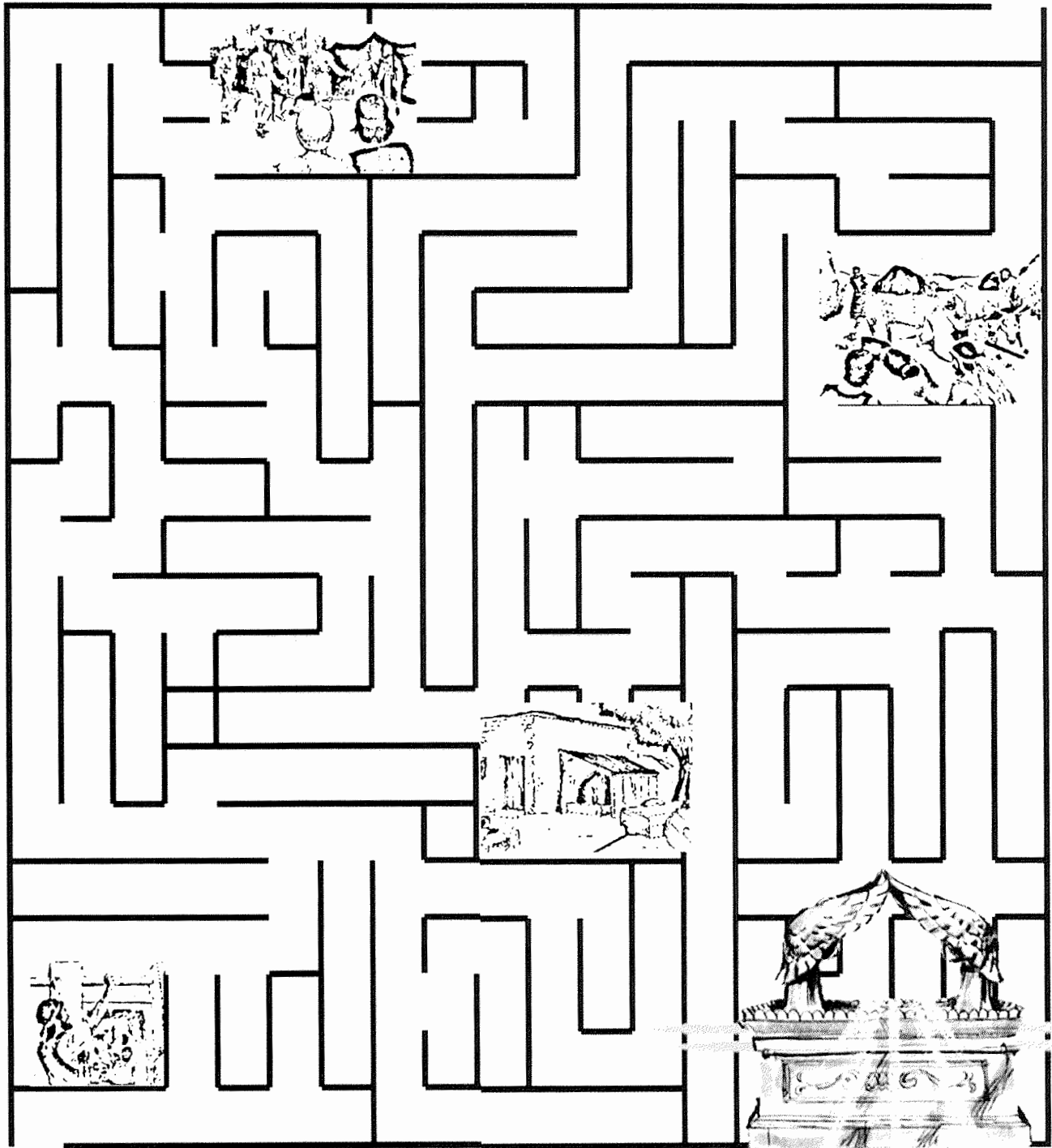
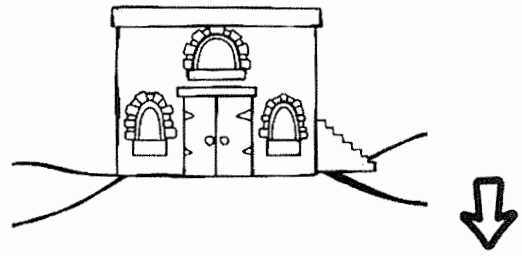

David Brings Ark to Jerusalem  
II Samuel 6; I Chronicles 13-16

**Memory Verse:**

**“Because you did not carry it the first time, the LORD our God broke out against us, because we did not seek him according to the rule.” I Chron 15:13**

**Choose the best answer:**

How did David choose to move the ark of God?

- a. On the shoulders of Levites.
- b. On a cart drawn by oxen.
- c. Carried by his servants.

What happened when Uzzah reached out to steady the ark?

- a. God blessed him.
- b. He was filled with the spirit.
- c. God struck him dead.

David was afraid of the Lord, so he:

- a. Left the ark with Obed-edom.
- b. Destroyed the ark.
- c. Brought the ark to Jerusalem.

Once David saw that the house of Obed-edom was blessed, he:

- a. Had the ark carried to Jerusalem by Levites.
- b. Put the ark back on the cart to return to Jerusalem.
- c. Asked Obed-edom to continue to house the ark.

David recognized that Uzzah’s death was a result of:

- a. David’s disobedience in how the ark was carried.
- b. David’s disobedience in bringing the ark to Jerusalem.
- c. Saul’s disobedience in the matter of the Amelikites.

David had the ark placed in a:

- a. Temple.
- b. House.
- c. Tent.

**Answer the following question in your own words.**

David may have been trying to do what was right, but because he did not follow the commandments of God, Uzzah lost his life. Think of a time when you may be tempted to only do part of what God has commanded, or to do something God has commanded but to do it in a way other than what God desires. How can we use the tools God has given us to avoid making the same mistake as David?

**Year 2**

**Week 78**

### **David Plans a House For God**

**Scriptures: 2 Samuel 7 and 1 Chronicles 17 and 22**

**Key Verse: 1 Chronicles 22:19** “Now set your heart and your soul to seek the Lord your God. Therefore arise and build the sanctuary of the Lord God, to bring the ark of the covenant of the Lord and the holy articles of God into the house that is to be built for the name of the Lord.”

#### **Key Points:**

1. King David was living at peace in Jerusalem in a fine, cedar house. He realized that the ark of God was kept in a tent. He told God’s Prophet, Nathan, that he wanted to build a fine house for God.
2. God’s words and vision through Nathan were thus:
  - a. I took you from the sheepfold.
  - b. I have never asked to have a house built for me. I moved about with Israel.
  - c. You will not build Me a house-I will build an eternal house for you, i.e. from your descendants will come the everlasting King of Kings. This spiritual “house” would show God’s selection of David’s family as royal. His generations would bring forth the Messiah, Jesus.
  - d. Your son, Solomon, will build an earthly house for the ark because you have shed much blood.
3. Instead of being disappointed, David praised God and stored up all manner of building materials for Solomon, his peaceful son. He gathered gold, silver, bronze, cedar wood, artisans, and workers for the magnificent temple. He encouraged all Israel to arise and work.

# 2 Samuel

7:18-29





Paint the world  
**SUPER**  
COLORING

**Then Nathan said to the king, “Go, do all that *is* in your heart, for the Lord *is* with you.”**

**2nd Samuel 7:3**



**STORY POINT: GOD PROMISED THAT EVERY KING OF ISRAEL  
WOULD COME FROM DAVID'S FAMILY.**





I want to build a house for the ark of God.

GOD'S PROMISE TO DAVID

GOD'S ANSWER

DAVID'S HOUSE

Make a Story Picture of David and Nathan



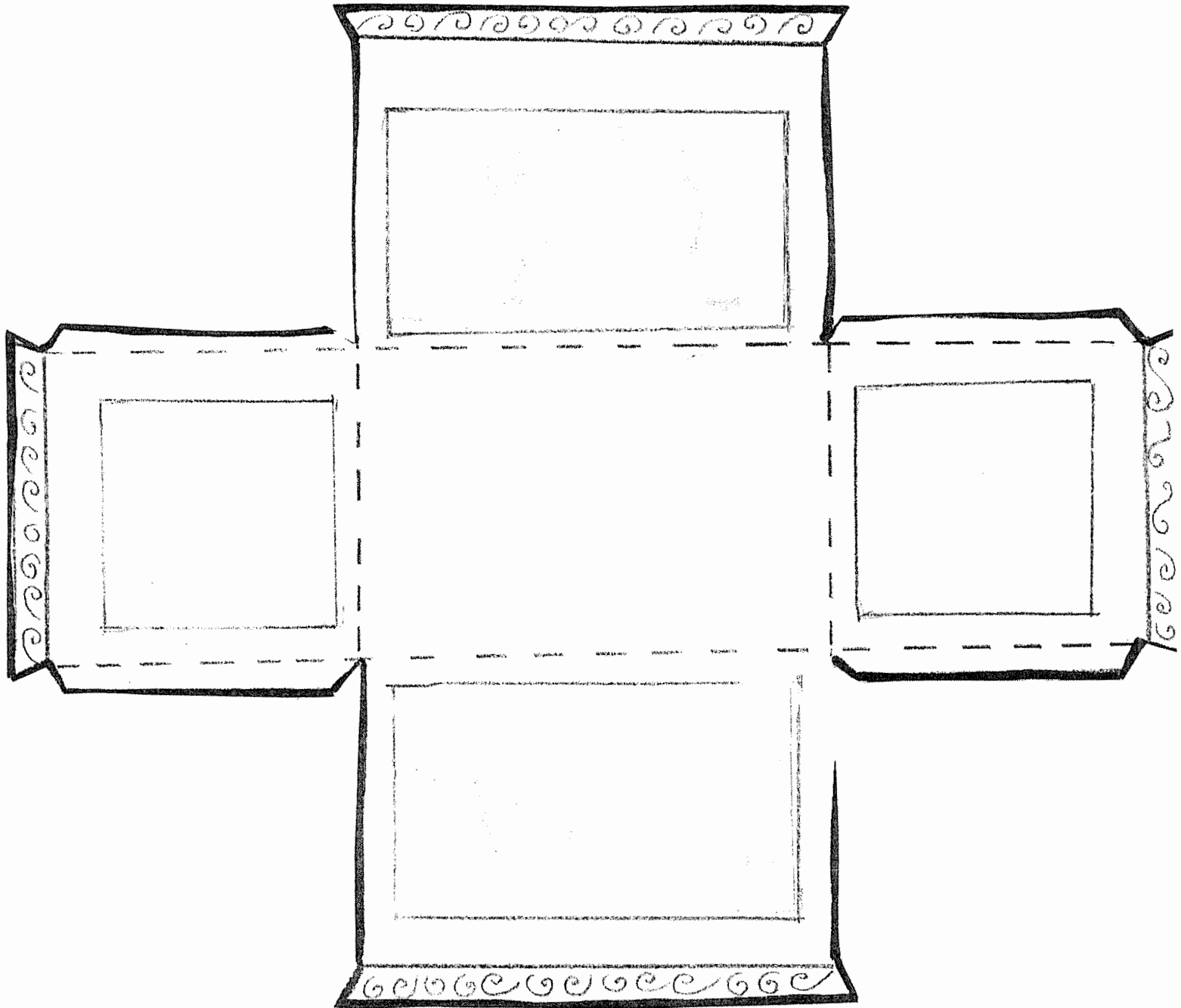

## **Making the Ark of the Covenant**

- Children can make their own Ark of the Covenant with a shoe box. With a hole punch, make holes on both sides of both ends of the shoe box. Punch the holes about 1 inch below the top edge. Make sure that the holes are below the edge of the lid. Insert two dowels through the holes, so that each dowel goes all the way through the box and extends out the other side. Paint the shoe box and its lid gold, inside and out. Direct children to glue a gold bead to each corner of the bottom of the box for legs, and then to glue gold braid to the sides of the lid for decoration. Cut out two kneeling angels and have children glue them to the lid of the box. While the children are constructing their Arks, talk about how people who love God can be a living Ark and carry blessings to the world around us.

David Plans a House for God  
II Samuel 7; I Chronicles 17

**Memory Verse:**

**“When your days are fulfilled and you lie down with your fathers, I will raise up your offspring after you, who shall come from your body, and I will establish his kingdom. He shall build a house for my name, and I will establish the throne of his kingdom forever.” II Samuel 7:12-13**

**Choose the best answer:**

When David told Nathan he wanted to build a house for God, Nathan:

- a. Told him to do it.
- b. Was hesitant.
- c. Said he shouldn't do it.

God told Nathan that David:

- a. Could build him a house.
- b. Would not be the one to build him a house.
- c. Should not consider building a house.

God states that since the Israelites came out of Egypt, He has:

- a. Stayed in Jerusalem.
- b. Waited in Egypt.
- c. Moved around with them.

God said that one of David's descendents would:

- a. Have a kingdom that lasted forever.
- b. Build a temple of stone that would never be destroyed.
- c. Reign over the Philistines.

David prayed that through his family, God's:

- a. Temple would be built.
- b. Name would be magnified.
- c. Church would be established.

**Answer the following question in your own words.**

Carefully read the memory verse for this week. Which of David's descendents do you think this verse is talking about? Is the kingdom God is talking about a kingdom on earth or a spiritual kingdom?

Name: \_\_\_\_\_

Date: \_\_\_\_\_

# 1 and 2 Samuel

H Q N N E J R T Z S O L O M O N A  
F Q S Q S V L S A U L Q A E I K R  
T H N I J G L G L F T S Y E Z O K  
P A L E L G Y K E L I T C X H W O  
B R O X X M J O N A T H A N R O F  
A P D E T K Y J E H V Q J S U P T  
R Z A K F J V O S O V K B J J H H  
B S V Y G E T Y B U L V X S N I E  
C B I K C R U G G Q C L T M H L C  
A V D L A U G O L I A T H U Y I O  
Y S U R L S U J U K U T I O V S V  
Z F U G X A A B S M N J X I G T E  
M Z R O H L B V A A W I X L K I N  
S G A D O E E Y O A U G M X N N A  
J S R N X M L L E Q W O Y P L E N  
E V O Y Q M E G D T F T Y N B S T  
U K I S A M U E L P Q R V J Q N E

SOLOMON

JERUSALEM

JONATHAN

GOLIATH

HARP

ARK OF THE COVENANT

DAVID

ELI

OIL

PHILISTINES

SAMUEL

SAUL

Name: \_\_\_\_\_

Date: \_\_\_\_\_

# God Made a Covenant with David

F N S M Z F D U Z V E R T V F A M I L Y Y G U K  
 V Q H I O M M Y V D C R E W W U H A S S A Q R I  
 W Y W A L C M R X S X F N B F S N F C N R B B C  
 C Q M M Q V G D B X J I T K D F X K J E S U S I  
 V V F V O K U Z V P B T A E H Q A I Q R K B P J  
 R C U P V U W S Y O P F R V K G Y N J C E B R R  
 N V U D P A L A C E N A T H A N G G K O U A O M  
 B H U F Z C D C Z R E E H C I K E D N X D F M E  
 G D A V I D E N S K E W B O B Z H O E M H E I A  
 F C Y C O V E N A N T X P C L X V M C Y A U S W  
 T M P P V P J G Z A M A Z I N G L B U R W B E C  
 M G Q G P S M O X L L A W A F B B K C D J B J E  
 U H N Q P H G S A G V B F W I Z P A A I J K R C  
 T E X K E A S P U P Y G T E A Z C S I D W Z J Y  
 Q B U B W R I E F E X Z D U W F S Y V I A Q M U  
 Z O Y M I K K L E C R Z U U N Y U Y U O W K N V  
 R K N O N Z M N U W K Z V Y P Q M W G Z D C Q T  
 R I Y H P G L H W M G V G Y W M Z S T R O N G C  
 K N K Q E O Q M A A U B W I P U Y C N Y P U R K  
 Q G Z W G D E K I F K E Q R G K A H Y D Q P E G  
 R B O F J V N A T B J G V A D S P Y U A I F D C  
 R U P T H P P T T B J C W I O R B A M Z Z W J O  
 S A M U E L C E E I P R S D N F J K R R B P M N  
 F A J T B X F O R E V E R E X W L R Q B R D K M

Amazing  
 King  
 Nathan  
 Jesus

Gospel  
 Family  
 Forever  
 God

Wait  
 Palace  
 Kingdom  
 David

Samuel  
 Tent  
 Covenant

Strong  
 Ark  
 Promise

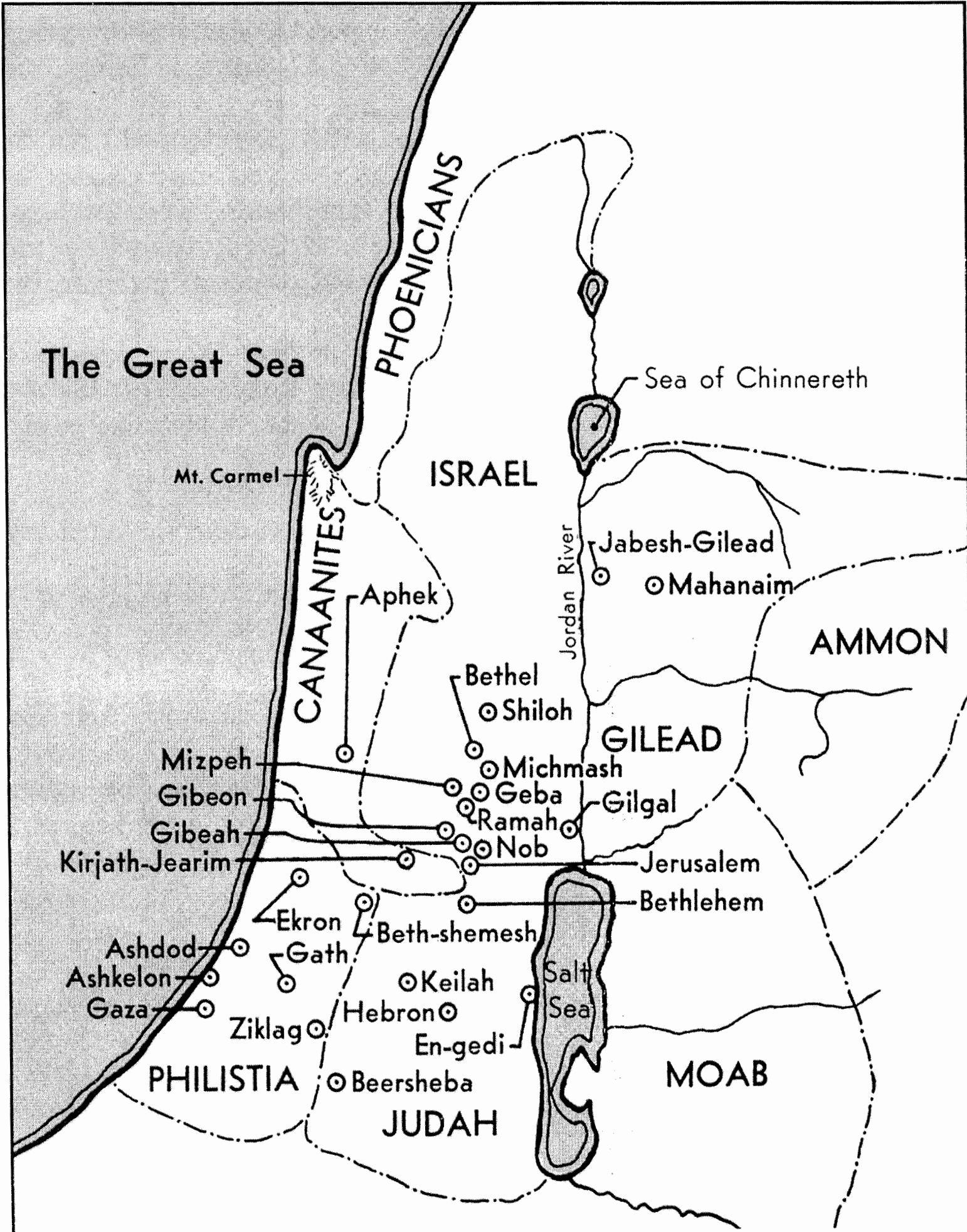

The Great Sea

PHOENICIANS

Sea of Chinnereth

Mt. Carmel

ISRAEL

Jordan River

Jabesh-Gilead

Mahanaim

AMMON

CANAANITES

Aphek

Bethel

Shiloh

GILEAD

Michmash

Mizpeh

Gibeon

Geba

Gilgal

Gibeah

Ramah

Nob

Kirjath-Jearim

Jerusalem

Bethlehem

Ashdod

Ekron

Beth-shemesh

Ashkelon

Gath

Keilah

Gaza

Ziklag

Hebron

En-gedi

Salt Sea

PHILISTIA

Beersheba

JUDAH

MOAB

**Year 2**

**Week 79**

**David and Bathsheba**

**Scriptures: 2 Samuel 11 & 12**

**Key Verse: 2 Samuel 11:27**“... But the thing that David had done displeased the Lord”

**Key Points:**

**1.** David saw a beautiful woman, Bathsheba, bathing from his rooftop. He inquired about her, sent messengers to get her, and then treated her as his own wife. She did not belong to David, however, she had her own husband Uriah.

**2.** David feared Uriah so he had Joab, the leader of the army, put him at the front of the battle and Uriah was killed. Bathsheba mourned her husband, but when her mourning was over she became David's wife and had a son.

**3.** Nathan, the Lord's prophet, came to David with a story about a ewe lamb. (recount this story) Nathan told David his taking Bathsheba from her husband was just as bad as the man who had taken the lamb. God was very displeased with him. David admitted his sin, however, his son died as his punishment.

**4.** David mourns his son, comforts Bathsheba, then has another son, Solomon, who the Lord loved. Because of David's sin, he experiences many years of unfortunate consequences.



# DAVID'S SIN

2 SAMUEL 11

## ACROSS

- 1) OPPOSITE OF GOOD
- 2) DAVID FELL IN \_\_\_\_\_  
WITH BATHSHEBA.
- 3) OPPOSITE OF  
SUNRISE.
- 4) BATHSHEBA WAS  
ALREADY MARRIED  
TO ANOTHER  
\_\_\_\_\_.

## DOWN

- 1) BEAUTIFUL MEANS  
FULL OF \_\_\_\_\_.
- 5) THE TOP OF A  
BUILDING
- 6) OPPOSITE OF OFF
- 7) TO BREAK GOD'S LAW -  
RHYMES WITH "PIN"

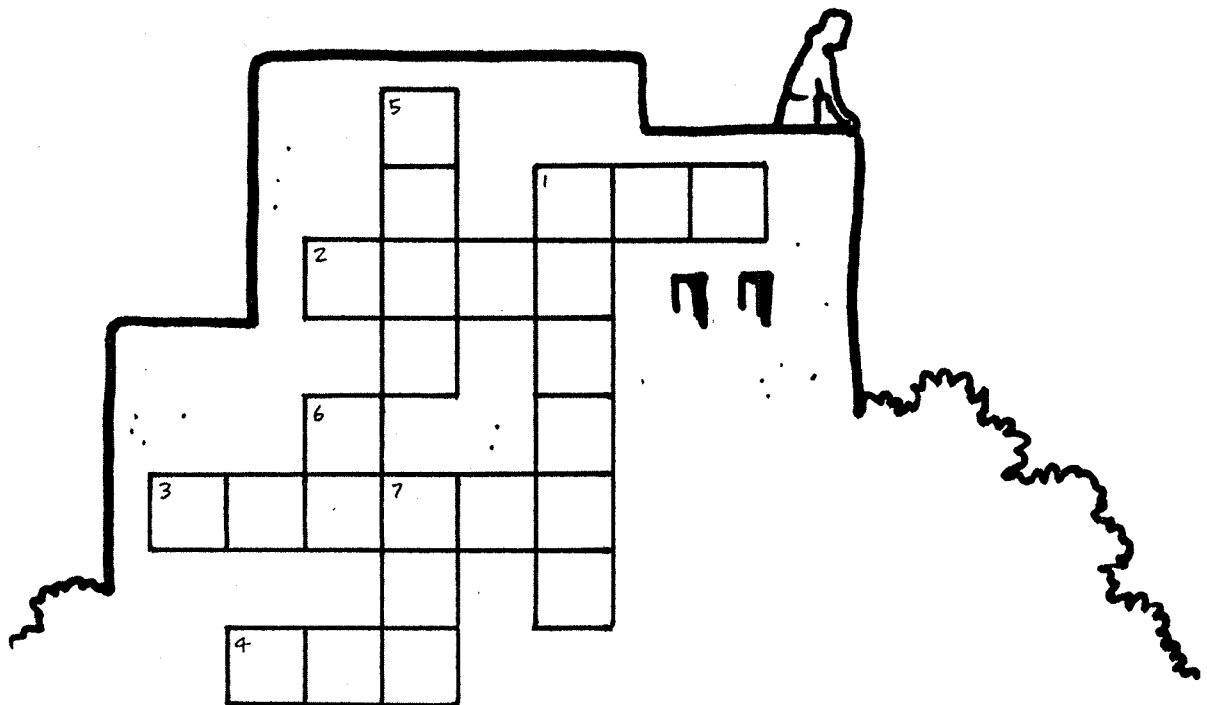

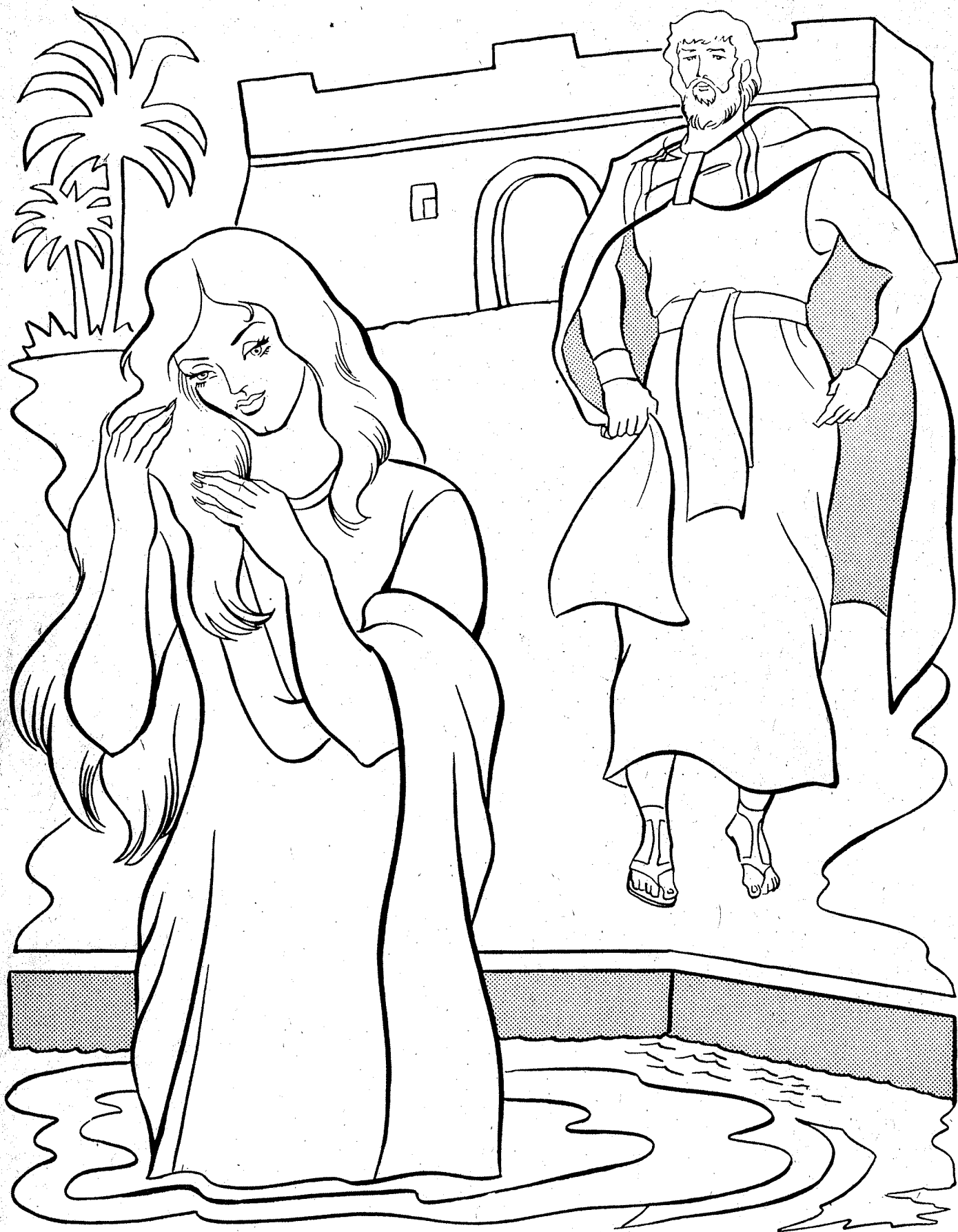

King David saw and deeply loved Bathsheba.  
She became his wife and bore him a son.

# *Bathsheba*

## **Word List**

WAR      BORN      DIED      JOAB  
LINE      ROOF      WIFE      BATHE  
DAVID      FIRST      FRONT      HOUSE  
SWORD      URIAH      BATTLE      PALACE  
HITTITE      HUSBAND      MOURNED      SOLOMON  
BEAUTIFUL

P F I H N E N I L D I E D N D  
A E O U U J T S T W L E R O A  
L H W B O S W I I T N O H M F  
A T A A R O B F T R B F O O R  
C A B I R B E A U T I F U L O  
E B F D R O B O N U I T S O N  
D A V I D U M H E D R H E S T

The woman was very beautiful, and David sent someone to

\_\_\_\_\_

\_\_\_\_\_.

2 Samuel 11:2,3

## 27. King David's Sin

One evening King David was walking on the flat roof of the palace. He looked down and saw a beautiful woman in her garden. He found out that her name was Bathsheba and that she was married to a soldier named Uriah.

David wanted to marry Bathsheba, but he couldn't because she had a husband. So David sent a terrible message to Joab, the commander of his army.

Cross out these letters: C, G, J, K, M, Q, V, X, Y, Z. The remaining letters spell the message.

**To Joab  
Commander of the Army of Israel**

V	P	M	U	T	U	K	R	I	A	H	C
I	N	Y	T	C	H	E	Q	F	X	R	O
G	N	T	K	O	F	T	H	J	E	B	A
M	T	T	Q	L	E	J	S	O	X	H	Y
E	W	Z	I	L	G	L	D	V	I	E	C

**From King David**

David committed two sins: murder and adultery.

God sent the prophet Nathan to show David his sins. David was very sorry for his sins and asked God to forgive him. God forgave David, but one of his punishments was that David and Bathsheba's first son died.

You can read about David's repentance in Psalm 51.

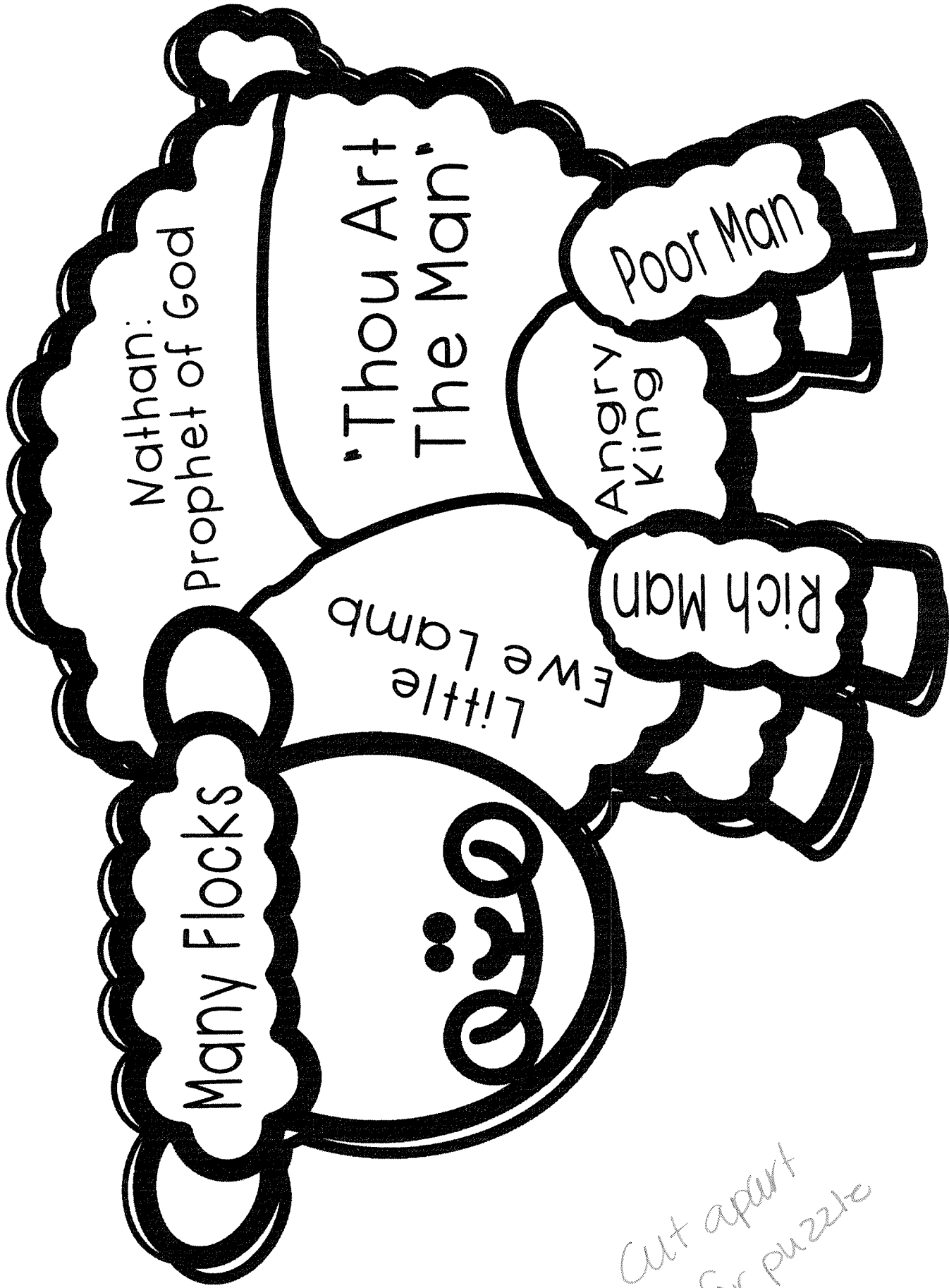

Nathan:  
Prophet of God

"Thou Art  
The Man"

Little  
Ewe Lamb

Many Flocks

Rich Man

Angry  
king

Poor Man

*Cut apart  
for puzzle*



David got into trouble with God when he took another man's wife - Bathsheba. He repented (asked forgiveness) of his sin, but there were still consequences. Their first son died and another tried to kill David. But their son Solomon was a great king! - **2 Samuel 11**

Name: \_\_\_\_\_

Date: \_\_\_\_\_

## David and Nathan

David was now King. But he did a very wicked thing. He took the \_\_\_\_\_, the wife of Uriah the Hittite, for his wife, and caused \_\_\_\_\_ to be killed. God was displeased at what he had done, and sent Nathan the prophet to reprove him.

\_\_\_\_\_ reproof was given by a parable. It was a story of a poor man who had one dear little \_\_\_\_\_. It grew up in his house, played with his \_\_\_\_\_, and was very precious to him. But one day a traveller came to a rich man, who possessed great flocks and herds. Instead of killing one of his own lambs to give to his guest, he took the poor man's lamb and killed it.

David heard the story, and was very \_\_\_\_\_. He said the rich man should \_\_\_\_\_, and the lamb taken away should be restored fourfold. Then Nathan, looking at the King, said: "You are the man!" He showed David how greatly he had \_\_\_\_\_, and told him that \_\_\_\_\_ and sorrow would come upon him for what he had done. God had given him riches and honour, and all that he could wish for; yet he had taken the one \_\_\_\_\_ thing of Uriah's, his wife, and had caused him to be slain. David was very upset when he saw how wickedly he had acted. He \_\_\_\_\_ his sin to God, and God \_\_\_\_\_ it.

1. angry

2. Bathsheba

3. children

4. confessed

5. die

6. forgave

7. lamb

8. Nathan's

9. precious

10. sinned

11. trouble

12. Uriah

Name: \_\_\_\_\_

Date: \_\_\_\_\_

## David and Nathan



sweetpublishing.com (CC BY-SA 3.0)

c	g	m	a	k	l	s	c	a	a	t	m
n	d	v	b	v	a	i	o	d	n	r	t
q	a	a	a	y	m	n	n	i	g	o	p
j	b	t	v	h	b	n	f	e	r	u	r
k	i	n	h	i	w	e	e	w	y	b	e
h	i	n	y	a	d	d	s	p	e	l	c
m	c	f	p	t	n	n	s	d	b	e	i
b	b	a	t	h	s	h	e	b	a	a	o
d	v	s	c	h	i	l	d	r	e	n	u
v	l	y	r	z	b	u	r	i	a	h	s

- |              |           |              |              |
|--------------|-----------|--------------|--------------|
| 1. David     | 4. Nathan | 7. confessed | 10. children |
| 2. Bathsheba | 5. lamb   | 8. precious  | 11. trouble  |
| 3. Uriah     | 6. sinned | 9. angry     | 12. die      |



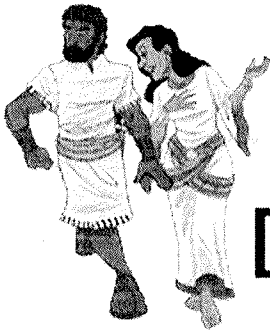

# Bible Pathway Adventures

CROSSWORD

## DAVID & BATHSHEBA

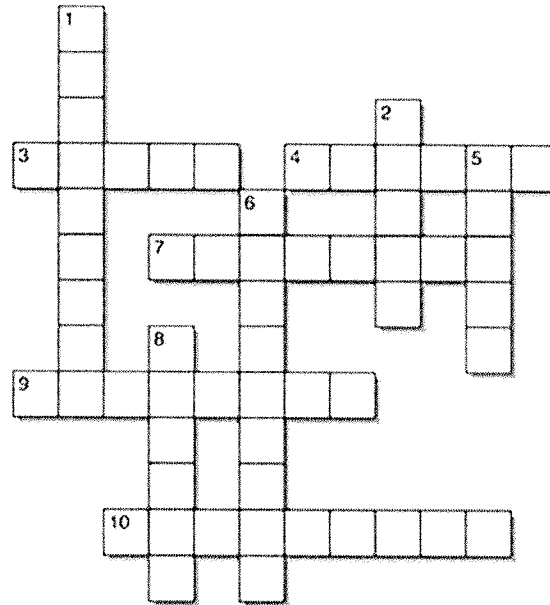

### ACROSS

- 3) On the seventh day the \_\_\_\_\_ died. (2 Samuel 12:18 ESV)  
4) Kings of Israel go to battle in which season? (2 Samuel 11:1 ESV)  
7) Bathsheba told David, "I am \_\_\_\_\_." (2 Samuel 11:5 ESV)  
9) "When Bathsheba heard her husband was dead, she \_\_\_\_\_ over her husband."  
(2 Samuel 11:26 ESV)  
10) David lived in this city. (2 Samuel 11:1 ESV)

### DOWN

- 1) Name of Uriah's wife. (2 Samuel 11:3 ESV)  
2) David arranged for \_\_\_\_\_ to be killed in battle. (2 Samuel 11:15 ESV)  
5) Name the prophet who confronted David with his adultery. (2 Samuel 12:1 ESV)  
6) Bathsheba was very \_\_\_\_\_. (2 Samuel 11:2 ESV)  
8) In the morning David wrote a \_\_\_\_\_ to Joab. (2 Samuel 11:14 ESV)

©Bible Pathway Adventures 2018. For free Bible resources and Teacher Packs including coloring pages, worksheets, quizzes and more visit our website at: [biblepathwayadventures.com](http://biblepathwayadventures.com)

## Year 2

### Week 80

#### David's Kingship is Threatened - Absalom Dies

**Scriptures:** 2 Samuel 13:37 – 2 Samuel 19

**Key Verse:** 2 Samuel 22:48 “It is God who avenges me, who subdues the people under me, who delivers me from my enemies....”

#### **Key Points:**

1. David's son Absalom, killed his brother Amnon for an evil thing he had done to their sister. Absalom fled Jerusalem because of the killing. David missed him very much and sent for him to come back.
2. Absalom was very handsome; he had long, strong hair. He was proud and rebellious against his father. He conspired to be king and to overthrow his father David. He gathered support throughout the tribes of Israel and his forces were great in number.
3. David hears of Absalom's plan. He, his household, and army fled Jerusalem, across the Jordan to safety. Two of David's servants, Jonathan and Ahimaaz, stayed behind to keep track of Absalom's activities. They were found out, but a woman hid them in a well and placed grain over them. They were then able to report to David. God keeps Absalom from pursuing David until he is able to regroup his troupes.
4. David divides his army into 3 groups. He told them to deal gently with Absalom. There was a great battle, 20,000 men died.
5. Absalom, riding on a mule through thick woods, was caught by his hair in a tree and was left hanging in the branches. Joab, the leader of his army, discovers him and disobeying the king, kills him with his sword to retaliate for his rebellion of the king.

6. David's army had won the battle but David grieved for Absalom. He journeyed back to Jerusalem and reigned as king again. God's will was accomplished as he wanted David to be king, not Absalom.

**\*\*\*Teachers:**

There is a lot of detail in these chapters. Younger children may be unable to absorb it all. Teach as much of it as you can, hitting the most important details.

## Absalom's Rebellion

**To Remember:** Beauty and popularity do not make one valuable

**Lesson** 2 Samuel 14-18

- 2 Samuel 15:4 Absalom's lie
- Absalom had killed his brothers
- Joab helped Absalom get back into Jerusalem
- Absalom betrayed his father
- Took over kingship
- David fled, his servants helped
  - **Act Out:** Hushai gave bad advice to Absalom
- David escapes
- Absalom is caught and killed
- David grieved greatly

**Activity:** "Mom or Dad Says": played like Simon Says, only use Mom or Dad

**Sing:** Be careful little feet

**Craft:** cut out round paper heads, use crimped paper, yarn etc to make Absalom's long hair.

**Memory Work:**

2 Samuel 15:6b "So Absalom stole the hearts of the men of Israel."

**True or False**

1. David had a loving family. F
2. Absalom "honored" his father. F
3. David loved his children. T
4. Joab always considered David's feelings first. F
5. The people loved David. T
6. Absalom was beautiful inside & out. F

**Review Questions** for gameboard



### linguistic questions

1. Define betray.
2. Define forgive.
3. Define reign.



### activity questions

1. Draw a throne.
2. Act out David fleeing.
3. Act out Absalom being caught.

# ABSALOM'S EVIL PLANS

2 Samuel 15-18

Find the hidden items from the key box in the picture. Circle them.

David's son Absalom wanted to be king.

He began telling people that he would make a better king than his father. Soon many people wanted Absalom to be king instead of David.

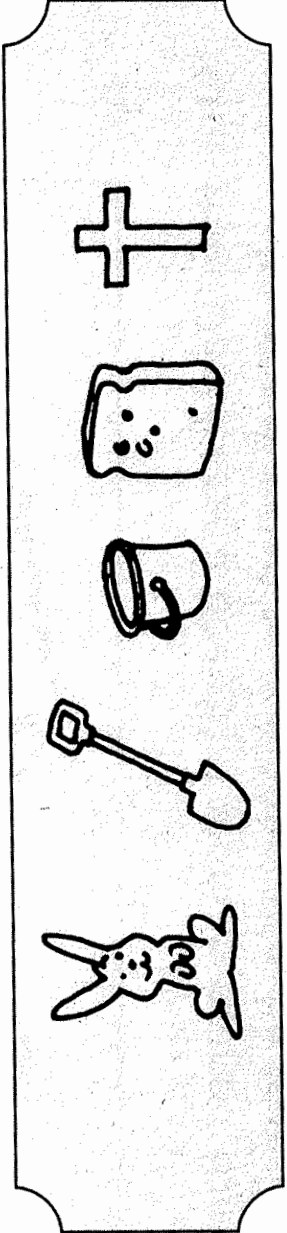
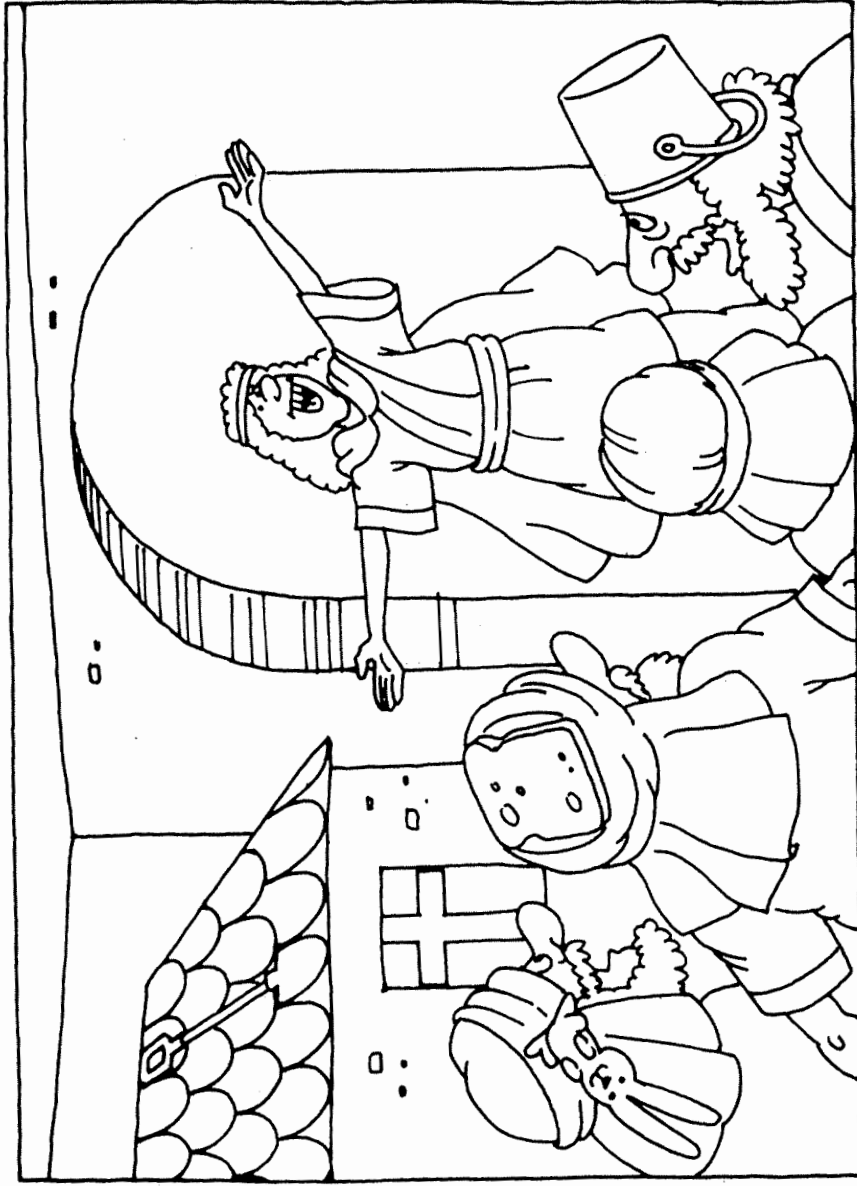



### emotion questions

1. David's children caused him \_\_\_\_\_.
2. Absalom's death made David feel \_\_\_\_\_.
3. Is God peaceful or argumentative?



### application questions

1. If we want to be like God, we should act \_\_\_\_\_.
2. How do we honor our parents?
3. How do we make peace at home?



### fact questions

1. Who was Absalom?
2. Who helped, then killed, Absalom?
3. Describe Absalom physically?



### review questions

1. How was Absalom caught?
2. How did Absalom become popular?
3. How did David gain time to escape?

[home](#) | [top](#) | updated June 14, 2010

**Privacy Notice:** Information you share on this site will not be sold, shared or otherwise given to any third party.

**Copyright:** Sunday School Sources at eBibleTeacher.com ©2000-2010 Papyrus Document & Design, LLC All rights reserved. [Read our usage terms.](#)

**Advertisements:** Some of these ads are randomly generated. If you see an inappropriate ad, please [contact me](#) **WITH THE URL** so I can block the ad. [Our ad policy.](#)

**NETFLIX**  
Rent *Dexter: Season Four* today!

Watch TV Shows From Netflix  
**FREE TRIAL!** [Click here](#)

# Absalom's Rebellion

2 Samuel 13:30 - 18:33



## Absalom Dies

And Absalom rode upon a mule, and the mule went under the thick boughs of a great oak, and his head caught hold of the oak, and he was taken up between the heaven and the earth;





## Absalom

Who was the one who helped to persuade David to be reconciled with his son? (1) Absalom (2) Amnon (3) Jonadab (4) Joab

Answer: 4

How many years did Absalom spend to plan and execute his rebellion plan? (1) 2 years (2) 4 years (3) 6 years (4) 8 years

Answer: 2

Who was David's advisor?

(1) Zadok (2) Abiathar (3) Ahithophel (4) Hushai

Answer: 3

Where did Ahimaaz and Jonathan hide in order to escape from Absalom's men? (1) A deserted house (2) A cave (3) A tree (4) A well

Answer: 4

What did Ahithophel do when he knew his advice had not been followed? (1) Ran away in fear (2) Hanged himself (3) Protested against the king's decision (4) Hid himself silently

Answer: 2

Which of the following was not appointed a captain over David's troops?

(1) Shobi (2) Joab (3) Abishai (4) Ittai

Answer: 1

David's men said he was worth \_\_\_\_\_ of them.

(1) 100 (2) 1000 (3) 10000 (4) 100000

Answer: 3

What had caused Absalom to be caught in the tree?

(1) His weapon (2) His armor (3) His tunic (4) His hair

Answer: 4

What did David do, knowing that Absalom was dead?

(1) Rejoice over the death of his enemy (2) Celebrate his victory (3) Mourn and cry for him (4) Mourn for him silently

Answer: 3

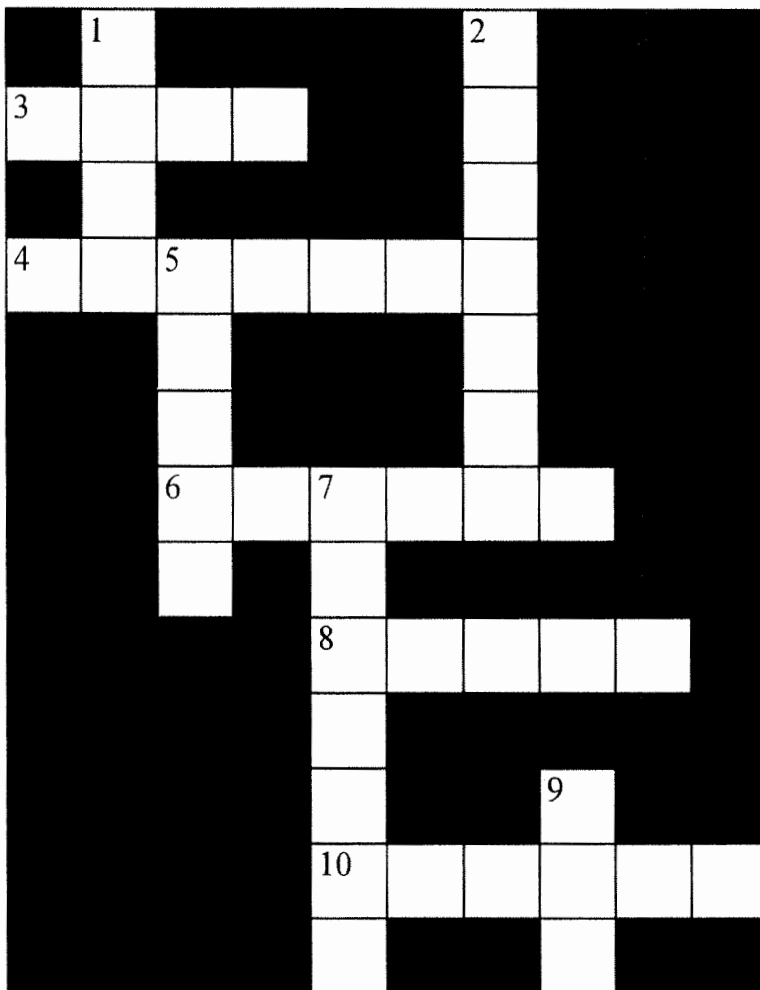

**ACROSS**

- 3** For the battle was there scattered over the face of all the country: and the \_\_\_\_\_ devoured more people that day than the sword devoured.
- 4** And the king commanded Joab and Abishai and Ittai, saying, Deal gently for my sake with the young man, even with

- \_\_\_\_\_.
- 6** Where the people of Israel were slain before the servants of David, and there was there a great slaughter that day of \_\_\_\_\_ thousand men.
- 8** And he took three darts in his hand, and thrust them through the \_\_\_\_\_ of Absalom, while he was yet alive in the

midst of the oak.

- 10** So the people went out into the field against \_\_\_\_\_:

**DOWN**

- 1** And a certain man saw it, and told \_\_\_\_\_, and said, Behold, I saw Absalom hanged in an oak.
- 2** And Joab blew the \_\_\_\_\_, and the people returned from pursuing after Israel: for Joab held back the people.
- 5** And ten young men that bare Joab's armour compassed about and \_\_\_\_\_ Absalom, and slew him.
- 7** . . .and the battle was in the wood of \_\_\_\_\_;
- 9** And Absalom rode upon a mule, and the mule went under the thick boughs of a great \_\_\_\_\_, and his head caught hold of the \_\_\_\_\_, and he was taken up between the heaven and the earth;

A T E P M U R T E T T D H D S  
 B P U R S U I N G H P T E A M  
 S O B S O T D A S S E A R R W  
 A A O S W O O D H M I I N T A  
 L S T O N E S G E S U W B S H  
 O R G T I M O E U E I A I E S  
 M S S I B A S N R T O B A G O  
 R M O M S N G T R J S R A S A  
 H O R D I I A L L N T U M R K  
 L T A I M T H Y S N B A R T U  
 A E S V M N E E S H N T L H E  
 S J Y A S P O I S R A E L R T  
 G W I D I I R B E I A T T I O  
 S Y A T E T W R E P H R A I M  
 E L T T A B F O R T H S W H T

W  
 h  
 e  
 a  
 s  
 e  
 s  
 a  
 r  
 e  
 p  
 r  
 e  
 s  
 e  
 n  
 t  
 e  
 d  
 h  
 e  
 r  
 e

**3 Letters**  
 OAK  
 PIT

**4 Letters**  
 JOAB  
 WOOD

**5 Letters**  
 DARTS  
 DAVID

FORTH  
 HEART  
 ITTAI  
 SMITE  
 SMOTE

**6 Letters**  
 BATTLE  
 GENTLY  
 ISRAEL  
 STONES

THRUST

**7 Letters**  
 ABISHAI  
 ABSALOM  
 EPHRAIM  
 SEEMETH  
 TRUMPET

**8 Letters**  
 PURSUING



**God wants  
me to...**

**Absalom was...**

## **Year 2**

### **Week 81**

### **Solomon Becomes King – King David Dies**

**Scriptures: 1 Kings 1 – 1 Kings 2:12**

**Key Verse: 1 Kings 2:3** “Keep the charge of the Lord your God: to walk in His ways, to keep His statutes, His commandments, His judgments, His testimonies, as it is written in the Law of Moses, that you may prosper in all that you do and wherever you turn.”

#### **Key Points:**

- 1.** David was old and feeble. His son Adonijah was as handsome and persuasive as Absalom. He attempts to take the throne as David’s death is coming. He gets Joab, the head of David’s army, and Abithar the priest on his side.
- 2.** Nathan, the prophet, hears of this and approaches Bathsheba to go talk to David. Her son Solomon was expected to be David’s choice to be his successor.
- 3.** Bathsheba speaks with David and he confirms Solomon is his choice. Zadok the priest and Nathan the prophet anoint Solomon.
- 4.** Adonijah heard and was afraid of Solomon. Solomon agreed to spare his life if he could live respectfully and honorably.
- 5.** David gives Solomon words of advice as he takes the throne as king. He tells him to keep the charges and statues of the Lord. His kingdom was “firmly established”. Adonijah, and Joab are eventually executed because of their betrayal, Abithar is removed as priest also. David dies and is buried in Jerusalem. David reigned over Israel 40 years.

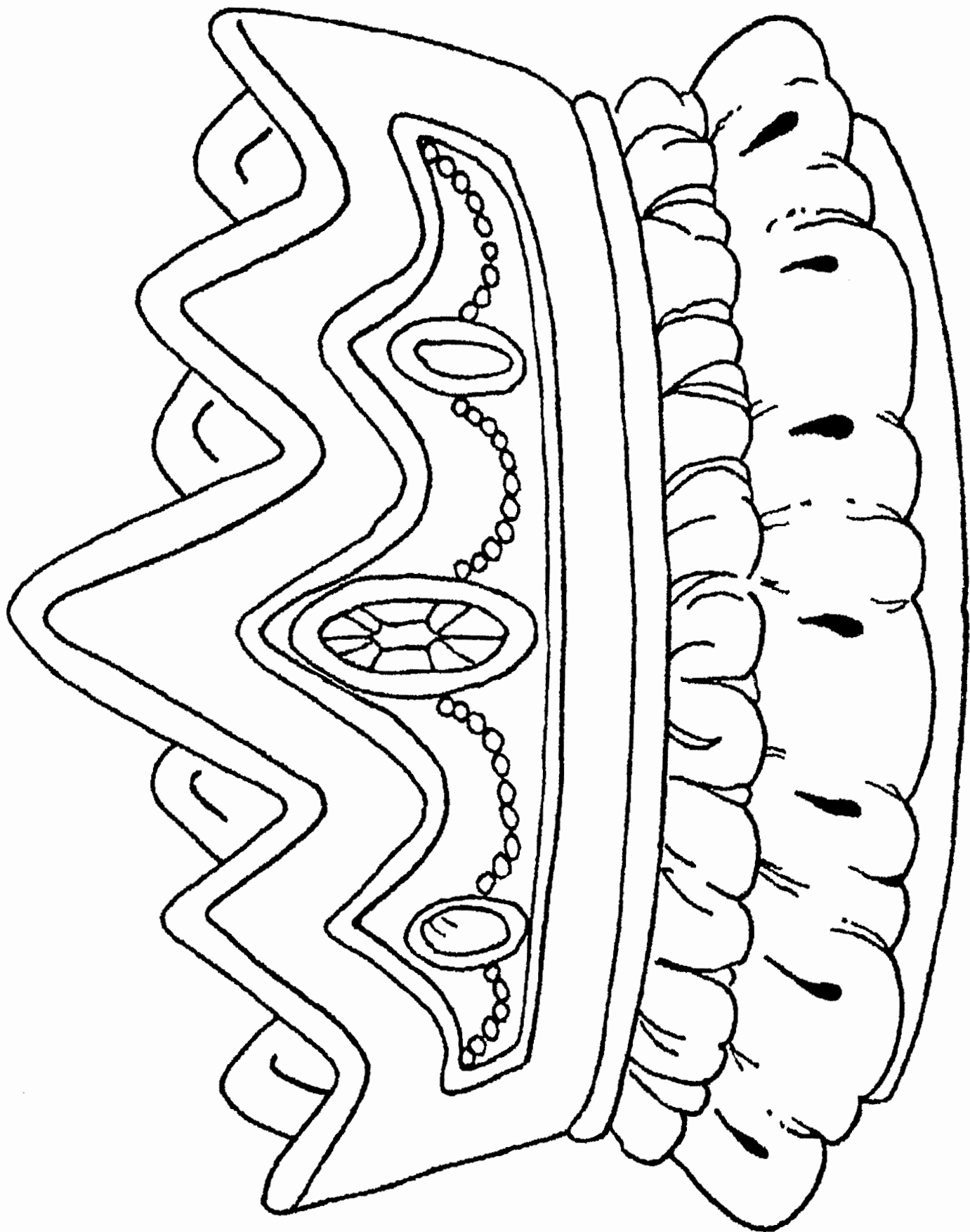

Adults: Use with any lesson on Jesus as King.  
May use glitter, sequins, or jewel-like pieces to decorate the picture.



King David, on death's bed, said to his son Solomon, "Obey the laws of our God in order that you may act wisely."

# 88. SOLOMON IS MADE KING

(1 KINGS 1:28-53)

U Y S V X O Q T Z A C X P Y I G C O Y A  
 Y K N N W A J N Z N U N N B A C H A X D  
 Y P B G E V N D N A N O I N T Z R K D D  
 R U N G B C I A K F J A K B G H E U N W  
 N I K D L A C R H T K Y B P W K M N B T  
 K Y K P V A T A O T S Q C P E N O R H T  
 H N O K D L T H B Q A U D B A K Q U E L  
 E K J S D O C Z S H M N W E N N N D H A  
 L T Q P Z Z J E R H J Q K N U O Y L T O  
 M G S P Z M W M H E E T I A T M M O I L  
 G Z P R O F Y D N A L B E I O O A U L A  
 M E A X W G J W V U T U A A M L S N U P  
 B Y M D H M R Q I U A H R H J O V L W A  
 P G B O O Q T E N R O H D Y K S Y Y Q D  
 M M B S Q K N N A T A T I N G R K H N Y  
 W Q O L I S A I O T U T V O H E W X I S  
 N H H K L Q S T N T E R A J G N L O S M  
 G V S W H V L A H D E R D W D C W I V U  
 K V S V T P P L I D N R P S V V W R U L  
 B G R J Y B U B U Q Q W I S B C Z N U S

ANOINT  
 BATHSHEBA  
 BENAIAH  
 DAVID  
 GREATER

HORN  
 KING  
 NATHAN  
 OIL

RULER  
 SOLOMON  
 THRONE  
 ZADOK

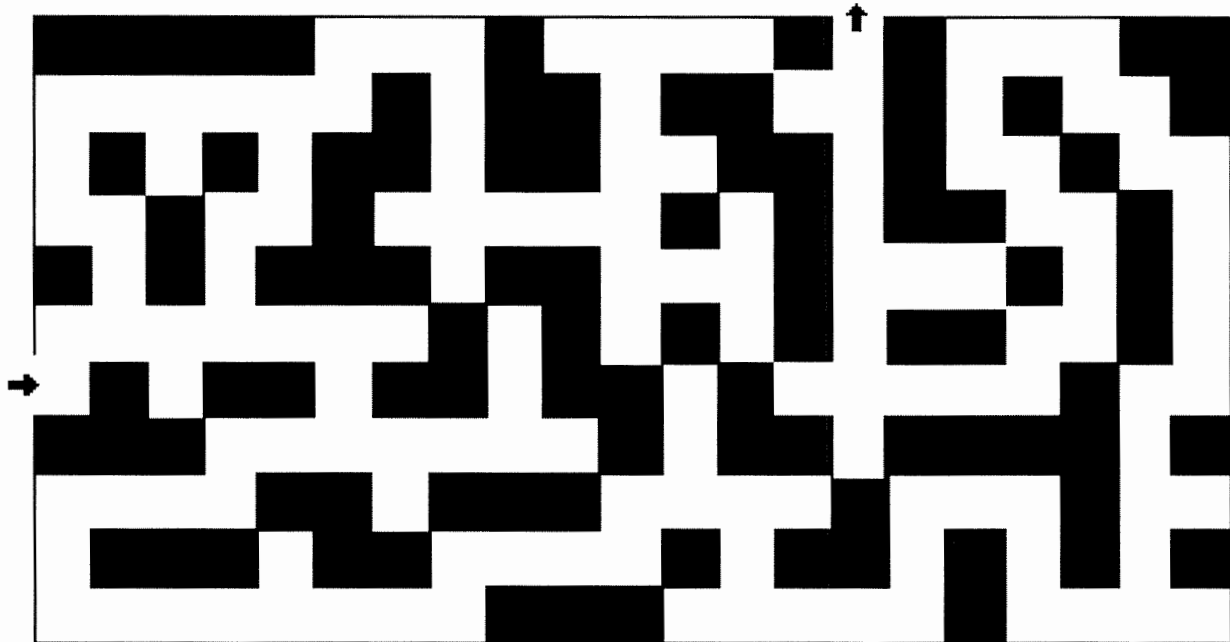



# 28. Solomon on David's Throne

## 1 Kings 1

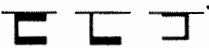
King David was very 

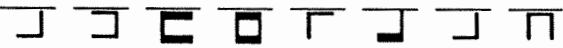
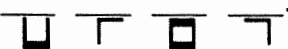
, his son, tried to make himself 

 told David what Adonijah was doing.

David said, "No, the next king will be my son

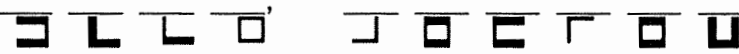

David asked  the priest and

 the prophet to let Solomon ride on the king's  him

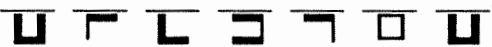
with , and blow the 

They did as David asked. Then all the people shouted,

"

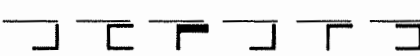

Adonijah was  when he heard what

had happened. He grabbed the  of the

 and begged Solomon for his life.

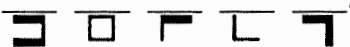
Solomon showed him 

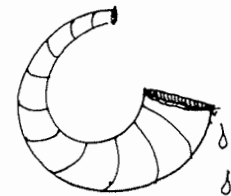
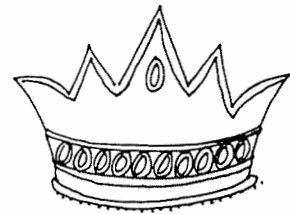

A	B	C
D	E	F
G	H	I

J	K	L
M	N	O
P	Q	R

S	T	U
V	W	X
Y	Z	

# DRAWING FUN

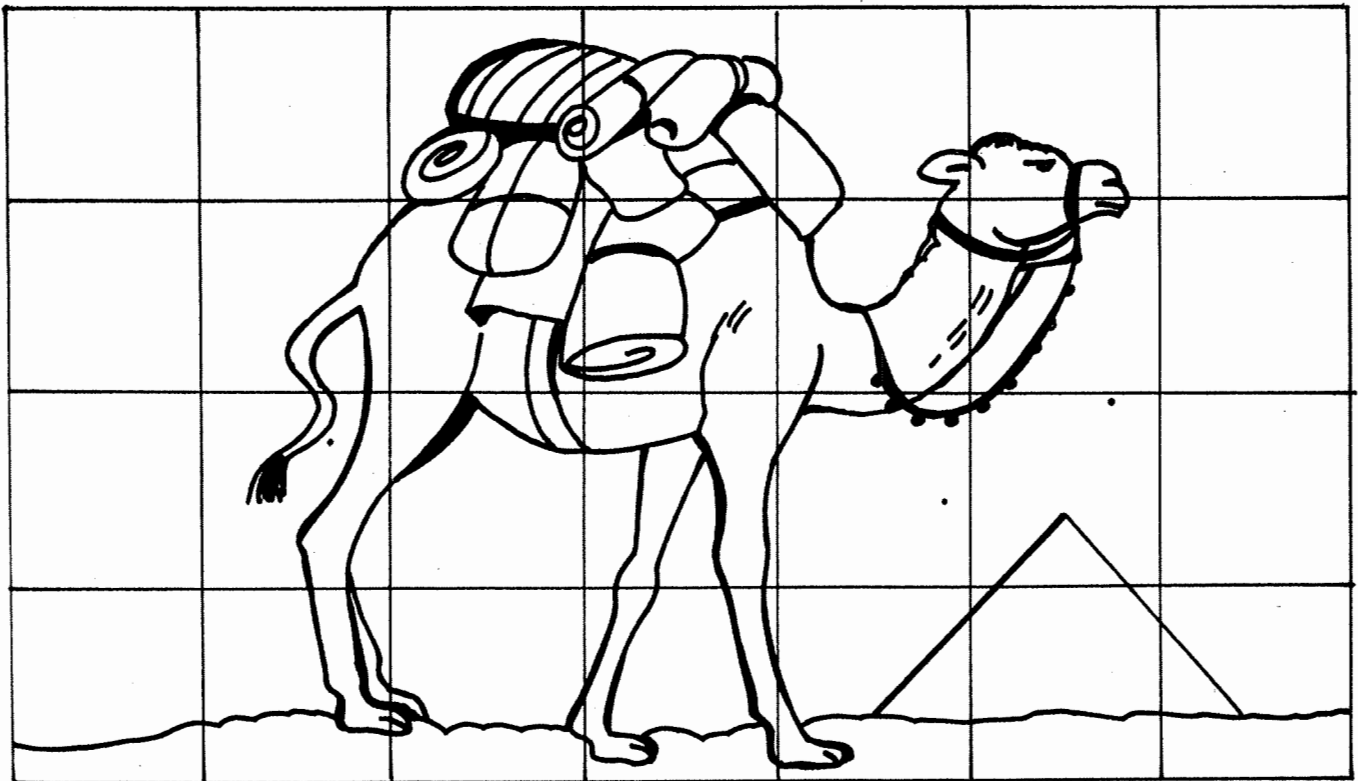

Use the dotted lines and the squares below to draw a camel like the one above. People in Solomon's time used camels to travel to Jerusalem.

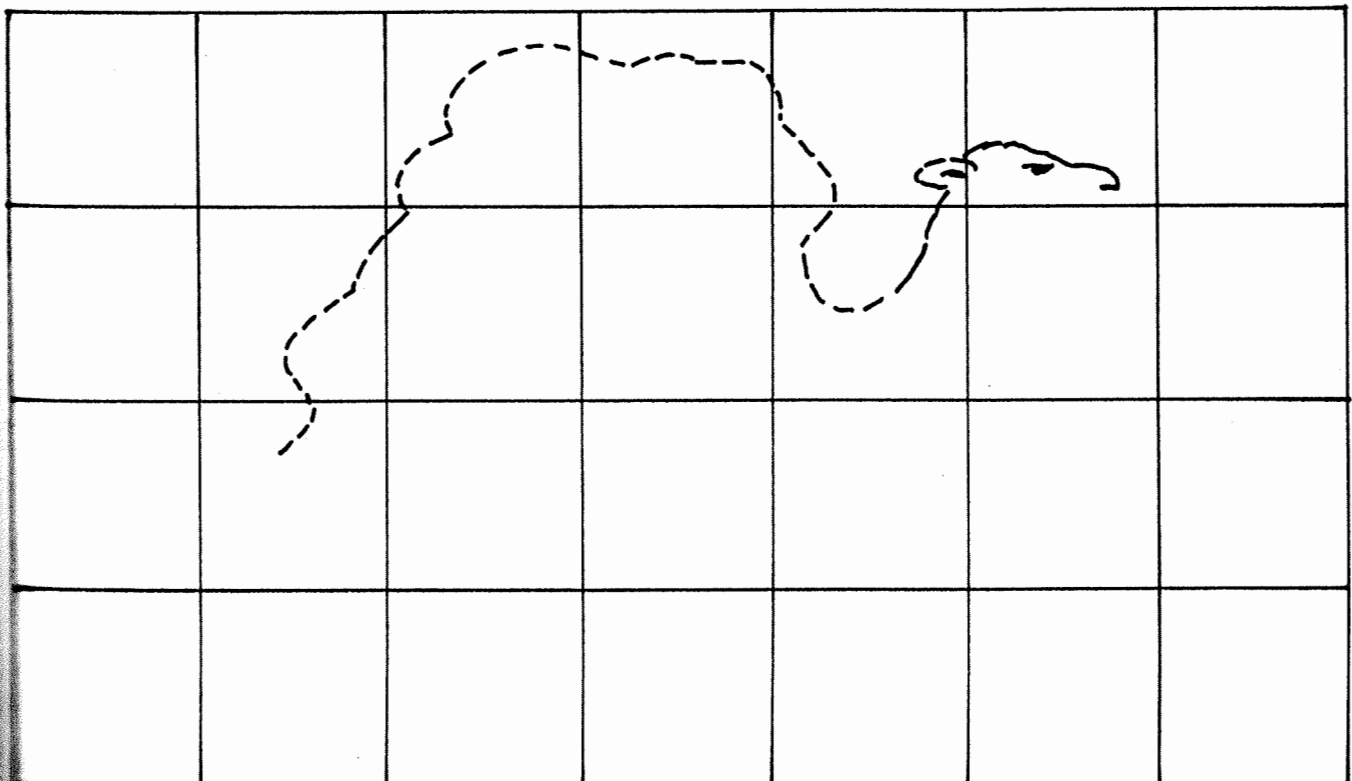

## 88. SOLOMON IS MADE KING (1 KINGS 1:28-53)

### MEMORY VERSE:

*"As the LORD has been with my lord the king, even so may He be with Solomon."* 1 KINGS 1:37

### FILL IN THE BLANK:

1. Now Bathsheba came to David and "the king took an oath and said, 'As the LORD lives, who has redeemed my life from every distress, just as I swore to you by the LORD GOD of Israel, saying, "Assuredly Solomon your son shall be \_\_\_\_\_ after me, and he shall sit on my throne in my place," so I certainly will do this day.'" 1 KINGS 1:29-30

### TRUE OR FALSE:

2. "Then Bathsheba bowed with her face to the earth, and did homage to the king, and said, 'Let my lord King David live forever!' " 1 KINGS 1:31

TRUE OR FALSE

### UNDERLINE THE CORRECT ANSWER:

3. "And King David said, 'Call to me...'" 1 KINGS 1:32
  - a. Zadok the priest
  - b. Nathan the prophet
  - c. Benaiah the son of Jehoiada
  - d. all of the these

### FILL IN THE BLANKS:

4. "The king also said to them, 'Take with you the servants of your lord, and have \_\_\_\_\_ my son ride on my own mule, and take him down to Gihon.'" 1 KINGS 1:33
5. "Let Zadok the priest and Nathan the prophet \_\_\_\_\_ him king over Israel; and blow the horn, and say, 'Long live King Solomon!'" 1 KINGS 1:34
6. "Then you shall come up after him, and he shall come and sit on my throne, and he shall be king in my place. For I have appointed him to be \_\_\_\_\_ over Israel and Judah." 1 KINGS 1:35
7. And Benaiah said, "As the LORD has been with my lord the king, even so may He be with Solomon, and make his throne \_\_\_\_\_ than the throne of my lord King David." 1 KINGS 1:37
8. "Then Zadok the priest took a horn of oil from the tabernacle and anointed Solomon. And they blew the horn, and \_\_\_\_\_ the people said, 'Long live King Solomon!'" 1 KINGS 1:39

# YOUNG SOLOMON ANOINTED 1 KINGS 1:38-53

## ACROSS

- 1) DAVID WAS GETTING \_\_\_\_\_, NOT YOUNG.
- 2) DAVID'S SON, \_\_\_\_\_, WOULD BE ISRAEL'S NEW KING.
- 3) ZADOK, A \_\_\_\_\_, ANOINTED SOLOMON (RHYMES WITH "LEAST").

## DOWN

- 1) SOLOMON WAS ANOINTED WITH \_\_\_\_\_.
- 2) SOLOMON WAS DAVID'S \_\_\_\_\_.
- 4) SOLOMON RODE ON DAVID'S \_\_\_\_\_, A CROSS BETWEEN A HORSE AND A DONKEY. (RHYMES WITH "RULE")
- 5) SOLOMON WOULD BE THE \_\_\_\_\_ KING AFTER KING DAVID (RHYMES WITH "TEXT").
- 6) SOLOMON \_\_\_\_\_ ON HIS FATHER'S MULE.

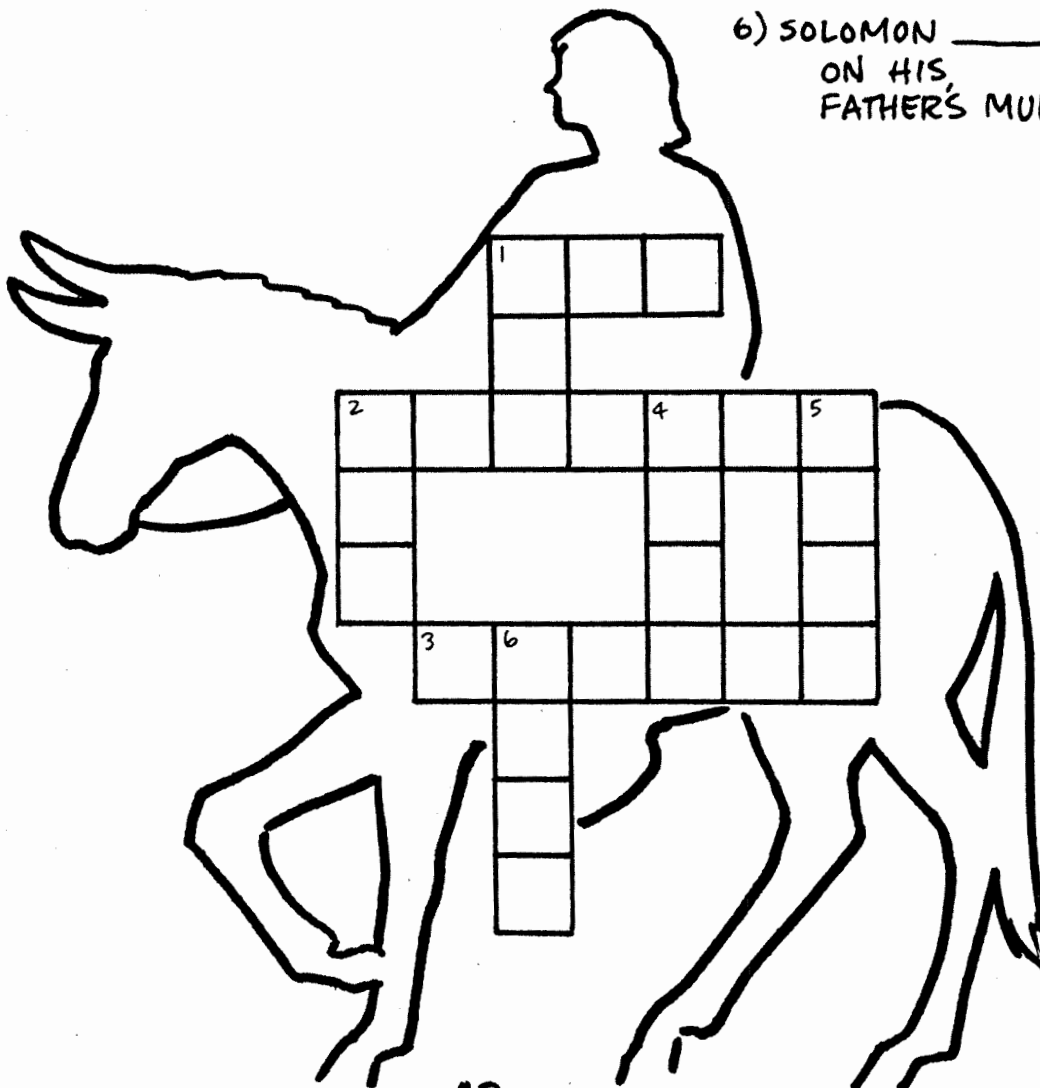

**Year 2**

**Week 82**

## **Solomon Asks for Wisdom**

**Scriptures: 1 Kings 3**

**Key Verse: 1 Kings 3:9** “Therefore, give your servant an understanding heart to judge Your people, that I may discern between good and evil....”

### **Key Points:**

**1.** Solomon makes an agreement with the Pharaoh of Egypt-he marries his daughter to gain an alliance with Egypt. He loved the Lord and followed his statues except, he sacrificed at the idolatrous high places. This was a bad influence from his Egyptian wife.

**2.** The Lord appears to Solomon in a dream, asking him what he could give him. Solomon chose wisdom. This pleased the Lord and he gave him the wisdom he asked for and also gave him riches and honor.

**3.** After this dream, Solomon was sacrificing and two women came to him to settle a dispute. Both women had babies but one baby had died in the night. They both claimed the living baby was theirs. Solomon asked for a sword and ordered the baby to be cut in two and give each woman one half of the baby. One mother cried out in protest and said to give it to the other mother, the other mother said to go ahead and split the child. Solomon said the mother wanting to save the child and give to the other was the true mother, she did not want harm to come to the baby. He gave her the baby, showing the wisdom God had given him.

**4.** All Israel heard of his judgment and wisdom. They revered and feared the king, knowing he had the wisdom of God to give justice.

# KING SOLOMON

David ruled wisely and well for many years. When he died, his son Solomon became king. God asked Solomon what gifts he wished for. He asked for wisdom, that he might rule well. God was very pleased with this answer.

Solomon grew to be the wisest man in the world. It was given to him to build the holy temple in Jerusalem where all the Israelites could come to worship God. Now Jerusalem was the capitol of all Israel and the tablets of God's commandments given to Moses were brought there.

The finest materials from all over the world and the best workmen came to Jerusalem to build the temple, as Solomon commanded.

Solomon was also a great writer. His father David had written the Book of Psalms. Solomon wrote the Book of Proverbs. Both of these Books are very important parts of the Holy Bible.

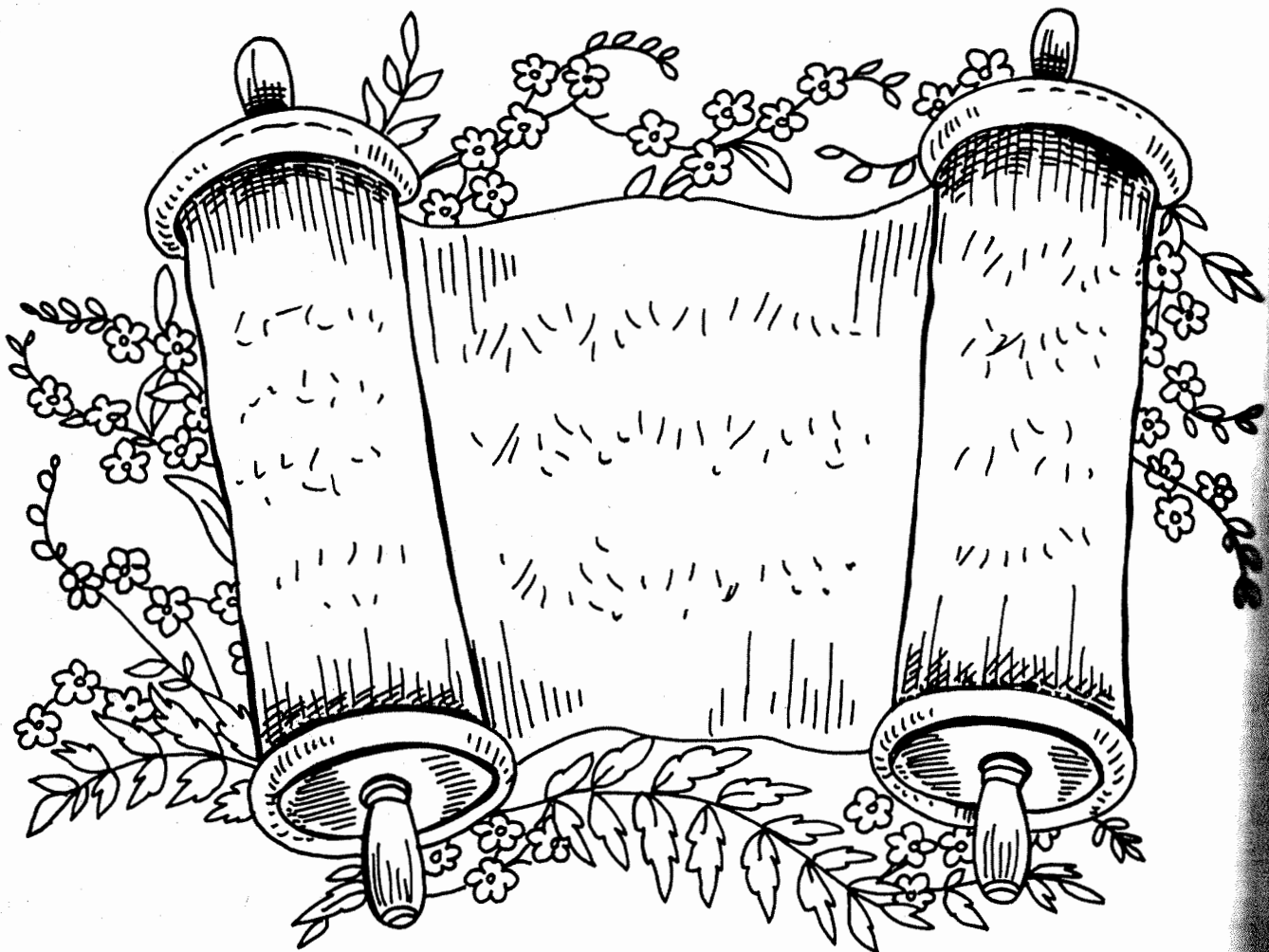



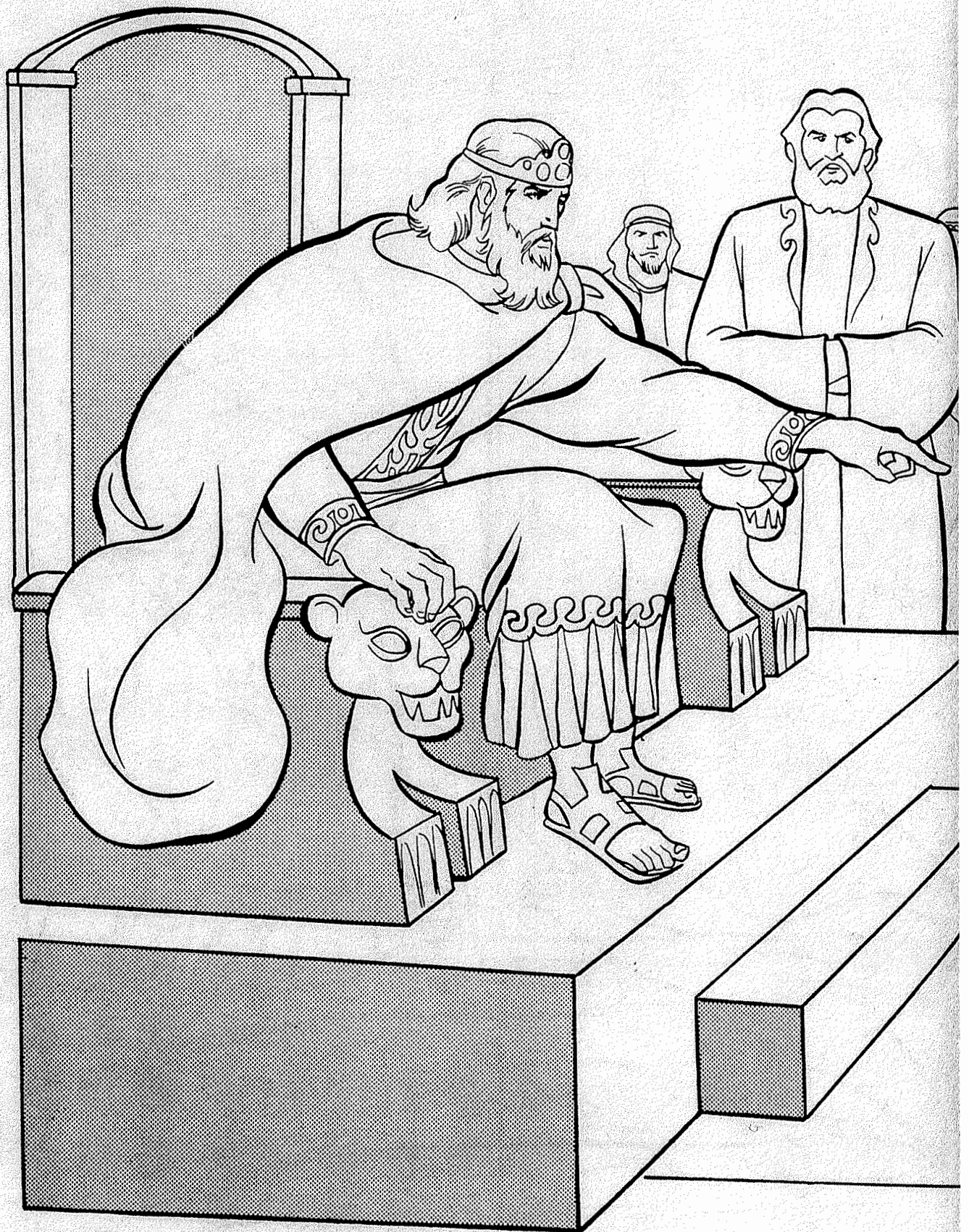

When two mothers claimed one child, the wise King Solomon decreed, "Cut the living child in half, and give one-half . . .



Because she could not see her child harmed, King Solomon knew the true mother, and the child was given to her.



# \* Find Wisdom \*



## Memory Verse

I will give you a wise and discerning heart, so that there will never have been anyone like you, nor will there ever be.

~ 1 Kings 3:12

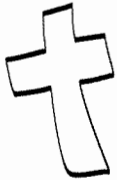

## Bible Truth

God wants me to try to make good choices.



## Bible Story

Solomon chooses wisdom from God. (1 Kings 3:1-14)



## What You Need

\* page 36

\* pencils



## Before class



Duplicate a pattern page for each child. Do the puzzle so you will be prepared in case some students need help with theirs.

## What to Do



1. Give each child a pattern page.
2. Tell the story of Solomon's choice from 1 Kings 3:1-14.
3. Say, Solomon could have anything he wanted. But he knew the best choice was to have wisdom. Solomon showed God that he cared about Him and His people. God rewarded Solomon for his choice. God rewards us when we make good choices, too.
4. Have the students fill in the blanks using the code. Say, Find some ways to get wisdom by choosing the matching letter to put in each blank. We will find some ways we can gain wisdom. (Answers: 1. Bible; 2. prayer; 3. church; 4. parents)
5. After the puzzles are finished, have someone read each word out loud. Ask the students for other ways they can gain wisdom to do God's work.



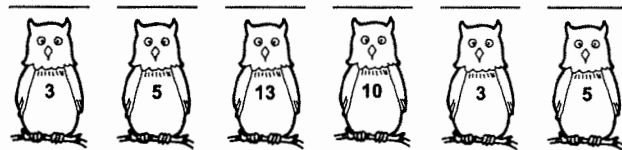
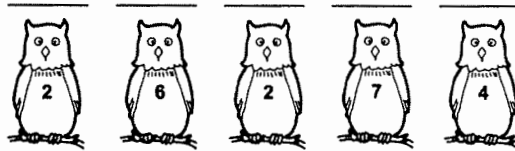
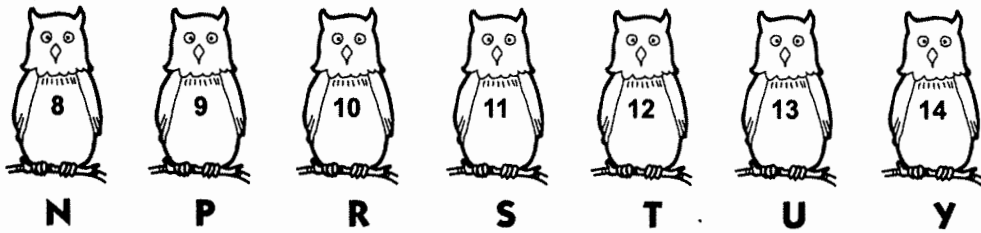
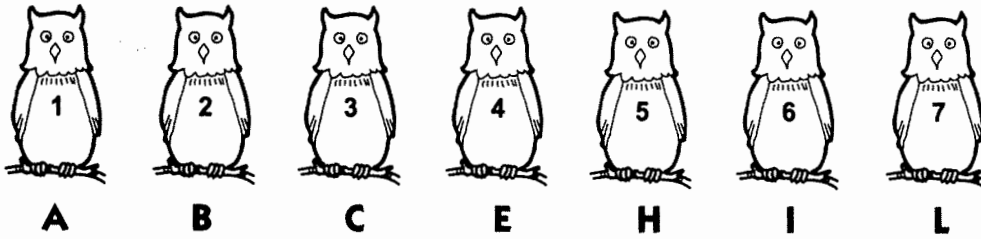

I will give you a wise  
and discerning  
heart, so that there  
will never have been  
anyone like you, nor  
will there ever be.  
1 Kings 3:12

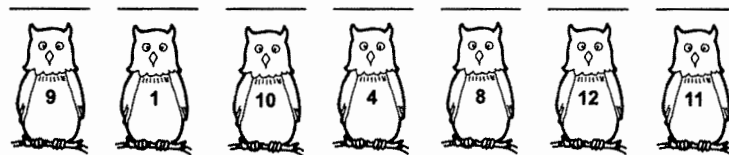

# What Doesn't Belong?

Read the story "A Sword and a Baby." Look at the pictures below. Which pictures do not belong to the story? Put an X on them. Color the pictures that do belong.

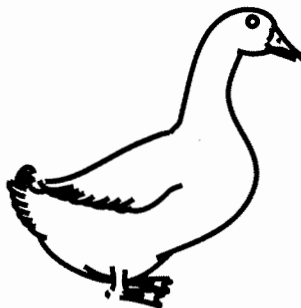
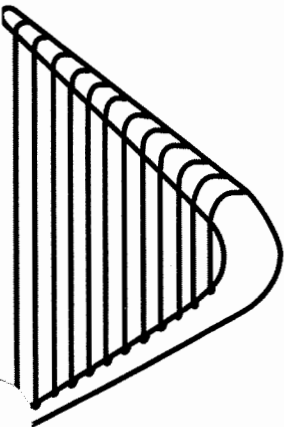
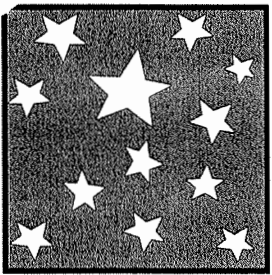
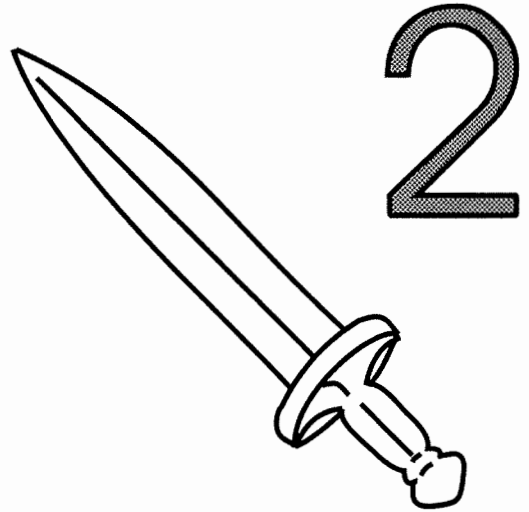
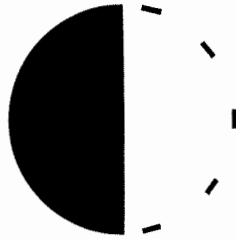
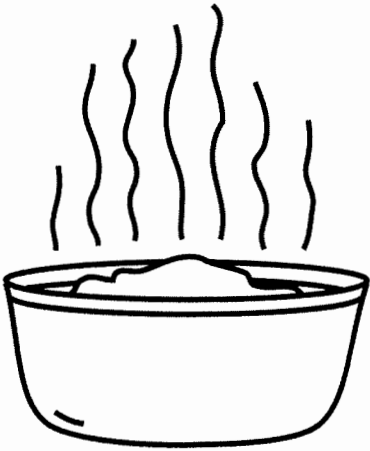

# A Sword and a Baby



king

2

two



mother



house



baby



night



























die













sword



half

 Solomon was a good . He was a wise . He did what was right. Here is a story about  Solomon. Once there were 2 s. The s lived in the same . Each  had a . One  one  d. Both s wanted the living . They went to see  Solomon. One  said, "She rolled on her  and it d. The living  is mine." "No! The living  is mine," the other  said.  Solomon got a . "Cut the  in ,

he said. "Give each   a .

The real  did not want her  to . "Give the  to her," she said. Then  Solomon knew who the real  was. He gave the  to the real .

# WISE KING SOLOMON

God made King Solomon wiser than anyone who ever lived. He ruled God's people for 40 years and wrote down hundreds of wise sayings, or proverbs.

**Match the letters with the numbers to find one of the proverbs written by King Solomon in Proverbs 17:22.**

1 3 8 5 5 18 6 21 12 8 5 1 18 20 9 19 7 15 15 4

13 5 4 9 3 9 14 5 2 21 20 1 3 18 21 19 8 5 4

19 16 9 18 9 20 4 18 9 5 19 21 16 20 8 5 2 15 14 5 19

A	B	C	D	E	F	G	H	I	J	K	L	M
1	2	3	4	5	6	7	8	9	10	11	12	13

N	O	P	Q	R	S	T	U	V	W	X	Y	Z
14	15	16	17	18	19	20	21	22	23	24	25	26

# Solomon's Wisdom

Unscramble each of the clue words.  
Copy the letters in the numbered cells to other cells with the same number.

HATRE

LOEV

HIESRC   
6 8

MDREA   
4

HOONR   
3

GINK   
1 5

TYPGE

DOG

DOMSIW   
2 7

1 2 3 4 5 6 7 8



# 90. THE WISDOM OF SOLOMON

(1 KINGS 3:16-28; 4:21-34)

Q L M S B R E V O R P P S W I G P R L Y  
F Q G I V Q O N C N H H Q G S R A E D B  
D K E F M J N Y P Y O B U G S R D B K P  
N E W L Y O V D L U H S N G X I U I G B  
G K K G M X L H R K O O Z V V K Y D C N  
V H R O A B C I Z S S P F I W U E A B Y  
G Y L H T R I B P S F P D B J P D M B Q  
K O G X J H E I C V B Y L I V I N G V Q  
S X U Y R Z G A O Y X J N I F S K D K F  
Z J J V O S V L M Z Z V M F D Q J I G E  
D V A Z W Y T N P N G T F X K I Y R V Z  
I I H O M Q Y F A O F C I L G V E G E H  
Y E R Y Q P E R S W N V E Y A Y Z D A F  
N D P M D V R D S K C S V E Z E W K B M  
A A R O T M B K I I N H M Q I Z I F Y C  
P A M T O V W S O Z Z D N T N N S Q Z G  
N Q A H U O I F N A A L I X T E D N R J  
A X U E C T B X D A K H M B S M O I Q O  
W P L R H J U Y H W I Z J K Y O M G V X  
Q F M U E Z W D M C L E C S T W Y J E F

BIRTH  
COMPASSION  
DIED  
DIVIDE  
LIVING

MOTHER  
PROVERBS  
SOLOMON  
SONGS

SON  
SWORD  
WISDOM  
WOMEN

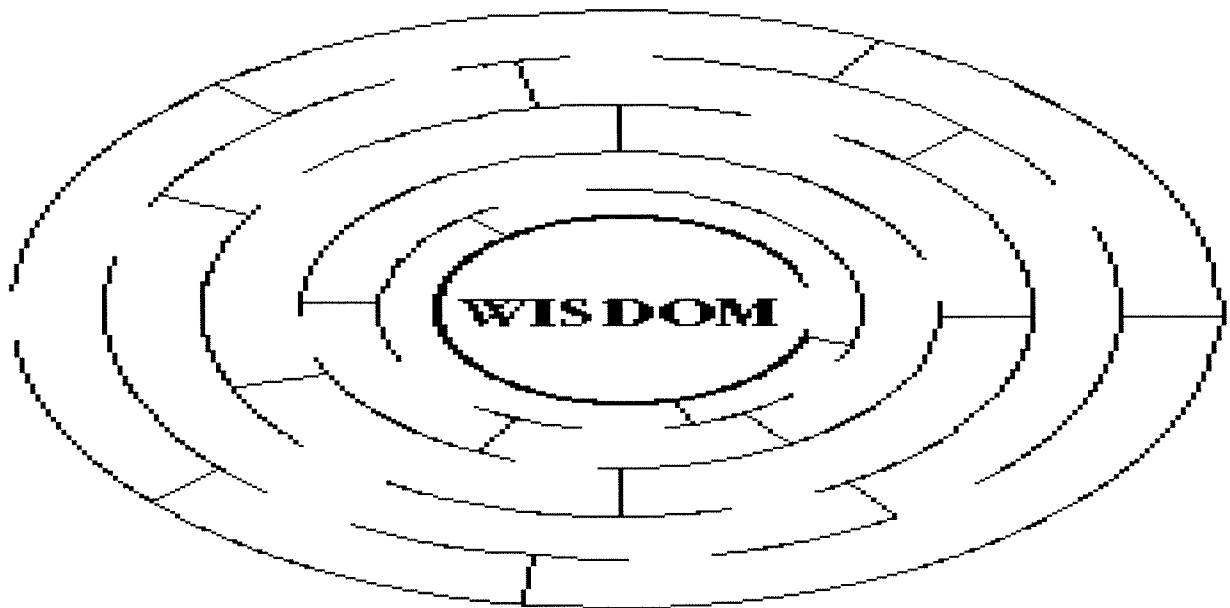

Name: \_\_\_\_\_

Date: \_\_\_\_\_

## Solomon Asks for Wisdom

Before \_\_\_\_\_ died, he chose \_\_\_\_\_, his son, to be the next king. Not long after Solomon became king, God appeared to him in a \_\_\_\_\_, inviting him to ask for whatever he wanted. Solomon was still young and knew that he would need God's help to rule over the nation of \_\_\_\_\_. He could have asked for wealth, long life, power, or victory over his enemies, but instead he asked for \_\_\_\_\_ so he could \_\_\_\_\_ between good and \_\_\_\_\_ and judge God's people wisely.

God was \_\_\_\_\_ with Solomon's unselfish request so he gave him great wisdom. But he also gave him \_\_\_\_\_ and \_\_\_\_\_. He said to him, Behold, I have given you a wise and understanding heart; so that there has been no one like you before you, and after you none will arise like you. I have also given you that which you have not asked, both riches and honor, so that there will not be any among the kings like you for all your days. If you will walk in my ways, to keep my statutes and my \_\_\_\_\_, as your father David walked, then I will \_\_\_\_\_ your days.

1. commandments

4. dream

7. Israel

10. Solomon

2. David

5. evil

8. lengthen

11. wealth

3. discern

6. fame

9. pleased

12. wisdom



Name: \_\_\_\_\_

Date: \_\_\_\_\_

## Solomon Asks for Wisdom



sweetpublishing.com (CC BY-SA 3.0)

e	v	i	l	r	e	k	h	q	p	s	i
i	t	l	q	t	r	x	g	n	l	o	s
w	l	o	n	g	l	i	f	e	e	l	r
e	r	s	f	d	r	e	a	m	a	o	a
a	g	w	d	a	i	g	u	v	s	m	e
l	o	l	p	a	m	y	c	x	e	o	l
t	o	n	k	l	v	e	k	m	d	n	f
h	d	i	m	u	d	i	s	c	e	r	n
w	i	s	d	o	m	i	d	h	p	k	m
c	o	m	m	a	n	d	m	e	n	t	s

1. commandments

2. David

3. discern

4. dream

5. evil

6. good

7. fame

8. Israel

9. long life

10. pleased

11. Solomon

12. wealth

13. wisdom

# King Solomon's Prayer

Study the passage in I Kings 3: 5-15 about King Solomon's dream and God's response. Then fill in the blanks of God's response to King Solomon below.

And God said unto him, Because thou hast not asked for this thing, and hast not asked for thyself \_\_\_\_\_; neither hast asked \_\_\_\_\_ for thyself, nor hast asked the life of thine \_\_\_\_\_; but hast asked for thyself \_\_\_\_\_ to discern judgment;

Behold, I have done according to thy words: lo, I have given thee a \_\_\_\_\_ and understanding \_\_\_\_\_; so that there was none like thee before thee, neither after thee.

And I have also given thee that which thou hast \_\_\_\_\_ asked, both \_\_\_\_\_, and \_\_\_\_\_: so that there shall not be any among the kings like unto thee all the days.

And if thou wilt \_\_\_\_\_ in my ways, to keep my

\_\_\_\_\_ and my \_\_\_\_\_ commandments, as thy father \_\_\_\_\_ did walk,

then I will

thy \_\_\_\_\_.



"In that night did God appear to Solomon (in a dream) and said unto him, 'ASK what I shall give you.'"

2 chronicles 1:7



God was pleased with this request

RICHES

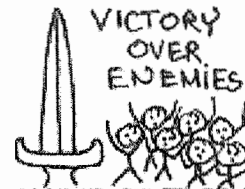
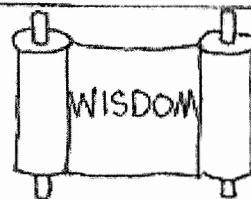

WHAT DID SOLOMON CHOOSE?

"In that night did God appear to Solomon (in a dream) and said unto him, 'ASK what I shall give you.'"

2 chronicles 1:7



God was pleased with this request

RICHES

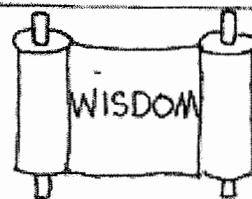

WHAT DID SOLOMON CHOOSE?

## Year 2

### Week 83

### Solomon's Great Kingdom

**Scriptures: 1 Kings 4, (20 – 34 particularly explains magnitude of Solomon's kingdom), 1 Kings 10**

**Key Verse: 1 Kings 10:23 “So King Solomon surpassed all the kings of the earth in riches and wisdom.”**

#### **Key Points:**

1. King Solomon was king over all Israel. He had many officials who served him. This included 12 governors who presided over the 12 districts in Israel. Each district provided food for the king and his household for one month out of the year. They also collected taxes and helped with building projects throughout their districts.
2. Solomon reigned over a very large area and over many people. Judah and Israel (vs.20) were as numerous as the sand by the sea. It took a large amount of provisions to keep the kingdom going. (you can discuss what those provisions and possessions were to show his greatness) They lived there happily, in safety and peace.
3. The Queen of Sheba heard of the fame of Solomon. She came with a great company of camels, carrying large amounts of gold, spices and precious stones. She asked him many hard questions, but nothing was too difficult for Solomon and his wisdom. The queen was very impressed with Solomon and his kingdom and gave him many gifts (list these) including ships that brought wood and gold from Ophir that Solomon used in building his house for God (in next weeks story).
4. Solomon also wrote many proverbs and songs. All the nations came to hear Solomon and his wisdom. God gave Solomon wisdom and greatness of heart that surpassed all others in that time.

**ACTIVITY:** "The Peaceful Times Of Solomon's Reign" Book

Materials needed: five sheets of 9" x 12" construction paper--orange, green, red, purple, and yellow--for each student, stapler, staples, marker, crayons, scissors.

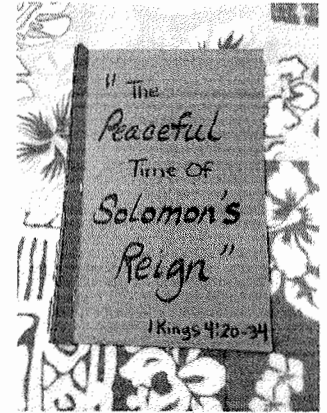

1. Hand out five sheets of different colored construction paper to each student.
2. Cut all papers in half.
3. Stack ten papers.
4. Staple 'book' three times on edge of book.
5. On cover, write "The Peaceful Tim Of Solomon's reign" and "1 Kings 4:20-34."
6. Open to next page, write "There was food." at the top of the paper.
7. Open to next page, write "It was a huge kingdom." at the top of the paper.
8. Open to next page, write "There were no battles or wars." at the top of the paper.
9. Open to next page, write "Solomon was rich." at the top of the page.
10. Open to next page, write "Even the horses and camels had food." at the top of the page.
11. Open to next page, write "Solomon was the wisest man." at the top of the page.
12. Open to next page, write "Solomon had honor and respect." at the top of the page.
13. Open to next page, write "He spoke 3,000 proverbs and 1,005 songs." at the top of the page.
14. Open to next page, write "God blessed Solomon." at the top of the paper and "Solomon obeyed God" at the bottom of the paper.
15. After writing the words, the students may go back and draw simple pictures depicting the words at the top of each page.
16. This should be a nice book for the students to take home and read.

# THE RICHEST MAN IN THE WORLD

2 Chronicles 9:13-27

Connect the dots to finish the picture.

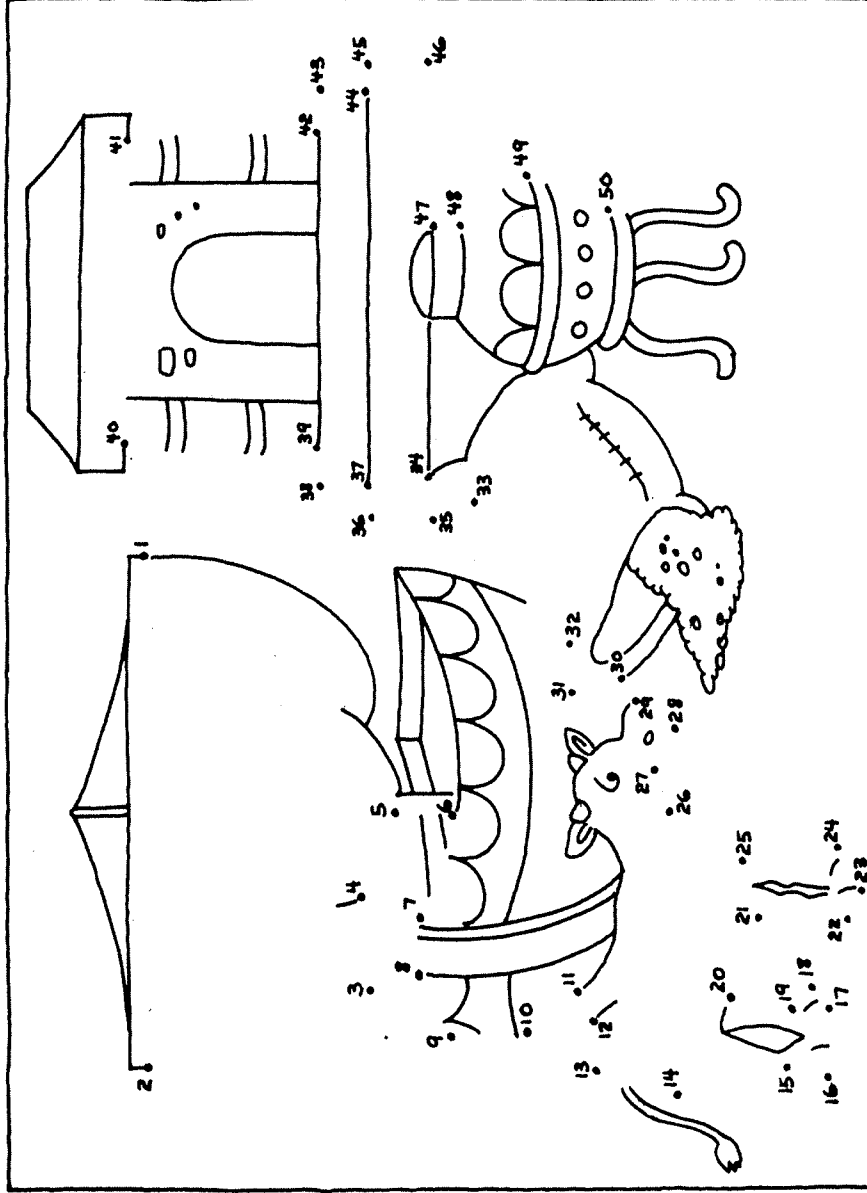

When God said Solomon could have anything he asked for, Solomon asked for wisdom instead of wealth or fame. God was so pleased with Solomon's response that he gave him great riches, too. Solomon was the richest man in the world.

# QUEEN OF SHEBA ☆ ELEMENTARY ACTIVITY

The queen of Sheba visited Solomon to see if he was as wise as people had told her. She brought him gold, precious stones, and spices. After she tested him with many questions she said, "Indeed, not even half the greatness of your wisdom was told me; you have far exceeded the report I heard. . . . Praise be to the LORD your God" (2 Chronicles 9:6-8).

See how many words you can find in the letters below. Go from left to right. The first one is done for you.

Shebagoldrichestonestespiceswisecamel

- |              |           |
|--------------|-----------|
| 1. She _____ | 14. _____ |
| 2. _____     | 15. _____ |
| 3. _____     | 16. _____ |
| 4. _____     | 17. _____ |
| 5. _____     | 18. _____ |
| 6. _____     | 19. _____ |
| 7. _____     | 20. _____ |
| 8. _____     | 21. _____ |
| 9. _____     | 22. _____ |
| 10. _____    | 23. _____ |
| 11. _____    | 24. _____ |
| 12. _____    | 25. _____ |
| 13. _____    | 26. _____ |
|              | 27. _____ |
|              | 28. _____ |
|              | 29. _____ |
|              | 30. _____ |

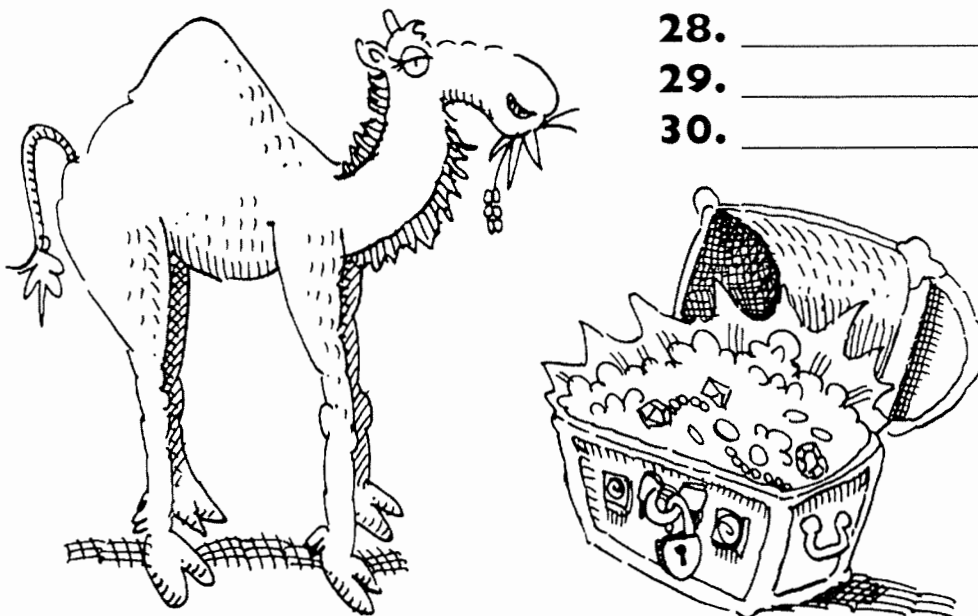



# Solomon's Greatness

Using the numbers indicated by the clues, work the puzzle to find out how many years King Solomon reigned. All the answers are found in the story of Solomon in 1 Kings in the Old Testament. The specific chapter and verse for each answer appears in ( ) at the end of each clue. You may need your calculator for this one!

The number of Egyptian chariots Solomon bought  
(10:26)

\_\_\_\_\_

Divided by ...

The number of wives Solomon had (11:3)

÷

\_\_\_\_\_

Multiplied by ...

The number of years it took to build the Lord's  
temple (6:38)

X

\_\_\_\_\_

Plus ...

The number of talents of gold that came to  
Solomon yearly (10:14)

+

\_\_\_\_\_

Minus ...

The number of years after the children of Israel  
left Egypt before Solomon began building the  
temple (6:1)

-

\_\_\_\_\_

Minus ...

The number of talents of gold that the Queen of  
Sheba gave Solomon for a gift (10:10)

-

\_\_\_\_\_

Divided by ...

The number of olive wood cherubim in the  
temple's inner sanctuary (6:23)

÷

\_\_\_\_\_

Equals ...

The number of years that Solomon reigned  
as king (11:42)

=

\_\_\_\_\_

*See answer on puzzle answer page 5.*



## Solomon's Greatness Key

1400

+ 700

x 7

+ 666

- 480

- 120

+ 2

= 40

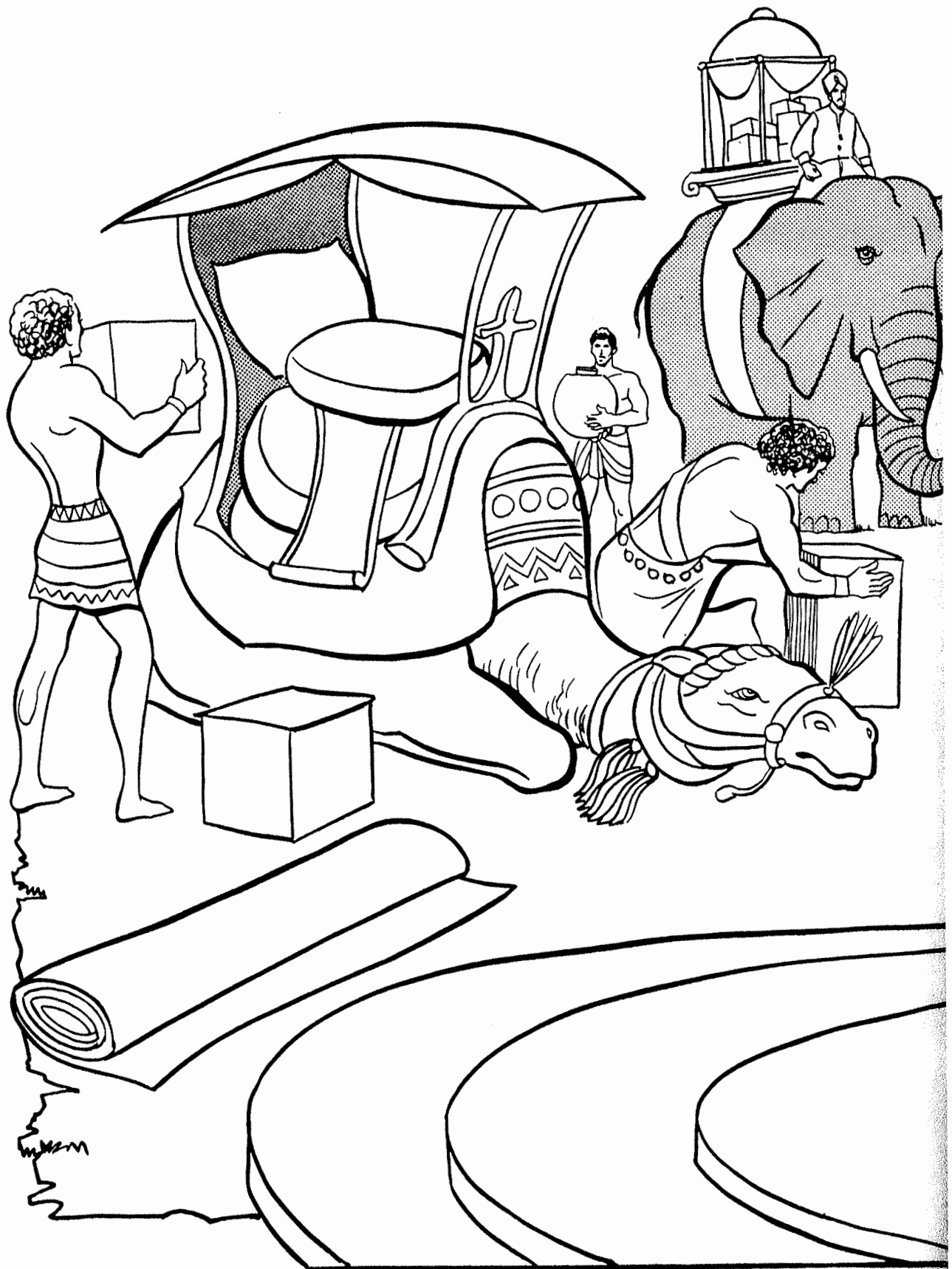

Stories of King Solomon's wisdom traveled far and wide. Queen of Sheeba, upon hearing these tales, came to . . .



... Jerusalem to test King Solomon's wisdom. What she heard with her own ears proved that King Solomon was truly wise.

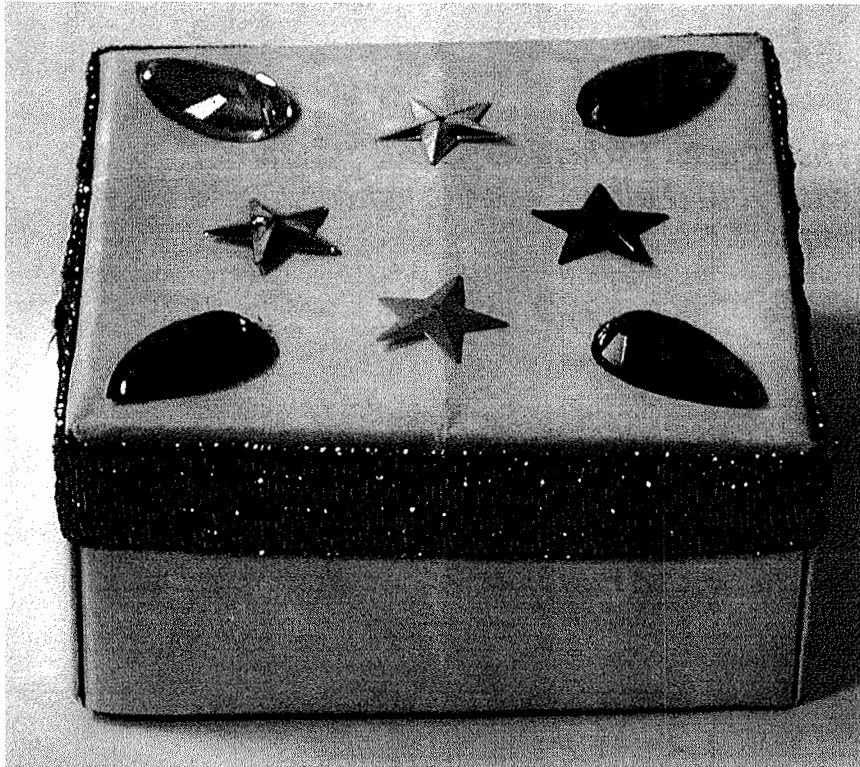

Make a small box to hold some of your treasures. You can decorate it with jewels, glitter glue, braid, or ribbon.

To make your box, you need two squares of paper, one  $\frac{1}{4}$  inch smaller on two sides than the other. The smaller box will be the bottom and the larger one the top. Fold one corner of the paper over to the opposite corner to form a triangle (make a sharp crease). Unfold and do the same with the other two corners. Now fold all four corners to the center. Then, with corners folded, fold the sides to the center crease. Unfold and do the same with the other two sides. Unfold and pull two flaps out. You'll now have a shape like figure 1.

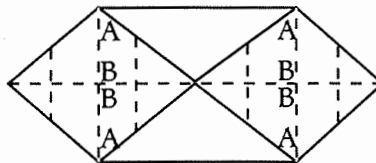
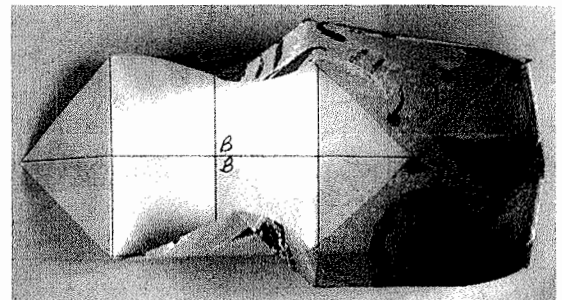

figure 1

Fold the two long edges up so they are perpendicular to the bottom. Then fold A to B on both sides as shown, and fold the flap over these folds into the box. Do the same with the other end.

**MATERIALS**

- 2 squares of paper, one  $\frac{1}{4}$  inch smaller on two sides than the other
- braid or ribbon
- Tacky glue
- jewels



## Year 2

### Week 84

### Solomon Builds the Temple

**Scriptures: 1 Kings 5 - 9**

**Key Verse: 1 Kings 6:13** “And I will dwell among the children of Israel and will not forsake My people Israel.”

#### **Key Points:**

1. Solomon’s father, David, desired in his heart to build a house for God, but was denied by God because of all the bloodshed during his kingship. God, however, promised that his son would build the temple.

2. Solomon began the work on the temple in the fourth year of his reign. During David’s reign, he had begun to set up men in the kingdom that would be able to help Solomon build the temple. In all there were 30,000 laborers who worked on the temple. They also built a royal house for Solomon, his household and royal court. It was also quite beautiful.

3. It took 7 ½ years to build the temple. It was built with many beautiful materials, including cedar logs and cypress from Lebanon, stones, gems, precious stones, gold (As time permits, discuss the many attributes of materials, size, furnishings and design of the temple and the royal court.) It was completely covered on the inside with pure gold.

4. Once the temple was built, Solomon ordered the priests to bring up the tabernacle and the Ark of the Covenant and all the holy furnishings to the temple. They put the ark in the most holy place and the glory of the Lord filled the temple. God promised he would reside there as long as Solomon walked with God and followed his statutes. The temple would be a holy, reverent place where his people would come and worship.

# MAZE

ur way down from the temple Solomon built.

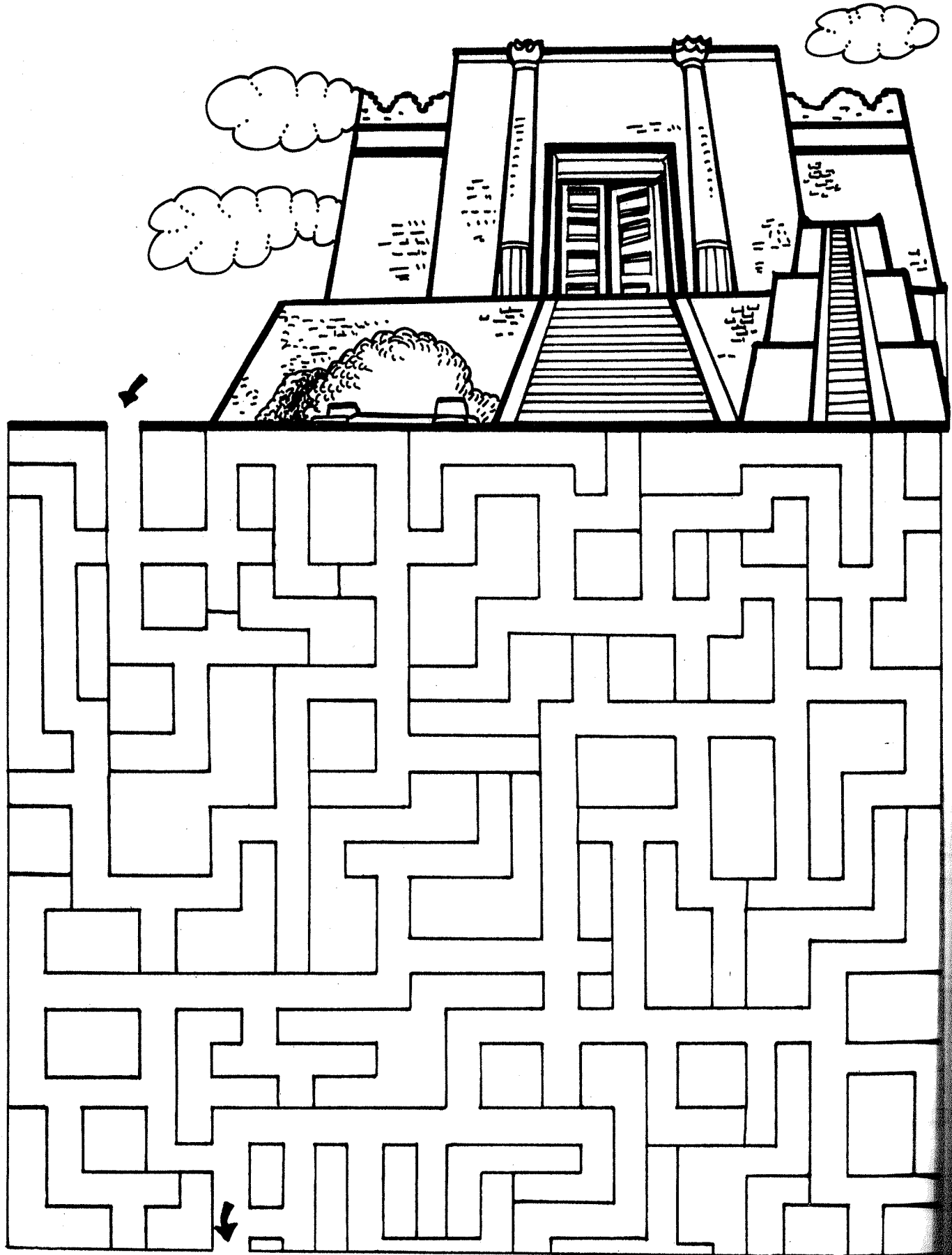

Hidden in the picture are some shapes Solomon used to decorate the temple. Find these shapes: lily, gourd, lion, bull, cherubim, and palm tree.



King Solomon built a great temple. After seven years of hard work, the temple was finished. 1 Kings 6:1, 37-38; 8:63

# GOD'S TEMPLE IS BUILT

1 Kings 5-8

Look at these two pictures. There are 5 things different in the second picture. Circle the differences.

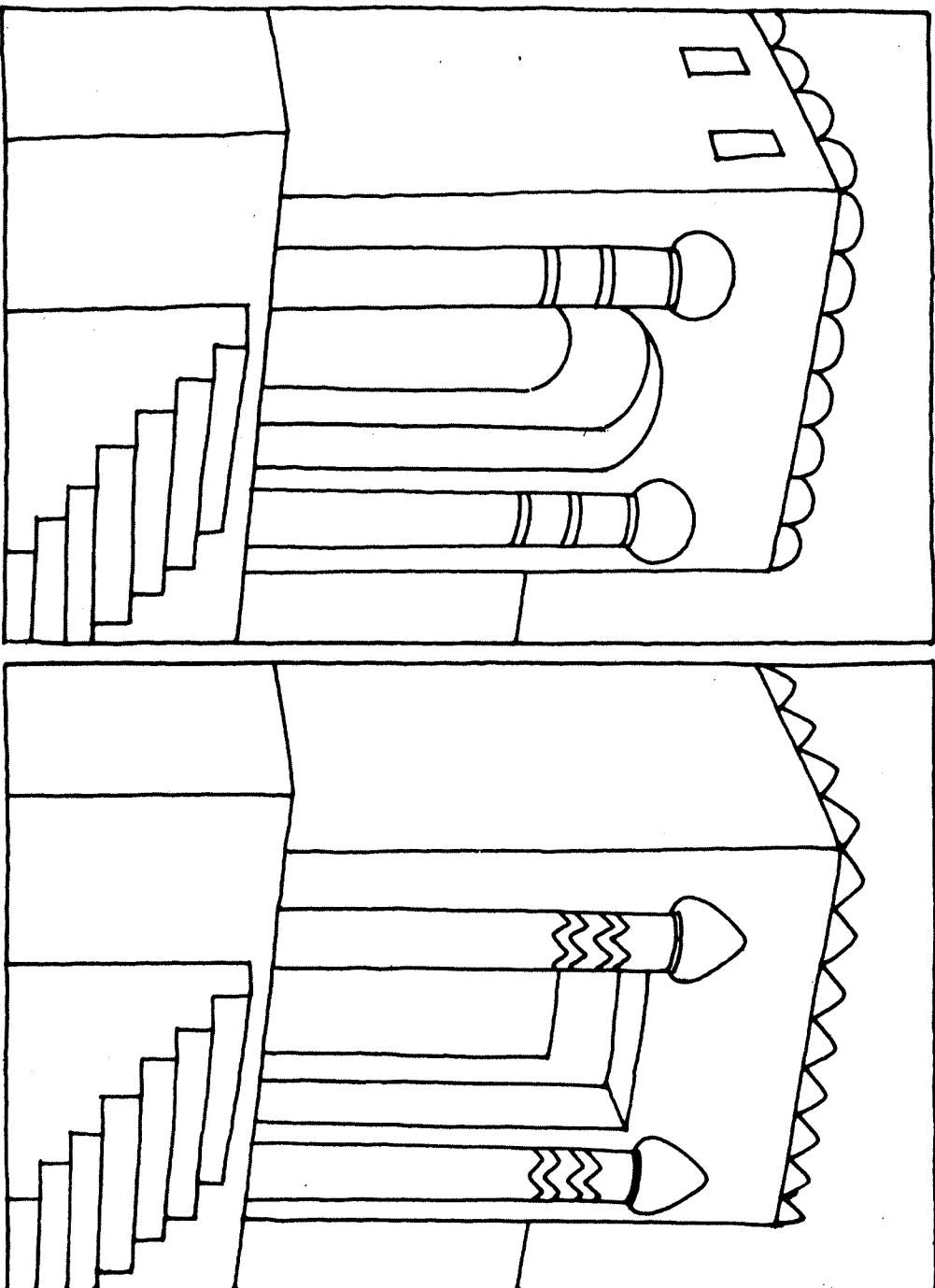

Before he died King David collected many of the materials needed to build the temple. But God wanted Solomon to finish the project his father had started.



# ☀ Temple Bird House ☀



## Memory Verse

Now my eyes will be open and my ears attentive to the prayers offered in this place. I have chosen and consecrated this temple so that my Name may be there forever.

~ 2 Chronicles 7:15-16

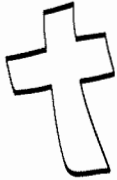

## Bible Truth

God loves to hear my prayers.



## Bible Story

God's temple is dedicated.  
(2 Chronicles 7:1-18)

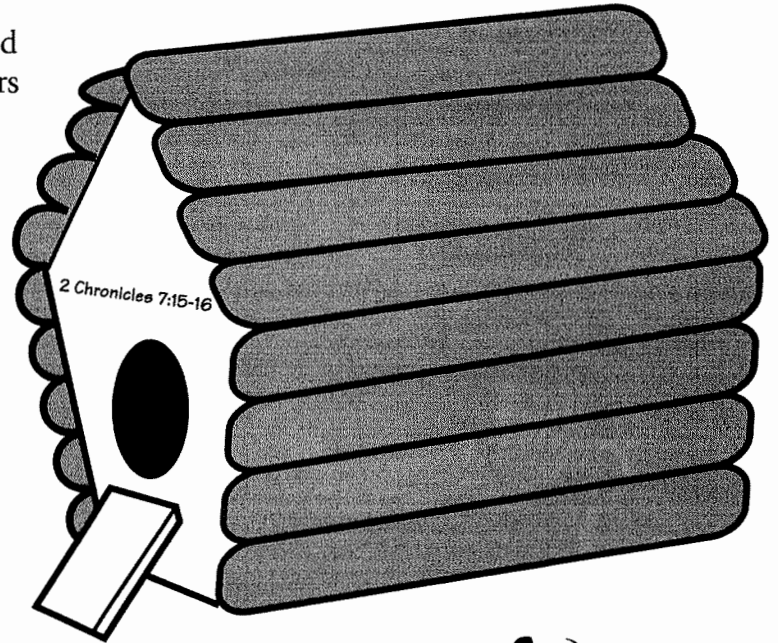

## What You Need



- \* page 40
- \* card stock
- \* thick craft foam
- \* scissors
- \* cool glue guns
- \* jumbo craft sticks
- \* pencils
- \* permanent markers

## Before class



Duplicate a pattern page to card stock for each child. Foam sheets about ½-inch thick can be substituted for craft foam.

## What to Do



1. Give each child a pattern page.
2. Tell the story of the dedication of the temple, from 2 Chronicles 7:1-18.
3. Say, **God wanted the temple to be a special place. When it was finished, He promised to be there, listening for prayers of the people. God loves to hear our prayers.**
4. Have the children cut out the pattern pieces.
5. Show how to trace two ends onto the craft foam and cut out those pieces.
6. Help the children construct the floor, sides and roof of the bird houses using jumbo craft sticks. For the floor of each birdhouse, have each child place three craft sticks side-by-side and stick a piece of tape across the sticks to hold them together. The children should repeat this process for two side parts (four sticks each) and two roof parts (four sticks each) for their houses. Then show how to attach the sections together with a glue gun.



*continued on next page...*

7. The students should use permanent markers to draw a cross on one end piece, and possibly a door and windows to look like a temple on the other.
8. Show how to use scissors to cut a two-inch hole in the opposite end of the bird house, and push a craft stick into the craft foam, leaving about 3 inches of stick outside the house.
9. Instruct the children to use permanent markers to write "2 Chronicles 7:15-16" above the hole in the end of their bird houses.

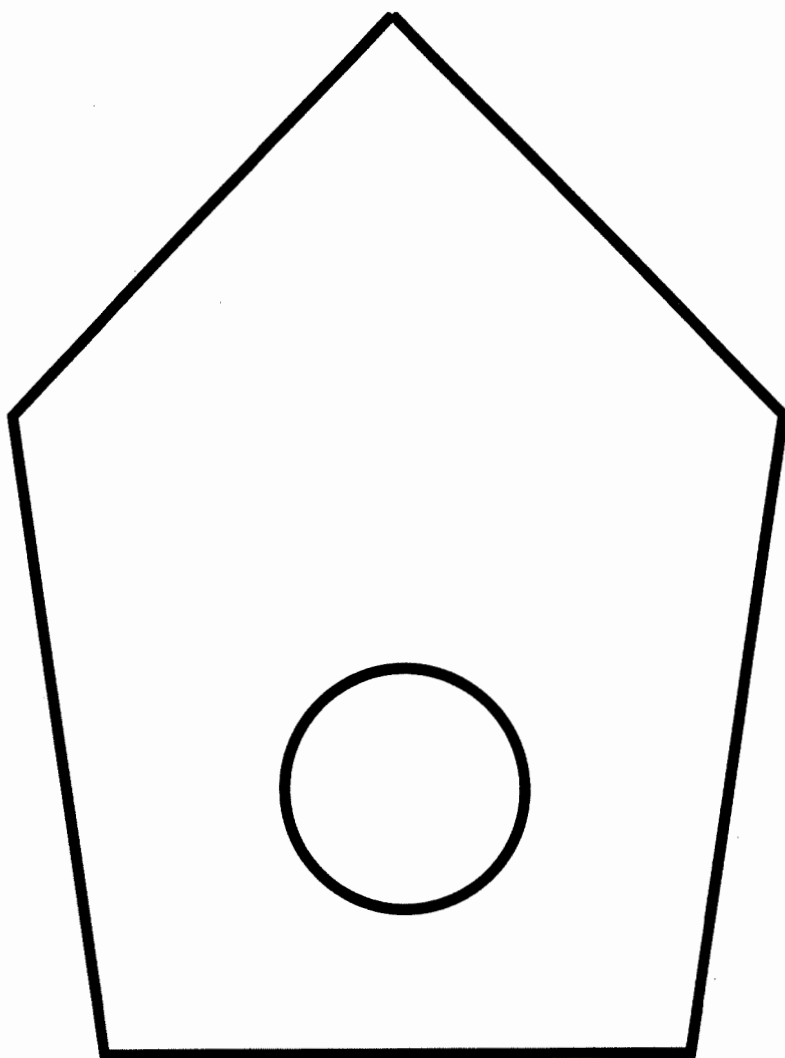

# TEMPLE MATERIALS

1 Kings 5-8

**Can you find the right river for these logs to go down in order to get to the temple?**

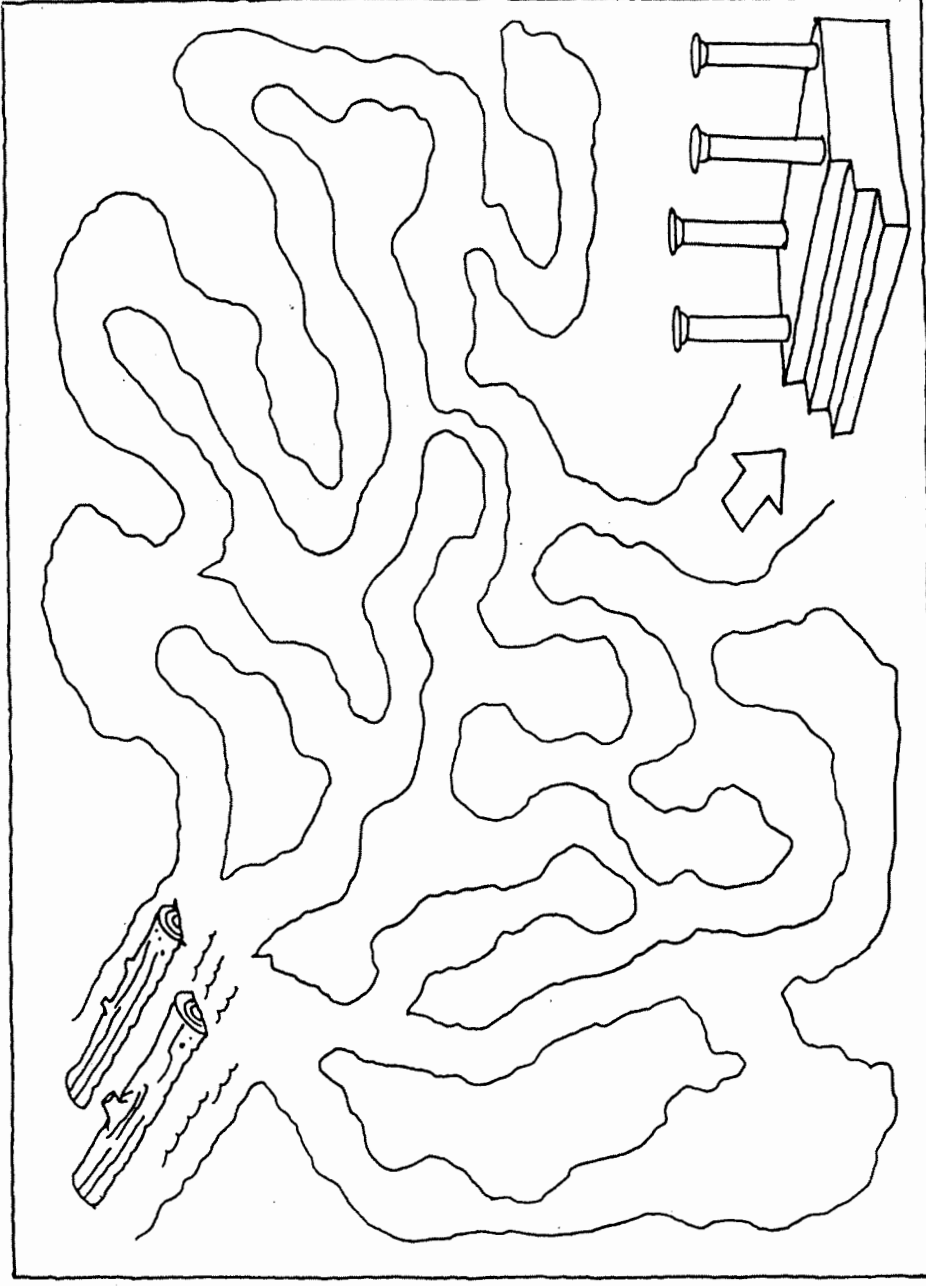

Solomon bought cedar trees from the King of Tyre to use in building the temple. The logs were floated to Israel and dragged cross country to Jerusalem. Then they were cut into beautiful wood panels.

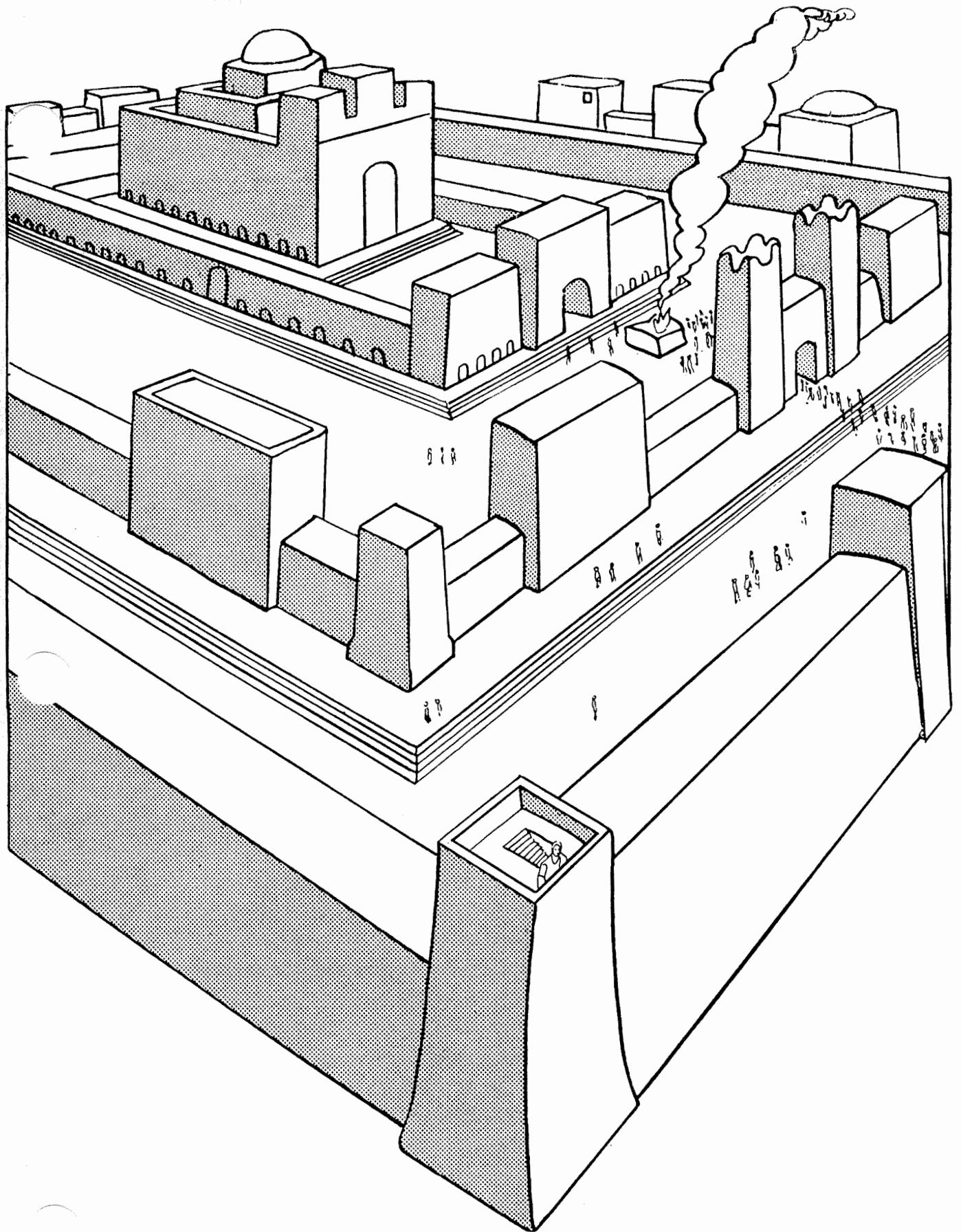

A great temple was built by King Solomon, where all people of the earth could come to worship and pray to God.

# SOLOMON BUILDS THE TEMPLE

## (1 KINGS 6:1-38)

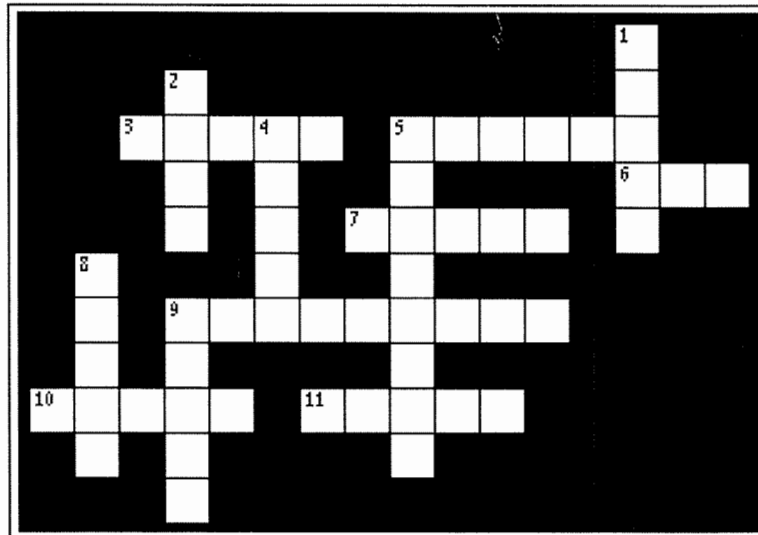

- 3 ACROSS "And it came to pass in the four hundred and eightieth year after the children of Israel had come out of the land of Egypt...that he began to build the \_\_\_\_\_ of the LORD." **1 KINGS 6:1**
- 7 ACROSS "No hammer or chisel or any iron tool was \_\_\_\_\_ in the temple while it was being built." **1 KINGS 6:7**
- 1 DOWN "He built the temple and finished it, and he paneled the temple with beam and boards of \_\_\_\_\_." **1 KINGS 6:9**
- 8 DOWN "And I will \_\_\_\_\_ among the children of Israel, and will not forsake My people Israel." **1 KINGS 6:13**
- 9 ACROSS "Then he built the twenty-cubit room at the rear of the temple, from floor to ceiling, with cedar boards; he built it inside as the inner \_\_\_\_\_, as the Most Holy Place." **1 KINGS 6:16**
- 6 ACROSS "And he prepared the inner sanctuary inside the temple, to set the \_\_\_\_\_ of the covenant of the LORD there." **1 KINGS 6:19**
- 2 DOWN "The whole temple he overlaid with \_\_\_\_\_, until he had finished all the temple." **1 KINGS 6:22**
- 5 DOWN "Inside the inner sanctuary he made two \_\_\_\_\_ of olive wood." **1 KINGS 6:23**
- 5 ACROSS "Then he \_\_\_\_\_ all the walls of the temple all around, both the inner and outer sanctuaries, with carved figures of cherubim, palm trees, and open flowers." **1 KINGS 6:29**
- 10 ACROSS "And the \_\_\_\_\_ of the temple he overlaid with gold, both the inner and outer sanctuaries." **1 KINGS 6:30**
- 11 ACROSS "For the entrance of the inner sanctuary he made doors of \_\_\_\_\_ wood." **1 KINGS 6:31**
- 9 DOWN "And he built the inner court with three rows of hewn \_\_\_\_\_ and a row of cedar beams." **1 KINGS 6:36**
- 4 DOWN "And Solomon was \_\_\_\_\_ years in building the temple." **1 KINGS 6:38**

# THE DEDICATION OF THE TEMPLE

## (1 KINGS 8:1-66)

### MEMORY VERSE:

*"There has not failed one word of all His good promise, which He promised through His servant Moses."* 1 KINGS 8:56

### FILL IN THE BLANK:

1. "Now Solomon assembled the elders of Israel and all the heads of the tribes, the chief fathers of the children of Israel, to King Solomon in Jerusalem, that they might bring up the \_\_\_\_\_ of the covenant of the LORD from the City of David, which is Zion." 1 KINGS 8:1

### UNDERLINE THE CORRECT ANSWER:

2. "And they brought up..." 1 KINGS 8:4
- |                              |                                                         |
|------------------------------|---------------------------------------------------------|
| a. the ark of the LORD       | c. all the holy furnishings that were in the tabernacle |
| b. the tabernacle of meeting | d. all of the above                                     |

### TRUE OR FALSE:

3. "The priests and the Levites brought them up." 1 KINGS 8:4  
TRUE OR FALSE
4. "Also King Solomon, and all the congregation of Israel who were assembled to him, were with him before the ark, sacrificing sheep and oxen that could not be counted or numbered for multitude." 1 KINGS 8:5  
TRUE OR FALSE

### FILL IN THE BLANKS:

5. "Then the priests brought in the ark of the covenant of the LORD to its place, into the inner sanctuary of the temple to the Most Holy Place, under the wings of the \_\_\_\_\_." 1 KINGS 8:6
6. "There was nothing in the ark except the two \_\_\_\_\_ of stone which Moses put there at Horeb, when the LORD made a covenant with the children of Israel, when he came out of the land of Egypt." 1 KINGS 8:9
7. "And it came to pass, when the priests came out of the holy place, that the \_\_\_\_\_ filled the house of the LORD." 1 KINGS 8:10
8. "And the king turned around and \_\_\_\_\_ the whole congregation of Israel, while all the congregation of Israel was standing." 1 KINGS 8:14

### TRUE OR FALSE:

9. "Then the king and all Israel with him offered sacrifices before the LORD." 1 KINGS 8:62  
TRUE OR FALSE

### FILL IN THE BLANKS:

10. "At that time Solomon held a \_\_\_\_\_, and all Israel with him, a great congregation from the entrance of Hamath to the Brook of Egypt, before the LORD our God, seven days and seven more days- fourteen days." 1 KINGS 8:65
11. "On the eighth day he sent the people away; and they blessed the king, and went to their tents joyful and glad of heart for all the \_\_\_\_\_ that the LORD had done for His servant David, and for Israel His people." 1 KINGS 8:66



# Build The Temple of God

Supplies You Will Need | 59 Craft Sticks | 1-2 Cans of Play-Doh | 1 Piece of Yellow Construction Paper | Ruler | Liquid Glue | Scissors

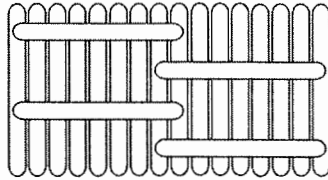

Line up 16 craft sticks.  
(Hint: Place a ruler at the bottom to keep them straight.)  
Glue 4 craft sticks in the opposite direction to hold them together.  
Repeat.  
**You just made the 2 long walls!**

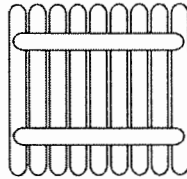

Line up 9 craft sticks.  
(Hint: Place a ruler at the bottom to keep them straight.)  
Glue 2 craft sticks in the opposite direction to hold them together.  
**Now you have the 1 short wall!**

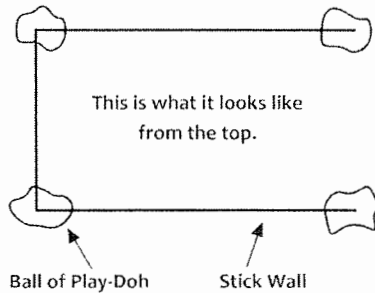

Place 4 small balls of Play-Doh on the table.  
Stick the bottom corners of the walls into the Play-Doh so they stand up. The 2 long walls should be across from each other with the 1 short wall connecting them.  
Connect the top corners with Play-Doh too.  
**The temple is standing!**

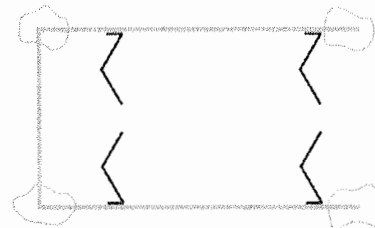
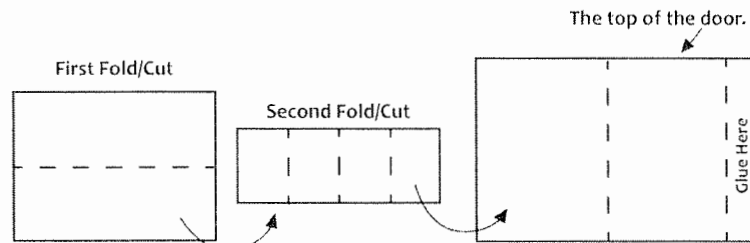

Fold the piece of construction paper in half lengthwise and cut on the fold.  
Then cut 1 of the pieces into 4 rectangles.  
On 1 of the rectangles, measure in 1/2 inch from the edge and fold the paper. Then fold the amount left over in half.  
Put glue on the 1/2 inch fold and use this part to attach the paper to the temple wall.  
Repeat this for the other 3 small rectangles.  
**Now you have 4 gold doors!**

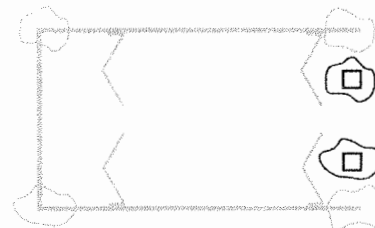

Place 2 small balls of Play-Doh on the table on the open end of the temple.  
Stick 4 craft sticks in each ball of Play-Doh to make a square.  
Connect the top of the sticks with Play-Doh too.  
**These are the temple columns!**

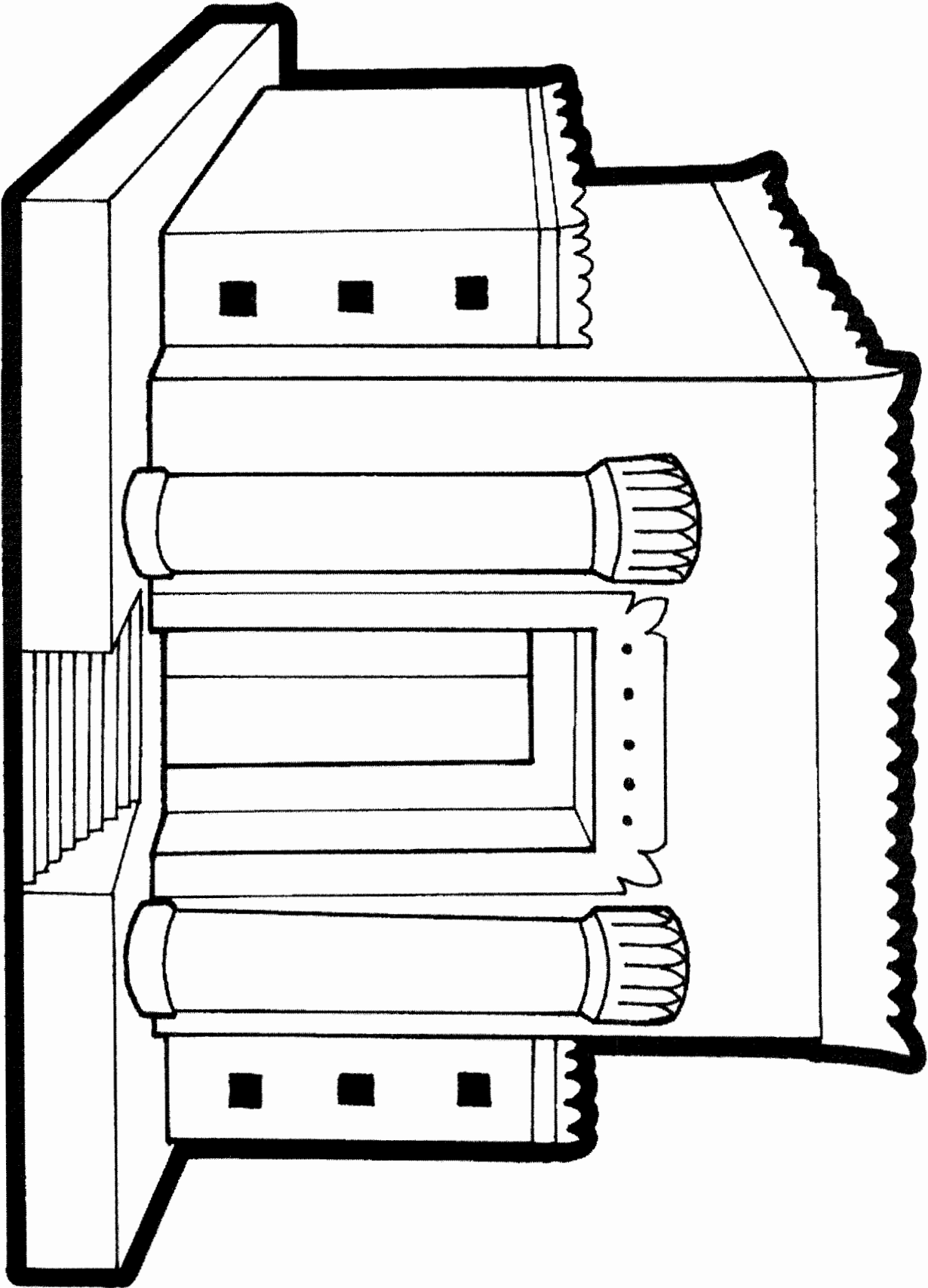



## Year 2

### Week 85

### Solomon Forgets God – The Kingdom Divides

**Scriptures: 1 Kings 11 and 12**

**Key Verse: 1 Kings 11:9 “So the Lord became angry with Solomon, because his heart had turned from the Lord God of Israel...”**

#### **Key Points:**

1. Solomon loved and married women who worshiped idols rather than God. God had given laws not to intermarry with those who were idolatrous. Solomon had 700 wives and princesses and 300 concubines. They turned his heart away from God and he did evil by worshiping idols.

2. The Lord became angry with him, told him Israel would rebel. He told him that all but one tribe would be taken from his son, Rehoboam, who would be king after him. He would retain these because of God’s love for his father David. 10 tribes would be under another king. God promised not to do this while Solomon lived, but after he died.

3. God instructed his prophet Ahijah to meet a mighty man of valor, Jeroboam, and show him that 10 tribes would be given to him as king. He showed this by taking fabric and tearing it into 10 pieces. Solomon wanted to kill Jeroboam because of this but he escaped to Egypt until Solomon died.

4. After the death of Solomon, Rehoboam ruled very harshly, thinking he would gain loyalty. It did not work and a rebellion took place. A battle had been planned against Jeroboam to restore the kingdom to Rehoboam. God sent Shemaiah, a prophet, to tell them not to fight. The kingdom would be divided, Judah and Benjamin remained with Rehoboam the rest with Jeroboam. Solomon reigned over Israel 40 years.

ISRAEL

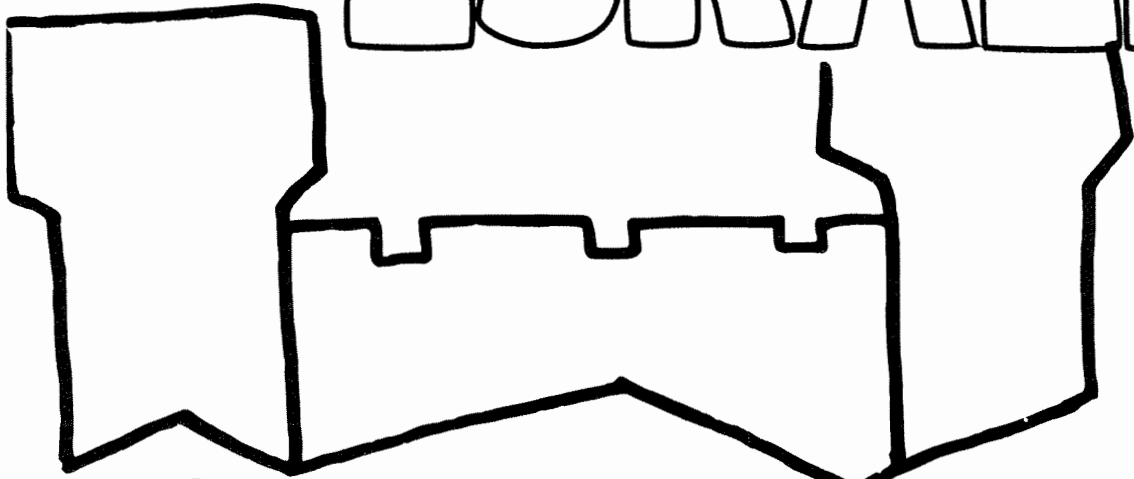

DIVIDED

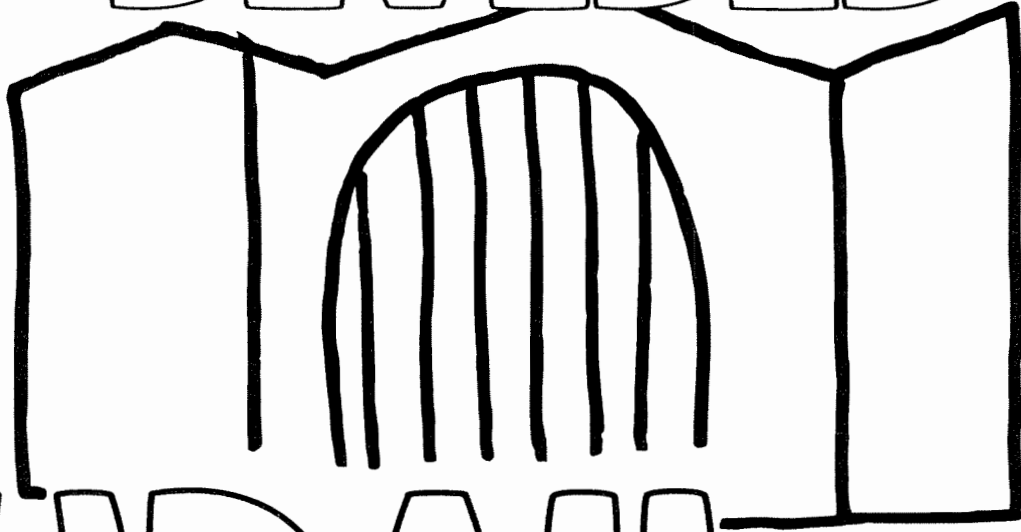

JUDAH

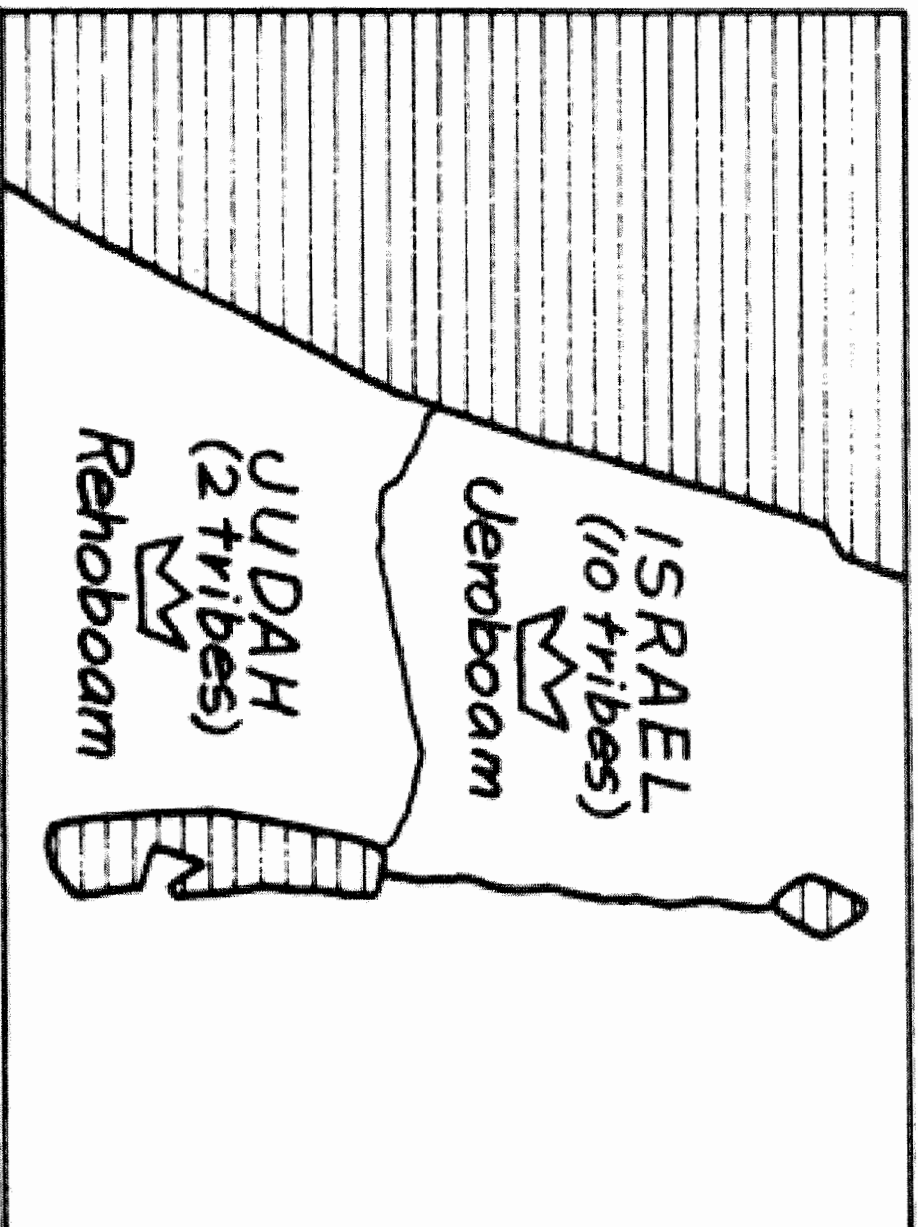

From *The Complete Bible Story Clip Art Book*. ©Gospel Light. Used by permission.

# SOLOMON'S SINS

2 KINGS 11

## ACROSS

- 1) KING OF EGYPT
- 2) FALSE GODS
- 3) SOLOMON MARRIED THE PHARAOH'S DAUGHTER WHO WAS FROM \_\_\_\_\_.

## DOWN

- 1) OPPOSITE OF RICH
- 4) EVIL, BAD
- 5) SOLOMON MADE LIFE \_\_\_\_\_ (DIFFICULT) FOR THE POOR PEOPLE. (RHYMES WITH "CARD")
- 6) PRECIOUS YELLOW METAL
- 7) OPPOSITE OF DOWN

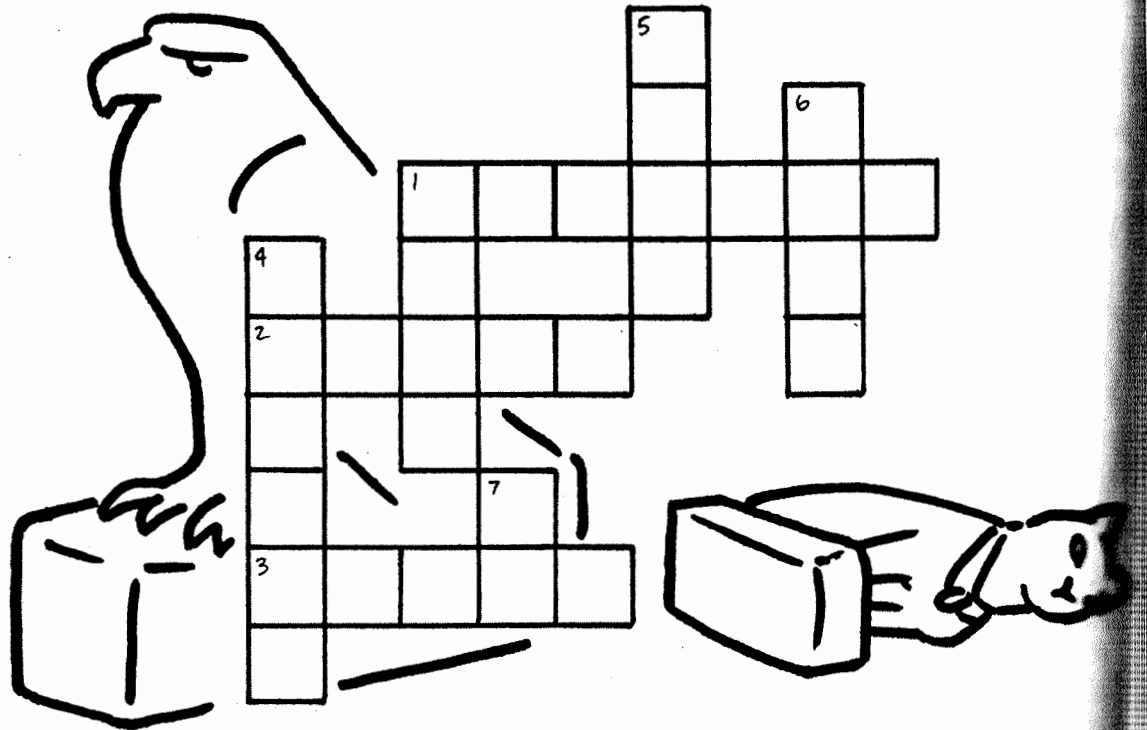

# SOLOMON TURNS FROM THE LORD

(1 KINGS 11:1-13, 41-43)

N E V S M R L O D Y S F E G Z  
W Z U C W E L O R D G O D O U  
Y C I I H P P K K L O I N W U  
Z L V N Y M E L A S U R E J I  
U E P P D C O V E N A N T J X  
S W E C S E V P A F E U A V Y  
G C B N Y T D Z G L Z H I R Q  
H A I C M V A N S K P I G H B  
Y Z R X B T G T A I E N P Y V  
I S T P U T Y S U M A P Q G B  
F D E R P O Q T A T M K F M W  
B G N R R J D V U Q E O R M Y  
L E O S O L O M O N U S C J U  
D P N E Y Q O G K S V R C V R  
A C T R A E H W S R A E T E Y

ANGRY  
COMMANDED  
COVENANT  
HEART

JERUSALEM  
LORD GOD  
ONE TRIBE  
SOLOMON

STATUTES  
TEAR  
TURNED  
WIVES

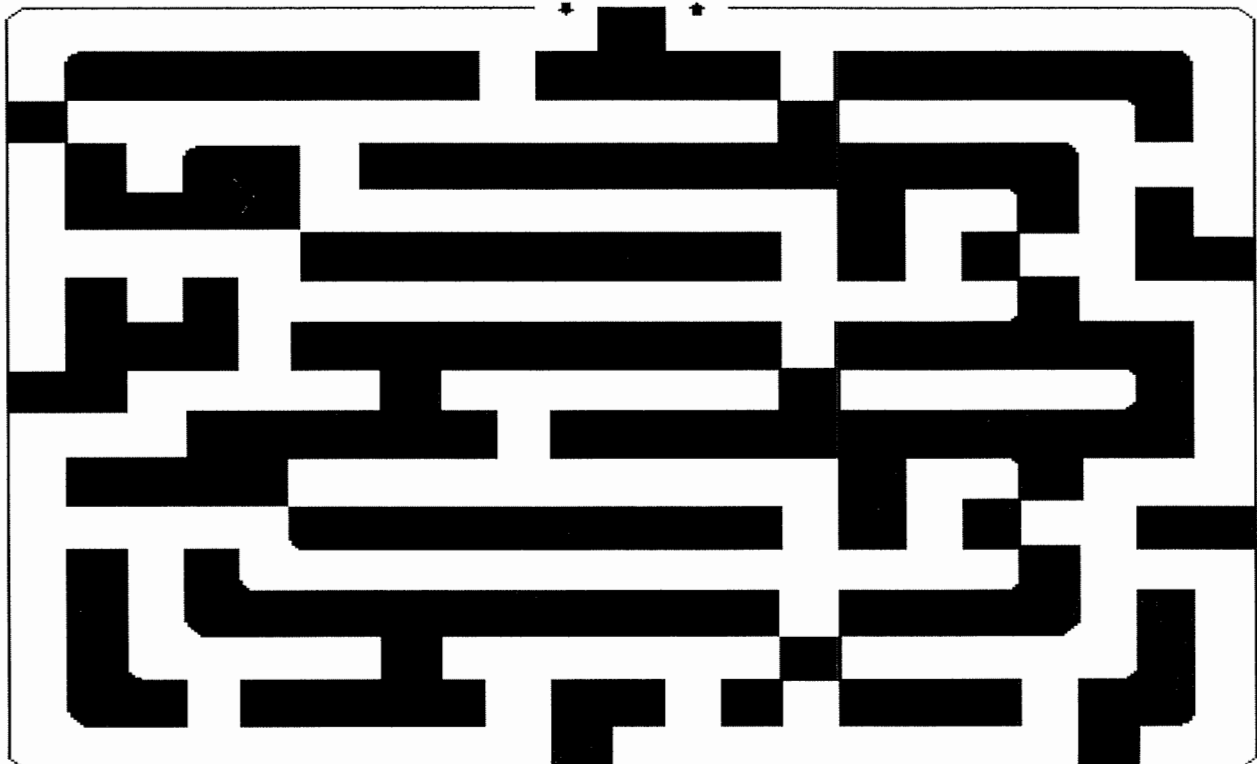

# SOLOMON TURNS FROM THE LORD

(1 KINGS 11:1-13, 41-43)

## MEMORY VERSE:

*"So the LORD became angry with Solomon, because his heart had turned from the LORD God of Israel."* 1 KINGS 11:9

## FILL IN THE BLANKS:

1. "For it was so, when Solomon was old, that his wives turned his \_\_\_\_\_ after other gods; and his \_\_\_\_\_ was not loyal to the LORD his God, as was the \_\_\_\_\_ of his father David." 1 KINGS 11:4

## TRUE OR FALSE:

2. "For Solomon went after Ashtoreth the goddess of the Sidonians, and after Milcom the abomination of the Ammonites." 1 KINGS 11:5  
TRUE OR FALSE
3. "Then Solomon built a high place for Chemosh the abomination of Moab, on the hill that east of Jerusalem, and for Molech the abomination of the people of Ammon." 1 KINGS 11:7  
TRUE OR FALSE

## FILL IN THE BLANKS:

4. "And he did likewise for \_\_\_\_\_ his \_\_\_\_\_, who burned incense and sacrificed to their gods." 1 KINGS 11:8
5. "So the LORD became \_\_\_\_\_ with Solomon, because his heart had turned from the LORD God of Israel, who had appeared to him twice." 1 KINGS 11:9
6. The LORD "had commanded him concerning this thing, that he \_\_\_\_\_ go after other gods; but he did not keep what the LORD had commanded." 1 KINGS 11:10

## TRUE OR FALSE:

7. "Therefore the LORD said to Solomon, 'Because you have done this, and have not kept My covenant and My statutes, which I have commanded you, I will surely tear the kingdom away from you and give it to your servant.' " 1 KINGS 11:11  
TRUE OR FALSE

## FILL IN THE BLANKS:

8. The LORD said, "However I will not tear away the whole kingdom, but I will give \_\_\_\_\_ to your son for the sake of My servant David, and for the sake of Jerusalem which I have chosen." 1 KINGS 11:13

# SOLOMON TURNS FROM THE LORD

(1 KINGS 11:1-13, 41-43)

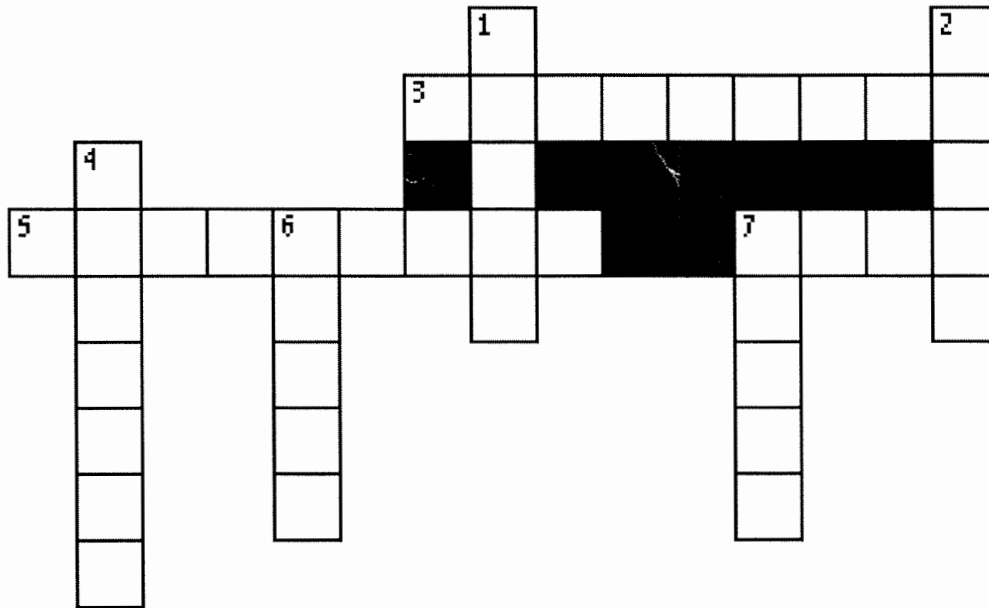

- 2 DOWN "For it was so, when Solomon was old, that his wives turned his \_\_\_\_\_ after other gods; and his heart was not loyal to the LORD his God, as was the heart of his father David." **1 KINGS 11:4**
- 4 DOWN "For \_\_\_\_\_ went after Ashtoreth the goddess of the Sidonians, and after Milcom the abomination of the Ammonites." **1 KINGS 11:5**
- 3 ACROSS "Then Solomon built a \_\_\_\_\_ \_\_\_\_\_ for Chemosh the abomination of Moab, on the hill that east of Jerusalem, and for Molech the abomination of the people of Ammon." **1 KINGS 11:7**
- 1 DOWN "And he did likewise for all his foreign \_\_\_\_\_, who burned incense and sacrificed to their gods." **1 KINGS 11:8**
- 6 DOWN "So the LORD became \_\_\_\_\_ with Solomon, because his heart had turned from the LORD God of Israel, who had appeared to him twice." **1 KINGS 11:9**
- 5 ACROSS "The LORD "had \_\_\_\_\_ him concerning this thing, that he should not go after other gods; but he did not keep what the LORD had commanded." **1 KINGS 11:10**
- 7 ACROSS "Therefore the LORD said to Solomon, 'Because you have done this, and have not kept My covenant and My statutes, which I have commanded you, I will surely \_\_\_\_\_ the kingdom away from you and give it to your servant.' " **1 KINGS 11:11**
- 7 DOWN "The LORD said, "However I will not tear away the whole kingdom, but I will give one \_\_\_\_\_ to your son for the sake of My servant David, and for the sake of Jerusalem which I have chosen." **1 KINGS 11:13**

# SOLOMON TURNS FROM THE LORD

(1 KINGS 11:1-13, 41-43)

D V H T N A N E V O C P S C K Y E F A Z  
 I I P V T D E N H S S P Q W D T D Q B H  
 Y E R M O M O F M Z E Y U E S G K N Y F  
 N A M Y U V R G Y N Z V N G I R J I Z M  
 A A A A C O B R D O Y R I G S R Y G R C  
 P Q U S N T W D U R U R Z W X K Z J Q G  
 N X L E B I R T K T O D G V W U Y L V J  
 A P M T E J I K J W G L E N J P R D E O  
 W F I U Q T B S E K F J F D A S B K Y D  
 Q M F T E Z U F R I X V N B N Q I G B F  
 L G L A J O W L U Z C T M I F A D C P O  
 Q E R T X V N Y S A X C F F M V M B B M  
 K W G S B L Y D A A Z V I L G Y A M N V  
 N O M O L O S C L W A S E L A E M B O E  
 E K X J H C D P E C W H V Y Z Z D V Y C  
 K R Y R Z E H L M H I D M E I P I K Q H  
 H G V O Y G I R S H L L N Q N A R G Q C  
 Y U Z M Q V I Z S O U H I T T R A E H K  
 X J Y Q P T A P V F H Z M M T U G V F Z  
 J A U D V Y L D Y B B E J B S Y K E E M

**ANGRY**  
**COMMANDED**  
**COVENANT**  
**HEART**

**JERUSALEM**  
**LORD GOD**  
**ONE TRIBE**  
**SOLOMON**

**STATUTES**  
**TEAR**  
**TURNED**  
**WIVES**

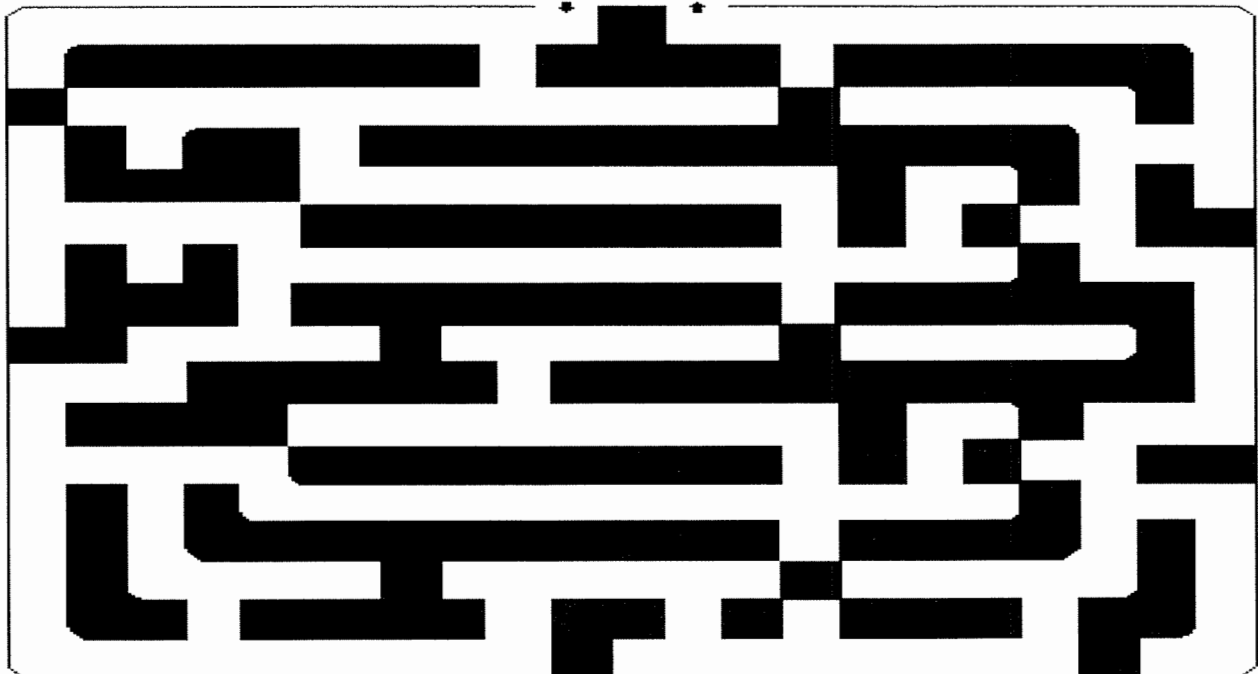



# THE KINGDOM IS DIVIDED

(1 KINGS 11:26-40; 12:1-24)

M O D G N I K R H D I G K O O N G T M I  
 C M M N D G N I H L P H E T T V K P H R  
 B S B Q D B E Y O O M G O C H G M M V O  
 B O A Q D L B R B F W N J U S R P S Y N  
 Y A K H V L D S R N L W S R K K E D X T  
 U L I V V N P S B T G B E V W Z I Q R V  
 W K Y Z D W U Y E M E D Z N W L P E L B  
 D N T U K Z U D A B L H N V S S H H M K  
 O M B D P S R O U E I W P M L O L E E C  
 K G Z F S V B Y S Q S R W O B I E N J E  
 J G B H H O J E L G Z B T O R O P P L U  
 Q T C G R M G B A R D V A E F P K T D Z  
 L E S E P R Z R Y E R M I F V V S D Z B  
 Z L J U U O M O D K O B I N R L E L P E  
 P S L O P E F I L D J C O O Q T E Z E Q  
 Q V C Q N N V J H F E H V X C V N W B A  
 L S S T R I J C D R L C M E C T U T T L  
 A P N J D G F V K H L O J M R L W T L B  
 L Z P V B I E G K L A E G G H C S O I F  
 L S M Q N C O W X D R Y D Q N M C S A H

ELDERS  
 GARMENT  
 JEROBOAM  
 KINGDOM

LORD  
 OFFICER  
 PROPHET  
 REHOBOAM

REJECTED  
 SCOURGES  
 TWELVE TRIBES  
 YOUNG MEN

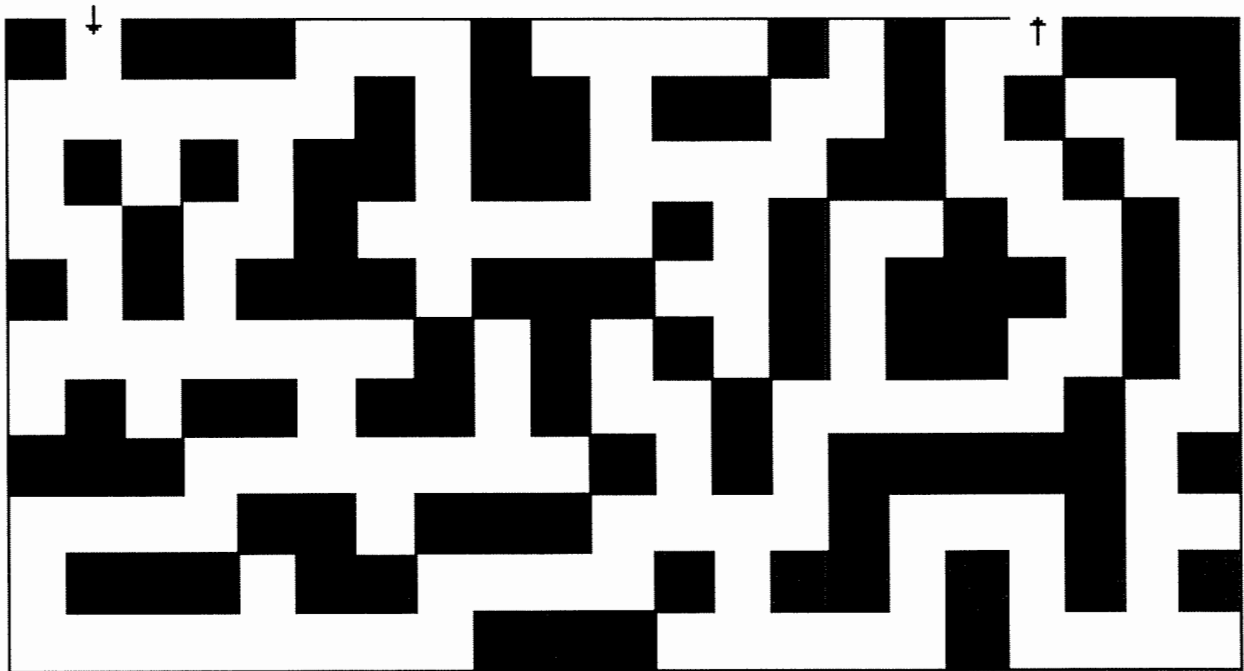

# THE KINGDOM IS DIVIDED

## (1 KINGS 11:26-40; 12:1-24)

### MEMORY VERSE:

"For the turn of affairs was from the LORD, that He might fulfill His word." 1 KINGS 12:15

### TRUE OR FALSE:

1. "Jeroboam was a mighty man of valor; and Solomon, seeing that the young man was industrious, made him the officer over all the labor force of the house of Joseph." 1 KINGS 11:28

TRUE OR FALSE

### CIRCLE THE CORRECT WORDS:

2. "Now it happened at that time, when Jeroboam went out of Jerusalem, that the (KING, PROPHET) Ahijah the Shilonite met him on the way; and he had clothed himself with a new garment, and the two were alone in the field." 1 KINGS 11:29
3. "Then Ahijah took hold of the new (GARMENT, CARPET) that was on him, and tore it into twelve pieces." 1 KINGS 11:30
4. "And he said to Jeroboam, 'Take for yourself (TWO, TEN) pieces, for thus says the LORD, the God of Israel: 'Behold, I will tear the kingdom out of the hand of Solomon and will give (TWO, TEN) tribes to you.' " 1 KINGS 11:31

### FILL IN THE BLANKS:

5. The LORD said, "I will take the kingdom out of his son's hand and give it to you- ten tribes. And to his son I will give one tribe, that My servant David may always have a \_\_\_\_\_ before Me in Jerusalem, the city which I have chosen for Myself, to put My name there." 1 KINGS 11:36
6. "Then it shall be, if you heed all that I command you, walk in \_\_\_\_\_ ways, and do what is right in \_\_\_\_\_ sight, to keep \_\_\_\_\_ statutes and \_\_\_\_\_ commandments, as \_\_\_\_\_ servant David did, then I will be with you and build for you an enduring house, as I built for David, and will give Israel to you." 1 KINGS 11:38

### TRUE OR FALSE:

7. "Now Rehoboam went to Shechem, for all Israel had gone to Shechem to make him king." 1 KINGS 12:1

TRUE OR FALSE

### CIRCLE THE CORRECT WORDS:

8. "Then Jeroboam and the whole congregation of Israel came and spoke to Rehoboam, saying, 'Your father made our (YOKE, JOKE) heavy; now therefore, lighten the burdensome service of your father, and his heavy (YOKE, JOKE) which he put on us, and we will serve you.' " 1 KINGS 12:3-4

### TRUE OR FALSE:

9. "King Rehoboam consulted the elders who stood before his father Solomon while he still lived." 1 KINGS 12:6

TRUE OR FALSE

10. And King Rehoboam accepted the counsel which the elders gave him. 1 KINGS 12:8

TRUE OR FALSE

### CIRCLE THE CORRECT WORD:

11. So Jeroboam and all the people came to Rehoboam "and he spoke to them according to the counsel of the young men, saying, 'My father made your yoke heavy, but I will add to your yoke; my father chastised you with whips, but I will chastise you with (SCOURGES, COURAGE)! " 1 KINGS 12:14

# THE BENEFITS OF WISDOM

## THE PROVERBS OF SOLOMON • CHAPTERS 2,3,4

### Across

3. Wisdom will save you from the ways of \_\_\_\_\_ men. v. 2:12
6. Wisdom will \_\_\_\_\_ you. v. 4:6
8. Wisdom is more precious than \_\_\_\_\_. v. 3:15
11. The paths of wisdom are \_\_\_\_\_. v. 3:17
12. The Lord disciplines those he \_\_\_\_\_. v. 3:12
14. The Lord gives \_\_\_\_\_. v. 2:6
15. Knowledge will be \_\_\_\_\_ to your soul. v. 2:10

### Down

1. \_\_\_\_\_ in the Lord with all your heart. v. 3:5
2. The fear of the Lord will bring \_\_\_\_\_ to your body. v. 3:8
4. Wisdom will \_\_\_\_\_ over you. v. 4:6
5. Do not \_\_\_\_\_ the Lord's discipline. v. 3:11
7. By wisdom the Lord laid the earth's \_\_\_\_\_. v. 3:19
9. Wisdom is \_\_\_\_\_. v. 4:7
10. Honor the Lord with your \_\_\_\_\_. v. 3:9
13. Keep the commandments of God in your \_\_\_\_\_. v. 3:1

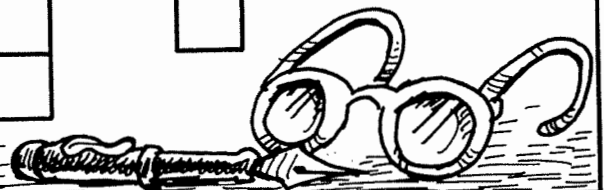
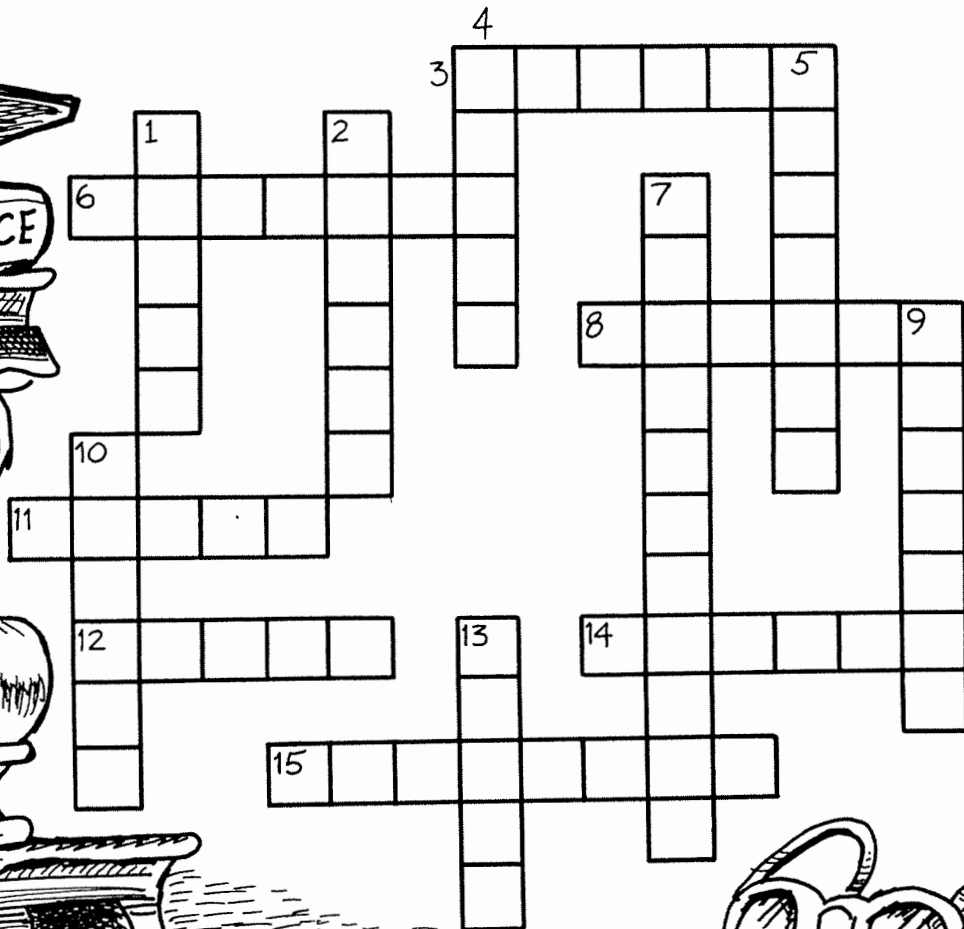
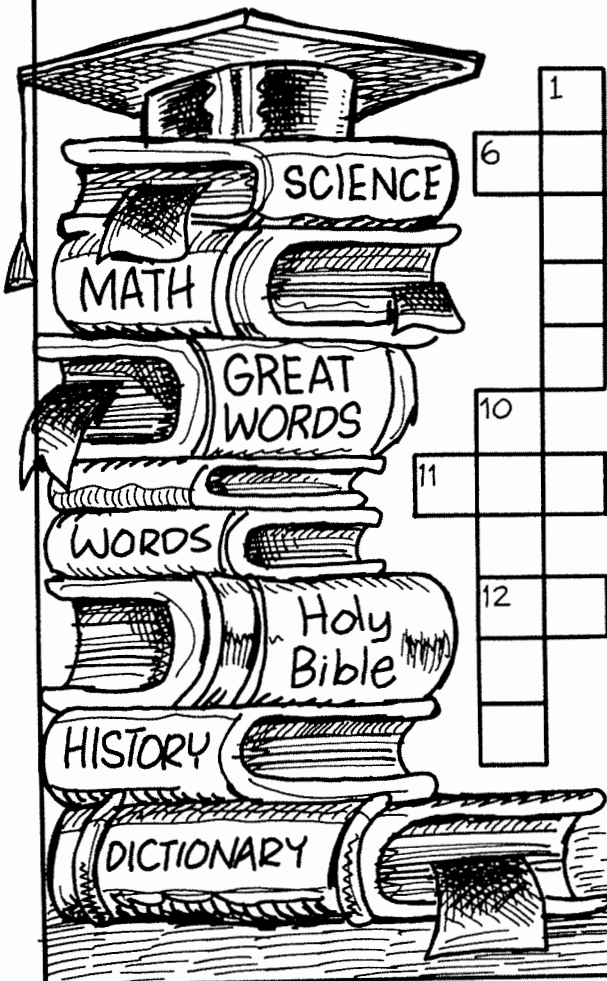

# Solomon

1. David promised Bathsheba that \_\_\_\_\_ would be the next king.
2. \_\_\_\_\_ tried to take the throne from Solomon.
3. Solomon was the \_\_\_\_\_ king of Israel.
4. Solomon asked God for \_\_\_\_\_ to judge the people.
5. Solomon built the \_\_\_\_\_ according to the plans given to him by David.
6. It took \_\_\_\_\_ years to build the Temple.
7. The Temple was \_\_\_\_\_ the size of the Tabernacle.
8. Solomon's kingdom was so wealthy that even his drinking cups were made of \_\_\_\_\_.
9. Solomon disobeyed God when he built \_\_\_\_\_ to his wives' false gods.
10. Because of Solomon's sin, the kingdom of Israel was \_\_\_\_\_ after Solomon died.

## REVIEWING THE KINGS GAME:

**Materials needed:** three paper or plastic cups, marker, 3" x 5" cards or paper cut to those dimensions

Take 3 plastic cups and write one king's name on each: Saul, David, Solomon

Write questions on 3x5 cards and have kids take turns putting the answer to the correct cup.

You may also have the kids work in teams to answer the question.

Older kids may incorporate verses and finding a verse to back up each question.

### Sample Questions:

1. Which king met the Queen of Sheba? (Solomon)
2. Which king was taller than everyone? (Saul)
3. Which king fought the Philistines all of his life? (Saul)
4. Which king played the harp? (David)
5. Which king had a good friend named Jonathan? (David)
6. Which king killed a giant? (David)
7. Which king built a temple for the LORD? (Solomon)
8. Which king had a peaceful kingdom? (Solomon)
9. Which king was kind to a past king's son who couldn't walk? (David)
10. Which king threw javelins? (Saul)
11. Which king spared King Saul's life? (David)
12. Which king spared King Agag and lost his own kingdom? (Saul)
13. Which king was jealous of David? (Saul)
14. Which king was the wisest king? (Solomon)
15. (Trick question because there are two answers!) Which king was anointed by Samuel? (Saul and David)
16. Feel free to add many more!

## Year 2

### Week 86

### Elijah Fed By Ravens

#### Scriptures: 1 Kings 17

**Key Verse: 1 Kings 17:24** “Then the woman said to Elijah, Now by this I know that you are a man of God, and that the word of the Lord in you mouth is the truth.”

#### Key Points:

1. Word of famine came through Elijah the Tishbite, a prophet of God. God sends him to hide by the Brook Cherith so he will have water to drink during the famine, he also sends ravens to bring him bread and meat.
2. Eventually, the brook dried up so God comes to him again and sends him to a widow at Zarephath, who would provide for him.
3. As Elijah requests water and food from her, she tells him she only has a small amount of meal and oil. She had been gathering sticks so she could prepare the last amount of bread for her and her son. Then she thought they would die.
4. Elijah tells her not to fear but, to make a cake for him then for her and her son – for God said the flour and oil would not run dry until the end of the famine. She obeyed and it happened as the word of the Lord had said through his prophet.
5. After these things, the widow’s son became very sick and was not breathing. Elijah took the boy to an upper room and laid him on his bed. He cried to the Lord, asking him why this tragedy had come to the woman’s son. Elijah stretched himself over the child 3 times and prayed to the Lord to revive him. He came back to life, so his mother rejoiced and praised Elijah. She knew he indeed was a man of God.

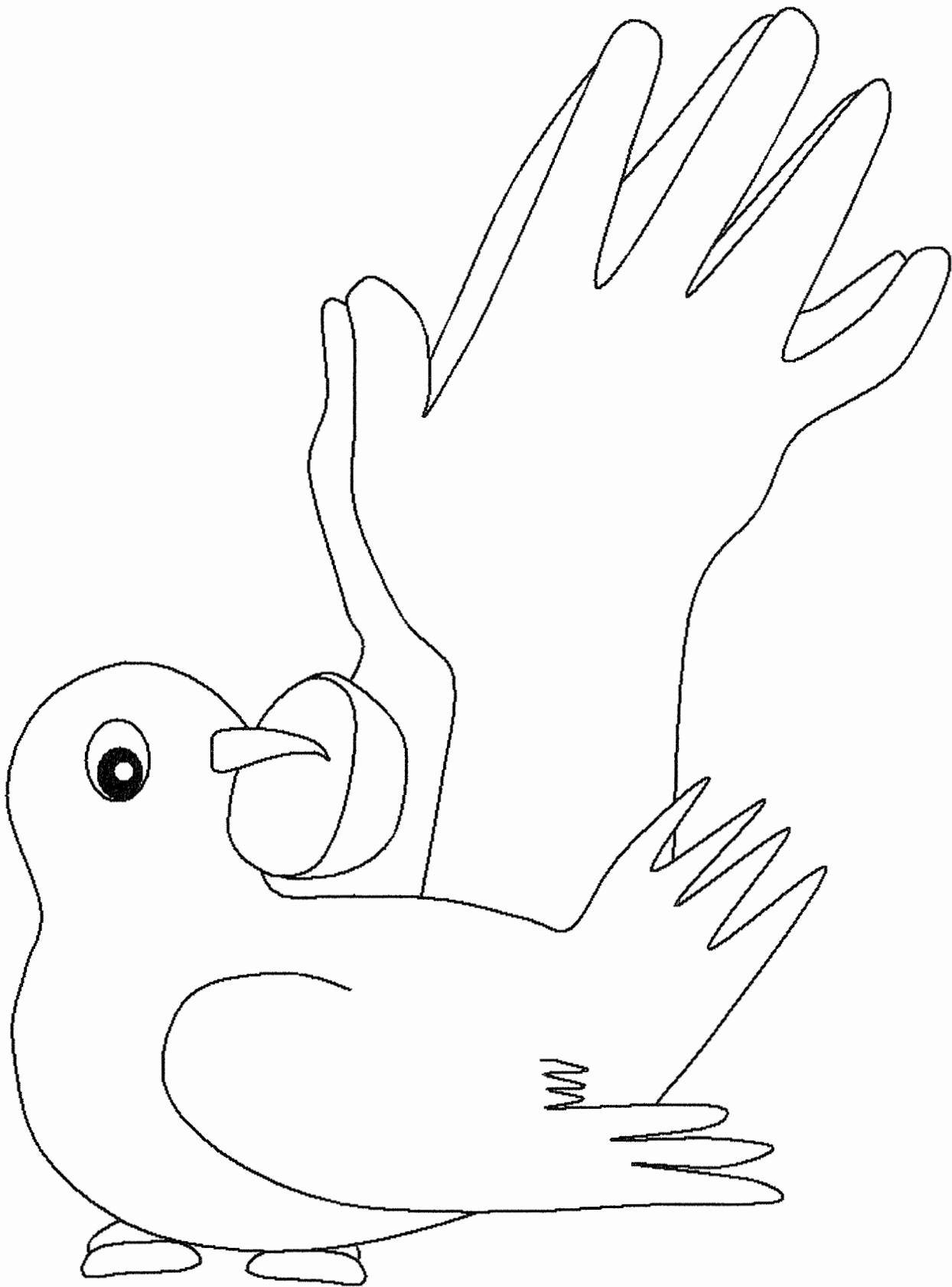

# Birds and Bread



king



angry



rain



Israel



food



bird













bread





house

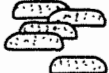

jar

 Ahab was not a good . He served false gods. He made God very . A prophet came and spoke God's words to Ahab. The prophet's name was Elijah. Elijah said to  Ahab, "No  will fall unless I tell it to."  became very dry.  did not grow. People got hungry. Elijah lived by a stream. Every day s brought him meat and . Then the stream dried up. God sent Elijah to a widow's . "Make me some ,

Elijah said to her. "My  of flour is almost empty," the widow said. She made Elijah the  anyway. God said to her, "Your  of flour will never be empty. Your  of oil will never run out."



# Find Two the Same

Two jars on this page are exactly the same. Find them. Make designs on them. Color them. Find the four jars that are different. Cross them out. Do you think the jar of flour looked like this?

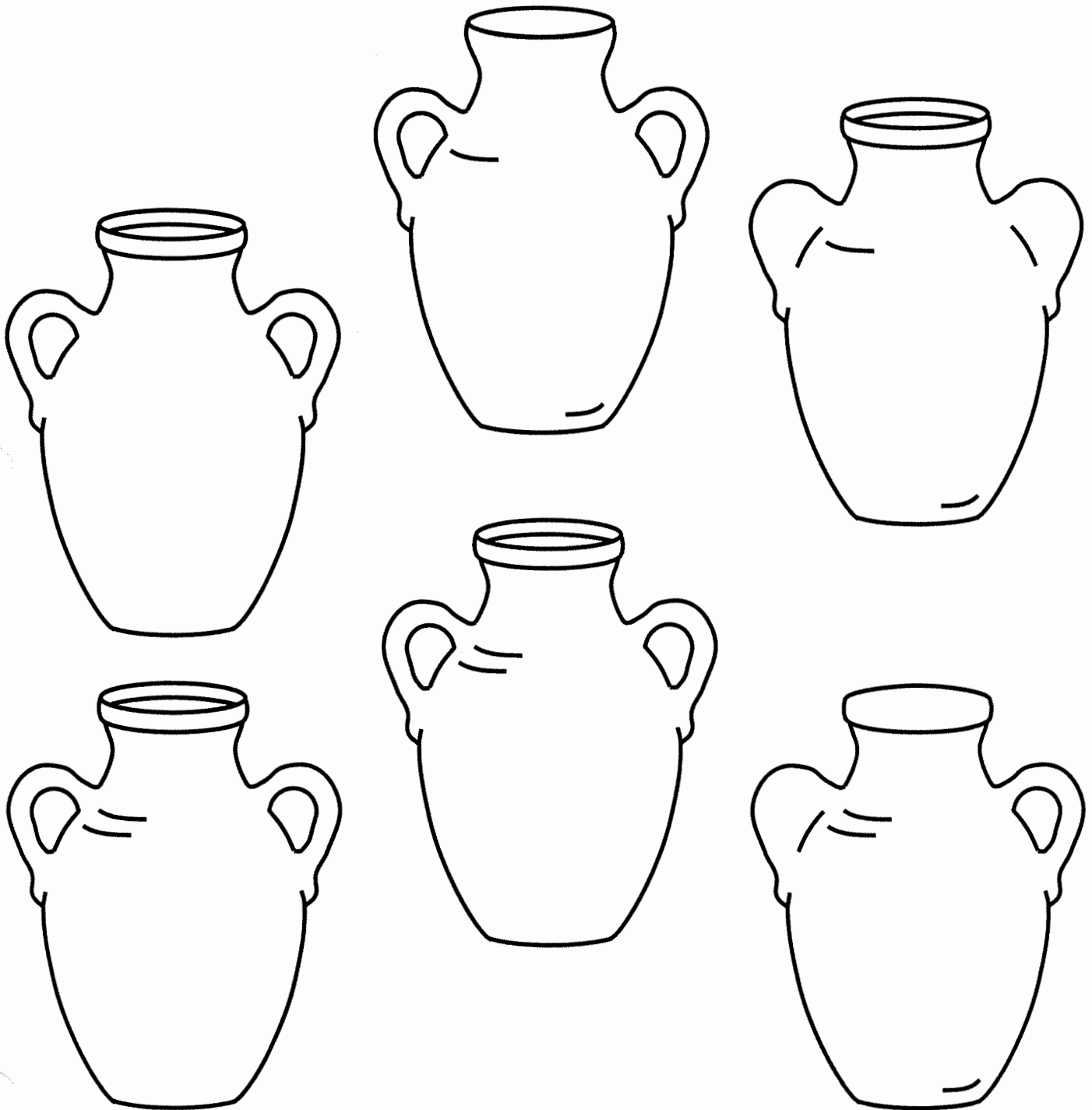

## Elijah's Raven

1 Kings 17:1-7

### Materials needed:

Construction paper—black, scrap of red  
Glue  
Black thread  
Crayons or paint

### Directions:

Cut two ravens out of black construction paper, and two pieces of meat out of the red paper. (See page 26 for patterns.) Glue raven pieces together, inserting 20-inch piece of thread as indicated. Glue meat between raven's beaks. Add raven's eyes with white crayon or paint. Hang in a window or suspend from the ceiling. Use as a visual or a craft.

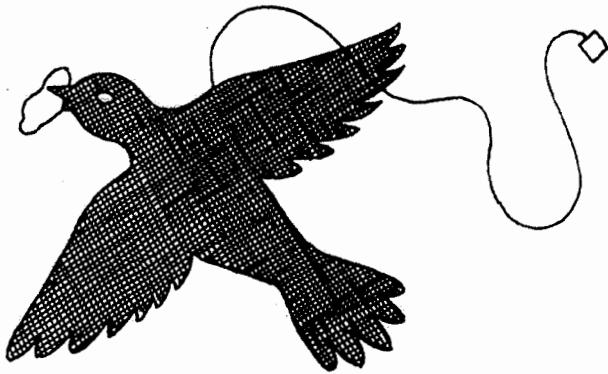

## Elijah on Mt. Carmel

1 Kings 18:20-40

### Materials needed:

Construction paper—dark green, red, gray, brown, light blue  
Yarn—dark green  
Tempera paint  
Glue

### Directions:

Cut twenty-four rocks from gray paper. (See page 24 for all patterns.) Use half of these to form an altar in the lower half of one sheet of green paper. Cut two sacrifices from red paper. Glue one of these on this altar. In second sheet of green paper, punch one hole 1 inch from top and one hole in lower half of paper, where altar will be placed. Glue rest of rocks together to form an altar. Place this over lower hole and glue only around edges. Also glue sacrifice to altar. Paint water around base of altar

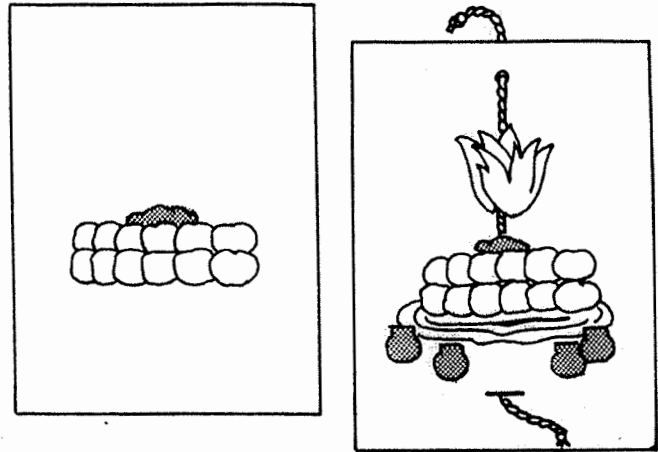

with blue paint. Cut from brown paper and glue four barrels around edge as shown in sketch. Cut flame from red paper and add yellow highlights with tempera paints. Glue this to middle of 20-inch piece of green yarn. Thread yarn through holes with flame on top. Cut sky from blue paper and glue this around edges to top of paper. Glue green sheets together, back to back.

As you tell the story, start with the plain altar. Then turn paper over. Keep flame under "sky" until you tell about the fire coming down from Heaven to consume the sacrifice, the rocks, and the water. Then pull yarn, and flame will come down from "Heaven."

## Sheep Without a Shepherd

1 Kings 22:1-37

### Materials needed:

Construction paper—green  
Clear adhesive backed plastic  
Tempera paints

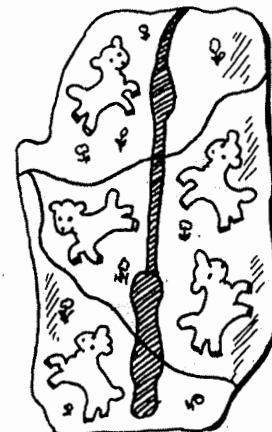

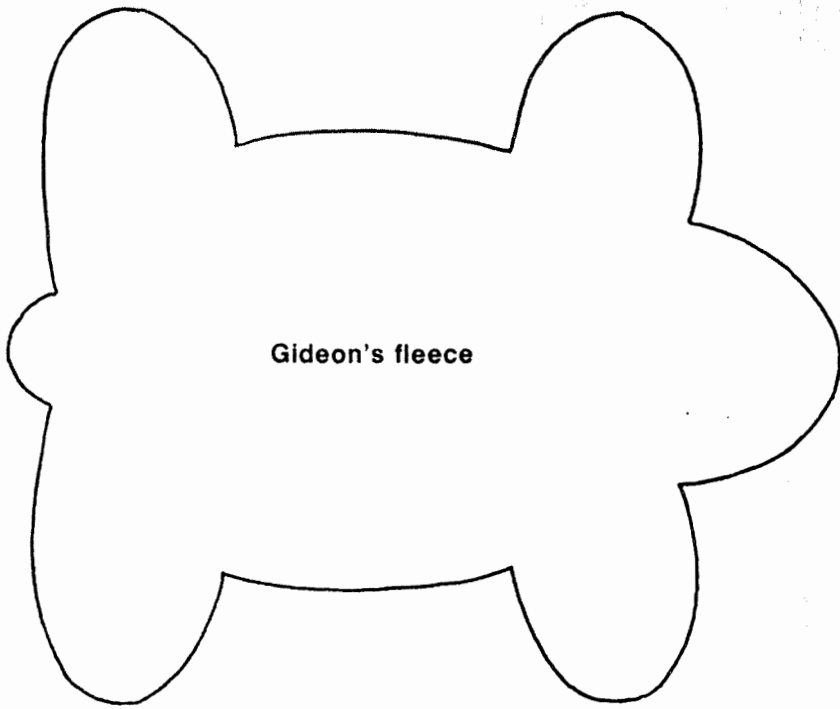

Gideon's fleece

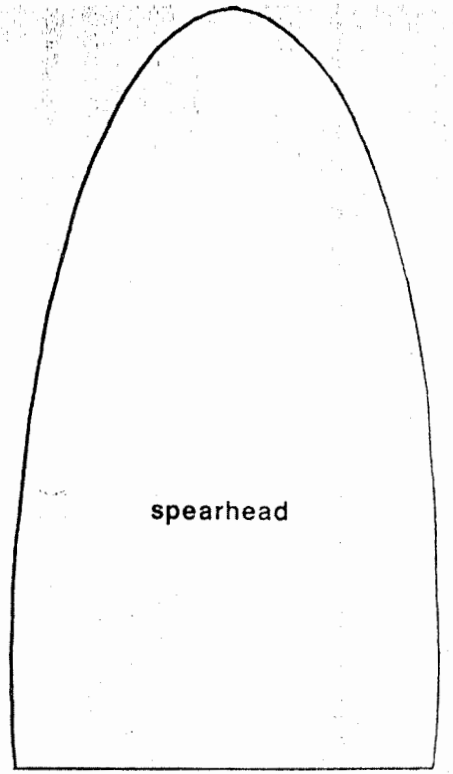

spearhead

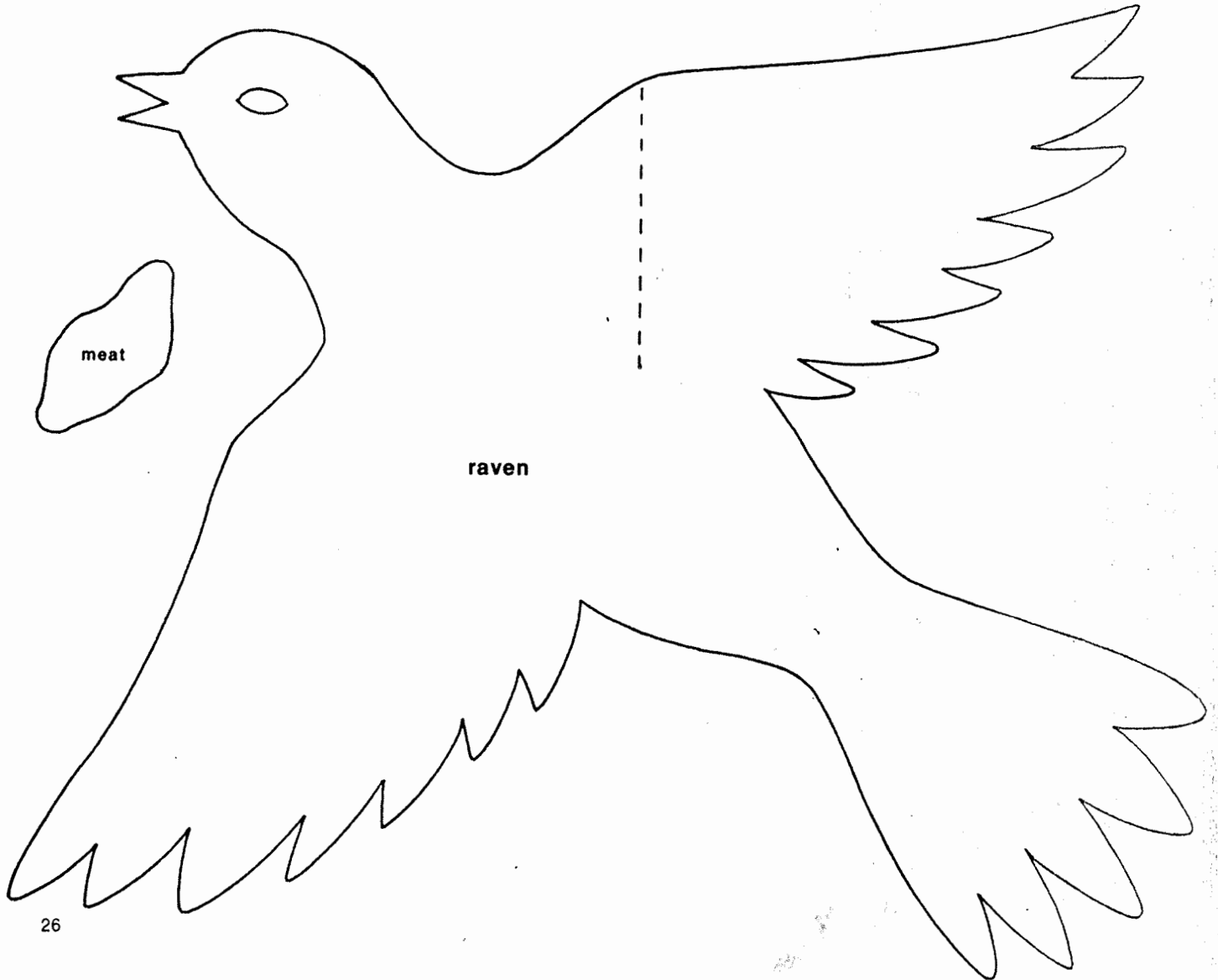

meat

raven



# Elijah

## A Man of Miracles

I Kings 17

### Memory Verse

The woman said to Elijah, "Now I know that you are a man of God and that the Word of the Lord from your mouth is the truth."  
I Kings 17:24 (NIV)

### For the Teacher

Duplicate one circle for each child. Provide scissors. Divide the children into two groups. Have the first group read aloud, in unison, every other word, beginning with the star. Then the second group will read every other word, beginning with the circle. The words read by the first group are in I Kings 17:15 (NIV), and the words read by the second group are in I Kings 17:22-23 (NIV). The answers are on page 61.

### Introduction

During the famine, God told Elijah to ask a poor widow for food. "I have only enough flour and oil to make one cake for my son and me," said the widow.

"Make me a cake first," said Elijah. The widow obeyed, and God used Elijah to work a miracle. Later, the widow's son died. Elijah prayed, and God worked another miracle.

### Skip-A-Word Stories

These stories tell of two of Elijah's miracles. What happened when the widow baked her last cake for Elijah? What happened when Elijah prayed for her dead boy? Cut out the story circle to remind you of the cake of bread that the widow baked for Elijah. Follow your teacher's directions and read every other word in the circle. Listen as the remaining children read the other words.

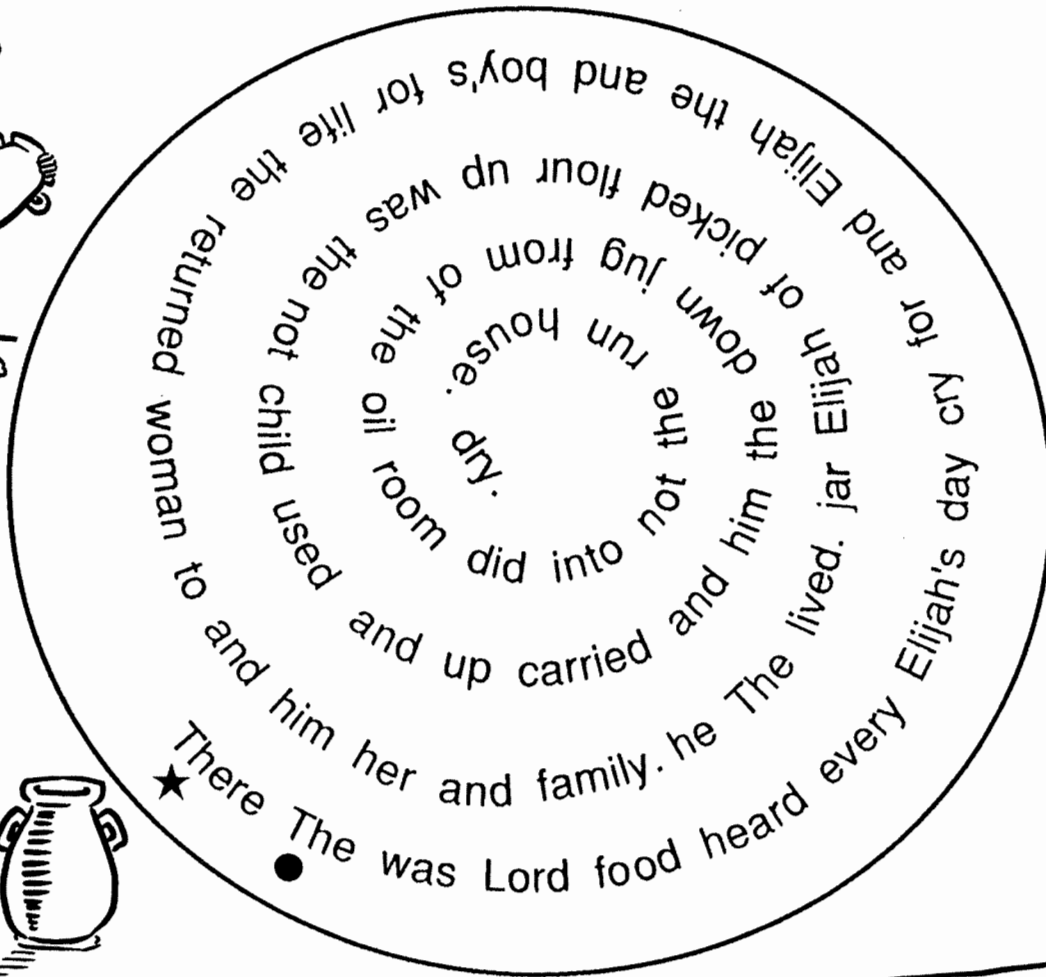

# THE RAVENS BRING FOOD TO ELIJAH

(1 KINGS 17:1-7)

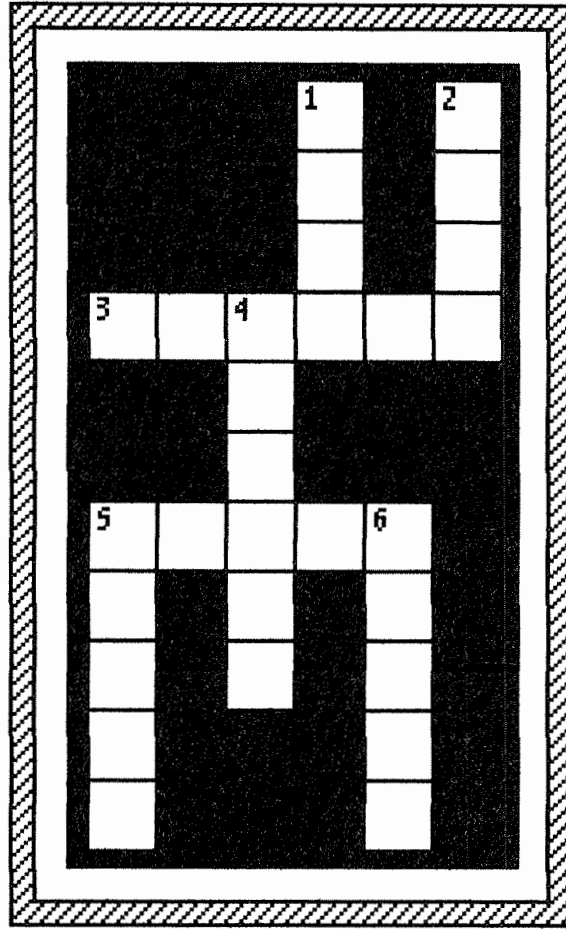

- 2 DOWN "Elijah the Tishbite, of the inhabitants of Gilead, said to Ahab, 'As the LORD God of Israel lives, before whom I stand, there shall not be dew nor \_\_\_\_\_ these years, except at my word.'" **1 KINGS 17:1**
- 3 ACROSS "Then the word of the LORD came to him, saying, 'Get away from here and turn eastward, and hide by the Brook Cherith, which flows into the \_\_\_\_\_.'" **1 KINGS 17:2-3**
- 4 DOWN "It will be that you shall drink from the brook, and I have commanded the \_\_\_\_\_ to feed you there." **1 KINGS 17:4**
- 1 DOWN "So he went and did according to the word of the \_\_\_\_\_, for he went and stayed by the Brook Cherith, which flows into the Jordan." **1 KINGS 17:5**
- 5 ACROSS "The ravens brought him \_\_\_\_\_ and meat in the morning, and bread and meat in the evening." **1 KINGS 17:6**
- 5 DOWN "And he drank from the \_\_\_\_\_." **1 KINGS 17:6**
- 6 DOWN "And it happened after a while that the brook \_\_\_\_\_ up, because there had been no rain in the land." **1 KINGS 17:7**

# THE RAVENS BRING FOOD TO ELIJAH

(1 KINGS 17:1-7)

P D U U K P W H J F K I Y J Y R M S E J  
 D N I A R E J Z T H Q O Y J P C M E A T  
 E T Q U T O N I B A J T K E Z G S V J T  
 B A D H D O S V I W B A O O W R Z R K P  
 C S C E Y C Z V A X B N F A O D R A N K  
 L T H A J I L E M P R R V W B R F C L L  
 P O N R H N K B L E B P L L M G B M P J  
 O O R J U K B Q T S K I S Z W N P L Z C  
 G T W D Q B Z Y Y G E Q V D A E R B Y V  
 U W T S S Y F E L D D D M L U G G B Y T  
 P F I T S N H L I E F R A P F Z K X O W  
 M S N E V A R N O P J J I J I J B A J H  
 N A W A I M N V V Z T Q Z E M P U C L P  
 R M P Z L H G Q Q C E R S H D N M W A J  
 L F P S S L X T Z C J I H G G U C J H H  
 D H W D J D G A U Q Z L M E Y U P U A Q  
 J O R D A N R Q A I Z S M U P O U K H O  
 C L Q J F R Q F N W K T S W Y R M O Z A  
 U B T Q F E I H M Z C P V D B L D I Y W  
 G C A I O U P P G K T A O W D L L T N V

**BREAD**  
**BROOK**  
**DRANK**  
**DRIED UP**

**ELIJAH**  
**JORDAN**  
**LORD**

**MEAT**  
**RAIN**  
**RAVENS**

Bring food →  
to Elijah

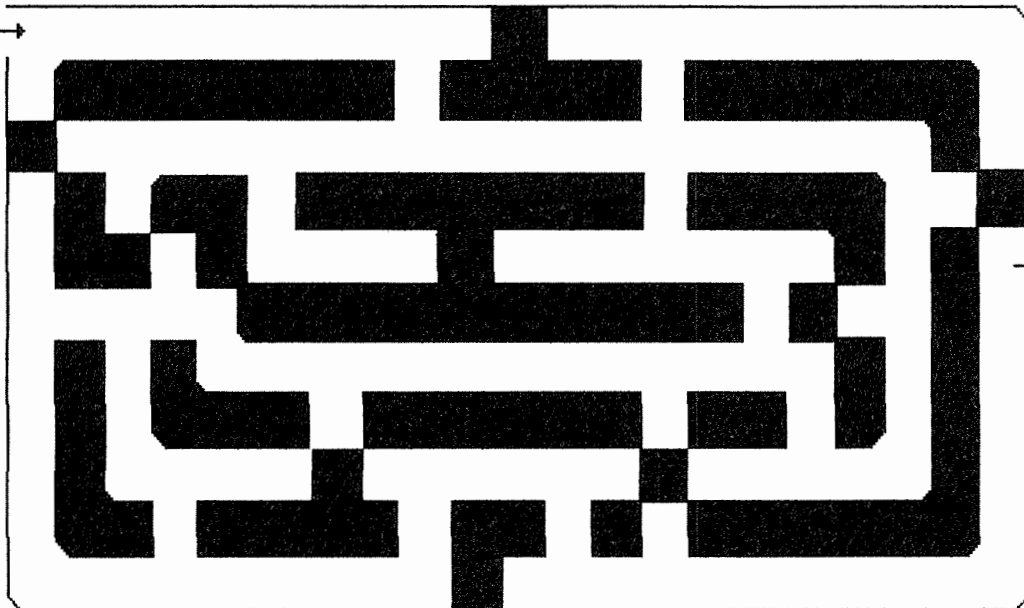

→ Elijah

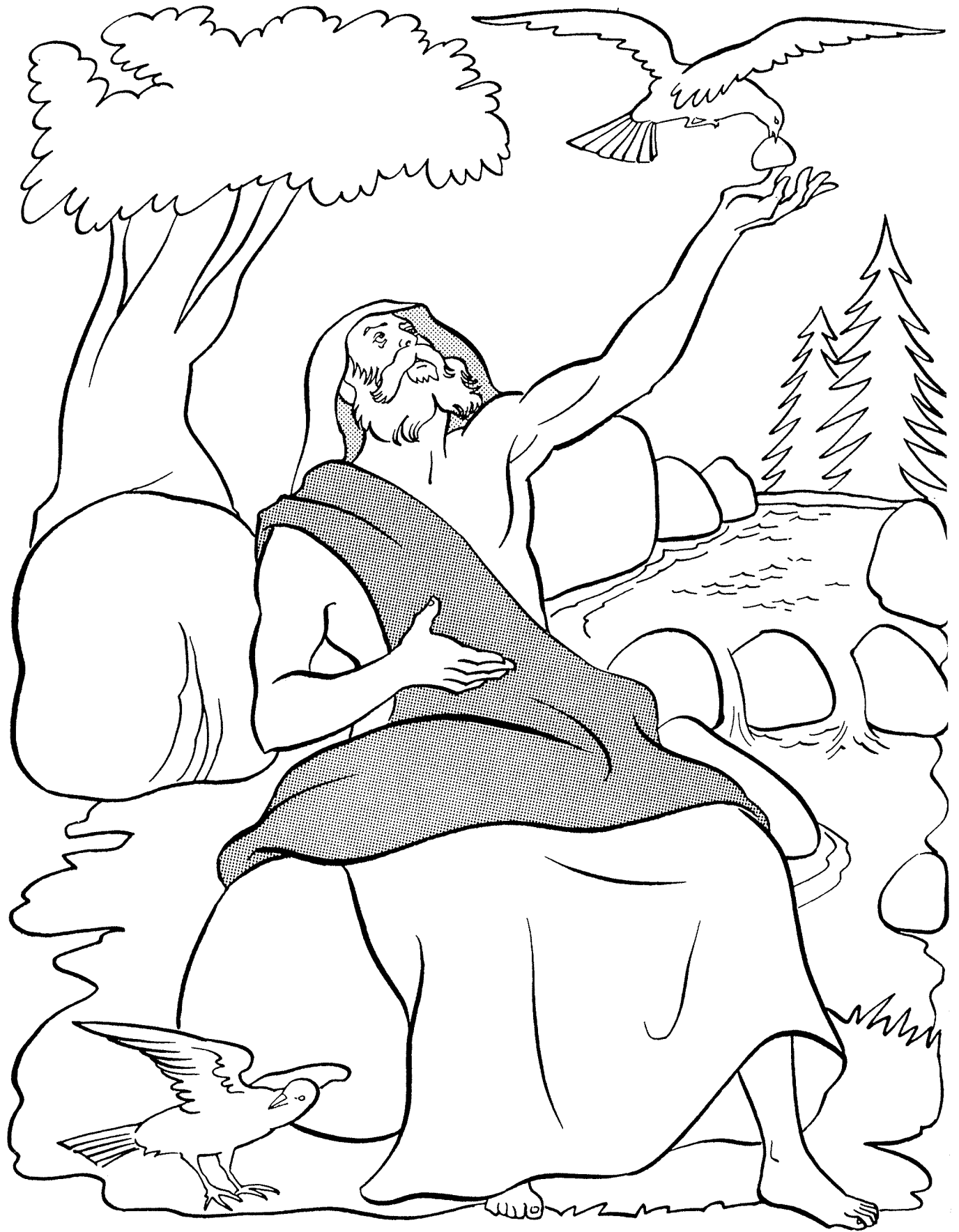

With the death of King Solomon, the people worshipped idols. Elijah remained true to God and was fed by Him through the ravens, when famine overcame the land.

# ELIJAH

1 KINGS 17

## ACROSS

- 1) LARGE BLACK BIRDS  
LIKE CROWS - RHYMES  
WITH "HAVENS"
- 2) WATER THAT FALLS  
FROM THE SKY
- 3) ELIJAH HAD A LONG,  
SCRUFFY \_\_\_\_\_  
GROWING FROM  
HIS CHIN.

## DOWN

- 4) ELIJAH'S \_\_\_\_\_  
WAS GROWN OUT  
LONG (RHYMES  
WITH "CHAIR").
- 5) \_\_\_\_\_ WAS A  
PROPHET OF GOD  
WITH LONG HAIR  
AND BEARD.
- 6) ELIJAH WORE CLOTHES  
MADE FROM ANIMAL  
\_\_\_\_\_, NOT CLOTH.

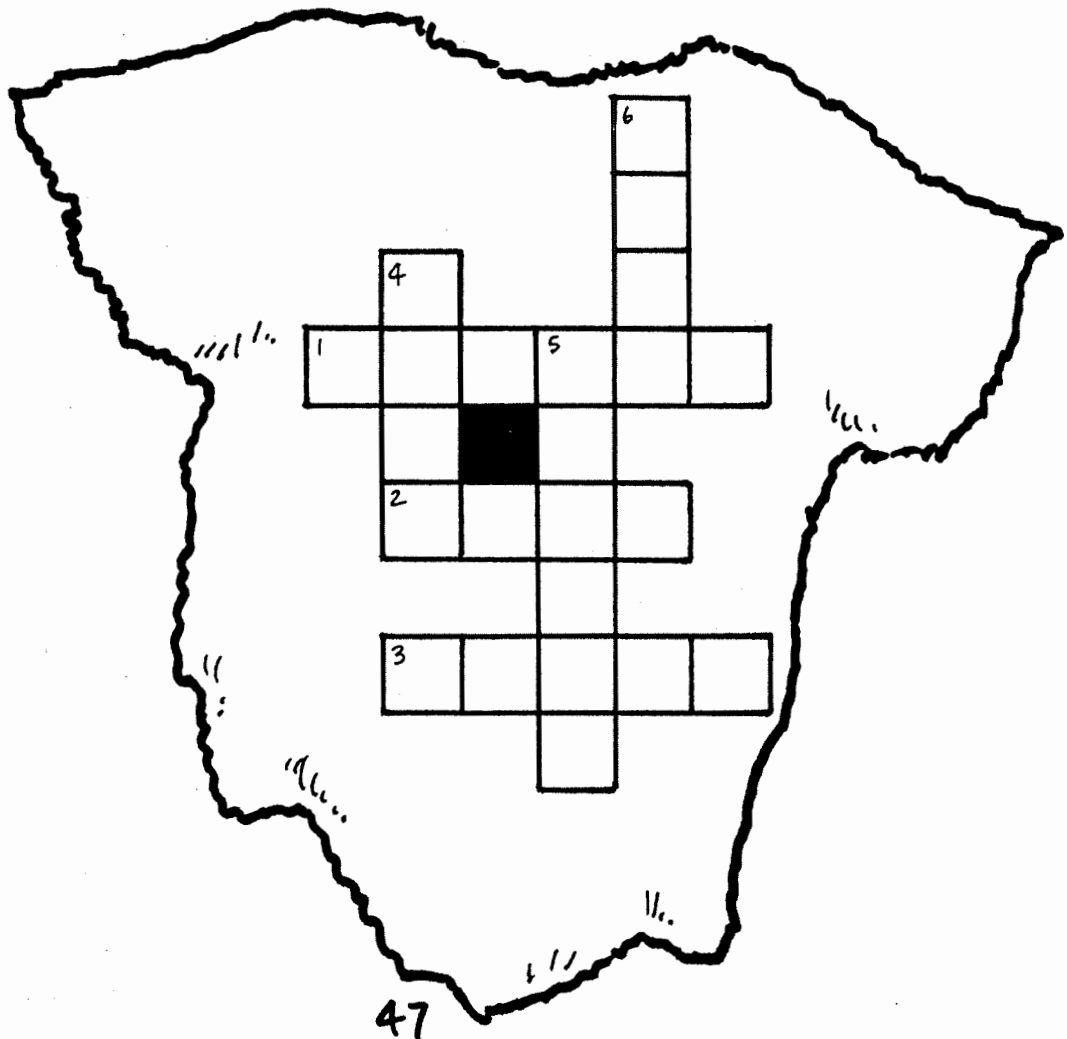



# THE RAVENS BRING FOOD TO ELIJAH

## (1 KINGS 17:1-7)

### MEMORY VERSE:

*"The ravens brought him bread and meat in the morning, and bread and meat in the evening; and he drank from the brook." 1 KINGS 17:6*

### FILL IN THE BLANKS:

1. "Elijah the Tishbite, of the inhabitants of Gilead, said to Ahab, 'As the LORD God of Israel lives, before whom I stand, there shall not be \_\_\_\_\_ nor \_\_\_\_\_ these years, except at my word.'" **1 KINGS 17:1**

### CIRCLE THE CORRECT WORDS:

2. "Then the word of the LORD came to him, saying, 'Get away from here and turn eastward, and hide by the Brook Cherith, which flows into the (OCEAN, JORDAN).'" **1 KINGS 17:2-3**
3. "It will be that you shall drink from the brook, and I have commanded the (RAVENS, ROCKS) to feed you there." **1 KINGS 17:4**

### TRUE OR FALSE:

4. But he would not do according to the word of the LORD, for he would not go to the Brook Cherith, which flows into the Jordan. **1 KINGS 17:5**

TRUE OR FALSE

5. "The ravens brought him bread and meat in the morning, and bread and meat in the evening." **1 KINGS 17:6**

TRUE OR FALSE

### CIRCLE THE CORRECT WORD:

6. "And he (SANK, DRANK) from the brook." **1 KINGS 17:6**

### TRUE OR FALSE:

7. "And it happened after a while that the brook dried up, because there had been no rain in the land." **1 KINGS 17:7**

TRUE OR FALSE

# THE RAVENS BRING FOOD TO ELIJAH

(1 KINGS 17:1-7)

X	N	I	A	R	T	P	M	S	Z
K	P	H	W	T	U	U	E	T	U
N	D	D	J	O	R	D	A	N	O
A	B	R	O	O	K	E	T	R	W
R	E	W	A	J	J	I	H	M	E
D	Q	L	L	V	Q	R	S	D	C
P	A	O	I	G	E	D	T	A	U
D	R	Y	G	J	K	N	O	E	C
D	F	N	Z	A	A	V	S	R	J
J	A	Z	T	Z	K	H	L	B	T

BREAD  
BROOK  
DRANK  
DRIEDUP

ELIJAH  
JORDAN  
LORD

MEAT  
RAIN  
RAVENS

Bring food →  
to Elijah

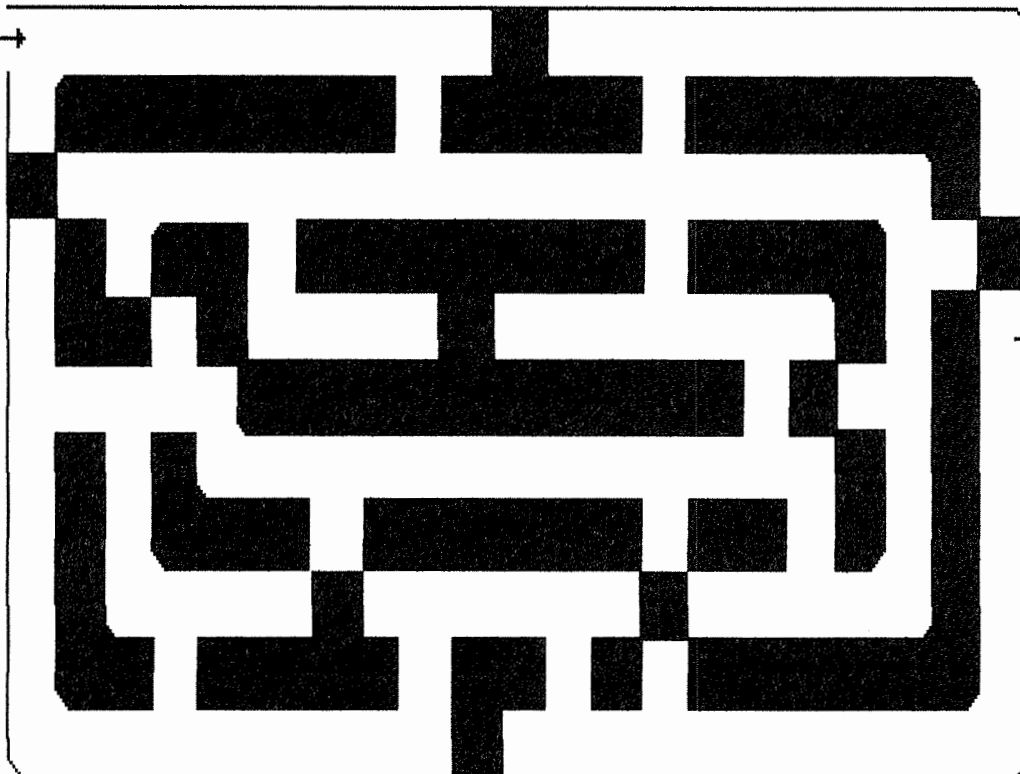

# THE RAVENS BRING FOOD TO ELIJAH

(1 KINGS 17:1-7)

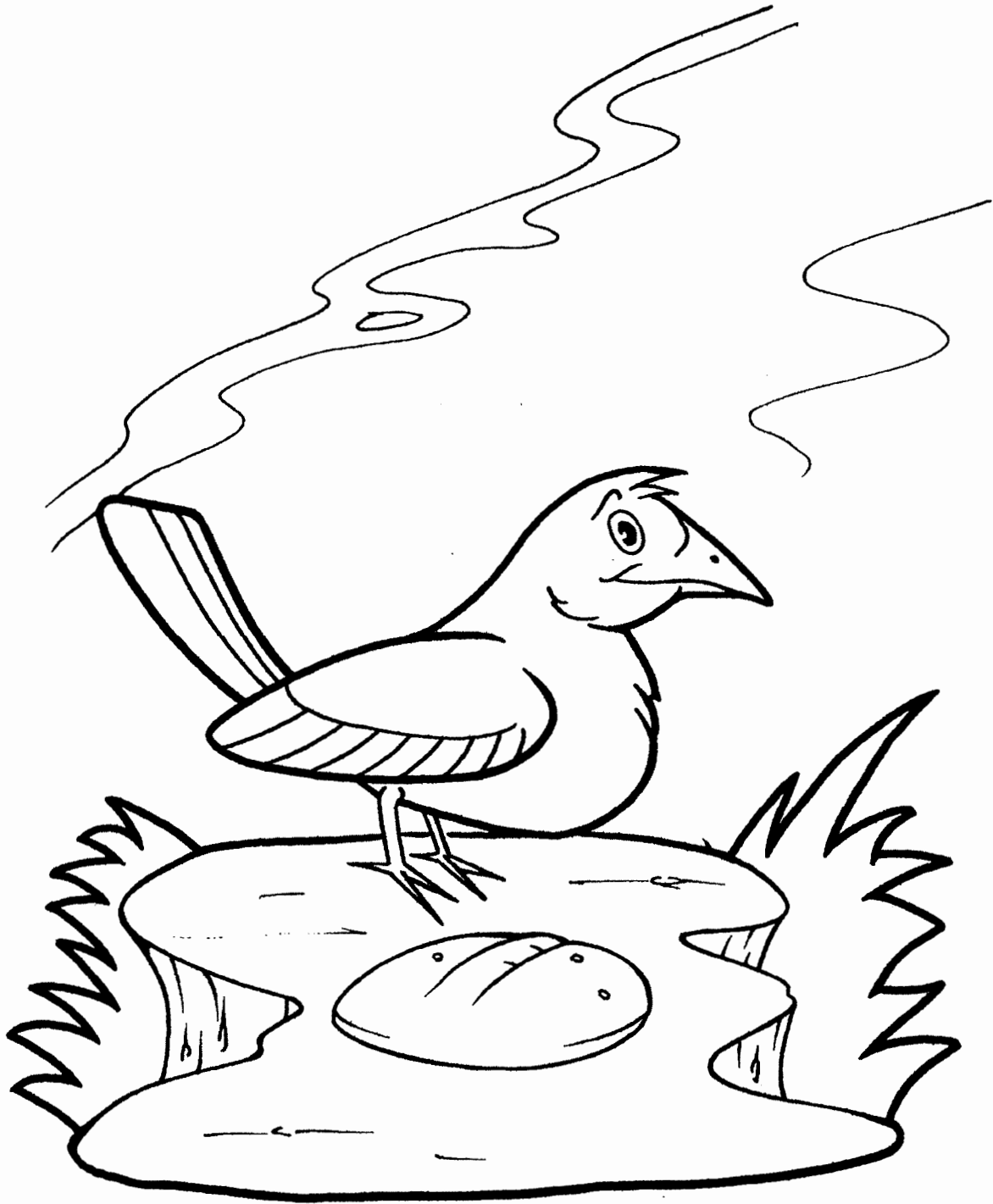

"The ravens brought him bread and meat in the morning, and bread and meat in the evening; and he drank from the brook."

**1 KINGS 17:6**

**E**

is for **Elijah**,  
A prophet who cared.  
Whatever God told him  
He lovingly shared.





Elijah

## Year 2

### Week 87

### Elijah on Mount Carmel

#### Scriptures: 1 Kings 18

**Key Verse: 1 Kings 18:37** “Hear me, O Lord, hear me that this people may know that You are the Lord God and that You have turned their hearts back to You again.”

#### Key Points:

1. King Ahab was more evil than any king before him. God told Elijah to go to Ahab and He would send rain to end the famine. Obadiah was Ahab's servant who met with Elijah, telling him he was willing to talk to Ahab. Obadiah feared the Lord and believed Elijah was a powerful man of God, however, he also feared that Ahab would kill him if he told him about Elijah.
2. Elijah and Ahab meet, Ahab calls Elijah, “O trouble of Israel”. Elijah told Ahab he was the one that had troubled Israel by worshiping false gods and forsaking the commands of the Lord. Elijah challenges Ahab to a show of power on Mt. Carmel.
3. All the children of Israel were summoned there, as well as the prophets of Baal. Elijah speaks to Israel asking them how long they will follow these false gods. No one spoke a word.
4. Elijah instructed two altars to be built; one for the prophets of Baal and one for him. Bulls were put on the altars, but no fire. Elijah tells Ahab to call to his gods to bring fire. They cried out from morning to evening but there was no fire. Elijah prepared his altar with 12 stones, wood and the bull cut in pieces. Water was poured on it 3 times. Elijah calls on the name of the Lord and God sends fire from heaven and completely consumes the entire altar as well as the water. The people of Israel fell on their faces. God again was victorious. His power was shown that day. The prophets of Baal were captured and executed.
5. In reverence Elijah bowed before God-rain was sent to end the famine.

A T E P M U R T E T T D H D S  
 B P U R S U I N G H P T E A M  
 S O B S O T D A S S E A R R W  
 A A O S W O O D H M I I N T A  
 L S T O N E S G E S U W B S H  
 O R G T I M O E U E I A I E S  
 M S S I B A S N R T O B A G O  
 R M O M S N G T R J S R A S A  
 H O R D I I A L L N T U M R K  
 L T A I M T H Y S N B A R T U  
 A E S V M N E E S H N T L H E  
 S J Y A S P O I S R A E L R T  
 G W I D I I R B E I A T T I O  
 S Y A T E T W R E P H R A I M  
 E L T T A B F O R T H S W H T

**3 Letters**  
 OAK  
 PIT

**4 Letters**  
 JOAB  
 WOOD

**5 Letters**  
 DARTS

FORTH  
 HEART  
 ITTAI  
 SMITE  
 SMOTE

**6 Letters**  
 BATTLE  
 GENTLY  
 ISRAEL

THRUST

**7 Letters**  
 ABISHAI  
 ABSALOM  
 EPHRAIM  
 SEEMETH  
 TRUMPET

**8 Letters**

W  
 O  
 R  
 L  
 D  
 Q  
 U  
 E  
 S  
 T  
 I  
 O  
 N  
 s

## Elijah's Altar

### Materials needed:

Styrofoam cup—6 $\frac{2}{3}$  oz. size  
Corrugated cardboard—5-inch square  
Construction paper—blue and yellow  
Lightweight cardboard, such as tagboard  
Felt-tip pen  
Crayons  
White glue  
Single-edge razor blade

### Directions:

With the razor cut the Styrofoam cup 1 $\frac{1}{4}$  inches from the top. Wrap a piece of the lightweight cardboard around cup, mark size, and cut. With a black crayon or felt-tip pen, draw stones on this piece. Color stones gray and use brown between stones.

Cut a piece of corrugated cardboard to fit top of altar and glue in place. Glue twigs on altar. Glue stone covering to sides of altar. Allow to dry.

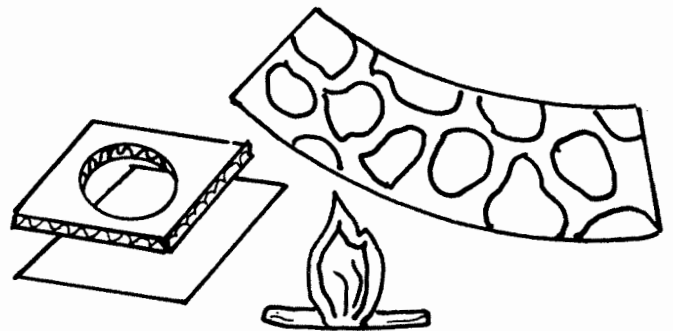
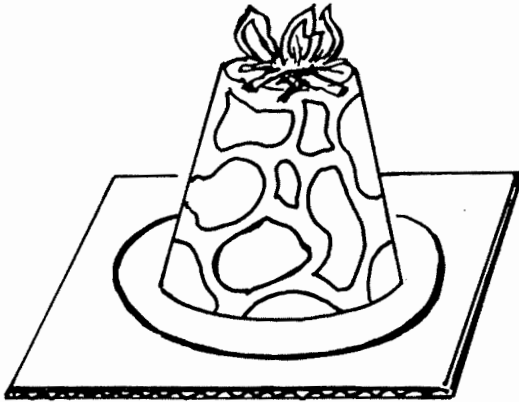

To make base, cut a 4-inch circle out of corrugated square. Cut a 5-inch square of lightweight cardboard and of blue construction paper and glue these together. Then glue corrugated cardboard "soil" on top of "water." Glue altar in center of water. Cut flames of yellow construction paper and edge with orange crayon. Glue onto twigs.

Without water, altar could be used with other Old Testament stories.



# A True Test



Israel



king



Baal



people



mountain



altar



wood





fire



pray



's  Ahab worshiped . God's 

worshiped .  was a false god. Elijah said to



's , "Bring 's prophets to Carmel .

Tell the  of  to come." 450 prophets of 

met Elijah at the . Many  came to watch.

Elijah said to everyone, "You prophets of  make

an . Put  on it. Put a bull on it. I will do the

same thing. Do not set  to it. You  to  for



. I will  to God for . Whoever sends  is

the true God." 's prophets ed and ed.

They ed for . No  came. Elijah ed once

to the true God. God sent . Then the  of



cried, "The Lord is God! The Lord is God!"

# True-False Test

Read the story "A True Test" Then read each sentence below. If a sentence is true, put an X in the true box. If it is not true, put an X in the false box.

1. Elijah said, "Set  to the .
2.  Ahab worshiped .
3. Many  came to watch.
4. Whoever sends  is the true God.
5. Many   ed and  ed.
6. The  cried, "The Lord is God."
7. Elijah said, "Put  on the .
8. God's  worshiped .
9. 350 prophets of  came to the .
10. The  was named Carmel.



Elijah and the Prophets of Baal  
1 Kings 18

# ELIJAH AND THE PROPHETS OF BAAL

1 Kings 18:16-40

**Trace over the lines to see who won the contest.**

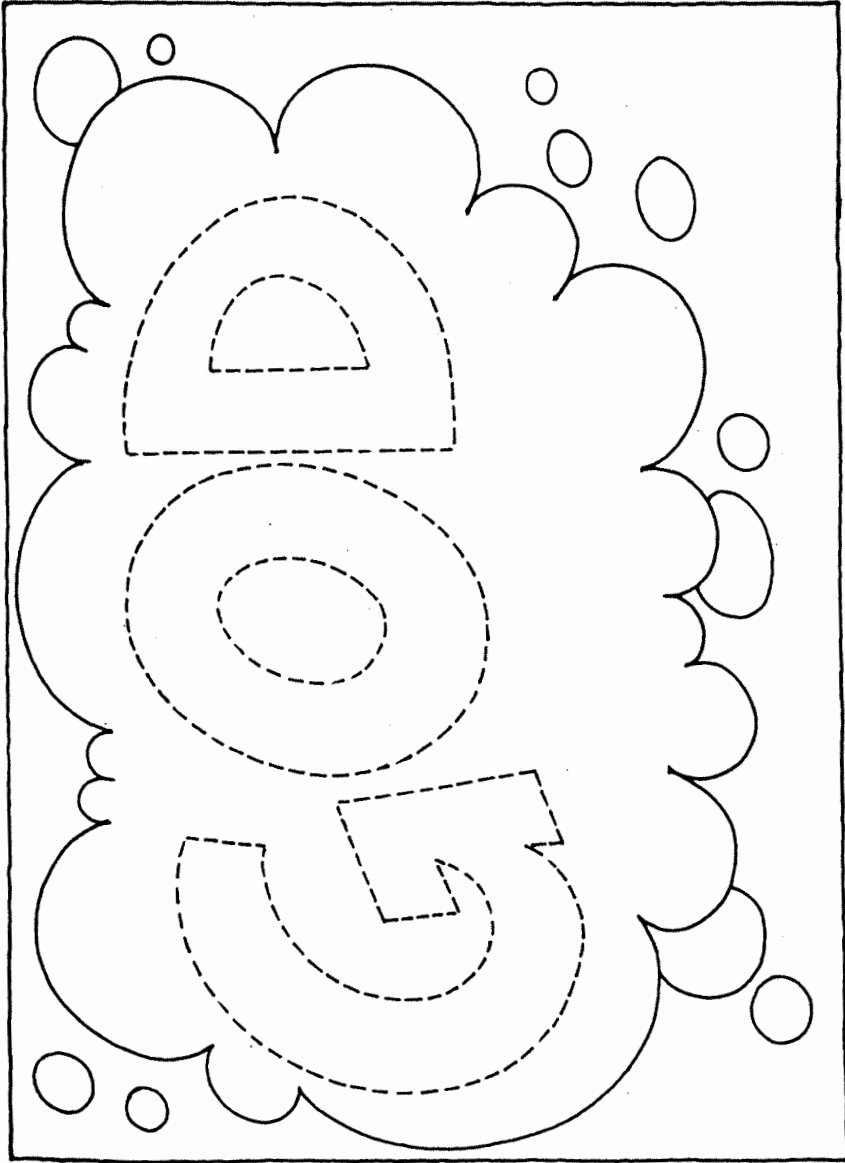

The king and queen of Israel worshiped a false god named Baal. Elijah wanted to prove that God was the true God, so he challenged the priests of Baal to a contest. They shouted for Baal to send down fire and burn an altar. Baal

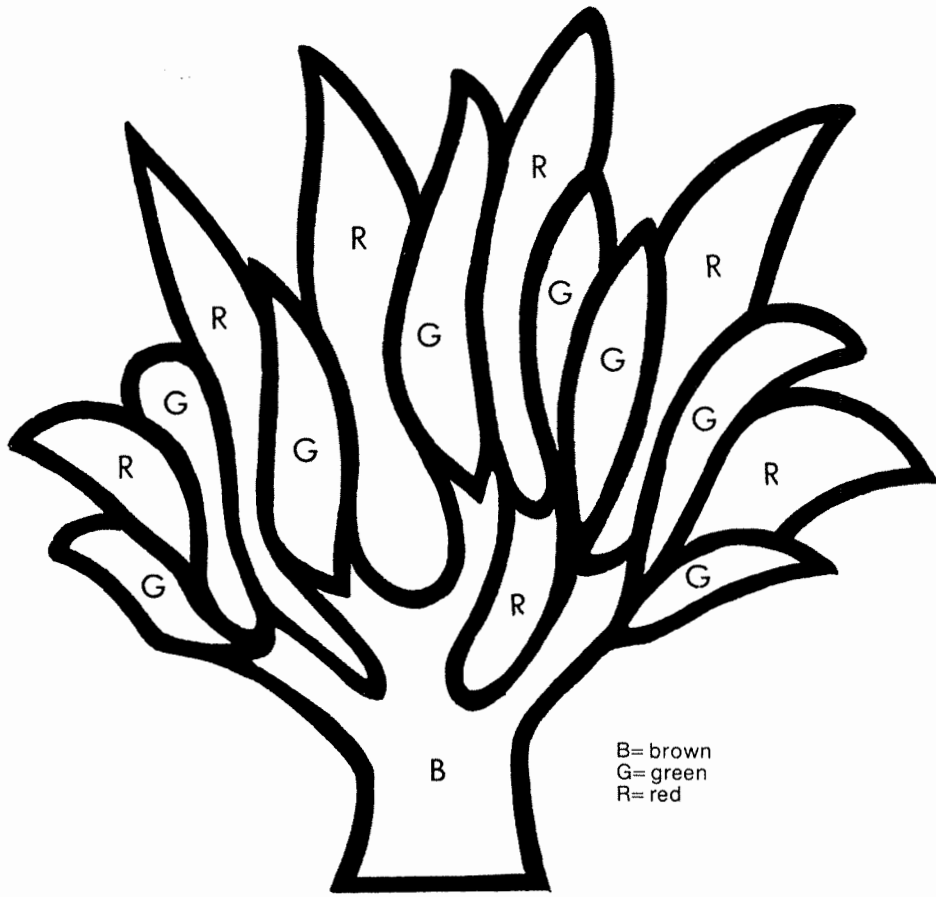

B= brown  
G= green  
R= red

burning bush

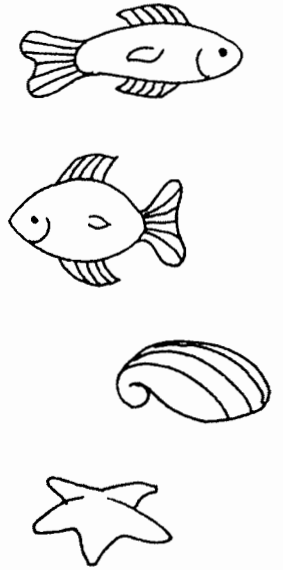

for Crossing the Red Sea



Israelites

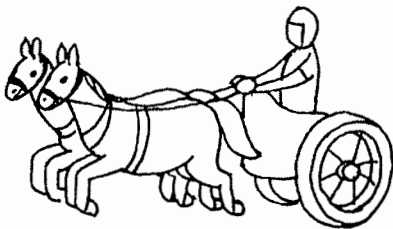

Egyptians

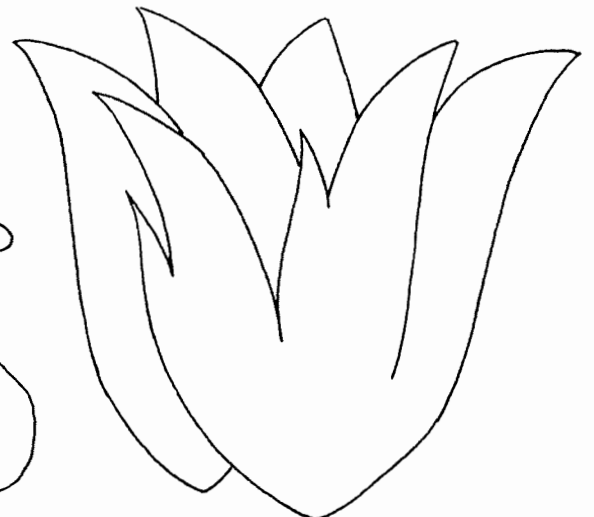
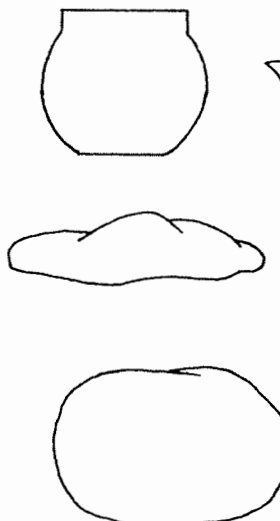

for Elijah on Mt. Carmel

# Elijah's Raven

1 Kings 17:1-7

## Materials needed:

Construction paper—black, scrap of red  
Glue  
Black thread  
Crayons or paint

## Directions:

Cut two ravens out of black construction paper, and two pieces of meat out of the red paper. (See page 26 for patterns.) Glue raven pieces together, inserting 20-inch piece of thread as indicated. Glue meat between raven's beaks. Add raven's eyes with white crayon or paint. Hang in a window or suspend from the ceiling. Use as a visual or a craft.

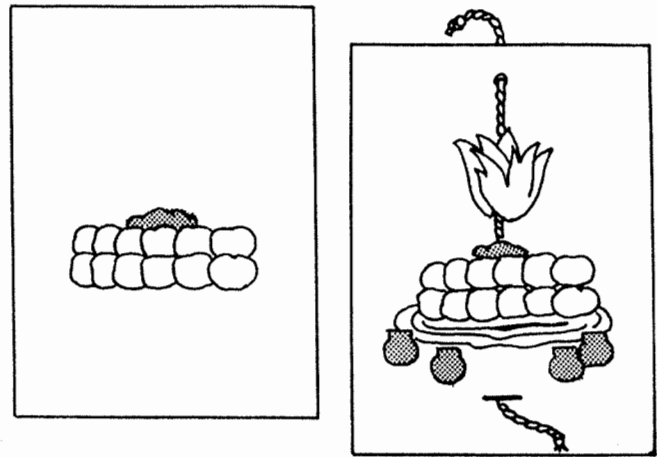
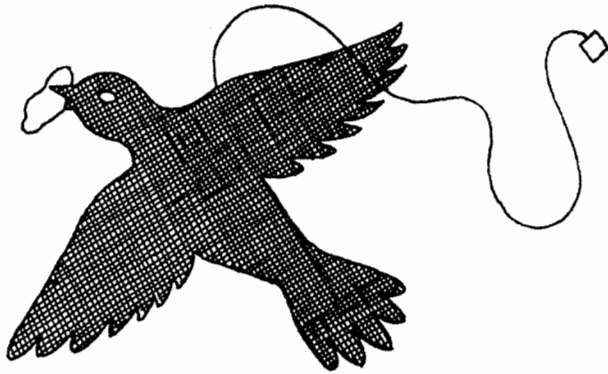

with blue paint. Cut from brown paper and glue four barrels around edge as shown in sketch. Cut flame from red paper and add yellow highlights with tempera paints. Glue this to middle of 20-inch piece of green yarn. Thread yarn through holes with flame on top. Cut sky from blue paper and glue this around edges to top of paper. Glue green sheets together, back to back.

As you tell the story, start with the plain altar. Then turn paper over. Keep flame under "sky" until you tell about the fire coming down from Heaven to consume the sacrifice, the rocks, and the water. Then pull yarn, and flame will come down from "Heaven."

# Elijah on Mt. Carmel

1 Kings 18:20-40

## Materials needed:

Construction paper—dark green, red, gray, brown, light blue  
Yarn—dark green  
Tempera paint  
Glue

## Directions:

Cut twenty-four rocks from gray paper. (See page 24 for all patterns.) Use half of these to form an altar in the lower half of one sheet of green paper. Cut two sacrifices from red paper. Glue one of these on this altar. In second sheet of green paper, punch one hole 1 inch from top and one hole in lower half of paper, where altar will be placed. Glue rest of rocks together to form an altar. Place this over lower hole and glue only around edges. Also glue sacrifice to altar. Paint water around base of altar

# Sheep Without a Shepherd

1 Kings 22:1-37

## Materials needed:

Construction paper—green  
Clear adhesive backed plastic  
Tempera paints

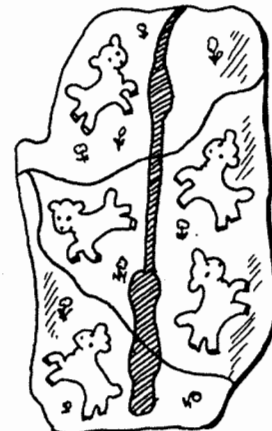

# ELIJAH DEFEATS THE PROPHETS OF BAAL

## (1 KINGS 18:1-40)

### MEMORY VERSE:

"Now when all the people saw it, they fell on their faces; and they said, 'The LORD, He is God! The LORD, He is God!' " 1 KINGS 18:39

### CIRCLE THE CORRECT WORDS:

1. "Now it came to pass after many days that the word of the LORD came to Elijah, in the third year, saying, 'Go, present yourself to Ahab, and I will send (**RAIN, SNOW**) on the earth.' " 1 KINGS 18:1
2. "Then it happened, when Ahab saw Elijah, that Ahab said to him, 'Is that you, O (**BUBBLER, TROUBLER**) of Israel?' " 1 KINGS 18:17
3. "He answered, 'I have not troubled Israel, but you and your father's house have, in that you have (**FORSAKEN, KEPT**) the commandments of the LORD, and you have followed the Baals.' "1 KINGS 18:18

### TRUE OR FALSE:

4. Elijah said to Ahab, "Now therefore, send and gather all Israel to me on Mount Carmel, the four hundred and fifty prophets of Baal, and the four hundred prophets of Asherah, who eat at Jezebel's table." 1 KINGS 18:19  
**TRUE OR FALSE**
5. But Ahab would not send for all the children of Israel, nor would he gather the prophets together on Mount Carmel. 1 KINGS 18:20  
**TRUE OR FALSE**
6. "And Elijah came to all the people, and said, 'How long will you falter between two opinions? If the LORD is God, follow Him; but if Baal, then follow him.' " 1 KINGS 18:21  
**TRUE OR FALSE**

### CIRCLE THE CORRECT WORDS:

7. "Therefore let them give us two bulls; and let them choose one bull for themselves, cut it in pieces, and lay it on the wood, but put (**A, NO**) fire under it; and I will prepare the other bull, and lay it on the wood, but put (**A, NO**) fire under it." 1 KINGS 18:23
8. " 'Then you call on the name of your gods, and I will call on the name of the LORD; and the God who answers by (**RAIN, FIRE**), He is God.' So all the people answered and said, 'It is well spoken.' "1 KINGS 18:24

### TRUE OR FALSE:

9. "So they took the bull which was given them, and they prepared it, and called on the name of Baal from morning even till noon, saying, 'O Baal, hear us!' But there was no voice; no one answered." 1 KINGS 18:26  
**TRUE OR FALSE**
10. When it was Elijah's turn, he prayed to the LORD, " 'Hear me, O LORD, hear me, that this people may know that You are the LORD God, and that You have turned their hearts back to You again.' Then the fire of the LORD fell and consumed the burnt sacrifice, and the wood and stones and the dust, and it licked up the water that was in the trench." 1 KINGS 18:37-38  
**TRUE OR FALSE**
11. "Now when all the people saw it, they fell on their faces; and they said, 'The LORD, He is God! The LORD, He is God!' And Elijah said to them, 'Seize the prophets of Baal! Do not let one of them escape!' So they seized them; and Elijah brought them down to the Brook Kishon and executed them there." 1 KINGS 18:39-40  
**TRUE OR FALSE**

# ELIJAH DEFEATS THE PROPHETS OF BAAL

## (1 KINGS 18:1-40)

```

R R D F I R E V P F H Z V X P
C E O Z L Y I S R A E L B H L
L R O O D N S F R R Y U W M O
P V R S K E C I F I R C A S P
R D K T L J E Z E B E L Y G D
E T D V P E O I R C G U U Q H
M O E G A R M U E G M A H A B
H J M W G F O R N O X I J W Q
Y Q U A S L E P A W U I K G J
Y L S T A K Z N H C L X Y X J
M P N E U I P I A E T Q H W C
B V O R K Q E A I J T N F D X
P G C A S H E R A H V S U I V
R Y P W S S U H P V E B N O D
Y Q S L L U B I Q L A A B C M
  
```

AHAB  
ASHERAH  
BAAL  
BULLS  
CONSUMED

ELIJAH  
FIRE  
ISRAEL  
JEZEBEL  
LORD

MOUNT CARMEL  
PROPHETS  
RAIN  
SACRIFICE  
WATER

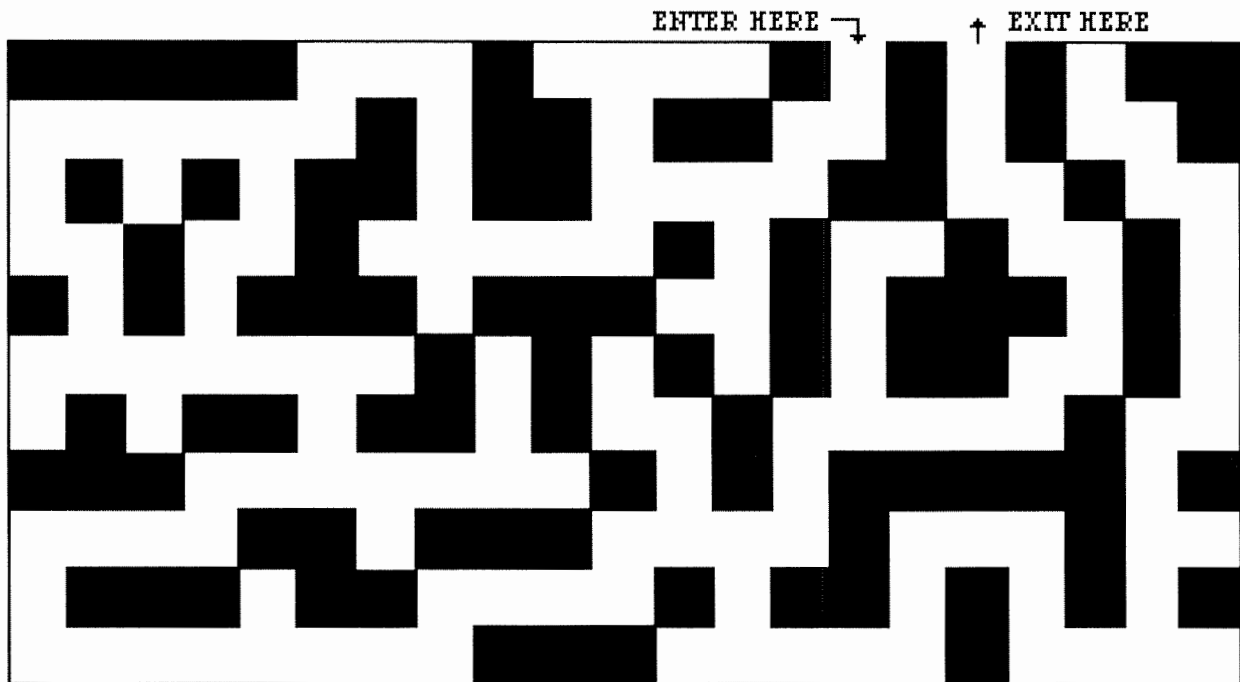



# ELIJAH DEFEATS THE PROPHETS OF BAAL

## (1 KINGS 18:1-40)

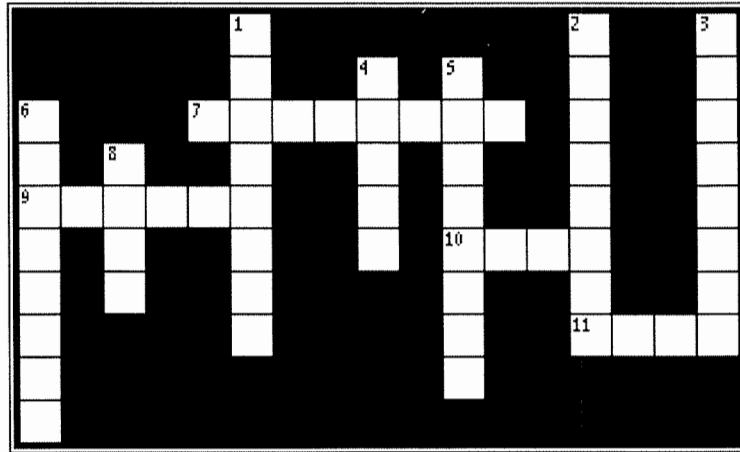

- 11 ACROSS "The word of the LORD came to Elijah, in the third year, saying, 'Go, present yourself to Ahab, and I will send \_\_\_\_\_ on the earth.' " **1 KINGS 18:1**
- 2 DOWN "Then it happened, when Ahab saw Elijah, that Ahab said to him, 'Is that you, O \_\_\_\_\_ of Israel?' " **1 KINGS 18:17**
- 3 DOWN "He answered, 'I have not troubled Israel, but you and your father's house have, in that you have \_\_\_\_\_ the commandments of the LORD, and you have followed the Baals.' " **1 KINGS 18:18**
- 5 DOWN Elijah said to Ahab, "Now therefore, send and gather all Israel to me on Mount Carmel, the four hundred and fifty prophets of Baal, and the four hundred prophets of Asherah, who eat at \_\_\_\_\_ table." **1 KINGS 18:19**
- 1 DOWN "So Ahab sent for all the children of Israel, and gathered the \_\_\_\_\_ together on Mount Carmel." **1 KINGS 18:20**
- 9 ACROSS "And \_\_\_\_\_ came to all the people, and said, 'How long will you falter between two opinions? If the LORD is God, follow Him; but if Baal, then follow him.' " **1 KINGS 18:21**
- 4 DOWN "Therefore let them give us two \_\_\_\_\_; and let them choose one bull for themselves, cut it in pieces, and lay it on the wood, but put no fire under it." **1 KINGS 18:23**
- 8 DOWN " 'Then you call on the name of your gods, and I will call on the name of the LORD; and the God who answers by \_\_\_\_\_, He is God.' So all the people answered and said, 'It is well spoken.' " **1 KINGS 18:24**
- 10 ACROSS "So they took the bull which was given them, and they prepared it, and called on the name of \_\_\_\_\_ from morning even till noon." **1 KINGS 18:26**
- 7 ACROSS "The fire of the LORD fell and \_\_\_\_\_ the burnt sacrifice, and the wood and stones and the dust, and it licked up the water that was in the trench." **1 KINGS 18:37-38**
- 6 DOWN "Elijah said to them, 'Seize the prophets of Baal! Do not let one of them escape!' So they seized them; and Elijah brought them down to the Brook Kishon and \_\_\_\_\_ them there." **1 KINGS 18:40**

# Elijah Defeats the Prophets of Baal

Elijah wanted to show the Israelites that God is the one true God so he challenged the prophets of Baal to a contest. Elijah and the prophets of Baal both called on their gods to send fire from heaven, but only Elijah's God answered. The people saw that God answered prayer and Baal could not. After this contest, God sent rain for the first time in more than 3 years.

The hidden words come from this story in I Kings 18:41-46. The code following each word tells the coordinates where one of the letters of the word is found in the puzzle. After you have found all the hidden words, start at the upper left and use all the leftover letters to fill in the blanks at the bottom of the page with a Bible verse which tells what happens when we pray.

AHAB (11N)		A	B	C	D	E	F	G	H	I	J	K	L	M	N	O	LOINS (4I)	
ARISETH (5F)																	LOOKED (7G)	
BEHOLD (13M)	1	E	T	H	P	E	L	N	E	V	A	E	H	E	F	C	1	LORD (4C)
BETWEEN (12H)	2	R	F	O	E	O	C	O	L	R	T	K	E	U	A	L	2	MEANWHILE (2H)
BLACK (5N)	3	A	T	L	R	F	T	E	I	R	V	E	C	N	T	O	3	NOTHING (10E)
CARMEL (14C)	4	P	A	D	L	N	T	S	H	N	P	A	A	A	R	U	4	NOW (14I)
CAST (4K)	5	E	E	A	Y	O	E	E	W	T	S	R	F	O	L	D	5	PASS (15M)
CLOUD (1O)	6	R	R	F	W	T	O	E	N	T	R	A	N	C	E	B	6	PREPARE (5A)
DOWN (13A)	7	P	G	A	H	H	G	K	A	A	O	A	R	B	I	G	7	RAIN (8D)
DRINK (13C)	8	H	R	T	I	I	K	E	E	O	D	U	E	B	S	M	8	RAN (15I)
EARTH (6J)	9	D	A	N	R	N	M	A	M	D	E	T	A	E	V	A	9	RODE (8J)
EAT (9M)																	9	SEA (12G)
ELIJAH (13D)	10	I	L	D	E	G	D	S	E	T	W	N	T	H	E	E	10	SERVANT (11K)
ENTRANCE (6N)	11	H	E	E	L	R	M	E	E	E	U	A	C	O	A	H	11	SOUND (15H)
FACE (2L)	12	D	S	W	I	N	D	A	E	L	J	V	A	L	M	B	12	STOP (2E)
GIRDED (9D)	13	O	E	N	J	N	S	N	F	W	F	R	I	D	V	E	13	THEE (10L)
GREAT (7B)	14	W	K	C	A	R	M	E	L	O	A	E	S	I	X	T	14	TOP (3B)
HAND (15C)	15	N	E	H	H	E	S	O	U	N	D	S	S	A	P	N	15	TOWARD (9A)
HEAVEN (1G)																		WAS (13I)
HIMSELF (9F)																		WIND (12E)
KNEES (12B)																		

**HIDDEN VERSE:** \_\_\_\_\_  
 \_\_\_\_\_  
 \_\_\_\_\_ . \_\_\_\_\_ :

**Year 2**

**Week 88**

## **God Comforts Elijah**

**Scriptures: I Kings 19:1-21**

**Key Verse: 1Ki 19:10** So he said, "I have been very zealous for the LORD God of hosts; for the children of Israel have forsaken Your covenant, torn down Your altars, and killed Your prophets with the sword. I alone am left; and they seek to take my life."

### **Key Points:**

1. Jezebel threatened Elijah's life after he had slain the prophets of Baal.
2. Elijah became afraid and ran away.
3. An angel provided food and water to sustain Elijah on his journey to Mt. Horeb. He had no other food for 40 days and nights.
4. Elijah was discouraged and hid in a cave.
5. God demonstrated his presence, not in the wind, an earthquake, or a fire, but in a still small voice.
6. God then sent Elijah to anoint two kings, Hazael and Jehu, and to anoint Elisha to be a helper to him.
7. Elijah knew that God would protect him to assure that he would be able to complete God's work.

# 30. An Enemy and a Friend

## 1 Kings 19

Queen \_\_\_\_\_, King \_\_\_\_\_'s wife, was angry that Elijah had shown that his God was more powerful than the prophets of Baal. Jezebel threatened to kill Elijah.

Elijah ran away to the desert. He was tired, \_\_\_\_\_ and discouraged. God sent an angel to feed and comfort him.

Then the Lord gave him a new job. Elijah was to anoint new kings for Israel and Judah and a new prophet to take his own place. The \_\_\_\_\_ also encouraged him by telling him that there were seven thousand men in Israel who had never bowed to the \_\_\_\_\_ Baal.

Elijah was refreshed and encouraged and went to do the Lord's will.

Elijah found \_\_\_\_\_ plowing a field. Elijah took his cloak and threw it around Elisha's shoulders. Elisha knew this meant he should leave his home and become a prophet like Elijah.

Elijah trained Elisha, and Elisha was an encouraging friend to Elijah.

Write the missing words in the boxes below.



E					
L					
I					
J					
A					
H					

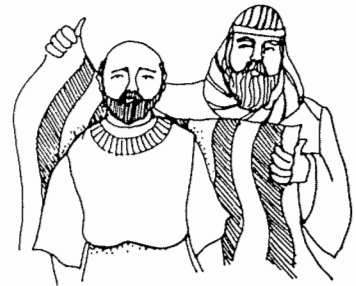

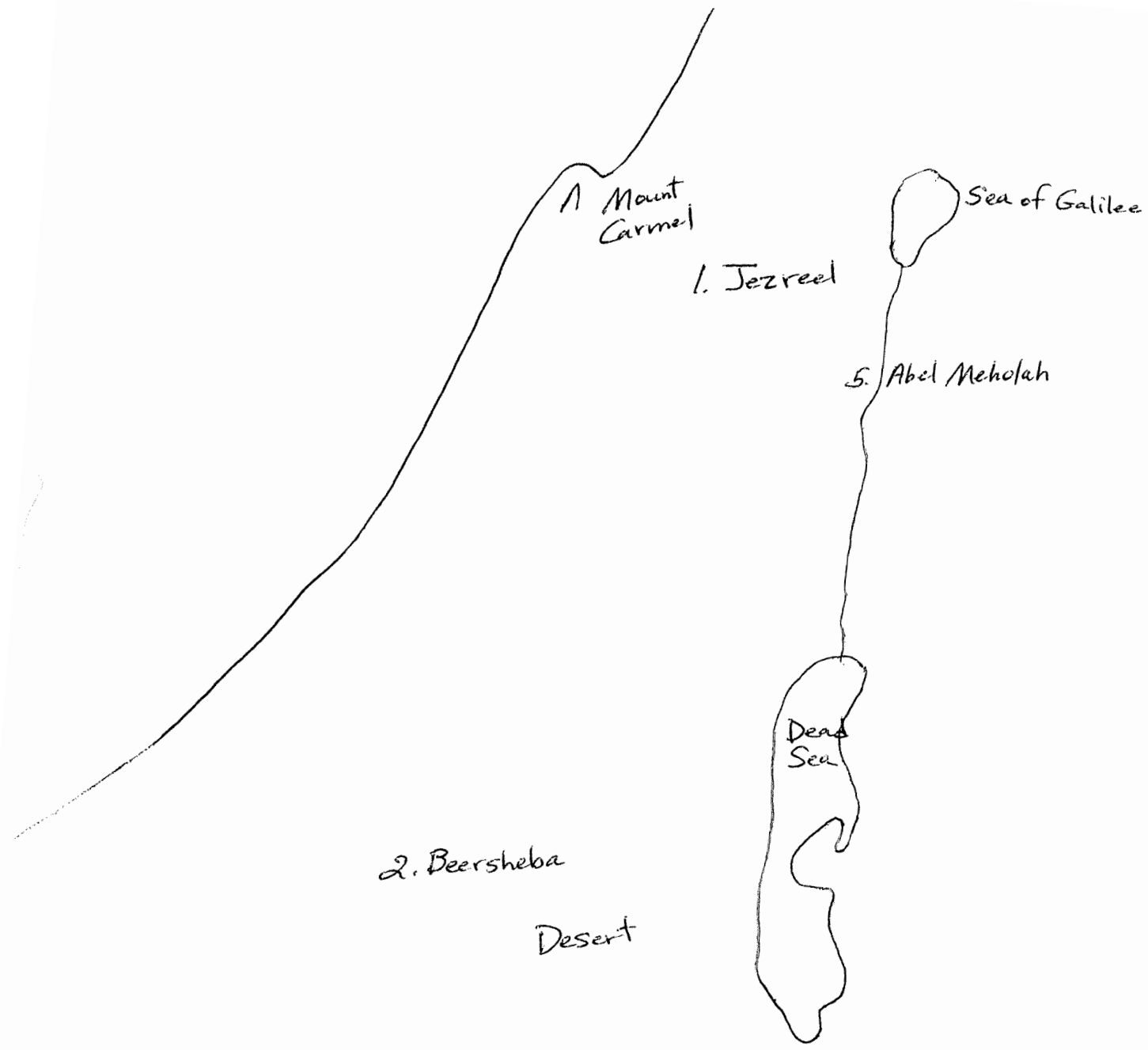

1 Mount Carmel

Sea of Galilee

1. Jezreel

5. Abel Meholah

2. Beersheba

Desert

Dead Sea

3. 40 Days travel  
250 miles

4. Mt. Horeb (Sinai) - A.V.F.

# THE STILL SMALL VOICE

(1 KINGS 19:11-18)

B H S G G E Q L P Y T W Z H T  
 Y V P D S S M O U N T A I N D  
 K E M E W T I O B J N Q N I D  
 P V N O A L E C A V E C I O V  
 U G R O O R L H Q T D X K U Q  
 Y D B P L V T Z P N R I O A C  
 F S B K S A H H J O A T B N U  
 K N O D L D H A Q E R A H N J  
 T B H N K D T M J U R P F T K  
 G B O I W Z Y F I I A I V Q S  
 E K S W V Z O M C A L K F H M  
 Y K S S E O A Q T S Z E E A J  
 G O R P J D V S C L E L I U T  
 M J V P X W C Q J P M B O U A  
 L O R D W H A V W U D Z N T A

ALONE  
 BOWED  
 CAVE  
 EARTHQUAKE

ELIJAH  
 FIRE  
 MOUNTAIN  
 PROPHETS

SWORD  
 VOICE  
 WIND  
 LORD

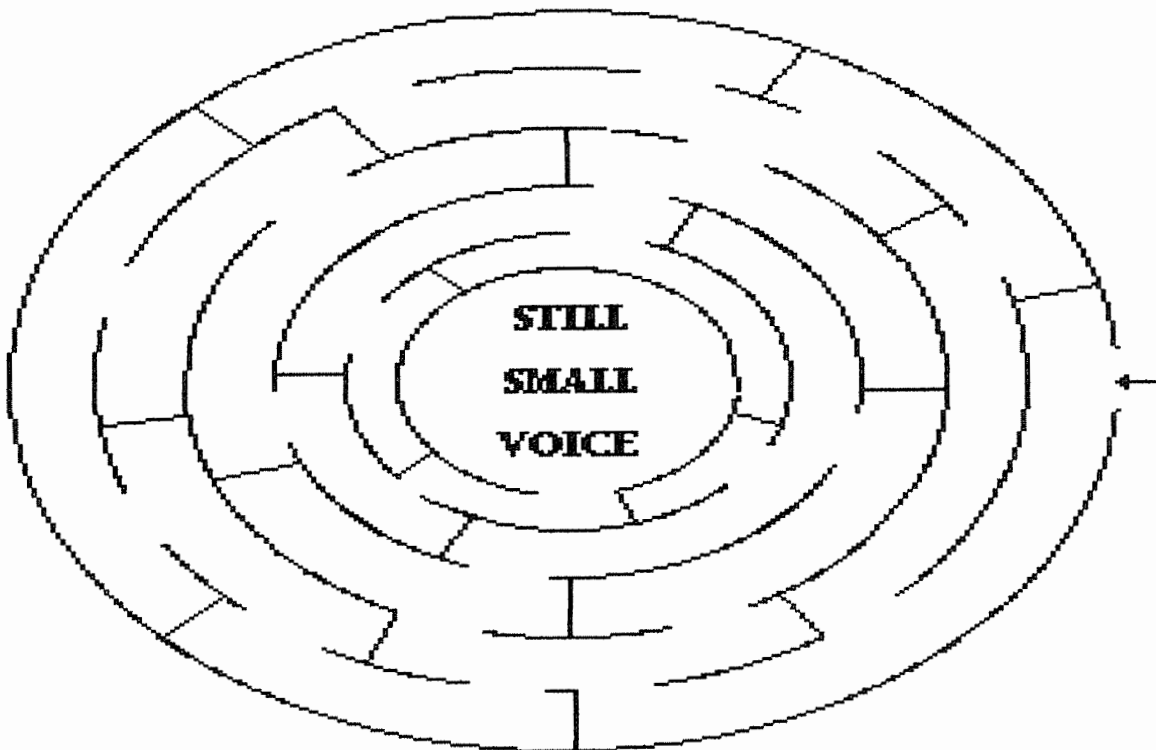

# **. THE STILL SMALL VOICE**

## **(1 KINGS 19:11-18)**

### **MEMORY VERSE:**

***"And behold, the LORD passed by, and a great and strong wind tore into the mountains and broke the rocks in pieces before the LORD, but the LORD was not in the wind; and after the wind an earthquake, but the LORD was not in the earthquake; and after the earthquake a fire, but the LORD was not in the fire; and after the fire a still small voice." 1 KINGS 19:11-12***

### **TRUE OR FALSE:**

1. The LORD God said to Elijah, "Go out, and stand on the mountain before the LORD." **1 KINGS 19:11**  
**TRUE OR FALSE**

### **CIRCLE THE CORRECT WORDS:**

2. "Behold, the LORD passed by, and a great and strong (**WIND, CRANE**) tore into the mountains and broke the rocks in pieces before the LORD." **1 KINGS 19:11**
3. "The LORD (**WAS, WAS NOT**) in the wind." **1 KINGS 19:11**
4. "After the wind an (**EARTHQUAKE, TIDAL WAVE**)." **1 KINGS 19:11**
5. "The LORD (**WAS, WAS NOT**) in the earthquake." **1 KINGS 19:11**
6. "After the earthquake a (**FIRE, FEAST**)." **1 KINGS 19:12**
7. "The LORD (**WAS, WAS NOT**) in the fire." **1 KINGS 19:12**
8. "After the fire a still small (**VOICE, MOUSE**)." **1 KINGS 19:12**

### **FILL IN THE BLANK:**

9. "So it was, when Elijah heard it, that he wrapped his face in his \_\_\_\_\_ and went out and stood in the entrance of the cave." **1 KINGS 19:13**

### **TRUE OR FALSE:**

10. "And suddenly a voice came to him, and said, "What are you doing here, Elijah?" " **1 KINGS 19:13**  
**TRUE OR FALSE**

### **FILL IN THE BLANK:**

11. Elijah said, "I have been very zealous for the LORD God of hosts; because the children of Israel have forsaken your covenant, torn down Your altars, and killed Your prophets with the sword. I \_\_\_\_\_ am left; and they seek to take my life." **1 KINGS 19:14**

### **CIRCLE THE CORRECT WORD:**

12. The LORD said to Elijah, "I have reserved seven thousand in Israel, all whose knees have not (**LOOKED, BOWED**) to Baal, and every mouth that has not kissed him." **1 KINGS 19:18**

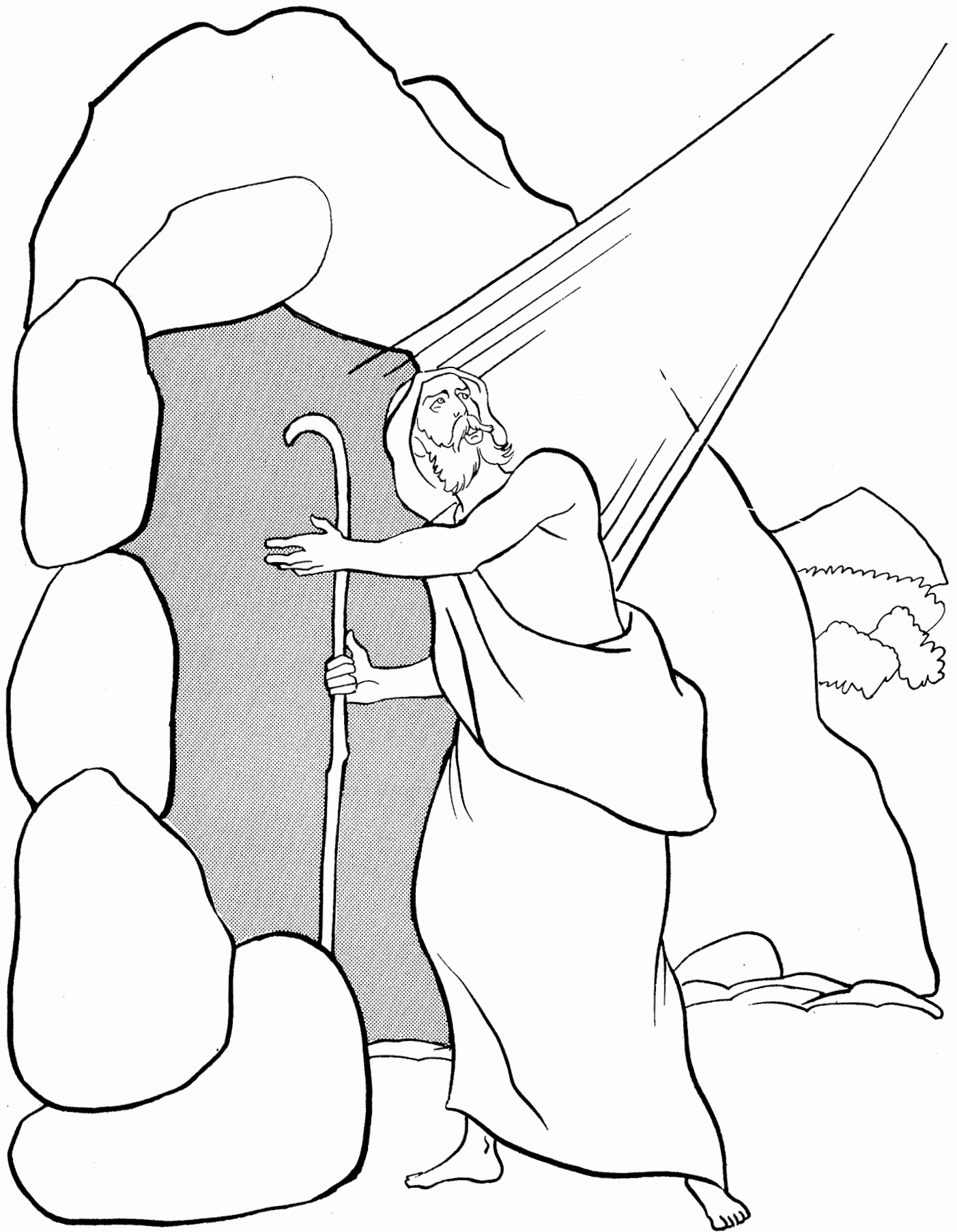

When Elijah's work was finished, a voice from heaven told him to anoint Elisha as the next prophet.





# ELIJAH CHOOSES ELISHA

## (1 KINGS 19:19-21)

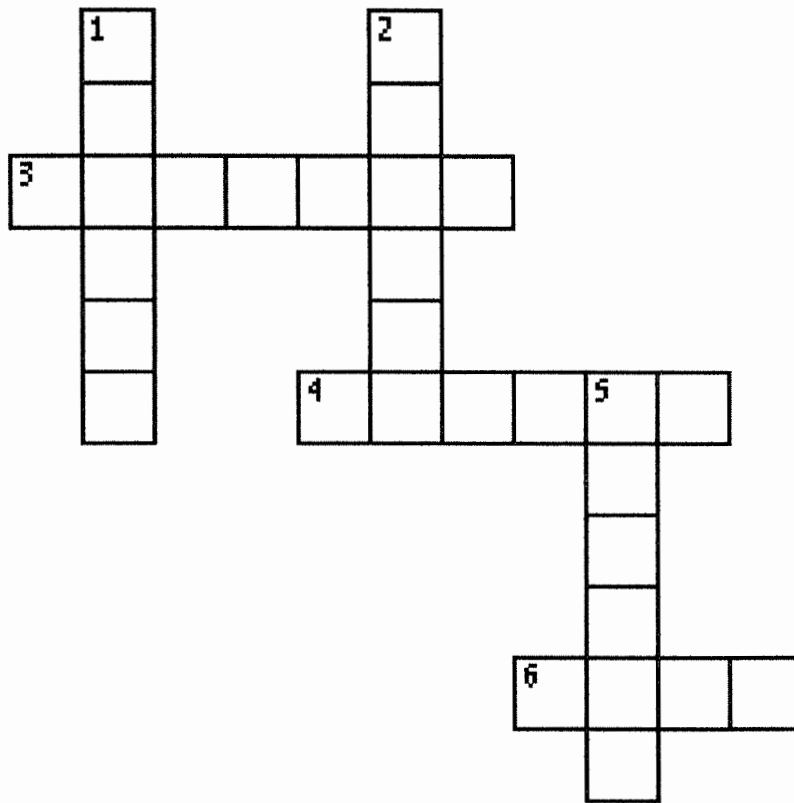

- 3 ACROSS Elijah "found Elisha the son of Shaphat, who was \_\_\_\_\_ with twelve yoke of oxen before him, and he was with the twelfth." **1 KINGS 19:19**
- 2 DOWN "Then Elijah passed by him and threw his \_\_\_\_\_ on him." **1 KINGS 19:19**
- 5 DOWN "And he left the oxen and ran after \_\_\_\_\_." **1 KINGS 19:20**
- 1 DOWN Elisha said to Elijah, "Please let me kiss my father and my mother, and then I will \_\_\_\_\_ you." **1 KINGS 19:20**
- 6 ACROSS Elijah said, "Go \_\_\_\_\_ again, for what have I done to you?" **1 KINGS 19:20**
- 4 ACROSS After eating with the people, "he arose and followed Elijah, and \_\_\_\_\_ him." **1 KINGS 19:21**

# ELIJAH CHOOSES ELISHA

## (1 KINGS 19:19-21)

### MEMORY VERSE:

*"So he departed from there, and found Elisha the son of Shaphat, who was plowing with twelve yoke of oxen before him."* 1 KINGS 19:19

### FILL IN THE BLANK:

1. Elijah "found Elisha the son of Shaphat, who was \_\_\_\_\_ with twelve yoke of oxen before him, and he was with the twelfth." 1 KINGS 19:19

### TRUE OR FALSE:

2. "Then Elijah passed by him and threw his mantle on him." 1 KINGS 19:19  
TRUE OR FALSE
3. But he would not leave the oxen nor run after Elijah. 1 KINGS 19:20  
TRUE OR FALSE

### FILL IN THE BLANK:

4. Elisha said to Elijah, "Please let me kiss my father and my mother, and then I will \_\_\_\_\_ you." 1 KINGS 19:20

### TRUE OR FALSE:

5. Elijah said, "Go back again, for what have I done to you?" 1 KINGS 19:20  
TRUE OR FALSE

### FILL IN THE BLANK:

6. After eating with the people, "he arose and followed Elijah, and \_\_\_\_\_ him." 1 KINGS 19:21

# GOD SPEAKS TO ELIJAH

1 Kings 19:1-18

Figure out the secret code and learn how God spoke to Elijah.



△ ▮ ○ ▽ ▽

▽ ☆ △ ▽ ▽

○ ▽ ○ ▮ ▮

Secret Code	
a	△
b	+
c	▮
d	○
e	▮
f	⊖
g	▮
h	◇
i	▽
j	*
k	▽
l	▽
m	☆
n	←
o	▽
p	x
q	D
r	∞
s	△
t	▮
u	▮
v	○
w	▮
x	□
y	⊖
z	▮

When God defeated Baal, the king and queen got very angry with Elijah. He had to run away and hide until they calmed down. God told Elijah to go to the top of a mountain because he wanted to talk to him. Elijah waited and soon a big windstorm came, then an earthquake, and after that a fire. God didn't speak through any of those things, but Elijah heard God's voice in a surprising way.

**Year 2**

**Week 89**

## **King Ahab**

**Scriptures: I Kings 21(result of prophecy II Kings 9:30-34)**

**Key Verse: 1Ki 21:25 But there was no one like Ahab who sold himself to do wickedness in the sight of the LORD, because Jezebel his wife stirred him up.**

### **Key Points:**

- 1.** Naboth owned a vineyard near the palace of King Ahab.
- 2.** Ahab asked to buy it, but Naboth refused to sell.
- 3.** Ahab was very unhappy, and his wife Jezebel devised a plan to get the vineyard for Ahab.
- 4.** She sent letters in Ahab's name to the elders instructing them to hold a feast pretending to honor Naboth, but it was a ploy to have him killed.
- 5.** During the feast, two liars came who accused Naboth of dishonoring God and King Ahab. Because of their lies, Naboth was killed.
- 6.** Ahab seized the vineyard, but God sent Elijah to meet him there.
- 7.** Ahab and his family would be punished. All of his family would be killed and their bodies left unburied to be eaten by dogs and birds.
- 8.** Ahab repented and mourned, and God postponed His justice to fall on Ahab's sons, who were also very wicked men.
- 9.** This was fulfilled in II Kings 9 when Jehu killed King Joram and Jezebel, and Ahab's other descendants.

# QUEEN JEZEBEL

1 Kings 21

These two pictures may look the same, but there are a few things that are different. Circle the differences in the second picture.

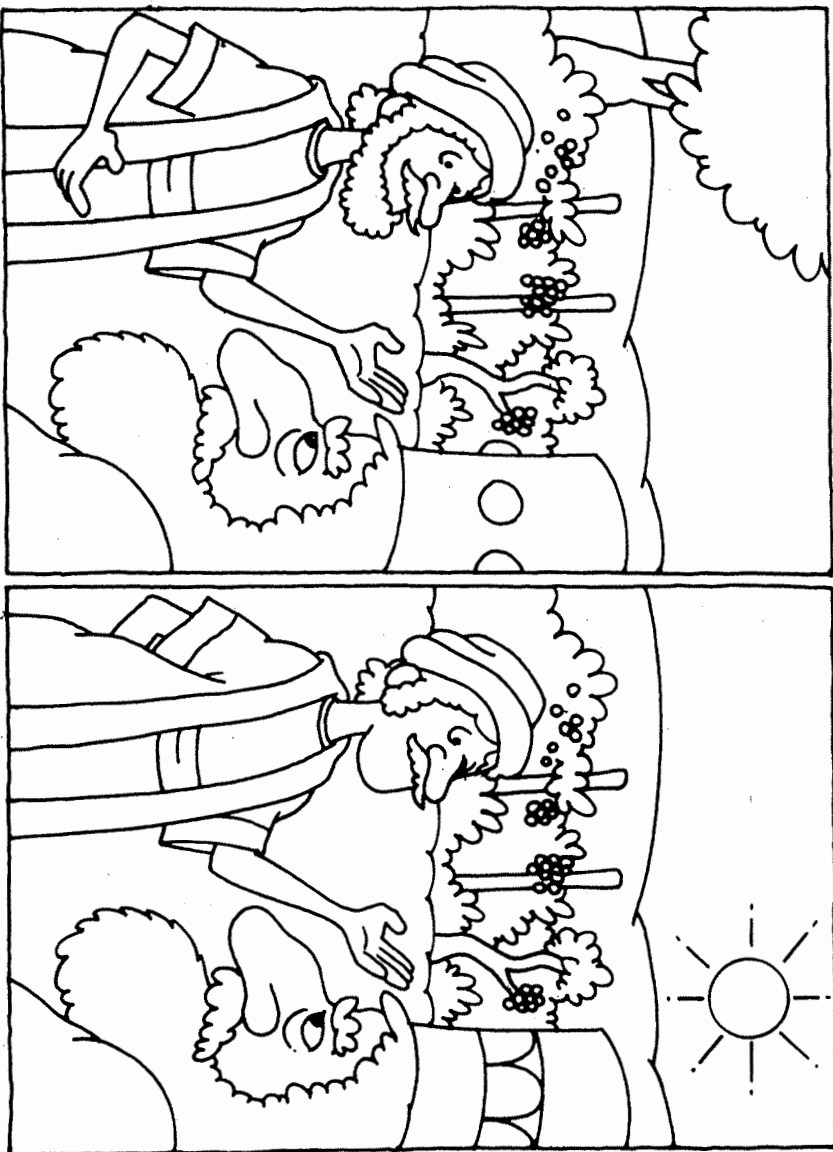

King Ahab and Queen Jezebel ruled Israel, but they were not good rulers. They didn't love God and they did bad things. One time King Ahab wanted a vineyard that belonged to someone else. Queen Jezebel had her soldiers kill the man so that the king could have the vineyard.

## Ahab asks to buy Naboth's vineyard

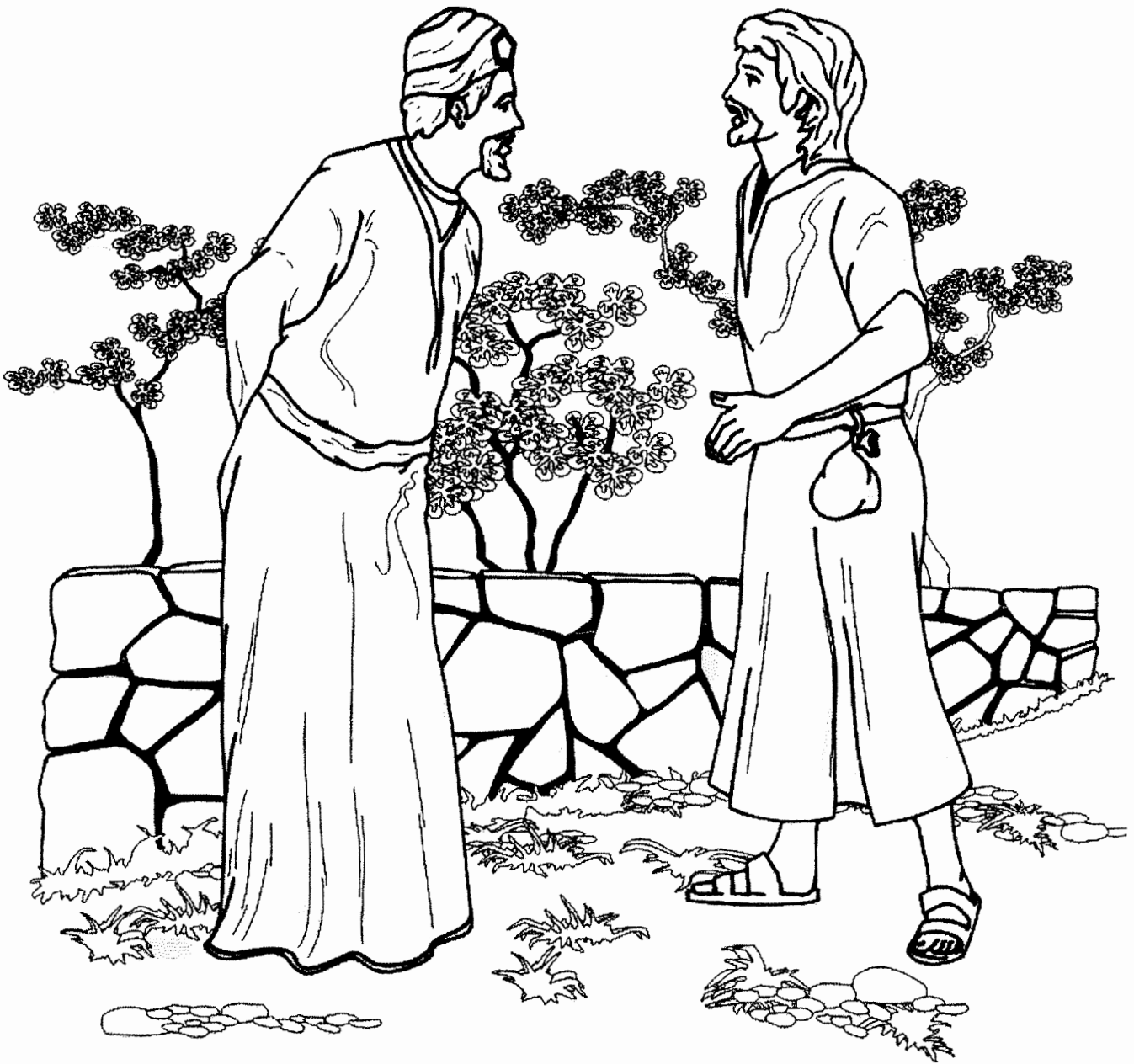

Graphics from Bible Clips

to the vineyard to take possession of it, and Elijah met Ahab for the last time. Elijah prophesied the violent deaths of Ahab and Jezebel and the extermination of their house (family). When Ahab repented at Elijah's word, the Lord had compassion on Ahab and said the prophecy would not come to pass during Ahab's lifetime but in the days of his son (I Kings 21).

### A. AHAB DESIRES NABOTH'S VINEYARD

- |                                                                                                          |                                    |
|----------------------------------------------------------------------------------------------------------|------------------------------------|
| 1. _____ Naboth, the Jezreelite, had a (21:1)                                                            | a. bread                           |
| 2. _____ It was near the palace of (21:1)                                                                | b. vineyard                        |
| 3. _____ Ahab told Naboth that he wanted the vineyard for a (21:2)                                       | c. fathers                         |
| 4. _____ He told Naboth that he would give him a better vineyard or give him its worth in (21:2)         | d. Naboth                          |
| 5. _____ Naboth said that the Lord forbid him to give away the inheritance of his (21:3)                 | e. sad (sullen)                    |
| 6. _____ Ahab went to his house (21:4)                                                                   | f. King Ahab                       |
| 7. _____ He laid down on his bed, turned away his face, and would eat no (21:4)                          | g. heavy (sullen), displeased      |
| 8. _____ Jezebel, his wife, asked him why his spirit was so (21:5)                                       | h. garden                          |
| 9. _____ When Ahab told her about the vineyard, Jezebel said she would give him the vineyard of (21:6-7) | i. elders, nobles in Naboth's city |
| 10. _____ She wrote letters with Ahab's seal to the (21:8)                                               | j. money                           |

### B. JEZEBEL'S PLOT AND THE LORD'S JUDGMENT

1. Jezebel instructed the elders and nobles to proclaim a \_\_\_\_\_ and give Naboth a seat of high honor. (I Kings 21:9)
2. They were to obtain two false witnesses to say Naboth had \_\_\_\_\_ God and the king. (I Kings 21:10)



3. After they accused Naboth, the elders were to carry Naboth out and \_\_\_\_\_ him that he might die. (I Kings 21:10)
4. When Jezebel received word from the elders and nobles that they had done as she instructed them, Jezebel told Ahab to take \_\_\_\_\_ of Naboth's vineyard, for he was dead. (I Kings 21:15)
5. The Lord told Elijah to go and meet Ahab in the \_\_\_\_\_ of Naboth. (I Kings 21:17-18)
6. The Lord instructed Elijah to tell Ahab that in the place where the \_\_\_\_\_ licked the blood of Naboth, the dogs would lick his blood. (I Kings 21:19)
7. Ahab called Elijah his \_\_\_\_\_. (I Kings 21:20)
8. Elijah said he had found Ahab because he had sold himself to work \_\_\_\_\_ in the sight of the Lord. (I Kings 21:20)
9. Because Ahab had done evil, the Lord would take away his \_\_\_\_\_. (I Kings 21:21)
10. Regarding Jezebel, the Lord said the \_\_\_\_\_ would eat Jezebel by the wall of Jezreel. (I Kings 21:23)
11. Regarding Ahab, the Lord said the \_\_\_\_\_ shall eat whoever belongs to Ahab and dies in the city, and the \_\_\_\_\_ shall eat whoever dies in the field. (I Kings 21:24)
12. Because Jezebel stirred him up, Ahab did wickedness in the sight of the Lord and behaved abominably in following \_\_\_\_\_. (I Kings 21:25-26)
13. When Ahab heard the words of the Lord, he \_\_\_\_\_ his clothes, put on \_\_\_\_\_, and \_\_\_\_\_. (I Kings 21:27)
14. Because Ahab humbled himself, the Lord would bring this evil (calamity) in the days of his \_\_\_\_\_. (I Kings 21:29)

## Year 2

### Week 90

#### Ahab is Punished

**Scriptures: I Kings 22:1-40**

**Key Verse: 1Ki 22:23 "Therefore look! The LORD has put a lying spirit in the mouth of all these prophets of yours, and the LORD has declared disaster against you."**

#### Key Points:

1. Ahab wanted to recapture cities that had been taken by Syria. King Jehoshaphat of Judah agreed to help him if the Lord approved of the battle.
2. About 400 false prophets predicted victory, but Jehoshaphat wanted to ask a prophet of the Lord.
3. Ahab reluctantly called for Micaiah, who in the past had prophesied evil for Ahab because Ahab was an evil man.
4. Micaiah told them to go into battle, but warned Ahab that the Lord had decided that Ahab would die.
5. Ahab disguised himself and wore armor for protection, but a random arrow mortally wounded him between his armor. He bled all day from the wound and died as the sun set.
6. Ahab's chariot was washed by a pool and the dogs drank the bloody water, just as Elijah had prophesied when he spoke to Ahab in Naboth's vineyard. A wicked king was dead.

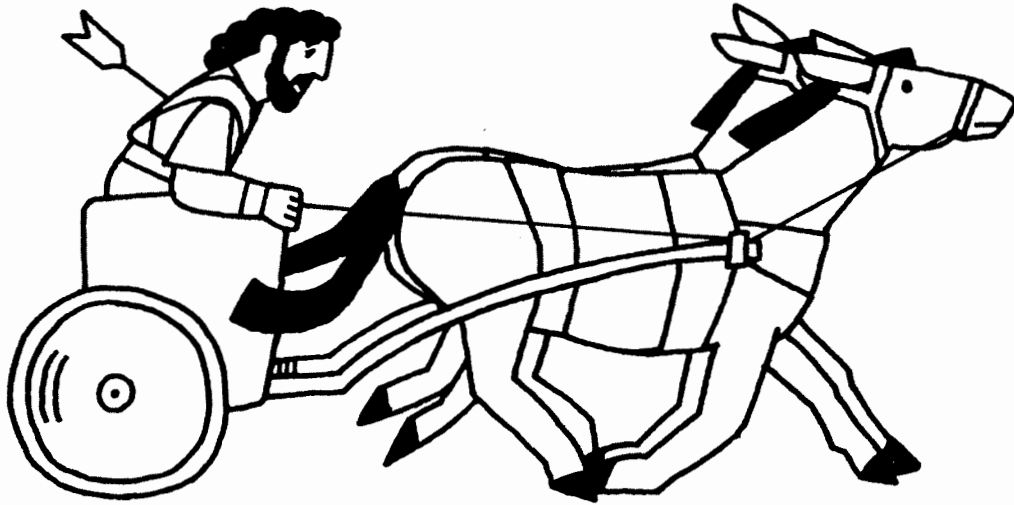

**King Ahab (I) Dies**  
1 Kings 22:29-40

(I)=1



**Micaiah Tells the Truth**

## Shield Spinner

### Supplies

copies of the Shield Spinner for each child  
crayons or markers  
scissors  
hole punch  
paper fasteners (1 per child)

### Directions

Color and cut out the shield and arrow. Punch a hole in the center of the shield and through the center of the arrow where indicated by the open circle. Attach the arrow to the center of the shield using a paper fastener. Spin the arrow. When it lands on a scene, retell that part of the story of Micaiah telling the truth.

- 1) King Ahab asked 400 prophets if he should go to battle, and they all said yes.
- 2) King Ahab asked Micaiah, a prophet of God, if he should go to battle. Micaiah warned him that he would die if he went into battle.
- 3) King Ahab threw Micaiah into prison for saying this and decided to go to battle anyway.
- 4) The king wore a disguise so the other army would not recognize him.
- 5) The king was killed in his chariot during the battle. Micaiah told the truth.

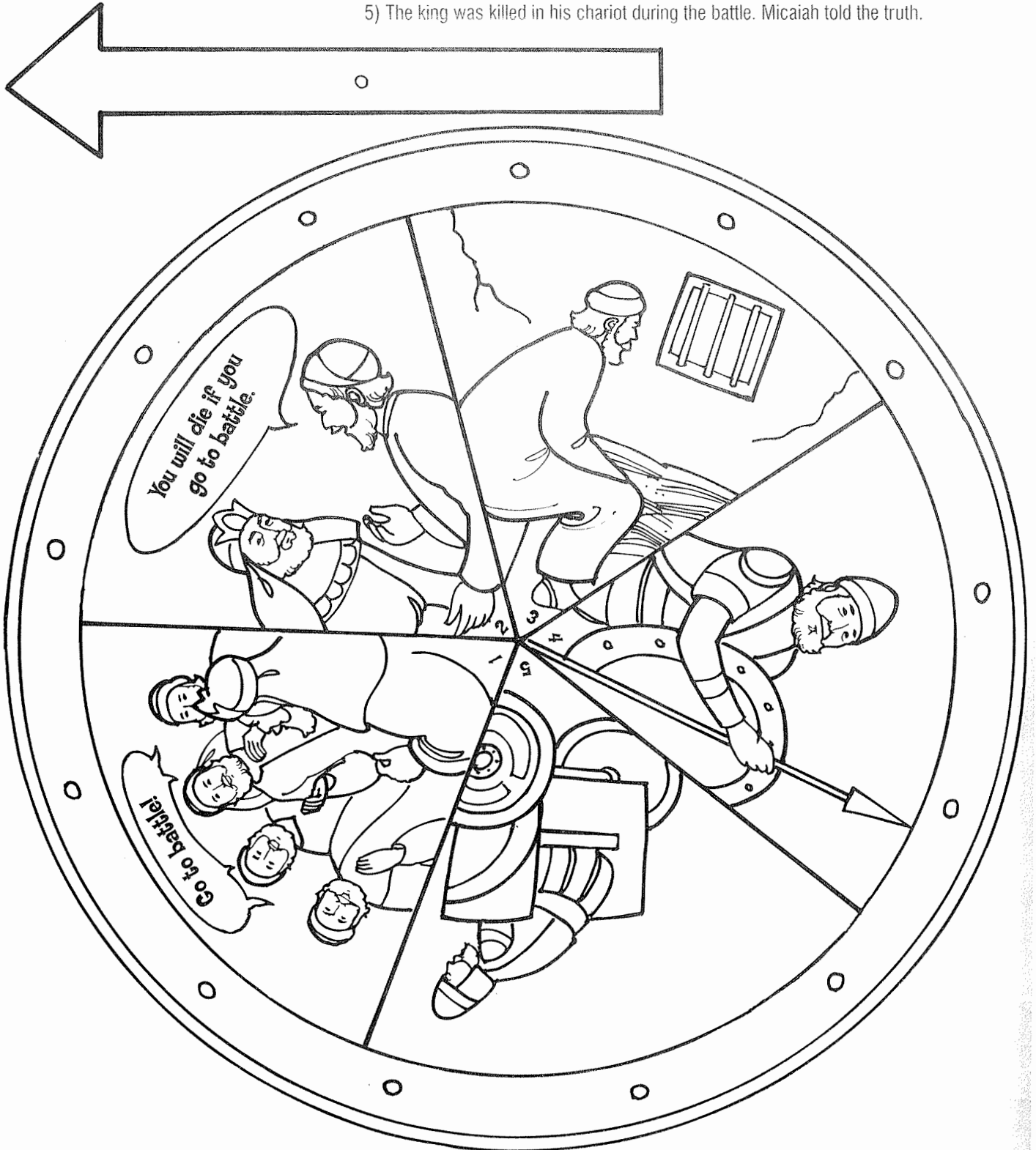

# Micaiah

1 Kings 22:1-37

# Speaking the Truth

King Jehoshaphat and King Ahab asked 400 prophets whether or not they should go to battle against the army of Aram. Only God's prophet Micaiah told the truth.

Using this code, write what Micaiah told the kings.

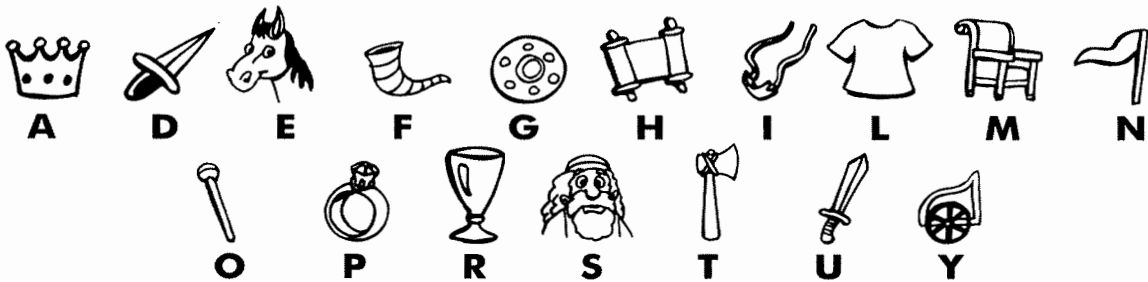

# KING AHAB DIES

I KINGS 22:29-40

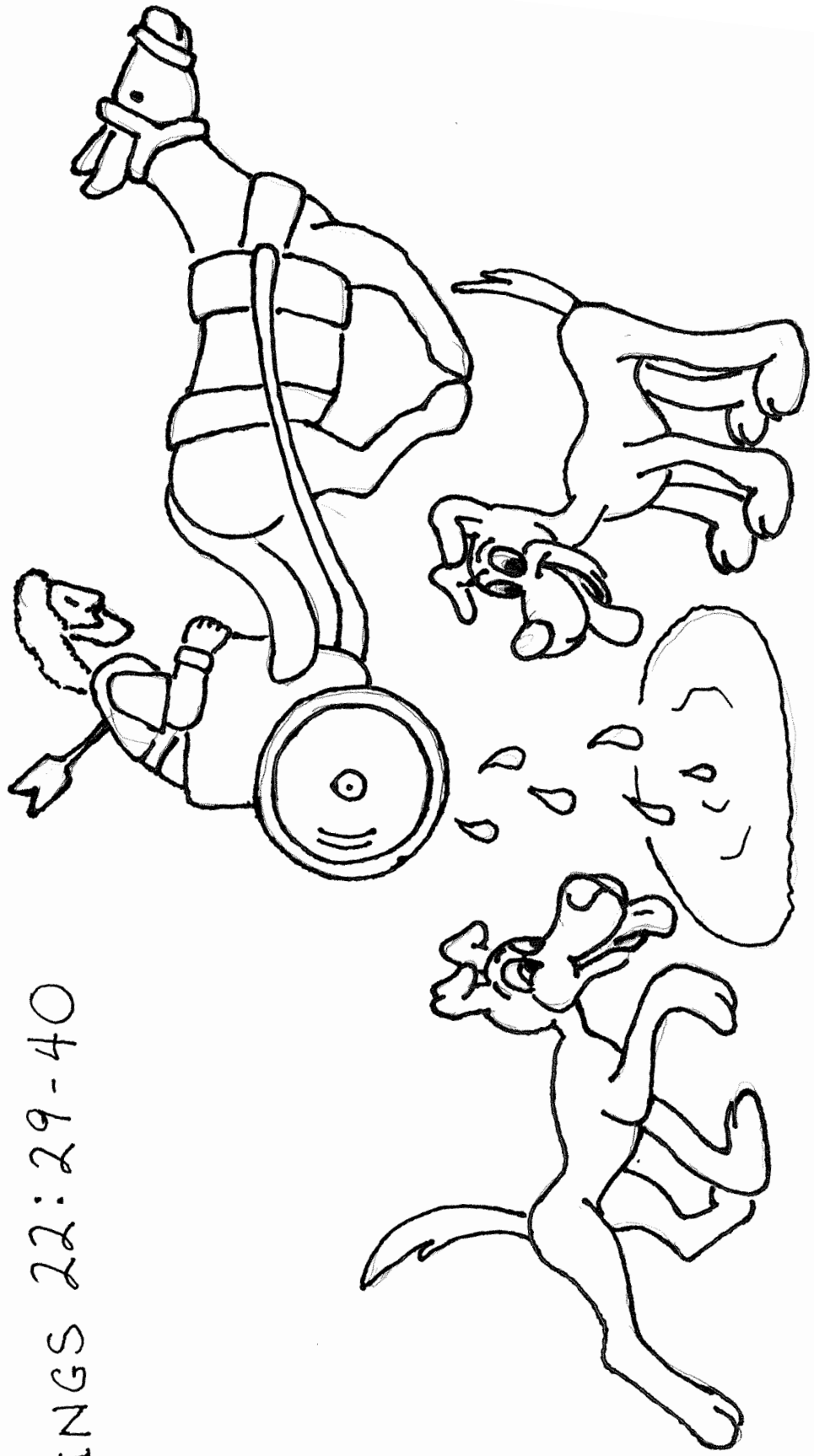

# God's Messenger, Elijah

I Kings 15 — II Kings 2

Elijah was God's prophet. "Prophet" means "messenger." Elijah told God's message to the people. He lived during a time when many evil kings ruled God's people and there was much idol worship in the land.

Match the names of the people who lived during Elijah's time by writing the correct number beside their description on the right. Then find each name in the word search puzzle.

- |                |       |                                                                          |
|----------------|-------|--------------------------------------------------------------------------|
| 1. AHAB        | _____ | Ahab hated him because he told the truth. (I Kings 22:8)                 |
| 2. AHAZIAH     | _____ | He took Elijah's place as God's prophet. (II Kings 2:15)                 |
| 3. AMON        | _____ | He wore horns while prophesying. (I Kings 22:11)                         |
| 4. ASA         | _____ | He was an evil king of Israel. He worshipped Baal. (I Kings 16:29-31)    |
| 5. BEN-HADAD   | _____ | Ahab and this king heard prophecies together. (I Kings 22:10)            |
| 6. ELISHA      | _____ | He became king after Ahab, his father, died. (I Kings 22:40)             |
| 7. JEHOSHAPHAT | _____ | He was the third king of Judah. His father was Abijam. (I Kings 15:8-11) |
| 8. JEZEBEL     | _____ | He hid prophets so Jezebel couldn't kill them. (I Kings 18:4)            |
| 9. MICAIAH     | _____ | He was killed because of his vineyard. (I Kings 21:1-14)                 |
| 10. NABOTH     | _____ | She was the evil wife of King Ahab. (I Kings 16:30-31; 18:4)             |
| 11. OBADIAH    | _____ | He was the governor where Micaiah was put in jail. (I Kings 22:26-27)    |
| 12. ZEDEKIAH   | _____ | King of Syria who attacked Samaria. (I Kings 20:1)                       |

P O I J Y U	T I W	P L I	Q W E	A Y T R E B	E W	U X
N A B O T H	Q S C	Z X B	T J S	S T K L M P	O F	S C
B Q W E R T	Z X V	B N E	H E G	D A I O	B X	T U
K A R	R E J	N V N	T Z H	F H K I	A K	H K
Q S H	W H X	J U H	S E D	J P F U	D G	A J
M O N A H	V A R	P H A	E B L	K A D I H Y	I C F I Q	
U Y H O L	E I W	N B D	O E I	L H Z T	A Z T K L	
Z X A C V	A Z S	H K A	J L K	M S O R	H R X E N	
M O I	T A Y	V G D	P I L I W	N O W E	S W D X	
R J A	F H G	X C O	Z S E D C	B H I W	K L E X	
V F C M B G	G A B I K A	L O P	V E Y T E	V E H Q	G Y Z E	
M O I C O V	N B V C S X	A S D	A H S I L E	C J U C	K M N H	
T U M C V N	H M N A Q W	Z Q W	W E R T Y U	X G O Z	V X F G	



have made Israel to sin. And of Jezebel the Lord said, 'The dogs shall eat Jezebel within the bounds of Jezreel.' Any one belonging to Ahab who dies in the city the dogs shall eat; and any one of his who dies in the country the birds of the air shall eat."

There was none who sold himself to do what was evil in the sight of the Lord like Ahab, whom Jezebel his wife urged on. He did very wickedly going after idols, as the Amorites had done.

And when Ahab heard those words, he tore his clothes, and put sackcloth upon his flesh, and fasted and lay in sackcloth, and went about dejectedly. And the word of the Lord came to Elijah the Tishbite, saying, "Have you seen how Ahab has humbled himself before me? Because he has humbled himself before me, I will not bring the evil in his days; but in his son's days I will bring the evil upon his house." ■

Soldiers search for Jezebel's body



## Ahab's family destroyed

1 Kings 21

Later on, Elijah's prophecies about Ahab and Jezebel came to pass. Ahab went to war against Syria with the King of Judah, Jehosaphat. He had been told by the prophet Micaiah that he would die in the battle.

So instead of dressing like a King normally would, he dressed like a soldier and Jehosaphat dressed like a King. But as he was riding in a chariot he was struck by a random arrow and badly wounded. He propped himself up for the rest of the day but was bleeding very heavily. That evening he died.

After he was buried, the soldiers took the chariot to Samaria to be cleaned, and there the dogs licked the blood of Ahab, just as Elijah had said.

God had also said that Ahab's family would be destroyed during his son's reign. When Jehoram, Ahab's son, was King, God chose Jehu, who was a commander in Israel's army, to take Jehoram's place.

Jehu killed not only the sons of Ahab, but even the king of Judah, who was working with him. Then he went to Jezreel where Jezebel was. She put on make-up and did her hair, perhaps hoping to influence Jehu. But he called to the servants in the tower where she was and they hated her enough to throw her out the window.

When the soldiers came back later to gather her body for burial, they could not find it. Just as God had said, the dogs had eaten it. ■

## Year 2

### Week 91

#### Elijah and the Fiery Chariot

**Scriptures: II Kings 2**

**Key Verse: 2Ki 2:9** And so it was, when they had crossed over, that Elijah said to Elisha, "Ask! What may I do for you, before I am taken away from you?" Elisha said, "Please let a double portion of your spirit be upon me."

#### **Key Points:**

1. As the time came for Elijah to go to be with God, Elisha did not want to leave him.
2. The sons of the prophets in Bethel, and in Jericho asked Elisha if he knew that his master would be taken from him that day. Elisha replied that he knew but did not want to talk about it.
3. When Elijah and Elisha reached the Jordan River, Elijah rolled up his mantle and when he struck the water, it divided so that they crossed on dry land.
4. Then Elijah asked what he could do for Elisha, and Elisha asked for a double portion of Elijah's power. Elijah said that was a difficult thing, but if Elisha saw Elijah taken away to heaven it would be given to him.
5. Because Elisha witnessed Elijah's departure in the chariot of fire, his request was granted. Elisha picked up Elijah's mantle, rolled it up, struck the water, and crossed back over.
6. The men of Jericho spent three days looking for Elijah, even though Elisha told them Elijah was with God.
7. Elisha performed two miracles that confirmed he was God's selected prophet. He restored water for a city. In Bethel, some young people disrespected Elisha because he was bald. Elisha pronounced a curse in the name of the Lord, and bears attacked 42 of the youths.

# ELIJAH IS TAKEN TO HEAVEN

## (2 KINGS 2:1-11)

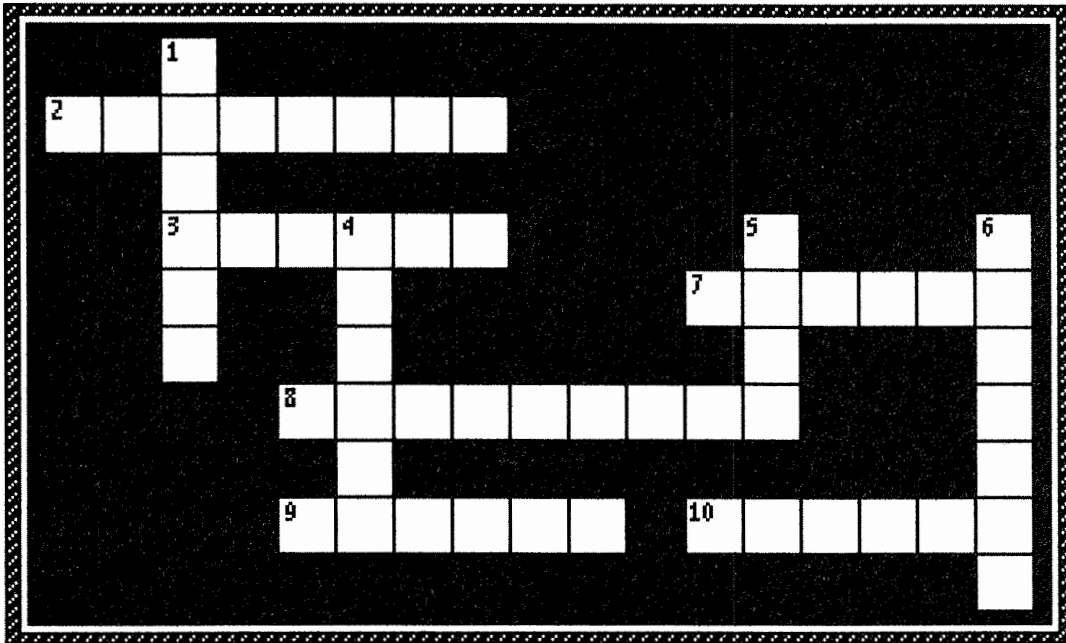

- 9 ACROSS "And it came to pass, when the LORD was about to take up Elijah into heaven by a whirlwind, that Elijah went with \_\_\_\_\_ from Gilgal." **2 KINGS 2:1**
- 4 DOWN "Then Elijah said to Elisha, 'Stay here, please, for the LORD has sent me on to \_\_\_\_\_.' And Elisha said, 'As the LORD lives, and as your soul lives, I will not leave you!' " **2 KINGS 2:2**
- 2 ACROSS "And the sons of the \_\_\_\_\_ who were at Bethel came out to Elisha, and said to him, 'Do you know that the LORD will take away your master from over you today?' " **2 KINGS 2:3**
- 6 ACROSS "Then Elijah said to him, 'Elisha, stay here, please, for the LORD has sent me on to \_\_\_\_\_.' " **2 KINGS 2:4**
- 10 ACROSS "Then \_\_\_\_\_ said to him, 'Stay here, please, for the LORD has sent me on to the Jordan.' " **2 KINGS 2:6**
- 1 DOWN "And fifty men of the sons of the prophets went and stood facing them at a distance, while the two of them stood by the \_\_\_\_\_." **2 KINGS 2:7**
- 7 ACROSS "Now Elijah took his \_\_\_\_\_, rolled it up, and struck the water; and it was divided this way and that, so that the two of them crossed over on dry ground." **2 KINGS 2:8**
- 3 ACROSS "And so it was, when they had crossed over, that Elijah said to Elisha, 'Ask! What may I do for you, before I am taken away from you? And Elisha said, 'Please let a \_\_\_\_\_ portion of your spirit be upon me.' " **2 KINGS 2:9**
- 5 DOWN "So he said, 'You have asked a \_\_\_\_\_ thing. Nevertheless, if you see me when I am taken from you, it shall be so for you; but if not, it shall not be so.' " **2 KINGS 2:10**
- 8 ACROSS "Suddenly a chariot of fire appeared with horses of fire, and separated the two of them; and Elijah went up by a \_\_\_\_\_ into heaven." **2 KINGS 2:11**

cloud



**Elijah and the  
chariot of fire**

cloud



**Elijah and the  
chariot of fire**

# ELISHA CROSSES THE RIVER

## (2 KINGS 2:13-15)

### MEMORY VERSE:

*"Now when the sons of the prophets who were from Jericho saw him, they said, 'The spirit of Elijah rests on Elisha.' "* 2 KINGS 2:15

### FILL IN THE BLANK:

1. Elisha "took the \_\_\_\_\_ of Elijah that had fallen from him, and struck the water." 2 KINGS 2:13

### TRUE OR FALSE:

2. He "went back and stood by the bank of the Jordan." 2 KINGS 2:13  
TRUE OR FALSE

### FILL IN THE BLANK:

3. "Then he took the mantle of Elijah that had fallen from him, and struck the \_\_\_\_\_." 2 KINGS 2:14

### TRUE OR FALSE:

4. He said, "Where is the LORD God of Elijah?" 2 KINGS 2:14  
TRUE OR FALSE
5. When he struck the water, nothing happened. 2 KINGS 2:14  
TRUE OR FALSE
6. "Elisha crossed over." 2 KINGS 2:14  
TRUE OR FALSE

### FILL IN THE BLANKS:

7. "Now when the sons of the prophets who were from Jericho saw him, they said, 'The \_\_\_\_\_ of Elijah rests on Elisha.' " 2 KINGS 2:15
8. "They came to meet him, and \_\_\_\_\_ to the ground before him." 2 KINGS 2:15

# ELIJAH IS TAKEN TO HEAVEN

## (2 KINGS 2:1-11)

### MEMORY VERSE:

*"Suddenly a chariot of fire appeared with horses of fire, and separated the two of them; and Elijah went up by a whirlwind into heaven." 2 KINGS 2:11*

### TRUE OR FALSE:

1. "And it came to pass, when the LORD was about to take up Elijah into heaven by a whirlwind, that Elijah went with Elisha from Gilgal." **2 KINGS 2:1**

### TRUE OR FALSE

### UNDERLINE THE CORRECT ANSWER:

2. "Then Elijah said to Elisha, 'Stay here, please, for the LORD has sent me on to Bethel.' And Elisha said..." **2 KINGS 2:2**
  - a. As the LORD lives, and as your soul lives, I will not leave you!
  - b. I will stay!
3. "And the sons of the prophets who were at Bethel came out to Elisha, and said to him..." **2 KINGS 2:3**
  - a. Do you know that the LORD will take away your master from over you today?
  - b. What are you doing here?
4. "Then Elijah said to him, 'Elisha, stay here, please, for the LORD has sent me on to Jericho.' And he said..." **2 KINGS 2:4**
  - a. As the LORD lives, and as your soul lives, I will not leave you!
  - b. I will stay!
5. "And the sons of the prophets who were at Jericho came to Elisha, and said to him..." **2 KINGS 2:5**
  - a. Do you know that the LORD will take away your master from over you today?
  - b. What are you doing here?
6. "Then Elijah said to him, 'Stay here, please, for the LORD has sent me on to the Jordan.' And he said..." **2 KINGS 2:6**
  - a. As the LORD lives, and as your soul lives, I will not leave you!
  - b. I will stay!

### FILL IN THE BLANKS:

7. "And fifty men of the sons of the prophets went and stood facing them at a distance, while the two of them stood by the \_\_\_\_\_." **2 KINGS 2:7**
8. "Now Elijah took his mantle, rolled it up, and struck the water; and it was divided this way and that, so that the two of them crossed over on \_\_\_\_\_ ground." **2 KINGS 2:8**
9. "And so it was, when they had crossed over, that Elijah said to Elisha, 'Ask! What may I do for you, before I am taken away from you? And Elisha said, 'Please let a \_\_\_\_\_ portion of your spirit be upon me.' " **2 KINGS 2:9**
10. "So he said, 'You have asked a \_\_\_\_\_ thing. Nevertheless, if you see me when I am taken from you, it shall be so for you; but if not, it shall not be so.' " **2 KINGS 2:10**
11. "Suddenly a chariot of fire appeared with horses of fire, and separated the two of them; and Elijah went up by a \_\_\_\_\_ into heaven." **2 KINGS 2:11**

# ELISHA CROSSES THE RIVER

(2 KINGS 2:13-15)

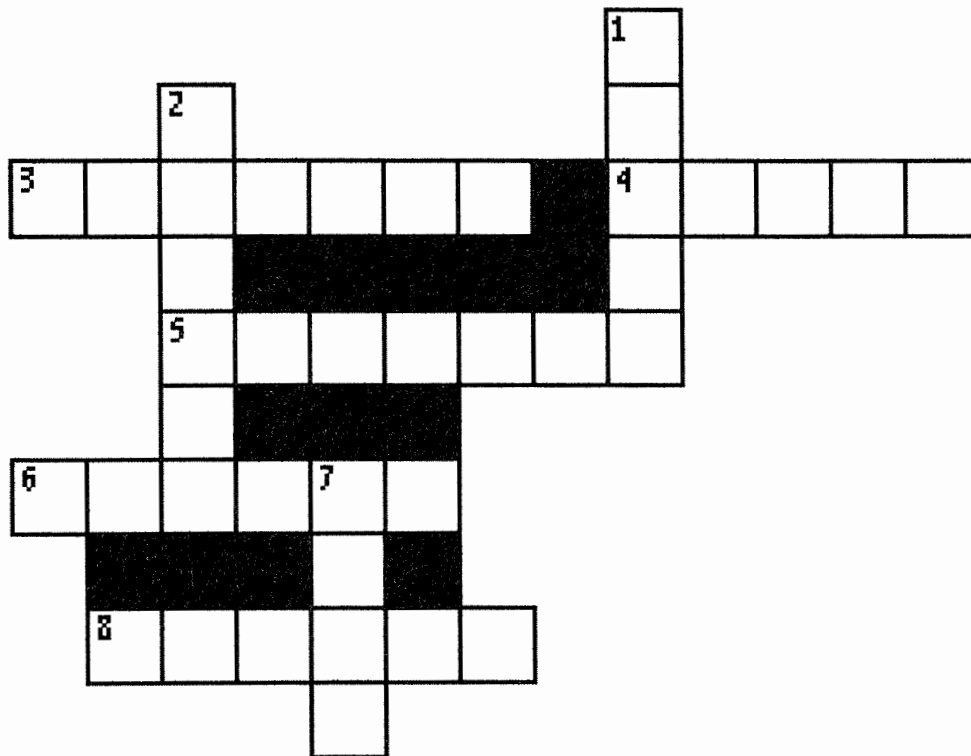

- 6 ACROSS Elisha "took the \_\_\_\_\_ of Elijah that had fallen from him, and struck the water." **2 KINGS 2:13**
- 2 DOWN He "went back and stood by the bank of the \_\_\_\_\_." **2 KINGS 2:13**
- 4 ACROSS "Then he took the mantle of Elijah that had fallen from him, and struck the \_\_\_\_\_." **2 KINGS 2:14**
- 7 DOWN He said, "Where is the \_\_\_\_\_ God of Elijah?" **2 KINGS 2:14**
- 5 ACROSS "When he also struck the water, it was \_\_\_\_\_ this way and that." **2 KINGS 2:14**
- 3 ACROSS "Elisha \_\_\_\_\_ over." **2 KINGS 2:14**
- 8 ACROSS "Now when the sons of the prophets who were from Jericho saw him, they said, 'The \_\_\_\_\_ of Elijah rests on Elisha.'" **2 KINGS 2:15**
- 1 DOWN "They came to meet him, and \_\_\_\_\_ to the ground before him." **2 KINGS 2:15**

# ELISHA CROSSES THE RIVER

(2 KINGS 2:13-15)

E K Q Q V R X O A Q C P A Z U  
L P H S N E L O R D G O D Z A  
M R V P L A W W V S J U Z N F  
G U E I R X D H C Q D E W O B  
M Y S T N O E R A V W T E K F  
B H V P A O P Q O P Y D M O T  
A F G M G W L H L J J E D B Q  
P K S B D S V I E B L D W H H  
M S N B C L D L O T T I Q F A  
W T P O P R D H N Q S V X V U  
N G B I K K O A Z J N I I I U  
G E K H R W M S M I A D T O T  
K Y K S S I Z T S C S N A N T  
B G O S P V T Y F E L D L H D  
Y M J R P J Z O M T D R B I D

BOWED  
CROSSED  
DIVIDED  
ELISHA

JORDAN  
LORD GOD  
MANTLE

PROPHETS  
SPIRIT  
WATER

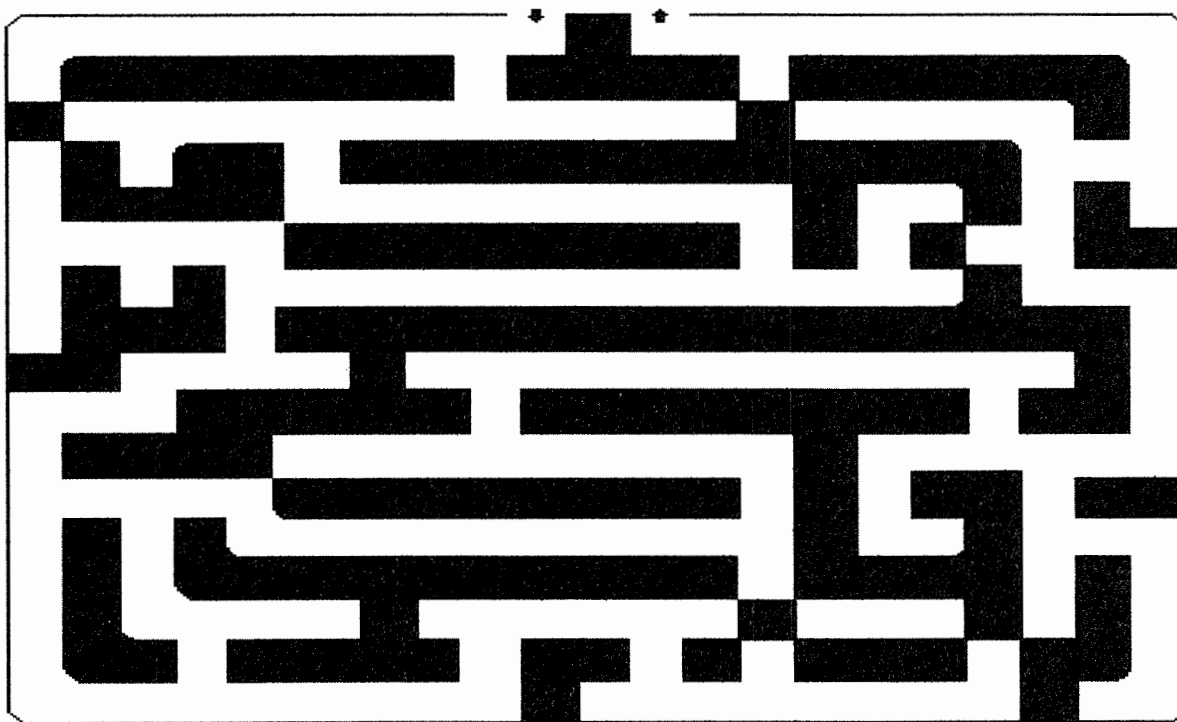



# ELISHA CROSSES THE RIVER

(2 KINGS 2:13-15)



“And he took the mantle of Elijah that fell from him, and smote the waters, and said, Where is the LORD God of Elijah? and when he also had smitten the waters, they parted hither and thither: and Elisha went over.”

**2 KINGS 2:14**

# Elijah

## A Mighty Prophet

I Kings 17-18; II Kings 2:1-12



### Memory Verse

The prophet Elijah stepped forward and prayed: "O Lord, God of Abraham, Isaac and Israel, let it be known today that You are God in Israel."

I Kings 18:36 (NIV)

### For the Teacher

Duplicate a word search puzzle for each child. Provide pencils or markers. If any of the children are unfamiliar with this type of puzzle, show them how to locate the words and circle them. The answers are on page 61. See if the children can think of a sentence about Elijah using each word.

**HINT:** If you lack enough table space for all the children, let them sit on the floor and use their chair seats for solving the puzzles or making the crafts.

### Introduction

Wicked King Ahab led the Israelites to worship the idol Baal. Elijah warned Ahab, "God will punish you for sinning. There will be no rain until I say so." It didn't rain for three years, causing a great famine. Elijah proved to the priests of Baal that there is only one real God. Elijah called down fire from heaven. Then he prayed, and the rains fell. King Ahab and Queen Jezebel were very angry with Elijah and wanted to kill him. He had to run for his life. But God protected him and gave Elijah food during the famine.

### Prophet Word Search

Look at the word list about Elijah's life. Circle the words as you find them in the puzzle. They may read up, down, across, and diagonally. Many words share some of the same letters. How many of these words can you use in sentences to describe Elijah?

Ahab	turn	son
Baal	widow	cave
mantle	fire	share
meat	horses	dead
ravens	oil	Elisha
altar	rain	down
chariot	ran	

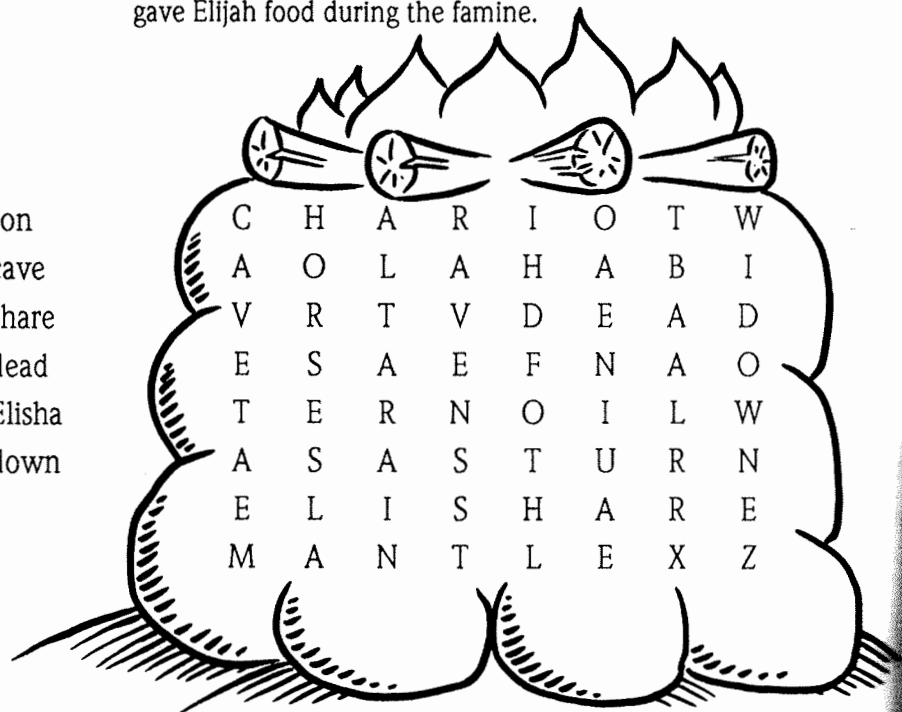

# ELIJAH IS TAKEN TO HEAVEN

(2 KINGS 2:1-11)

I X G P M R Z S Y Q S S E A M K P D W L  
O Y F W E Y C C J O R D A N X Y L I J J  
X L Z C Z G L N M L T Y U I U H O M H T  
K N A P I N W P B P V X V P V F P O N B  
E D N R I W C N O I T R O P E L B U O D  
Y L E H T E B M A N T L E Q E Q D O F V  
T C S F D E A C P V G F E F Z X Q F G Q  
E V H D Z Y R X R G W L F R U H J U I O  
Z O U N N Z Z I Y Y I L P R O P H E T S  
Q S S I Z R S C F S D K I C U M J D E V  
V K Y W V G D X H F K I U G I G T I G Y  
L L J L U F G A R Q O Q H O X Q I V W X  
S D N R D H P O E D A T I W Q W R E K C  
R F D I W Y A P H O G S O J B G I M O J  
S A Y H E I C J X C S S P I V X P N I N  
B B I W E F V R I O I O K V R W S B L B  
B R B M B B U E V L A R R H B A C A D L  
Z N L E D L I M T K E E E Y W D H S S L  
F E O T V A P H O P U Z E J Y I M C R D  
W W U L N E N Y J Z K P N G U C V P J N

**BETHEL**

**ELISHA**

**PORTION**

**CHARIOT OF FIRE**

**JERICH0**

**PROPHETS**

**DOUBLE**

**JORDAN**

**WHIRLWIND**

**ELIJAH**

**MANTLE**

**Directions:**

Trace pattern of map (page 27) on a piece of light green construction paper. Paint lambs and water with the paints. When dry, cover map with the plastic to preserve it. Cut on dotted lines into three pieces. Let the children put the puzzle together and take it apart to show how the people of Israel were to be as sheep without a shepherd.

Use this in a learning center. Have a Bible for the children to read the story. Have a set of two or three simple questions for them to answer. These could be true/false. Cover questions with the plastic and let the children circle the correct answer with a wipe-off crayon. This activity can be used again and again.

## Elijah and Elisha Cross the Jordan

*2 Kings 2:1-8*

**Materials needed:**

Construction paper—green, blue, scrap of color  
Crayons, felt-tip pens, or tempera paints  
Clear adhesive-backed plastic  
Brass paper fastener  
Glue

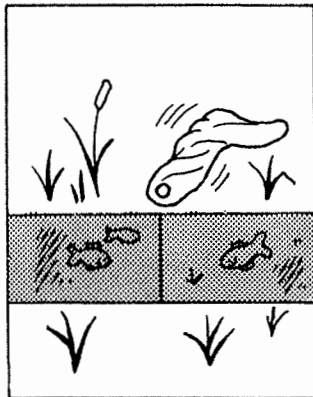
**Directions:**

Cut two pieces of blue construction paper, 7 inches by 2¼ inches. Score and fold each piece 1 inch from end. Trace fish and objects on strips and color. Cover strips with pieces of clear adhesive-backed plastic, leaving the 1-inch tabs. Trace plants, etc., on green paper and color. Trace and cut robe from white or other color. Glue 1-inch tabs of blue strips to backs of green so ends of blue meet in middle of page. Fasten robe above strips of water with brass paper fastener as shown. Use as a visual, "striking" water with robe and turning back water at the proper time in the story.

## Elijah Goes to Heaven

*2 Kings 2:9-11*

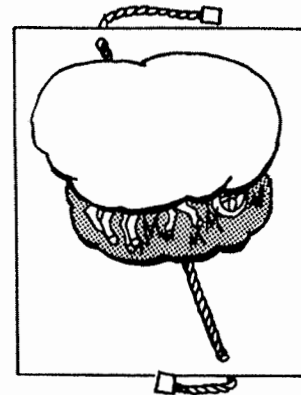
**Materials needed:**

Construction paper—dark blue, white  
Crayons, felt tip pens, or tempera paints  
Yarn—dark blue

**Directions:**

Trace the picture of Elijah and the chariot and horses (pattern on page 28) onto white construction paper. Color the picture. Punch two holes in the dark blue paper, as shown. Glue the center section of an 18-inch piece of dark blue yarn across the picture. Optional: Cut a second piece of paper to mount on the back of the picture for strength. When dry, thread yarn through the holes. Finish yarn ends with small paper tags. Cut cloud from white paper and glue at top and side edges to background as shown in sketch. Elijah will now "go to Heaven" by sliding the picture under the cloud. Glue a second piece of construction paper under background for durability. Make sure yarn can be moved freely.

## Bible-Times Furniture

**Materials needed:**

Tagboard  
Glue  
Crayons  
Scrap of orange paper  
Wooden bead

**Directions:**

Cut the furniture from tagboard and follow directions on patterns (page 29) for folding. Glue the two headboards and the back of the chair in place. When dry, color with brown crayon. The lamp is

**Year 2**

**Week 92**

## **Two Boys Saved and the Shunamite Woman**

**Scriptures: II Kings 4:1-37**

**Key Verses: 2Ki 4:9-10 "Look now, I know that this is a holy man of God, who passes by us regularly. "Please, let us make a small upper room on the wall; and let us put a bed for him there, and a table and a chair and a lampstand; so it will be, whenever he comes to us, he can turn in there."**

### **Key Points:**

1. A widow sought Elisha for help. Her husband's death had left the family in debt, and her two sons were about to be sold as slaves to pay the bill.
2. Elisha asked what she had in the house, and she replied that she had only one jar of oil. Elisha told her to gather many, many containers and fill them from her oil.
3. The family borrowed a large number of containers, and the oil did not run out until all of them were full. She was able to sell the oil to pay her debt.
4. Elisha often traveled through Shunem. A husband and wife shared food with him, and arranged a room for Elisha in their home there.
5. Elisha asked if there was anything he could do to repay their hospitality, but the woman asked for nothing.
6. Elisha asked his servant, Gehazi, who mentioned that she had no son. Elisha told the woman that she would have a son the next year.
7. As promised, the boy was born. Several years passed. One day the child fell ill and died.
8. In great distress, the woman traveled to Elisha. He sent Gehazi ahead of them with instructions to lay Elisha's staff on the boy's face.
9. The boy did not revive when the staff touched him, so Gehazi returned to Elisha and told him that the child did not awaken.
10. Elisha came to the house and prayed to God. He touched the boy, and laid on him two times, and the boy revived.

# ELISHA HELPS A POOR WIDOW

(2 KINGS 4:1-7)



'So she went from him, and shut the door upon her and upon her sons, who brought *the vessels* to her; and she poured out.'

**2 KINGS 4:5**

Elisha's Room



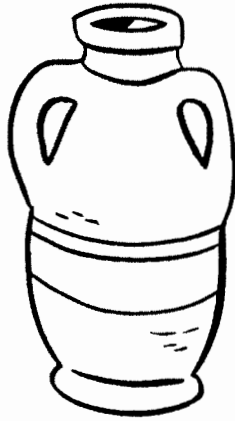



# ELISHA HELPS A POOR WIDOW

## (2 KINGS 4:1-7)

### MEMORY VERSE:

**"Go, sell the oil and pay your debt; and you and your sons live on the rest." 2 KINGS 4:7**

### TRUE OR FALSE:

1. "A certain woman of the wives of the sons of the prophets cried out to Elisha, saying, 'Your servant my husband is dead, and you know that your servant feared the LORD. And the creditor is coming to take my two sons to be his slaves.' " **2 KINGS 4:1**

**TRUE OR FALSE**

### CIRCLE THE CORRECT WORDS:

2. "So Elisha said to her, 'What shall I do for you? Tell me, what do you have in the house?' And she said, 'Your maidservant has nothing in the house but a jar of \_\_\_\_\_.' " **2 KINGS 4:2**
3. "Then he said, 'Go, borrow vessels from everywhere, from all your neighbors-\_\_\_\_\_ vessels; do not gather just a few.' " **2 KINGS 4:3**

### TRUE OR FALSE:

4. "And when you have come in, you shall shut the door behind you and your sons; then pour it into all those vessels, and set aside the full ones." **2 KINGS 4:4**
- TRUE OR FALSE**
5. But she would not do those things which Elisha had told her to do. **2 KINGS 4:5**
- TRUE OR FALSE**

### CIRCLE THE CORRECT WORDS:

6. "Now it came to pass, when the vessels were full, that she said to her son, 'Bring me another vessel.' And he said to her, 'There is not another.' So the oil \_\_\_\_\_." **2 KINGS 4:6**
7. "Then she came and told the man of God. And he said, 'Go, \_\_\_\_\_ the oil and pay your debt; and you and your sons live on the rest.' " **2 KINGS 4:7**

# The Oil that Didn't Run Out

II Kings 4:1-7

There was a mother and her two boys who did not have enough money to pay their bills. All they had was a little jar of oil. The mother asked Elisha what to do. Elisha told her to borrow all the jugs and pots and jars she could find and to pour the oil into them. God multiplied the oil so it did not run out, but it filled all the containers. The mother sold the oil and paid the bills.

The hidden words come from this story in II Kings 4:1-7. The code following each word tells the coordinates where one of the letters of the word is found in the puzzle. After you have found all the hidden words, start at the upper left and use all the leftover letters to fill in the blanks at the bottom of the page with the words of a Bible verse which tells what God can do.

ART (2K)		A B C D E F G H I J K L M N		OIL (11C)
ASIDE (8G)				PASS (14E)
BONDMEN (9I)	1	F G O S L E S S E V T R T W	1	POT (5F)
BRING (12E)	2	I T N H G O T D N S R N B O	2	POURED (7A)
BROUGHT (13G)	3	D T H I I E A S E N A N E G	3	PROPHETS (3F)
CERTAIN (10G)	4	E L I S H A Y R E V A S D S	4	REST (4H)
CHILDREN (9D)	5	R H A P O T E R R W S L L N	5	SAVE (4K)
CREDITOR (6B)	6	U C O B P N D E E H O U S E	6	SELL (13H)
DEAD (8L)	7	O R I M M L S P U I O N S I	7	SERVANT (5I)
DEBT (4M)	8	P E E D I S A T B C S D K G	8	SET (8K)
DOOR (11A)				SHUT (8H)
ELISHA (4B)	9	L D S H B H I B O H E L E H	9	SONS (6F)
EMPTY (8C)	10	L I C E R T A I N A T W O B	10	STAYED (3G)
GOD (12F)	11	R T O U I K D L D A I D E O	11	THING (3D)
HIM (9F)	12	O O N E N O T L M V M R H R	12	TWO (10M)
HOUSE (6L)	13	B R O U G H T E E I R O T S	13	VESSELS (1J)
KNOWEST (7L)	14	Y S E D P A S S N V E L W N	14	WHICH (7J)
LORD (12L)		A B C D E F G H I J K L M N		WIVES (12J)
NEIGHBORS (13N)				WOMAN (12K)

**HIDDEN VERSE:** \_\_\_\_\_  
 \_\_\_\_\_  
 \_\_\_\_\_

# ELISHA HELPS A POOR WIDOW

(2 KINGS 4:1-7)

F A T K R B X N S S R A T T E  
T D F N F Z W H Z L O F J O C  
N B U Z N U P E G E Z J G L U  
B D Y Y B Z L A I S G A A S C  
T L I V E V K L K S E H A R J  
I L Z E R X Y T W E C D Z T T  
T V S I L O N E B V J W T R H  
L G M O N I B N N U X Y U X H  
K L M W N A S H A S P F J Z L  
W J H Z V S J H E M D Z Q U Z  
Q C W L N E J V A M O W K O R  
I T V M O L A D K J J W K I L  
E U V O L L G I C B P G V L P  
Q N N B S O J L H O D Z H O J  
G Y C D O H V Q P J Q T S W Z

ELISHA

OIL

SONS

FULL

SELL

VESSELS

JAR

SLAVES

WOMAN

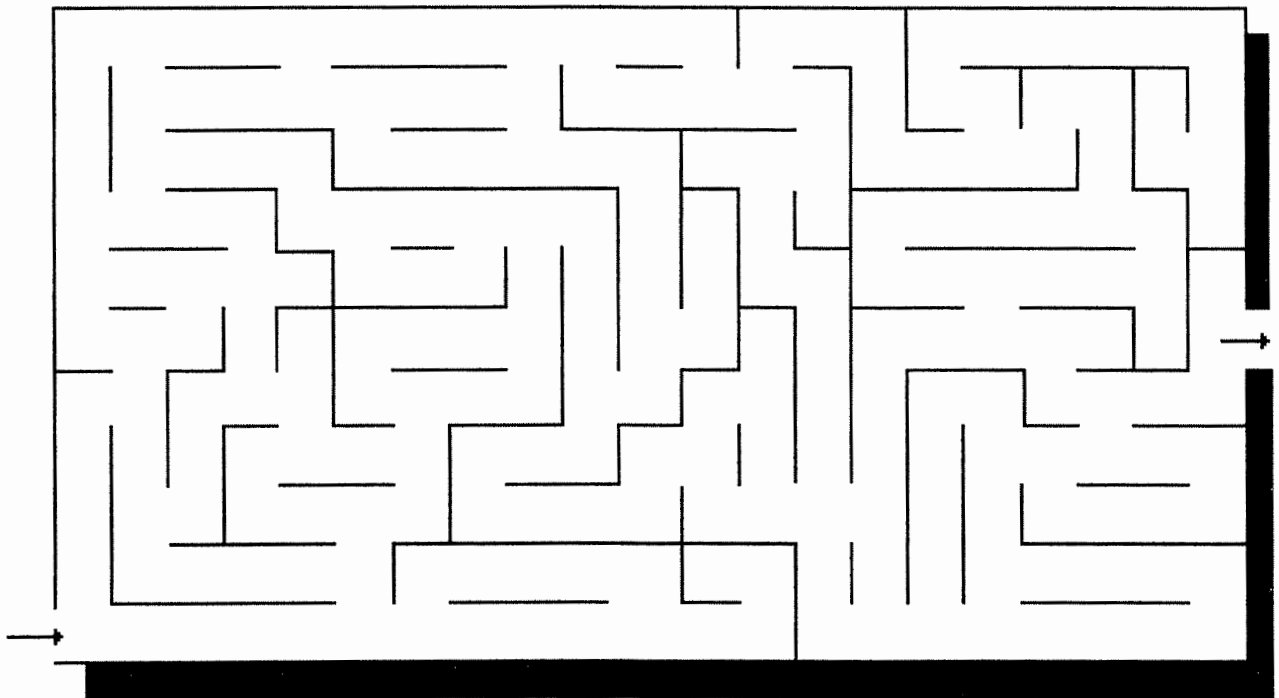

# ELISHA HELPS A POOR WIDOW

(2 KINGS 4:1-7)

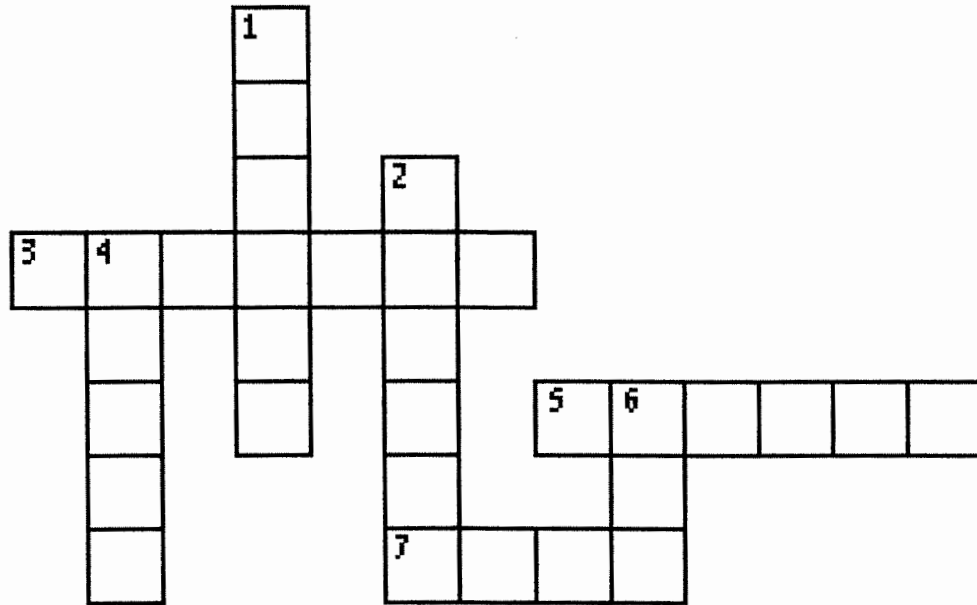

- 2 DOWN "A certain woman of the wives of the sons of the prophets cried out to Elisha, saying, 'Your servant my husband is dead, and you know that your servant feared the LORD. And the creditor is coming to take my two sons to be his \_\_\_\_.'" **2 KINGS 4:1**
- 6 DOWN "So Elisha said to her, 'What shall I do for you? Tell me, what do you have in the house?' And she said, 'Your maidservant has nothing in the house but a jar of \_\_\_\_.'" **2 KINGS 4:2**
- 4 DOWN "Then he said, 'Go, borrow vessels from everywhere, from all your neighbors- \_\_\_\_ vessels; do not gather just a few.'" **2 KINGS 4:3**
- 3 ACROSS "And when you have come in, you shall shut the door behind you and your sons; then pour it into all those \_\_\_\_, and set aside the full ones." **2 KINGS 4:4**
- 5 ACROSS "So she went from him and shut the door behind her and her sons, who brought the vessels to her; and she \_\_\_\_ it out." **2 KINGS 4:5**
- 1 DOWN "Now it came to pass, when the vessels were full, that she said to her son, 'Bring me another vessel.' And he said to her, 'There is not another.' So the oil \_\_\_\_." **2 KINGS 4:6**
- 7 ACROSS "Then she came and told the man of God. And he said, 'Go, \_\_\_\_ the oil and pay your debt; and you and your sons live on the rest.'" **2 KINGS 4:7**

# ELISHA AND THE SHUNAMMITE WOMAN

(2 KINGS 4:8-17)

## MEMORY VERSE:

*"And she said to her husband, 'Look now, I know that this is a holy man of God, who passes by us regularly.' "* 2 KINGS 4:9

## TRUE OR FALSE:

1. "Now it happened one day that Elisha went to Shunem, where there was a notable woman, and she constrained him to eat some food. So it was, as often as he passed by, that he turned in there to eat some food." 2 KINGS 4:8

TRUE OR FALSE

2. "And she said to her husband, 'Look now, I know that this is a holy man of God, who passes by us regularly.' " 2 KINGS 4:9

TRUE OR FALSE

## FILL IN THE BLANKS:

3. She said, "Please, let us make a small upper \_\_\_\_\_ on the wall; and let us put a bed for him there, and a table and a chair and a lampstand; so it will be, whenever he comes to us, he can turn in there." 2 KINGS 4:10

4. Elijah said to Gehazi his servant, 'Call this Shunammite woman.' When he called her, she stood before him. And he said to him, 'Say now to her, "Look, you have been concerned for us with all this \_\_\_\_\_. What can I do for you?" ' " 2 KINGS 4:12-13

## TRUE OR FALSE:

5. "Gehazi answered, 'Actually, she has no son, and her husband is old.' " 2 KINGS 4:14

TRUE OR FALSE

## FILL IN THE BLANK:

6. "Then he said, 'About this time next year you shall embrace a \_\_\_\_\_.' And she said, 'No, my lord. Man of God, do not lie to your maidservant!' " 2 KINGS 4:16

## TRUE OR FALSE:

7. And the woman did not conceive, and bore no son when the appointed time had come, of which Elisha had told her. 2 KINGS 4:17

TRUE OR FALSE



# ELISHA AND THE SHUNAMMITE WOMAN

(2 KINGS 4:8-17)

V M X R H Q Y Q P J X J L G K  
 L O O F G R N F N Y C Q M T I  
 C N P W B O Y N U G B L S E Y  
 L Y O P E D T F L A H S I L E  
 V D O S L N O T N H B Z O L T  
 N V R W B C P G Z D Y P A S F  
 M U J V A X S H F E O Q L V Z  
 J X Y G T R J D R O U O K P B  
 C S M J O B O A H S N I F Z C  
 M S G T N I C O H U Z A N S S  
 Y O U N A R V T M A S L M M L  
 S V U G X A D N H E W B M B S  
 O Z O J H W T E R Q D A A A N  
 J D V W P X G Y A M O L G N P  
 I C V J T B T B A B K E I L D

CARE  
 ELISHA  
 FOOD  
 GEHAZI





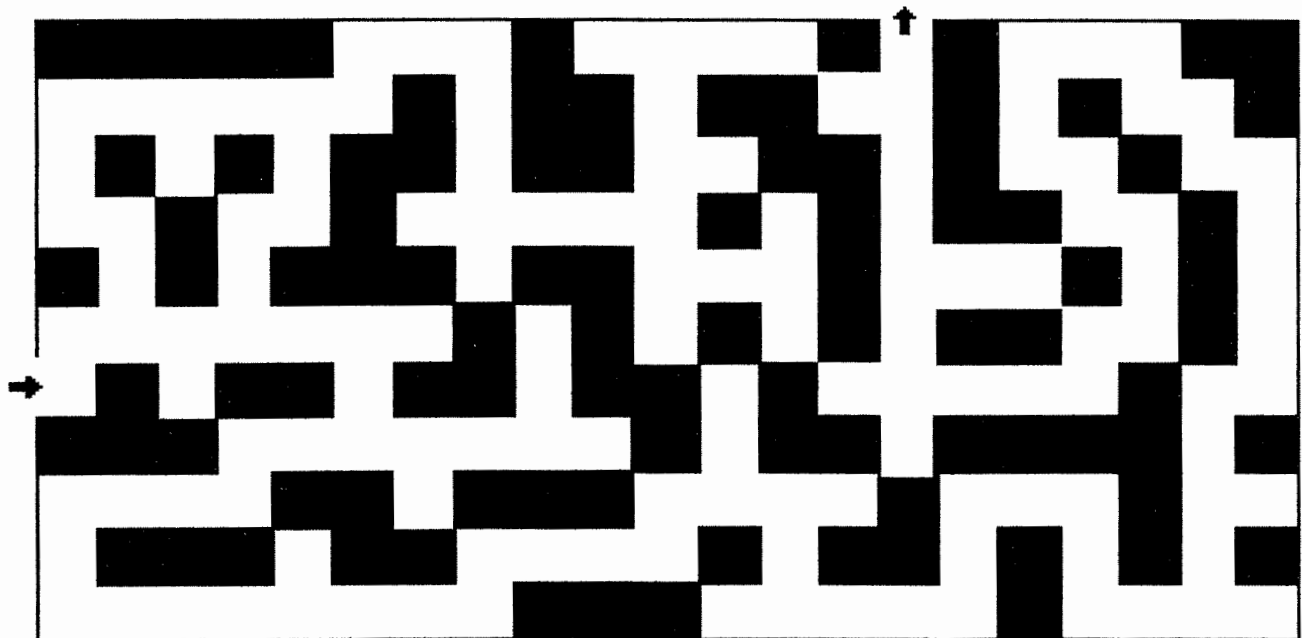



HUSBAND  
 LIE  
 MAN OF GOD

NOTABLE  
 ROOM  
 SON

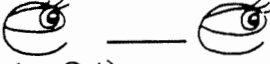

# WHAT A BLESSING!

To find out how Elisha helped a family, read 2 Kings 4:8-10, 17-22, and 32-37. Then read the sentences below. The sketch in each blank resembles a letter of the alphabet. Can you guess which letters? Then think of a word suggested by the sketches that fit the blanks.

1. A well-to-do woman asked Elisha to stay for a \_\_\_\_\_  (v. 8).
2. The woman and her husband made a room on the roof and put in it a bed, a table, a \_\_\_\_\_  \_\_\_\_\_, and a lamp for Elisha (v. 10).
3. The woman gave birth to a \_\_\_\_\_  \_\_\_\_\_ (v. 17).
4. The boy sat on his mother's lap until \_\_\_\_\_  \_\_\_\_\_ and then died (v. 20).
5. When Elisha reached the \_\_\_\_\_  \_\_\_\_\_, the boy was lying dead on his couch (v. 32).
6. Elisha laid upon the boy, mouth to mouth, \_\_\_\_\_  \_\_\_\_\_ to eyes, hands to hands (v. 34).
7. The boy \_\_\_\_\_  \_\_\_\_\_ seven times and opened his eyes (v. 35).
8. Elisha said to Gehazi, " \_\_\_\_\_  \_\_\_\_\_ the Shunammite" (v. 36).
9. When Elisha told the woman to take her son, she fell at his \_\_\_\_\_  \_\_\_\_\_ (v. 37).



# ELISHA RAISES A BOY FROM THE DEAD

(2 KINGS 4:18-36)

## MEMORY VERSE:

*"He went in therefore, shut the door behind the two of them, and prayed to the LORD." 2 KINGS 4:33*

## TRUE OR FALSE:

1. Now it happened one day that the Shunammite boy "went out to his father, to the reapers. And he said to his father, 'My head, my head!' So he said to a servant, 'Carry him to his mother.'" **2 KINGS 4:18-19**

TRUE OR FALSE

2. "When he had taken him and brought him to his mother, he sat on her knees till noon, and then died." **2 KINGS 4:20**

TRUE OR FALSE

## FILL IN THE BLANKS:

3. "And she went up and laid him on the \_\_\_\_\_ of the man of God, shut the door upon him, and went out." **2 KINGS 4:21**
4. "So she departed, and went to the man of God at Mount \_\_\_\_\_." **2 KINGS 4:25**
5. "Now when she came to the man of God at the hill, she caught him by the feet, but Gehazi came near to push her away. But the man of God said, 'Let her alone; for her soul is in deep distress, and the LORD has \_\_\_\_\_ it from me, and has not told me.'" **2 KINGS 4:27**
6. "And she said, 'Did I ask a \_\_\_\_\_ of my lord? Did I not say, "Do not deceive me?" ' " **2 KINGS 4:28**

## TRUE OR FALSE:

7. "And when Elisha came into the house, there was the child, lying dead on his bed." **2 KINGS 4:32**

TRUE OR FALSE

8. "He stretched himself out on the child, and the flesh of the child became warm." **2 KINGS 4:34**

TRUE OR FALSE

## FILL IN THE BLANK:

9. "He returned and walked back and forth in the house, and again went up and stretched himself out on him; then the child sneezed seven times, and the child \_\_\_\_\_ his eyes." **2 KINGS 4:35**

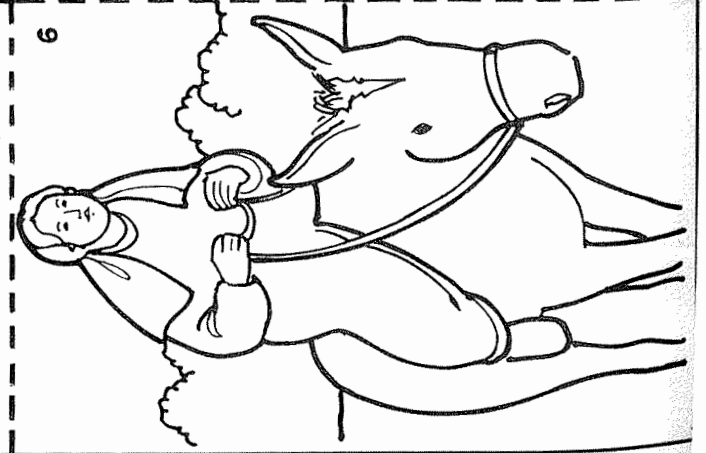
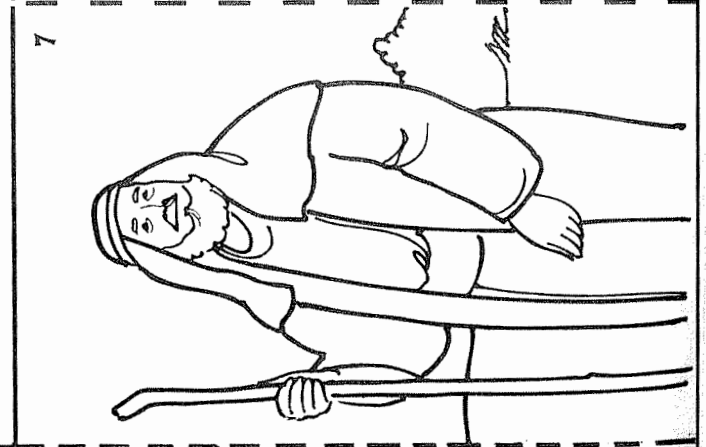
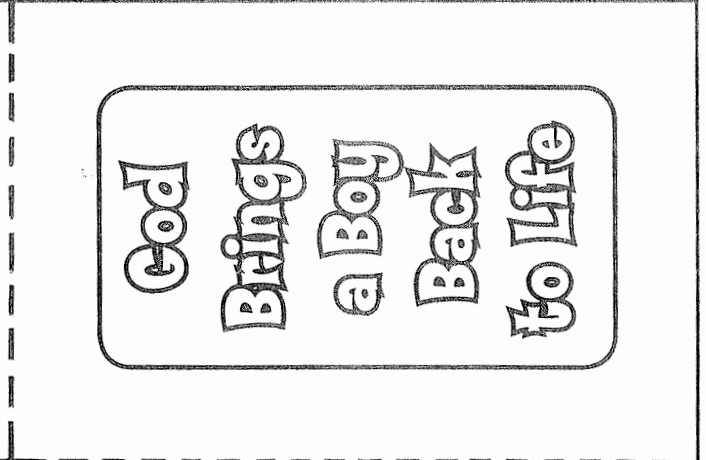
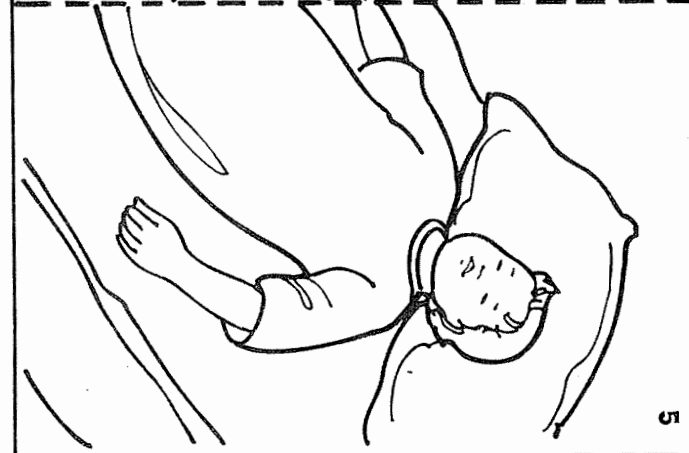
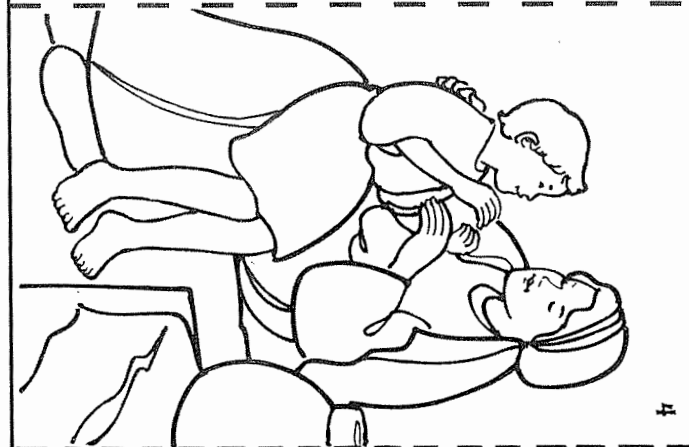
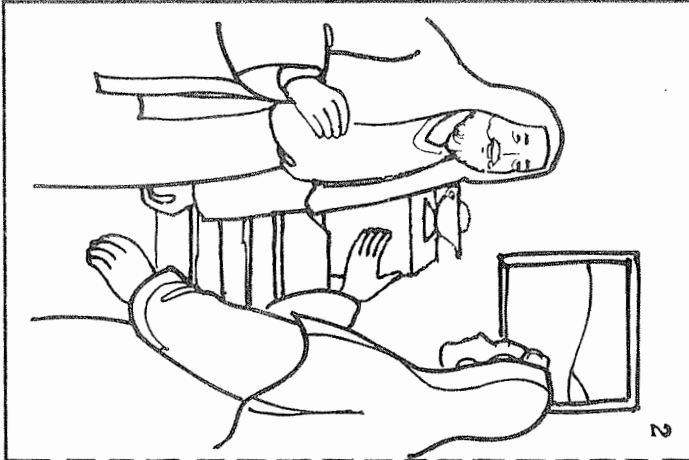

# ELISHA RAISES A BOY FROM THE DEAD

(2 KINGS 4:18-36)

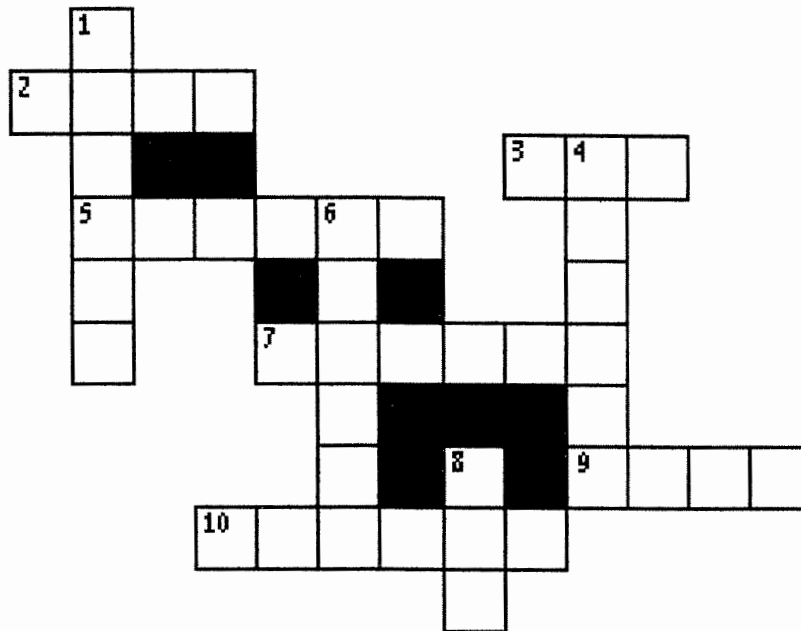

- 5 ACROSS Now it happened one day that the Shunammite boy "went out to his father, to the reapers. And he said to his father, 'My head, my head!' So he said to a servant, 'Carry him to his \_\_\_\_.'" **2 KINGS 4:18-19**
- 9 ACROSS "When he had taken him and brought him to his mother, he sat on her knees till noon, and then \_\_\_\_." **2 KINGS 4:20**
- 8 DOWN "And she went up and laid him on the \_\_\_\_ of the man of God, shut the door upon him, and went out." **2 KINGS 4:21**
- 1 DOWN "So she departed, and went to the man of God at Mount \_\_\_\_." **2 KINGS 4:25**
- 7 ACROSS "Now when she came to the man of God at the hill, she caught him by the feet, but Gehazi came near to push her away. But the man of God said, 'Let her alone; for her soul is in deep distress, and the LORD has \_\_\_\_ it from me, and has not told me.'" **2 KINGS 4:27**
- 3 ACROSS "And she said, 'Did I ask a \_\_\_\_ of my lord? Did I not say, "Do not deceive me?"'" **2 KINGS 4:28**
- 6 DOWN "And when \_\_\_\_ came into the house, there was the child, lying dead on his bed." **2 KINGS 4:32**
- 10 ACROSS "He went in therefore, shut the door behind the two of them, and \_\_\_\_ to the LORD." **2 KINGS 4:33**
- 2 ACROSS "He stretched himself out on the child, and the flesh of the child became \_\_\_\_." **2 KINGS 4:34**
- 4 DOWN "He returned and walked back and forth in the house, and again went up and stretched himself out on him; then the child sneezed seven times, and the child \_\_\_\_ his eyes." **2 KINGS 4:35**

# ELISHA RAISES A BOY FROM THE DEAD

(2 KINGS 4:18-36)

Z J L T D N K Z D V Q I H I R M E N N A  
T A H H R N X R D E N E P O T H H O P Z  
L G U T L S O D S Z C B V Y A O X A M H  
Y F G P B L Z I S Z N K P W L P K R Y Q  
D F I N H K Z E F M L G O Y S D M R A W  
O O N C R A R E A M B L P M K E F L H W  
W V L B H Y B E V M C O U R J I S B C I  
S W T E D L O D H I E M U P X D E T G Y  
R Q G F M N R C S T O L R Z R D Q D D M  
Z T M O D R B C W X O T D P Q D V E J H  
X C S V V O A L A O W M Y R M E H H D W  
C Y N E D H B C W J P T M A O M K C O N  
H N E M L M T G T U Y J D Y M K P T F E  
J K E T M I C G W N V T L E G W W E W L  
L K Z F V H S H Z B U H P D C C G R D I  
E W E W I Z N H O O Z O Y I C W Q T U Z  
O I D D P D P V A Y Y H M D L O V S I J  
O J D Y T C O S R D S G E U T E Y W L Y  
W E L F I V J O A A S J A K E U H L T K  
N Q N E H E T N W U O J O L J U W A O M

**BED**

**LORD**

**SNEEZED**

**DIED**

**MOTHER**

**SON**

**ELISHA**

**MOUNT CARMEL**

**STRETCHED**

**GEHAZI**

**OPENED**

**WARM**

**HIDDEN**

**PRAYED**

## Year 2

### Week 93

#### Naaman

**Scriptures: II Kings 5**

**Key Verse: II Kings 5:15 “Indeed now I know there is no God in all the earth, except in Israel;”**

#### **Key Points:**

1. Naaman was a Syrian army commander who had leprosy.
2. His wife had a servant girl from Israel. She suggested that Naaman seek the prophet of God (Elisha) in Samaria to be cured.
3. The king of Syria sent Naaman with a letter to the king of Israel, expecting healing for Naaman.
5. The king of Israel tore his clothes in distress when he read the letter, but Elisha asked the king to send Naaman to him.
6. Through a messenger, Elisha instructed Naaman to wash in the Jordan River seven times to be healed.
7. Naaman was angry because Elisha had not personally performed a miracle to cure him, and he turned to leave. However, his servants urged Naaman to do as he had been instructed.
8. Naaman listened to them, and when he had dipped 7 times in the muddy water of the Jordan he was cured! He praised God.
9. Naaman returned and offered gifts to Elisha, who refused to take them. Elisha’s servant Gehazi followed Naaman and asked for the gifts. When Gehazi returned, Elisha struck him with the leprosy of Naaman.

# 34. A Slave Girl Helps Her Sick Master

## 2 Kings 5

Naaman was a brave and powerful captain in the Syrian army. The sad thing about Naaman was that he had a sickness called leprosy. His wife's Israelite slave girl felt sorry for her master and wished he could get better.

What did the little girl say Naaman should do to get better?

$\overline{2-4}$   $\overline{5-3}$   $\overline{5-2}$   $\overline{5-3}$   $\overline{5-2}$   $\overline{3-4}$   $\overline{5-5}$

$\overline{1-2}$   $\overline{3-2}$   $\overline{5-3}$   $\overline{1-2}$   $\overline{3-4}$   $\overline{5-5}$   $\overline{5-2}$   $\overline{4-4}$   $\overline{4-3}$

$\overline{4-4}$   $\overline{4-2}$   $\overline{3-2}$   $\overline{1-5}$   $\overline{5-5}$   $\overline{2-3}$

What did the prophet tell Naaman to do?

$\overline{3-1}$   $\overline{1-5}$   $\overline{4-2}$   $\overline{3-4}$   $\overline{4-4}$   $\overline{4-3}$   $\overline{5-4}$   $\overline{5-3}$   $\overline{3-2}$   $\overline{4-5}$   $\overline{1-5}$   $\overline{4-3}$

$\overline{4-2}$   $\overline{5-5}$   $\overline{2-1}$   $\overline{5-5}$   $\overline{4-3}$   $\overline{5-2}$   $\overline{4-4}$   $\overline{3-3}$   $\overline{5-5}$   $\overline{4-2}$

What happened when Naaman obeyed the prophet?

$\overline{3-4}$   $\overline{5-5}$   $\overline{3-1}$   $\overline{1-5}$   $\overline{4-2}$   $\overline{3-4}$   $\overline{5-5}$   $\overline{1-5}$   $\overline{2-3}$   $\overline{5-5}$   $\overline{4-5}$

5	A	B	C	D	E
4	F	G	H	I	J
3	K	L	M	N	O
2	P	Q	R	S	T
1	U	V	W	X	Y
	1	2	3	4	5



To find the correct letter in the graph go across the bottom line till you get to the first number in the code ( $\overline{5-4}$ ). The second number indicates the number of rows you need to go up ( $\overline{5-4}$ ).  $\overline{5-4}$  is the letter "J."

# NAAMAN'S LEPROSY IS HEALED

(2 KINGS 5:1-14)



"So he went down and dipped seven times in the Jordan, according to the saying of the man of God; and his flesh was restored like the flesh of a little child, and he was clean."

**2 KINGS 5:14**

# NAAMAN'S LEPROSY IS HEALED

## (2 KINGS 5:1-14)

### MEMORY VERSE:

*"So he went down and dipped seven times in the Jordan, according to the saying of the man of God; and his flesh was restored like the flesh of a little child, and he was clean." 2 KINGS 5:14*

### CIRCLE THE CORRECT WORDS:

1. "(**HEYMAN, NAAMAN**), commander of the army of the king of Syria, was a great and honorable man in the eyes of his master, because by him the LORD had given victory to Syria." **2 KINGS 5:1**
2. "He was also a mighty man of valor, but he was a (**LEPER, PEPPER**)." **2 KINGS 5:1**

### TRUE OR FALSE:

3. "The Syrians had gone out on raids, and had brought back captive a young girl from the land of Israel. She waited on Naaman's wife." **2 KINGS 5:2**

TRUE OR FALSE

### CIRCLE THE CORRECT WORDS:

4. "Then she said to her mistress, 'If only my master were with the prophet who is in Samaria! For he would (**HEAL, PEEL**) him of his leprosy.'" **2 KINGS 5:3**
5. "So the king of Syria said, 'Go now, and I will send a (**LETTER, CHARIOT**) to the king of Israel.'" **2 KINGS 5:5**

### TRUE OR FALSE:

6. And it happened, when the king of Israel read the letter, he rejoiced because he could heal Naaman of his leprosy! **2 KINGS 5:7**

TRUE OR FALSE

7. Elisha sent a messenger to Naaman, saying, "Go and wash in the Jordan seven times, and your flesh shall be restored to you, and you shall be clean." **2 KINGS 5:10**

TRUE OR FALSE

### CIRCLE THE CORRECT WORD:

8. "Naaman became (**EXCITED, FURIOUS**), and went away and said, 'Indeed, I said to myself, "He will surely come out to me." ' " **2 KINGS 5:11**

### FILL IN THE BLANK:

9. "And his servants came near and spoke to him, and said, 'My father, if the prophet had told you to do something \_\_\_\_\_, would you not have done it? How much more then, when he says to you "Wash, and be clean"?' " **2 KINGS 5:13**

### TRUE OR FALSE:

10. "So he went down and dipped seven times in the Jordan, according to the saying of the man of God; and his flesh was restored like the flesh of a little child, and he was clean." **2 KINGS 5:14**

TRUE OR FALSE



# NAAMAN'S LEPROSY IS HEALED

## (2 KINGS 5:1-14)

### MEMORY VERSE:

*"So he went down and dipped seven times in the Jordan, according to the saying of the man of God; and his flesh was restored like the flesh of a little child, and he was clean." 2 KINGS 5:14*

### FILL IN THE BLANKS:

1. "\_\_\_\_\_, commander of the army of the king of Syria, was a great and honorable man in the eyes of his master, because by him the LORD had given victory to Syria." **2 KINGS 5:1**
2. "He was also a mighty man of valor, but he was a \_\_\_\_\_." **2 KINGS 5:1**

### TRUE OR FALSE:

3. "The Syrians had gone out on raids, and had brought back captive a young girl from the land of Israel. She waited on Naaman's wife." **2 KINGS 5:2**

**TRUE OR FALSE**

### FILL IN THE BLANKS:

4. "Then she said to her mistress, 'If only my master were with the prophet who is in Samaria! For he would \_\_\_\_\_ him of his leprosy.'" **2 KINGS 5:3**
5. "So the king of Syria said, 'Go now, and I will send a \_\_\_\_\_ to the king of Israel.'" **2 KINGS 5:5**

### TRUE OR FALSE:

6. And it happened, when the king of Israel read the letter, he rejoiced because he could heal Naaman of his leprosy! **2 KINGS 5:7**

**TRUE OR FALSE**

7. Elisha sent a messenger to Naaman, saying, "Go and wash in the Jordan seven times, and your flesh shall be restored to you, and you shall be clean." **2 KINGS 5:10**

**TRUE OR FALSE**

### FILL IN THE BLANKS:

8. "Naaman became \_\_\_\_\_, and went away and said, 'Indeed, I said to myself, "He will surely come out to me." ' " **2 KINGS 5:11**
9. "And his servants came near and spoke to him, and said, 'My father, if the prophet had told you to do something \_\_\_\_\_, would you not have done it? How much more then, when he says to you "Wash, and be clean"?' " **2 KINGS 5:13**

### TRUE OR FALSE:

10. "So he went down and dipped seven times in the Jordan, according to the saying of the man of God; and his flesh was restored like the flesh of a little child, and he was clean." **2 KINGS 5:14**

**TRUE OR FALSE**

# NAAMAN'S LEPROSY IS HEALED

## (2 KINGS 5:1-14)

Y H B T E Z V M N I J A A T W Y M Q Z Q  
 N T H I K D S A D E P P I D O H Y W J L  
 K P F H D E E M N B H O L E E W H I Y E  
 K N D N Z L W R L K V I S J U N C Y K P  
 W C D N C E E I B G V Y K M U N G M L E  
 I B V S B T A N C L O W J H E A D H F R  
 J F S K T D A H E O P Y X O H D J W Z P  
 Q O D E O C W O S M U M R P L R D N M Y  
 L V L Y M C W J O I U R Q D D O O R S Z  
 H M M L R I Z U W L L F C N F J F E W I  
 U T F N B L T B P T R E O A S O W D N N  
 G F U S B G O N Y T D Z C A Q A D N O Q  
 I W R O Y G X O E J Y I G M V R U A U V  
 N Y I H T R A Y V V M D C A H X I M H A  
 T F O M C X I D Z T E U L N K T X M G W  
 M E U Z N V W A Y H D S A E P W T O F A  
 L D S D P S V A N H M K E C W X O C L S  
 N R V C O S Z U S S N L H K G A A E R H  
 T O R E J F Z Q S G Y R C W Q N Z L T F  
 T L P V T A M C O J E T L C V P H I F F

CLEAN  
 COMMANDER  
 DIPPED  
 ELISHA  
 FURIOUS

HEAL  
 JORDAN  
 LEPER  
 LETTER  
 NAAMAN

SEVEN TIMES  
 SYRIANS  
 TORE  
 WASH

WRITE DOWN ALL THE LETTERS AS YOU COME TO THEM EXCEPT THE "X"'S ON THE LINES BELOW

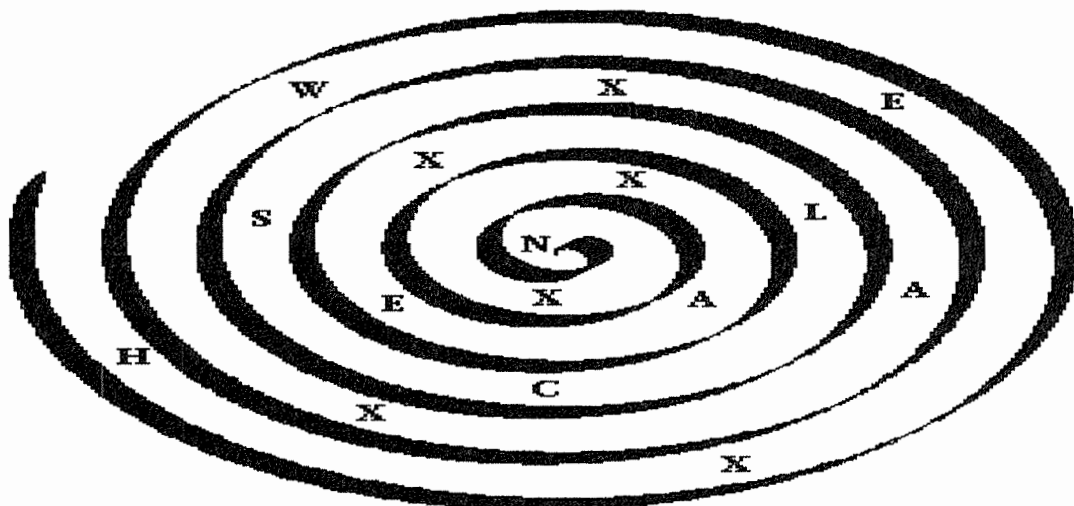

-----

# NAAMAN'S LEPROSY IS HEALED

(2 KINGS 5:1-14)

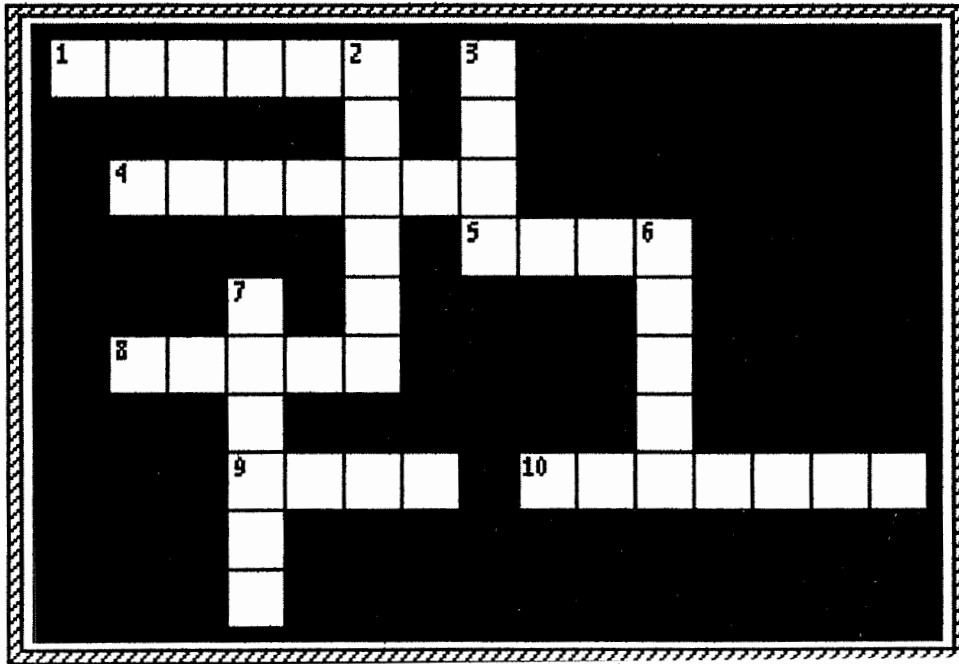

*Examples of leprosy*



# ELISHA'S GREEDY SERVANT

## (2 KINGS 5:15-27)

### MEMORY VERSE:

*"Did not my heart go with you when the man turned back from his chariot to meet you? Is it time to receive money and to receive clothing, olive groves and vineyards, sheep and oxen, male and female servants?" 2 KINGS 5:26*

### TRUE OR FALSE:

1. Naaman "returned to the man of God, he and all his aides, and came and stood before him; and he said, 'Indeed, now I know that there is no God in all the earth, except in Israel.' " **2 KINGS 5:15**  
**TRUE OR FALSE**

### FILL IN THE BLANKS:

2. He said, "Now therefore, please take a \_\_\_\_\_ from your servant." **2 KINGS 5:15**
3. Elisha said, "As the LORD lives, before whom I stand, I will receive \_\_\_\_\_." **2 KINGS 5:16**
4. Elisha "said to him, 'Go in peace.' So he departed from him a \_\_\_\_\_ distance." **2 KINGS 5:19**

### TRUE OR FALSE:

5. "But Gehazi, the servant of Elisha the man of God, said, 'Look, my master has spared Naaman this Syrian, while not receiving from his hands what he brought; but as the LORD lives, I will run after him and take something from him.' " **2 KINGS 5:20**  
**TRUE OR FALSE**
6. But Gehazi changed his mind and did not pursue Naaman. **2 KINGS 5:21**  
**TRUE OR FALSE**

### FILL IN THE BLANKS:

7. Gehazi said to Naaman, "All is well. My master has sent me, saying, 'Indeed, just now two young men of the sons of the prophets have come to me from the mountains of Ephraim. Please give them a talent of \_\_\_\_\_ and two changes of \_\_\_\_\_.' " **2 KINGS 5:22**
8. "So Naaman said, 'Please take \_\_\_\_\_ talents.' " **2 KINGS 5:23**

### UNDERLINE THE CORRECT ANSWER:

9. "Now he went in and stood before his master. And Elisha said to him..." **2 KINGS 5:25**
  - a. Where did you go, Gehazi?
  - b. Did you get anything for me too?

### TRUE OR FALSE:

10. Then Elisha "said to him, 'Did not my heart go with you when the man turned back from his chariot to meet you?' " **2 KINGS 5:26**  
**TRUE OR FALSE**
11. He said, " 'Therefore the leprosy of Naaman shall cling to you and your descendants forever.' And he went out from his presence leprous, as white as snow." **2 KINGS 5:27**  
**TRUE OR FALSE**

# ELISHA'S GREEDY SERVANT

(2 KINGS 5:15-27)



"The leprosy therefore of Naaman shall cleave unto thee, and unto thy seed for ever.  
And he went out from his presence a leper as *white* as snow."  
**2 KINGS 5:27**

# ELISHA'S GREEDY SERVANT

## (2 KINGS 5:15-27)

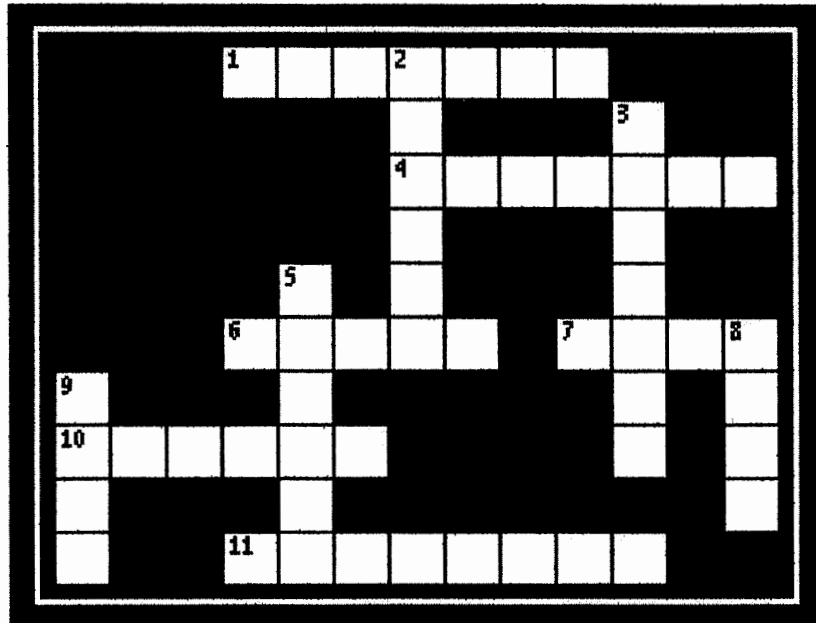

- 9 DOWN Naaman "returned to the man of God, he and all his aides, and came and stood before him; and he said, 'Indeed, now I \_\_\_\_\_ that there is no God in all the earth, except in Israel.' " **2 KINGS 5:15**
- 7 ACROSS He said, "Now therefore, please take a \_\_\_\_\_ from your servant." **2 KINGS 5:15**
- 3 DOWN Elisha said, "As the LORD lives, before whom I stand, I will receive \_\_\_\_\_." **2 KINGS 5:16**
- 11 ACROSS Elisha "said to him, 'Go in peace.' So he departed from him a short \_\_\_\_\_." **2 KINGS 5:19**
- 8 DOWN "But Gehazi, the servant of Elisha the man of God, said, 'Look, my master has spared Naaman this Syrian, while not receiving from his hands what he brought; but as the LORD lives, I will run after him and \_\_\_\_\_ something from him.' " **2 KINGS 5:20**
- 1 ACROSS "So Gehazi \_\_\_\_\_ Naaman." **2 KINGS 5:21**
- 2 DOWN Gehazi said to Naaman, "All is well. My master has sent me, saying, 'Indeed, just now two young men of the sons of the prophets have come to me from the mountains of Ephraim. Please give them a talent of \_\_\_\_\_ and two changes of garments.' " **2 KINGS 5:22**
- 10 ACROSS "So \_\_\_\_\_ said, 'Please take two talents.' " **2 KINGS 5:23**
- 5 DOWN "Now he went in and stood before his master. And Elisha said to him, 'Where did you go, \_\_\_\_\_?' " **2 KINGS 5:25**
- 6 ACROSS Then Elisha "said to him, 'Did not my \_\_\_\_\_ go with you when the man turned back from his chariot to meet you?' " **2 KINGS 5:26**
- 4 ACROSS He said, "Therefore the \_\_\_\_\_ of Naaman shall cling to you and your descendants forever.' And he went out from his presence leprous, as white as snow." **2 KINGS 5:27**

## Year 2

### Week 94 Elisha and War Between Israel and Syria

**Scriptures:** II Kings 6:13-33, II Kings 7

**Key Verse:** II Kings 6:16 “Do not fear, for those who are with us are more than those are with them.”

#### Key Points:

1. The king of Syria planned to ambush the Israelites. Elisha was warned by God to tell the king of Israel (Joram, the son of Ahab) to avoid the place where the Syrians would attack. The king sent scouts who were able to verify what Elisha had told him. The king of Syria suspected some of his men of spying for Israel, but the servants correctly blamed Elisha for the plan's failure.

2. The Syrians then tried to capture Elisha in the city of Dothan. God sent an army of horses and chariots of fire to protect him. Although Elisha knew of the presence of God's army, his servant was afraid when he saw the Syrians. Elisha asked that his servant's eyes be opened so that he was able to see the power of God.

3. Then Elisha prayed that God would blind the Syrians, and He did. Elisha led the Syrian army to Samaria. Elisha prayed to the Lord to restore their sight and they realized they were inside Samaria. The king of Israel asked if he should kill them, but Elisha instructed him to prepare a feast. After they ate and drank, they returned to Syria and the raids ended.

4. Later, the Syrians again tried to capture Israel by surrounding the city. Food was so scarce that two mothers agreed to kill and eat their babies. One mother went through with the plan, but the second one refused to kill her son.

5. The king mourned when he heard how desperate his people were. He was angry with Elisha, but Elisha predicted that relief would come the next day. One officer expressed doubts, and Elisha predicted that he would see it happen with his eyes, but he would not eat any of it.

6. Four lepers who sat at the city gate decided to find the Syrian army and surrender. Meanwhile, God had caused the Syrians to hear the noise of a great army and they had all run away. The lepers found the camp deserted, but intact. They returned to the city and sent messages to the king. The king sent men to investigate. They found the camp was full of provisions, and the Israelites had food again. The king's officer did not get to eat any of it because he was trampled and killed in the gate.

# Kings and Prophets

After King Solomon's death, the nation of Israel was divided into two kingdoms—Judah and Israel. Many of the kings who ruled the two kingdoms were very wicked. During this time, God spoke to His people through prophets.

Use the clues and Bible references to find the identity of several kings and prophets and write them in the crossword puzzle.

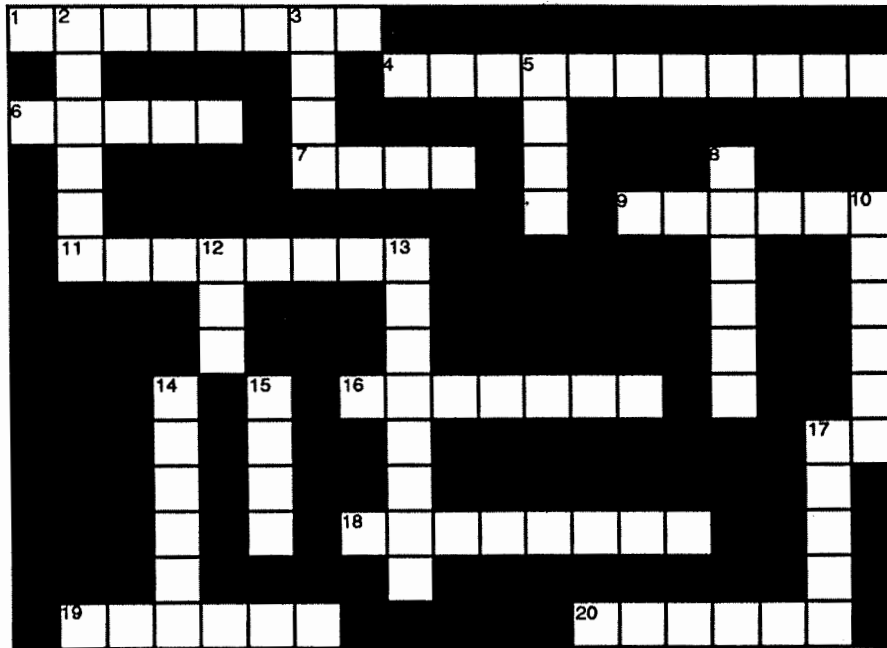

## ACROSS

## DOWN

- |                                                                                                                                                                                                                                                                                                                                                                                                                                                                                                                                                                                                                                                                                                                                                                                                                                                                                                                                                                                                                 |                                                                                                                                                                                                                                                                                                                                                                                                                                                                                                                                                                                                                                                                                                                                                                                                                                                                                                                                                                                                                                                           |
|-----------------------------------------------------------------------------------------------------------------------------------------------------------------------------------------------------------------------------------------------------------------------------------------------------------------------------------------------------------------------------------------------------------------------------------------------------------------------------------------------------------------------------------------------------------------------------------------------------------------------------------------------------------------------------------------------------------------------------------------------------------------------------------------------------------------------------------------------------------------------------------------------------------------------------------------------------------------------------------------------------------------|-----------------------------------------------------------------------------------------------------------------------------------------------------------------------------------------------------------------------------------------------------------------------------------------------------------------------------------------------------------------------------------------------------------------------------------------------------------------------------------------------------------------------------------------------------------------------------------------------------------------------------------------------------------------------------------------------------------------------------------------------------------------------------------------------------------------------------------------------------------------------------------------------------------------------------------------------------------------------------------------------------------------------------------------------------------|
| <ol style="list-style-type: none"> <li>1. Solomon's son; he became king after his father died. (<i>I Kings 11:43</i>)</li> <li>4. This king reigned over Judah for 25 years. His mother's name was Azubah. (<i>I Kings 22:42</i>)</li> <li>6. His reign over Judah lasted only seven days. He died in a fire he set himself. (<i>I Kings 16:10-18</i>)</li> <li>7. Elijah killed 450 prophets of _____. (<i>I Kings 18:40</i>)</li> <li>9. His leprosy was healed when he dipped himself into the Jordan river seven times. (<i>II Kings 5:9-14</i>)</li> <li>11. Ahaziah's mother. (<i>II Kings 8:26</i>)</li> <li>16. Ahab's wife. She was a very wicked queen. (<i>I Kings 16:30-31</i>)</li> <li>18. Hezekiah's wicked son who became king after him. (<i>II Kings 20:21</i>)</li> <li>19. Elisha's servant; he became a leper because of his sin. (<i>II Kings 5:20-27</i>)</li> <li>20. This good king of Judah found the book of God's law and read it to the people. (<i>II Kings 22-23</i>)</li> </ol> | <ol style="list-style-type: none"> <li>2. He took Elijah's place as God's prophet. (<i>II Kings 2:15</i>)</li> <li>3. The Bible says this king did evil "above all that were before him." (<i>I Kings 16:30</i>)</li> <li>5. Ahab's father. Like his son, he was an evil king. (<i>I Kings 16:25-29</i>)</li> <li>8. The mountain where Elijah defeated the prophets of Baal. (<i>I Kings 18:20-40</i>)</li> <li>10. Owned a vineyard that King Ahab wanted. (<i>I Kings 21:1-14</i>)</li> <li>12. This king removed all the idols his fathers had made. (<i>I Kings 15:11-12</i>)</li> <li>13. This good king was the son of evil King Ahaz. He spread out a threatening letter before the Lord. (<i>II Kings 16:20; 19:14</i>)</li> <li>14. Taken to heaven in a chariot of fire. (<i>II Kings 2:11</i>)</li> <li>15. This king stopped the worship of Baal, but allowed the people to worship golden idols. (<i>II Kings 10:28-29</i>)</li> <li>17. He was hidden from wicked Queen Athaliah. He became king at age 7. (<i>II Kings 11</i>)</li> </ol> |
|-----------------------------------------------------------------------------------------------------------------------------------------------------------------------------------------------------------------------------------------------------------------------------------------------------------------------------------------------------------------------------------------------------------------------------------------------------------------------------------------------------------------------------------------------------------------------------------------------------------------------------------------------------------------------------------------------------------------------------------------------------------------------------------------------------------------------------------------------------------------------------------------------------------------------------------------------------------------------------------------------------------------|-----------------------------------------------------------------------------------------------------------------------------------------------------------------------------------------------------------------------------------------------------------------------------------------------------------------------------------------------------------------------------------------------------------------------------------------------------------------------------------------------------------------------------------------------------------------------------------------------------------------------------------------------------------------------------------------------------------------------------------------------------------------------------------------------------------------------------------------------------------------------------------------------------------------------------------------------------------------------------------------------------------------------------------------------------------|



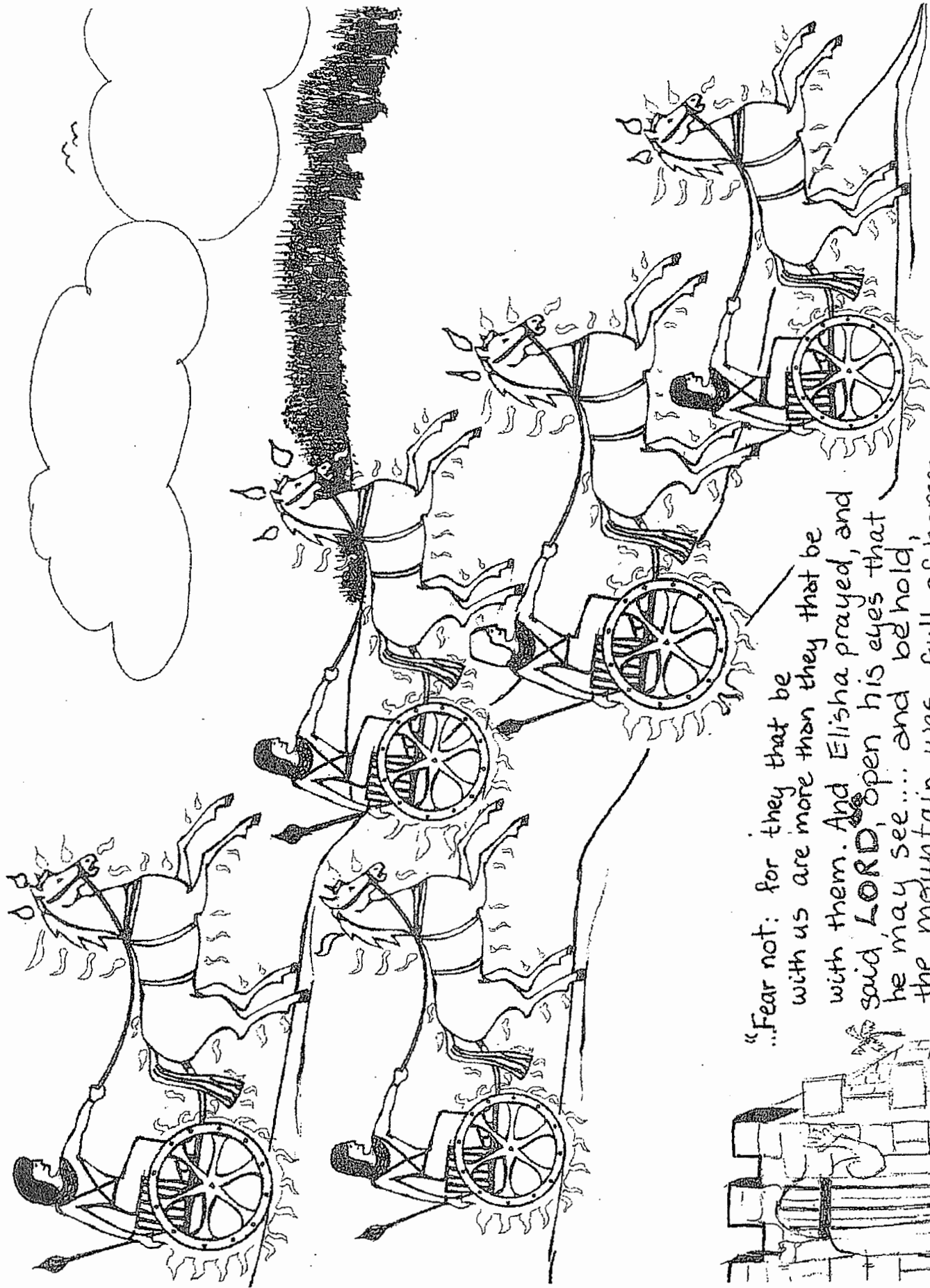

“Fear not: for they that be  
with us are more than they that be  
with them. And Elisha prayed, and  
said, **LORD**, open his eyes that  
he may see... and behold,  
the mountain was full of horses  
and chariots of fire round about  
Elisha... 2 Kings 6: 16-17

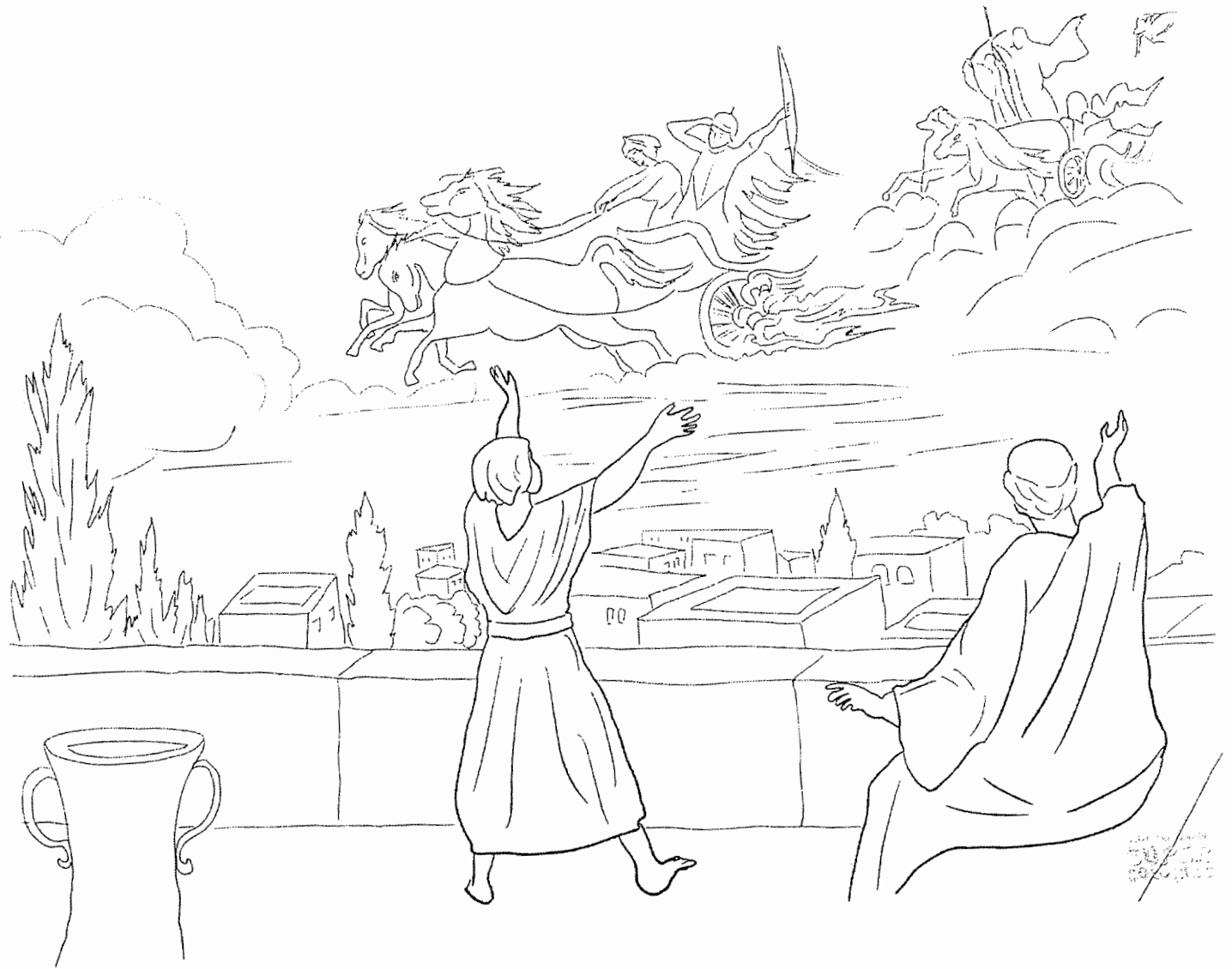

## Word Search

S V T O F O X L Z P H M Q M Z A T Z  
R I V W Z A S N D R R C D L H P R T  
A E I Y N S D L O R D O D F R S U M  
F B L I N D Q F T X G V V O V N E M  
F S K I N G S X H M O I P E E V T T  
R H N R J H V F A B Q H Q P R S R N  
I C D C P A A D N O E A O J U B U E  
G Z K N H R H B I T H P R R K Y S V  
H V R W A R O G Z S D S R M S E T A  
T E V M O F R Z I E R O F B Y E L E  
E K V F F A N L Y E U A Z E U I S H  
N Z G I X I E A N N J Z E N E M Y P  
E I C U D P R N D A C W S L Q G G M  
D E M Q I P I E C H A R I O T S B C  
R C V Q O W D W L X U L I U L Q Z P

Find and Circle the Following Words:

Aram, army, blind, chariots, Dothan, Elijah, Elisha, enemy, eyes, fire, frustrated, God, heaven, horses, Israel, kings, Lord, officer, open, prayed, prophet, Proverbs, surrounded, trust, war, winners

# A SERVANT SEES A FIERY ARMY

(2 KINGS 6:8-23)



"Then the LORD opened the eyes of the young man, and he saw. And behold, the mountain was full of horses and chariots of fire all around Elisha."

**2 KINGS 6:17**

# A SERVANT SEES A FIERY ARMY

## (2 KINGS 6:8-23)

### MEMORY VERSE:

*"Then the LORD opened the eyes of the young man, and he saw. And behold, the mountain was full of horses and chariots of fire all around Elisha." 2 KINGS 6:17*

### FILL IN THE BLANK:

1. "Now the king of Syria was making \_\_\_\_\_ against Israel; and he took counsel with his servants, saying, 'My camp will be in such and such a place.'" **2 KINGS 6:8**

### TRUE OR FALSE:

2. "And the man of God sent to the king of Israel, saying, 'Beware that you do not pass this place, for the Syrians are coming down there.'" **2 KINGS 6:9**

TRUE OR FALSE

3. But the king of Israel did not listen and did not send anyone to the place of which the man of God had told him. **2 KINGS 6:10**

TRUE OR FALSE

### FILL IN THE BLANKS:

4. "Therefore the heart of the king of Syria was greatly \_\_\_\_\_ by this thing; and he called his servants and said to them, 'Will you not show me which of us is for the king of Israel?'" **2 KINGS 6:11**

5. "And one of his servants said, 'None, my lord, O king; but \_\_\_\_\_, the prophet who is in Israel, tells the king of Israel the words that you speak in your bedroom.'" **2 KINGS 6:12**

### TRUE OR FALSE:

6. "So he said, 'Go and see where he is, that I may send and get him.' And it was told him, saying, 'Surely he is in Dothan.'" **2 KINGS 6:13**

TRUE OR FALSE

7. "Therefore he sent horses and chariots and a great army there, and they came by night and surrounded the city." **2 KINGS 6:14**

TRUE OR FALSE

### FILL IN THE BLANKS:

8. "And when the servant of the man of God arose early and went out, there was an army, \_\_\_\_\_ the city with horses and chariots. And his servant said to him, 'Alas, my master! What shall we do?'" **2 KINGS 6:15**

9. "So he answered, 'Do not fear, for those who are with us are \_\_\_\_\_ than those who are with them.'" **2 KINGS 6:16**

10. "And Elisha prayed, and said, 'LORD, I pray, open his eyes that he may see.' Then the LORD opened the eyes of the young man, and he saw. And behold, the mountain was \_\_\_\_\_ of horses and chariots of fire all around Elisha." **2 KINGS 6:17**

11. "So when the Syrians came down to him,, Elisha prayed to the LORD, and said, 'Strike this people, I pray, with \_\_\_\_\_.'" **2 KINGS 6:18**

12. "Now Elisha said to them, 'This is not the way, nor is this the city. Follow me, and I will bring you to the man whom you seek.' But he led them to \_\_\_\_\_." **2 KINGS 6:19**

# A SERVANT SEES A FIERY ARMY

## (2 KINGS 6:8-23)

### MEMORY VERSE:

*"Then the LORD opened the eyes of the young man, and he saw. And behold, the mountain was full of horses and chariots of fire all around Elisha." 2 KINGS 6:17*

### CIRCLE THE CORRECT WORD:

1. "Now the king of Syria was making (**TALK, WAR**) against Israel; and he took counsel with his servants, saying, 'My camp will be in such and such a place.' " **2 KINGS 6:8**

### TRUE OR FALSE:

2. "And the man of God sent to the king of Israel, saying, 'Beware that you do not pass this place, for the Syrians are coming down there.' " **2 KINGS 6:9**

TRUE OR FALSE

3. But the king of Israel did not listen and did not send anyone to the place of which the man of God had told him. **2 KINGS 6:10**

TRUE OR FALSE

### CIRCLE THE CORRECT WORD:

4. "Therefore the heart of the king of Syria was greatly (**TROUBLED, BUBBLED**) by this thing; and he called his servants and said to them, 'Will you not show me which of us is for the king of Israel?' " **2 KINGS 6:11**

### FILL IN THE BLANK:

5. "And one of his servants said, 'None, my lord, O king; but \_\_\_\_\_, the prophet who is in Israel, tells the king of Israel the words that you speak in your bedroom.' " **2 KINGS 6:12**

### TRUE OR FALSE:

6. "So he said, 'Go and see where he is, that I may send and get him.' And it was told him, saying, 'Surely he is in Dothan.' " **2 KINGS 6:13**

TRUE OR FALSE

7. "Therefore he sent horses and chariots and a great army there, and they came by night and surrounded the city." **2 KINGS 6:14**

TRUE OR FALSE

### CIRCLE THE CORRECT WORDS:

8. "And when the servant of the man of God arose early and went out, there was an army, (**SURROUNDING, LEAVING**) the city with horses and chariots. And his servant said to him, 'Alas, my master! What shall we do?' " **2 KINGS 6:15**
9. "So he answered, 'Do not fear, for those who are with us are (**MORE, LESS**) than those who are with them.' " **2 KINGS 6:16**
10. "And Elisha prayed, and said, 'LORD, I pray, open his eyes that he may see.' Then the LORD opened the eyes of the young man, and he saw. And behold, the mountain was (**EMPTY, FULL**) of horses and chariots of fire all around Elisha." **2 KINGS 6:17**
11. "So when the Syrians came down to him,, Elisha prayed to the LORD, and said, 'Strike this people, I pray, with (**KINDNESS, BLINDNESS**).' " **2 KINGS 6:18**
12. "Now Elisha said to them, 'This is not the way, nor is this the city. Follow me, and I will bring you to the man whom you seek.' But he led them to (**SAMARIA, SYRIA**). " **2 KINGS 6:19**

# A SERVANT SEES A FIERY ARMY

## (2 KINGS 6:8-23)

J	T	F	E	Y	E	S	E	M	Y	Q	P	N	V	F
Q	V	L	S	I	F	I	S	R	A	E	L	V	E	G
L	G	K	O	P	R	H	Z	Q	H	W	L	D	M	I
P	W	I	E	K	S	S	E	N	D	N	I	L	B	E
V	D	Q	Z	D	S	E	R	V	A	N	T	I	N	G
G	K	D	P	S	E	Y	U	B	F	G	O	M	B	W
Y	A	E	E	R	A	D	U	V	Q	L	P	O	A	K
Q	G	L	U	E	C	M	N	B	X	W	D	O	S	G
D	S	B	V	N	G	G	A	U	H	D	Q	F	P	N
O	A	U	F	A	O	M	Y	R	O	I	J	U	W	I
O	L	O	I	I	W	X	M	W	I	R	J	D	J	K
K	K	R	U	P	J	U	R	Y	M	A	R	R	H	O
P	S	T	S	Y	R	I	A	N	S	C	A	U	N	I
Z	Y	S	H	Q	V	V	I	U	G	W	C	I	S	L
S	J	N	A	H	T	O	D	K	A	H	S	I	L	E

**ARMY**  
**BLINDNESS**  
**DOTHAN**  
**ELISHA**  
**EYES**

**ISRAEL**  
**KING**  
**SAMARIA**  
**SERVANT**

**SURROUNDED**  
**SYRIANS**  
**TROUBLED**  
**WAR**

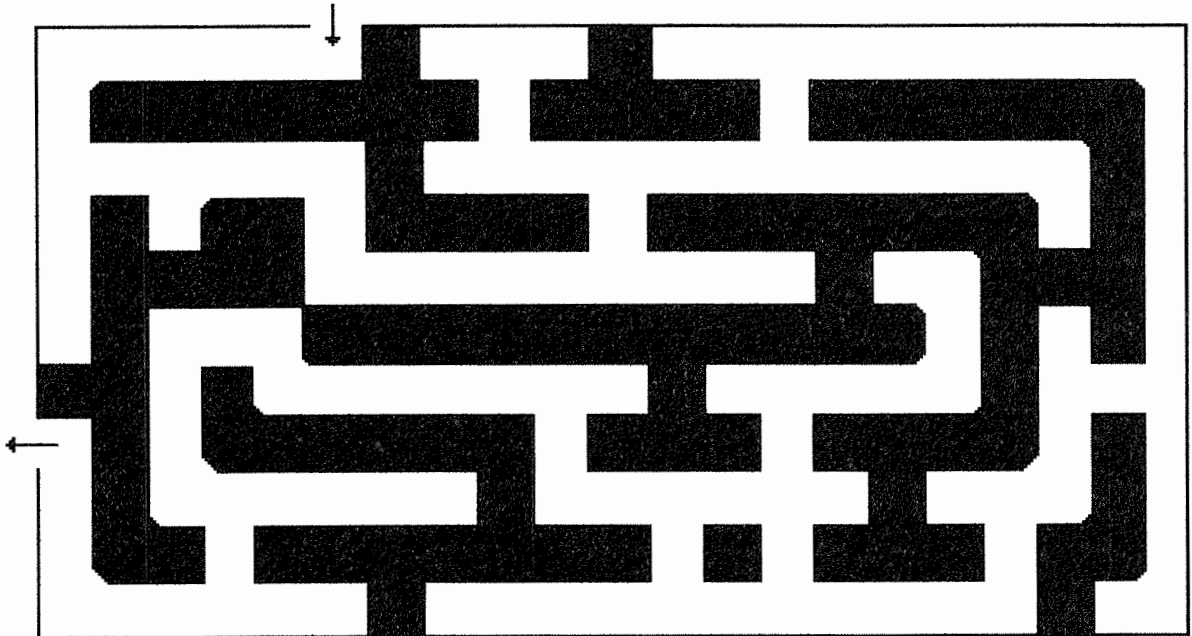

# A SERVANT SEES A FIERY ARMY

## (2 KINGS 6:8-23)

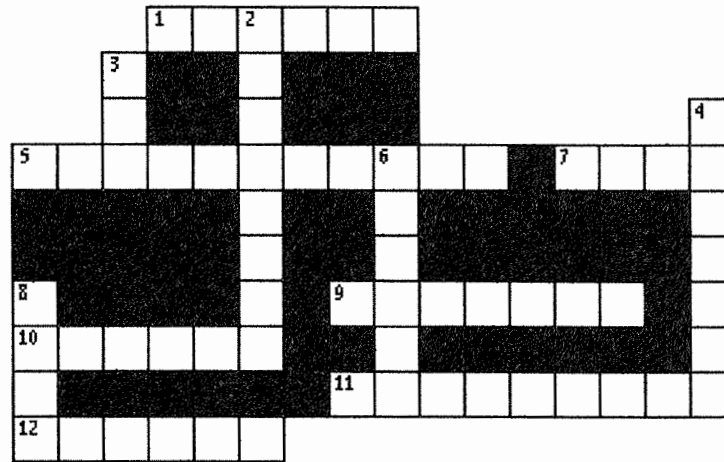

- 3 DOWN "Now the king of Syria was making \_\_\_\_\_ against Israel; and he took counsel with his servants, saying, 'My camp will be in such and such a place.' " **2 KINGS 6:8**
- 4 DOWN "And the man of God sent to the king of Israel, saying, 'Beware that you do not pass this place, for the \_\_\_\_\_ are coming down there.' " **2 KINGS 6:9**
- 6 DOWN "Then the king of \_\_\_\_\_ sent someone to the place of which the man of God had told him." **2 KINGS 6:10**
- 2 DOWN "Therefore the heart of the king of Syria was greatly \_\_\_\_\_ by this thing." **2 KINGS 6:11**
- 12 ACROSS "And one of his servants said, 'None, my lord, O king; but \_\_\_\_\_, the prophet who is in Israel, tells the king of Israel the words that you speak in your bedroom.' " **2 KINGS 6:12**
- 1 ACROSS "So he said, 'Go and see where he is, that I may send and get him.' And it was told him, saying, 'Surely he is in \_\_\_\_\_.' " **2 KINGS 6:13**
- 7 ACROSS "Therefore he sent horses and chariots and a great \_\_\_\_\_ there, and they came by night and surrounded the city." **2 KINGS 6:14**
- 5 ACROSS "And when the servant of the man of God arose early and went out, there was an army, \_\_\_\_\_ the city with horses and chariots." **2 KINGS 6:15**
- 8 DOWN "So he answered, 'Do not fear, for those who are with us are \_\_\_\_\_ than those who are with them.' " **2 KINGS 6:16**
- 10 ACROSS "And Elisha prayed, and said, 'LORD, I pray, open his eyes that he may see.' Then the LORD \_\_\_\_\_ the eyes of the young man, and he saw." **2 KINGS 6:17**
- 11 ACROSS "So when the Syrians came down to him,, Elisha prayed to the LORD, and said, 'Strike this people, I pray, with \_\_\_\_\_.' " **2 KINGS 6:18**
- 9 ACROSS "Now Elisha said to them, 'This is not the way, nor is this the city. Follow me, and I will bring you to the man whom you seek.' But he led them to \_\_\_\_\_." **2 KINGS 6:19**



## THE KINGS OF JUDAH AND ISRAEL DURING THE MINISTRIES OF ELIJAH AND ELISHA

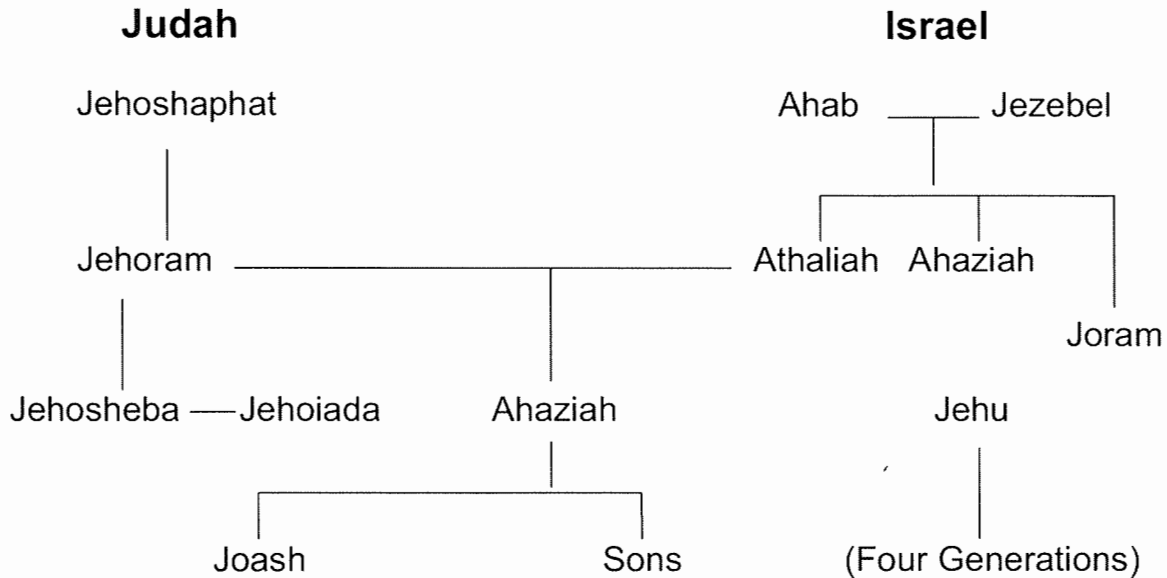

### In Judah:

- *Jehoram* was married to Athaliah, daughter of Ahab and Jezebel, and reigned for eight years
- *Ahaziah*, the son of Jehoram and Athaliah, reigned for one year and was killed by Jehu of Israel
- *Athaliah*, the daughter of Ahab and Jezebel, was married to Jehoram of Judah and reigned for six years after the death of her son Ahaziah; she killed all the sons of Ahaziah except Joash; she was killed by order of Jehoiada the high priest
- *Joash* was the only son of Ahaziah to escape from Athaliah; he was hidden in the temple by Ahaziah's sister Jehosheba (probably half-sister) who was married to Jehoiada, the high priest; he began to reign when he was seven years old and reigned for forty years

### In Israel:

- *Ahaziah*, son of Ahab and Jezebel, reigned two years then died
- *Joram*, son of Ahab and Jezebel, reigned after his brother Ahaziah for twelve years; he was killed by Jehu
- *Jehu*, anointed king by command of God, killed Ahaziah of Judah, Joram of Israel, Jezebel and remaining house of Ahab, then destroyed the Baal worship; he reigned in Israel for 28 years; his dynasty continued unto the fourth generation

### Elijah and Elisha were prophets to Israel:

- *Elijah* ministered during the reigns of Ahab and Ahaziah
- *Elisha* ministered during the reigns of Joram, Jehu, and two of Jehu's descendants

**Year 2**

**Week 95**

**King Uzziah Becomes a Leper**

**Scriptures: II Chronicles 26, II Kings 14, 15**

**Key Verse: II Chron. 26:5 “and as long as he sought the LORD, God made him prosper.”**

**Key Points:**

- 1. Uzziah (Azariah) became king of Judah when he was sixteen, and his 52 year reign was very good because he sought God in all his dealings.**
- 2. The Lord blessed Uzziah with wealth, inventions, and victory in war, and his fame spread far and wide.**
- 3. Uzziah became proud that his reign was so successful. He forgot that God had made him great.**
- 4. One day, Uzziah entered the temple to burn incense. This was a responsibility of the priests, not of the king.**
- 5. The priests stood up to the king, who became very angry.**
- 6. The Lord caused leprosy to come on Uzziah. He lived the rest of his life in isolation, and his son Jotham ruled in his place.**

Proud King Uzziah transgresses against the Lord by entering the temple to burn incense on the altar.

The priests stood up to prevent him and Uzziah became angry.

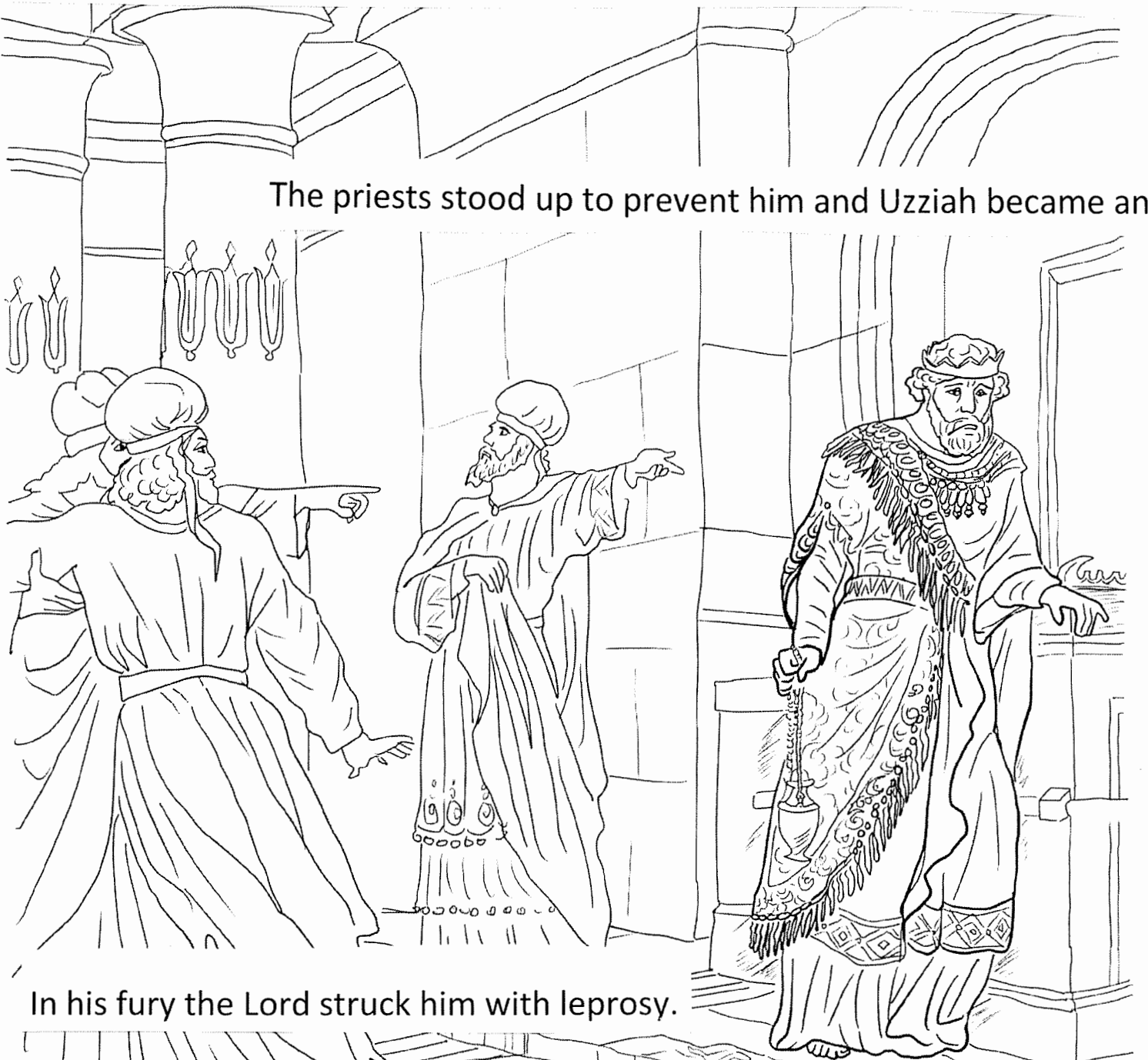

In his fury the Lord struck him with leprosy.

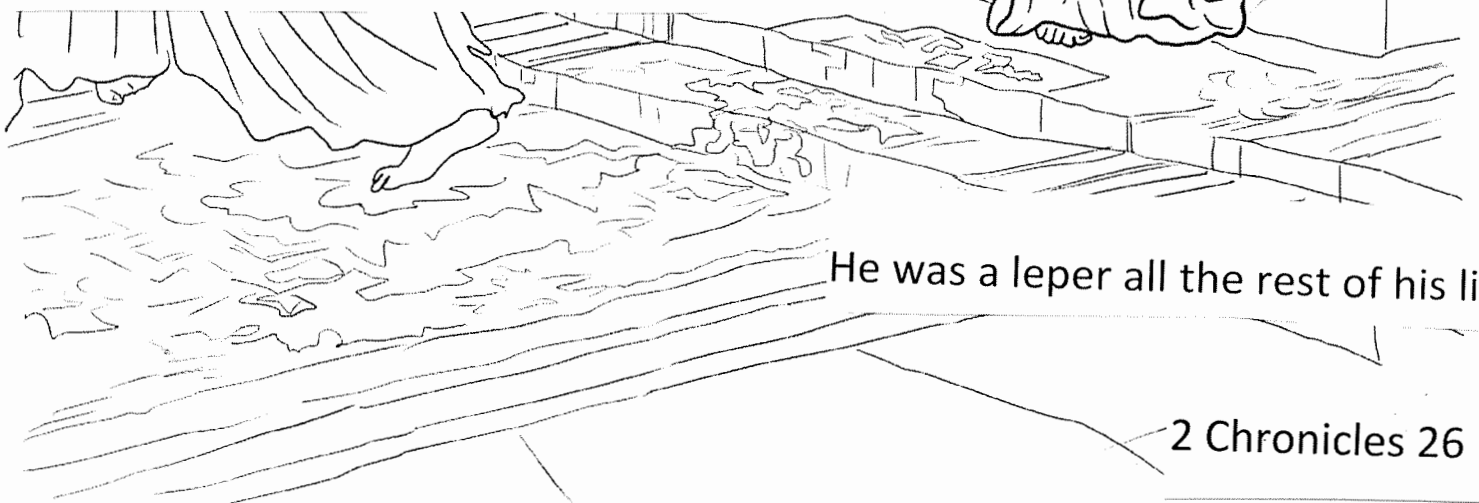

He was a leper all the rest of his life.

## Word Search

K F O L L O W H D F L J  
S W S C K R M D S D P M  
B F A M O U S B P R D N  
J M K G H R B L D C R S  
T P O W E R F U L D C P  
J F C H F P R N Y K D M  
S A R M Y J D R K B N P  
D M S B R T K D F N D S  
R S H I E L D F T J D H  
N R K T D M H P L V S M  
S S P E A R S G J P C T  
P R B M K T S W F D G W

FOLLOW

FAMOUS

POWERFUL

ARMY

SHIELD

SPEARS



**King Uzziah Disobeyed the Lord**  
II Chronicles 26 & II Kings 15:1-7

---



# BIBLESCHOOLRESOURCES.NET

## King Uzziah, The Leper King

### God Punishes Those Who Disobey Him

#### 2 Chronicles 26, 2 Kings 14:21, 15:1-7

Uzziah became king of Judah at the age of 16 and had a great start to his reign. He trusted and obeyed God. As he became more prosperous, Uzziah started to think he didn't need God. Uzziah decided that he would offer incense to God, even though God had commanded that only the priests do that. Uzziah thought he knew better than God!!! God struck King Uzziah with leprosy for his disobedience. Uzziah lived with this terrible disease until he died.

Put a check in the  box if the sentence is true or the  box if the sentence is false.

- |     | <b>True</b>              | <b>False</b>             |                                                                                                           |
|-----|--------------------------|--------------------------|-----------------------------------------------------------------------------------------------------------|
| 1.  | <input type="checkbox"/> | <input type="checkbox"/> | Uzziah was sixty-two years old when he became king of Judah.                                              |
| 2.  | <input type="checkbox"/> | <input type="checkbox"/> | God helped Uzziah win his battles.                                                                        |
| 3.  | <input type="checkbox"/> | <input type="checkbox"/> | Uzziah had the love of the people but was not very prosperous.                                            |
| 4.  | <input type="checkbox"/> | <input type="checkbox"/> | Uzziah listened to the prophets and messengers that God sent to persuade him to continue trusting in God. |
| 5.  | <input type="checkbox"/> | <input type="checkbox"/> | King Uzziah decided he would enter the temple to offer incense on the altar.                              |
| 6.  | <input type="checkbox"/> | <input type="checkbox"/> | God had commanded that only priests enter the temple and offer incense.                                   |
| 7.  | <input type="checkbox"/> | <input type="checkbox"/> | God did not care that King Uzziah disobeyed one of God's commands on how to worship Him.                  |
| 8.  | <input type="checkbox"/> | <input type="checkbox"/> | God struck King Uzziah with leprosy while he was in the temple arguing with the priests.                  |
| 9.  | <input type="checkbox"/> | <input type="checkbox"/> | Because of his leprosy, Uzziah could no longer live in the palace or go to the temple to worship God.     |
| 10. | <input type="checkbox"/> | <input type="checkbox"/> | Uzziah died a faithful follower of God.                                                                   |

### Think! Our Lesson Applied

In our lesson, Uzziah chose to worship God in his own way. God punished him for that. Read Matthew 15:9. Does God care if we make up our own way of worshipping Him?

Visit [BibleSchoolResources.Net](http://BibleSchoolResources.Net) for more free Bible school materials.

© 2004 BibleSchoolResources.Net This worksheet may be duplicated freely for non-commercial use only so long as the copyright statement is not removed and contents are not altered or extracted for use elsewhere.

# The Secret of Success

Uzziah became king when he was only 16 years old, yet he was a successful and powerful ruler for many years. How did he do it? Use these charts to find out. At the top of each column, write the letter indicated by the black square in the box. (See 2 Chronicles 26:1-5.)

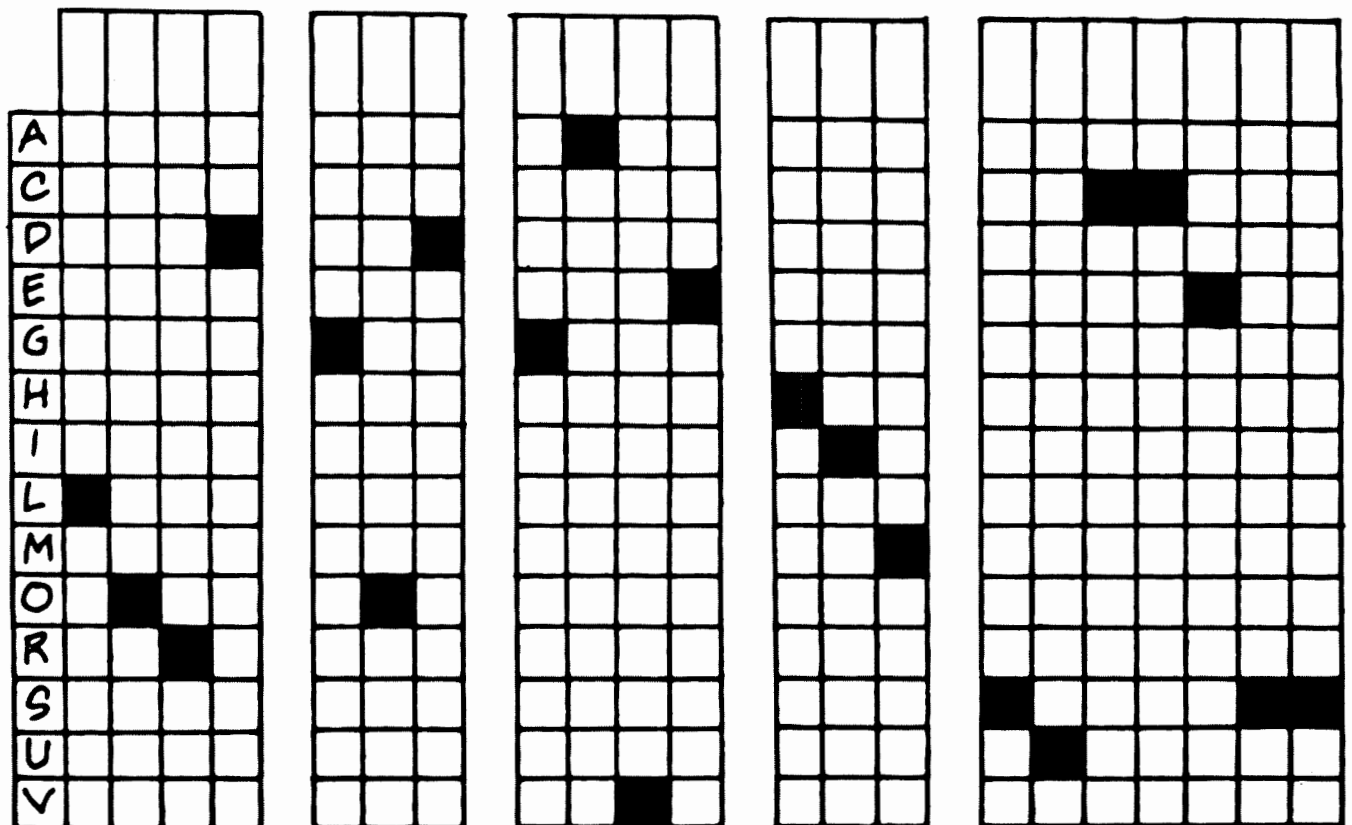
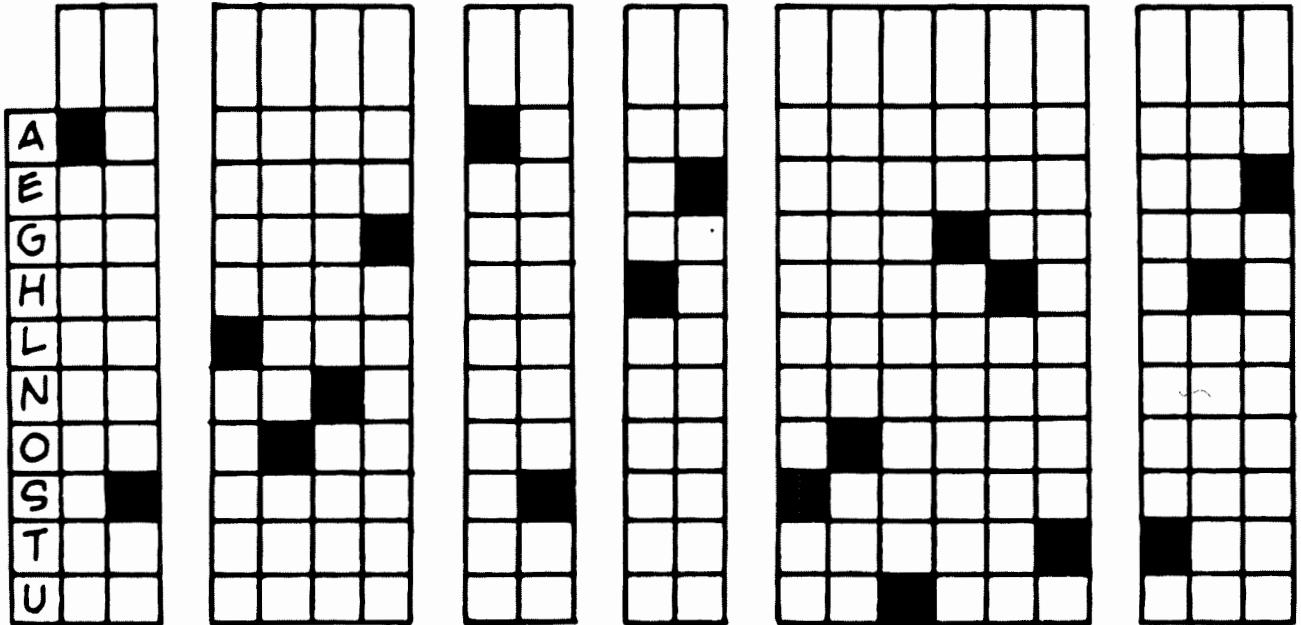

**Year 2**

**Week 96**

**Brave Prophet Isaiah**

**Scriptures: Isaiah 6, 7, 9, 13**

**Key Verse: Isaiah 6:8 “Also I heard the voice of the Lord saying, whom shall I send...Then I said, ‘Here am I, send me.’”**

**Key Points:**

- 1. Isaiah lived during the reigns of Uzziah, Jotham, and Ahaz of Judah.**
- 2. He had a vision and the Lord called him to speak to the people.**
- 3. Jerusalem was under siege by Syria and Israel when Isaiah went to see King Ahaz (Uzziah’s grandson).**
- 4. Isaiah reassured Ahaz that the Lord was with them in the war, and that Assyria would invade Syria and Samaria.**
- 5. Isaiah predicted Christ’s birth, his kingdom and his reign.**
- 6. He also prophesied the judgment of Assyria, and the destruction of Babylon.**



# Isaiah's Vision

Isaiah 6:8

Also I heard the voice of the Lord, saying:

“Whom shall I send,  
And who will go for Us?”

Then I said, “Here *am* I! Send me!”



# Isaiah Was God's Prophet

2 Kings 18-19; Isaiah 7:14-16, 11:1-5, 30, 37

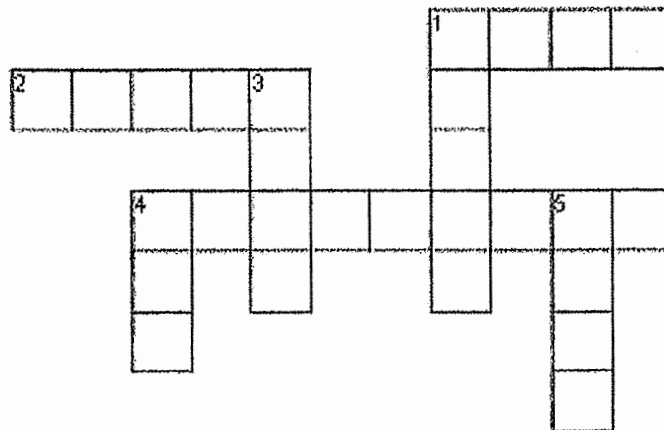

## Across

1. Isaiah prophesied during the reign of \_\_\_\_\_ different kings.
2. Isaiah was a prophet of this country.
4. The name Isaiah means \_\_\_\_\_ of God.

## Down

1. Isaiah was a prophet for \_\_\_\_\_ years.
3. Isaiah told King Hezekiah that God would \_\_\_\_\_ the people.
4. Isaiah prophesied that God would send His \_\_\_\_\_.
5. Isaiah told the people they must \_\_\_\_\_ God.

---

For the word of the Lord is right; and all His works are done in truth.  
Psalm 33:4

---

HOLY HOLY HOLY  
WORD FOR LIFE SAYS

I L R H W L E K O M S T  
L L P I E F E N O E L N  
O O U N C L E A N O S H  
U R D I O M S D R S T T  
Z D E Q P R M D E T H U  
Z O T U L E E R R S H O  
I F F I Y H A L A L R M  
A H I T V P O T P T L S  
H O L Y H O L Y H O L Y  
G S S I X W I N G S E A  
I T M F L S H C A I R P  
H S G N O T M L E H H S

UZZIAH  
LORD  
HOLY HOLY HOLY  
UNCLEAN  
TONGS  
INIQUITY

HIGH  
SERAPHIMS  
EARTH  
PEOPLE  
ALTAR  
VOICE

LIFTED UP  
SIX WINGS  
SMOKE  
LORD OF HOSTS  
MOUTH  
SEND ME

Here I am, Lord Send Me!!!

Trace Kids hands

Cut out &  
glue on.

Isaiah 6:8

Also, I heard the voice of the Lord, saying: "Whom shall I send,  
And who will go for us?" Then I said, "Here am I! Send me."

## Isaiah

P	O	T	T	E	R	R	O	R	A	T	O	R	F	S
N	O	L	Y	B	A	B	O	L	I	S	H	O	U	T
D	E	M	A	H	S	A	P	R	E	A	C	H	R	U
S	C	E	P	T	R	E	S	E	L	T	T	E	N	B
R	A	E	C	A	R	C	A	S	E	I	I	A	A	B
A	E	K	S	E	L	P	M	I	W	E	D	R	C	L
O	P	R	U	D	E	N	T	S	P	O	I	L	E	E
U	P	O	L	S	P	R	I	G	S	T	R	U	S	T
T	E	A	I	N	O	D	R	A	P	R	E	N	R	S
C	E	G	N	V	O	M	I	T	R	O	S	C	U	A
A	H	I	E	G	D	U	J	I	A	D	P	L	C	W
S	S	D	E	H	S	A	D	P	I	D	E	E	A	R
T	O	O	R	U	I	N	O	U	S	E	C	A	S	A
S	W	O	R	D	R	E	G	S	E	N	T	N	T	T
F	E	E	B	L	E	E	R	I	M	A	E	R	E	H

ABOLISH	FEEBLE	OARS	PRUDENT	STUBBLE
ASHAMED	FRO	ORATOR	REEL	SWORD
BABYLON	FURNACE	OUTCASTS	RESPECT	SWORN
CARCASE	GOD IS WITH US	PANGS	RUINOUS	TERROR
CAST	HEAR	PARDON	SCEPTRE	TRODDEN
CURSE	HERE AM I	PEACE	SHEEP	TRUST
DASHED	JUDGE	PIT	SHOUT	UNCLEAN
DEATH	LOP	POMP	SIGH	VOMIT
DEW	MEEK	POTTER	SIN	WASTE
DITCH	MIRE	PRAISE	SOW	WIMPLES
DREGS	NETTLES	PREACH	SPOIL	WOE
			SPRIGS	WRATH



## Prophets Told About Jesus Word Search

Find the words on the list that are hidden in the puzzle. The words can be right to left, up and down, or diagonally.

S O N Q O L O R E D E L I F U  
Z R I T E I F E U G A I T A U  
L C O U N S E L O R S I W T R  
I T N I A A B H E N B S O H D  
T I O N S I D E U G I A N E E  
L A I Q U A T N O N R E D R E  
D R E V E H E X E R T R E U R  
B E T H L E H E M R H I R E R  
S U P I N E P D R E T A F V E  
S U T R N E N E R E T A U V E  
L I M I I I M M A N U E L I D  
U N I A L N Q U A C U E R I T  
L O C E R S C C T E E D I T O  
N U A L A M C E N S E Q U I S  
N O H L Z Q U I E T E R N A L

BETHLEHEM  
BIRTH  
COUNSELOR  
IMMANUEL

ETERNAL  
FATHER  
ISAIAH  
MICAH

PEACE  
PRINCE  
SON  
WONDERFUL

Bible for Children  
presents

# ISAIAH SEES THE FUTURE

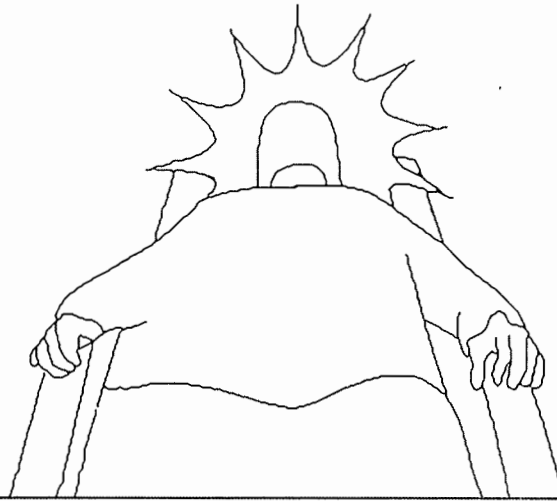

Written by: Edward Hughes

Illustrated by: Jonathan Hay

Adapted by: Mary-Anne S.

Story 27 of 60

[www.M1914.org](http://www.M1914.org)

*Bible for Children, PO Box 3, Winnipeg, MB R3C 2G1 Canada*

License: You have the right to copy or print this story, as long as you do not sell it.

English

Isaiah was a prophet. His job was to tell people what God said.

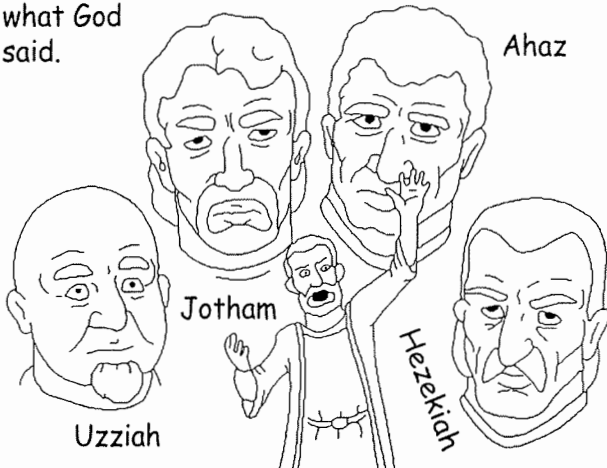

1

People didn't always want to hear God's Word, but Isaiah never let God down. Isaiah preached during the reigns of four different kings.

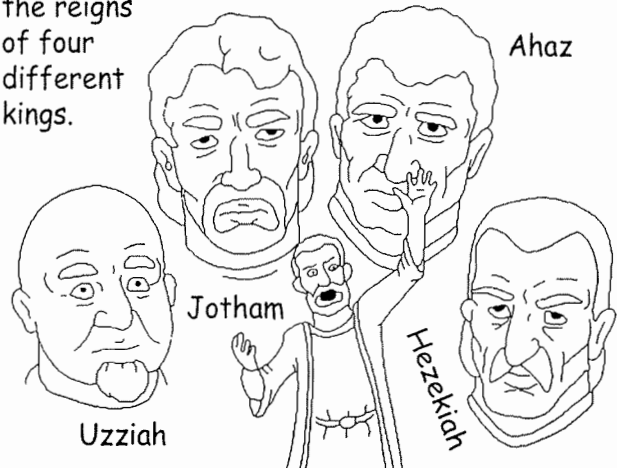

2

King Uzziah ruled the land of Judah from the city of Jerusalem. At first, God blessed Uzziah because he did what was right in the sight of the LORD. But Uzziah became proud and stopped obeying God. He became a leper and had to live alone until he died.

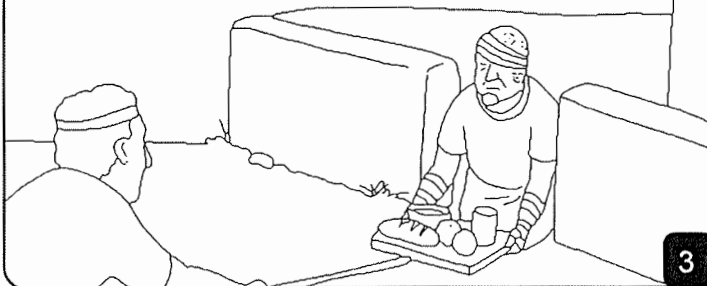

3

King Uzziah reigned for over 60 years. When he died, his son Jotham took his place and reigned for seventeen years. God blessed Jotham because he listened to what God had to say through Isaiah and other prophets.

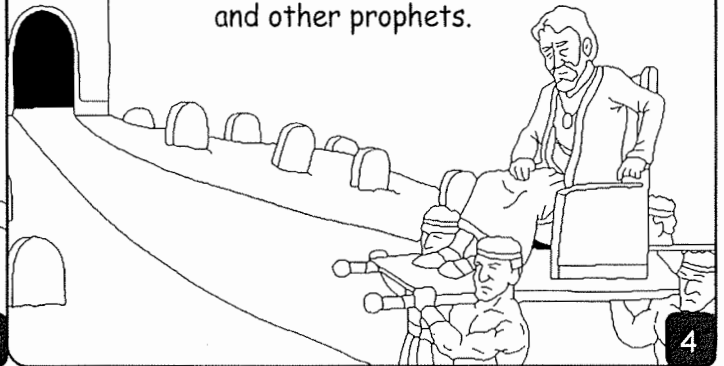

4

King Jotham's son was Ahaz. Ahaz was twenty years old when he began to reign, and he reigned sixteen years in Jerusalem. Ahaz didn't care about God. He worshiped idols and false gods, and led many of God's people to do the same. Although Isaiah warned him, Ahaz wouldn't listen to God's warnings. He died when he was only 35 years old.

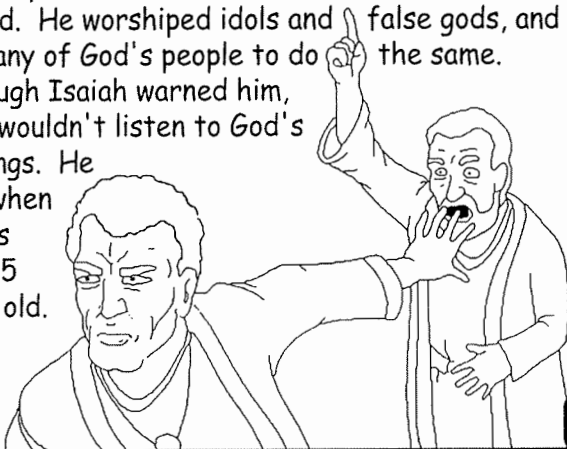

5

God blessed the next king, Hezekiah, because he removed all the idols and false gods, and prayed to the true God. When an enemy army attacked Judah, Hezekiah knew his army was too weak to win. He asked Isaiah to pray for God's help.

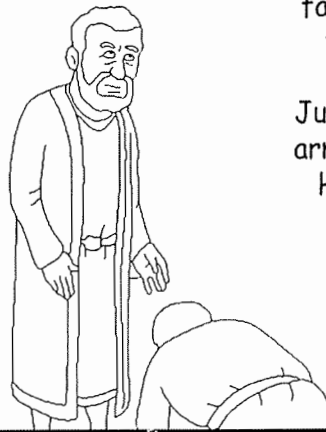

6

Isaiah sent this message to the King. "This is what the LORD says: Don't be afraid of this enemy ... I will cause him to fall ..." Soon after, God made the enemy army leave without even fighting Hezekiah!

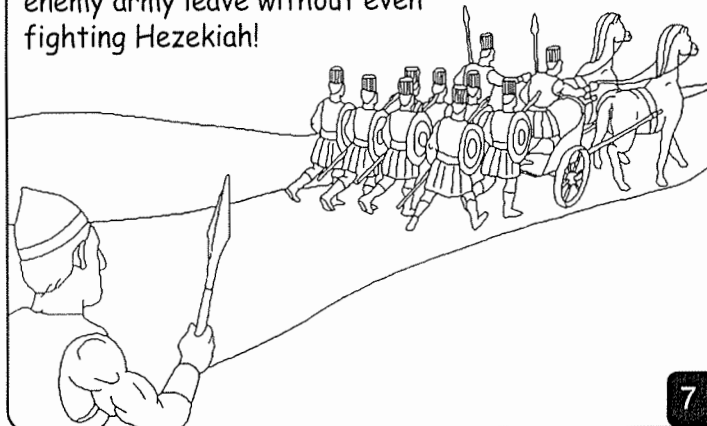

7

Although people around him didn't think much about God, Isaiah thought about

Him a lot.

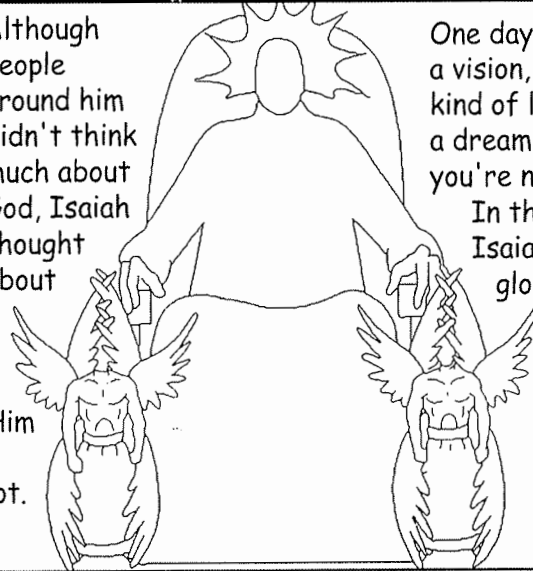

One day, he had a vision, which is kind of like having a dream when you're not asleep. In the vision, Isaiah saw how glorious and holy the LORD is.

8



"Who shall I send?"  
God asked in the vision.  
"Here am I. Send me,"  
Isaiah answered.  
He was willing to do  
whatever God asked,  
and go wherever God  
sent him.



9

Maybe Isaiah thought God would send him  
to faraway people who hadn't heard about  
God. But no, God didn't do that.

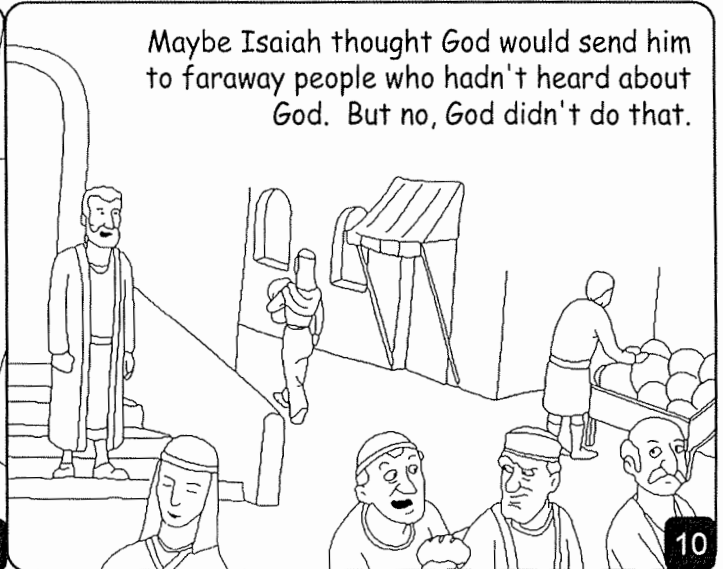

10

God told Isaiah to speak to his own  
people in his own country. He had to tell  
them that God was angry at their sin.

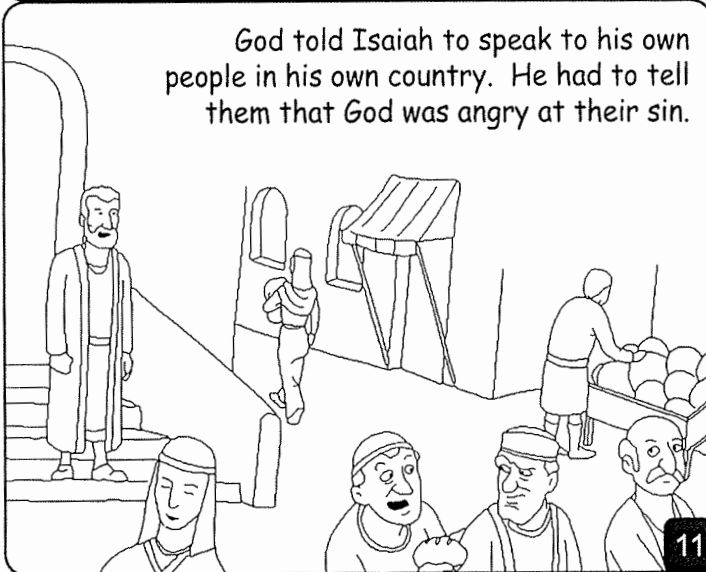

11

There were other things Isaiah had to tell his  
people - wonderful things about a Person who would  
be a strong deliverer and come to save them from  
sin and from all their  
enemies.

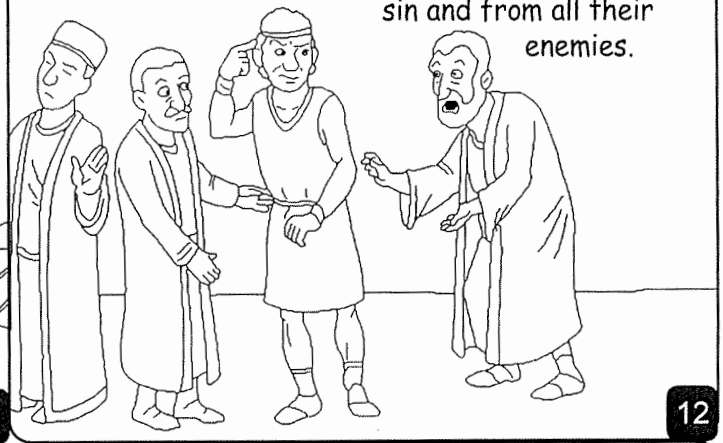

12

The Jewish people called this Person "Messiah".  
Even though they expected God to send Messiah,  
many people lived as if He would never come.

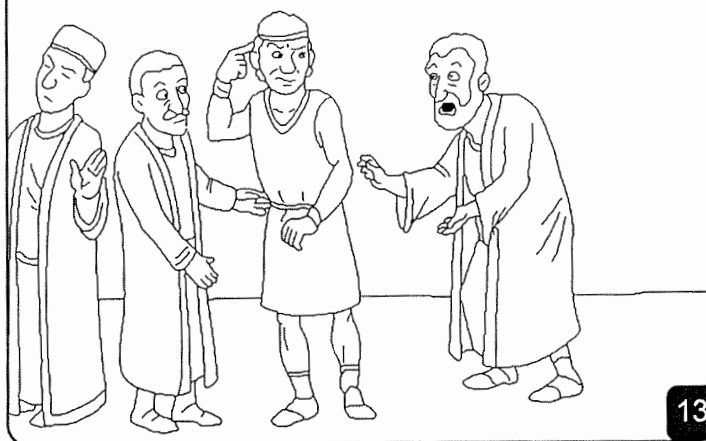

13

All the things  
Isaiah said about  
Messiah are  
written in his  
book. Although  
he wrote these  
things hundreds  
of years before  
they happened,  
everything  
Isaiah said  
about Messiah  
would come true.

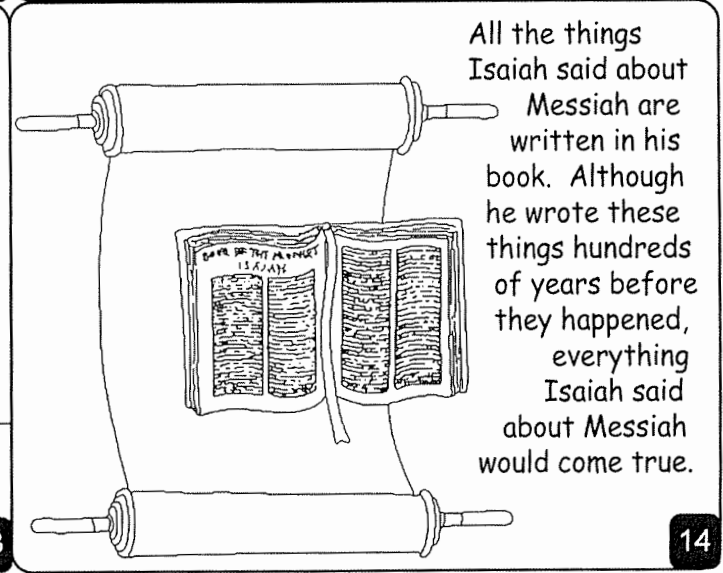

14

Isaiah said that God Himself would give a sign. He said,

"Behold a virgin shall bear a son and call his name Immanuel."



15

People knew Isaiah was talking about God's Messiah

because a woman could not be a virgin and also have a child. Also, the name Immanuel means God with us!

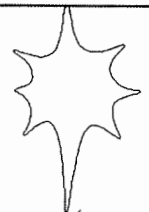

16

"For unto us a Child is born, unto us a Son is given; and the government shall be upon His shoulder. And His name will be called Wonderful, Counselor, Mighty God, Everlasting Father, Prince of Peace." Isaiah was so sure that God's promises would come true, he spoke as if the event had already happened. This is called prophecy.



17

Isaiah said that Messiah would be great and do great things. God also told Isaiah to tell the people that Messiah would suffer and be put to death. Isaiah might have wondered how Messiah could be great and powerful and also weak and injured. But Isaiah didn't argue with God - he just repeated what God told him to say. God would make sure His prophecy came true.

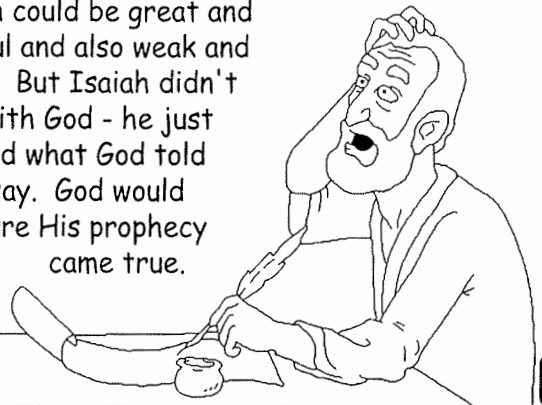

18

Messiah was coming - not just for the Jewish people. God told Isaiah that Messiah would be "a light to the Gentiles". Gentiles are all the people in the world who are not Jews. God loves everybody and His Messiah would come to bless everyone and to bring salvation to the ends of the earth.



19

### Isaiah Sees the Future

A story from God's Word, the Bible,

is found in

Isaiah 1, 6, 7, 9, 53

"The entrance of Your Words gives light."  
Psalm 119:130



**God knows** we have done bad things, which He calls sin. The penalty for sin is death.

**God loves us** so much He sent His Son, Jesus, to die on a Cross and pay our penalty.

**Jesus came alive** and went back to Heaven!  
Now God can forgive our sins.

**If you want to turn from your sins**, say this to God: Dear God, I believe Jesus died for me and now lives again. Please come into my life and forgive my sins, so I can have new life now, and then be with You forever. Help me live for You as Your child. Amen. John 3:16

**Read the Bible and talk to God every day!**

# When the Lord Calls

What did Isaiah say when he heard the voice of the Lord calling for someone to do God's work? Isaiah's answer, which should be our answer too, is hidden in this puzzle. Color all the spaces containing a dot to make the answer appear.

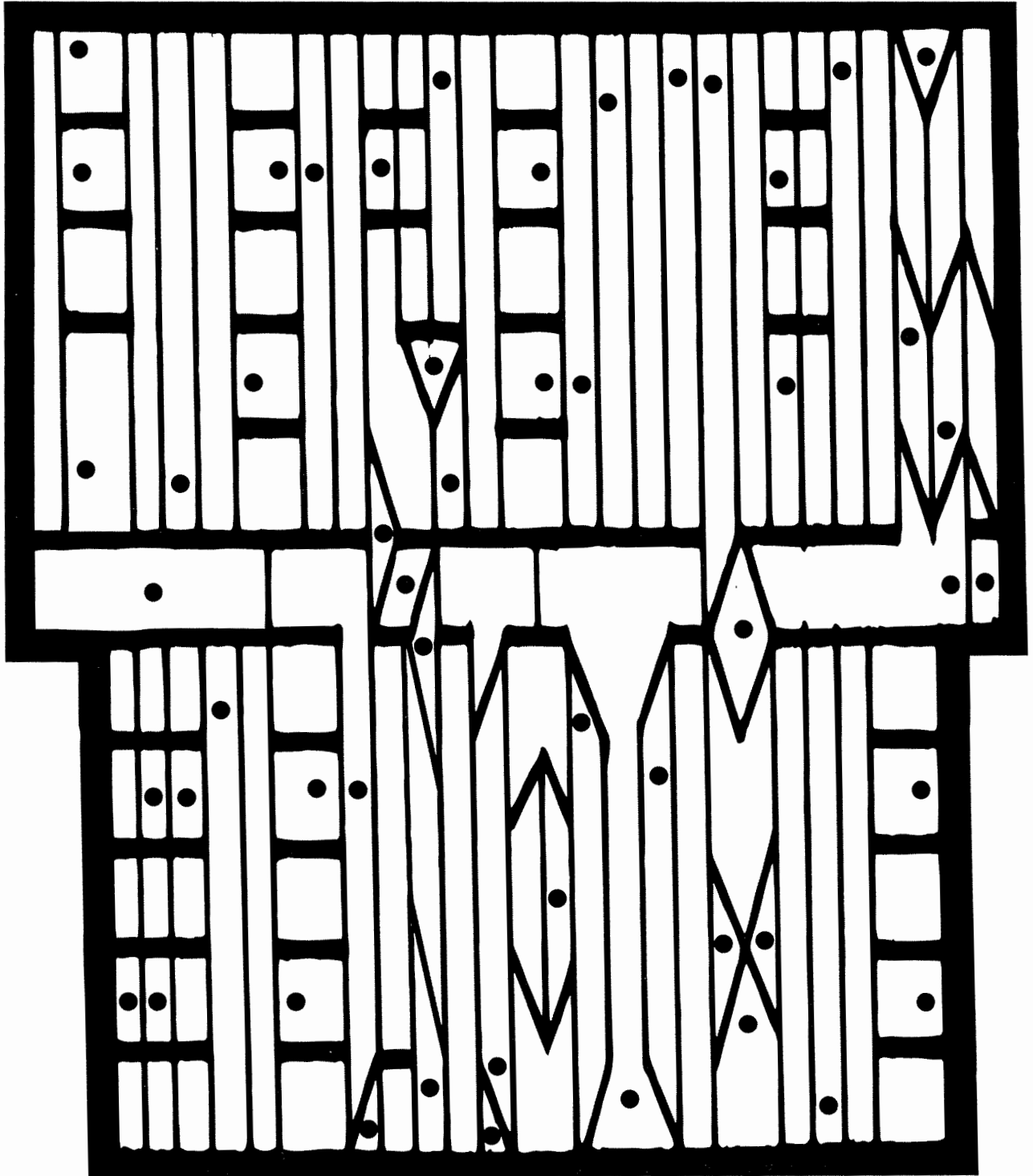

An open book is the central focus, with a sun in the upper right, clouds scattered around, and a rainbow at the bottom. The book's pages contain the text:

The Lord  
will do what  
he says.

Isaiah 38:7

# The Book of Isaiah

<b>Focus</b>	Judgment is Coming				Glory Will Follow				
<b>Divisions</b>	1 Judgment on Judah		12 Judgment on Judah's Neighbors		13 Judgment on All the Earth		27		
	28		35		36		39		
	40		48		49		57		
	58		66						
<b>Topics</b>	Visions			Burdens			Woes		
	Wars			Parentthesis			Sermmons of Comfort		
<b>Place</b>	Judah & Her Neighbors				Israel & the World				
<b>Time</b>	About 40 Years (722-681 B.C.)				Thousands of Years				
<b>Author</b>	The Prophet Isaiah								

# SANCTIFIED LIPS

## (ISAIAH 6:1-13)

### MEMORY VERSE:

*"In the year that King Uzziah died, I saw the Lord sitting on a throne, high and lifted up, and the train of His robe filled the temple." ISAIAH 6:1*

### CIRCLE THE CORRECT WORD:

1. "Above it stood seraphim; each one had six (**HANDS, WINGS**): with two he covered his face, with two he covered his feet, and with two he flew." ISAIAH 6:2

*"And one cried to another and said: 'Holy, holy, holy is the LORD of hosts; the whole earth is full of His glory!' "* ISAIAH 6:3

### TRUE OR FALSE:

2. "And the posts of the door were shaken by the voice of him who cried out, and the house was filled with smoke." ISAIAH 6:4

TRUE OR FALSE

*"Then I said: 'Woe is me, for I am undone! Because I am a man of unclean lips, and I dwell in the midst of people of unclean lips; for my eyes have seen the King, the LORD of hosts.' "* ISAIAH 6:5

### CIRCLE THE CORRECT WORDS:

3. "Then one of the seraphim flew to me, having in his hand a live (**COAL, BOWL**) which he had taken with the tongs from the altar." ISAIAH 6:6

4. "And he touched my (**MOUTH, EARS**) with it." ISAIAH 6:7

*He said, "Behold, this has touched your lips; your iniquity is taken away, and your sin is purged." ISAIAH 6:7*

*"Also I heard the voice of the Lord, saying: 'Whom shall I send, and who will go for Us?' "* ISAIAH 6:8

### FILL IN THE BLANKS:

5. "Then I said, 'Here I am! \_\_\_\_\_.'" ISAIAH 6:8

# SANCTIFIED LIPS

(ISAIAH 6:1-13)



"Then flew one of the seraphims unto me, having a live coal in his hand, *which* he had taken with the tongs from off the altar: And he laid *it* upon my mouth, and said, Lo, this hath touched thy lips; and thine iniquity is taken away, and thy sin purged."

**ISAIAH 6:6-7**



# ISAIAH

Isaiah 6:1-8

Color this picture of Isaiah.

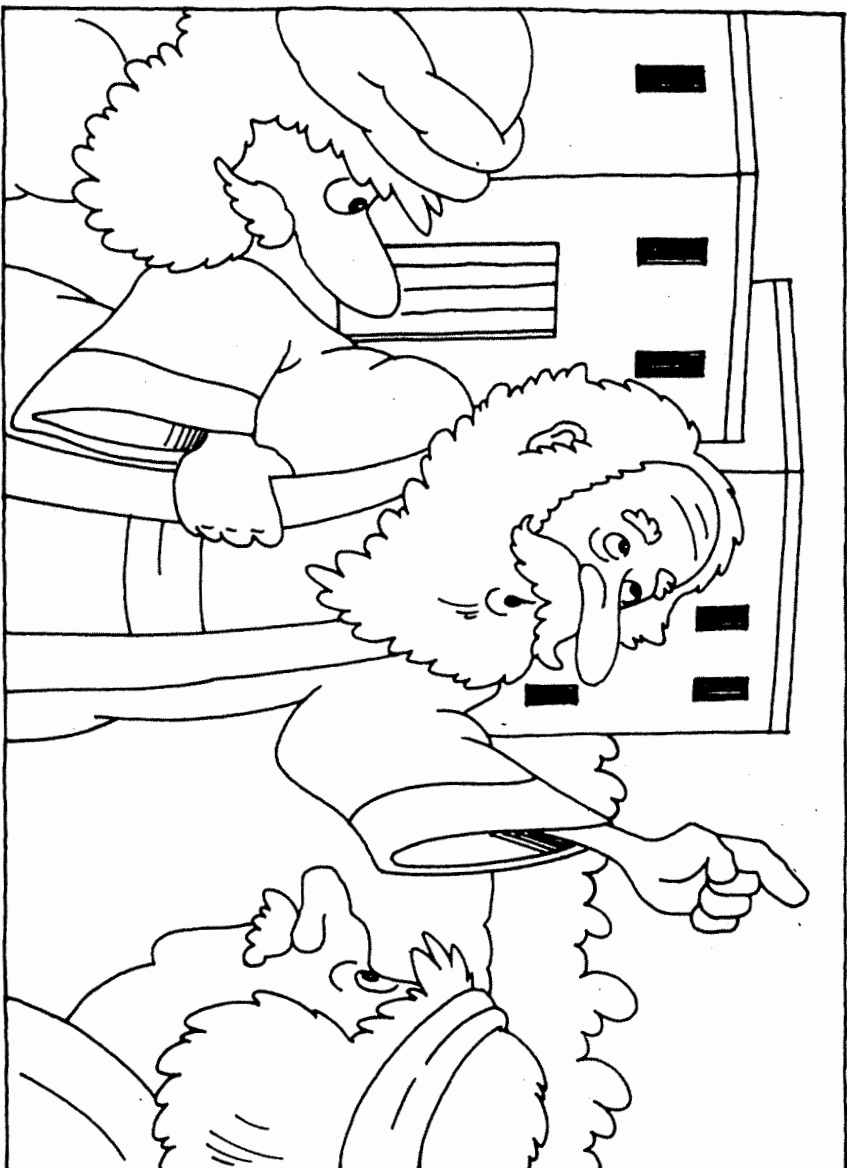

Many people in Bible times learned about God through men called prophets. The prophets taught the people and God gave them messages for the people. One of the most famous prophets was Isaiah. He even wrote one of the books that is in our Bible now.

## ISAIAH'S VISION

In Isaiah 6:2, the angels are described as seraphs "each with six wings. With two wings they covered their faces, with two wings they covered their feet, and with two they were flying."

Please use a pencil and correct the drawing below so it fits the description of a seraph.



# SANCTIFIED LIPS

(ISAIAH 6:1-13)

I S A I A H Q M U M  
E E K T A A D O T X  
J N A E L C N U M N  
O D K W P P V T O O  
U H O L Y L S H E B  
D E I F I T C N A S  
G E L P M E T C L U  
F D S L P V M Z O L  
S E R A P H I M R P  
K B A L A O C L D M

COAL

LORD

SERAPHIM

HOLY

MOUTH

TEMPLE

ISAIAH

SANCTIFIED

UNCLEAN

LIPS

SEND

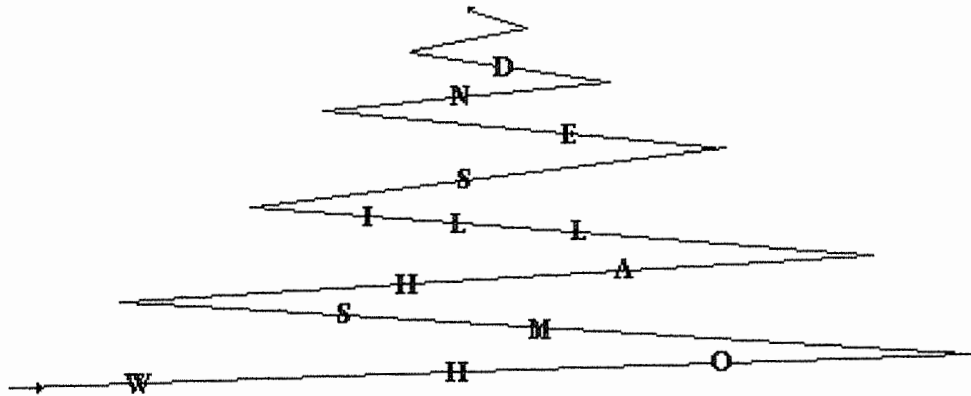

WRITE DOWN THE LETTERS FROM ABOVE AS YOU COME TO THEM ON THE LINES BELOW

" \_\_\_\_\_ ?"

# SANCTIFIED LIPS

## (ISAIAH 6:1-13)

### MEMORY VERSE:

***"In the year that King Uzziah died, I saw the Lord sitting on a throne, high and lifted up, and the train of His robe filled the temple." ISAIAH 6:1***

### UNDERLINE THE CORRECT ANSWER:

1. "Above it stood seraphim; each one had six wings:" ISAIAH 6:2
  - a. with two he covered his face
  - b. with two he covered his feet
  - c. and with two he flew
  - d. all of the above

***"And one cried to another and said: 'Holy, holy, holy is the LORD of hosts; the whole earth is full of His glory!' " ISAIAH 6:3***

### TRUE OR FALSE:

2. "And the posts of the door were shaken by the voice of him who cried out, and the house was filled with smoke." ISAIAH 6:4

TRUE OR FALSE

***"Then I said: 'Woe is me, for I am undone! Because I am a man of unclean lips, and I dwell in the midst of people of unclean lips; for my eyes have seen the King, the LORD of hosts.' " ISAIAH 6:5***

### FILL IN THE BLANKS:

3. "Then one of the seraphim flew to me, having in his hand a live \_\_\_\_\_ which he had taken with the tongs from the altar." ISAIAH 6:6
4. "And he touched my \_\_\_\_\_ with it." ISAIAH 6:7

***He said, "Behold, this has touched your lips; your iniquity is taken away, and your sin is purged." ISAIAH 6:7***

***"Also I heard the voice of the Lord, saying: 'Whom shall I send, and who will go for Us?' " ISAIAH 6:8***

### FILL IN THE BLANKS:

5. "Then I said, 'Here I am! \_\_\_\_\_.'" ISAIAH 6:8

# 142. SANCTIFIED LIPS

## (ISAIAH 6:1-13)

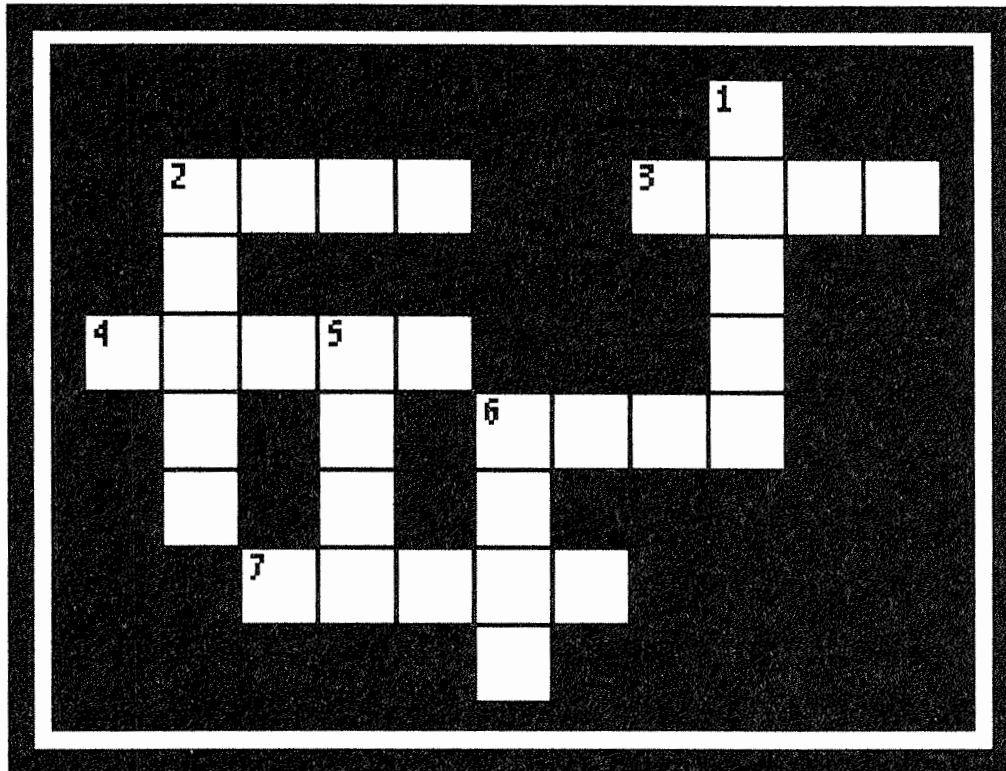

- 6 DOWN "In the year that King Uzziah died, I saw the \_\_\_\_\_ sitting on a throne, high and lifted up, and the train of His robe filled the temple." **ISAIAH 6:1**
- 1 DOWN "Above it stood seraphim; each one had six \_\_\_\_\_: with two he covered his face, with two he covered his feet, and with two he flew." **ISAIAH 6:2**
- 7 ACROSS "And one cried to another and said: 'Holy, holy, holy is the LORD of hosts; the whole earth is full of His \_\_\_\_\_!'" **ISAIAH 6:3**
- 2 DOWN "And the posts of the door were shaken by the voice of him who cried out, and the house was filled with \_\_\_\_\_." **ISAIAH 6:4**
- 3 ACROSS "Then I said: 'Woe is me, for I am undone! Because I am a man of unclean lips, and I dwell in the midst of people of unclean lips; for my eyes have seen the \_\_\_\_\_, the LORD of hosts.'" **ISAIAH 6:5**
- 5 DOWN "Then one of the seraphim flew to me, having in his hand a live \_\_\_\_\_ which he had taken with the tongs from the altar." **ISAIAH 6:6**
- 6 ACROSS He said, "Behold, this has touched your \_\_\_\_\_; your iniquity is taken away, and your sin is purged." **ISAIAH 6:7**
- 4 ACROSS "Also I heard the \_\_\_\_\_ of the Lord, saying: 'Whom shall I send, and who will go for Us?'" **ISAIAH 6:8**
- 2 ACROSS "Then I said, 'Here I am! \_\_\_\_\_ me.'" **ISAIAH 6:8**

# 142. SANCTIFIED LIPS

## (ISAIAH 6:1-13)

S Z U Y J L D A N W W X S S Y Y F F R S  
 N A V A O C R Z B Q J Q R W G E U R W L  
 M F N O W T O U R A F K R I M L C P P M  
 F B K C I S L D E N F H W N R P S Y U H  
 V P K T T C G W B M T Z Q G O M Q Z N E  
 L A J G F I E J O V V G G S U E W O R C  
 A N I L U G F P R O J B D P S T K A H O  
 P F F H D J V I P I K F T K P E J O F A  
 N N M I H P A R E S I J E G I O T T A L  
 Q U C V V H Y N L D L E P G L I H N K T  
 I F N W E T Y A S T L G K V N U E O Q R  
 T Z S U P U U G H M T I B I A P K J L M  
 S O K Z B O N R C H U R P Y E U A P R Y  
 K E E I K M O E L H P O S S L O U R F E  
 M E N W V N J D G R E R S J C P Z A S P  
 M B R D E L N L L Q H Y N D N Q P A Q V  
 U Z Z I A H R T O M W K Z T U X E C E N  
 G Q M R E O Z O R M R Z Y N C H K M R C  
 Y I S B M U Z R Y P C P R W O M Y R L F  
 P K S N V I S A I A H I M N C G V L T N

COAL	LORD	SEND	UNCLEAN LIPS
GLORY	MOUTH	SERAPHIM	UZZIAH
HOLY	ROBE	TEMPLE	VOICE
ISAIAH	SANCTIFIED LIPS	THRONE	WINGS

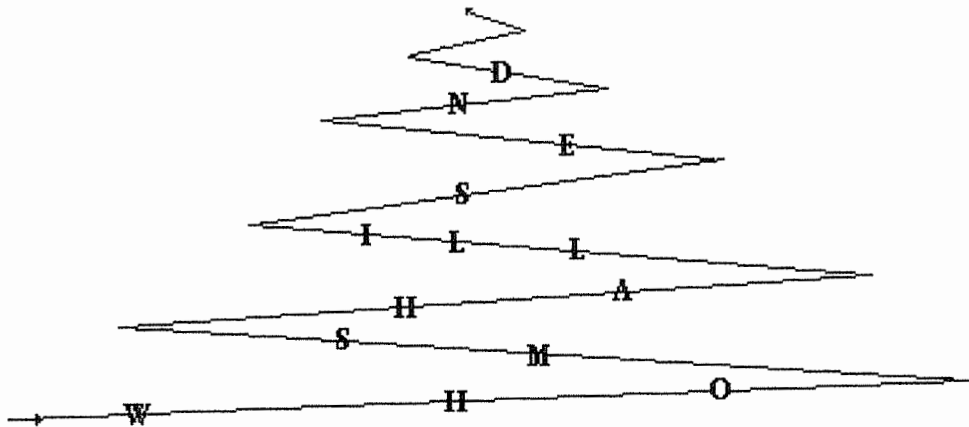

WRITE DOWN THE LETTERS FROM ABOVE AS YOU COME TO THEM ON THE LINES BELOW

" \_\_\_\_\_ ?"

# UNTO US A CHILD IS BORN (ISAIAH 9:1-7)

## MEMORY VERSE:

"And His name will be called Wonderful, Counselor, Mighty God, Everlasting Father, Prince of Peace." ISAIAH 9:6

*The LORD spoke to Isaiah saying...*

## CIRCLE THE CORRECT WORDS:

1. "The people who walked in darkness have seen a great (**NIGHT, LIGHT**)." ISAIAH 9:2
2. "Those who dwelt in the land of the shadow of death, upon them a (**FIGHT, LIGHT**) has shined." ISAIAH 9:2

## FILL IN THE BLANKS:

3. "For unto us a \_\_\_\_\_ is born, unto us a \_\_\_\_\_ is given." ISAIAH 9:6

## TRUE OR FALSE:

4. "And the government will be upon His shoulder." ISAIAH 9:6  
TRUE OR FALSE

## CIRCLE ALL OF THE CORRECT WORDS:

5. "And His name will be called..." ISAIAH 9:6  
Wonderful                                      Counselor                                      Mighty God  
John                                                      Everlasting Father                                      Prince of Peace

## TRUE OR FALSE:

6. "Of the increase of His government and peace there will be no end." ISAIAH 9:7  
TRUE OR FALSE

## CIRCLE THE CORRECT WORD:

7. "The (**ZEAL, SEAL**) of the LORD of hosts will perform this." ISAIAH 9:7

# UNTO US A CHILD IS BORN

## (ISAIAH 9:1-7)

W U O D Z H N J I H Z K E T S E  
 O Q O R F Z V T O A C Q F A T V  
 N S C E H I Q B V W C J J N F E  
 D S F U N V D O G Y T H G I M R  
 E I R O L E S N U O C B T R A L  
 R L K W G V T I Q P Q B E P Y A  
 F S B J L B A A Z P I R J I Y S  
 U J Y N G Q Q M U E W B Z Q O T  
 L E C A E P F O E C N I R P F I  
 K F N S R N O S A S Z T Z D V N  
 T F D L I H C L N G K H K J B G  
 D O M Z Q Y F T M D D G C Q O F  
 G O V E R N M E N T R I T R R A  
 Y P H K I E H Y G E O L I I N T  
 H E L B P L P L F P L K O L P H  
 W F T G H Q S D F G D D V P L E  
 P M H G T R H K P L M F D N W R

<b>BORN</b>	<b>LORD</b>	<b>CHILD</b>
<b>MIGHTY GOD</b>	<b>COUNSELOR</b>	<b>PRINCE OF PEACE</b>
<b>GOVERNMENT</b>	<b>SON</b>	<b>LIGHT</b>
<b>WONDERFUL</b>	<b>EVERLASTING FATHER</b>	





# UNTO US A CHILD IS BORN (ISAIAH 9:1-7)

## MEMORY VERSE:

**"And His name will be called Wonderful, Counselor, Mighty God, Everlasting Father, Prince of Peace." ISAIAH 9:6**

***The LORD spoke to Isaiah saying...***

## FILL IN THE BLANKS:

1. "The people who walked in darkness have seen a great \_\_\_\_\_." **ISAIAH 9:2**
2. "Those who dwelt in the land of the shadow of death, upon them a \_\_\_\_\_ has shined." **ISAIAH 9:2**
3. "For unto us a \_\_\_\_\_ is born, unto us a \_\_\_\_\_ is given." **ISAIAH 9:6**

## TRUE OR FALSE:

4. "And the government will be upon His shoulder." **ISAIAH 9:6**  
**TRUE OR FALSE**

## CIRCLE ALL OF THE CORRECT WORDS:

5. "And His name will be called..." **ISAIAH 9:6**

**Wonderful**

**Counselor**

**Mighty God**

**John**

**Everlasting Father**

**Prince of Peace**

## TRUE OR FALSE:

6. "Of the increase of His government and peace there will be no end." **ISAIAH 9:7**  
**TRUE OR FALSE**

## FILL IN THE BLANK:

7. "The \_\_\_\_\_ of the LORD of hosts will perform this." **ISAIAH 9:7**

# UNTO US A CHILD IS BORN

## (ISAIAH 9:1-7)

B O O H I E I T Y P O C A F L P D E T L S Y N B C  
 Y J S T C M O D Q I M C K B A T U P P J G E E I S  
 K Q L Y T D N D T Y J H U E O W O K L T J E E F G  
 P S K O C E H Q W N K P R I N C E O F P E A C E E E  
 U P E A J W V O U B E R N H A B L J J W P J M W Y  
 Y M W C W Q N E Q B G M S O N H O E M A N A J L U  
 F B V V A D I C R P H E N T P J U F B K D L I H C  
 K B J C E E U U T L G M U R A Y I Y J M Z V Q J W  
 T O X R Y X P J H P A Q D L E K I T H L F K V B I  
 G H F A J I A K T Y D S L U D V B W T U B U E B A  
 E U W L L O R D T F D N T W Y P O U J G X O V K C  
 L S E O T T F S R O V O U I S G R G Y C K Z V J L  
 Y S L Z N A N M R J B Y G Q N L W G R V M X L K P  
 G R C M A L R J W W G M F Y M G A H D U Z A A U A  
 M V V O S B O T P S C A L N T K F E C B X M I M I  
 Q N D F U Z B A N S Z S Y I U H G A Z N I Z L X E  
 H G D M L N F A K I H V H S B G G X T H Z B R Y Y  
 V D Z Q P Z S U B A K Y F V S P T I G H F T U R A  
 V P Z S U N T E C G K K O U E S K V M R E P U T Q  
 G K O Q T K Q E L W R W I U J O W S S A Z R C T A  
 S S W V N O H N D O E L R A M T I U Q U X Z Q C O  
 N P H P D B A Q W A R W F D G W U X U V D F N M Y  
 B P Q B R H U T K F N W Y D O I M H M A K V R P E  
 K R I Q A F U N I U C Z X W V H F U J E L F U M A  
 K X L J Z V T A E T V O D T S J O Q Q I U H K L E

**BORN**

**LORD**

**PRINCE OF PEACE**

**CHILD**

**MIGHTY GOD**

**SON**

**COUNSELOR**

**NAME**

**WONDERFUL**

**EVERLASTING FATHER**

**PEACE**

**ZEAL**

**GOVERNMENT**



# Which Way to Go?

The confusion of signs holds an important message.

To discover what the signs say, start at the first set of signs on the left side of the page and read the signs down the pole, then progress to the next pole. If the sign points left, then count the letters from right to left and record the correct letters on the lines. If the sign points right, count the letters from left to right.

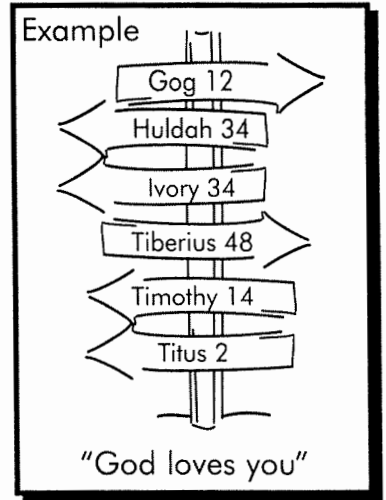

Isaiah prophesied about the birth of Jesus. He said the Lord himself would give them a sign. What was the sign? (Isaiah 7:14)

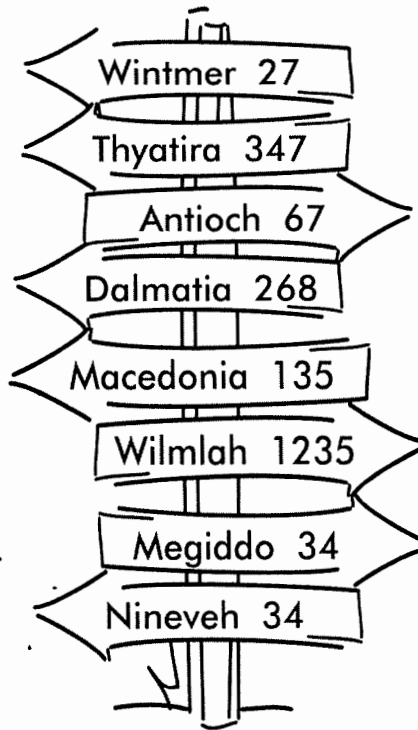

**Year 2**

**Week 97**

## **10 Lost Tribes of Israel**

**Scriptures: II Chron 28,29,30,31:1 and II Kings 17,18,19**

**Key Verse: 2Kings 19:34 “ 'For I will defend this city to save it for my own sake and for My servant David's sake.' ”**

### **Key Points:**

1. King Ahaz of Judah, and King Hoshea of Israel did not follow God. King Hoshea decided to subject himself to the King of Assyria, and King Ahaz defaced the temple and worshiped idols.

2. After King Ahaz died, his son Hezekiah became king of Judah. He led his people to repent. He restored the temple, tore down the idols, and brought the people together to offer sacrifices for the Passover.( 2Chron. 30-31 describes how eagerly they repented.) Hezekiah also asked the 10 tribes of Israel to join Judah in their worship to God. A few people from the 10 Tribes accepted this invitation humbly, but the rest made fun of it.

3. Not only did the 10 Tribes refuse to repent, but King Hoshea also decided to stop paying tribute to Assyria. Sennacherib put King Hoshea in prison, and took the 10 tribes of Israel captive. Sennacherib decided to conquer Judah while he was at it. He told Hezekiah and the people of Jerusalem to surrender, and belittled God's power to defend them. (2 Chron 32:10-19)

4. King Hezekiah asked the prophet Isaiah for advice. Isaiah told him not to be afraid. (2 Kings 19:6-7) Hezekiah prayed to God for deliverance. In the night, an angel of the Lord killed 185,000 people in the Assyrian camp. Sennacherib went home to Assyria and was killed by his two sons while he worshiped in the temple of his pagan god.

# ISRAEL IS CARRIED TO ASSYRIA

(2 KINGS 17:5-41)

S I N N E D R U A K  
 O S D G E F P Z S K  
 A Y L T E R C E S Y  
 T M T A I K P V Y R  
 M R R I M A G E R G  
 S E C A L P H G I H  
 D A I R A M A S A I  
 Z P N K I N G F R K  
 W O R S H I P E D U  
 J C N D E V R E S A

ASSYRIA	KING	SERVED
FEARED	SAMARIA	SINNED
HIGH PLACES	SECRETLY	WORSHIPED
IMAGE		

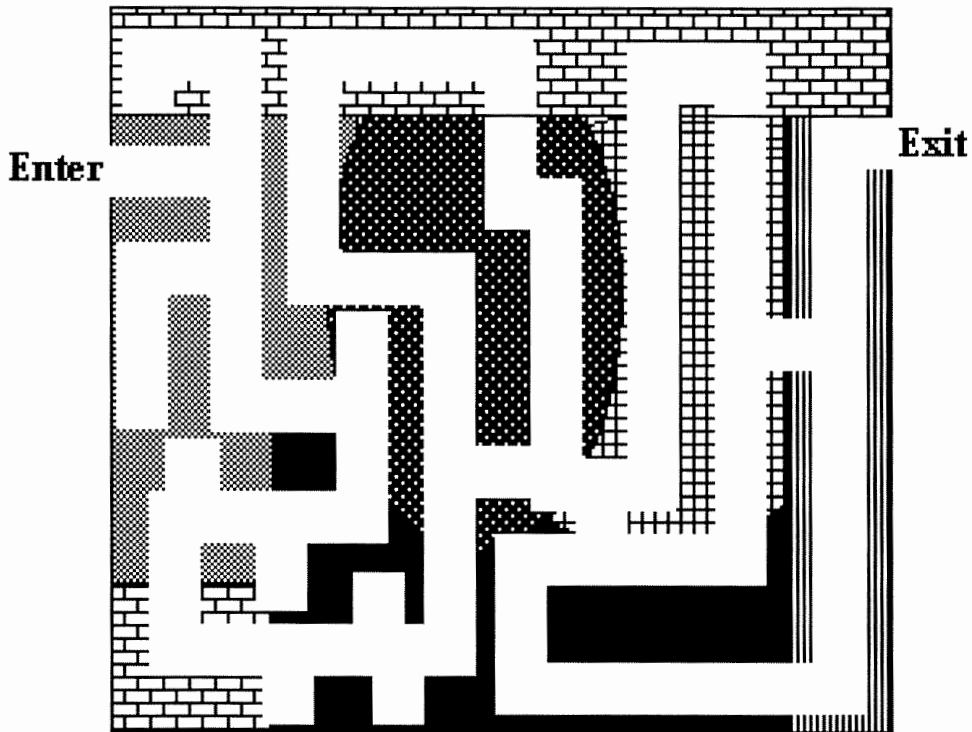

# ISRAEL IS CARRIED TO ASSYRIA

## (2 KINGS 17:5-41)

### MEMORY VERSE:

*"But the LORD your God you shall fear; and He will deliver you from the hand of all your enemies."* 2 KINGS 17:39

### TRUE OR FALSE:

1. "The king of Assyria went throughout all the land, and went up to Samaria and besieged it for three years." 2 KINGS 17:5

TRUE OR FALSE

2. In the ninth year of Hoshea, the king of Assyria took Samaria and carried Israel away to Egypt. 2 KINGS 17:6

TRUE OR FALSE

### CIRCLE THE CORRECT WORDS:

3. "For so it was that the children of Israel had (**CRIED, SINNED**) against the LORD their God, who had brought them up out of the land of Egypt, from under the hand of Pharaoh king of Egypt." 2 KINGS 17:7
4. "Also the children of Israel (**SECRETLY, OPENLY**) did against the LORD their God things that were not right, and they built for themselves high places in all their cities, from watchtower to fortified city." 2 KINGS 17:9

### TRUE OR FALSE:

5. "They left all the commandments of the LORD their God, made for themselves a molded image and two calves, made a wooden image and worshiped all the host of heaven, and served Baal." 2 KINGS 17:16

TRUE OR FALSE

### FILL IN THE BLANK:

6. "Therefore the LORD was very angry with Israel, and removed them from His sight; there was none left but the tribe of \_\_\_\_\_ alone." 2 KINGS 17:18

### CIRCLE THE CORRECT WORD:

7. "Then the king of Assyria brought (**CHARIOTS, PEOPLE**) from Babylon, Cuthah, Ava, Hamath, and from Sepharvaim, and placed them in the cities of Samaria instead of the children of Israel." 2 KINGS 17:24

### TRUE OR FALSE:

8. "These nations feared the LORD, yet served their carved images." 2 KINGS 17:41

TRUE OR FALSE

# ISRAEL IS CARRIED TO ASSYRIA

## (2 KINGS 17:5-41)

```

U Q V P R I Z G Q G Q O S W T
R S F B S N N B N W J F P K B
S S I R C I U A H W I M A G E
Y D A W K D E P I H S R O W V
N E U E S U U V M R J U W O D
L V Y N A E I B G D A D J I E
Y R L A G S C W Q I C M H L V
R A T I O V S A W C P I A D R
G C E P W F I Y L P V V N S E
N O R Q J E N Y R P D E F S S
A E C D V A N U L I H M G W Q
F Z E R H R E K I L A G I J O
L P S O Y E D Y O O I N I L V
K E H L G D P H N P M B E H Y
I U I F M E Q F S D O A G J P
    
```

**ANGRY**  
**ASSYRIA**  
**CARVED**  
**FEARED**  
**HIGH PLACES**

**IMAGE**  
**ISRAEL**  
**KING**  
**LIONS**  
**LORD**

**SAMARIA**  
**SECRETLY**  
**SERVED**  
**SINNED**  
**WORSHIPED**

WRITE DOWN THE LETTERS AS YOU COME TO THEM ON THE LINES BELOW

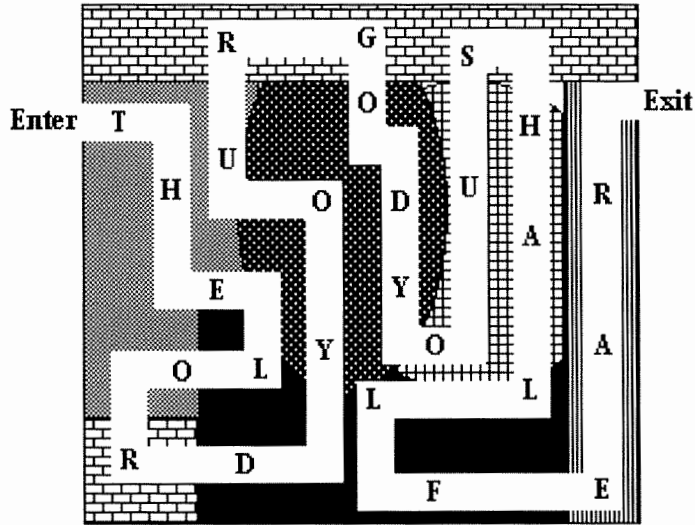

# ISRAEL IS CARRIED TO ASSYRIA

## (2 KINGS 17:5-41)

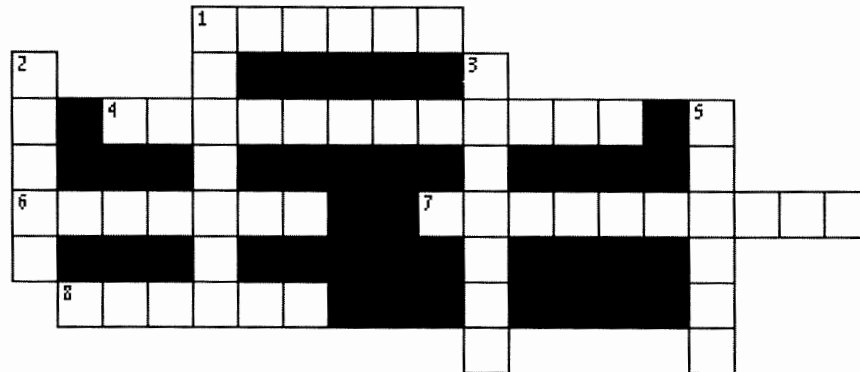

- 6 ACROSS "The king of \_\_\_\_\_ went throughout all the land, and went up to Samaria and besieged it for three years." **2 KINGS 17:5**
- 8 ACROSS "In the ninth year of Hoshea, the king of Assyria took Samaria and carried \_\_\_\_\_ away to Assyria." **2 KINGS 17:6**
- 1 ACROSS "For so it was that the children of Israel had \_\_\_\_\_ against the LORD their God, who had brought them up out of the land of Egypt, from under the hand of Pharaoh king of Egypt." **2 KINGS 17:7**
- 7 ACROSS "Also the children of Israel openly did against the LORD their God things that were not right, and they built for themselves \_\_\_\_\_ in all their cities, from watchtower to fortified city." **2 KINGS 17:9**
- 4 ACROSS "They left all the \_\_\_\_\_ of the LORD their God, made for themselves a molded image and two calves, made a wooden image and worshiped all the host of heaven, and served Baal." **2 KINGS 17:16**
- 2 DOWN "Therefore the LORD was very angry with Israel, and removed them from His sight; there was none left but the tribe of \_\_\_\_\_ alone." **2 KINGS 17:18**
- 1 DOWN "Then the king of Assyria brought people from Babylon, Cuthah, Ava, Hamath, and from Sepharvaim, and placed them in the cities of \_\_\_\_\_ instead of the children of Israel." **2 KINGS 17:24**
- 3 DOWN "But the LORD your God you shall fear; and He will \_\_\_\_\_ you from the hand of all your enemies." **2 KINGS 17:39**
- 5 DOWN "These nations \_\_\_\_\_ the LORD, yet served their carved images." **2 KINGS 17:41**



# What Was Their Downfall?

Read 2 Kings 17:7-18. Start with the circle that is numbered the same as the sentence and follow the arrows to fill in the blanks. When completed, you will find some bad things Israel did to cause their downfall with God.

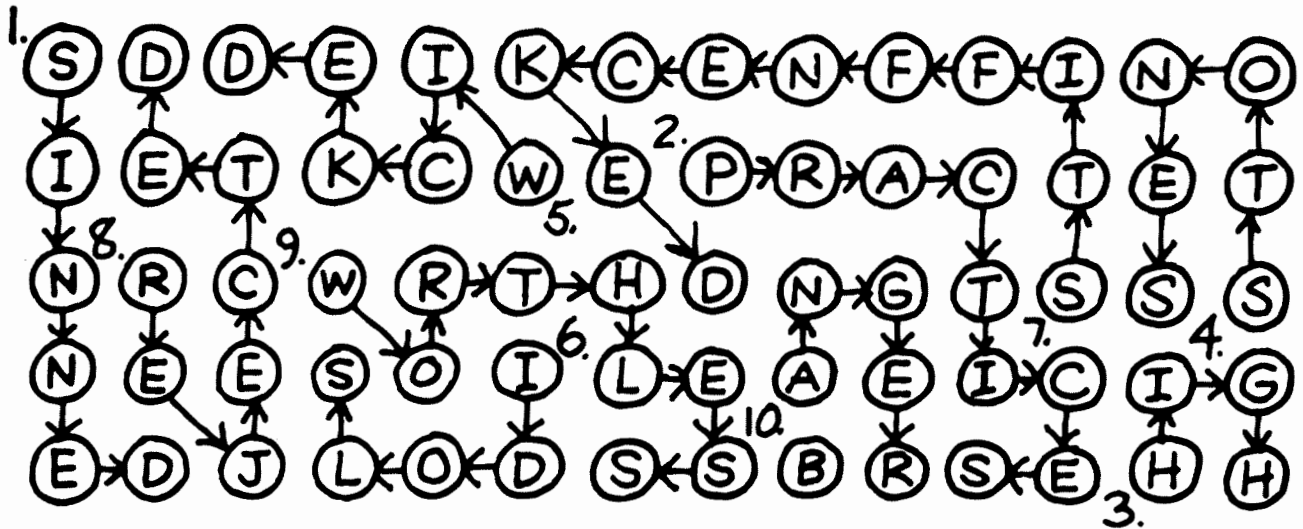

1. The Israelites had \_\_\_\_\_ against the Lord their God.
2. They followed the \_\_\_\_\_ of the nations the Lord had driven out.
3. They built themselves \_\_\_\_\_ places in all their towns.
4. They set up sacred \_\_\_\_\_ and poles.
5. They did \_\_\_\_\_ things that provoked the Lord to anger.
6. They worshiped \_\_\_\_\_.
7. They would not listen and were as \_\_\_\_\_ as their fathers.
8. They \_\_\_\_\_ his decrees and covenant.
9. They became \_\_\_\_\_.
10. They provoked the Lord to \_\_\_\_\_.

**Year 2**

**Week 98**

## **God Answers Hezekiah**

**Scriptures: II Chronicles 32, II Kings 20**

**Key Verse: 2 Kings 20:5 " 'Return and tell Hezekiah the leader of My people, 'Thus says the LORD , the God of David your father; I have seen your tears; surely I will heal you. ' "**

### **Key Points:**

1. Hezekiah was sick and near death. The prophet Isaiah told him to put his affairs in order because God said he would die. Hezekiah asked God to spare his life. God told Isaiah to convey that He had heard Hezekiah's prayer, and that He would add fifteen years to his life. Hezekiah asked Isaiah for a sign to prove that God would indeed spare him. Isaiah asked God to move the shadow backward ten degrees on a sundial.

2. After God spared Hezekiah's life, Hezekiah became proud. This angered God. Hezekiah realized his fault and humbled himself, so God spared Judah during the life of Hezekiah.

3. Hezekiah became very rich (2 Chronicles 32:27-30), and when the Babylonian ambassadors came to visit Jerusalem after Hezekiah's sickness, they asked to see everything in his house, his treasury, his armory, and his kingdom. Anything they wanted to see, he was happy to show them. After the Babylonians left, Isaiah came to see Hezekiah. He asked Hezekiah how much he had shown the Babylonians. When he heard that Hezekiah had shown them everything, Isaiah told him that, after his death, everything he had would be taken away to Babylon. Hezekiah's own descendants would be servants in the house of the Babylonian king.

4. Hezekiah died and was buried with his fathers. Manasseh becomes king of Judah.

# Basic Zigzag Crown

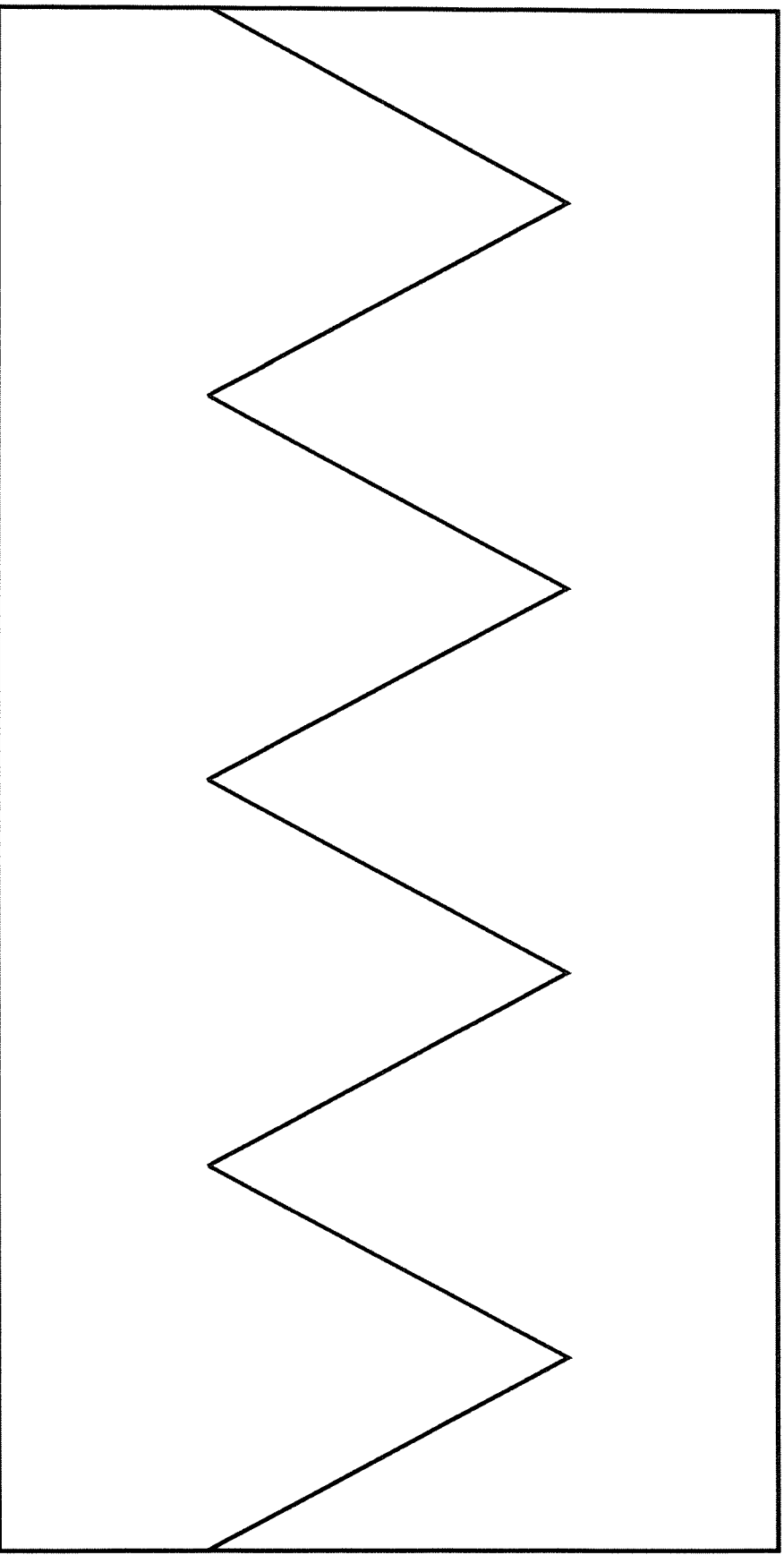

# 114. HEZEKIAH RESTORES TEMPLE WORSHIP

(2 CHRONICLES 29:20-36)



"And Hezekiah commanded to offer the burnt offering upon the altar.  
And when the burnt offering began, the song of the LORD began *also*  
with the trumpets, and with the instruments *ordained* by David king of Israel."

2 CHRONICLES 29:27

"And the consecrated things *were* six hundred oxen and three thousand sheep." 2 CHRONICLES 29:33

# Bible Pathway Adventures

CROSSWORD

## KING HEZEKIAH'S GOLD

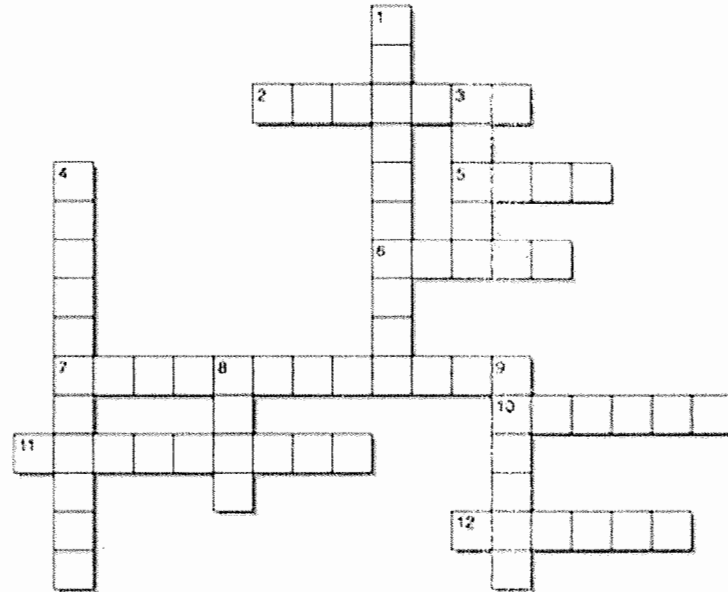

### ACROSS

- 2) Hezekiah cut down the \_\_\_\_\_. (2 Kings 18:4)  
5) Hezekiah gave the Assyrians \_\_\_\_ from the Temple. (2 Kings 18:16)  
6) Enemies attacked Israel because they worshipped \_\_\_\_\_ gods.  
(2 Kings 17:15)  
7) The King of Judah kept God's \_\_\_\_\_. (2 Kings 18:6)  
10) Hezekiah asked for help from this prophet. (2 Kings 19:20)  
11) The king of Assyria ordered his soldiers to attack this city.  
(2 Kings 18:17)  
12) Hezekiah took gold and silver from the \_\_\_\_\_, (2 Kings 18:16)

### DOWN

- 1) Hezekiah was \_\_\_\_\_ years old when he began to rule Judah.  
(2 Kings 18:1)  
3) The \_\_\_\_ of God killed many enemy soldiers. (2 Kings 19:35)  
4) Name of the Assyrian king who attacked Judah. (2 Kings 18:13 ESV)  
8) Hezekiah was the son of this man. (2 Kings 18:1)  
9) The king of Assyria demanded three hundred talents of \_\_\_\_ and thirty  
talents of gold. (2 Kings 18:14)

FOR MORE FREE BIBLE RESOURCES AND TEACHER PACKS INCLUDING COLORING PAGES,

WORKSHEETS, QUIZZES AND MORE VISIT OUR WEBSITE AT

[WWW.BIBLEPATHWAYADVENTURES.COM](http://WWW.BIBLEPATHWAYADVENTURES.COM)

1 King Hezekiah of Judah was a righteous leader. He prayed for the Lord's help in defending his country from its enemies, and he followed the counsel of the prophet Isaiah. (See **Isa. 37.**)

2 When King Hezekiah became very ill, the prophet Isaiah visited him and warned him that he would soon die. (See **Isa. 38:1.**)

3 Upon hearing this, Hezekiah turned his face to the wall and wept. He did not want to die, so he prayed, crying, "Remember now, O Lord, I beseech thee, how I have walked before thee in truth and with a perfect heart." (See **Isa. 38:2–3.**)

4 The Lord told Isaiah to visit King Hezekiah again and tell him that He had seen the king's tears and had heard his prayers. The Lord promised to add fifteen years to King Hezekiah's life. (See **Isa. 38:4–5.**)

5 As a sign that He would keep His promise to heal King Hezekiah, the Lord caused the sun to go backward ten degrees. Isaiah told King Hezekiah to watch the shadow on a large sundial to see the miraculous sign. (See **Isa. 38:7–8.**)

6 King Hezekiah recovered from his illness and composed a beautiful psalm to praise the Lord's goodness. "The Lord was ready to save me: therefore we will sing my songs to the stringed instruments," he wrote. (See **Isa. 38:9–20.**)

**God Reverses the Sun's Shadow**  
2 Kings 20:1-11; Isaiah 38:1-8

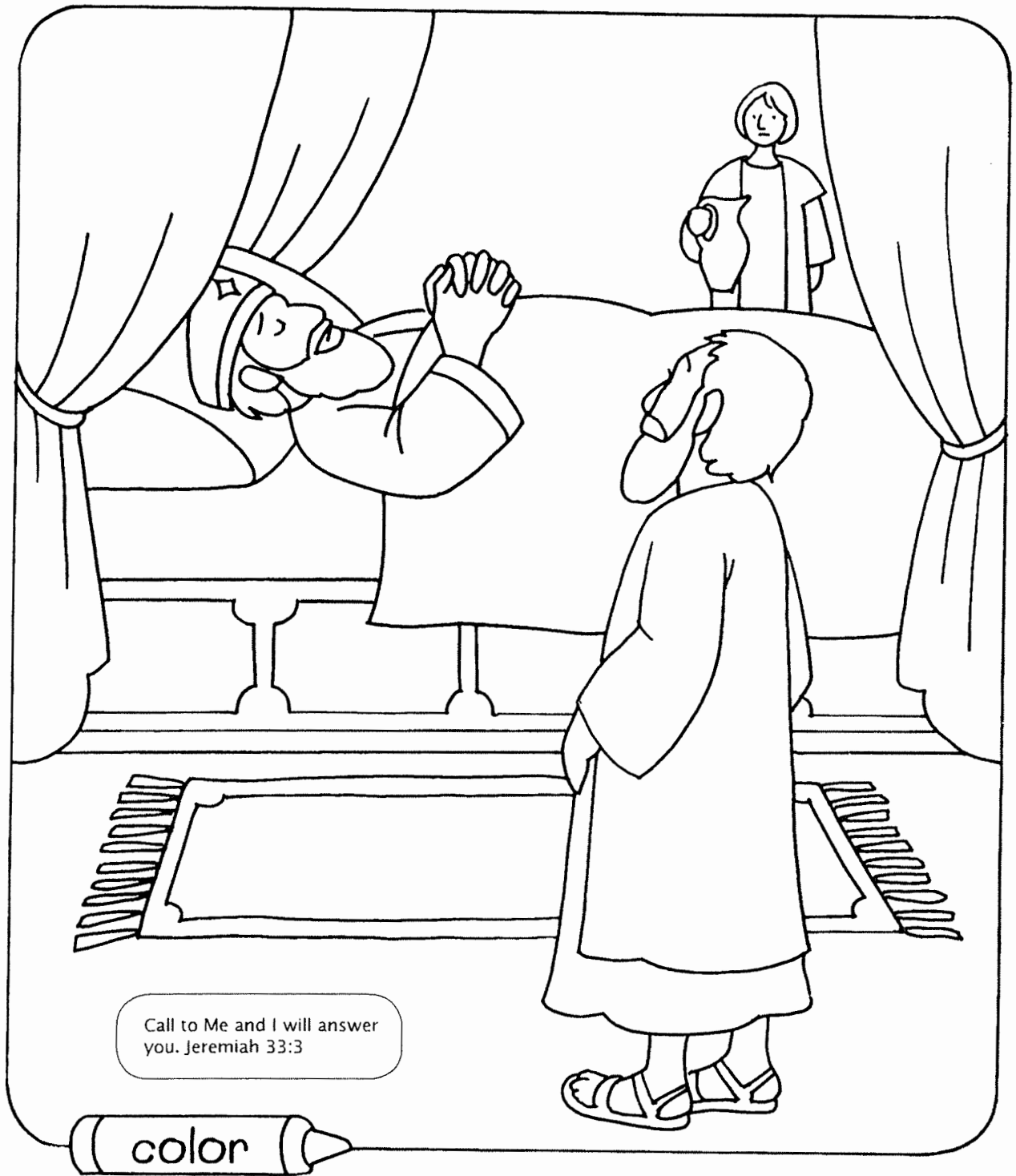

Call to Me and I will answer you. Jeremiah 33:3



## Craft Guide

- Make a paper plate sundial -

### Lesson 8: God Reverses the Sun's Shadow

#### Paper-Plate Stage

*Materials:* For each project, you will need a copy of Activity Pages 8A and 8B from the Early Childhood Teacher Guide, a 9-inch paper plate, construction paper, paper brads, markers or crayons, and scissors.

*Instructions:* Make copies of Activity Pages 8A and 8B. Have the children color both pages. Cut each section of pictures out. Glue the Bible story scenes to one half of the plate and the scenes that show prayer opportunities to the other half. Cut out the hand, or trace around the child's hand onto construction paper and cut it out. Use a paper brad to attach the hand through the middle to the center of the plate. Move the hand backwards to retell the story. Move the hand forward on the bottom half to talk about how God wants us to pray to Him at all times. Let the children make the Hezekiah figure into a storytelling figure by attaching it to a straw or cup.

*Option:* You will need a place to store this project so it can dry and be sent home next week. Have children make clay plaques of their handprint. Ahead of time, make the clay by mixing 1 cup salt, ½ cup flour, and 1 cup water in a saucepan. Cook over low heat, stirring constantly until thick and rubbery. Cool and store in an airtight container.

In class, roll a ball of clay for each child into a circle and flatten so that it is about ¼-inch thick. Have each child make a hand imprint in the clay, keeping fingers together so that it looks like a praying hand. Poke a hole at the top for hanging. Let the clay dry. In two days, turn it over to dry on the other side. Help the children string yarn through it the next week. If desired, they can paint or decorate it with art supplies. Send it home the next week along with the Bible Words. As you are working on the project, talk about how God promises to hear and answer our prayers.

#### Prayer Book

**To Prepare:** For each book, you will need several pieces of craft paper, paper punches, yarn, scissors, and markers.

First, fold in half two or more pieces of craft paper. Then trace and cut out several praying hand pages with the edge of the hand on the fold. Open the pages and punch two holes along the edge of the fold. Cut a piece of yarn, and tie the pages together on the outside of the book. Inside write the names of people for whom you would like to pray, draw their pictures, or add photos or special prayers.

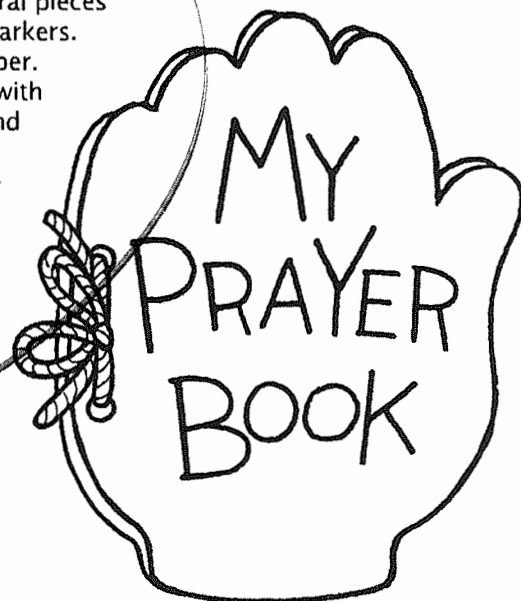



# Isaiah and King Hezekiah

By Tryn Paxton

## ISAIAH AND KING HEZEKIAH

By Tryn Paxton/illustrated by Virginia Sargent

**1** King Hezekiah of Judah was a righteous leader. He prayed for the Lord's help in defending his country from its enemies, and he followed the counsel of the prophet Isaiah. (See Isaiah 37.)



**2** When King Hezekiah became very ill, the prophet Isaiah visited him and warned him that he would soon die. (See Isaiah 38:1.)

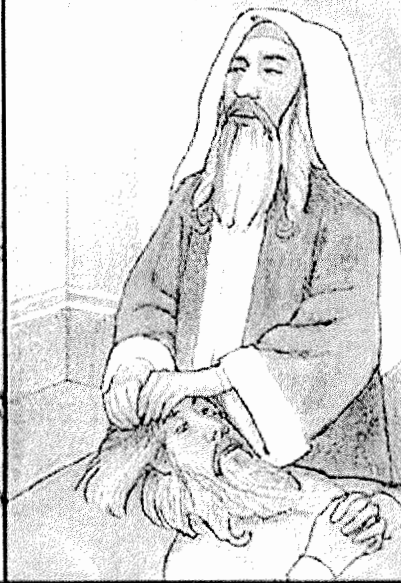

**3** Upon hearing this, Hezekiah turned his face to the wall and wept. He did not want to die, so he prayed, crying, "Remember now, O Lord, I beseech thee, how I have walked before thee in truth and with a perfect heart." (See Isaiah 38:2-3.)



**4** The Lord told Isaiah to visit King Hezekiah again and tell him that He had seen the king's tears and had heard his prayers. The Lord promised to add fifteen years to King Hezekiah's life. (See Isaiah 38:4-5.)

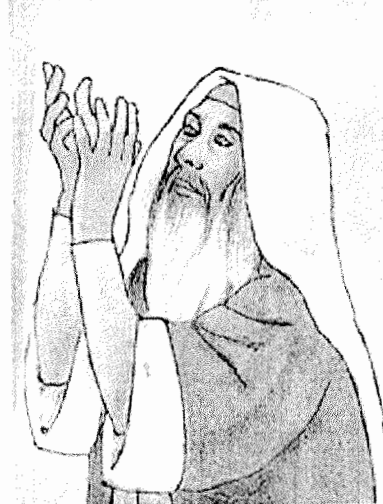

**5** As a sign that He would keep His promise to heal King Hezekiah, the Lord caused the sun to go backward ten degrees. Isaiah told King Hezekiah to watch the shadow on a large sundial to see the miraculous sign. (See Isaiah 38:7-8.)

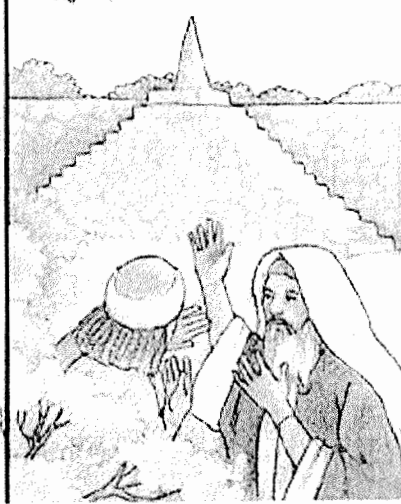

**6** King Hezekiah recovered from his illness and composed a beautiful psalm to praise the Lord's goodness. "The Lord was ready to save me; therefore we will sing my songs to the stringed instruments," he wrote. (See Isaiah 38:9-22.)



(click to view larger)

# HEZEKIAH CLEANSSES THE TEMPLE

## (2 CHRONICLES 29:3-19)

H	E	Z	E	K	I	A	H	S	S
C	J	J	M	U	G	N	E	A	P
O	R	C	O	N	V	T	N	N	R
V	E	X	I	D	I	C	W	E	I
E	P	K	O	V	T	R	L	L	E
N	A	V	E	I	A	O	P	P	S
A	I	L	F	T	R	B	W	M	T
N	R	I	H	D	E	A	J	E	S
T	E	D	H	S	I	B	B	T	R
D	D	C	L	E	A	N	S	E	L

COVENANT

LORD

RUBBISH

HEZEKIAH

PRIESTS

SANCTIFIED

KING

REPAIRED

WRATH

LEVITES

CLEANSE

TEMPLE

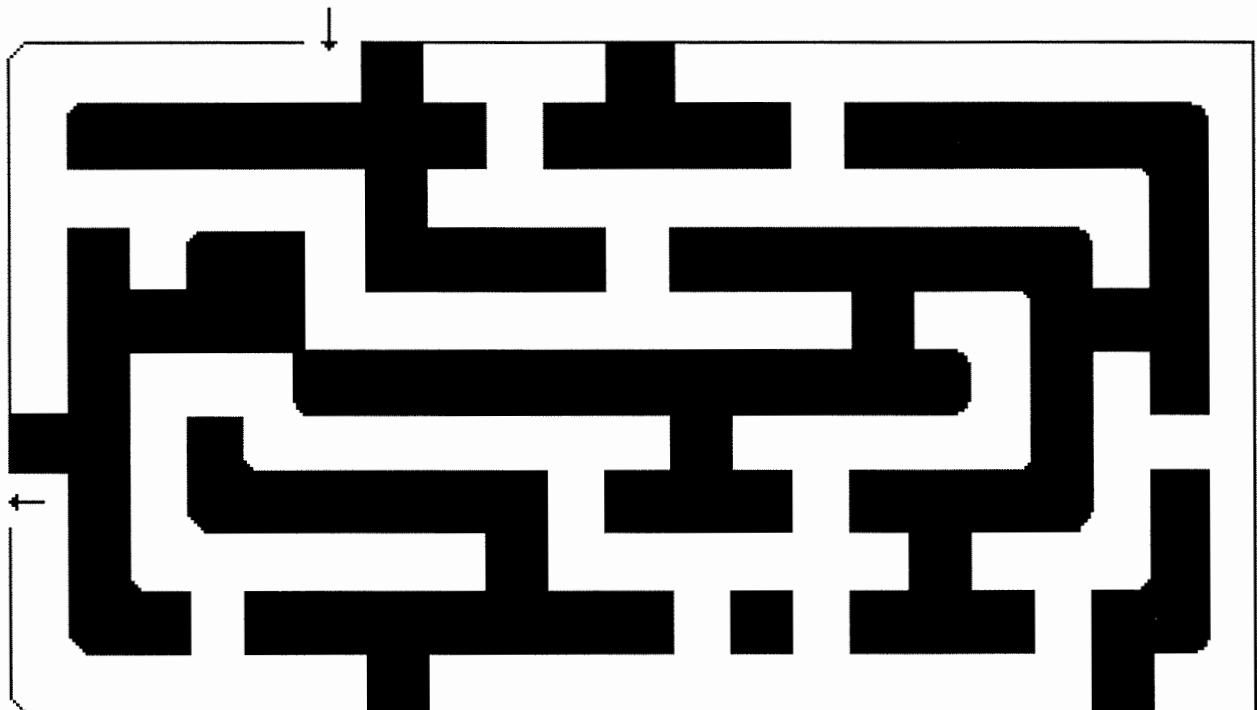

# HEZEKIAH CLEANSSES THE TEMPLE

## (2 CHRONICLES 29:3-19)

I	E	T	N	E	M	D	N	A	M	M	O	C	M	C
M	Q	S	F	R	A	R	T	K	G	Y	Y	H	T	O
J	T	T	G	R	U	B	K	N	V	Z	A	Q	G	Z
C	T	W	G	K	Y	I	D	G	A	I	B	Q	J	D
W	C	D	A	U	E	R	F	E	K	N	P	F	O	O
G	L	E	Z	P	U	D	Q	E	R	R	E	E	X	O
G	E	I	I	B	D	A	Z	C	S	I	B	V	F	R
V	A	F	B	S	K	E	N	E	E	Q	A	G	O	S
B	N	I	N	Q	H	M	T	B	A	V	N	P	O	C
I	S	T	T	V	J	I	I	B	B	I	N	Z	E	M
H	E	C	S	Y	V	D	G	V	K	E	Y	H	F	R
F	B	N	Y	E	Y	I	J	T	E	M	P	L	E	J
D	G	A	L	E	S	T	S	E	I	R	P	F	V	A
L	S	S	T	L	L	R	L	W	R	A	T	H	E	P
Y	I	J	G	P	Y	G	D	K	D	R	O	L	H	N

CLEANSE  
 COMMANDMENT  
 COVENANT  
 DOORS  
 HEZEKIAH

KING  
 LEVITES  
 LORD  
 PRIESTS  
 REPAIRED

RUBBISH  
 SANCTIFIED  
 TEMPLE  
 WRATH

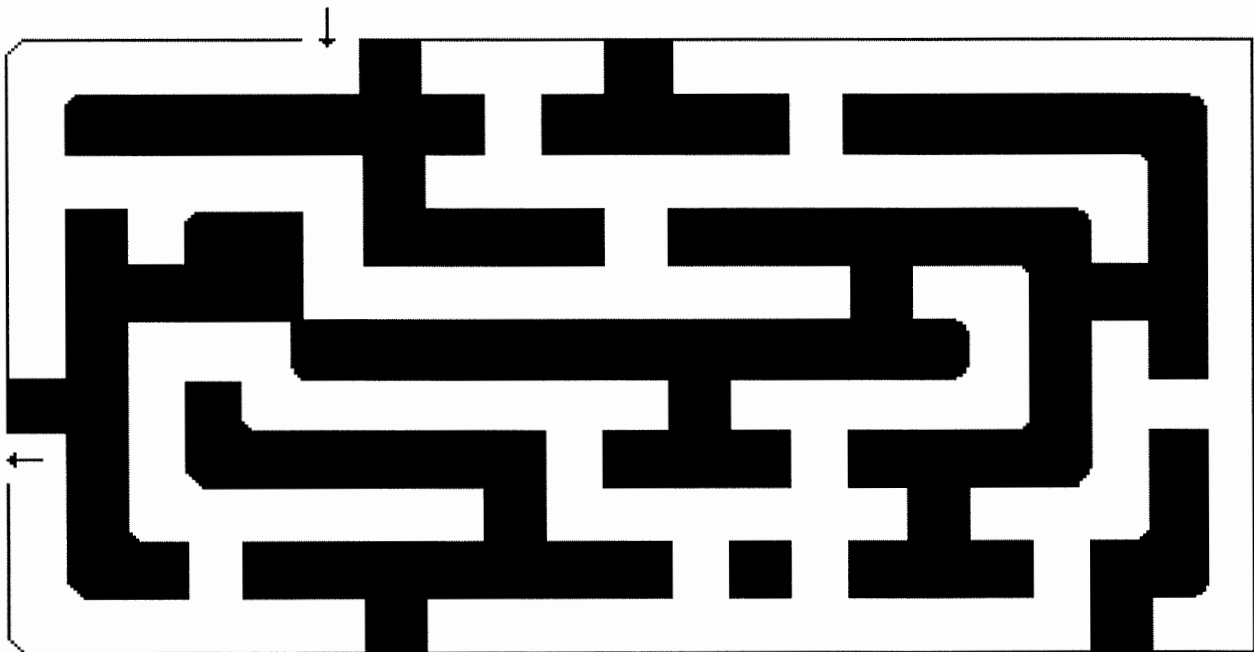

# HEZEKIAH RESTORES TEMPLE WORSHIP

(2 CHRONICLES 29:20-36)



“And Hezekiah commanded to offer the burnt offering upon the altar.  
And when the burnt offering began, the song of the LORD began *also*  
with the trumpets, and with the instruments *ordained* by David king of Israel.”

**2 CHRONICLES 29:27**

“And the consecrated things *were* six hundred oxen and three thousand sheep.” **2 CHRONICLES 29:33**

# HEZEKIAH RESTORES TEMPLE WORSHIP

## (2 CHRONICLES 29:20-36)

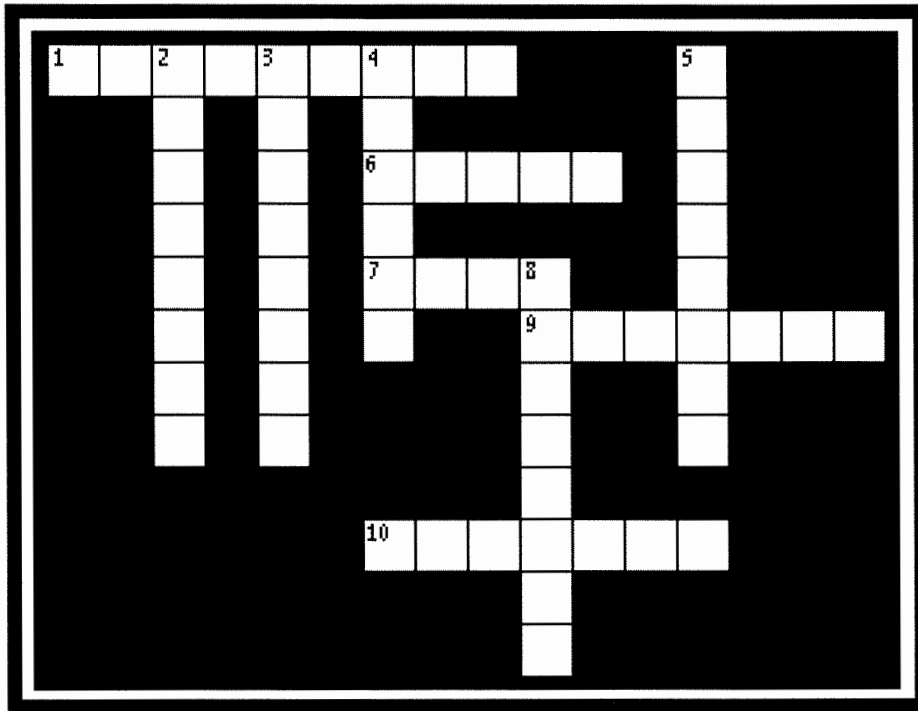

- 3 DOWN "King \_\_\_\_\_ rose early, gathered the rulers of the city, and went up to the house of the LORD." **2 CHRONICLES 29:20**
- 6 ACROSS "Then he commanded the priests, the sons of Aaron, to offer them on the \_\_\_\_\_ of the LORD." **2 CHRONICLES 29:21**
- 9 ACROSS "Then he stationed the \_\_\_\_\_ in the house of the LORD with cymbals, with stringed instruments, and with harps." **2 CHRONICLES 29:25**
- 10 ACROSS "The Levites stood with the instruments of David, and the \_\_\_\_\_ with the trumpets." **2 CHRONICLES 29:26**
- 7 ACROSS "Then Hezekiah commanded them to offer the burnt offering on the altar. And when the burnt offering began, the \_\_\_\_\_ of the LORD also began, with the trumpets and with the instruments of David king of Israel." **2 CHRONICLES 29:27**
- 5 DOWN "So all the congregation worshiped, the singers sang, and the trumpeters sounded; all this continued until the burnt \_\_\_\_\_ was finished." **2 CHRONICLES 29:28**
- 1 ACROSS "And when they had finished offering, the king and all who were present with him bowed and \_\_\_\_\_." **2 CHRONICLES 29:29**
- 4 DOWN "Moreover King Hezekiah and the leaders commanded the Levites to sing \_\_\_\_\_ to the LORD with the words of David and of Asaph the seer." **2 CHRONICLES 29:30**
- 8 DOWN "So they sang praises with \_\_\_\_\_, and they bowed their heads and worshiped." **2 CHRONICLES 29:30**
- 2 DOWN "Hezekiah and all the people \_\_\_\_\_ that God had prepared the people, since the events took place so suddenly." **2 CHRONICLES 29:36**

# Hezekiah Is Healed 2 Kings 20:1-11



# Tell Hezekiah's Story

Read 2 Kings 20:1-11 to find the words you need to fill in the blanks in the story below. Or, you can choose words from the word list that fit the blanks. Then take the letters inside the shapes and complete the sentence at the bottom of the page.

(v. 1) \_\_\_\_\_  \_\_\_\_\_ became very sick.

(v. 1) The \_\_\_\_\_  \_\_\_\_\_ \_\_\_\_\_ Isaiah went to see him.

(v. 2) Hezekiah turned toward the \_\_\_\_\_  \_\_\_\_\_ and prayed to the Lord.

(v. 3) Hezekiah \_\_\_\_\_  \_\_\_\_\_  loudly.

(v. 4) The Lord spoke his word to \_\_\_\_\_ .









(v. 5) "Go back and tell Hezekiah, I have heard your \_\_\_\_\_  \_\_\_\_\_ ."

(v. 8) Hezekiah asked, "What will be the \_\_\_\_\_  \_\_\_\_\_ that the Lord will heal me?"

(v. 10) Hezekiah answered, "Let the shadow go back ten \_\_\_\_\_  \_\_\_\_\_ ."

### Word List

cried  
Hezekiah  
Isaiah  
prayer  
sign  
steps  
wall  
prophet

The     \_\_\_\_\_ will do what he    

## For Thinkers Only

# The Sun Stood Still.....

One day, Joshua was in the midst of an important battle with the Amorites. He was winning, but the sun was beginning to set, and he was afraid the enemy would escape in the darkness. So he prayed and asked God to stop the sun in the sky. God did just that! The sun stood still for almost 24 hours while Joshua won the battle. Impossible????? Not for God! (Joshua 10)

# Then It Moved Backward!

As if the Joshua story were not miraculous enough, God caused something even more strange and impossible to happen.

King Hezekiah's health was bad. The Lord had already told him that he needed to prepare himself to die, but the king was not ready to die. He was a good man and asked God to let him live 15 years longer. God sent the prophet Isaiah to tell Hezekiah the good news that He was going to answer his prayer with a big YES!

Well, Hezekiah could hardly believe it. He was skeptical. He asked for proof that God was really going to heal him and let him live. God said, "I will have the shadow on your sundial suddenly move forward 10 points or backward 10 points. Which way do you want it to move?" Hezekiah chose backward because he knew it would be more difficult or unusual for the sun to move backward ..... but that was no problem for God. Back the sun went, and the shadow on the sundial moved back with it. So the extra minutes that were left of the almost-24-hour day that the sun stood still for Joshua were used by this event in Hezekiah's life ..... and a whole extra day was added to time! (2 Kings 20)

*Some people think!*

Isn't God clever? He is the author of law and order, and He always knows how to make things come out just perfect!!

# Color the Shapes

Got a few *minutes*? Take *time* to color the shapes. A is gold. B is blue. C is brown. D is silver. E is black. F is yellow. G is green. *Watch* what you are doing. Have fun!

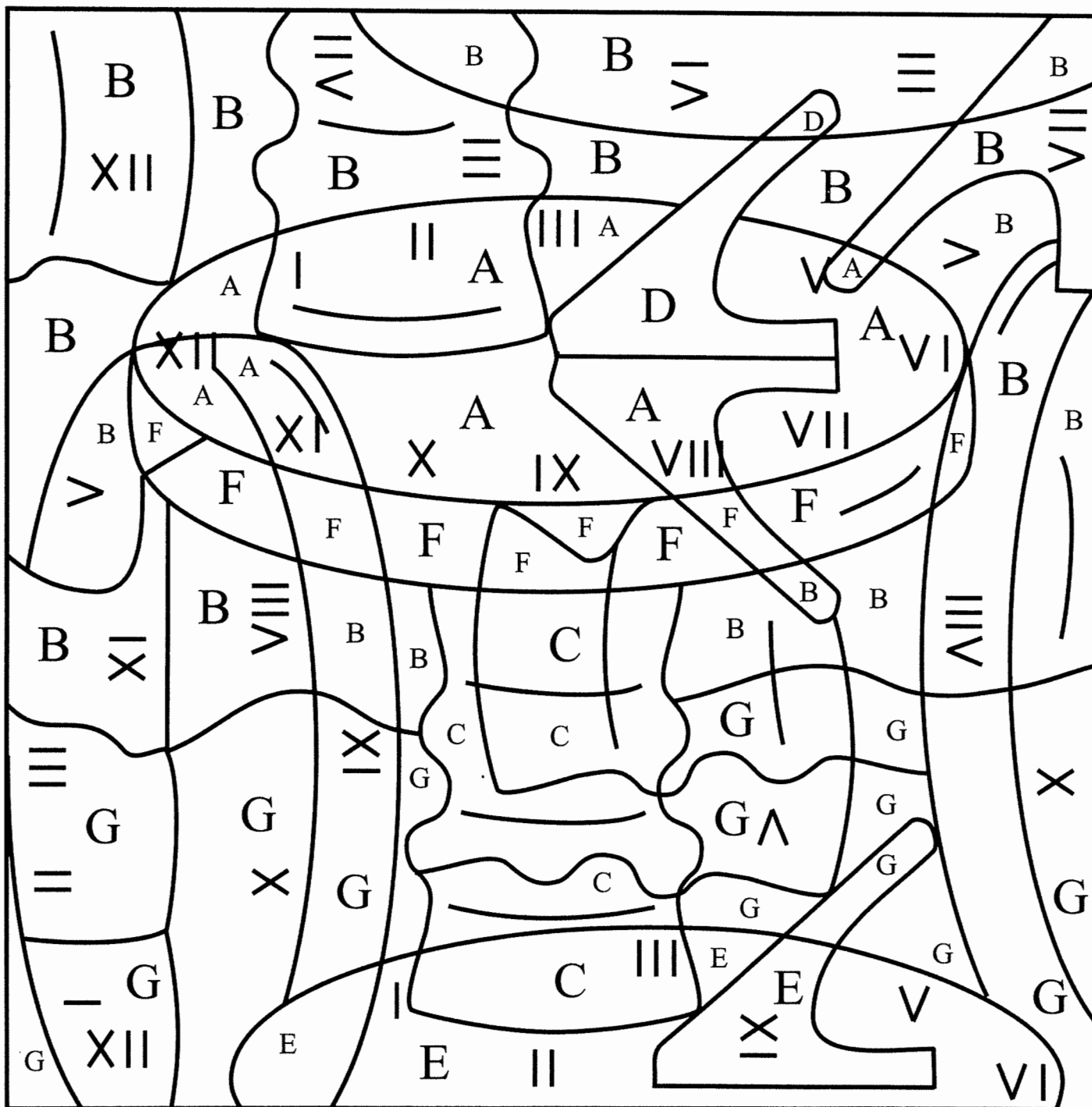



# Back It Up!



time



people



sundial



sun



numbers



king









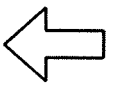









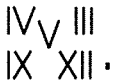

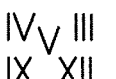



die



pray

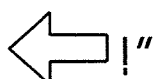

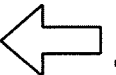
back

In Bible s  didn't have clocks. How did  know what  it was? They used s. The  makes a shadow on the . The shadow falls on . As the  moves, the shadows move. The  at the shadow show the . Once a  became sick. God's prophet Isaiah said to him, "You will . Get ready." The  did not want to . He ed to God. Isaiah said to him, "God heard you . God says you will live 15 more years." "How do I know that is true?" the  asked. "The shadow on the  will move !" Isaiah said. "This will be a sign to you." It was true. God moved the 's shadow . The  lived.

# HEZEKIAH

2 Kings 18-20

Look at this picture of Hezekiah, then find the shapes shown in the key box.

Hezekiah was king of Judah. He wanted to show how much he loved God, so he rebuilt God's temple. He held big feasts in God's honor to remind the people about God.

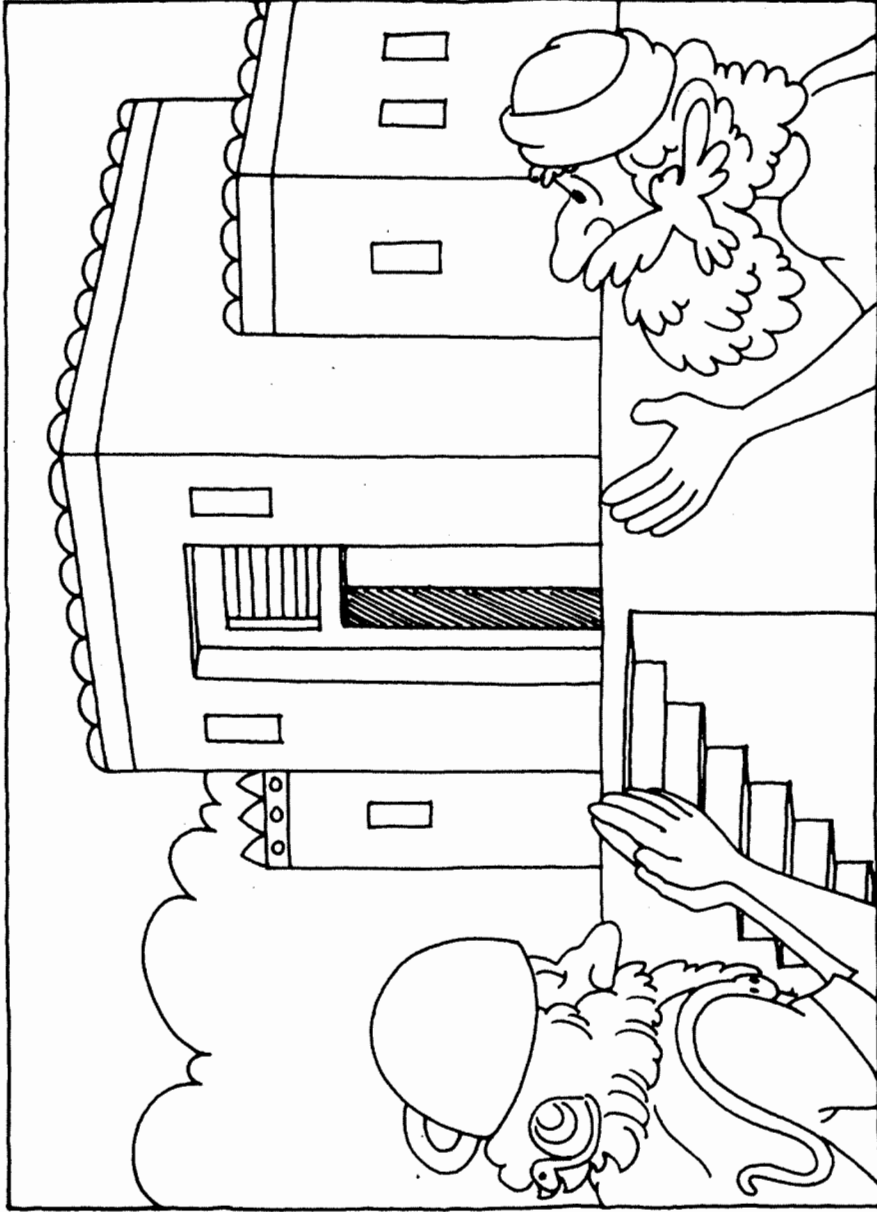

**Year 2**

**Week 99**

## **Manasseh Turns to God**

**Scriptures: II Chronicles 33: 1-20, II Kings 21**

**Key Verse: 2 Chronicles 33:12 " Now when he was in affliction, he implored the Lord his God, and humbled himself greatly before the God of his fathers,"**

### **Key Points:**

**1.** Manasseh became king at the age of twelve. He did not follow God, but lead the people of Judah to become even more wicked than the Amorites, whom God destroyed. He reintroduced the worship of idols to the people of Judah, rebuilt the high places, practiced witchcraft, and killed innocent people.

**2.** God sent prophets to Manasseh. They warned him that God was going to allow Judah to be destroyed. Manasseh and the people did not listen, so God sent the Assyrian army to take Manasseh captive (2Chronicles 33: 10-13). Once Manasseh was in trouble, he humbled himself and asked God to forgive and help him. God answered Manasseh's prayer and brought him home to Jerusalem. Then Manasseh knew who was the true God. He fortified his military defenses and began worshiping God. After reigning for 55 years, Manasseh died and was buried with his fathers.

**3.** His son, Amon, became king of Judah. Amon was 22 years old and was wicked. He followed idols, but unlike his father, he refused to repent. Amon was killed in his own house, by his servants, and his little boy, Josiah, became king.



# A King's Crossword

All the words in this puzzle are from the story "A Boy King." Look for the clues in the story. Find the missing words. Write the words that fit the clues in the empty boxes.

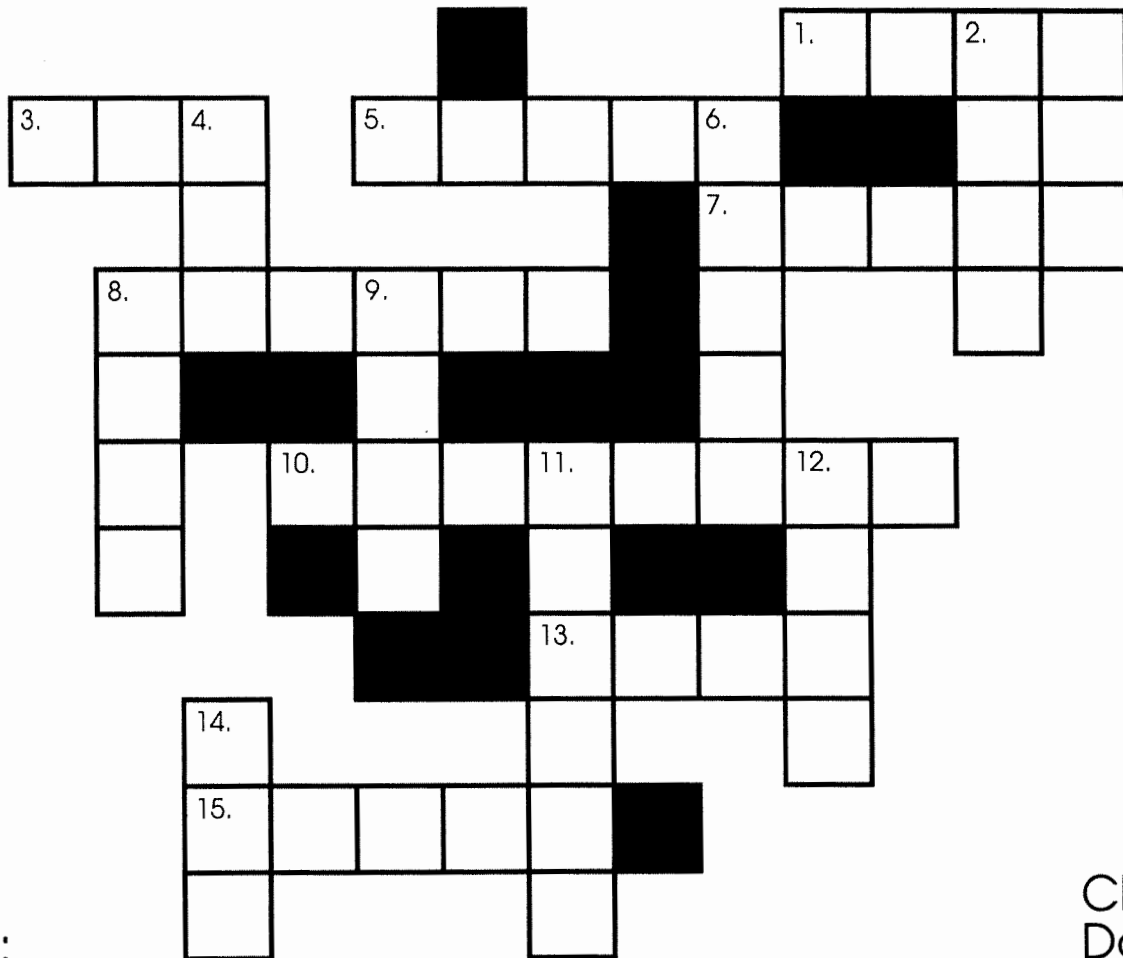

Clues  
Across:

Clues  
Down:

- |                             |                                 |
|-----------------------------|---------------------------------|
| 1. He prayed to _____.      | 2. The _____ caught the king.   |
| 3. God _____ him free.      | 4. _____ army caught _____ king |
| 5. This made God _____.     | 6. _____ was only 12 _____ old  |
| 7. God sent an _____ army   | 8. _____ King Manasseh knew     |
| 8. an idol in the _____.    | 9. He _____ed to God.           |
| 10. _____ was a bad king.   | 11. He took down the _____      |
| 13. God was the _____ God.  | 12. He _____ put an idol in     |
| 15. put up an _____ to God. | 14. Manasseh was a _____        |

# A Boy King



king



altar



pray



Baal



temple



angry



























army



chain



down

How old should a  be? Manasseh was only 12 years old when he became . Manasseh was a bad . He built s to false gods. He ed to . He even put an idol in the . This made God . God sent an enemy  to fight against the . The  caught the  and put s on him.  Manasseh was a prisoner! The  was sorry he had been bad. He ed to God. He told God he was sorry. God set him free. Then  Manasseh knew God was the true God. He took  the s to . He took  the idol in the . He put up an  to God.  Manasseh ordered his people to serve God.

It was a sad day for Manasseh. His dad, King Hezekiah had just died. Now, only twelve years old, Manasseh was the new king over God's people in Judah. He didn't know it then, but Manasseh would be king for 55 years. Manasseh needed God's help to be a good king.

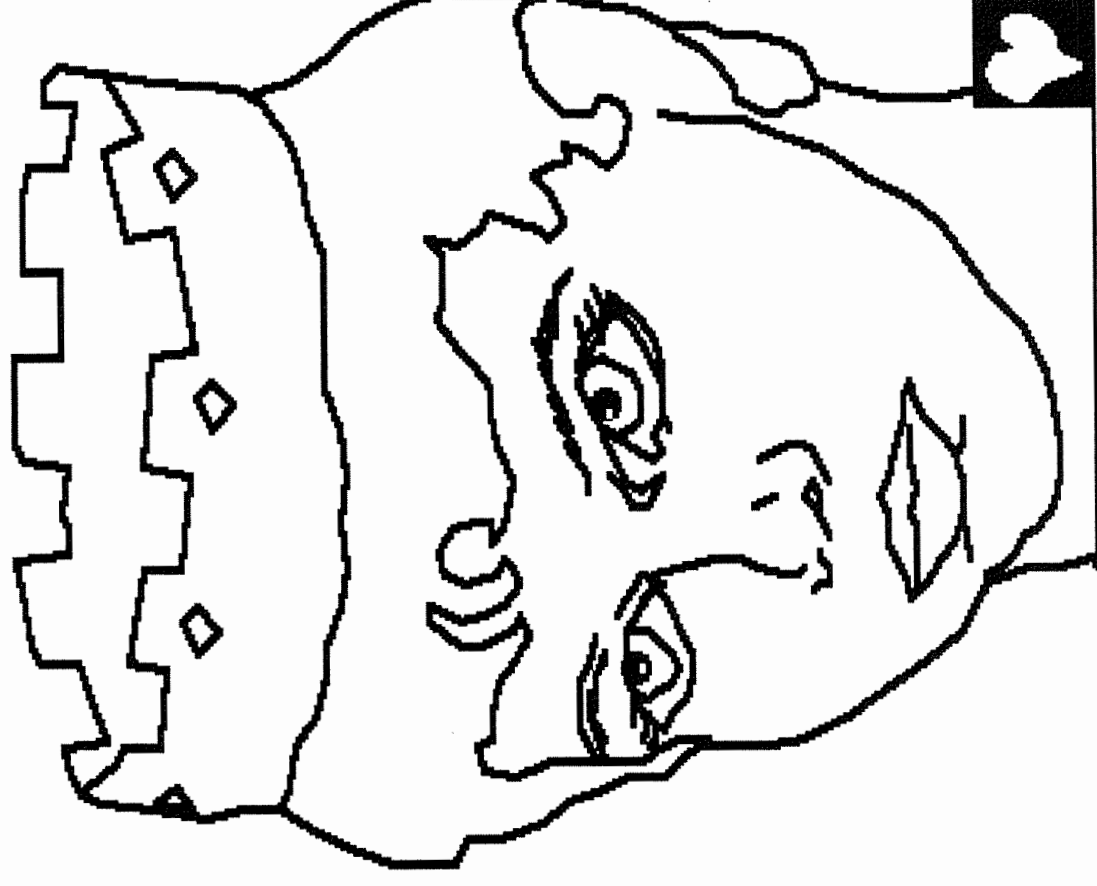

But Manasseh ignored God and did evil. Manasseh rebuilt altars for idol worship. He even made a carved image and set it in God's holy Temple! God had said through Moses, "You shall not make any carved images. You shall not bow down to them

nor serve them."

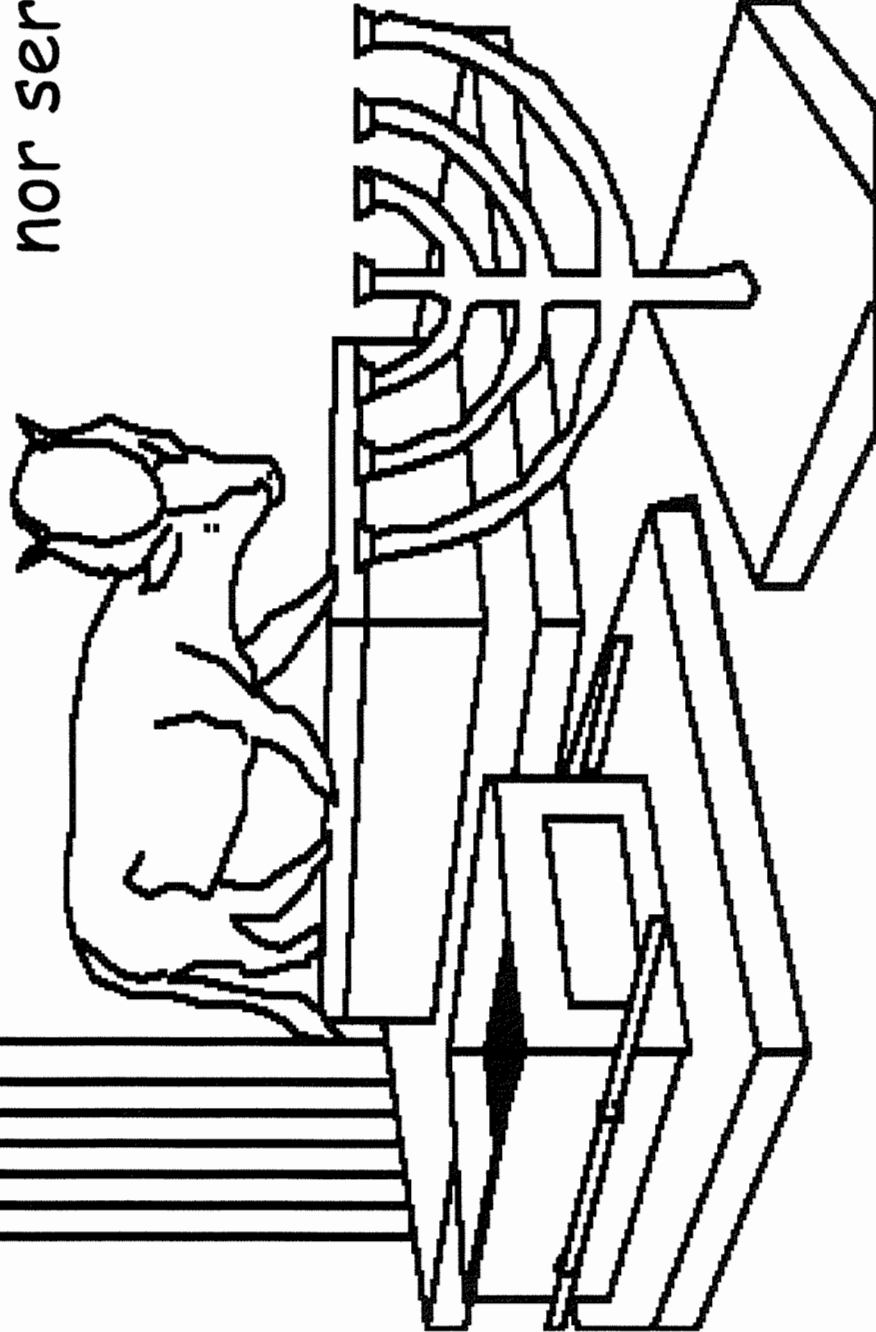



Manasseh practised witchcraft and sorcery. He led the people away from God. The king even burned his sons as sacrifices to idols. Manasseh's disobedience angered God greatly.

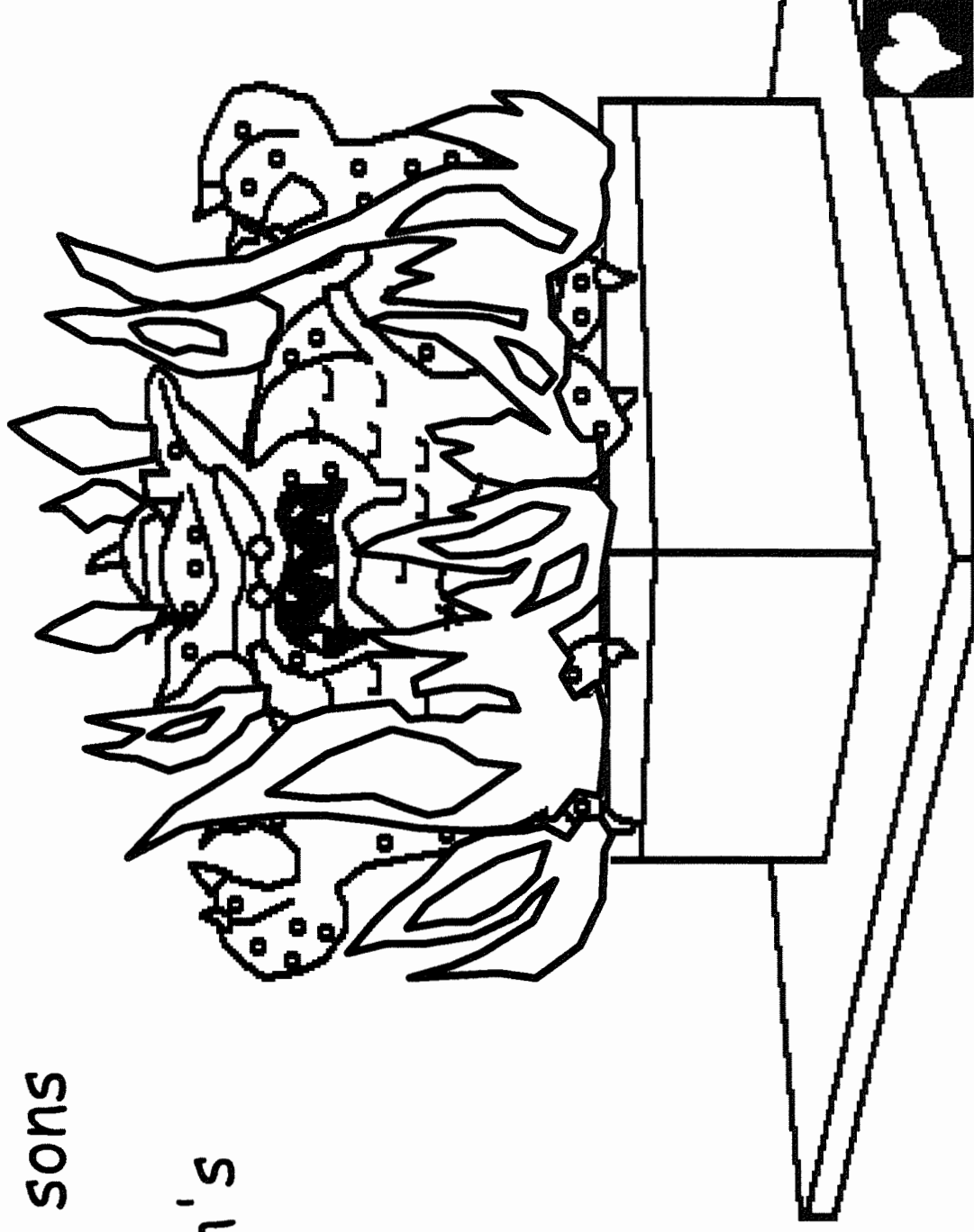

When His people disobey, God allows them to be punished. That's what happened to Manasseh and the people he ruled. The LORD brought the Assyrian army upon them. Manasseh was taken away in chains to Babylon.

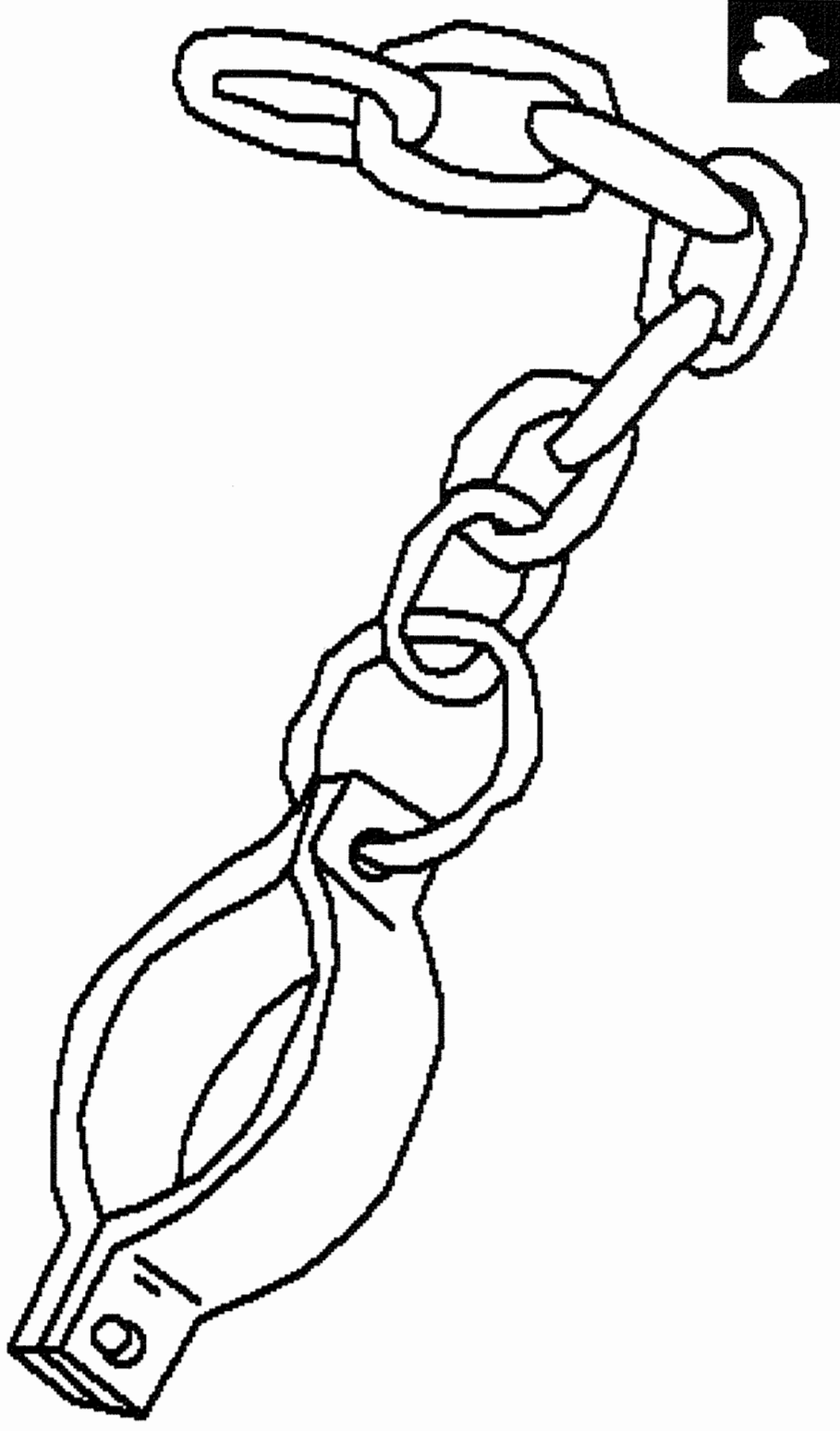

Suffering in Babylon,  
Manasseh pleaded with  
the LORD, his God. He  
humbled himself greatly  
before the God of his  
fathers, and prayed to  
Him. No more praying  
to dead idols! But, would  
the living God answer  
Manasseh after all  
his wickedness?

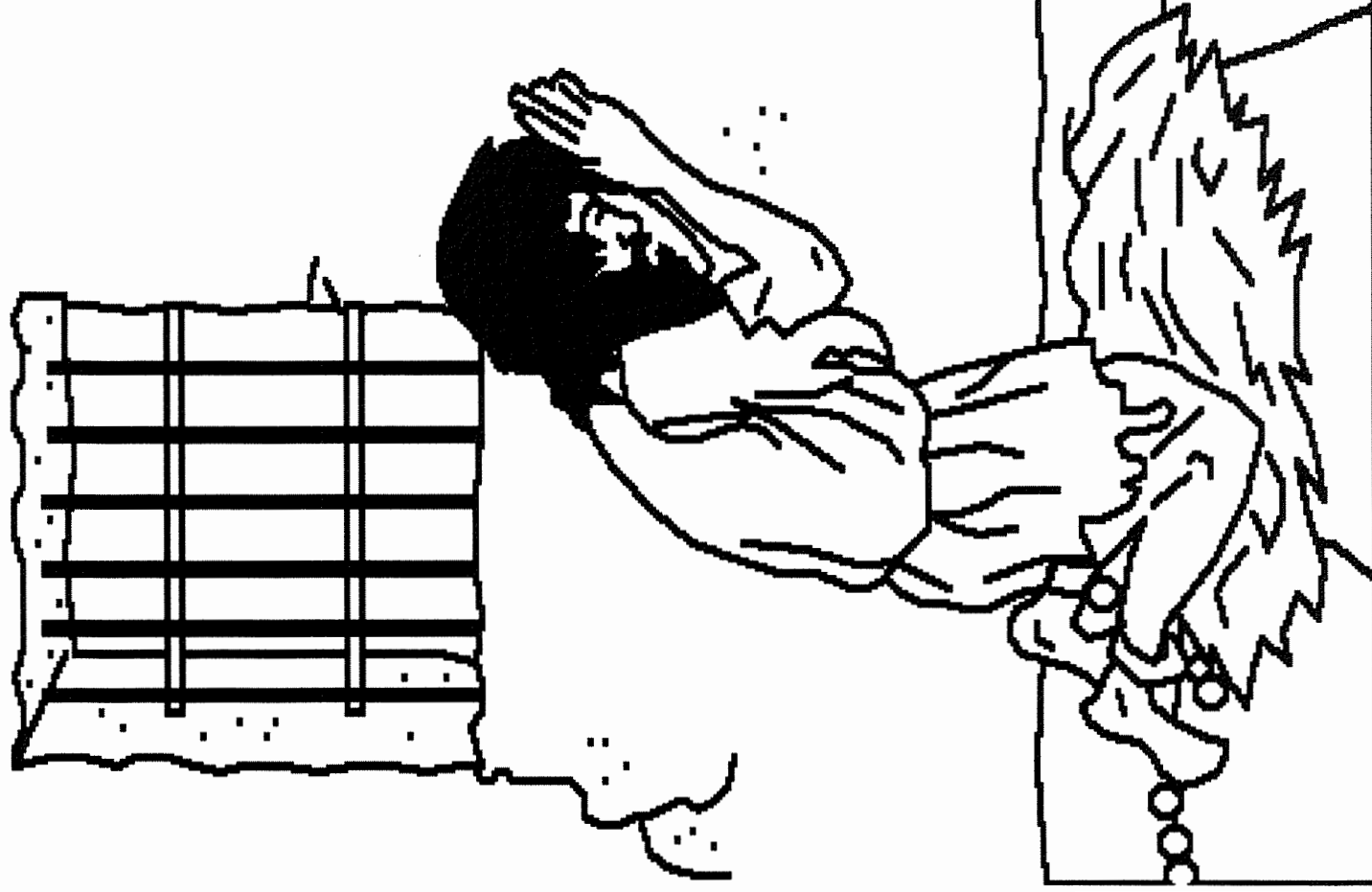

Yes! God heard the king's prayer and brought him back to Jerusalem, back to the throne, back to being king, over the people. Then, Manasseh knew that the LORD was God.

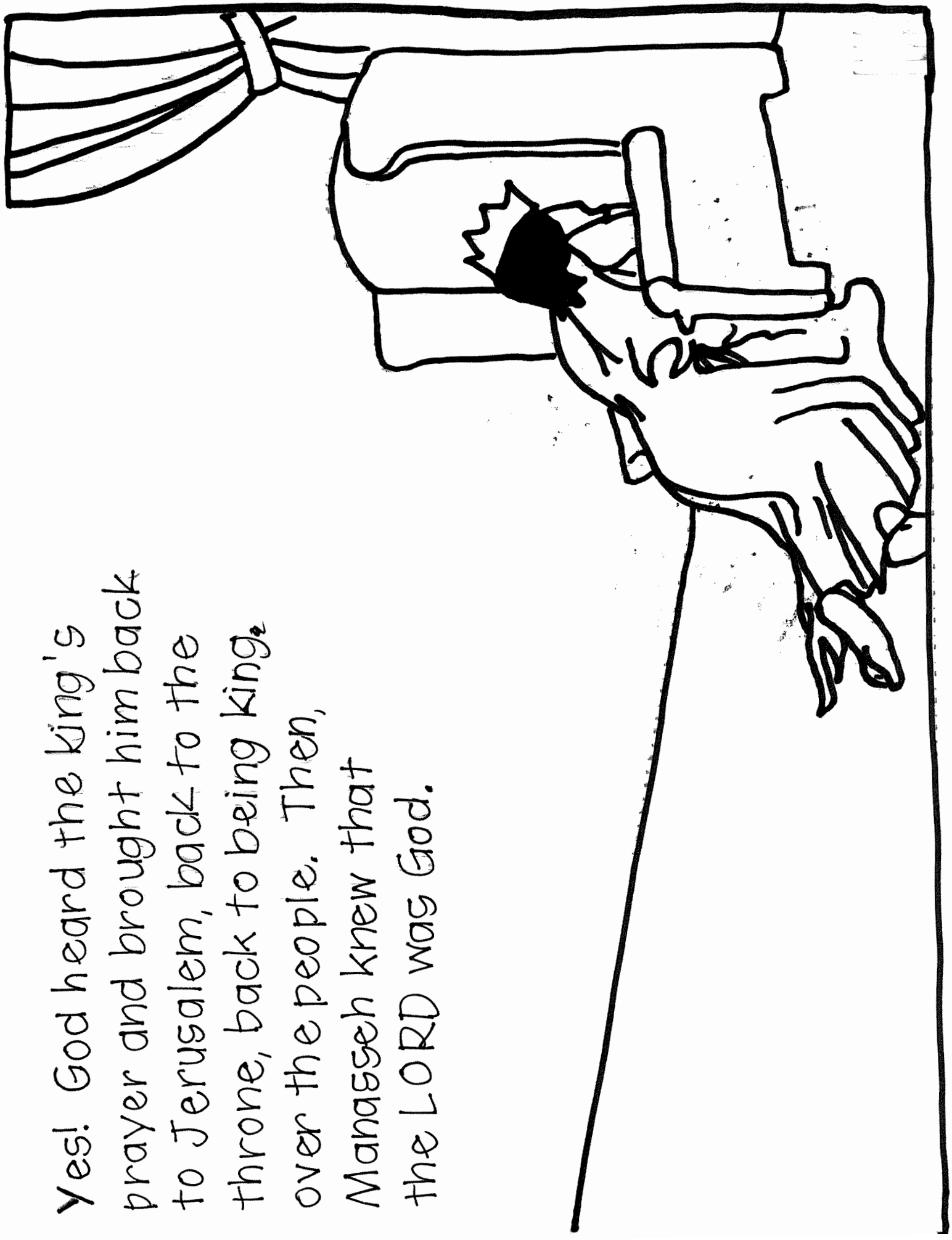

King Manasseh was a new person. He took the image out of God's temple and gathered up all the foreign gods in Jerusalem. He threw them all away. He repaired the altar of the LORD and offered thank offerings. Then he commanded his people to serve the LORD God of Israel. What a change in Manasseh!

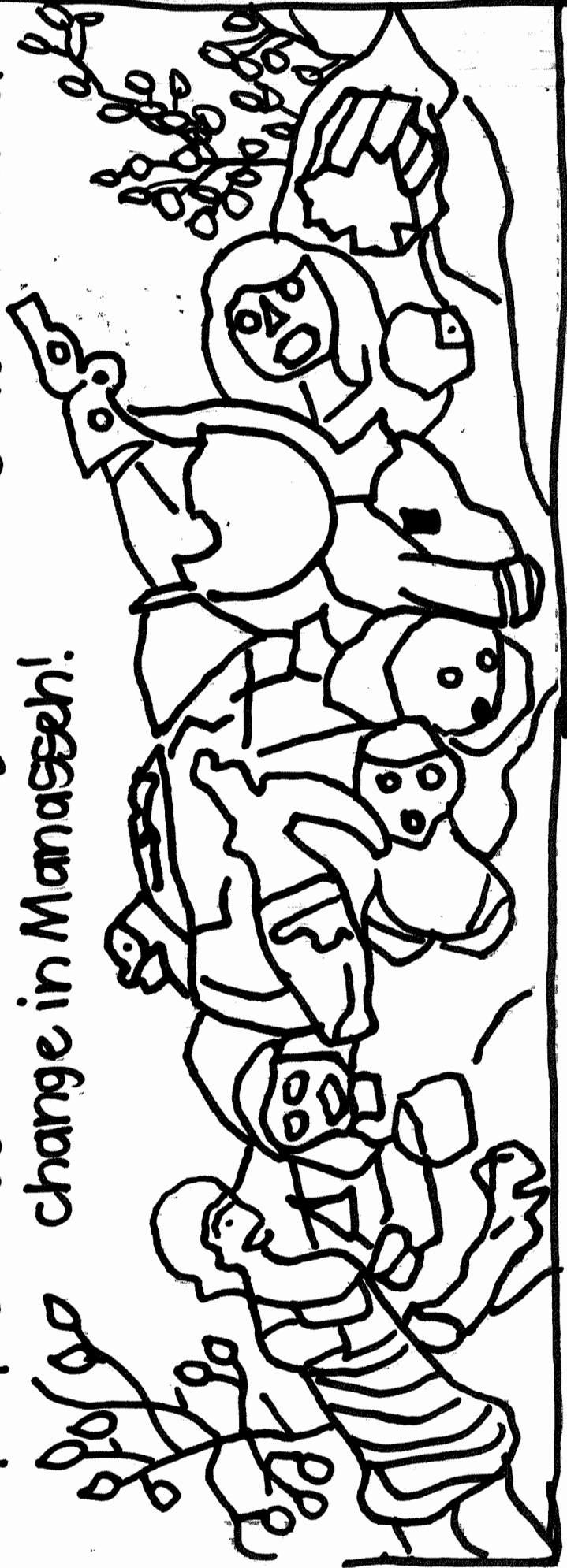

When Manasseh died, his own sons reigned  
to idol worship. But he did not turn them  
before the Lord like Manasseh. And there were  
more and more, his servants first, and then  
in his own house. He reigned only in his

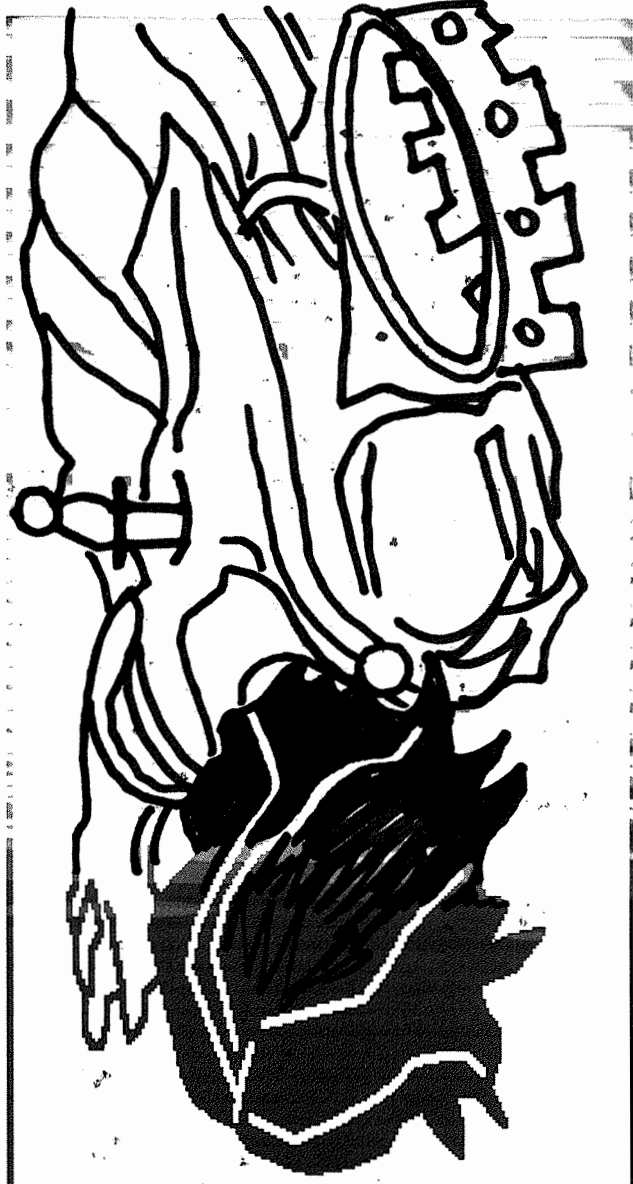

# Jesus Taught Us How to Pray

To the tune of "Jesus Loves Me."

Jesus taught us how to pray,  
to God our Father everyday;  
Morning, noon, and night-time too,  
we can pray and so can you.  
Yes, we can pray! Yes, we can pray!  
Yes, we can pray; to God through-out the day.

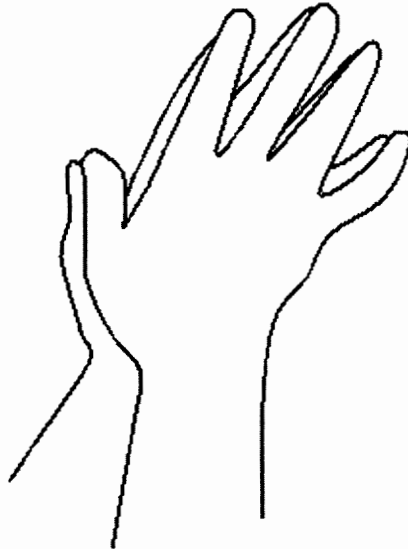
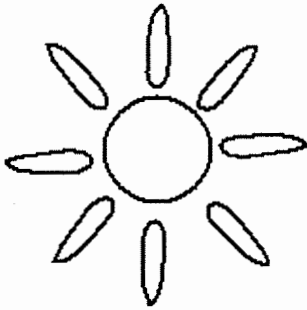

**Year 2**

**Week 100**

## **Josiah and God's Lost Book**

**Scriptures: II Chronicles 34, 35, II Kings 22, 23**

**Key Verse: II Chronicles 34:30 " The king went up to the house of the LORD, with all the men of Judah and the inhabitants of Jerusalem -- the priests and the Levites, and all the people, great and small. And he read in their hearing all the words of the Book of the Covenant which had been found in the house of the LORD."**

### **Key Points:**

- 1.** Josiah became king at the age of eight. He followed God and sought to do what was right. In the twelfth year of his reign (at age 20), he began to remove the idols from the land of Judah.
- 2.** In the eighteenth year of his reign, Josiah began the restoration of the temple. During the repairs, Hilkiah the priest found the Book of the Law and sent it to Josiah. After Josiah heard the words of the Law, he was very afraid. He understood how much his fathers sinned against God and the destruction God promised as a consequence. Josiah asks Huldah, a prophetess of God, about the promised consequences. She sends word back saying that although God would pour out His wrath, Josiah would not have to live through it because he humbled himself and was tender hearted towards the truth.
- 3.** Josiah went to the temple and called the people of Judah together and read all of the Book of the Covenant to them. After he finished reading, he made a covenant to follow God and keep his commandments. That year, Josiah kept the Passover according to God's instructions (2Chronicles 35). No Passover had been kept so carefully since Samuel was alive.
- 4.** Josiah was killed in battle. The people of Judah mourned for him. During his reign, they had been faithful to God.



**close  
my  
eyes.**

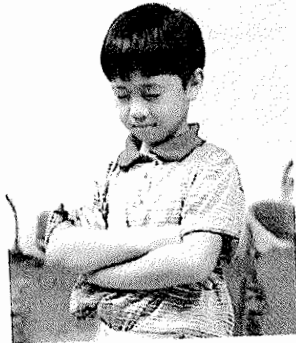

**BOW  
my  
head.**



**FOLD  
my  
arms.**



**Listen  
to the  
words**



# 36. The Lost Book

## 2 Chronicles 34

What happened when King Josiah ordered the temple to be cleaned?

Follow the maze of letters.

1. \_\_\_\_\_

\_\_\_\_\_

\_\_\_\_\_

\_\_\_\_\_

\_\_\_\_\_

\_\_\_\_\_

\_\_\_\_\_

2. \_\_\_\_\_

\_\_\_\_\_

\_\_\_\_\_

\_\_\_\_\_

\_\_\_\_\_

\_\_\_\_\_

\_\_\_\_\_

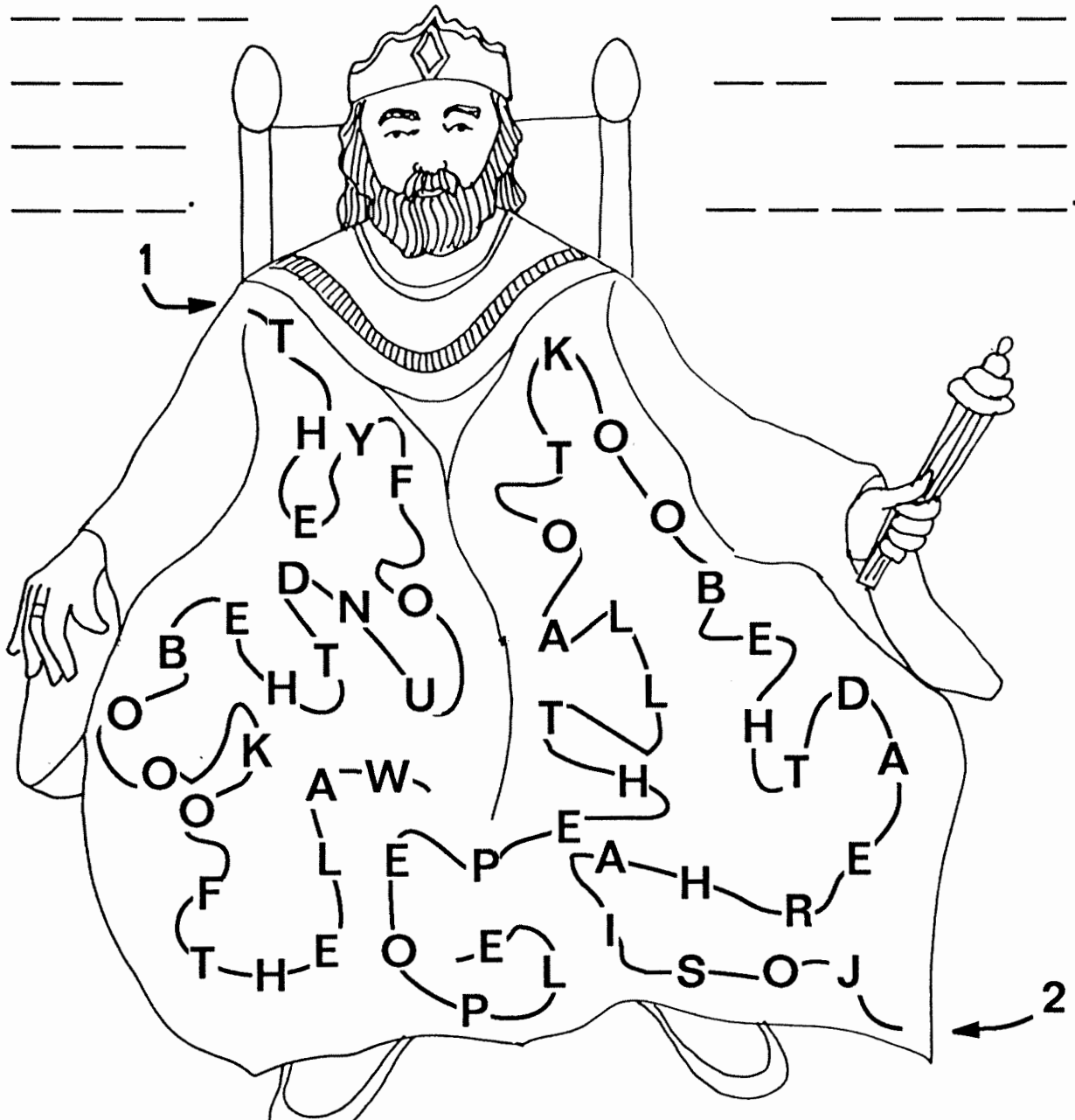

**King Josiah  
and the Law  
2 Kings 22:1-13**

# Unburied Treasure!

King Josiah was only 26 years old when he decided to repair the Temple of the Lord. Carpenters, builders, and stoneworkers began to work. While clearing out the Temple, they found something very important.

To see what they found, black out all the letters in the broken bricks and fallen timbers. Then transfer the letters left in the saws, chisels and hammers to the spaces below.

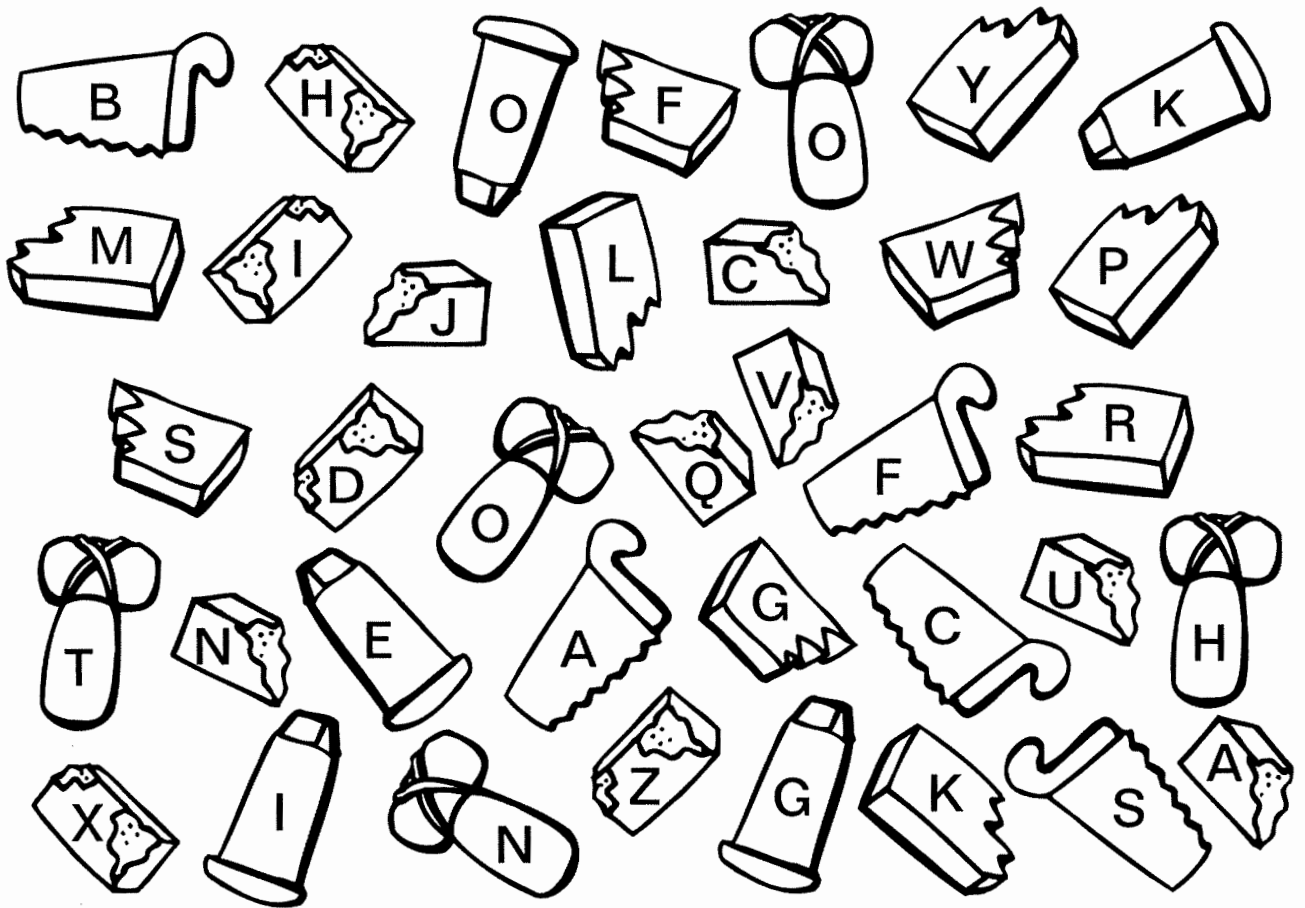

# JOSIAH

## (2 KINGS 22:1-2; 23:1-30)

### MEMORY VERSE:

*"Now before him there was no king like him, who turned to the LORD with all his heart, with all his soul, and with all his might." 2 KINGS 23:25*

### TRUE OR FALSE:

1. "Josiah was eight years old when he became king, and he reigned thirty-one years in Jerusalem." **2 KINGS 22:1**  
TRUE OR FALSE
2. "He did what was right in the sight of the LORD, and walked in all the ways of his father David; he did not turn aside to the right hand or to the left." **2 KINGS 22:2**  
TRUE OR FALSE

### CIRCLE THE CORRECT WORDS:

3. Josiah "the king went up to the house of the LORD with all the men of Judah, and with him all the inhabitants of Jerusalem- the priests and prophets and all the people, both small and great; and he (**READ, FED**) in their hearing all the words of the Book of the Covenant which had been found in the house of the LORD." **2 KINGS 23:2**
4. "Then the king stood by a pillar, and made a (**CAKE, COVENANT**) before the LORD, to follow the LORD and to keep His commandments and His testimonies and His statutes, with all his heart and all his soul, to perform the words of this covenant that were written in this book." **2 KINGS 23:3**

### TRUE OR FALSE:

5. But none of the people took their stand for the covenant. **2 KINGS 23:3**  
TRUE OR FALSE
6. "And the king commanded Hilkiah the high priest, the priests of the second order, and the doorkeepers, to bring out of the temple of the LORD all the articles that were made for Baal, for Asherah, and for all the host of heaven." **2 KINGS 23:4**  
TRUE OR FALSE
7. "And he burned them outside Jerusalem in the fields of Kidron, and carried their ashes to Bethel." **2 KINGS 23:4**  
TRUE OR FALSE

### CIRCLE THE CORRECT WORDS:

8. "Then he removed the idolatrous priests whom the (**KINGS, GOD**) of Judah had ordained to burn incense on the high places in the cities of Judah and in the places all around Jerusalem." **2 KINGS 23:5**
9. "And he brought out the wooden (**IMAGE, MIRAGE**) from the house of the LORD, to the Brook Kidron outside Jerusalem, burned it at the Brook Kidron and ground it to ashes, and threw its ashes on the graves of the common people." **2 KINGS 23:6**
10. "As Josiah turned, he saw the (**COMBS, TOMBS**) that were there on the mountain." **2 KINGS 23:16**
11. "Then he said, 'What gravestone is this that I see?' And the men of the city told him, 'It is the tomb of the man of God who came from Judah and proclaimed these things which you have done against the (**PEOPLE, ALTAR**) of Bethel.'" **2 KINGS 23:17**
12. "Now before him there was no king like him, who turned to the (**LORD, WORLD**) with all his heart, with all his soul, and with all his might." **2 KINGS 23:25**

# JOSIAH

(2 KINGS 22:1-2; 23:1-30)

C B Z E Z N Y B B N B I I D D  
O J H C Z B C G F O V Y R T S  
V Q E R L U O S H R D R O M T  
E K A C W K T A O D H O E P T  
N K R J P O G L I I Q I J U W  
A V T J F O H G M K B T L R N  
N H U T E B A N A K W E B P G  
T S O H P R D I G O Q H N T F  
Z T W H R T U K E O I A Z Y O  
T O T L I O J S C R J I Z L B  
A L E Z E M B L A B G S Q O M  
S S M R S B R V G L P O N R I  
H T P L T Q B C S Z E J M D G  
E R L P S C T B M B C M P W H  
S W E J Q J G R E O Q H G Y T

ASHES

JERUSALEM

MIGHT

BOOK

JOSIAH

PRIESTS

BROOK KIDRON

JUDAH

SOUL

COVENANT

KING

TEMPLE

HEART

LORD

TOMB

IMAGE

# JOSIAH

(2 KINGS 22:1-2; 23:1-30)

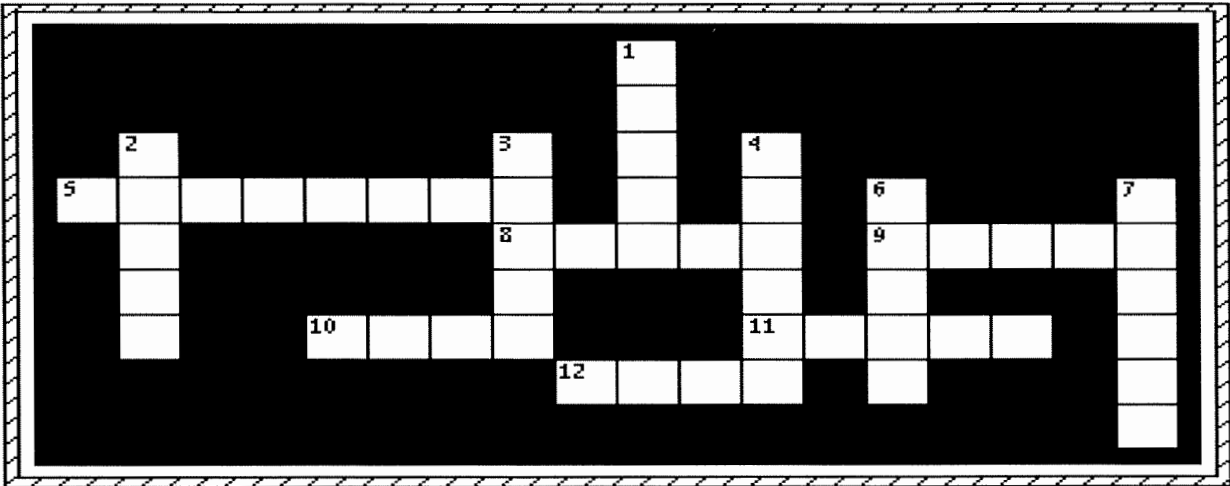

- 11 ACROSS "Josiah was \_\_\_\_\_ years old when he became king, and he reigned thirty-one years in Jerusalem." **2 KINGS 22:1**
- 1 DOWN "He did what was \_\_\_\_\_ in the sight of the LORD, and walked in all the ways of his father David; he did not turn aside to the right hand or to the left." **2 KINGS 22:2**
- 10 ACROSS "He \_\_\_\_\_ in their hearing all the words of the Book of the Covenant which had been found in the house of the LORD." **2 KINGS 23:2**
- 5 ACROSS "Then the king stood by a pillar, and made a \_\_\_\_\_ before the LORD." **2 KINGS 23:3**
- 3 DOWN "And all the people took their \_\_\_\_\_ for the covenant." **2 KINGS 23:3**
- 7 DOWN "And the king commanded Hilkiah the high priest, the priests of the second order, and the doorkeepers, to bring out of the \_\_\_\_\_ of the LORD all the articles that were made for Baal, for Asherah, and for all the host of heaven." **2 KINGS 23:4**
- 4 DOWN "And he \_\_\_\_\_ them outside Jerusalem in the fields of Kidron, and carried their ashes to Bethel." **2 KINGS 23:4**
- 6 DOWN "Then he removed the idolatrous priests whom the \_\_\_\_\_ of Judah had ordained to burn incense on the high places in the cities of Judah and in the places all around Jerusalem." **2 KINGS 23:5**
- 9 ACROSS "And he brought out the wooden \_\_\_\_\_ from the house of the LORD." **2 KINGS 23:6**
- 2 DOWN "As Josiah turned, he saw the \_\_\_\_\_ that were there on the mountain." **2 KINGS 23:16**
- 8 ACROSS "Then he said, 'What gravestone is this that I see?' And the men of the city told him, 'It is the tomb of the man of God who came from Judah and proclaimed these things which you have done against the \_\_\_\_\_ of Bethel.'" **2 KINGS 23:17**
- 12 ACROSS "Now before him there was no king like him, who turned to the \_\_\_\_\_ with all his heart, with all his soul, and with all his might." **2 KINGS 23:25**

# JOSIAH

(2 KINGS 22:1-2; 23:1-30)

N D Z B L S C H N N U Y Y H L Y D O C C  
O T H B L B S G S Z U B L L A K O M R M  
N T R Y M P L U H S R O H D G E T M H G  
C Q S U S Z S Q P V J J R I H O C G N K  
N F A E O S N J P M Z C B H A I S O J M  
B N A W H M P N R O F B L P G J U Q C P  
I F J D A S M V O M J G N M N S V O N E  
F T Y O I M A G E R F T R A E H V O V I  
A H G K L B N L B N D W D W W E H T G P  
W D H J K A A Q S G E I O L N Z A H R L  
N T S Q N S Q T N B O H K A B N D K K E  
B N E W U B S D O I D H N K W W U W Z P  
Y Y Q R M E Q O G R R T F G O I J E L K  
K B E Z I I K D O C I B N S B O L W N S  
Y J M R G Y H L B N Y M Q Z V P R M I N  
T P P P G T V D L E S B R R M O N B V U  
P W G Q T F Z V L B M S K E B V V L V W  
S U B N E Z U V N O O B T O H M M R T S  
J L W L I B D D T U Y U D J C G U Q L C  
V N C A L K B L L P D L F L O T H G I M

ASHES

JERUSALEM

MIGHT

BOOK

JOSIAH

PRIESTS

BROOK KIDRON

JUDAH

SOUL

COVENANT

KING

TEMPLE

HEART

LORD

TOMB

IMAGE

# THE BOOK OF THE LAW IS FOUND

(2 KINGS 22:3-20)



"And Hilkiah the high priest said unto Shaphan the scribe, I have found the book of the law in the house of the LORD. And Hilkiah gave the book to Shaphan, and he read it."

**2 KINGS 22:8**



# THE BOOK OF THE LAW IS FOUND

## (2 KINGS 22:3-20)

H U M B L E D N Q K K Y D Q D  
 H B I O S O B C N W U H F N W  
 T D Y B S R G V Y L N N B I T  
 T C O J O M E S H A P H A N L  
 R D B G S O C P M W U O E S A  
 R W B W D J K C E W D K I N G  
 Y K P H I R Z O A E H I H V O  
 E I P Y I K O C F A K R T U A  
 N E Y T A L H L I T L R L U P  
 O D F I G G K S E Z H R O A A  
 M N H M W H O I S H U E E O D  
 W U T A A J K H A O T F L A D  
 P O A L F G K R V H F Y U A D  
 N F R A U D R E Y A L N W D W  
 K P W C T V E M H U L D A H Y

BOOK OF THE LAW  
 CALAMITY  
 DOORKEEPERS  
 FOUND  
 HILKIAH

HULDAH  
 HUMBLED  
 JOSIAH  
 KING  
 MONEY

READ  
 SHAPHAN  
 THE LORD GOD  
 WRATH

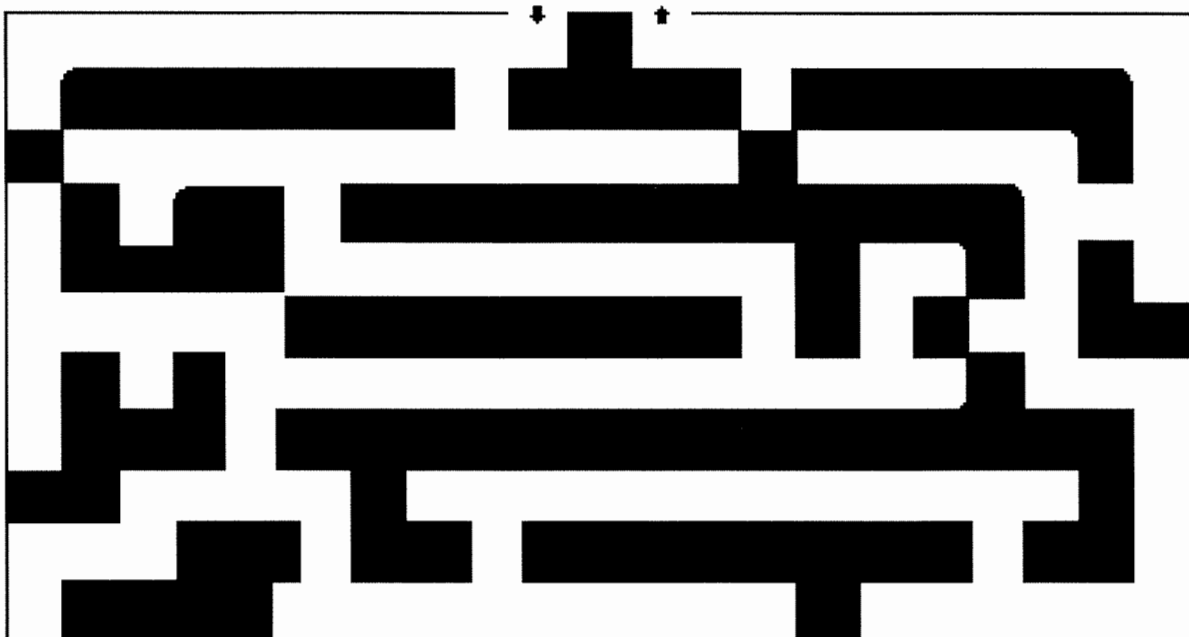

# THE BOOK OF THE LAW IS FOUND

## (2 KINGS 22:3-20)

C F G E V G M C P D L A E E N G L F J L  
 E N D U V M A T Z Z B B P G W K K S Z K  
 T W O L F W Q C J W U P N H H V U P G I  
 G Q O N W H W N F G H I J W A E V A V Y  
 I S R N G K P L J Z K S A A I I W P T K  
 T D K T L L J O W Y Q L Z R S T H G H M  
 Z E E E J F Y Z Q T E T J O O R O M E H  
 Q D E A Z N W Y U H O Y H T J V A H L I  
 Y U P D W Q D S T R J D N U O F H D O L  
 H S E E L Y C F J L N L F R Q I W C R K  
 Q N R M K K O H N U G Y E N O M A B D I  
 H J S K I K V R N K A V R H A L M H G A  
 S U S T O R S H A P H A N V A K G F O H  
 E D M O B V S V V U E O K M V D S L D S  
 N W B B A U R I J H S C I J U D W I Z V  
 R K B B L P Q H Z P U T Y H D O N R C O  
 F H I D K E B H A T Y L S D L C P A K M  
 B P P B S F D R D H E T D H Z J N M R R  
 P K Q N H T A R W S Q Z S A N A R Z A Z  
 A J C L R E A D S D P O D P H S N W I F

**BOOK OF THE LAW**  
**CALAMITY**  
**DOORKEEPERS**  
**FOUND**  
**HILKIAH**

**HULDAH**  
**HUMBLED**  
**JOSIAH**  
**KING**  
**MONEY**

**READ**  
**SHAPHAN**  
**THE LORD GOD**  
**WRATH**

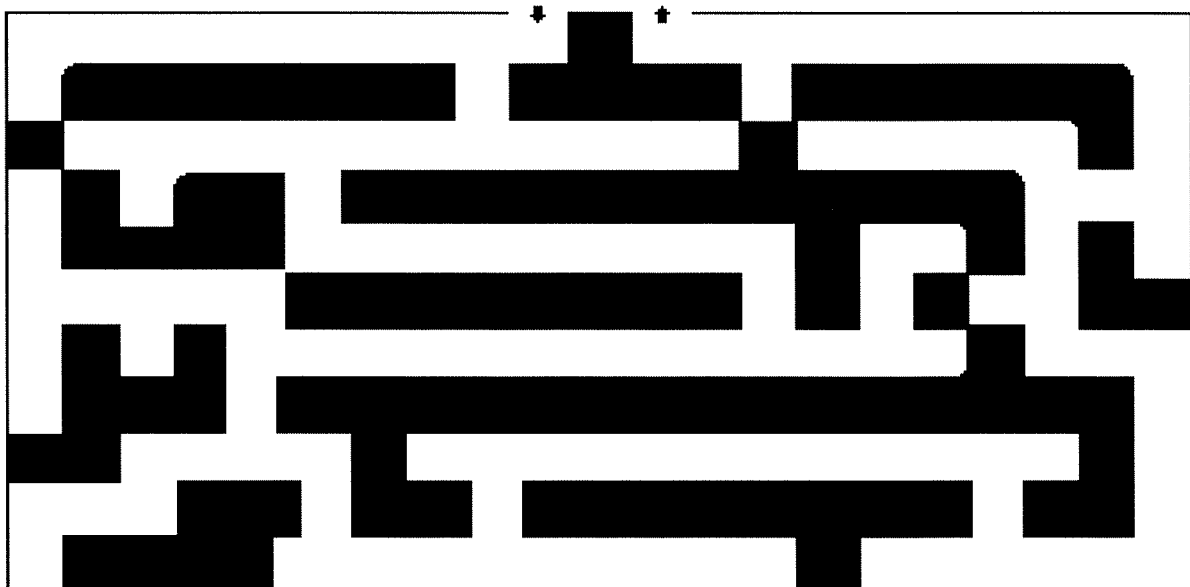

# 117. THE BOOK OF THE LAW IS FOUND

(2 KINGS 22:3-20)



“And Hilkiyah the high priest said unto Shaphan the scribe, I have found the book of the law in the house of the LORD. And Hilkiyah gave the book to Shaphan, and he read it.”  
2 KINGS 22:8

## Year 2

### Week 100

#### Israel to Babylon

**Scriptures: II Chronicles 36, II Kings 25, Jeremiah 1 and 2**

**Key Verse: Jeremiah 2:19 " 'Your own wickedness will correct you, And your backslidings will rebuke you. Know therefore and see that it is an evil and bitter thing that you have forsaken the Lord your God, and the fear of Me is not in you,' says the Lord God of hosts."**

#### **Key Points:**

1. Jehoaz became king after Josiah. He reigned for three months before the king of Egypt carried him off and made his brother, Eliakim/Jehoiakim, king in his place. Jehoiakim reigned 11 years and was evil. Nebuchadnezzar of Babylon carried him away, along with some articles from the temple.

Jehoiachin became king for three months, did evil, and was also taken away by King Nebuchadnezzar along with more treasure from the temple. Zedekiah was made king of Judah.

2. Zedekiah was 21 years old and reigned for eleven years. He did not follow God and refused to listen to the prophet, Jeremiah, whom God had sent to him (2 Chronicles 36:11-16). God sent the Babylonians one final time to punish Judah.

3. The Babylonians laid seige to the city of Jerusalem. They broke through the wall and took Zedekiah, and all the people in Jerusalem and Judah who weren't killed in the battle, back to Babylon. (Details: 2Chronicles 36 17-21 and 2 Kings 25:2-7) The Babylonians stripped everything of value from the temple and then burned it, the palace, and all the houses of the great. (2 Kings 25:8-17) A small remnant of the lower class was left in Judah to farm the area.

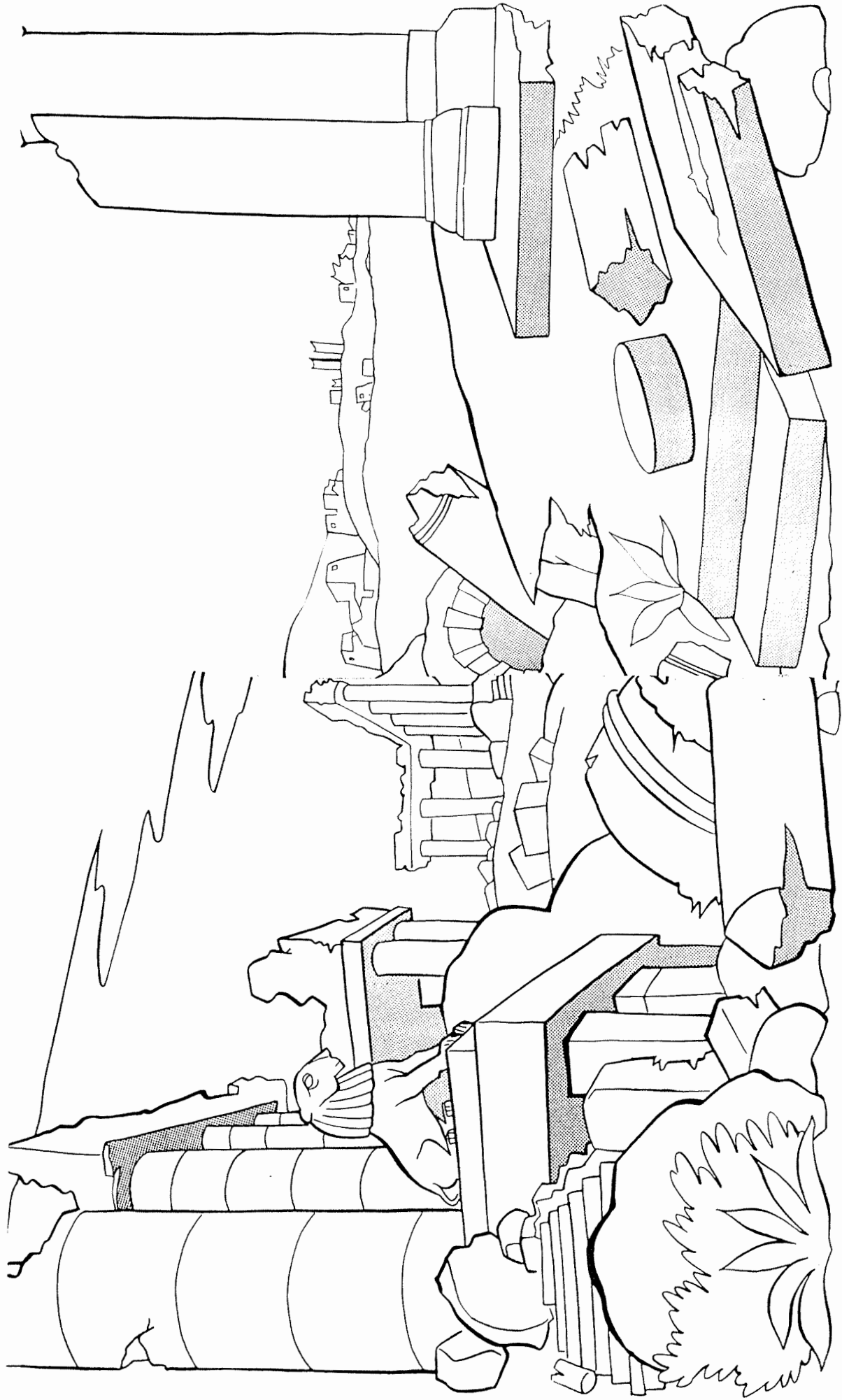

Because the people disobeyed God's laws, their temple . . . . . and all of Jerusalem was destroyed by the Babylonians.

118. JUDAH IS LEAD INTO CAPTIVITY  
(2 KINGS 25:1-21)



"Thus Judah was carried away captive from its own land."  
2 KINGS 25:21

# JEREMIAH

Jeremiah 1

Unscramble the letters to find the name of one of Israel's prophets.

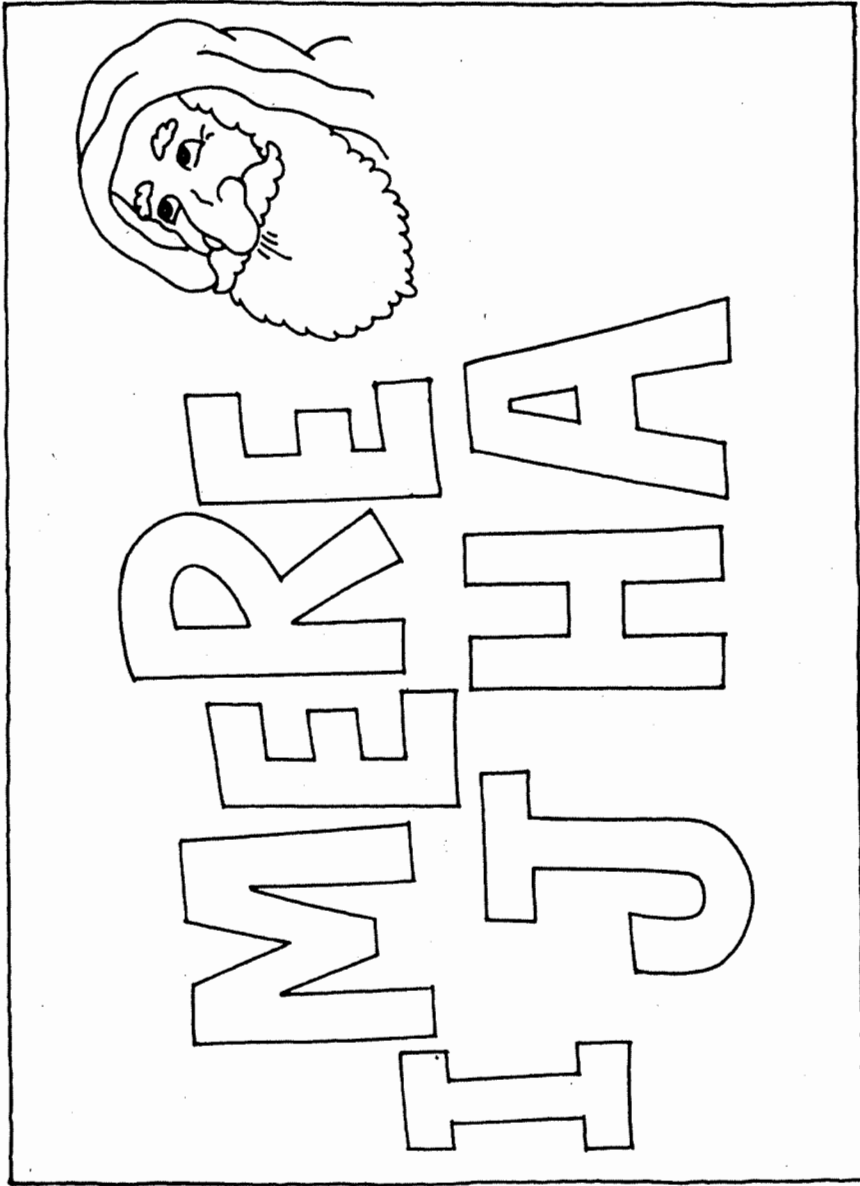

-----

Jeremiah

This famous prophet warned the people of Israel that their nation would be captured by Babylon if they kept sinning. He wrote a book that is in our Bible now and it has the same name that he has.

# Cistern Escape

The Israelites threw Jeremiah into a cistern. How did he get out? Find the book of Jeremiah in your Bible and answer the questions below. Then take the letters from the circles and write them in the rocks. Read Jeremiah 38:3-10.

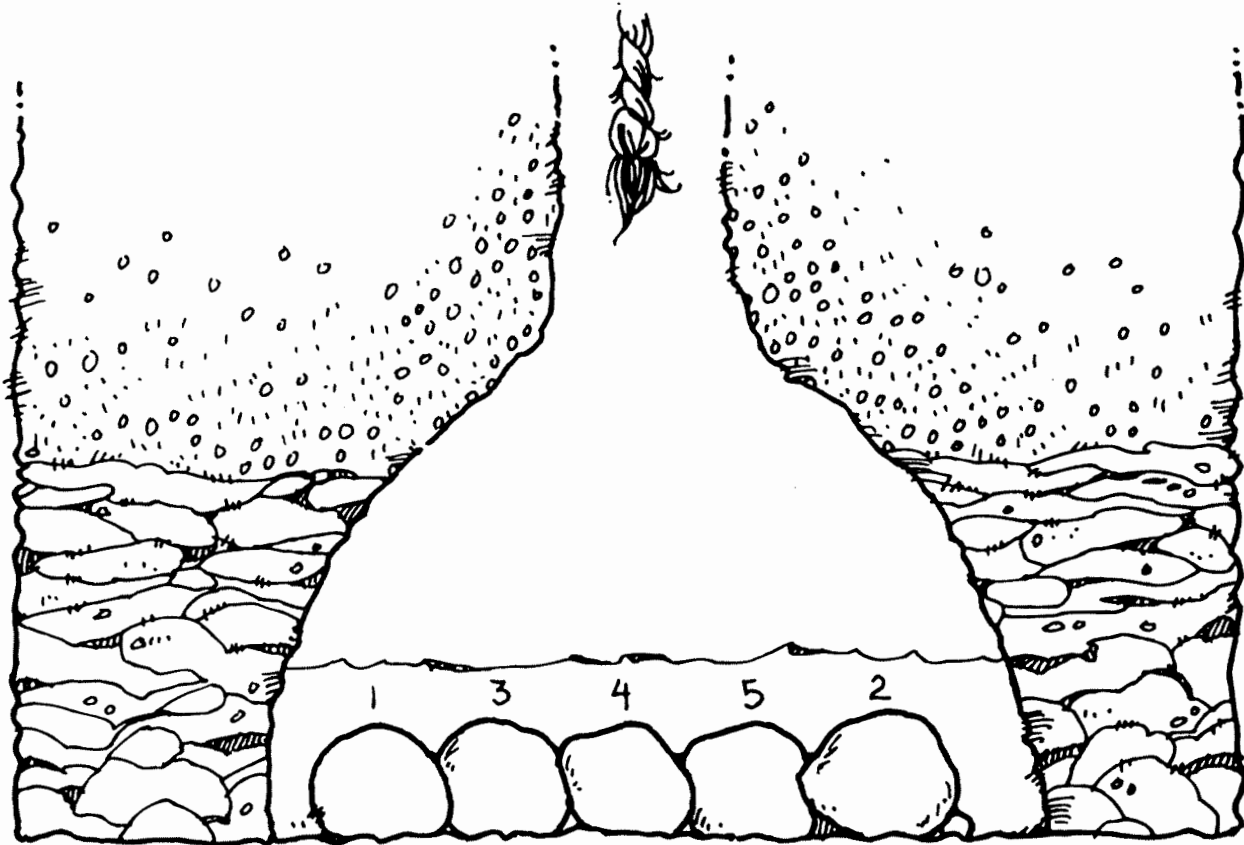

1. Jeremiah said the city would be handed over to the \_\_\_\_\_ of the king  
of Babylon (38:3).

2. They put Jeremiah into a \_\_\_\_\_ (38:6).

3. The cistern was in the \_\_\_\_\_ (38:6).

4. Jeremiah was a \_\_\_\_\_ (38:9).

5. The king said, "Lift Jeremiah out before he \_\_\_\_\_" (38:10).



# JUDAH IS LEAD INTO CAPTIVITY

## (2 KINGS 25:1-21)

### MEMORY VERSE:

*"Thus Judah was carried away captive from its own land." 2 KINGS 25:21*

### TRUE OR FALSE:

1. "Nebuchadnezzar king of Babylon and all his army came against Jerusalem and encamped against it; and they built a siege wall against it all around." **2 KINGS 25:1**  
**TRUE OR FALSE**
2. "By the ninth day of the fourth month the famine had become so severe in the city that there was no food for the people of the land." **2 KINGS 25:3**  
**TRUE OR FALSE**

### CIRCLE THE CORRECT WORDS:

3. "Then the city wall was broken through, and all the men of war (**SLEPT, FLED**) at night by way of the gate between two walls, which was by the king's garden, even though the Chaldeans were still encamped all around against the city." **2 KINGS 25:4**
4. "But the army of the Chaldeans pursued the king, and they (**OVERTOOK, OVERLOOKED**) him in the plains of Jericho. All his army scattered from him." **2 KINGS 25:5**
5. "Nebuzaradan the captain of the guard, a servant of the king of Babylon, came to Jerusalem. He (**BURNED, BUILT**) the house of the LORD and the king's house; all the houses of Jerusalem, that is, all the houses of the great men, he burned with fire." **2 KINGS 25:8-9**
6. "And all the army of the Chaldeans who were with the captain of the guard broke down the (**WALLS, HALLS**) of Jerusalem all around." **2 KINGS 25:10**

### TRUE OR FALSE:

7. "Then Nebuzaradan the captain of the guard carried away captive the rest of the people who remained in the city and the defectors who had deserted to the king of Babylon, with the rest of the multitude." **2 KINGS 25:11**  
**TRUE OR FALSE**
8. The captain of the guard also took all of the poor of the land and left no one as vinedressers or farmers. **2 KINGS 25:12**  
**TRUE OR FALSE**

*"Thus Judah was carried away captive from its own land." 2 KINGS 25:21*

# JUDAH IS LEAD INTO CAPTIVITY

(2 KINGS 25:1-21)



"Thus Judah was carried away captive from its own land."  
2 KINGS 25:21

# JUDAH IS LEAD INTO CAPTIVITY

## (2 KINGS 25:1-21)

### MEMORY VERSE:

*"Thus Judah was carried away captive from its own land." 2 KINGS 25:21*

### TRUE OR FALSE:

1. "Nebuchadnezzar king of Babylon and all his army came against Jerusalem and encamped against it; and they built a siege wall against it all around." **2 KINGS 25:1**  
**TRUE OR FALSE**
2. "By the ninth day of the fourth month the famine had become so severe in the city that there was no food for the people of the land." **2 KINGS 25:3**  
**TRUE OR FALSE**

### FILL IN THE BLANKS:

3. "Then the city wall was broken through, and all the men of war \_\_\_\_\_ at night by way of the gate between two walls, which was by the king's garden, even though the Chaldeans were still encamped all around against the city." **2 KINGS 25:4**
4. "But the army of the Chaldeans pursued the king, and they \_\_\_\_\_ him in the plains of Jericho. All his army scattered from him." **2 KINGS 25:5**
5. "Nebuzaradan the captain of the guard, a servant of the king of Babylon, came to Jerusalem. He \_\_\_\_\_ the house of the LORD and the king's house; all the houses of Jerusalem, that is, all the houses of the great men, he \_\_\_\_\_ with fire." **2 KINGS 25:8-9**
6. "And all the army of the Chaldeans who were with the captain of the guard broke down the \_\_\_\_\_ of Jerusalem all around." **2 KINGS 25:10**

### TRUE OR FALSE:

7. "Then Nebuzaradan the captain of the guard carried away captive the rest of the people who remained in the city and the defectors who had deserted to the king of Babylon, with the rest of the multitude." **2 KINGS 25:11**  
**TRUE OR FALSE**
8. The captain of the guard also took all of the poor of the land and left no one as vinedressers or farmers. **2 KINGS 25:12**  
**TRUE OR FALSE**

*"Thus Judah was carried away captive from its own land." 2 KINGS 25:21*

# JUDAH IS LEAD INTO CAPTIVITY

## (2 KINGS 25:1-21)

H O U S E O F T H E L O R D N  
 J Y J U D A H G S Q L U N E N  
 E A G D O M H B C Y L O B E G  
 R W L Q O N U A M O L U B V A  
 U A W J F R P R U Y C U O K T  
 S D D J N T A W B H Z W W I N  
 A E I E I B N A A A D K H N B  
 L I D V U A B D R V N Y J G B  
 E R E C D S N A J Y F Y S N F  
 M R C N I E D K S B L E R A L  
 Q A P V Z A F E L C E H M G W  
 G C L Z N P I O J J D I V O A  
 H Q A D V G G I T N N L J Q L  
 M R O I E W I L B E K B D A L  
 G W P M E J E D V B A R U E S

- |              |                   |                |
|--------------|-------------------|----------------|
| ARMY         | FAMINE            | KING           |
| BABYLON      | FLED              | NEBUCHADNEZZAR |
| BURNED       | HOUSE OF THE LORD | NEBUZARADAN    |
| CAPTIVE      | JERUSALEM         | SEIGE          |
| CARRIED AWAY | JUDAH             | WALLS          |

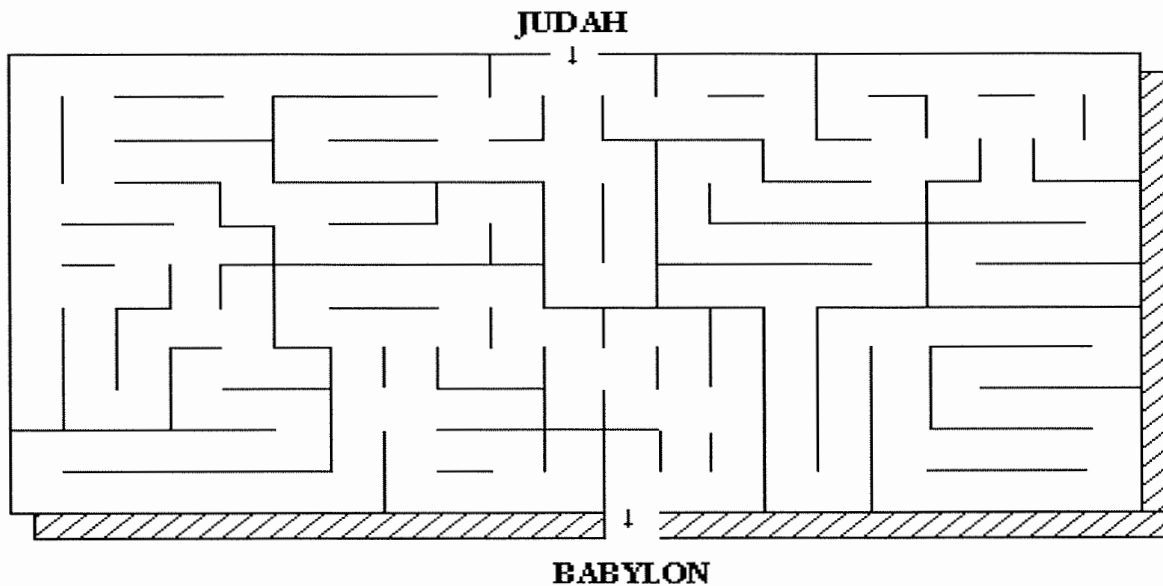

# JUDAH IS LEAD INTO CAPTIVITY

## (2 KINGS 25:1-21)

U L V I D E N R U B A H S D T S E N O Y  
 N V D Y E P G H M G J W U R G V G N I K  
 Y C H R J U F Z Q E S C I O P H N O E K  
 A B Q O L R O N R A M E I L M W H G B C  
 W H B I B P B U F H U D Y E R S A K Q D  
 A L K T N T S M U Q E R U H Y G D D P O  
 D F Q E N A R B N L Z Z W T L T U N W L  
 E H I H L E N O F Q N B Y F E W J M Q F  
 I O J E Z Y B M Q Y A P F O H A Y U P K  
 R C M I Z W R U G C D M Y E R L I G O Q  
 R C A P T I V E C L A B O S I L Y S G U  
 A N O L Y B A B T H R U S U V S Q Q B S  
 C G G E Q Y A C C V A F U O V B S P T R  
 B S P N N D G A A M Z D B H T U W H Y T  
 T M A I B S M C B O U S N T R C J R W F  
 G E R M P S E B N B B U U E A G K R K J  
 N Z M A G T W I B I E Y G D Z B T Q I S  
 G B Y F D T O X G B N P O H L Z P T G J  
 A O C M T W W N I E O B M Y J A A Y R E  
 L B Q O M N T I B H B K N J K K E R E F

- |                     |                          |                       |
|---------------------|--------------------------|-----------------------|
| <b>ARMY</b>         | <b>FAMINE</b>            | <b>KING</b>           |
| <b>BABYLON</b>      | <b>FLED</b>              | <b>NEBUCHADNEZZAR</b> |
| <b>BURNED</b>       | <b>HOUSE OF THE LORD</b> | <b>NEBUZARADAN</b>    |
| <b>CAPTIVE</b>      | <b>JERUSALEM</b>         | <b>SEIGE</b>          |
| <b>CARRIED AWAY</b> | <b>JUDAH</b>             | <b>WALLS</b>          |

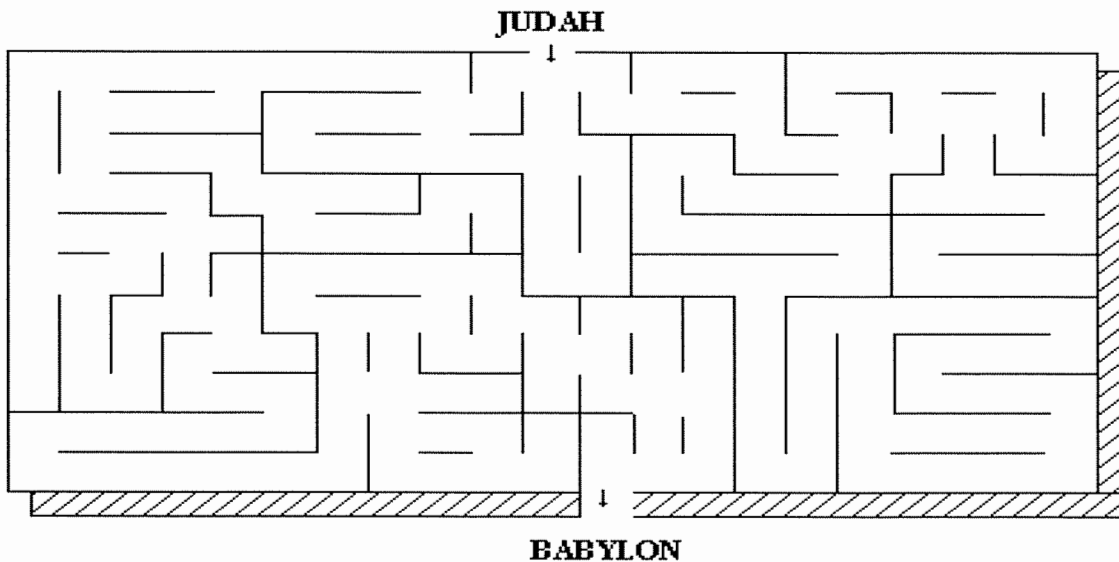

# Judah is Lead into Captivity (2 Kings 25:1-21)

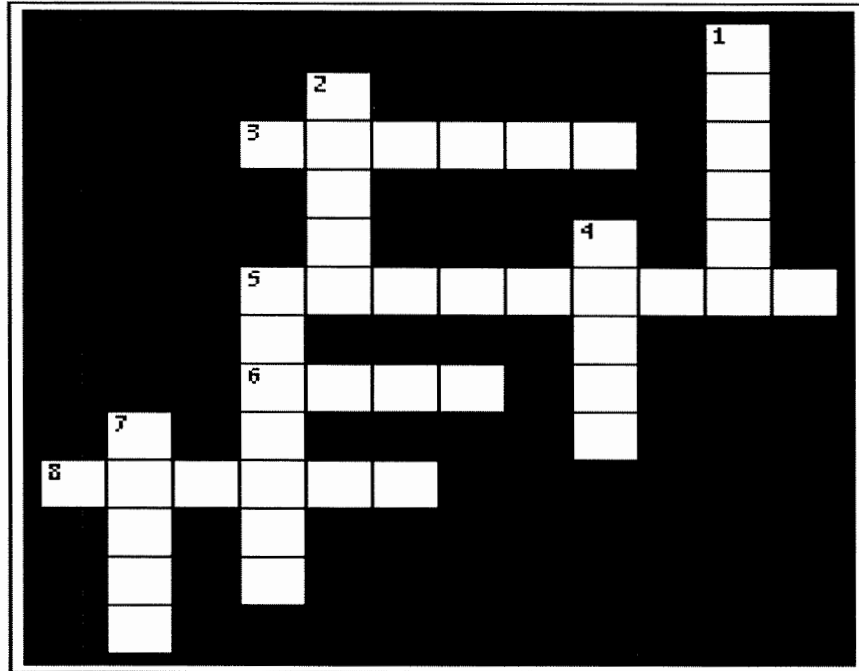

- 4 DOWN "Nebuchadnezzar king of Babylon and all his army came against Jerusalem and encamped against it; and they built a \_\_\_\_\_ wall against it all around." **2 KINGS 25:1**
- 8 ACROSS "By the ninth day of the fourth month the \_\_\_\_\_ had become so severe in the city that there was no food for the people of the land." **2 KINGS 25:3**
- 1 DOWN "Then the city wall was \_\_\_\_\_ through, and all the men of war fled at night by way of the gate between two walls, which was by the king's garden, even though the Chaldeans were still encamped all around against the city." **2 KINGS 25:4**
- 5 ACROSS "But the army of the \_\_\_\_\_ pursued the king, and they overtook him in the plains of Jericho. All his army scattered from him." **2 KINGS 25:5**
- 3 ACROSS "Nebuzaradan the captain of the guard, a servant of the king of Babylon, came to Jerusalem. He \_\_\_\_\_ the house of the LORD and the king's house; all the houses of Jerusalem, that is, all the houses of the great men, he burned with fire." **2 KINGS 25:8-9**
- 7 DOWN "And all the army of the Chaldeans who were with the captain of the guard broke down the \_\_\_\_\_ of Jerusalem all around." **2 KINGS 25:10**
- 5 DOWN "Then Nebuzaradan the captain of the guard carried away \_\_\_\_\_ the rest of the people who remained in the city and the defectors who had deserted to the king of Babylon, with the rest of the multitude." **2 KINGS 25:11**
- 6 ACROSS "But the captain of the guard left some of the \_\_\_\_\_ of the land as vinedressers and farmers." **2 KINGS 25:12**
- 2 DOWN "Thus \_\_\_\_\_ was carried away captive from its own land." **2 KINGS 25:21**

# 37. The Babylonian Captivity

A B C D E F G H I J K L M N O P Q R S T U V W X Y Z

Add or subtract the number of letters written under each line.

The people of Judah turned away from God and again began to  
serve  $\overline{K-2}$   $\overline{E-1}$   $\overline{L+3}$   $\overline{M-1}$   $\overline{Q+2}$

The prophet  $\overline{I+1}$   $\overline{H-3}$   $\overline{O+3}$   $\overline{D+1}$   $\overline{O-2}$   $\overline{L-3}$   $\overline{C-2}$   $\overline{F+2}$  warned the people  
that their evil ways would bring trouble. They didn't listen.

King  $\overline{O-1}$   $\overline{D+1}$   $\overline{D-2}$   $\overline{S+2}$   $\overline{F-3}$   $\overline{E+3}$   $\overline{E-4}$   $\overline{H-4}$   $\overline{K+3}$   $\overline{H-3}$   $\overline{X+2}$   $\overline{Y+1}$   $\overline{C-2}$   $\overline{S-1}$   
fought the people of Judah and won. He took the valuables out of  
the  $\overline{W-3}$   $\overline{G-2}$   $\overline{N-1}$   $\overline{O+1}$   $\overline{J+2}$   $\overline{B+3}$  and burned it.

The people were taken as captives to  
 $\overline{D-2}$   $\overline{B-1}$   $\overline{A+1}$   $\overline{Z-1}$   $\overline{J+2}$   $\overline{R-3}$   $\overline{J+4}$   
Jeremiah prophesied that the people would return to Jerusalem  
after  $\overline{Q+2}$   $\overline{F-1}$   $\overline{U+1}$   $\overline{C+2}$   $\overline{P-2}$   $\overline{P+4}$   $\overline{X+1}$  years.

# 38. Homesick Jews

The people of Judah, now called Jews, were captives in Babylon. There were Babylonian idols all around them, but the Jews only wanted to serve God. God sent prophets to encourage the people.

The people taught their children about God and Jerusalem. They often sang songs about Jerusalem, which is also called Zion. One of the songs is found in Psalm 137.

By the rivers of Babylon we sat and wept  
 when we remembered Zion.  
 There on the poplars  
 we hung our harps,  
 for there our captors asked us for songs,  
 our tormentors demanded songs of joy;  
 they said, "Sing us one of the songs of Zion!"  
 How can we sing the songs of the LORD  
 while in a foreign land?  
 If I forget you, O Jerusalem,  
 may my right hand forget its skill.  
 May my tongue cling to the roof of my mouth  
 if I do not remember you,  
 if I do not consider Jerusalem  
 my highest joy. (NIV)

Fit the underlined words into the stack-a-word puzzle below.

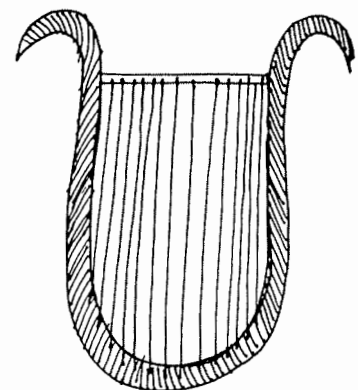
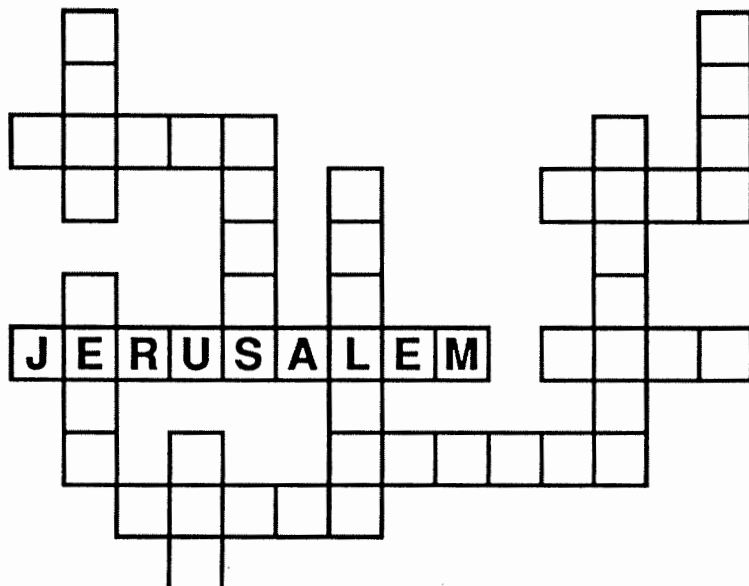



**Year 2**

**Week 102**

## **Daniel Explains Dreams**

**Scriptures: Daniel 2**

**Key Verse: Daniel 2:44** "'And in the days of these kings the God of heaven will set up a kingdom which shall never be destroyed; and the kingdom shall not be left to other people; it shall break in pieces and consume all these kingdoms, and it shall stand forever.'"

### **Key Points:**

- 1.** Daniel was taken to Babylon, along with king Jehoiakim, to serve as a wise man in King Nebuchadnezzar's palace because he was young, handsome, intelligent, and of noble blood. (Daniel 1:1-7)
- 2.** King Nebuchadnezzar had a troubling dream. He sent for his magicians and astrologers and told them to first tell him his dream and then its interpretation. The magicians said they couldn't retell the dream. The king was furious and gave the command to kill all the wise men in the kingdom.
- 3.** When Daniel heard of the king's decree, he went to his house and prayed to God that He might reveal the secret. That night God showed Daniel the dream and its meaning in a vision.
- 4.** Daniel goes before the king and explains that the dream is telling the future, and that God has revealed it to him. (Read Daniel 2:31-45) God told Nebuchadnezzar through his dream that there would be three world powers that would come after Babylon, but that all these kingdoms would be broken by a kingdom built by God - one that would fill the whole earth and never be destroyed.
- 5.** Nebuchadnezzar gave glory to God and made Daniel a ruler of Babylon. He also promoted Daniel's friends: Shadrach, Meshach, and Abed-Nego.

# Bad King/ Good King

Manasseh did many bad things that the Lord said not to do. When the Lord used the Assyrian army to punish Manasseh, he became very sorry for all the wrong he had done. Manasseh begged God for help and God forgave him.

To find out what Manasseh said then, write the words in the shapes in the crown.

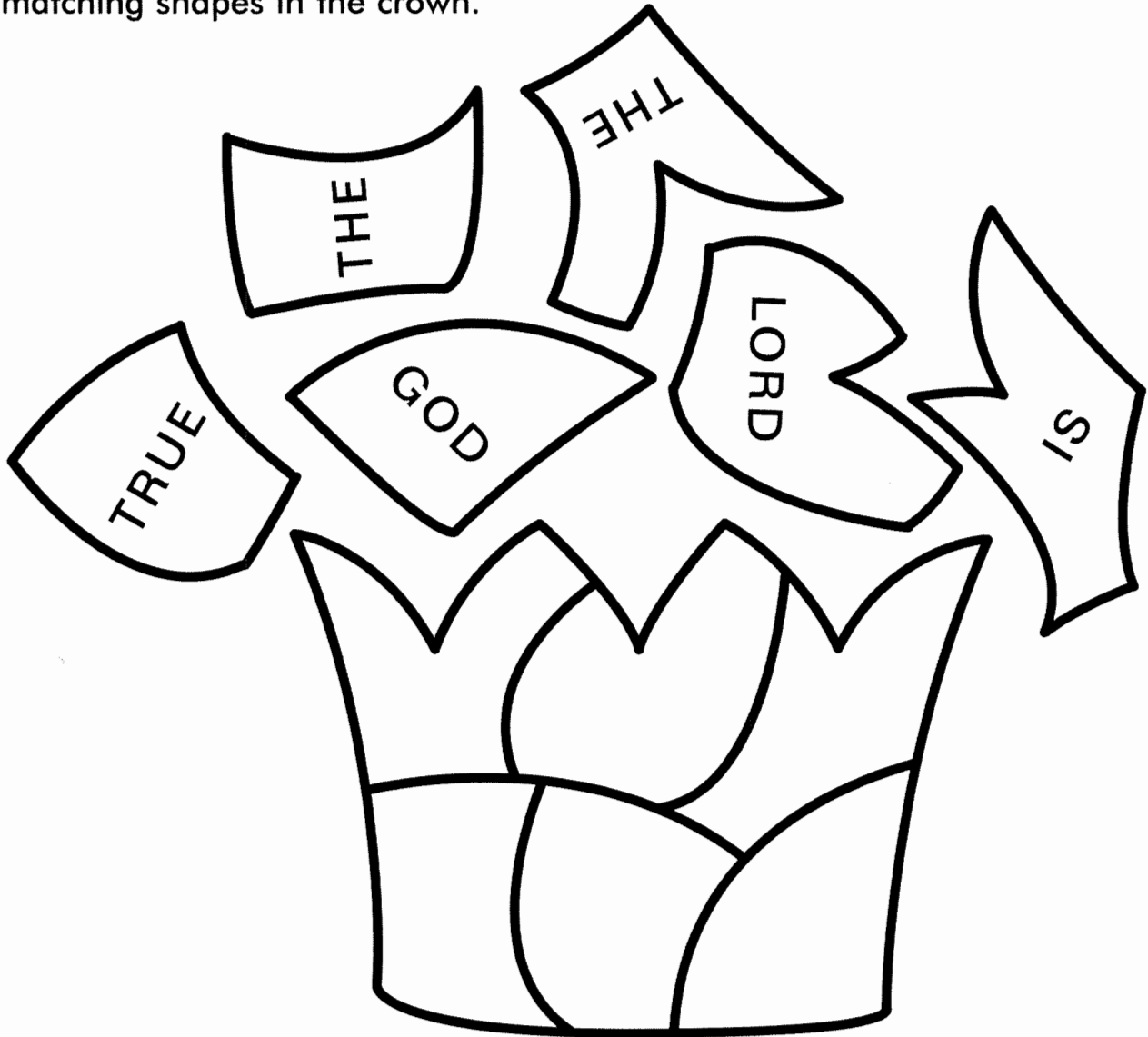

# NEBUCHADNEZZAR'S DREAM

## (DANIEL 2:1-49)

**MEMORY VERSE:**

*"Truly your God is the God of gods, the Lord of kings, and a revealer of secrets." DANIEL 2:47*

**CIRCLE THE CORRECT WORD:**

1. "Now in the second year of Nebuchadnezzar's reign, Nebuchadnezzar had (SCREAMS, DREAMS)."  
DANIEL 2:1

**TRUE OR FALSE:**

2. "His spirit was so troubled that his sleep left him." DANIEL 2:1  
TRUE OR FALSE

**CIRCLE THE CORRECT WORDS:**

3. "Then the king gave the command to call the ...

magicians

clowns

queen

astrologers

sorcerers

Chaldeans

to tell the king his dreams." DANIEL 2:2

**TRUE OR FALSE:**

4. The king said to them, "If you do not make known the dream to me, and its interpretation, you shall be cut in pieces, and your houses shall be made an ash heap." DANIEL 2:5  
TRUE OR FALSE
5. The Chaldeans said to the king, "It is a difficult thing that the king requires, and there is no other who can tell it to the king except the gods, whose dwelling is not with flesh." DANIEL 2:11  
TRUE OR FALSE
6. For this reason the king was very happy and joyful, and gave a command to celebrate the wisdom of the Chaldeans. DANIEL 2:12

TRUE OR FALSE

**CIRCLE THE CORRECT WORDS:**

7. "So the decree went out, and they began (KILLING, PRAISING) the wise men of Babylon." DANIEL 2:13
8. "Daniel went in and asked the king to give him (MONEY, TIME), that he might tell the king the interpretation." DANIEL 2:16
9. "Then Daniel went to his house, and made the decision known to Hananiah, Mishael, and Azariah, his companions, that they might seek mercies from the (GOD, CLOUDS) of heaven concerning this secret, so that Daniel and his companions might not perish with the rest of the wise men of Babylon." DANIEL 2:17-18

**TRUE OR FALSE:**

10. But the secret was not revealed to Daniel or to his companions. DANIEL 2:19  
TRUE OR FALSE

**CIRCLE THE CORRECT WORD:**

11. Daniel was brought before the king and said, "There is a God in heaven who reveals secrets, and He has made known to King Nebuchadnezzar what will be in the (EARLY, LATTER) days." DANIEL 2:28

# NEBUCHADNEZZAR'S DREAM

(DANIEL 2:1-49)

A R K Z H D Q S H B A C D U P  
S C O Y E C O W Q K R S D E N  
H M I C Z V A U O S L C O A O  
H L R Y Y T Y O R T S E D V I  
E E D N A M M O C U W H K D S  
A B T O N W W D E H J U Q Q I  
P B E J J H S L E E P E K E V  
C A J F T P V L E I N A D N T  
U R A Z Z E N D A H C U B E N  
M C K A P S E I C R E M L R V  
D W N E M E S I W P U C W Y R  
L G O D L J M S W E O N K Y F  
L A T T E R D A Y S E Q I D E  
S J K H J H F J E V P L J J J  
V U P A S M A E R D T K S I O

ASH HEAP

DREAMS

MERCIES

COMMAND

GOD

SLEEP

DANIEL

LATTER DAYS

VISION

DECREE

NEBUCHADNEZZAR

WISE MEN

DESTROY

# NEBUCHADNEZZAR'S DREAM

(DANIEL 2:1-49)

L Z X L M E I P C R O S E E Y W D J N A  
 B F E O E B F C R E O A Z N G Y I C S O  
 M W W U T D B V P N K U P A M U C H B I  
 I X G P L V L U R V P K E I M K H N A L  
 O Y F W M N A S E I C R E M L E I N A D  
 X D N A M M O C E T Z S U P A Y P V S D  
 K L Z C E R E I M O S Y D P U H L D P S  
 E N A S Z P A P H J T R V Q V F O I W U  
 Y D N Y I Y Z Z Y Q E X W I S E M E N J  
 T C S A I G C N Z A V F F F E Q P M J L  
 E V H D D N L S M E G L I R Z N E O H J  
 Z O U R Z W W S Y L N K U C U H E O N T  
 Q S S E P N C Y M P W D H G U M R F F B  
 V K Y T Z Y O C O V D I A O I G C L G V  
 L L J T V Z A I B R K Q I H M Q E D I Q  
 S D N A U U Z N S G T S P W C W D I E O  
 R F D L S L E E P I G S K J Q U D V G V  
 S A Y P D G S P P Y V O E V B G B E W Y  
 B B I R W F D C R Q A S D D V M Q E K X  
 B R B F E Y G R Y D G O R H B W J M N C

**ASH HEAP**

**DREAMS**

**NEBUCHADNEZZAR**

**COMMAND**

**GOD**

**SLEEP**

**DANIEL**

**LATTER DAYS**

**VISION**

**DECREE**

**MERCIES**

**WISE MEN**

**DESTROY**

# NEBUCHADNEZZAR'S DREAM

## (DANIEL 2:1-49)

### MEMORY VERSE:

*"Truly your God is the God of gods, the Lord of kings, and a revealer of secrets."* DANIEL 2:47

### FILL IN THE BLANK:

1. "Now in the second year of Nebuchadnezzar's reign, Nebuchadnezzar had \_\_\_\_\_." DANIEL 2:1

### TRUE OR FALSE:

2. "His spirit was so troubled that his sleep left him." DANIEL 2:1  
TRUE OR FALSE

### CIRCLE THE CORRECT WORDS:

3. "Then the king gave the command to call the ...

magicians

clowns

queen

astrologers

sorcerers

Chaldeans

to tell the king his dreams." DANIEL 2:2

### TRUE OR FALSE:

4. The king said to them, "If you do not make known the dream to me, and its interpretation, you shall be cut in pieces, and your houses shall be made an ash heap." DANIEL 2:5  
TRUE OR FALSE
5. The Chaldeans said to the king, "It is a difficult thing that the king requires, and there is no other who can tell it to the king except the gods, whose dwelling is not with flesh." DANIEL 2:11  
TRUE OR FALSE
6. For this reason the king was very happy and joyful, and gave a command to celebrate the wisdom of the Chaldeans. DANIEL 2:12

TRUE OR FALSE

### FILL IN THE BLANKS:

7. "So the decree went out, and they began \_\_\_\_\_ the wise men of Babylon." DANIEL 2:13
8. "Daniel went in and asked the king to give him \_\_\_\_\_, that he might tell the king the interpretation." DANIEL 2:16
9. "Then Daniel went to his house, and made the decision known to Hananiah, Mishael, and Azariah, his companions, that they might seek \_\_\_\_\_ from the \_\_\_\_\_ of heaven concerning this secret, so that Daniel and his companions might not perish with the rest of the wise men of Babylon." DANIEL 2:17-18

### TRUE OR FALSE:

10. But the secret was not revealed to Daniel or to his companions. DANIEL 2:19  
TRUE OR FALSE

### FILL IN THE BLANKS:

11. Daniel was brought before the king and said, "There is a God in heaven who reveals secrets, and He has made known to King Nebuchadnezzar what will be in the \_\_\_\_\_." DANIEL 2:28

# NEBUCHADNEZZAR'S DREAM

## (DANIEL 2:1-49)

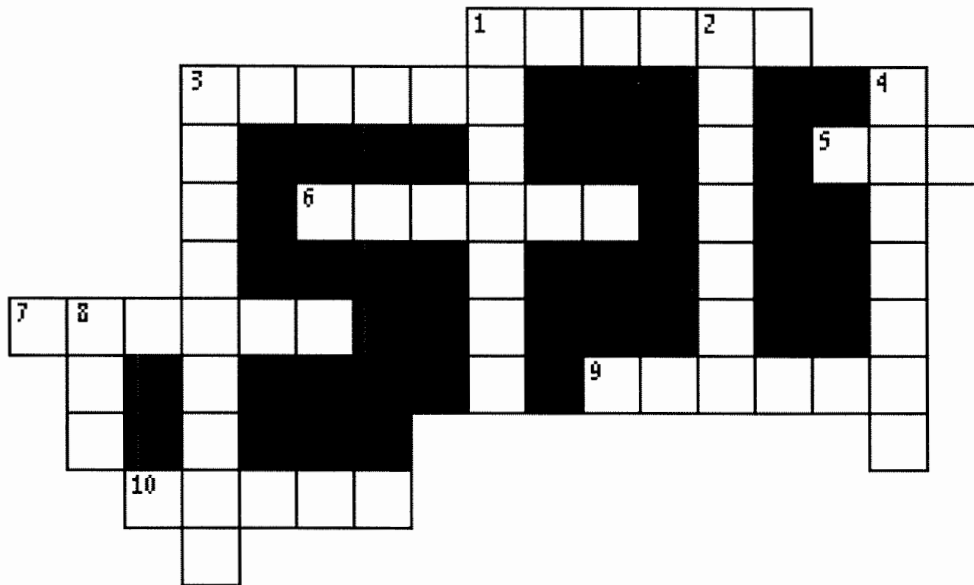

- 1 ACROSS "Now in the second year of Nebuchadnezzar's reign, Nebuchadnezzar had \_\_\_\_." **DANIEL 2:1**
- 10 ACROSS "His spirit was so troubled that his \_\_\_\_ left him." **DANIEL 2:1**
- 4 DOWN "Then the king gave the \_\_\_\_ to call the magicians, the astrologers, the sorcerers and the Chaldeans to tell the king his dreams." **DANIEL 2:2**
- 8 DOWN The king said to them, "If you do not make known the dream to me, and its interpretation, you shall be cut in pieces, and your houses shall be made an \_\_\_\_ heap." **DANIEL 2:5**
- 3 DOWN The Chaldeans said to the king, "It is a \_\_\_\_ thing that the king requires, and there is no other who can tell it to the king except the gods, whose dwelling is not with flesh." **DANIEL 2:11**
- 1 DOWN "For this reason the king was angry and very furious, and gave a command to \_\_\_\_ all the wise men of Babylon." **DANIEL 2:12**
- 3 ACROSS "So the \_\_\_\_ went out, and they began killing the wise men of Babylon." **DANIEL 2:13**
- 7 ACROSS "\_\_\_\_ went in and asked the king to give him time, that he might tell the king the interpretation." **DANIEL 2:16**
- 2 DOWN "Then Daniel went to his house, and made the decision known to Hananiah, Mishael, and Azariah, his companions, that they might seek \_\_\_\_ from the God of heaven concerning this secret." **DANIEL 2:17-18**
- 9 ACROSS "Then the secret was revealed to Daniel in a night \_\_\_\_." **DANIEL 2:19**
- 6 ACROSS Daniel was brought before the king and said, "There is a God in heaven who reveals secrets, and He has made known to King Nebuchadnezzar what will be in the \_\_\_\_ days." **DANIEL 2:28**
- 5 ACROSS "Truly your \_\_\_\_ is the God of gods, the Lord of kings, and a revealer of secrets." **DANIEL 2:47**

**Daniel's Three Friends and the Fiery Furnace**

**Scriptures: Daniel 3**

**Key Verse: Dan 3:16-17** Shadrach, Meshach, and Abed-Nego answered and said to the king, "O Nebuchadnezzar, we have no need to answer you in this matter. (17) If that is the case, our God whom we serve is able to deliver us from the burning fiery furnace, and He will deliver us from your hand, O king.

**Key Points:**

1. King Nebuchadnezzar erects a great image for all the rulers of Babylon to worship.
2. At the sound of music, all those present would fall down and worship the image.
3. Chaldeans reported to Nebuchadnezzar that Shadrach, Meshach, and Abed-Nego refused to bow down to the image.
4. Nebuchadnezzar confronts Daniel's three friends; they confirm their refusal to worship the image.
5. For their refusal, Nebuchadnezzar binds Shadrach, Meshach, and Abed-Nego, heats a furnace seven times hotter than normal, and casts them in for destruction.
6. Even though the ones who cast the three men into the furnace lost their life, Shadrach, Meshach, and Abed-Nego lived through the ordeal.
7. While they were in the fiery furnace, a fourth person -- described as one like the Son of God -- was walking in the midst of the flames.
8. Shadrach, Meshach, and Abed-Nego are removed from the furnace without any indication that they were in the furnace; consequently, Nebuchadnezzar praises God.



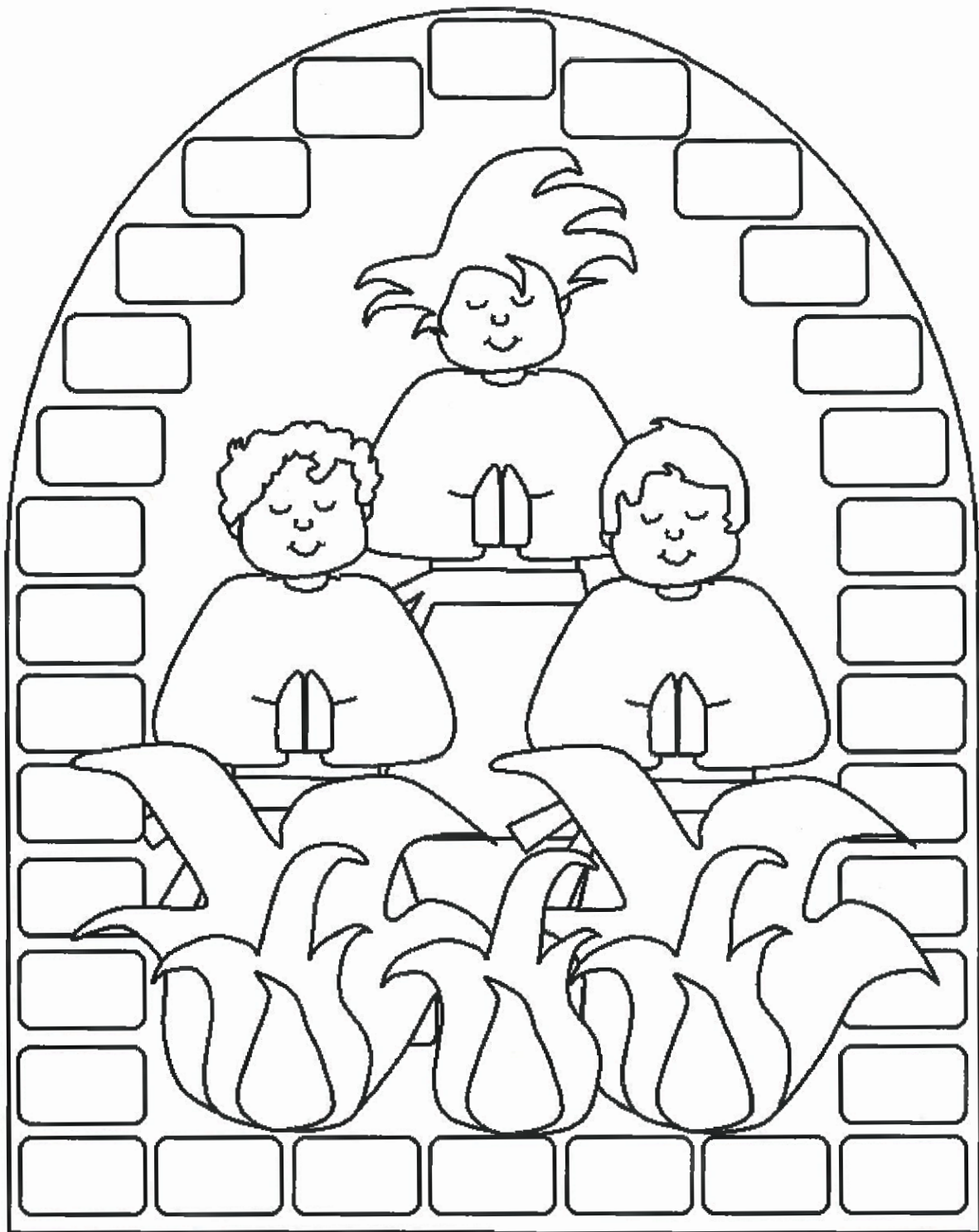

And he commanded the most mighty men that were in his army to bind Shadrach, Meshach, and Abed-nego, and to cast them into the burning fiery furnace.

*Daniel 3:20*



king



Shadrach



Meshach



Abednego



music

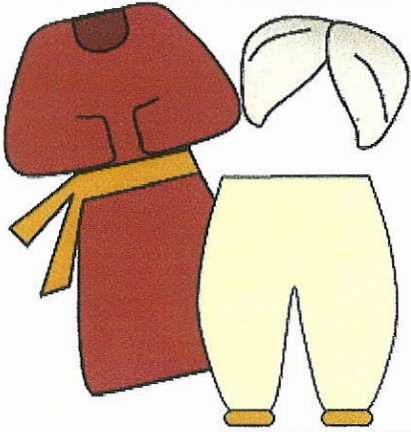

clothes

3

three

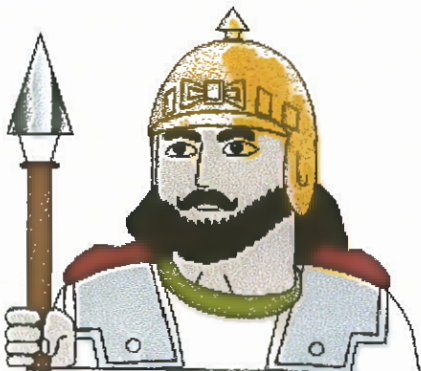

soldier



gold



fire



angel



statue



# The Three Faithful Men

This is a story about a King and three brave men, all with really strange names. The king's name is Nebuchadnezzar and the three men were known as Shadrach, Meshach, and Abednego. They lived in a place called Babylon and the three men worked for the king and had important jobs for the province of Babylon.

One day the king decided to build a huge image made of gold that stood 90 feet high. To understand how tall this is, imagine 15 men all standing one on top of the other to make a tall tower. It sure was big!

King Nebuchadnezzar then made an announcement. "People of all languages, when you hear the music, you must bow down and worship the statue because I have said so. Whoever does not obey and worship the statue will immediately be thrown into a fiery furnace."

The problem with this is God does not want us to worship anything or anyone other than Him. After all, he is God, He made us, and He loves us so much. He came to earth and died for us and cares about every little thing in our lives.

Why would we want to pray or worship something that isn't real, something that can't answer our prayers or help us? To worship a big pile of gold like the one that king Nebuchadnezzar set up is silly. The gold can't hear, see, or care about anything or anyone.

So the next time the music played everyone stopped what they were doing and they bowed down to worship this idol. Everyone that is, except for Shadrach, Meshach, and Abednego. Some of the king's workers (that were jealous that Shadrach, Meshach, and Abednego had such good jobs) saw that they would not bow down to the image so they immediately ran to tell the king.

When king Nebuchadnezzar heard the news he was very angry. He immediately ordered that Shadrach, Meshach, and Abednego be brought to him to explain their actions.

The men were brought before the king and Nebuchadnezzar said to them, "Is it true, Shadrach, Meshach and Abednego, that you will not bow down and worship the image of gold that I have made? Just in case there was a mistake I will give you another chance. When the music plays again you will be ready and bow down to the image, and if you don't this time you will be thrown into a fiery furnace. Then what god will be able to save you?"

Shadrach, Meshach, and Abednego looked at each other and replied to the king, "O Nebuchadnezzar, we did not make a mistake nor will we apologize for not bowing down. If we are thrown into the furnace, the God we worship will save us, and he will rescue us. But even if he doesn't, we want you to know, that we will not serve your gods or worship the image of gold you have set up."

That made Nebuchadnezzar even more mad. Right away he ordered the furnace to be heated way hotter than it usually was and commanded some of the strongest soldiers to take Shadrach, Meshach, and Abednego to throw them in the fire.

The soldiers took the three men just as they were straight to the furnace. The men were wearing all their clothes including robes, their shirts and pants underneath that, and turbans on their heads. These things would catch fire very easily in the fire.

As the soldiers were pushing the men into the furnace the flames of the fire killed the soldiers, because the fire was so hot and Shadrach, Meshach, and Abednego fell into the hot, hot furnace.

Then king Nebuchadnezzar jumped to his feet in amazement and asked his advisors, "Weren't there only three men thrown into the fire?" They replied, "O, yes king." He said, "Look! I see four men walking around in the fire, untied and unhurt, and the fourth looks like some kind of angel!"

Nebuchadnezzar then came as close as he could to the furnace and shouted in the doorway, "Shadrach, Meshach, and Abednego, follower of the Most High God, come out! Come here!"

So the three men walked out of the furnace without any burns, no hairs on their head burned, all their clothes perfectly fine, and no smell of fire on them at all.

At that moment Nebuchadnezzar knew that they worshipped a real God not some fake statue. God had sent an angel to protect them from harm, and even more importantly he realized that they truly believed and trusted in God. They were willing to die rather than serve or worship any god except their own God.

So from that day on the king made an announcement that all the people, people of all languages could not say anything bad about Shadrach, Meshach, and Abednego's God or they would be badly punished.

The king then gave the three men even better jobs than they already had for the province of Babylon.

# 157. THE FIERY FURNACE

(DANIEL 3:1-30)



"Then Nebuchadnezzar the king was astonished, and rose up in haste, *and* spake, and said unto his counsellors, Did not we cast three men bound into the midst of the fire? They answered and said unto the king, True, O king. He answered and said, Lo, I see four men loose, walking in the midst of the fire, and they have no hurt; and the form of the fourth is like the Son of God."

DANIEL 3:24-25



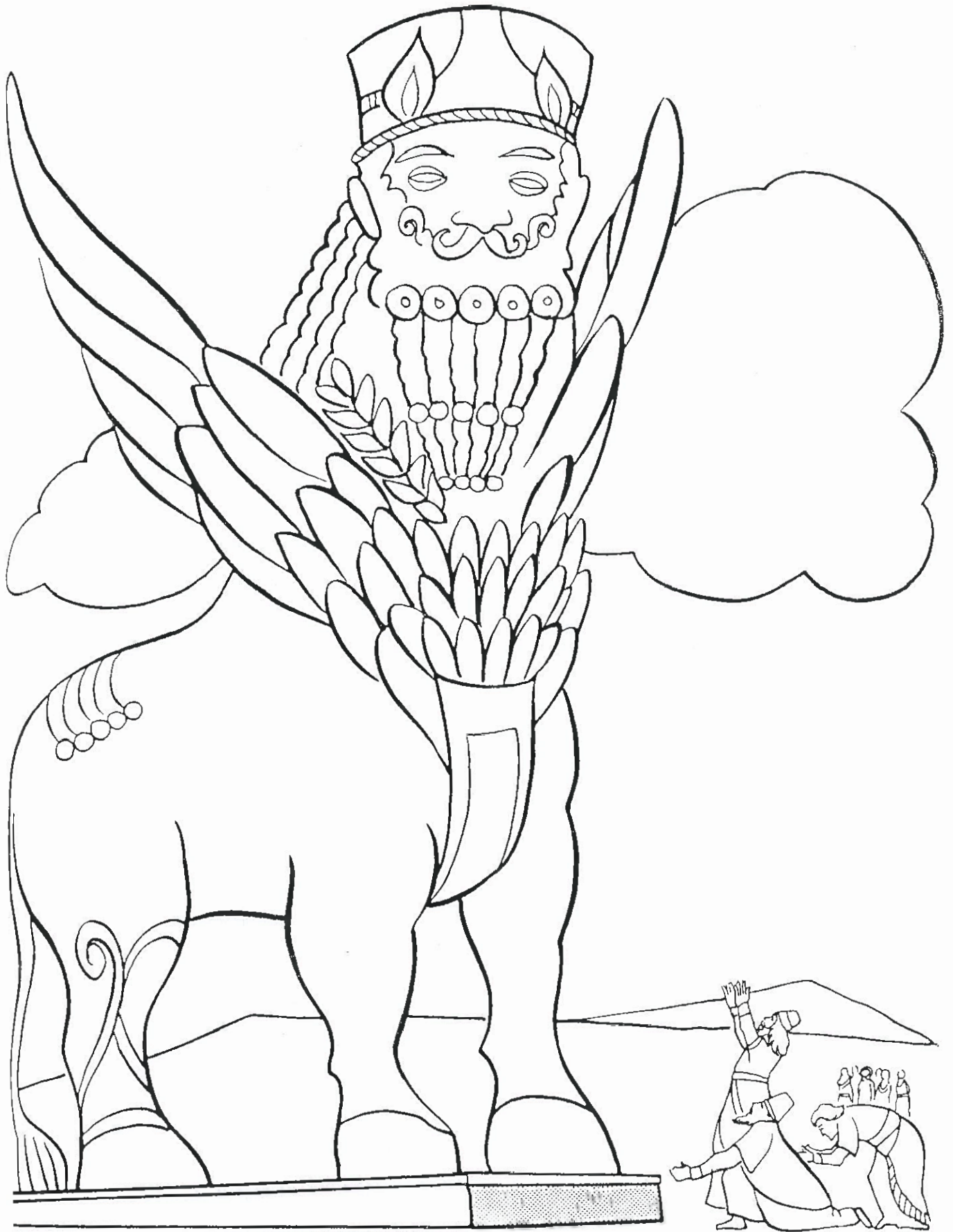

Daniel would not worship their idol, which was a golden image of King Nebuchadnezzar.



## The Fiery Furnace

Read the Bible story at <http://gardenofpraise.com/bibl19s.htm>

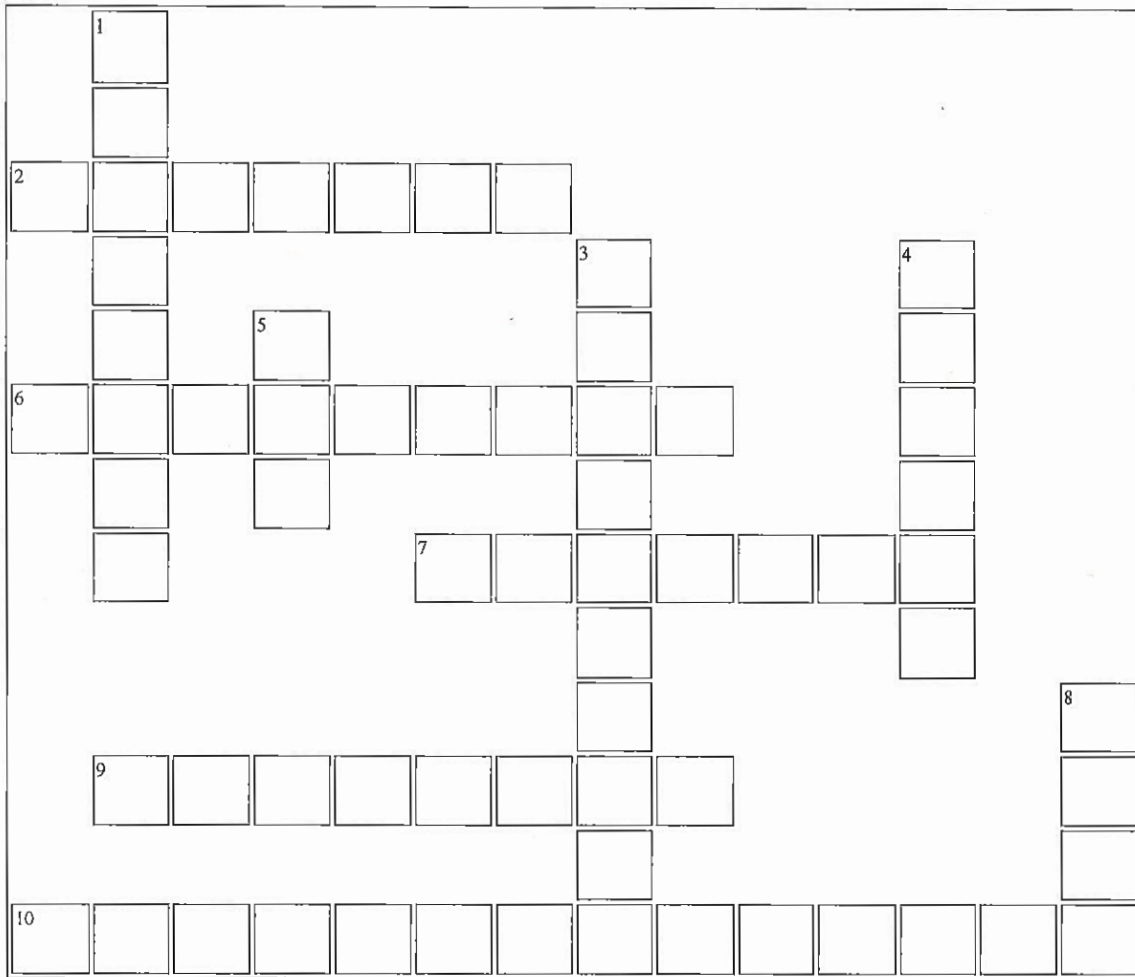

### Across

2. the land to which the captives were taken
6. The boys had been \_\_\_\_ by the fire.
7. the punishment for disobedience
9. The three boys were Shadrach, Meshach, and \_\_\_\_.
10. the king who made a gold idol

### Down

1. One in the fire looked like a \_\_\_\_ being.
3. The young men worshiped \_\_\_\_.
4. The fire \_\_\_\_ the men who threw them in.
5. \_\_\_\_ had delivered them from the flames.
8. the number of men the king saw in the flames

WORD BANK: NEBUCHADNEZZAR, FURNACE, BABYLON, ABEDNEGO, KILLED,

THE TRUE GOD, HEAVENLY, UNTOUCHED, GOD, FOUR

# FRIENDS IN THE FIRE

## Daniel 3

### EXERCISE 1

FILL IN THE MISSING WORDS TO COMPLETE THIS BIBLE STORY.

King Nebuchadnezzar made a huge statue of \_\_\_\_\_.

He commanded all the people to \_\_\_\_\_ down and \_\_\_\_\_ the statue. Anyone who did not obey the king's command would be thrown into a fiery \_\_\_\_\_. Shadrach, Meshach and Abednego \_\_\_\_\_ obey the command. They were taken to stand before the king. The king said, "No \_\_\_\_\_ can save you from the fiery furnace."

Shadrach, Meshach and Abednego were tied up and thrown into the fire. \_\_\_\_\_ saved them from the flames. Not even one \_\_\_\_\_ on their heads was burned. King Nebuchadnezzar said, "Blessed be the \_\_\_\_\_ of Shadrach, Meshach and Abednego!"



They were thrown into a fiery furnace, but did not burn.  
God's angel was with them and protected them.



Help Shadrach, Meshach, and Abednego find their way out of the fire.  
Draw a path from the furnace flames to King Nebuchadnezzar.



King Nebuchadnezzar said, "Shadrach, Meshach, and  
Abednego, servants of the Most High God, come out! Come  
here!"  
Daniel 3:26

# Rescued!



What did the king say when God rescued Shadrach, Meshach, and Abednego from the fiery furnace? Above each letter, write the letter that comes after it in the alphabet. Hint: After Z comes A.

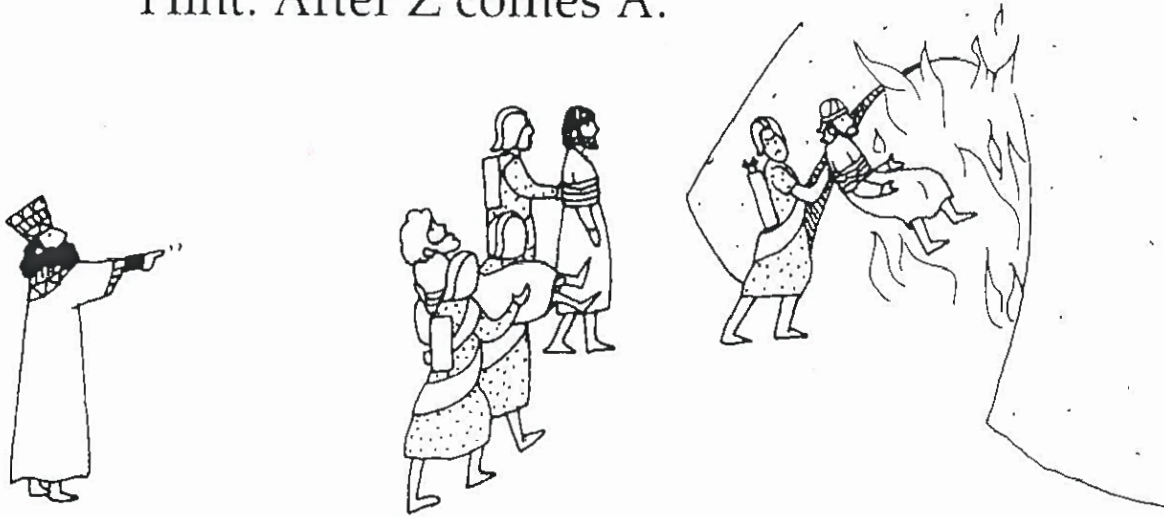

<u>    </u> M N	<u>    </u> N S G D Q	<u>    </u> F N C	<u>    </u> B Z M
<u>    </u> R Z U D	<u>    </u> H M	<u>    </u> S G H R	<u>    </u> V Z X !

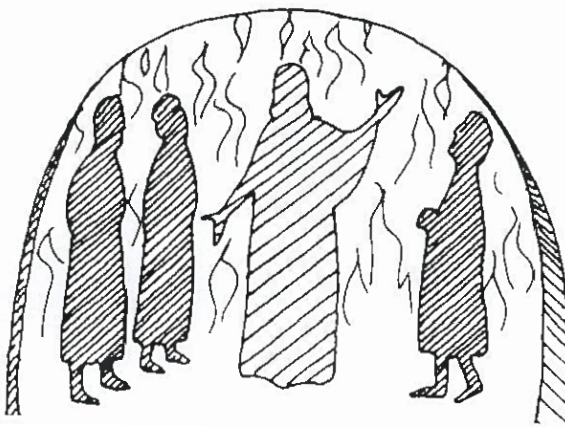



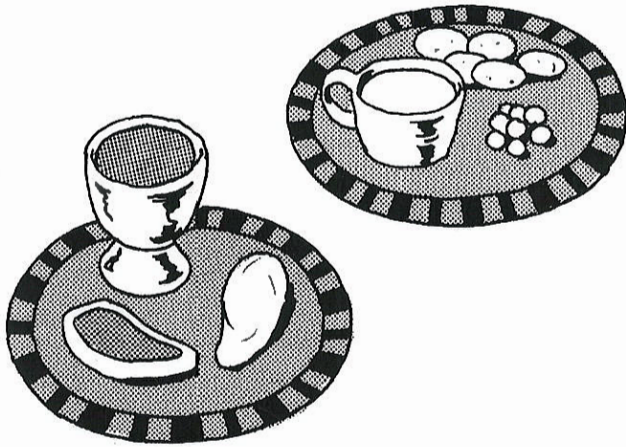

**Directions:**

Cut two plates from construction paper and two from tagboard, all 5 inches in diameter. Glue a paper plate to each tagboard plate. Decorate plates with felt-tip pens or paints. Model food out of bread-dough clay or any self-hardening clay. When food is thoroughly dry, color with the pens or paints. Glue to plates. Cut the cups down to 1½ inches tall. Cover cups with the foil. Twist or fold a scrap to make the handle. Staple or glue in place. Make stem and base of goblet with the extra foil by twisting and flattening into shape. Stuff each container with a bit of plastic from a dry-cleaning bag. (Watch this around children!) Tint the "wine" with a red felt-tip pen. Glue cup and goblet to plates.

(\*See recipe on page 5 for bread dough.)

## In the Fiery Furnace

*Daniel 3*

**Materials needed:**

- Tagboard
- Construction paper—black, red, orange



- Glue
- Crayons, felt-tip pens, or tempera paints

**Directions:**

Cut the four figures from tagboard, using the patterns on pages 27 and 28. Color the figures. Cut free-form flames from red construction paper. Cut these about 9½ inches wide and 4 inches high at peaks. Make three folds in flames, then add yellow color. Place glue on bottom and sides of flames and glue to orange sheet, about 1½ inches from bottom. Allow flames to "pleat" where they were folded to give them a slight 3-D effect. Cut a piece of black paper, 9 inches by 2½ inches. Put glue on bottom and sides of this and place at bottom, over flames. Figures can now be slipped behind flames and removed easily.

## Esther Paper Doll



**Materials needed:**

- Tagboard
- Construction paper—various colors
- Glue
- Gold glitter
- Cotton ball
- Felt-tip pens or tempera paints
- Fancy wrapping paper (optional)

**Directions:**

Cut paper doll out of tagboard, using pattern on page 30. Color with the pens or paints. Cut robe and crown from construction paper. Glue tabs of crown together. Add glue to crown and dip into glitter (or sprinkle on glitter). Unroll cotton ball and use it to trim robe. Make dresses using fancy wrapping paper or use construction paper and decorate with glitter, etc. Add Post-It Note tape to backs of all garments.

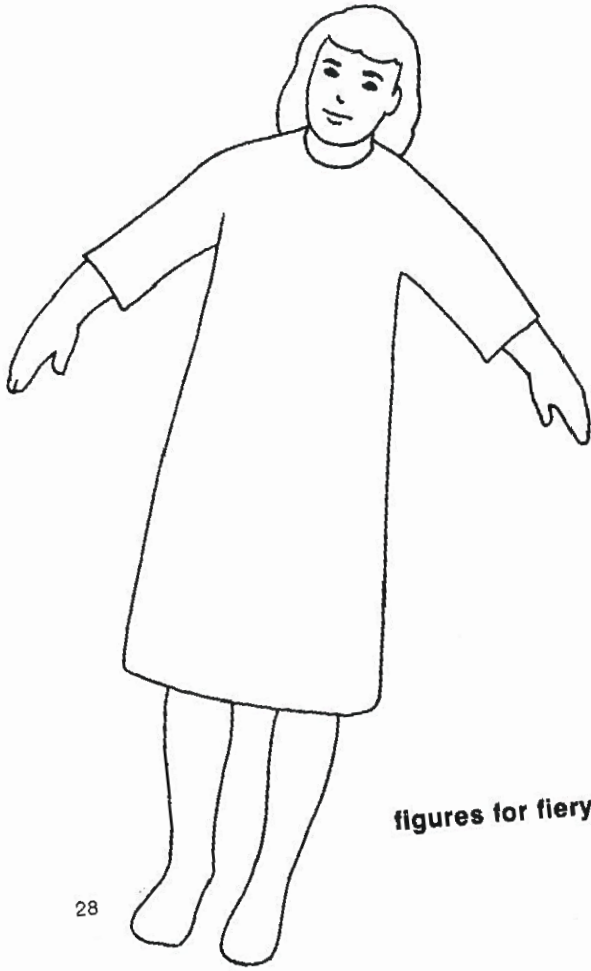

figures for fiery furnace

28

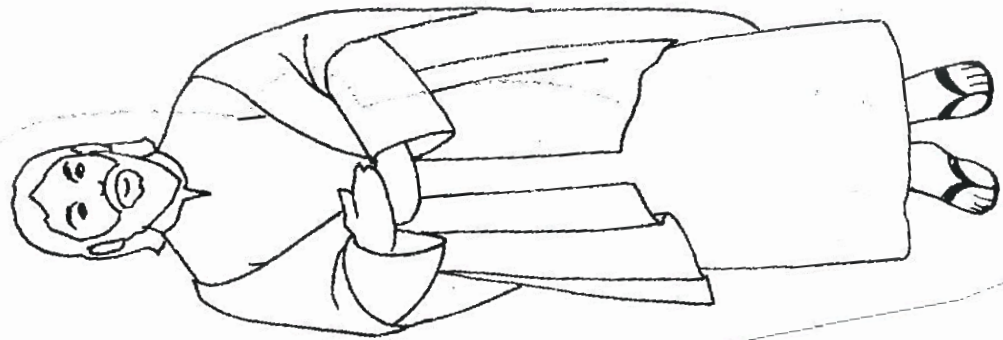
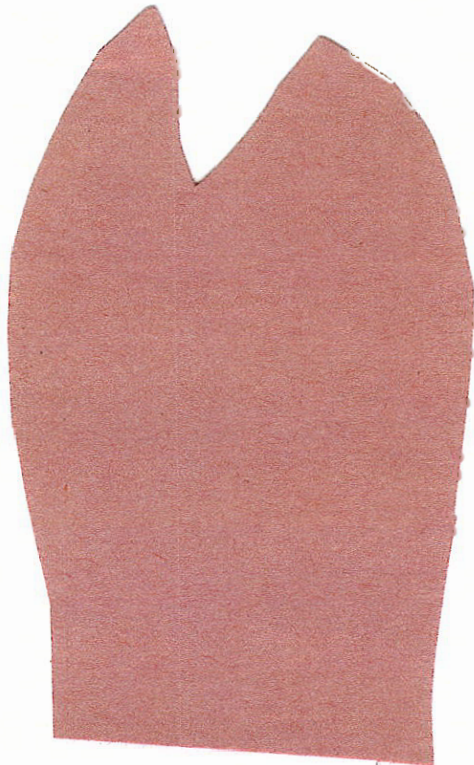
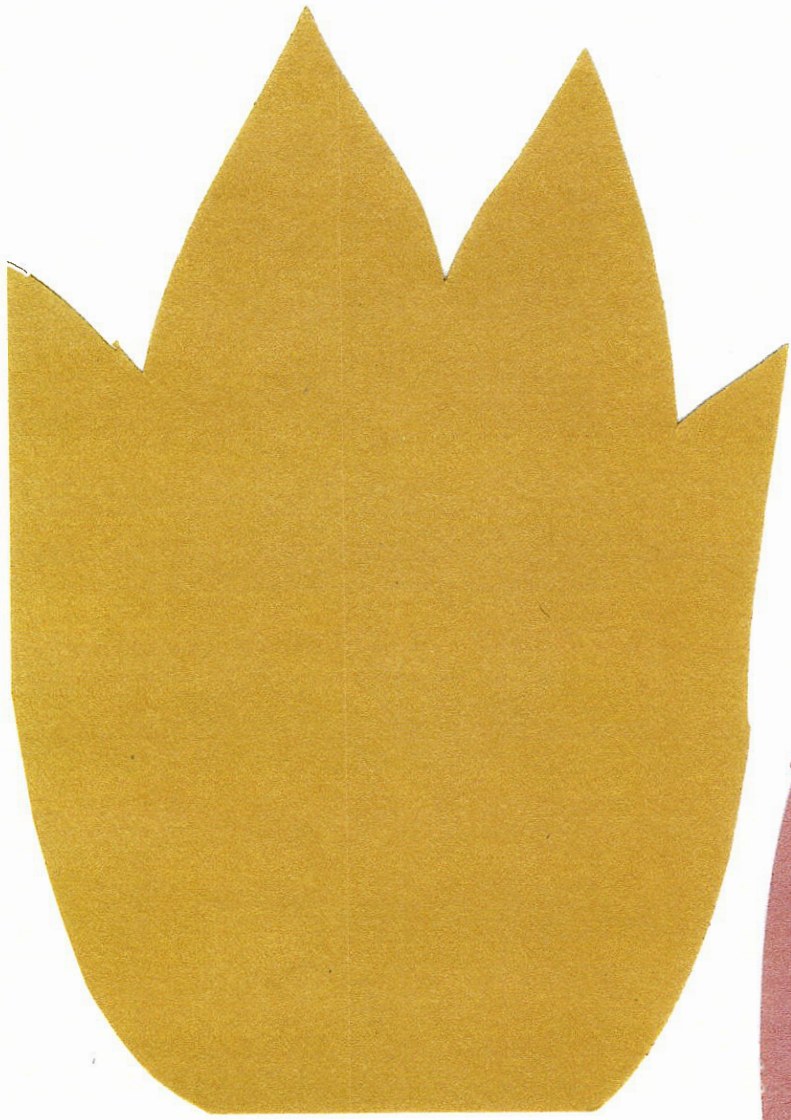

figure for fiery furnace







# DANIEL 3

CEARUFN

TRHWON

REEVS

ESIARP

ZINGBAL



WHAT KING NEBUCHADNEZZAR GAVE  
THE 3 ISRAELITES:

A      BY

# Three Brave Friends

To find out what Shadrach, Meshach, and Abednego told the king,  
color in the empty spaces.

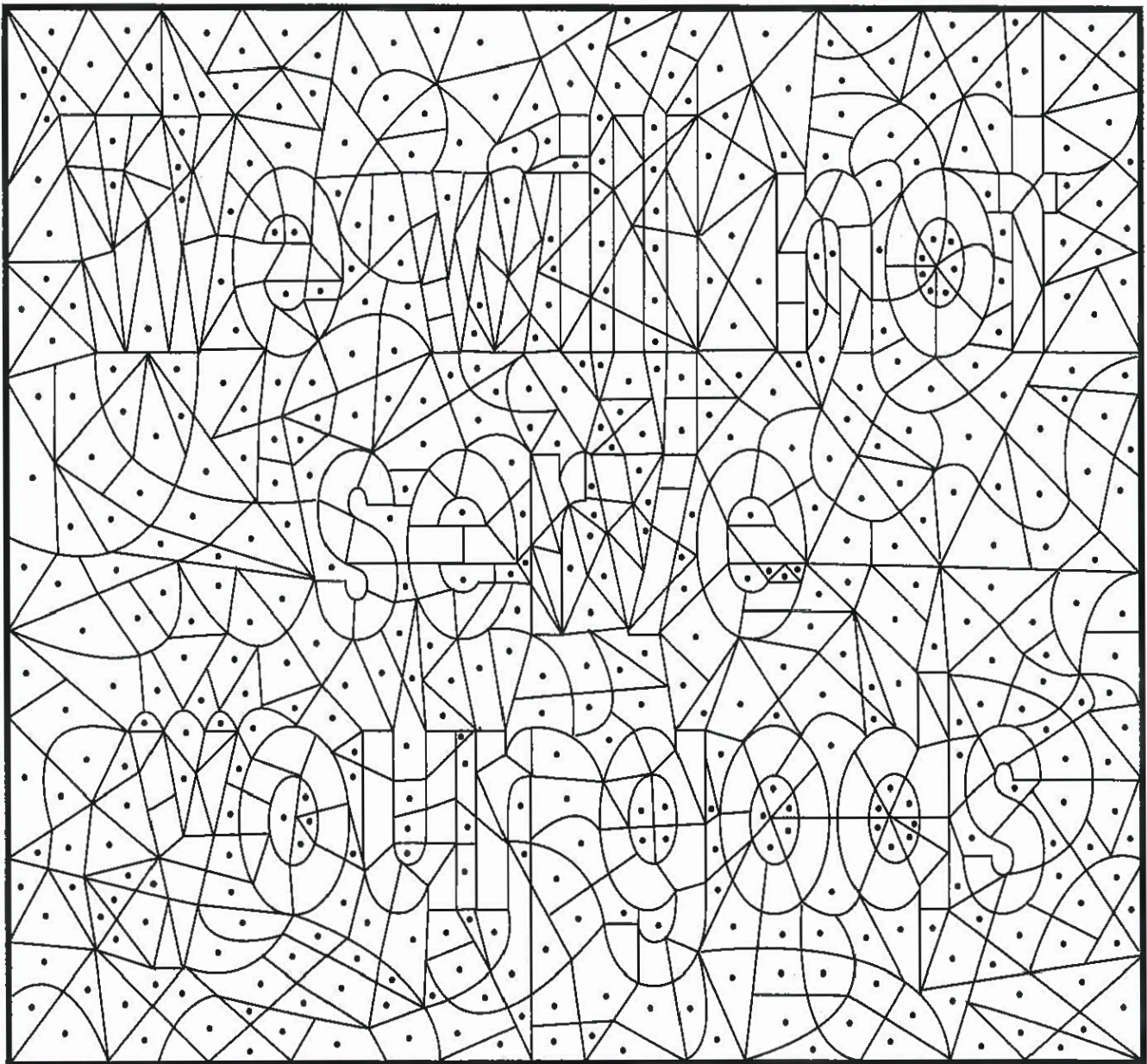



**Year 2**

**Week 104**

## **A Proud King is Humbled**

**Scriptures: Daniel 4**

**Key Verse: Dan 4:34-35** And at the end of the time I, Nebuchadnezzar, lifted my eyes to heaven, and my understanding returned to me; and I blessed the Most High and praised and honored Him who lives forever: For His dominion is an everlasting dominion, And His kingdom is from generation to generation. (35) All the inhabitants of the earth are reputed as nothing; He does according to His will in the army of heaven And among the inhabitants of the earth. No one can restrain His hand Or say to Him, "What have You done?"

### **Key Points:**

1. King Nebuchadnezzar writes a letter to the entire empire detailing his experiences and praising God.
2. Nebuchadnezzar is troubled by a dream; he calls in Daniel to interpret its meaning.
3. After relating the dream to Daniel in verses 10-17, Daniel offers the interpretation: Nebuchadnezzar, has built a great earthly kingdom, yet to learn Who truly rules the world, the mighty king will be humbled for a time.
4. As he took great pride in the mighty city of Babylon, Nebuchadnezzar heard a voice from heaven pronounce judgment: he would be driven from men and live as a beast for 7 years.
5. At the close of that time, Nebuchadnezzar lifted his eyes to heaven, recognizes God, and is restored to the throne.

**NEBUCHADNEZZAR IS HUMBLD****(DANIEL 4:28-37)**

B H E L B P N T V P W B J R I  
 L U O D Z H V B Q P Z K T P L  
 E Q O R F Z Q I Z E K E E N S  
 S S C E H I H T U R T C J O T  
 S S N O L Y B A B S K L Z S F  
 E I F U N V T A U G Q A Z A A  
 D L K W G V A M A D J W K E Y  
 J S B J L B Q D N E B S C R Y  
 Q R A Z Z E N D A H C U B E N  
 I J Y N G Q F T M P B S T I O  
 K F E D I R P Y G Z R S I Q O  
 T F N S R Y H L F C R A O D T  
 D E P A R T E D H C I R T J E  
 D O M Z Q E P I A Q A G A Q N  
 Y P H K I L J O W I H F N R F

**BABYLON****GRASS****PRIDE****BLESSED****HAIR****REASON****CLAWS****NEBUCHADNEZZAR****TRUTH****DEPARTED****OXEN**

# THE KING WHO ATE GRASS

## Daniel 4

Place an **X** beside each thing King Nebuchadnezzar saw in his dream.

- 1. A tall tree reaching into the sky
- 2. A garden of flowers
- 3. Birds and animals
- 4. An angel
- 5. A treasure
- 6. A river
- 7. A stump with a band of iron and brass
- 8. A palace

Now place an **X** beside each thing that happened to King Nebuchadnezzar.

- 1. He was driven away from men.
- 2. God gave him a wonderful reward.
- 3. He moved into a new palace.
- 4. He lived with the beasts in the field.
- 5. He lost his mind.
- 6. He ate grass.
- 7. His nails grew like bird claws.
- 8. He lost his kingdom for seven years.

# The King Learns a Lesson

Read Daniel 4:30-37. Read each sentence below. If the sentence is true, color the circle in the TRUE column. If the sentence is not true, color the circle in the FALSE column. Copy the colored letters first, then the uncolored ones onto the blanks below to find a message.

TRUE FALSE

1. God said Nebuchadnezzar would lose his royal authority (v. 31).

O L

2. The king was driven away from the people (v. 33).

N L

3. He had to eat birds and fish (v. 33).

P L

4. His nails grew like bird claws (v. 33).

Y O

5. At the end of the time, he looked up to heaven (v. 34).

G W

6. He refused to honor and glorify God (v. 34).

E O

7. His honor as king was restored (v. 36).

D R

8. His advisors took over his throne (v. 36).

F I

9. He became greater than before (v. 36).

S U

10. He said that God's ways were not just (v. 37).

L A



\_\_\_\_\_

\_\_\_\_\_

# YOU DRAW THE PICTURE

Draw a picture of King Nebuchadnezzar living in the field with the animals.

In your own words tell why this happened to King Nebuchadnezzar. \_\_\_\_\_

---



# NEBUCHADNEZZAR IS HUMBLLED

## (DANIEL 4:28-37)

### MEMORY VERSE:

*"Those who walk in pride He is able to abase."* DANIEL 4:37

*Nebuchadnezzar "was walking about the royal palace of Babylon..."*

### FILL IN THE BLANKS:

1. "The king spoke, saying, 'Is this not the great Babylon, that \_\_\_\_ have built for a royal dwelling by \_\_\_\_ mighty power and for the honor of \_\_\_\_ majesty?' " DANIEL 4:30

*"While the word was still in the king's mouth, a voice fell from heaven..."*

2. The voice said, "King Nebuchadnezzar, to you it is spoken: the kingdom has \_\_\_\_\_ from you!" DANIEL 4:31

*"That very hour the word was fulfilled concerning Nebuchadnezzar..."*

3. "He was driven from men and ate \_\_\_\_\_ like oxen." DANIEL 4:33

### TRUE OR FALSE:

4. "His body was wet with the dew of heaven till his hair had grown like eagles feathers." DANIEL 4:33

TRUE OR FALSE

5. His nails were like a bird's beak. DANIEL 4:33

TRUE OR FALSE

### FILL IN THE BLANKS:

6. The king declared, "At the end of the time I, Nebuchadnezzar, lifted my eyes to heaven, and my \_\_\_\_\_ returned to me." DANIEL 4:34

7. "I \_\_\_\_\_ the Most High and praised and honored Him who lives forever." DANIEL 4:34

### CIRCLE THE CORRECT WORDS:

8. "At the same time my (**MONEY, REASON**) was returned to me, and for the glory of my kingdom, my honor and splendor returned to me." DANIEL 4:36

9. He then declared, "Now I, Nebuchadnezzar, praise and extol and honor the King of heaven, all of whose works are (**TRUTH, THROUGH**), and His ways justice." DANIEL 4:37



## NEBUCHADNEZZAR IS HUMBLLED

(DANIEL 4:28-37)

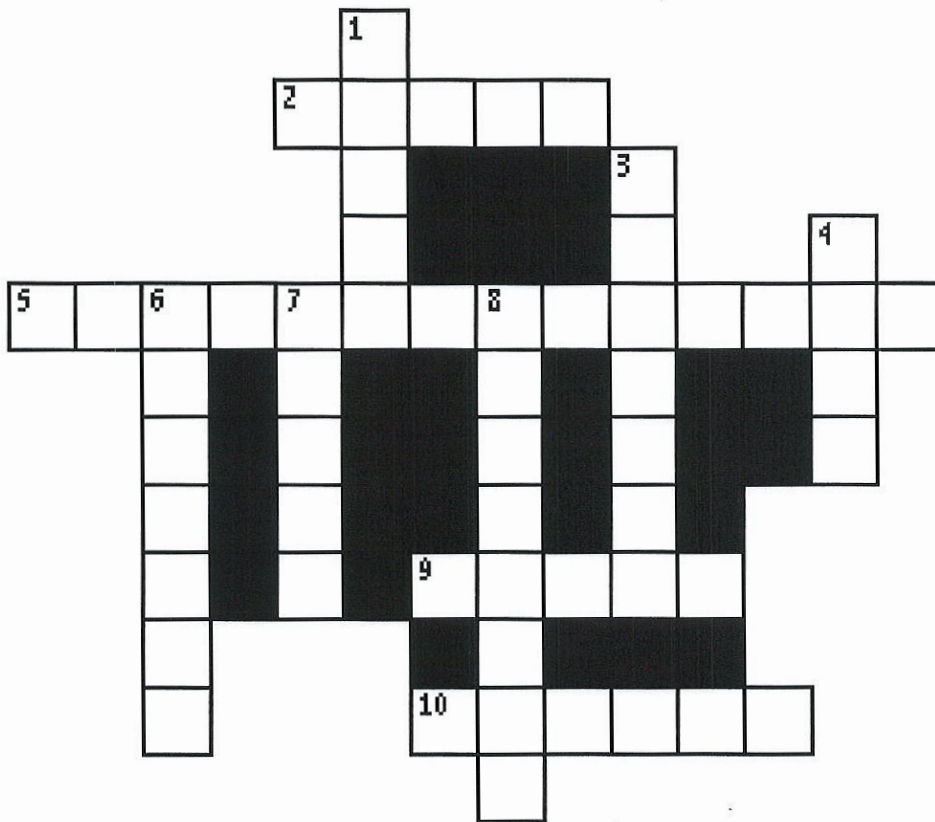

- 6 DOWN "The king spoke, saying, 'Is this not the great \_\_\_\_\_, that I have built for a royal dwelling by my mighty power and for the honor of my majesty?' " **DANIEL 4:30**
- 8 DOWN The voice said, "King Nebuchadnezzar, to you it is spoken: the kingdom has \_\_\_\_\_ from you!" **DANIEL 4:31**
- 2 ACROSS "He was driven from men and ate \_\_\_\_\_ like oxen." **DANIEL 4:33**
- 4 DOWN "His body was wet with the dew of heaven till his \_\_\_\_\_ had grown like eagles feathers." **DANIEL 4:33**
- 7 DOWN "His nails were like birds' \_\_\_\_\_." **DANIEL 4:33**
- 5 ACROSS The king declared, "At the end of the time I, \_\_\_\_\_, lifted my eyes to heaven, and my understanding returned to me." **DANIEL 4:34**
- 3 DOWN "I \_\_\_\_\_ the Most High and praised and honored Him who lives forever." **DANIEL 4:34**
- 10 ACROSS "At the same time my \_\_\_\_\_ was returned to me, and for the glory of my kingdom, my honor and splendor returned to me." **DANIEL 4:36**
- 1 DOWN He then declared, "Now I, Nebuchadnezzar, praise and extol and honor the King of heaven, all of whose works are \_\_\_\_\_, and His ways justice." **DANIEL 4:37**
- 9 ACROSS "Those who walk in \_\_\_\_\_ He is able to abase." **DANIEL 4:37**

158. NEBUCHADNEZZAR IS HUMBLLED  
(DANIEL 4:28-37)



"Now I Nebuchadnezzar praise and extol and honour the King of heaven, all whose works  
*are* truth, and his ways judgment: and those that walk in pride he is able to abase."

DANIEL 4:37

**Year 2**

**Week 105**

## **The Writing on the Wall**

**Scriptures: Daniel 5**

**Key Verse: Dan 5:22-23** "But you his son, Belshazzar, have not humbled your heart, although you knew all this. (23) And you have lifted yourself up against the Lord of heaven. They have brought the vessels of His house before you, and you and your lords, your wives and your concubines, have drunk wine from them. And you have praised the gods of silver and gold, bronze and iron, wood and stone, which do not see or hear or know; and the God who holds your breath in His hand and owns all your ways, you have not glorified.

### **Key Points:**

1. Belshazzar, king of Babylon, throws a great feast for his lords using the utensils and vessels from the temple of God in Jerusalem.
2. As they were feasting, a hand appeared and wrote out a message on the wall of the king's palace.
3. Greatly disturbed by this, the king offers any man in the kingdom a high rank if they can interpret the writing on the wall.
4. The queen suggests Daniel as an interpreter; Daniel is brought in and rebukes the king for his pride.
5. The writing tells the king that the Babylonian empire will come to an end and be succeeded by the Medes and Persians.
6. The king rewards Daniel as promised; that night the city is conquered by the Medo-Persian empire.

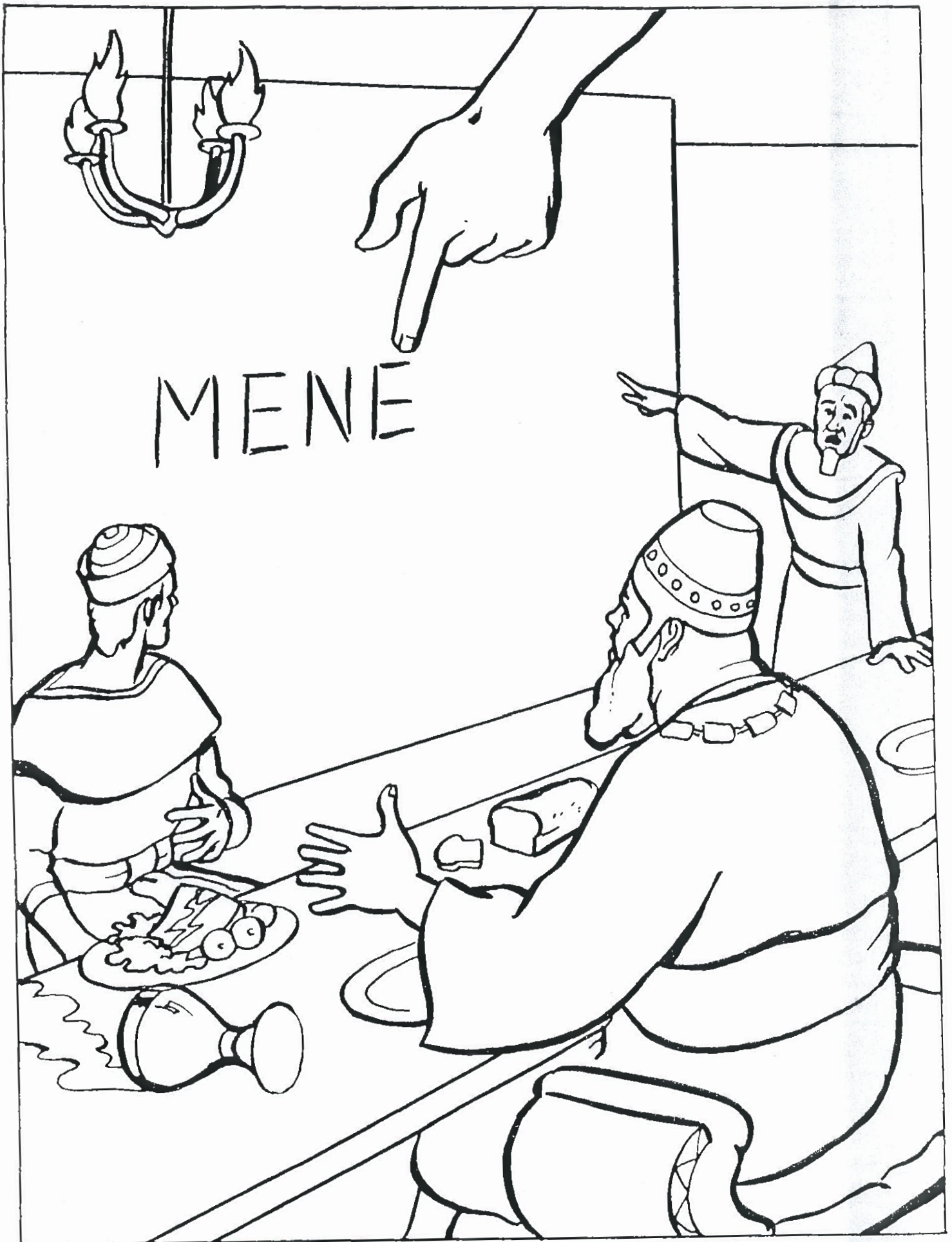

In the midst of the party, fingers of a man's hand write strange words on the wall. Daniel 5:5



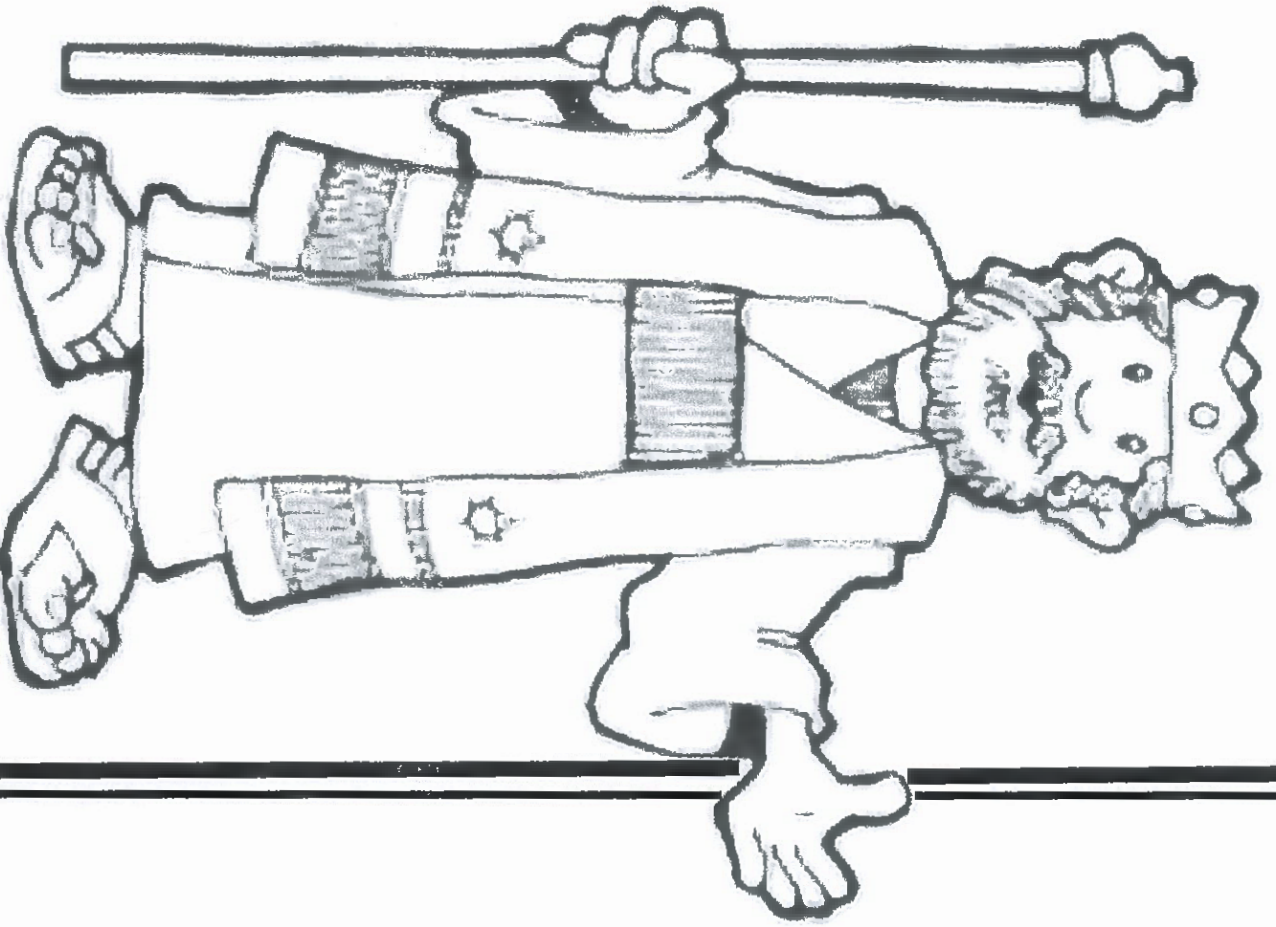

Daniel 5

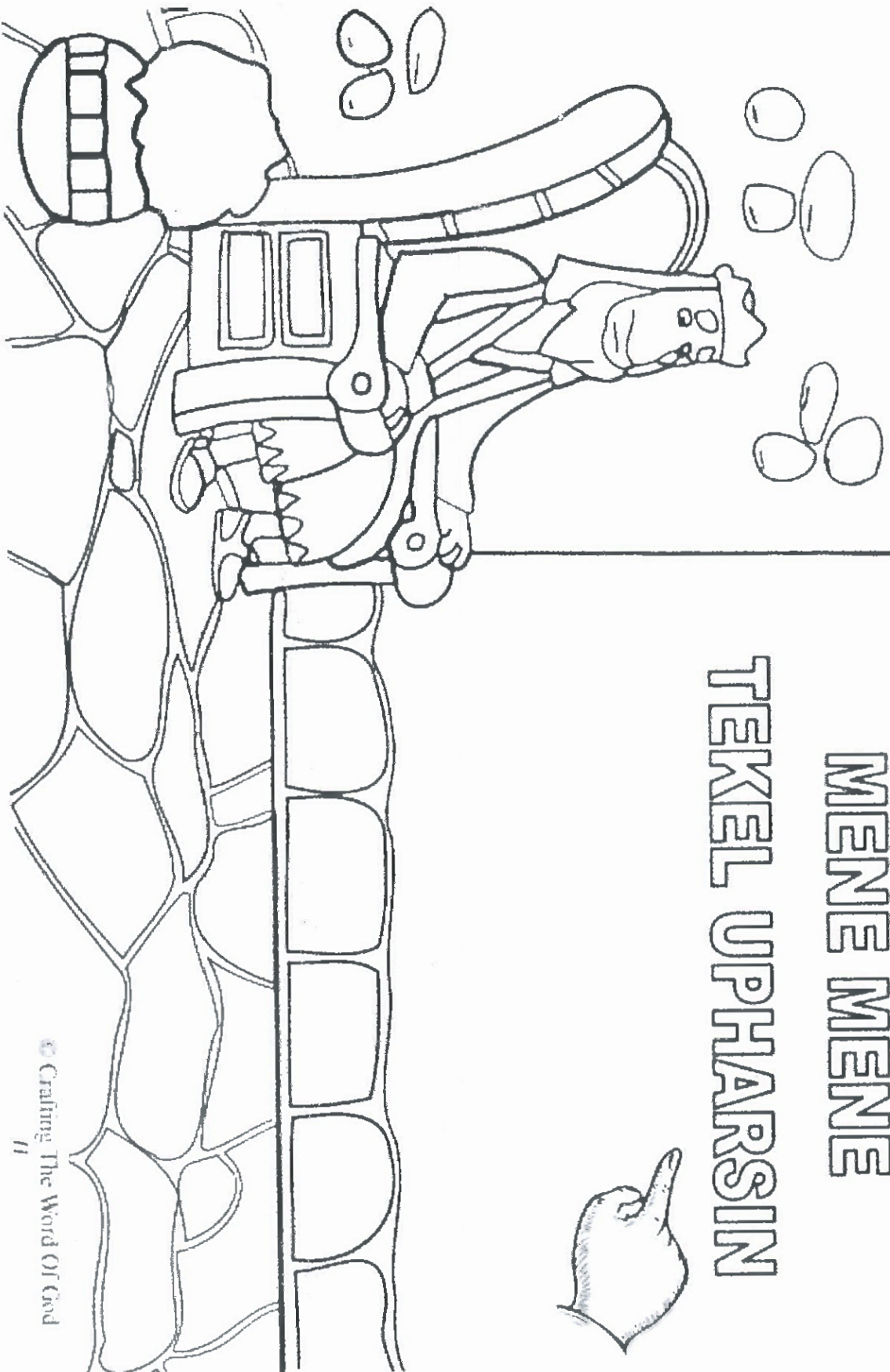

# MENE MENE TEKEL UPPHARSIN



159. THE WRITING ON THE WALL  
(DANIEL 5:1-31)

R U B H Q A Q F M N  
A N W R I T I N G E  
Z K I V D N E S S D  
Z U U S G A M K V C  
A P A E R Z N E E I  
H S R T C A S I R L  
S S K D M S H Y E U  
L J D A E E U P H L  
E D I L R H N Q U N  
B J S C H Q K E V J

BELSHAZZAR  
DANIEL  
FINGERS

MENE  
TEKEL  
UPHARSIN

VESSELS  
WRITING

**MENE, MENE,**

**TEKEL, UPHARSIN**

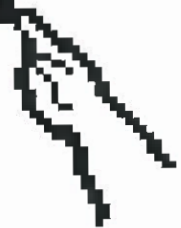

# 159. THE WRITING ON THE WALL

## (DANIEL 5:1-31)

### MEMORY VERSE:

"The Most High God rules in the kingdom of men, and appoints over it whomever He chooses."  
DANIEL 5:21

### CIRCLE THE CORRECT WORDS:

1. "Belshazzar the king made a great feast for a (COUPLE, THOUSAND) of his lords, and drank wine in the presence of the (TWO, THOUSAND)." DANIEL 5:1

### TRUE OR FALSE:

2. "While he tasted the wine, Belshazzar gave the command to bring the gold and silver vessels which his father Nebuchadnezzar had taken from the temple which had been in Jerusalem." DANIEL 5:2  
TRUE OR FALSE
3. "They drank wine, and praised the gods of gold and silver, bronze and iron, wood and stone." DANIEL 5:4  
TRUE OR FALSE

### CIRCLE THE CORRECT WORDS:

4. "In the same hour the (KNUCKLES, FINGERS) of a man's hand appeared and wrote opposite the lampstand on the plaster of the wall of the king's palace." DANIEL 5:5
5. "Then the king's countenance changed, and his thoughts troubled him, so that the joints of his hips were (LOOSENED, TIGHTENED) and his knees (LOCKED, KNOCKED) against each other." DANIEL 5:6

### FILL IN THE BLANK:

6. "Then Daniel was brought in before the king. And the king spoke, and said to Daniel, 'Are you that Daniel who is one of the \_\_\_\_\_ from Judah, whom my father the king brought from Judah?'" DANIEL 5:13

### TRUE OR FALSE:

7. The king said to Daniel, "If you can read the writing and make known to me its interpretation, you shall be clothed with purple and have a chain of gold around your neck, and shall be the third ruler in the kingdom." DANIEL 5:16  
TRUE OR FALSE
8. Daniel said to the king, "I will take your gifts and your rewards, but I will not read the writing to the king!" DANIEL 5:17

TRUE OR FALSE

### MATCHING:

9. "This is the inscription that was written: MENE, MENE, TEKEL, UPHARSIN." DANIEL 5:25  
DRAW A LINE TO THE CORRECT INTERPRETATION FOR EACH WORD-

(DANIEL 5:26) MENE

You have been weighed in the balances, and found wanting

(DANIEL 5:27) TEKEL

Your kingdom has been divided, and given to the Medes and Persians

(DANIEL 5:28) PERES

God has numbered your kingdom, and finished it





# Wall Writing

The wicked King Belshazzar had a banquet to which he invited a thousand lords, and he used the sacred gold and silver vessels that had been stolen from the temple in Jerusalem to serve the wine. King Belshazzar made a toast to the gods of gold and silver, bronze and iron, wood and stone as the people drank from these goblets. That same hour, the king saw the fingers of a man's hand appear and write mysterious words opposite the lampstand on the plaster wall of his palace. Decode the message below to see what was written on the wall.

## Message

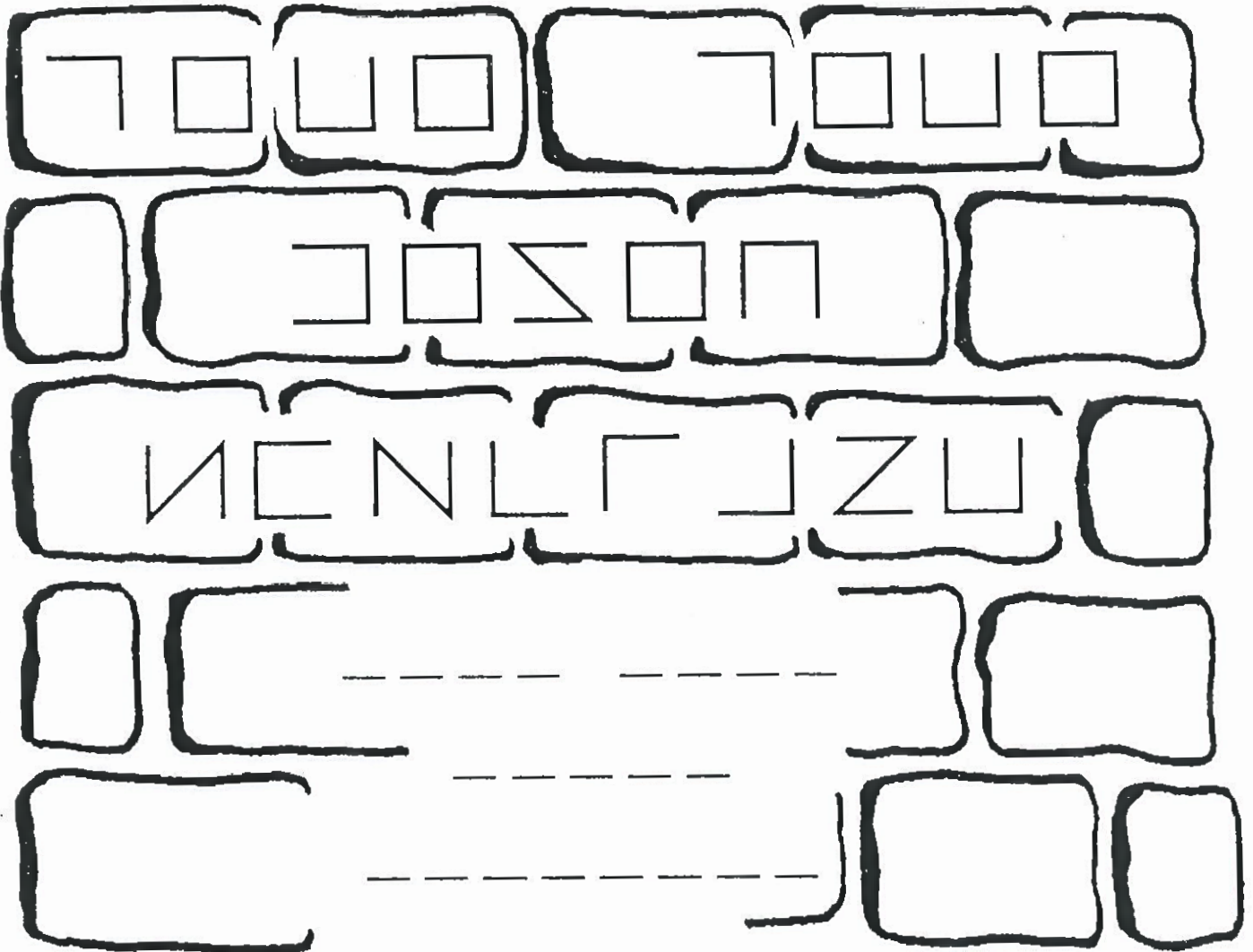

## Code

L   □   N   Z   Σ   Π   Γ   U   □   Γ   J   □   ∩  
A   E   H   I   K   L   M   N   P   R   S   T   U

# 39. The Hand That Wrote on the Wall

## Daniel 5

The American Manual Alphabet uses different finger positions to spell out words. Practice spelling the alphabet with your hand.

Use the manual alphabet to solve the puzzle.

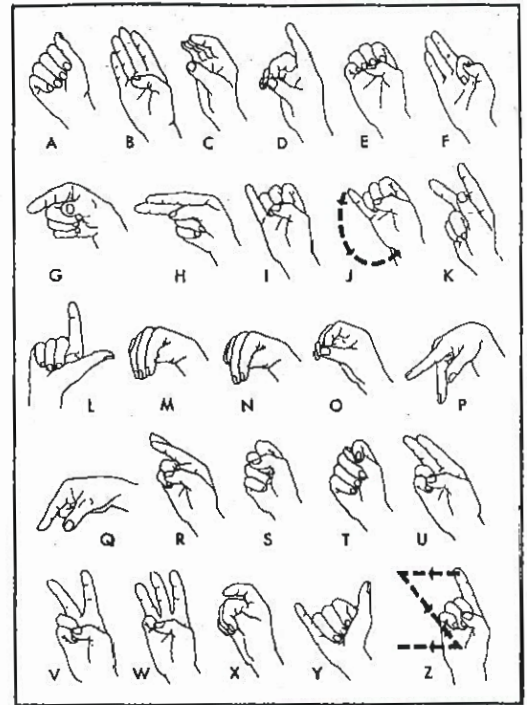

Daniel was called in to the king's banquet to interpret the writing on the wall. Daniel told the king about his sin and punishment.

What was King Belshazzar's sin?

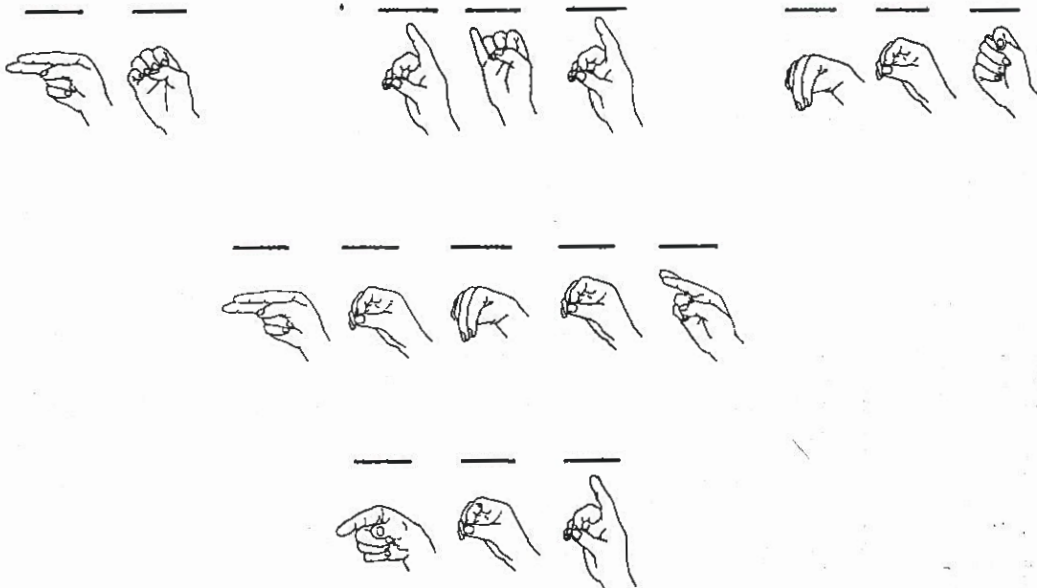



# THE WRITING ON THE WALL

## DANIEL 5:1-30

### Across

4. The king promised Daniel a gold \_\_\_\_\_. v. 16
6. Nebuchadnezzar had become arrogant and lost his \_\_\_\_\_. v. 20
7. Daniel did not want the king's \_\_\_\_\_. v. 17
8. Nebuchadnezzar was given the mind of an \_\_\_\_\_. v. 21
9. Belshazzar had praised the gods of \_\_\_\_\_ and gold. v. 23
11. The queen knew a man with great \_\_\_\_\_. v. 11
13. King Belshazzar gave a great \_\_\_\_\_. v. 1
14. Daniel told Belshazzar that he had not \_\_\_\_\_ himself. v. 22
16. Daniel reminded the king that \_\_\_\_\_ had blessed his father, Nebuchadnezzar. v. 18

### Down

1. That night, Belshazzar was \_\_\_\_\_. v. 30
2. Belshazzar did not \_\_\_\_\_ God. v. 23
3. Daniel was clothed in \_\_\_\_\_. v. 29
5. The queen told the king to call for \_\_\_\_\_. v. 12
10. A hand appeared and wrote a \_\_\_\_\_ on the wall. v. 5
11. The king told his wisemen to read the \_\_\_\_\_ on the wall. v. 7
12. The king used gold goblets taken from the \_\_\_\_\_ at Jerusalem. v. 3
15. No one could \_\_\_\_\_ the writing on the wall. v. 8

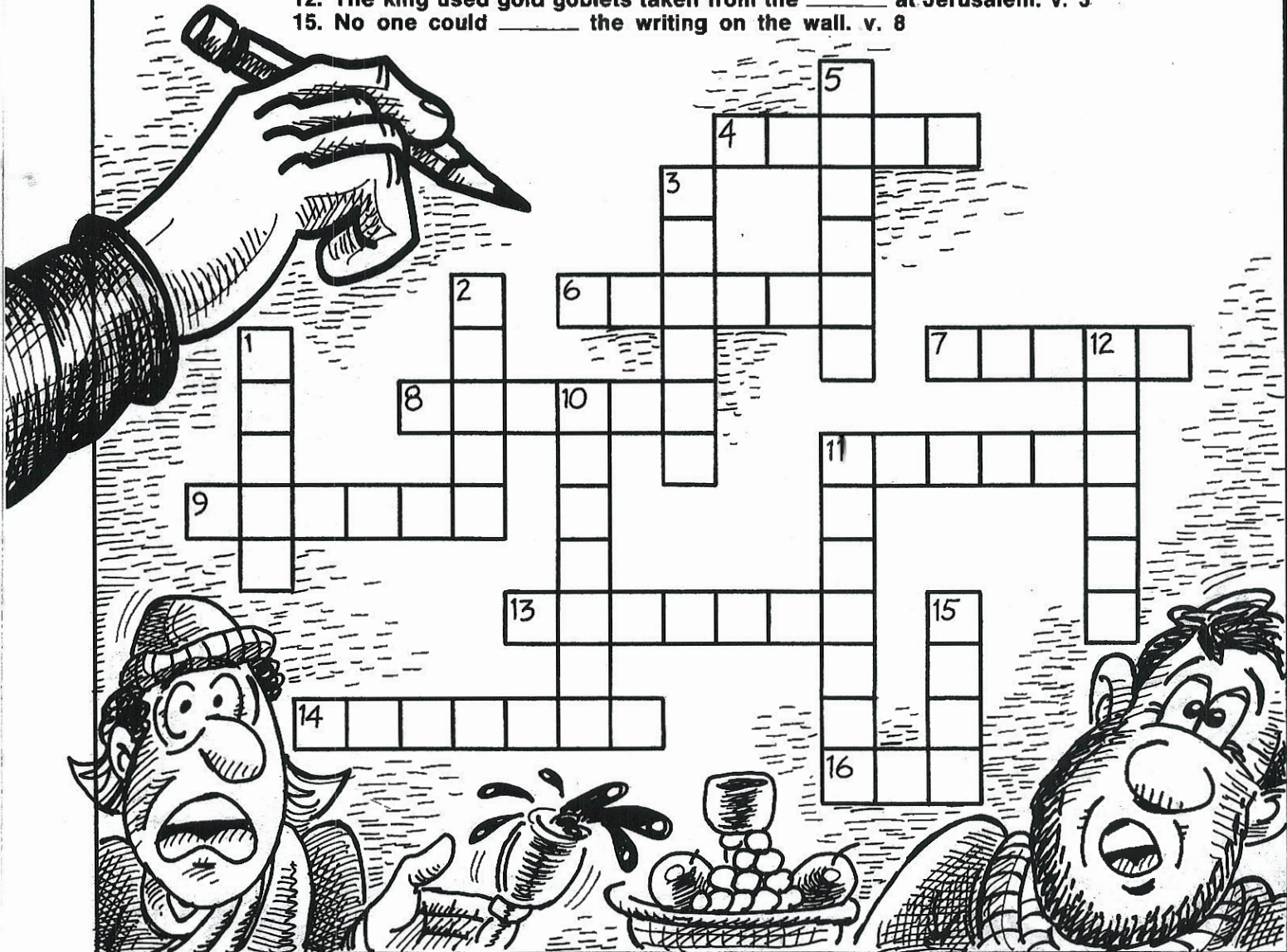

# WRITING ON THE WALL

Daniel 5

Figure out the secret code and learn the name of the king Daniel helped.

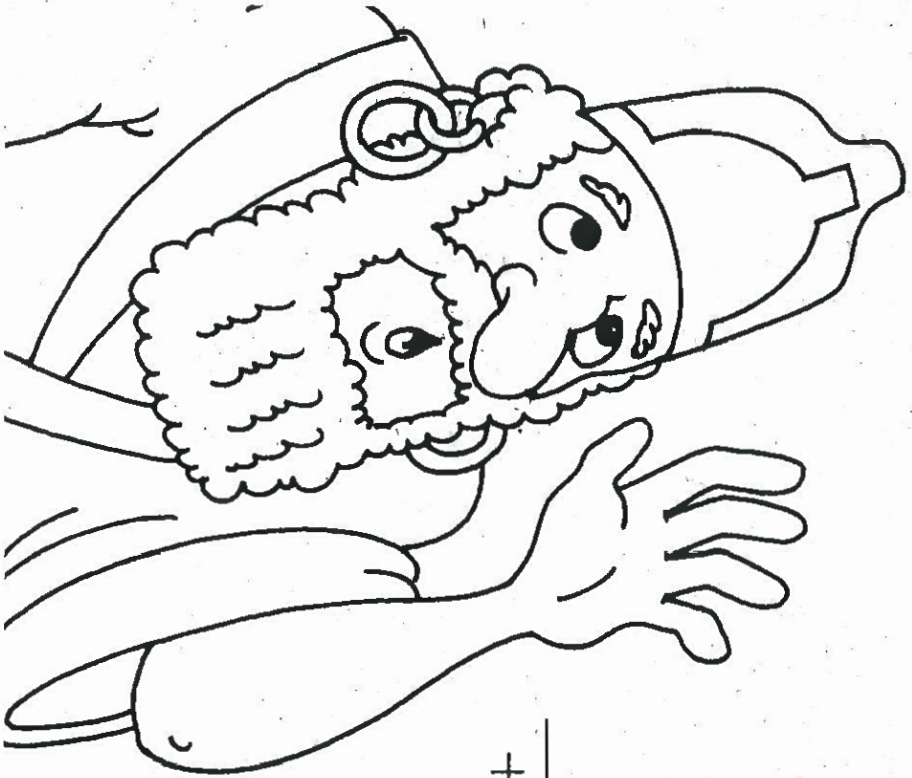

+    ◻    ▽    △    ◇    ▽    ▽    ◻    ◻    △    ×

Secret Code																									
a	b	c	d	e	f	g	h	i	j	k	l	m	n	o	p	q	r	s	t	u	v	w	x	y	z
△	+	B	○	◻	⊖	▭	◇	▽	*	▷	▷	☆	←	▽	×	D	∞	△	▩	▩	○	▩	□	⊗	▩

One night the Babylonian king was having a huge party. In the middle of the celebration a hand appeared and wrote a message on the wall of the room. God helped Daniel understand the message and he explained it to the king.



## Year 3

### Week 106

### Daniel and the Lion's Den

#### Scriptures: Daniel 6

**Key Verse: Daniel 6:16** “Now the king spoke and said to Daniel, “Your God, whom you serve continually, He will deliver you.”

#### Key Points:

1. Daniel is promoted to a high position in the land, and distinguished himself because of his excellent spirit, and the king considered setting Daniel above the whole kingdom.

2. Some governors and satraps sought for a way to entrap Daniel, but could find no fault with him, other than his diligent service to the Lord God.

3. They created a law for King Darius to sign that made it illegal for anyone to petition any other god or man for 30 days other than the king. The king signs the decree.

4. Daniel continues to pray three times a day in his home, and is caught by the governors and satraps. They tell the king of Daniel's disobedience to the law, and he is greatly saddened by the news, but orders that Daniel be punished by being thrown into the lions' den. King Darius tells Daniel that he knows God will protect him.

5. Daniel spends the whole night in the lions' den, and when the king comes to check on Daniel early the next morning, he finds Daniel alive and unharmed. Daniel tells him that the Lord shut the mouths of the lions because Daniel was innocent before Him and the king.

6. The king is very happy, and has Daniel taken out of the den. The men who entrapped Daniel are thrown into the lions' den, along with their families. They were broken into pieces before their bodies touched the ground. King Darius makes a decree that all men in the kingdom must bow down and worship the Lord God.



Daniel prays, even though it is against the law to do so. Daniel 6:4-10

Daniel Spends the Night With Lions  
Daniel 6



**Because Daniel loved God, he was thrown into the Lions' den. Help him escape.**

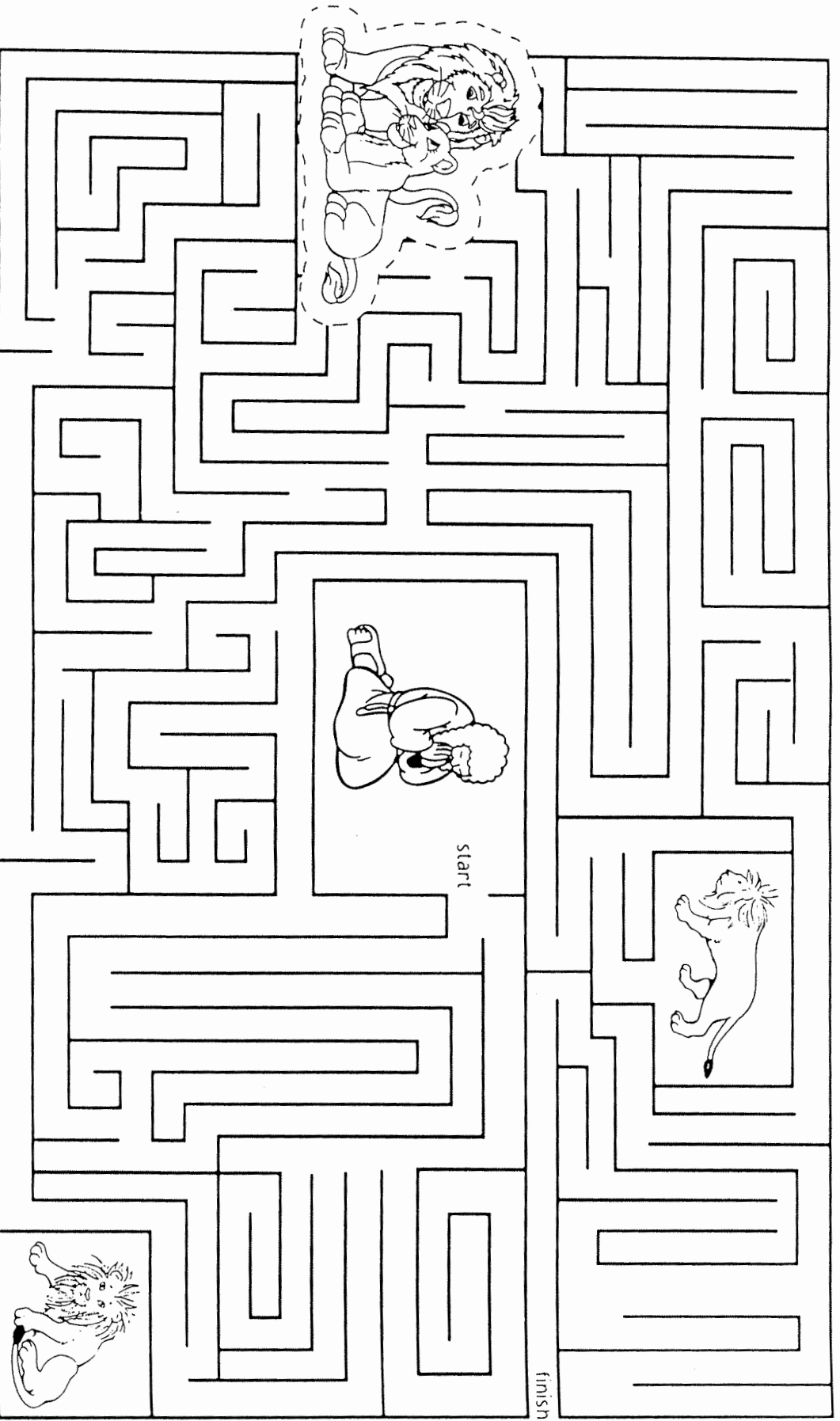

*“Daniel was taken out of the den, and no manner of hurt was found upon him, because he believed in his God.”—Daniel 6:23*



# DANIEL'S ADVENTURE

Twelve words are hidden in the box of letters below. Your job is to find them. The words are hidden backwards, across, down, or diagonally. They are always in a straight line. Do not skip any letters to make a word. You may use a letter more than once, but do not use a word more than once. Circle each word in the box of letters as you find it. Then cross it off on the word list.

bow  
den  
God  
king  
pray  
shut  
brave  
lions  
mouth  
Daniel  
hungry  
people

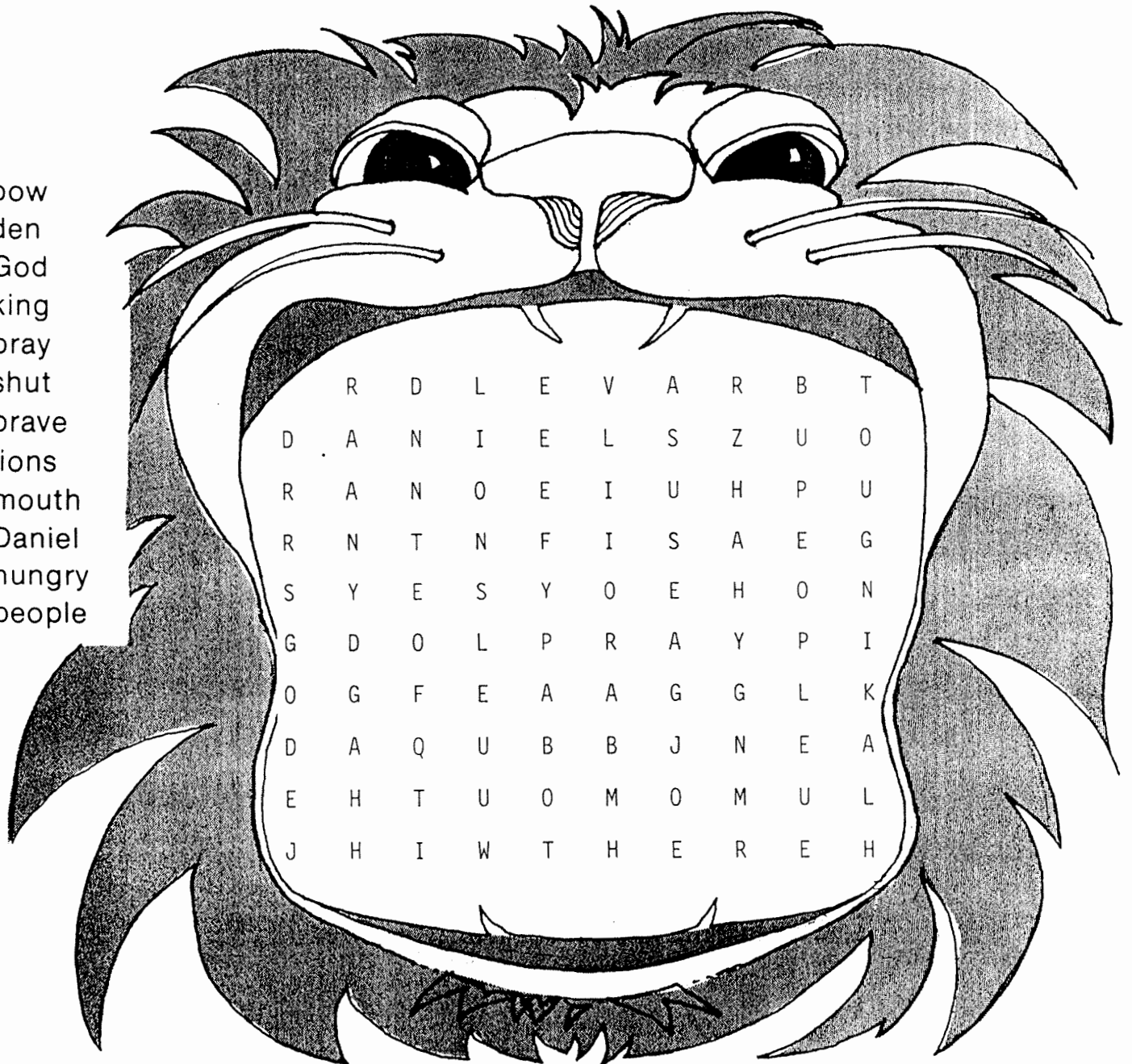

Daniel's adventure is found in your Bible. See Daniel 6.

# Daniel

Daniel 6:16-23

So the \_\_\_\_\_ gave the order, and they brought \_\_\_\_\_ and threw him into the lions' \_\_\_\_\_. The king said to Daniel, "May your God, whom you serve \_\_\_\_\_, 'rescue you!'"

A \_\_\_\_\_ was brought and placed over the \_\_\_\_\_ of the den, and the king \_\_\_\_\_ it with his own signet \_\_\_\_\_ and with the rings of his \_\_\_\_\_, so that Daniel's \_\_\_\_\_ might not be changed. Then the king returned to his \_\_\_\_\_ and spent the \_\_\_\_\_ without eating and without any \_\_\_\_\_ being brought to him. And he could not \_\_\_\_\_.

At the first \_\_\_\_\_ of dawn, the king got up and \_\_\_\_\_ to the lions' den. When he came \_\_\_\_\_ the den, he called to Daniel in an \_\_\_\_\_ voice, "Daniel, servant of the \_\_\_\_\_ God, has your God, whom you \_\_\_\_\_ continually, been able to rescue you from the \_\_\_\_\_?"

Daniel answered, "O king, live \_\_\_\_\_! My God sent his \_\_\_\_\_, and he shut the \_\_\_\_\_ of the lions. They have not \_\_\_\_\_ me, because I was found \_\_\_\_\_ in his sight. Nor have I ever done any \_\_\_\_\_ before you, O king."

The king was \_\_\_\_\_ and gave orders to lift Daniel out of the den. And when Daniel was \_\_\_\_\_ from the den, no \_\_\_\_\_ was found on him, because he had \_\_\_\_\_ in his God.

W U C R I N G R E V E R O F  
X G N O R W N O B L I G H T A  
H D R E N O T S L I G H T W  
U V A G F T D E T H G I N H U  
R T Q N D X I T P N E A R N  
I S N I E E W V U M K G G D  
E E O G T Z L T N A N J E S  
D P N F U G N I V I L L Y E I  
Y A I J C I A Q K M O L F T  
S L E E P T S R O J M E Y U  
N A M K R B U H R L O V D A  
O C L E G N A E E H T U R T I  
I E T L B A V Q E N D T H S B  
L N I N T H S D E N T H S B  
E M O U T H S D E N T H S B



# DANIEL IN THE LION'S DEN

## Daniel 6

### EXERCISE 1

Fill in the blanks with the correct words. Choose your answers from the words on the lions' faces.



1. THE KINGS GAVE DANIEL IMPORTANT JOBS TO DO. THEY \_\_\_\_\_ DANIEL.
2. KING DARIUS MADE DANIEL THE \_\_\_\_\_ PRESIDENT.
3. THE OTHER PRESIDENTS WERE \_\_\_\_\_ OF DANIEL.
4. THE PRESIDENTS COULD FIND NOTHING \_\_\_\_\_ IN DANIEL'S LIFE.
5. KING DARIUS WROTE A NEW \_\_\_\_\_.
6. DANIEL PRAYED EVERY DAY TO \_\_\_\_\_.
7. DANIEL WAS THROWN INTO A DEN OF \_\_\_\_\_.
8. KING DARIUS FELT \_\_\_\_\_ WHEN DANIEL WAS PUT INTO THE DEN.
9. GOD SENT AN \_\_\_\_\_ TO SAVE DANIEL.
10. KING DARIUS SAID, "DANIEL'S GOD IS THE \_\_\_\_\_ GOD."

# DANIEL 6

SIONL

--	--	--	--	--	--	--	--

TRUH

--	--	--	--	--	--	--	--

LENGA

--	--	--	--	--	--	--	--

REYPAR

--	--	--	--	--	--	--	--

CEALAP

--	--	--	--	--	--	--	--

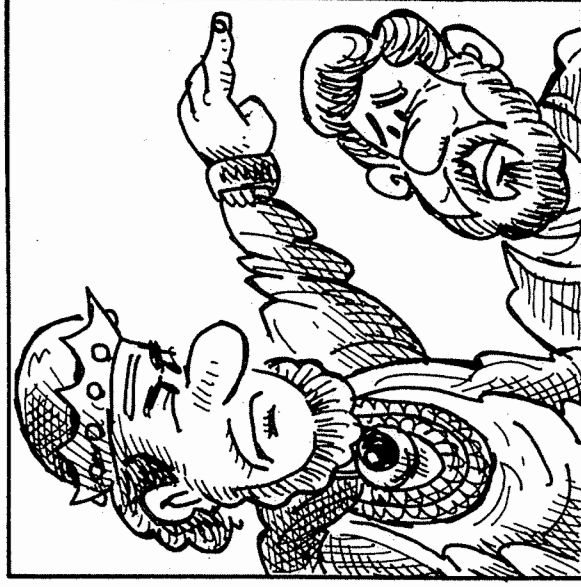

WHO SHARED A ROOM WITH DANIEL  
WHEN HE GOT IN TROUBLE WITH A KING?

SOME

--	--	--	--	--	--	--	--

--	--	--	--	--	--	--	--

# PICTURE

# C

# R

# WORD

# S

# S

Write the words listed at the bottom of the page in the correct spaces in the crossword puzzle.

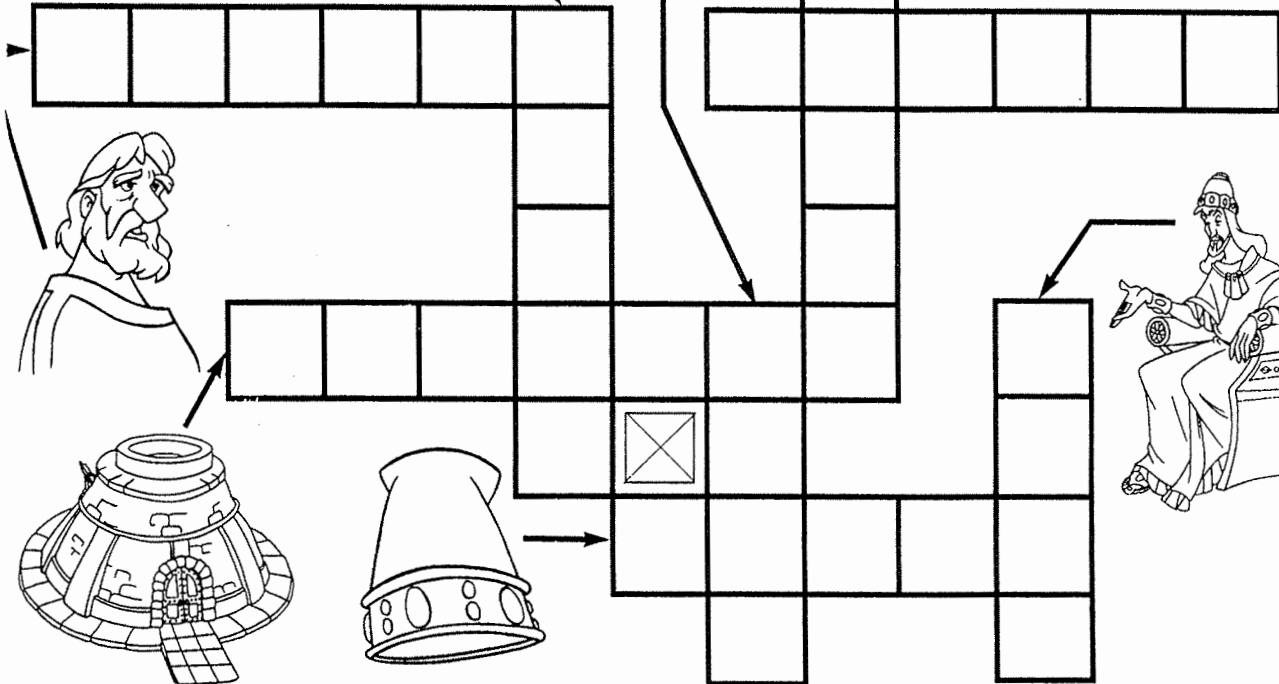
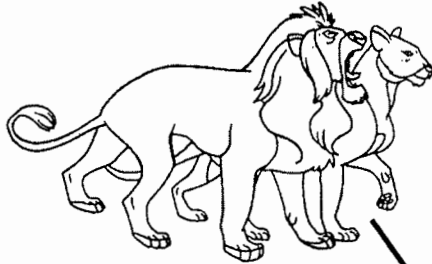
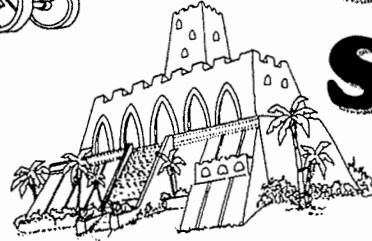
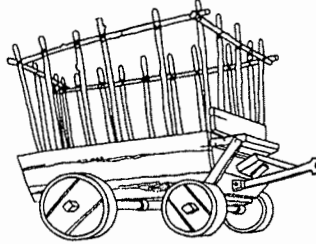

STATUE PALACE LIONS CROWN FURNACE KING DANIEL CART

# FAITH & COURAGE



2 NAME THE MAN WHO FOUGHT OFF 1,000 PHILISTINES ARMED WITH ONLY A BONE.

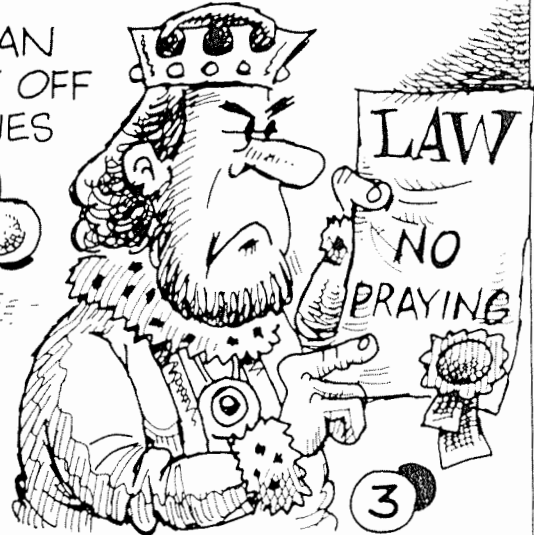
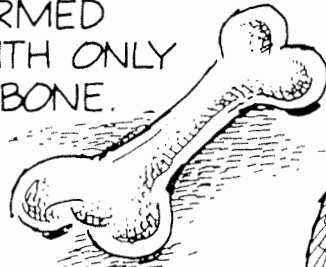

3 WHICH APOSTLE CONTINUED TO PREACH THE GOSPEL EVEN THOUGH HE WAS LASHED 5 TIMES, BEATEN 3 TIMES, STONED ONCE AND SHIPWRECKED 3 TIMES?



5 NAME THE YOUNG MAN WHO FELLED A GIANT WITH A SLING.

3 NAME THE OLD TESTAMENT MAN WHO WAS PUNISHED BY HIS KING, DARIUS, FOR PRAYING TO GOD 3 TIMES A DAY.

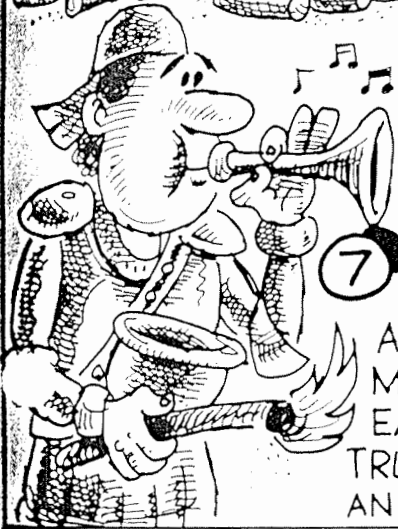

7 NAME THE ISRAELITE WHO LED 300 MEN AGAINST THE MIDIANITES AND ARMED EACH MAN WITH A TRUMPET, TORCH AND AN EMPTY JAR.



6 WHO PREACHED THE GOSPEL OPENLY AND BOLDLY ON PENTECOST, EVEN THOUGH HE HAD DENIED KNOWING JESUS LESS THAN 2 MONTHS BEFORE?



8 NAME THE MAN WHO SAID THAT FAITH IN GOD CAN MOVE MOUNTAINS.



## Daniel in the Lions' Den

—Daniel 6

# Daniel and the Lions

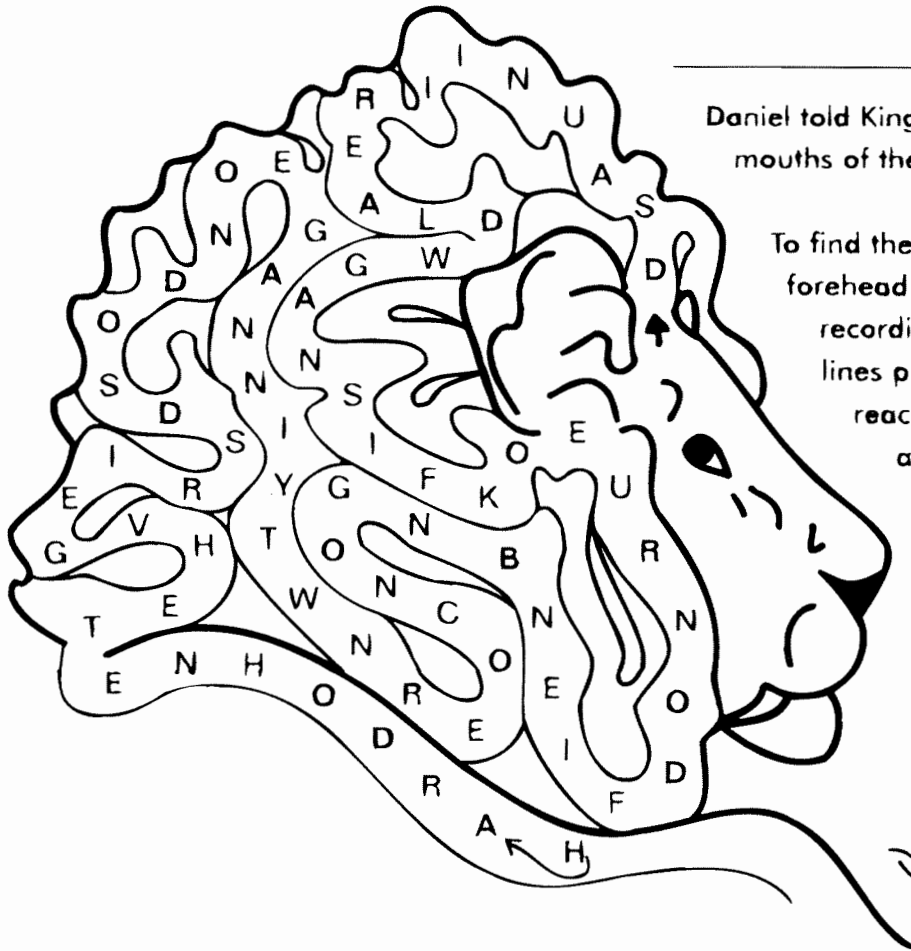

Daniel told King Darius that God had shut the mouths of the lions. Why did he say that?

To find the answer, start on the lion's forehead and travel through the maze, recording every other letter on the lines provided. When you have reached the last letter, follow the arrow to the next letter to be recorded. Record every other letter as you work your way back through the maze.



-----

-----

-----

-----

-----



# WHAT HAPPENED FIRST ?



Number each picture below in the order it appeared in the video, then write the numbers in the blanks under the pictures.



\_\_\_\_\_

A. Daniel interprets the king's dream.



\_\_\_\_\_

B. God protects Daniel in the lions' den.

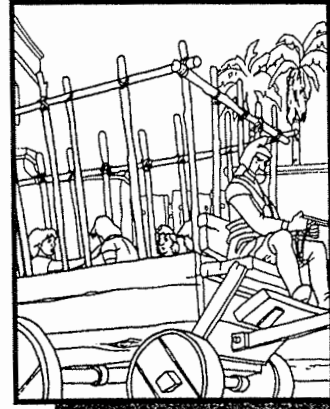

\_\_\_\_\_

C. Daniel and his friends are taken to the king's palace.



\_\_\_\_\_

D. Daniel interprets the writing on the wall.



\_\_\_\_\_

E. Daniel's friends are thrown into the fiery furnace.



\_\_\_\_\_

F. King Darius asks for Daniel's forgiveness.



**Year 3**

**Week 107**

## **God Brings His People Back and Rebuilding of the Temple Begins**

**Scriptures: Ezra 1-4**

**Key Verse: Ezra 4:1...** “Then all the people shouted with a great shout, they praised the Lord because the foundation of the house of the Lord was laid.”

### **Key Points:**

**1.** When King Cyrus of Persia became king, the Lord stirred his spirit to allow the Jews to return to Jerusalem after their captivity in Babylon. The king made a proclamation that all Jews could voluntarily return to Jerusalem and restore the temple.

**2.** All the heads of the houses of Benjamin and Judah prepared to return. King Cyrus brought out the precious articles of the temple that Nebuchadnezzar had taken from Jerusalem and put in the temple of his gods. Their neighbors also helped them with gifts of gold and silver. Zerubbabel, (Sheshbazzar is the Chaldean name) the Prince of Judah, was to watch over these as they traveled back to Jerusalem.

**3.** When the children of Israel were in the cities they all gathered together in Jerusalem. Jeshua, Zerubbabel and the priests built an altar and restored daily sacrifices. Free-will offerings were given for the work to restore the temple. The work began, overseen by the Levites and priests. A great shout with trumpets and cymbals came out from the people as the temple foundations were laid.

**4.** Enemies of Benjamin and Judah heard of the rebuilding and restoration of worship and offered their help, however this was just an evil plan. Zerubbabel and the rest of the men refused their help. These enemies continued to frustrate the children of Israel during their building.

**5.** As Artaxerxes began to reign, their enemies wrote to the king false accusations about the children of Israel, saying Jerusalem is an evil city and they will be rebellious and not pay their taxes. The king had found that in latter times Jerusalem had been somewhat controversial and ordered that the building of the temple be stopped.

# Return to Zion

King Cyrus was a friend to the captive Jews. Cyrus gave honor to God and commanded that the temple be rebuilt in Jerusalem.

The Jews were filled with joy when they heard this news. They had been away from Jerusalem for seventy years and were glad to go back.

Cyrus gave back all the valuables that had been removed from the temple. The Jews took these objects and returned to Jerusalem, which is also called Zion.

Again they sang a song, but this time it was a song of joy.

## Psalm 126

When the LORD brought back the captives to Zion,  
we were like men who dreamed.

Our mouths were filled with laughter,  
our tongues with songs of joy.

Then it was said among the nations,

"The LORD has done great things for them."

The LORD has done great things for us,  
and we are filled with joy.

Restore our fortunes, O LORD,  
like streams in the Negev.

Those who sow in tears  
will reap with songs of joy.

He who goes out weeping,  
carrying seed to sow,

will return with songs of joy,  
carrying sheaves with him. (NIV)

Find the underlined words in the word search.

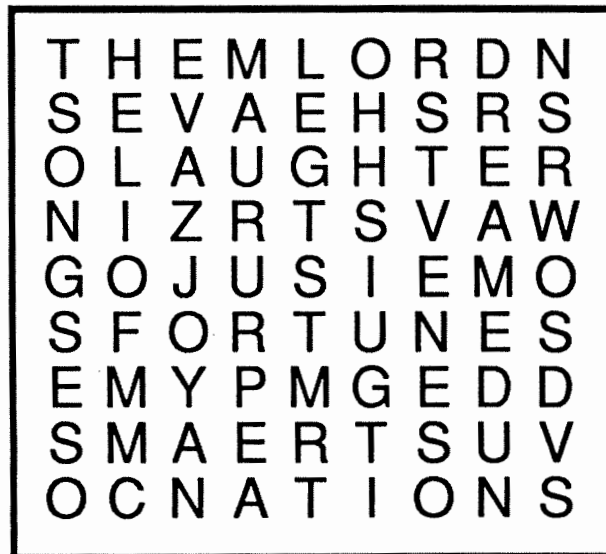

# THE ISRAELITES GO HOME

Book of Ezra

Help the Israelites find the way to their own land.

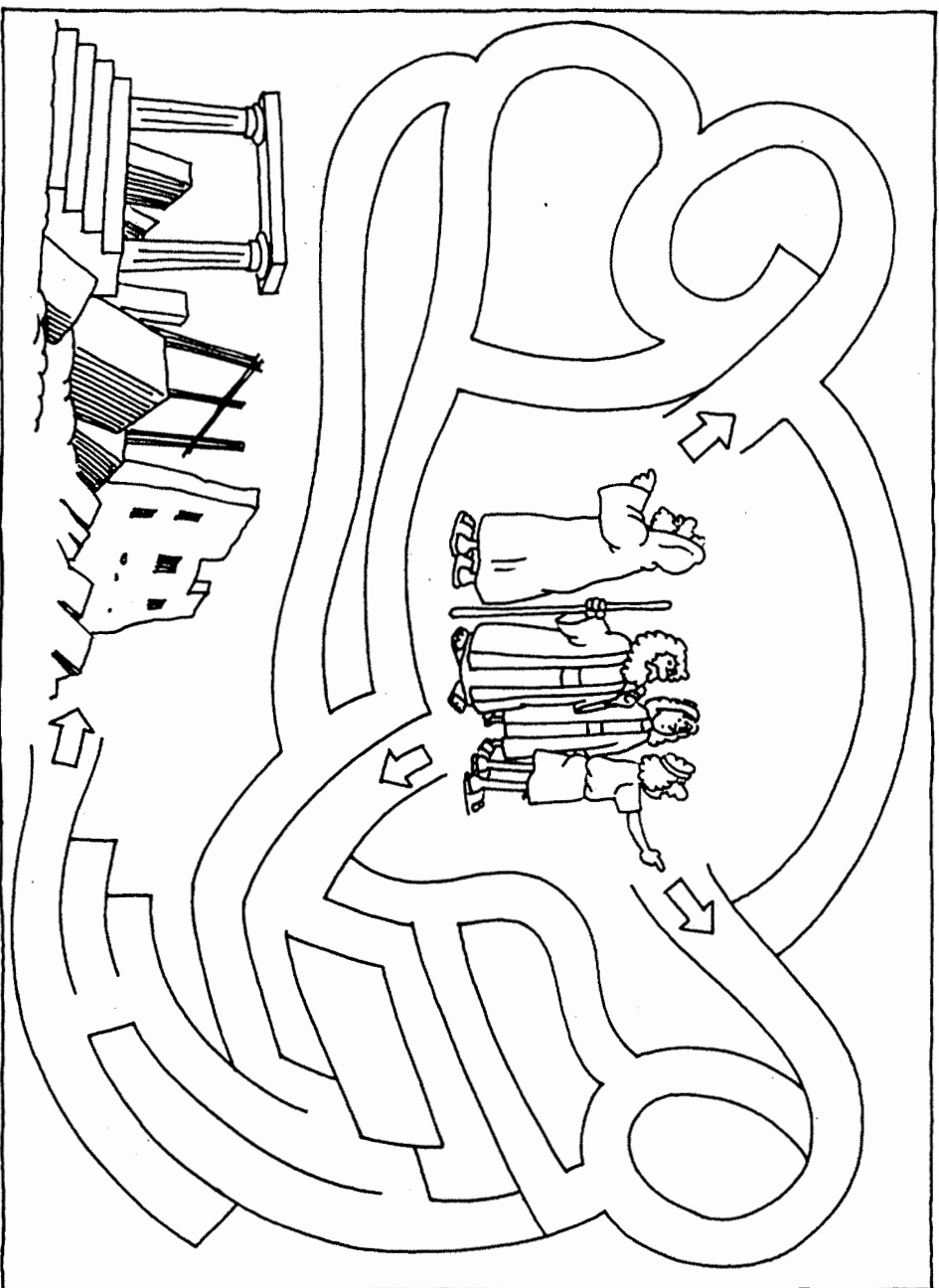

The Persians took over the land of Babylon. The Persian king, Cyrus said the Israelites could go home. So Ezra led the first group of Israelites back to Israel.

The first thing they did was to rebuild the temple.

**Return From  
Exile  
Jeremiah 29**

# I Have Plans for You

God spoke to Jeremiah about the future of Israel in Jeremiah 29:11. Follow the instructions to discover what God told him.

Use the code to interpret the message. The first letter of the code represents the vertical column and the second letter the horizontal column. For example, "DF" would be the letter "W."

	A	D	F	G	V	X
A	F	L	I	A	O	2
D	J	D	W	3	G	U
F	C	I	Y	B	4	P
G	R	5	Q	8	V	E
V	6	K	7	Z	M	X
X	S	N	H	0	T	9

" AA AV GA FD VD XD AV DF XV XF GX FX AD AG XD XA  
 FD XF AG GV GX AA AV GA FF AV DX' DD GX FA AD AG GA GX XA  
 XV XF GX AD AV GA DD' " FX AD AG XD XA XV AV FX GA AV XA FX GX GA  
 FF AV DX AG XD DD XD AV XV XV AV XF AG GA VV FF AV DX'  
 FX AD AG XD XA XV AV DV FD GV GX FF AV DX XF AV FX GX  
 AG XD DD AG AA DX XV DX GA GX"

**MEMORANDUM: IN THE FIRST YEAR OF KING CYRUS, THE KING  
ISSUED A DECREE CONCERNING THE TEMPLE OF GOD IN  
JERUSALEM**

*Let the temple be rebuilt as a place to present sacrifices, and let its foundations be laid. It is to be ninety feet high and ninety feet wide, with three courses of large stones and one of timbers. The costs are to be paid by the royal treasury. Also, the gold and silver articles of the house of God, which Nebuchadnezzar took from the temple in Jerusalem and brought to Babylon, are to be returned to their places in the temple in Jerusalem; they are to be deposited in the house of God.*

*Made scrolls on parchment paper —*

# CYRUS HELPS THE EXILES

## (EZRA 1:1-11)

### MEMORY VERSE:

"I was glad when they said to me, 'Let us go into the house of the LORD.' " PSALM 122:1

### TRUE OR FALSE:

1. "Now in the first year of Cyrus king of Persia, that the word of the LORD spoken by the mouth of Jeremiah might be fulfilled, the LORD stirred up the spirit of Cyrus king of Persia, so that he made a proclamation throughout all his kingdom, and also put it in writing." EZRA 1:1

TRUE OR FALSE

### FILL IN THE BLANK:

2. "Thus says Cyrus king of Persia: All the kingdoms of the earth the LORD God of heaven has given me. And He has commanded me to build Him a \_\_\_\_\_ at Jerusalem which is in Judah." EZRA 1:2

### TRUE OR FALSE:

3. But the heads of the fathers' houses of Judah and Benjamin, and the priests and the Levites, and all those whose spirits God moved, would not arise to go up and build the house of the LORD which is in Jerusalem. EZRA 1:5

TRUE OR FALSE

4. "And all those who were around them encouraged them with articles of silver and gold, with goods and livestock, and with precious things, besides all that was willingly offered." EZRA 1:6

TRUE OR FALSE

### FILL IN THE BLANKS:

5. "King Cyrus also brought out the articles of the house of the LORD, which \_\_\_\_\_ had taken from Jerusalem and put in the temple of his gods." EZRA 1:7

6. "And Cyrus king of Persia brought them out by the hand of Mithredath the treasurer, and counted them out to Sheshbazzar the prince of \_\_\_\_\_." EZRA 1:8

### CIRCLE THE CORRECT WORDS:

7. "This is the number of them..." EZRA 1:9-10  
thirty gold (PLATTERS, HATTERS)  
one thousand silver (PLATTERS, HATTERS)  
twenty-nine (LIVES, KNIVES)  
thirty gold (RAISINS, BASINS)  
four hundred and ten silver (RAISINS, BASINS) of a similar kind  
and one thousand other (ARTICLES, PARTICLES)

### FILL IN THE BLANKS:

8. "All the articles of \_\_\_\_\_ and \_\_\_\_\_ were five thousand four hundred." EZRA 1:11

### TRUE OR FALSE:

9. "All these Sheshbazzar took with the captives who were brought from Babylon to Jerusalem." EZRA 1:11

TRUE OR FALSE

# REBUILDING THE ALTAR AND THE TEMPLE

(EZRA 3:1-13)



“And when the builders laid the foundation of the temple of the LORD, they set the priests in their apparel with trumpets, and the Levites the sons of Asaph with cymbals, to praise the LORD, after the ordinance of David king of Israel.”

**EZRA 3:10**

# THE OPPOSITION OF REBUILDING

## (EZRA 4:1-24)

### MEMORY VERSE:

*"Now when the copy of King Artaxerxes' letter was read before Rehum, Shimshai the scribe, and their companions, they went up in haste to Jerusalem against the Jews, and by force of arms made them cease." EZRA 4:23*

### FILL IN THE BLANKS:

1. "Now when the \_\_\_\_\_ of Judah and Benjamin heard that the descendants of the captivity were building the temple of the LORD God of Israel, they came to Zerubbabel and the heads of the fathers' houses, and said to them, 'Let us build with you, for we seek your God as you do; and we have sacrificed to Him since the days of Esarhaddon king of Assyria, who brought us here.' " **EZRA 4:1-2**
2. "But Zerubbabel and Jeshua and the rest of the heads of the fathers' houses of Israel said to them, 'You may do \_\_\_\_\_ with us to build a house for our God; but we alone will build to the LORD God of Israel, as King Cyrus the king of Persia has commanded us.' " **EZRA 4:3**

### TRUE OR FALSE:

3. "Then the people of the land tried to discourage the people of Judah." **EZRA 4:4**  
TRUE OR FALSE
4. They helped them in the building. **EZRA 4:4**  
TRUE OR FALSE

### FILL IN THE BLANK:

5. They "hired counselors against them to \_\_\_\_\_ their purpose all the days of Cyrus king of Persia, even until the reign of Darius king of Persia." **EZRA 4:5**

### TRUE OR FALSE:

6. "Now in the reign of Ahasuerus, in the beginning of his reign, they wrote an accusation against the inhabitants of Judah and Jerusalem." **EZRA 4:6**  
TRUE OR FALSE

### FILL IN THE BLANK:

7. "Now when the copy of King Artaxerxes' letter was read before Rehum, Shimshai the scribe, and their companions, they went up in haste to Jerusalem against the Jews, and by force of arms made them \_\_\_\_\_." **EZRA 4:23**

### TRUE OR FALSE:

8. Thus the work of the house of God which is at Jerusalem continued without any problems. **EZRA 4:24**  
TRUE OR FALSE



# REBUILDING THE ALTAR AND THE TEMPLE

(EZRA 3;1-13)

C Y P R A I S E O F  
E D T H A N K S O A  
D E E O S J U U Q L  
A T H W R D N A Y T  
R U L H V D U C L A  
L O B J A H R O A R  
O H R T S E R C E A  
G S I E M D V G G T  
S O J E L P M E T N  
N J E R U S A L E M

ALTAR	JESHUA	SHOUTED
CEDAR LOGS	LORD	TEMPLE
FOUNDATION	MERCY	THANKS
JERUSALEM	PRAISE	

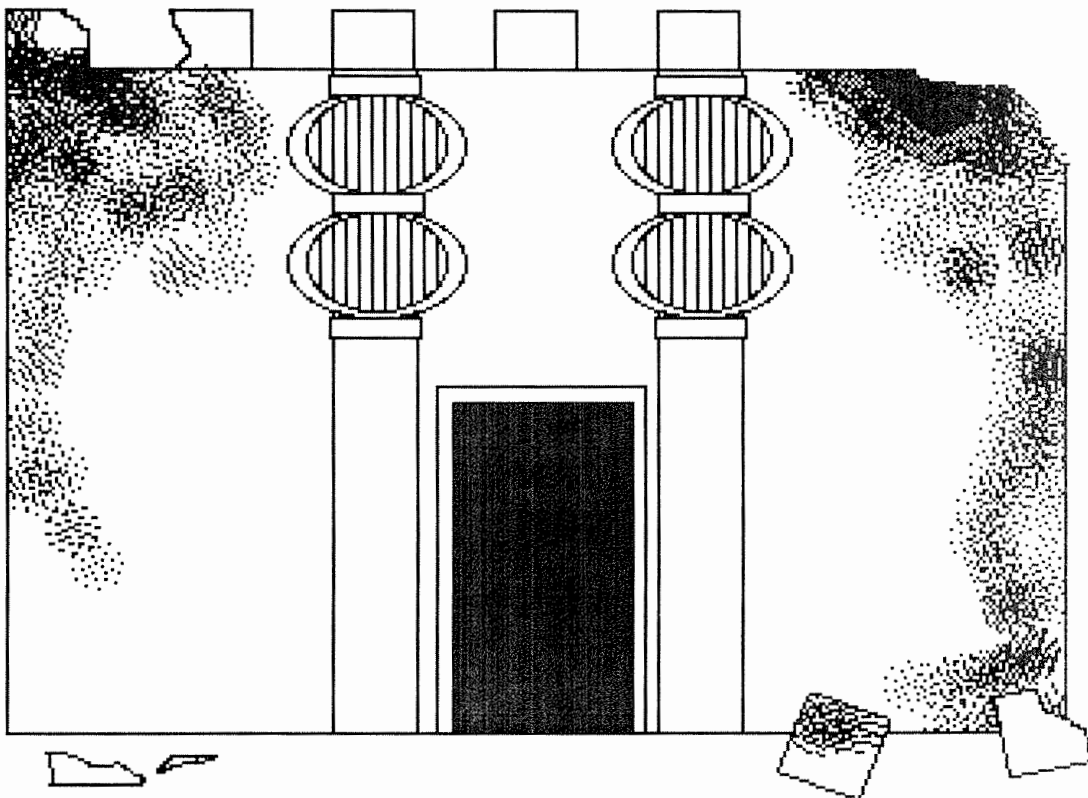

# CYRUS HELPS THE EXILES

## (EZRA 1:1-11)

L Z W N P M J Z J J V E J J B P D O O I  
 I M E L A S U R E J A C S I K P V B A K  
 V R U G G L K Y H H R N B P K A S U T N  
 E P F Z K B K N Q Q L Q E T A N M L M P  
 S J I J B M P J O O W L S E L C I T R A  
 T H R A Z Z A B H S E H S V G O L D Z P  
 O G D P U A Z T A E J K S S I L V E R U  
 C E G N K C Y P W W U D C E T V C P J Z  
 K U Y U C W Y L V E O D A A V Q Z M S V  
 W W P O U J O J M B E O V R P I L C M F  
 S D Y F M U J C B N P B D F W T N C M R  
 V D R O L E H T F O E S U O H S I K P K  
 O W B L D R F V S S T Q Q E L U U V C K  
 J Y D L L O A T W U W W E J A R T V E Y  
 J P R N O L Y B A B S L N O B Y M Z D S  
 E Z C M S I H W U H C W R U A C O B T R  
 P R O C L A M A T I O N Y G S G E F N G  
 A W G S V T A H D P H K Y F I N M K R I  
 W B R Z R E H P S E U I D B N I N S G K  
 L M G F C S R E T T A L P D S K N M E U

- |          |                   |              |
|----------|-------------------|--------------|
| ARTICLES | HOUSE OF THE LORD | PLATTERS     |
| BABYLON  | JERUSALEM         | PROCLAMATION |
| BASINS   | KING CYRUS        | SHESHBAZZAR  |
| CAPTIVES | KNIVES            | SILVER       |
| GOLD     | LIVESTOCK         |              |

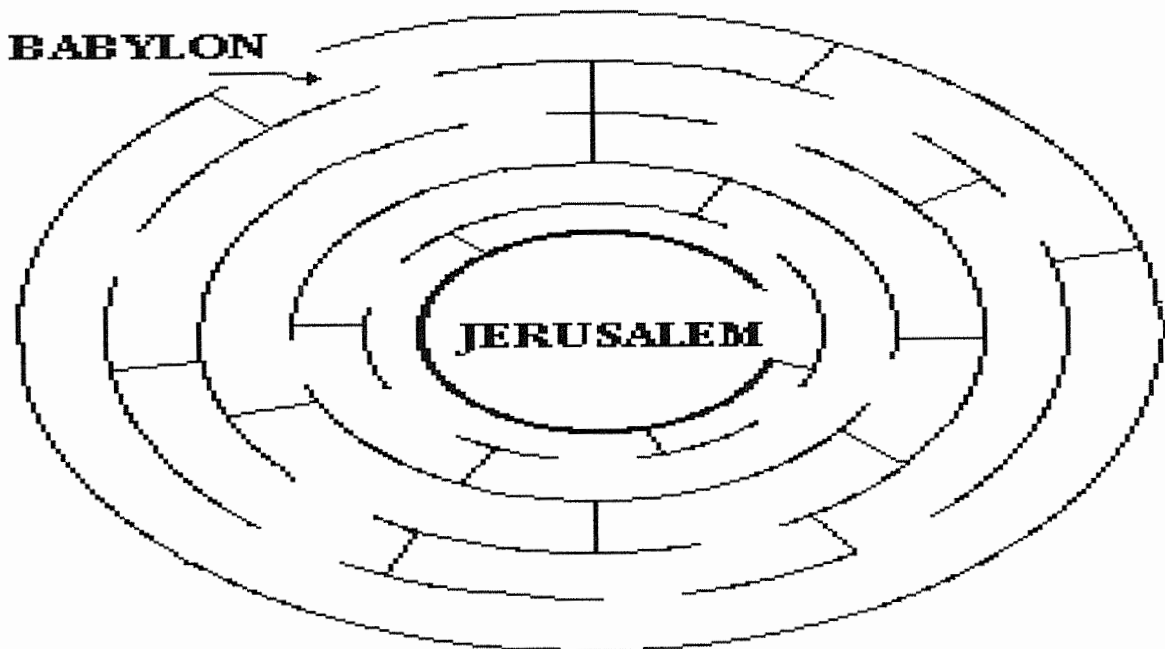

# CYRUS HELPS THE EXILES

(EZRA 1:1-11)

C A P T I V E S V I J I J N H  
 S V I H I Y W L B V H L T O E  
 S W P Y M H G O D A N D U B H  
 O K C O T S E V I L S S B L L  
 E I Q G Q G L P I E E I V L S  
 Z U N M J F O D M O F L N D R  
 S H R N B E W L F M G V Q S E  
 E I C U V Q R T D N I E O N T  
 V P G V B M H U O B E R N K T  
 I K O E W E D Q S A G O V A A  
 N R W Z L H C J O A L S Y U L  
 K E J O Y Y I J F Y L W D W P  
 P N R U R M C C B S W E C K B  
 E D V B U G P A U P K J M Y R  
 U A S B K Q B L D W O L J Y O

BABYLON

GOLD

LIVESTOCK

BASINS

HOUSE OF THE LORD

PLATTERS

CAPTIVES

JERUSALEM

SILVER

CYRUS

KNIVES

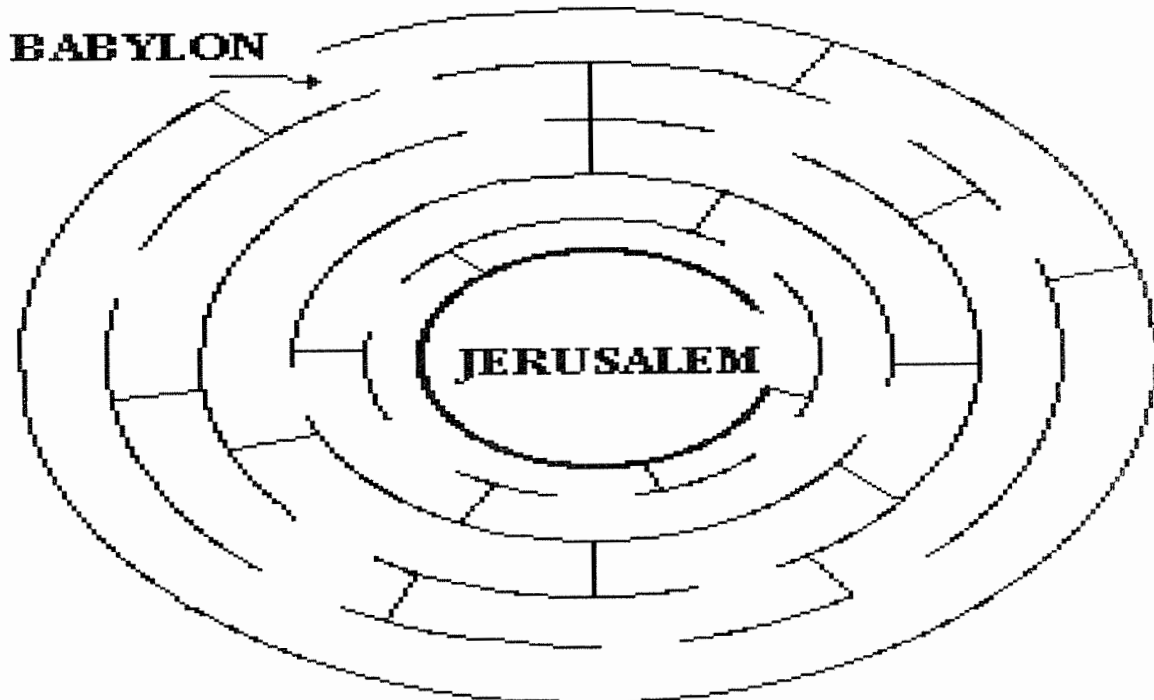

## Year 3

### Week 108

### Jerusalem is Rebuilt

#### Scriptures: Ezra 5 & 6

**Key Verse:** Ezra 6:21 “Then the children of Israel who had returned from the captivity ate together with all who had separated themselves from the filth of the nations of the land in order to seek the LORD God of Israel.

#### Key Points:

1. Temple building had been halted. Prophets Haggai and Zechariah encouraged Zerubbabel (Prince of Judah) and Jeshua (high priest) to resume the building of the temple and the wall. Tattnai, a governor in the region, asked by who’s authority had they resumed the building. They gave them the names of the men working on the building. God was with them and the building was allowed to continue until official word from King Darius could be given.
2. Tattnai sent a letter to King Darius. He explained the history of the destruction of the original temple and how the children of Israel had been exiled to Babylon. He also explained how King Cyrus had issued a decree that the temple could be rebuilt, allowing the articles of the temple that Nebuchadnezzar had taken and carried to the temple of Babylon be recovered and placed back in the new temple. Tattnai asked the king how they were to proceed.
3. King Darius ordered a search for the decree of King Cyrus. The scroll was found and because Darius respected Cyrus, he sent an order back that the building of the temple could be allowed. Also in the decree were orders that all the articles stolen from the temple could be restored and taken back where they belonged. He even requested that taxes paid to the king could be used for the rebuilding so their work would not be hindered.
4. Tattnai and his companions encouraged the rebuilding and did all according to what King Darius had decreed. The Jews finished the temple and they prospered.
5. They celebrated the completion of the temple and dedicated it with great joy. They purified themselves, and kept the Passover and Feast of Unleavened bread, setting back in order the ceremonies of the temple that God had commanded.

# THE COMPLETION & DEDICATION OF THE TEMPLE (EZRA 6:13-22)

## MEMORY VERSE:

*"Then the children of Israel, the priests and the Levites and the rest of the descendants of the captivity, celebrated the dedication of this house of God with joy." EZRA 6:16*

## FILL IN THE BLANK:

1. "So the elders of the Jews \_\_\_\_\_, and they prospered through the prophesying of Haggai the prophet and Zechariah the son of Iddo." **EZRA 6:14**

## CIRCLE THE CORRECT WORDS:

2. "And they built and finished it, according to the commandment of the God of Israel, and according to the command of \_\_\_\_\_, \_\_\_\_\_, and \_\_\_\_\_." **EZRA 6:14**

**CYRUS**

**DARIUS**

**BARIUS**

**ARTAXERXES**

## TRUE OR FALSE:

3. Now the temple was not finished on the third day of the month of Adar, which was in the sixth year of the reign of King Darius. **EZRA 6:15**

**TRUE OR FALSE**

## FILL IN THE BLANK:

4. "Then the children of Israel, the priests and the Levites and the rest of the descendants of the captivity, celebrated the dedication of this house of God with \_\_\_\_\_." **EZRA 6:16**

## TRUE OR FALSE:

5. "They offered sacrifices at the dedication of this house of God." **EZRA 6:17**

**TRUE OR FALSE**

6. "And the descendants of the captivity kept the Passover on the fourteenth day of the first month." **EZRA 6:19**

**TRUE OR FALSE**

## FILL IN THE BLANKS:

7. "For the priests and the Levites had purified themselves; all of them were ritually \_\_\_\_\_." **EZRA 6:20**

8. "Then the children of Israel who had returned from the captivity ate together with all who had separated themselves from the filth of the nations of the land in order to \_\_\_\_\_ the LORD God of Israel." **EZRA 6:21**

9. "And they kept the Feast of Unleavened Bread seven days with joy; for the \_\_\_\_\_ made them joyful." **EZRA 6:22**

# THE COMPLETION & DEDICATION OF THE TEMPLE (EZRA 6:13-22)

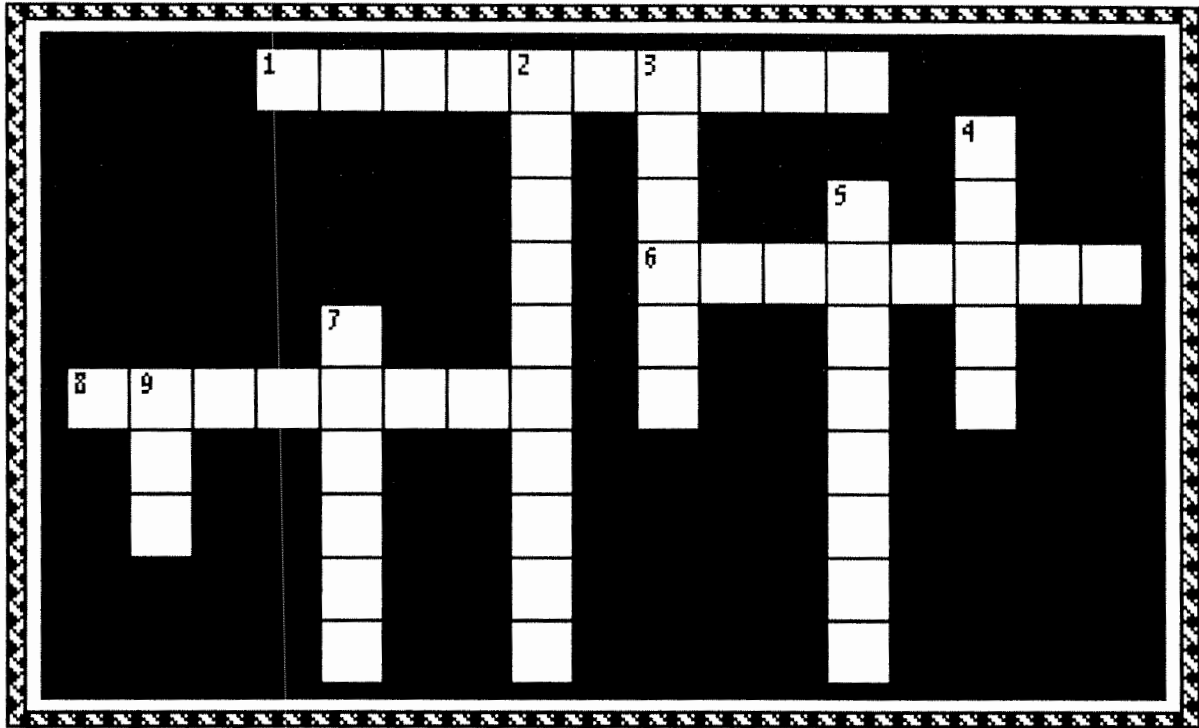

- 4 DOWN "So the elders of the Jews \_\_\_\_\_ and they prospered through the prophesying of Haggai the prophet and Zechariah the son of Iddo." **EZRA 6:14**
- 5 DOWN "And they built and \_\_\_\_\_ it, according to the commandment of the God of Israel, and according to the command of Cyrus, Darius, and Artaxerxes." **EZRA 6:14**
- 3 DOWN "Now the \_\_\_\_\_ was finished on the third day of the month of Adar, which was in the sixth year of the reign of King Darius." **EZRA 6:15**
- 2 DOWN "Then the children of Israel, the priests and the Levites and the rest of the descendants of the captivity, \_\_\_\_\_ the dedication of this house of God with joy." **EZRA 6:16**
- 1 ACROSS "They offered sacrifices at the \_\_\_\_\_ of this house of God." **EZRA 6:17**
- 8 ACROSS "And the descendants of the captivity kept the \_\_\_\_\_ on the fourteenth day of the first month." **EZRA 6:19**
- 6 ACROSS "For the priests and the Levites had \_\_\_\_\_ themselves; all of them were ritually clean." **EZRA 6:20**
- 9 DOWN "Then the children of Israel who had returned from the captivity \_\_\_\_\_ together with all who had separated themselves from the filth of the nations of the land in order to seek the LORD God of Israel." **EZRA 6:21**
- 7 DOWN "And they kept the Feast of Unleavened Bread seven days with joy; for the LORD made them \_\_\_\_\_." **EZRA 6:22**

# THE COMPLETION & DEDICATION OF THE TEMPLE

(EZRA 6:13-22)



“And this house was finished on the third day of the month Adar,  
which was in the sixth year of the reign of Darius the king.”

**EZRA 6:15**

# THE COMPLETION & DEDICATION OF THE TEMPLE

(EZRA 6:13-22)

N	J	D	R	O	L	J	F	H	T
O	R	O	L	E	V	I	T	E	S
I	D	E	Y	F	N	F	M	O	B
T	C	A	V	I	I	P	J	K	U
A	F	D	S	O	L	B	M	Y	I
C	D	H	Q	E	S	G	S	J	L
I	E	P	R	I	E	S	T	S	T
D	H	M	C	O	M	M	A	N	D
E	H	T	C	H	D	B	P	P	N
D	P	N	A	Z	E	A	H	G	L

BUILT

JOY

PASSOVER

COMMAND

LEVITES

PRIESTS

DEDICATION

LORD

TEMPLE

FINISHED

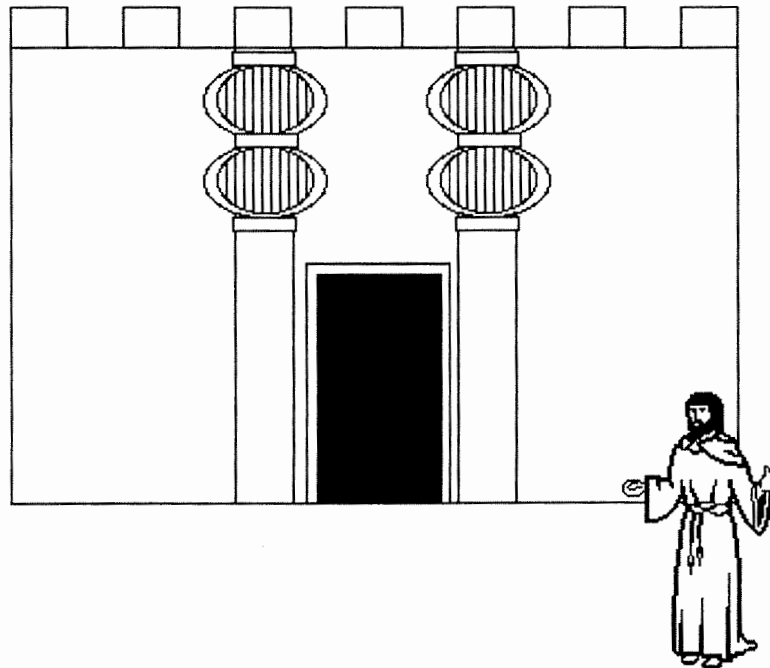



## Year 3

### Week 109

### Beautiful Queen Esther

#### Scriptures: Esther 1 and 2

**Key Verse: Esther 2:17** “The king loved Esther more than all the other women, and she obtained grace and favor in his sight more than all the virgins; so he set the royal crown upon her head and made her queen instead of Vashti.”

#### Key Points:

1. King Ahasuerus gave a large feast that lasted for several days, and summoned Queen Vashti on the 7<sup>th</sup> day to come so he could show her beauty. Queen Vashti refused to come, and the king was very angry.
2. The king consulted with his wise men and decided that the queen’s disobedience would set a bad example for all the women in the land, and that she should no longer be the queen, and another queen should be found.
3. The king orders beautiful women from all over the country to be brought to the palace and for beauty preparations to be made for them. The young woman who most pleases the king would become the new queen.
4. Esther, a Jewish girl who has been raised by her cousin Mordecai, is one of the women taken to the palace, and she finds favor with the custodian of the women. He gives her extra beauty preparations and other benefits. All the time, Esther does not reveal her ethnicity, and Mordecai waits every day for news of Esther.
5. After 12 months of preparations, Esther is taken before the king, where she finds the favor of everyone who sees her, including the king, who loves her more than all the other women. He makes her his queen.
6. Mordecai continues to wait in the king’s gate, and while he is there, he overhears two of the king’s eunuchs plotting to kill King Ahasuereus. He reports this to Queen Esther, who informs the king in Mordecai’s name. Both men were hanged in the gallows, and it was recorded in the king’s book of chronicles.

# 127 ESTHER BECOMES QUEEN

(ESTHER 2:1-18)



"Now when the turn of Esther, the daughter of Abihail the uncle of Mordecai, who had taken her for his daughter, was come to go in unto the king, she required nothing but what Hegai the king's chamberlain, the keeper of the women, appointed. And Esther obtained favour in the sight of all them that looked upon her."

**ESTHER 2:15**

# 127. ESTHER BECOMES QUEEN

(ESTHER 2:1-18)

T K T F C O L G M C Q D D P Z  
Q Y H R A K L G B S Q F D P S  
X T D A B V M T A L H H D R V  
O P T A Y I O E K R E H T S E  
N S N J A J A R I S V G V G M  
C J Y Y D Q S C Y D Z U N B O  
X V B G I X O L E T E I V N N  
B D P H L C I S S D K V D G G  
I T R S O T R A P N R N O B I  
F T U E H Z E O T A E O K L C  
A Q L S B F A V W E L Q M L N  
W F A Q Y P L P U N C A X L E  
X V N M U Q K Q F P N J C N B  
B N Z B W L N Z Z M U V S E P  
Y F H X L A M S B N U Q H N U

CROWN  
ESTHER  
FAVOR  
FEAST

HOLIDAY  
KING  
LOVED  
MORDECAI

PALACE  
QUEEN  
UNCLE  
VASHTI





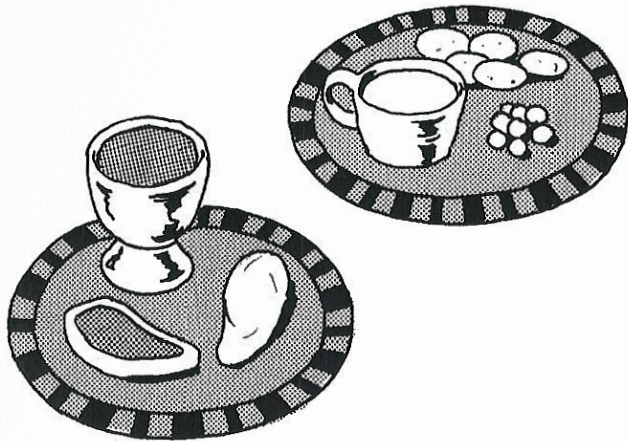

**Directions:**

Cut two plates from construction paper and two from tagboard, all 5 inches in diameter. Glue a paper plate to each tagboard plate. Decorate plates with felt-tip pens or paints. Model food out of bread-dough clay or any self-hardening clay. When food is thoroughly dry, color with the pens or paints. Glue to plates. Cut the cups down to 1½ inches tall. Cover cups with the foil. Twist or fold a scrap to make the handle. Staple or glue in place. Make stem and base of goblet with the extra foil by twisting and flattening into shape. Stuff each container with a bit of plastic from a dry-cleaning bag. (Watch this around children!) Tint the "wine" with a red felt-tip pen. Glue cup and goblet to plates.

(\*See recipe on page 5 for bread dough.)

## In the Fiery Furnace

*Daniel 3*

**Materials needed:**

Tagboard  
Construction paper—black, red, orange



Glue  
Crayons, felt-tip pens, or tempera paints

**Directions:**

Cut the four figures from tagboard, using the patterns on pages 27 and 28. Color the figures. Cut free-form flames from red construction paper. Cut these about 9½ inches wide and 4 inches high at peaks. Make three folds in flames, then add yellow color. Place glue on bottom and sides of flames and glue to orange sheet, about 1½ inches from bottom. Allow flames to "pleat" where they were folded to give them a slight 3-D effect. Cut a piece of black paper, 9 inches by 2½ inches. Put glue on bottom and sides of this and place at bottom, over flames. Figures can now be slipped behind flames and removed easily.

## Esther Paper Doll



**Materials needed:**

Tagboard  
Construction paper—various colors  
Glue  
Gold glitter  
Cotton ball  
Felt-tip pens or tempera paints  
Fancy wrapping paper (optional)

**Directions:**

Cut paper doll out of tagboard, using pattern on page 30. Color with the pens or paints. Cut robe and crown from construction paper. Glue tabs of crown together. Add glue to crown and dip into glitter (or sprinkle on glitter). Unroll cotton ball and use it to trim robe. Make dresses using fancy wrapping paper or use construction paper and decorate with glitter, etc. Add Post-It Note tape to backs of all garments.

# ESTHER BECOMES QUEEN

## (ESTHER 1-17)

### WORD RECOGNITION

Circle the correct word or phrase that best describes the word in the sentence.

### TRUE OR FALSE

King Ahasuerus had a banquet for all the women in the palace. (ESTHER 1:10)

TRUE OR FALSE

### CHOOSE THE CORRECT WORDS

King Ahasuerus had a banquet for all the women in the palace. (ESTHER 1:10)

King Ahasuerus had a banquet for all the women in the palace. (ESTHER 1:10)

### TRUE OR FALSE

King Ahasuerus had a banquet for all the women in the palace. (ESTHER 1:10)

King Ahasuerus had a banquet for all the women in the palace. (ESTHER 1:10)

### TRUE OR FALSE

King Ahasuerus had a banquet for all the women in the palace. (ESTHER 1:10)

TRUE OR FALSE

King Ahasuerus had a banquet for all the women in the palace. (ESTHER 1:10)

TRUE OR FALSE

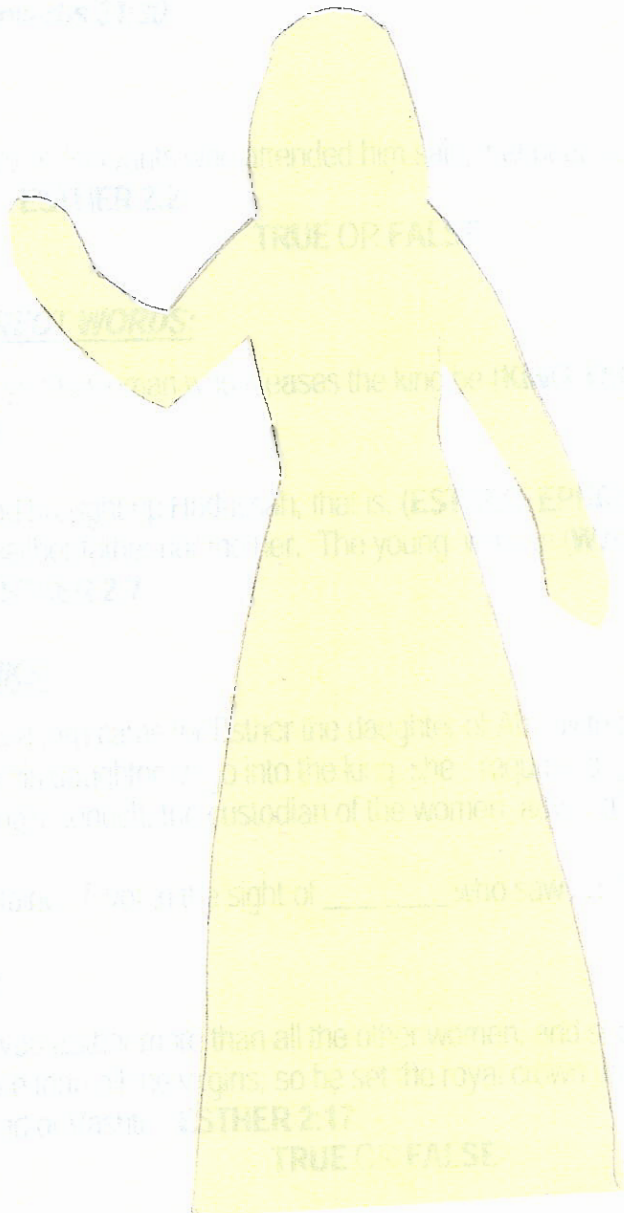

**MORDECAI AND HAMAN****(ESTHER 2:19-3:15)**

"Now it came to pass, when they spake daily unto him, and he hearkened not unto them, that they told Haman, to see whether Mordecai's matters would stand: for he had told them that he *was* a Jew. And when Haman saw that Mordecai bowed not, nor did him reverence, then was Haman full of wrath."

**ESTHER 3:4-5**

128. MORDECAI AND HAMAN  
(ESTHER 2:19-3:15)

V Q J N T P K B J F G J E W S  
 I H K Q Y N M O R D E C A I K  
 O M S Q H O I P W U H C N E W  
 N A O X U K R T E R E S H M L  
 B U M D T E E T S T G Z C Q W  
 O U J N G B E P S G N I K N W  
 W T D D T N N N S E D H V Y Z  
 H T T E E C I A E D D K C M O  
 I C A A G C P K H S E K C A A  
 U D O Y R N R Y I T T Y H S K  
 A D A M R D A E A H G H E V U  
 F Q U Q M E I H E O A I E B N  
 F C E U T A Y F G M V M B R O  
 H O M A G E N O W J B R A Y U  
 T U G Q W W B D A K G E R N D

BIGHTHAN  
 BOW  
 COMMAND  
 DECREE

DESTROY  
 GATE  
 HAMAN  
 HANGED

HOMAGE  
 JEWS  
 KING  
 KINGDOM

MORDECAI  
 OBEYED  
 QUEEN ESTHER  
 TERESH

FIND YOUR WAY THROUGH THE DECREE

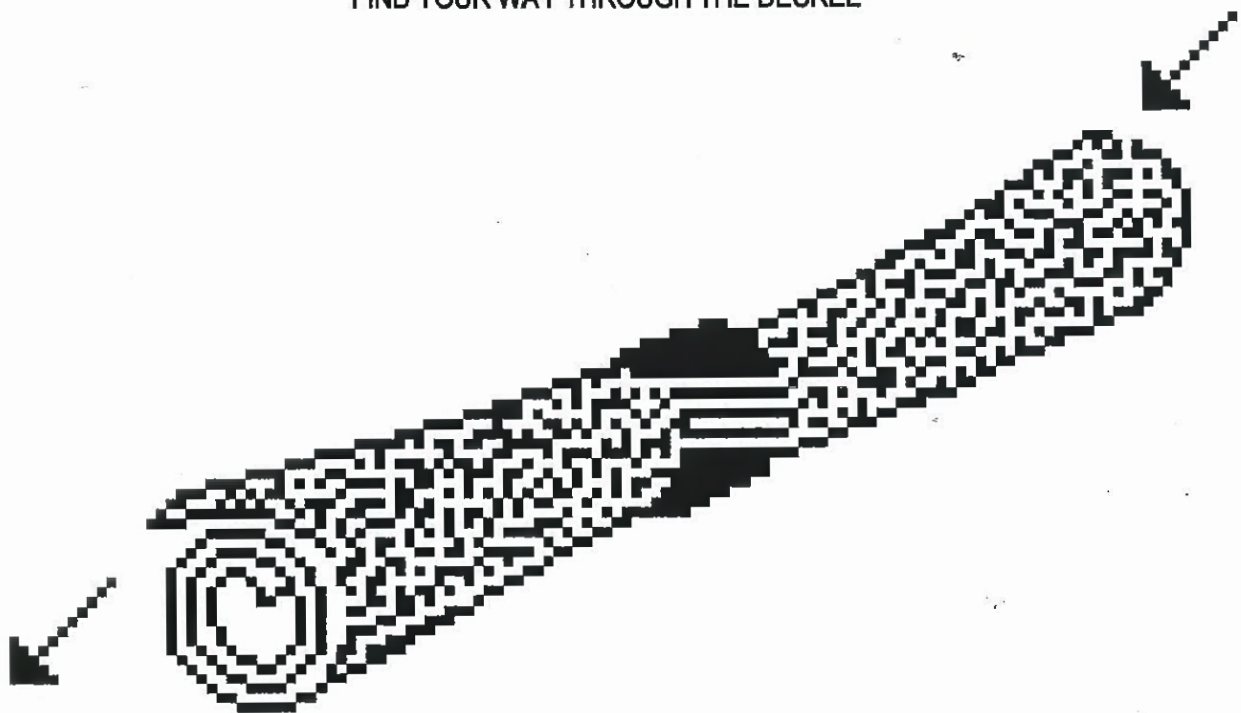



## Year 3

### Week 110

### Esther Saves God's People

#### Scriptures: Esther 3 - 8

**Key Verse: Esther 4:14** "If you remain silent at this time, relief and deliverance will arise for the Jews from another place, but you and your father's house will perish. Yet who knows whether you have come to the kingdom for such a time as this?"

#### Key Points:

1. Haman receives promotions, and is angered when Mordecai does not bow down to him. Instead of punishing only Mordecai, Haman decides to seek his revenge by destroying all of the Jews in the kingdom. He persuades King Ahasuereus to let him write a decree that the Jews may be destroyed.

2. When Mordecai learns of the decree, he mourns in the midst of the city, and word of it reaches Esther. She discovers the reason for Mordecai's grief and learns of the decree of the king, but does not want to go into the king's presence, since she has not been summoned. Mordecai reminds her that she, too, will be killed. Esther asks for all the Jews to fast for her before she goes into the king.

3. Esther seeks an audience with the king, and when she is accepted, she requests that the king and Haman come that day to a banquet she has prepared. When they come, she requests that they attend another banquet tomorrow, where she will reveal her petition. Haman leaves joyful, but is angered when he sees Mordecai. He goes home to his wife and friends, who suggest that he have Mordecai hanged on a gallows. Haman has the gallows made.

4. Meanwhile, the king is unable to sleep, and he has his book of chronicles read for him, when he remembers that he needs to honor Mordecai. He asks Haman for his advice on what should be done for the man the king delights to honor. Haman, thinking the king is talking about him, suggests a great honor of riding through the city on horseback, with someone shouting about him. The king is pleased by this suggestion, and tells Haman to do so for Mordecai.

(Continued on next page)



5. At the banquet, Queen Esther asks that the king to save the lives of her and her people, and tells him that Haman devised the wicked plan. The king leaves in his anger, and when he returns, Haman is begging for his life before Esther, laying across her couch. Haman is then hanged on the gallows prepared for Mordecai.

6. King Ahasuerus gives Mordecai the house of Haman, and the king wrote a counter-decree to save the Jews. Instead of just being attacked, they may now fight back against their enemies. Many people in the land were converted to Judaism.



**Brave Esther helped save God's people.**

Esther  
Esther

# A Very Special Queen

Circle the words that tell about Esther.  
When you are finished, copy the letters in  
the crowns to the matching crown-spaces below.

be<sup>👑</sup>autiful

was a  
que<sup>👑</sup>en

Mordecai's  
cousin

ugly

lived in  
a tent

marrie<sup>👑</sup>d  
King Xerxes

helped her  
people

<sup>👑</sup>s topped Haman

asked Xerxes  
for gold

lazy



li<sup>👑</sup>ed in a palace

Esther



her people.

\_\_\_\_\_ knew that Queen Esther was the only one who could talk to the king about \_\_\_\_\_'s plot to kill all of the Jews. This was scary for Esther. The custom of the day was that if the king didn't summon you and you appeared before him, he might have you killed. Also, the king didn't know that Esther was a Jew. Esther bravely approached the king.

To fill in the missing names above, write the letters of the picture clues, adding or subtracting according to the math signs.

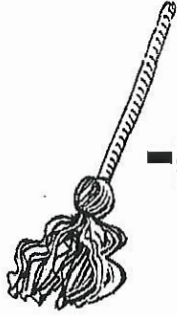

**-p +**



**-oa +**



**-tre +**



**-t**

**+**



**- dce**

\_\_\_\_\_

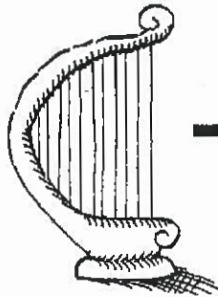

**-rp**

**+**



\_\_\_\_\_



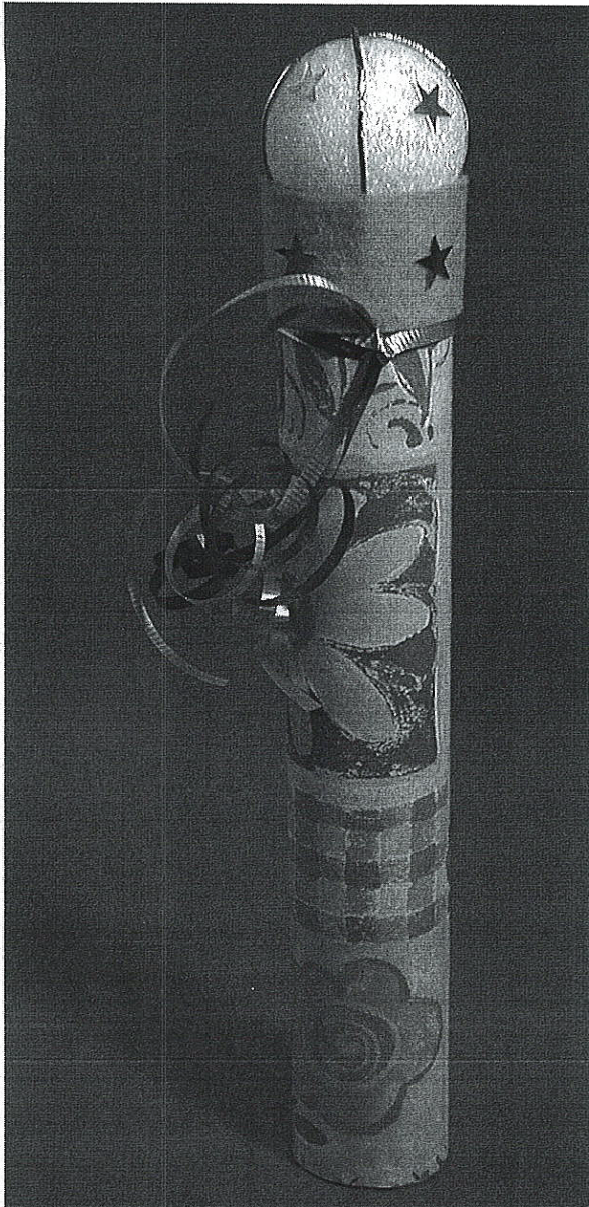









### MATERIALS

12-inch tube from paper towel  
wrapping paper  
2-inch Styrofoam ball  
various trims  
felt  
tape

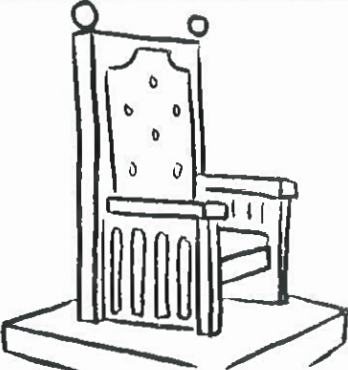
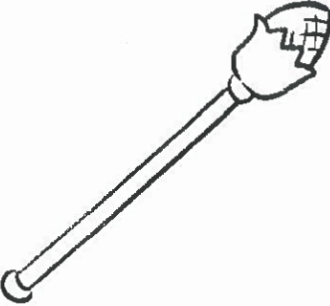
Esther knew the king would talk to her because he held out his scepter when she came into the room. The scepter was a symbol of his authority over all the people.

You can make a scepter out of a cardboard tube. Cut a piece of wrapping paper large enough to cover the entire tube. Tape it in place. Then push the Styrofoam ball in one end of the tube as far as it will go. Use small rope-type trim to hold the ball in place, overlapping the tube about half an inch, and taping it down. Then cover the tape with trim, ribbon, or a piece of felt. Glue small decorations to the ball and tube, and add ribbons if you like.

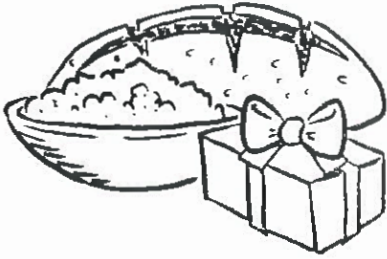
 <p>King Ahasuerus</p>	 <p>Queen Esther</p>	 <p>Esther's cousin, Mordecai</p>
 <p>Wicked Prince Haman</p>	 <p>The king's decree</p>	 <p>Esther before the king</p>
 <p>The king's scepter</p>	 <p>Esther's banquets</p>	 <p>Decree sealed by the king's ring: The Jews may live!</p>
 <p>Haman hanged on his own gallows</p>	 <p>Mordecai crowned as prince</p>	 <p>The Feast of Purim</p>

This was a matching game.



# Esther

Esther 2, 4, 5, 8

# A Petition and a Request

Use the code to decipher the message by writing the opposite letter on the lines provided. Example: for the letter C, P would be the answer.

A	B	C	D	E	F	G	H	I	J	K	L	M
N	O	P	Q	R	S	T	U	V	W	X	Y	Z

Wicked Haman plotted to kill all of the Jews throughout the kingdom of Xerxes. Queen Esther brought a petition to the king for her people. Use the code to discover Esther's request (Esther 3:5, 6; 7:1-4).

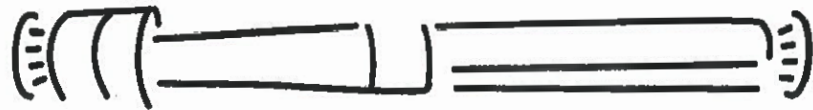

T E N A G    Z<sup>R</sup>    Z<sup>L</sup>    Y V S R

F N E<sup>R</sup>    Z<sup>L</sup>    C<sup>B</sup> R C<sup>R</sup> Y

# Purim

From Wikipedia, the free encyclopedia

**Purim** (Hebrew: פורים *Pûrîm* "lots", related to Akkadian *pûru*) is a Jewish holiday that commemorates the deliverance of the Jewish people of the ancient Persian Empire from Haman's plot to annihilate them, as recorded in the Biblical Book of Esther (*Megillat Esther*). According to the story, Haman cast lots to determine the day upon which to exterminate the Jews.

Purim is celebrated annually according to the Hebrew calendar on the 14th day of the Hebrew month of Adar, the day following the victory of the Jews over their enemies; as with all Jewish holidays, Purim begins at sundown on the previous secular day. In cities that were protected by a surrounding wall at the time of Joshua, including Shushan (Susa) and Jerusalem, Purim is celebrated on the 15th of the month, known as *Shushan Purim*. Purim is characterized by public recitation of the Book of Esther (*keriat ha-megilla*), giving mutual gifts of food and drink (*mishloach manot*), giving charity to the poor (*mattanot la-eyyonim*), and a celebratory meal (*se'udat Purim*);<sup>[1]</sup> other customs include drinking wine, wearing of masks and costumes, and public celebration.

Jewish exiles from the Kingdom of Judah who had been living in the Babylonian captivity (6th Century BCE) found themselves under Persian rule after Babylonia was in turn conquered by the Persian Empire. According to the Book of Esther, Haman, royal vizier to King Ahasuerus / Xerxes,<sup>[2]</sup> planned to kill the Jews, but his plans were foiled by Esther, who was made queen after Xerxes kicked out his previous queen, Vashti, and Mordechai, the palace gatekeeper for Xerxes who raised Esther when her parents died, though he was her cousin. The Jews were delivered from being the victims of an evil decree against them and were instead allowed by the King to destroy their enemies, and the day after the battle was designated as a day of feasting and rejoicing.

## Contents

- 1 History
  - 1.1 The Persian Empire
  - 1.2 Sources
  - 1.3 The Purim story
- 2 The holiday
- 3 Reading of the Megilla
  - 3.1 Boisterousness in the synagogue
  - 3.2 Burning of Haman's effigy
  - 3.3 Women and Megilla reading
- 4 Giving of food gifts and charity
- 5 The Purim meal
- 6 Masquerading
- 7 Songs
- 8 Traditional foods
- 9 Purim Torah and Purim spiel
- 10 Focus on children
  - 10.1 Children's Songs
- 11 Shushan Purim
- 12 Purim Ha-Me-shulash
- 13 Purim Katan
- 14 Fasting before and after Purim
- 15 Other "Purims"
  - 15.1 Public / Communal

*Make out of poppicle sticks + construction paper*

## Purim

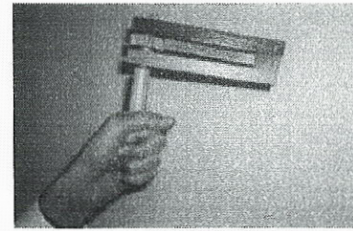

A Purim gragger, also called "*ra'ashan*" (noisemaker), used when Haman's name is mentioned during the reading of the Megilla, as tradition dictates, to blot out the name of evil.

**Official name** Hebrew: פורים Translation: "Lots" (of a "lottery" performed by the wicked Haman)

**Observed by** Judaism

**Type** Jewish

**Significance** Celebration of Jewish deliverance as told in the Book of Esther. After the destruction of the Kingdom of Judah, the Jews were taken into the seventy-year Babylonian captivity. When ancient Persia took control, Haman, royal vizier to King Ahasuerus, planned to kill the Jews, but his plans were foiled by Esther and Mordechai.

**Date** 14th day of Adar (in Jerusalem and all ancient walled cities on 15th of Adar)

**2008 date** Sunset, 20 March – nightfall, 21 March

**2009 date** Sunset, 9 March – nightfall, 10 March

**Celebrations** Listening to the reading of the Book of Esther - the *Megillah* ("scroll") in synagogue. Giving Tzedakah "gifts to the poor" (*mattanot le'evyonim*). Sending "gift food portions" (*mishloach manot*). Eating a festive meal.

**Related to** Hanukkah, as a rabbinically decreed holiday





131 **MORDECAI IS HONORED**  
(ESTHER 6:1-14)

*Mordecai's procession begins here*

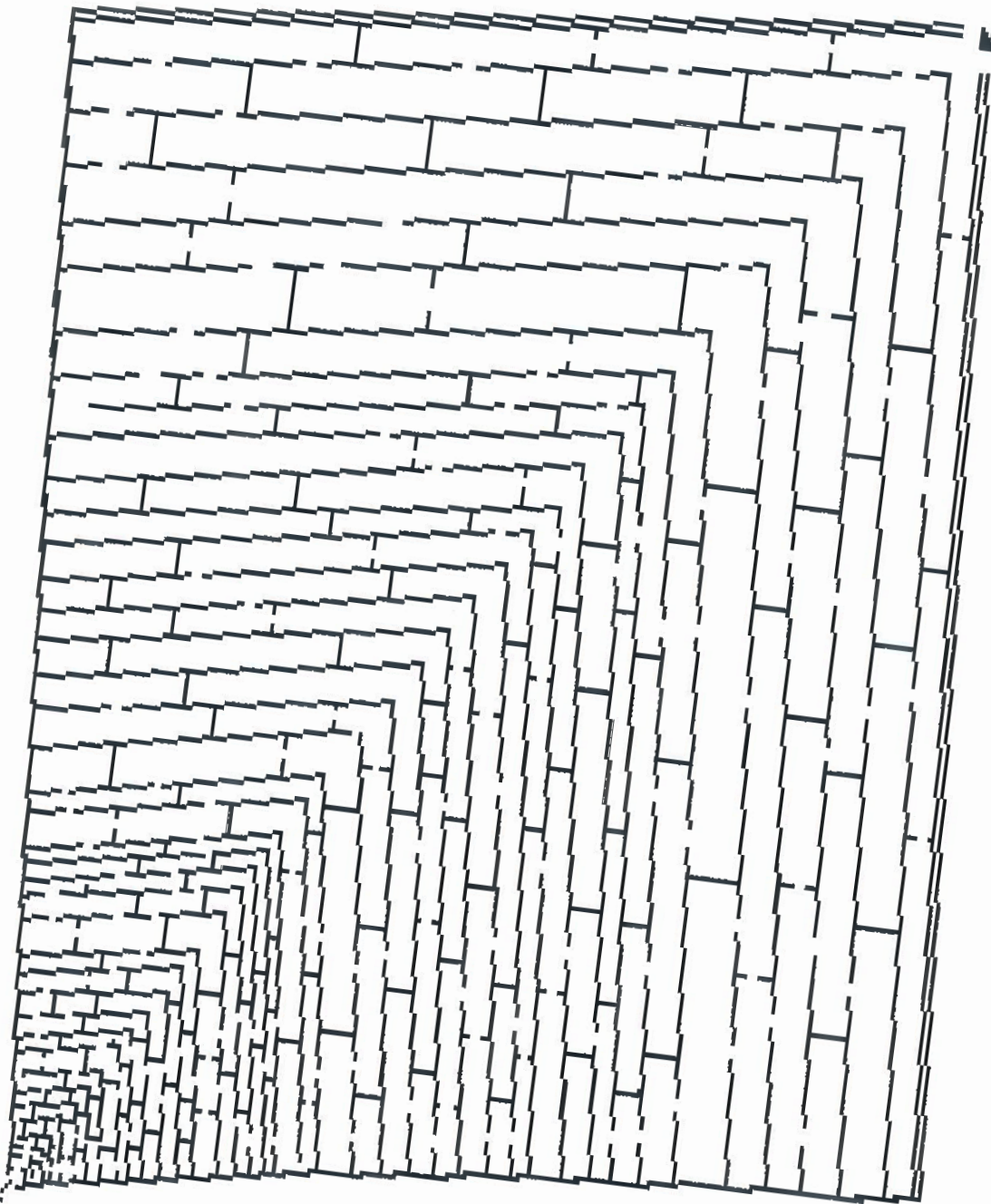

*The place of honor*

# HAMAN'S EVIL IS REPAID

(ESTHER 7:1-10)

## MEMORY VERSE:

*"Do not be overcome by evil, but overcome evil with good."* ROMANS 12:21

## TRUE OR FALSE:

1. "So the king and Haman went to dine with Queen Esther." ESTHER 7:1  
TRUE OR FALSE

## FILL IN THE BLANKS:

2. Queen Esther said to the king, "If I have found favor in your sight, O king, and if it pleases the king, let \_\_\_\_ life be given me at \_\_\_\_ petition, and \_\_\_\_ people at \_\_\_\_ request."  
ESTHER 7:3

## UNDERLINE THE CORRECT ANSWER:

3. "For we have been sold, my people and I,..." ESTHER 7:4
- a. to be destroyed
  - b. to be killed
  - c. to be annihilated
  - d. all of the above

## CIRCLE THE CORRECT WORDS:

4. "Then King Ahasuerus answered and said to Queen Esther, 'Who is he, and where is he, who would dare presume in his (HEAD, HEART) to do such a thing?' " ESTHER 7:5
5. "And Esther said, 'The adversary and enemy is this wicked (HAMAN, KING)!' So Haman was (HAPPY, TERRIFIED) before the king and queen." ESTHER 7:6

## TRUE OR FALSE:

6. "Then the king arose in his wrath from the banquet of wine and went into the palace garden: but Haman stood before Queen Esther, pleading for his life, for he saw that evil was determined against him by the king." ESTHER 7:7  
TRUE OR FALSE
7. "So they hanged Haman on the gallows that he had prepared for Mordecai. Then the king's wrath subsided." ESTHER 7:10  
TRUE OR FALSE



## 32. HAMAN'S EVIL IS REPAID (ESTHER 7:1-10)

P H A N G E D C X V H A M A N  
 E N E M Y B A Z N Z D L O S K  
 T K J R R K X L O K M T G T Y  
 I D S Y F K N E D R A G N E R  
 T D I A C E D R D M Z A I U G  
 I O U Y E A V U B F J L K Q I  
 O K E D J T F A V O R L E N K  
 N Q A J O W Q T U K S O I A U  
 U D E I F I R R E T M W K B A  
 E K V I U L D S L S M S H Z V  
 C L D P G A T M P M P E P V X  
 N W Q T F H V O M O A J P F O  
 M O R D E C A I C R W R A T H  
 Q K E R K P S E T A C X P R U  
 L I N V D P M M C T D G U K V

BANQUET  
 ENEMY  
 ESTHER  
 FAVOR

GALLOWS  
 GARDEN  
 HAMAN  
 HANGED

HEART  
 KING  
 MORDECAI  
 WRATH

PETITION  
 SOLD  
 TERRIFIED

You are invited to dine with the king!

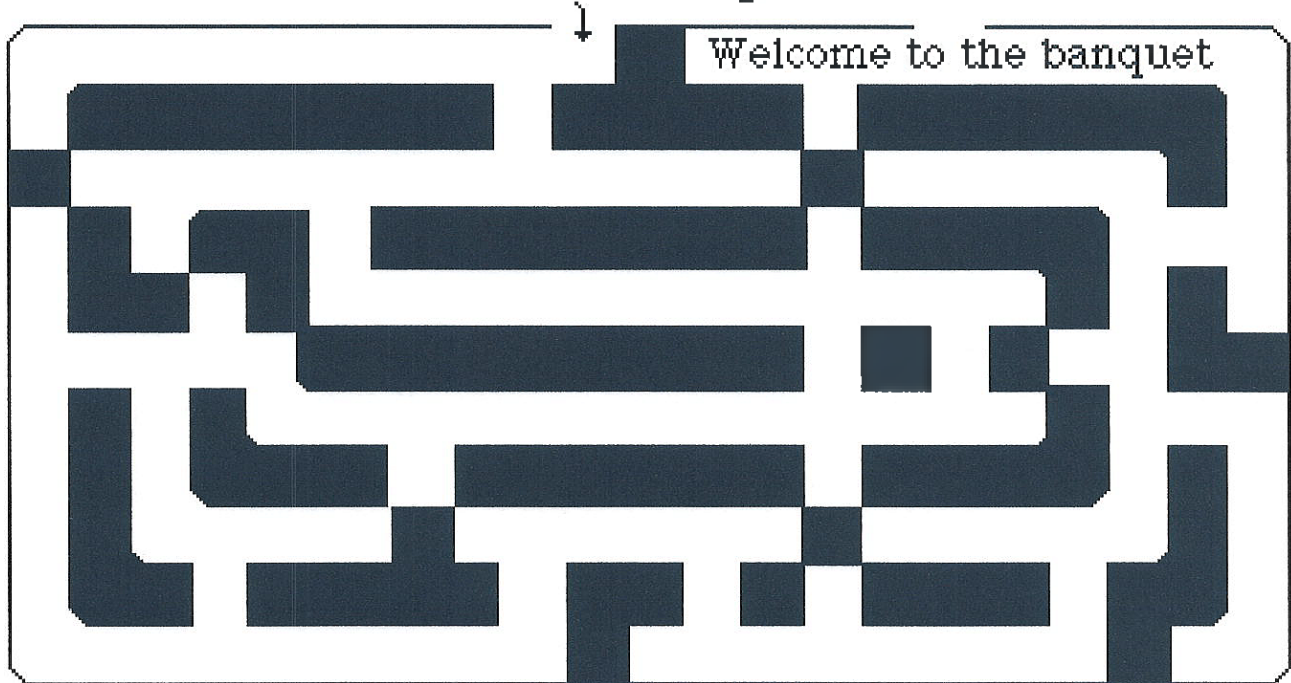

# ESTHER SAVES HER PEOPLE

## (ESTHER 8:1-17)

### MEMORY VERSE:

*"When it goes well with the righteous, the city rejoices; and when the wicked perish, there is shouting."* PROVERBS 11:10

### TRUE OR FALSE:

1. "King Ahasuerus gave Queen Esther the house of Haman, the enemy of the Jews. And Mordecai came before the king, for Esther had told how he was related to her." **ESTHER 8:1**  
**TRUE OR FALSE**

### UNDERLINE THE CORRECT ANSWER:

2. "So the king..." **ESTHER 8:2**
- took off his signet ring, which he had taken from Haman
  - gave it to Mordecai
  - and Esther appointed Mordecai over the house of Haman
  - all of the above

### FILL IN THE BLANKS:

3. The king said to Queen Esther and Mordecai, "You yourselves write a decree for the Jews, as you please, in the king's name, and seal it with the king's signet \_\_\_\_\_; for a letter which is written in the king's name and sealed with the king's signet \_\_\_\_\_ no one can revoke." **ESTHER 8:8**
4. "By these \_\_\_\_\_ the king permitted the Jews who were in every city to gather together and \_\_\_\_\_ their lives." **ESTHER 8:11**

### UNDERLINE THE CORRECT ANSWER:

5. "Now Mordecai went out from the presence of the king..." **ESTHER 8:15**
- in royal apparel of blue and white
  - with a great crown of gold
  - and a garment of fine linen and purple
  - all of the above

### CIRCLE THE CORRECT WORDS:

6. "The Jews had..." **ESTHER 8:16**
- LIGHT      GLADNESS      SADNESS      MADNESS      JOY      HONOR

### FILL IN THE BLANKS:

7. "And in every province and city, wherever the king's command and decree came, the Jews had \_\_\_\_\_ and \_\_\_\_\_, a feast and a holiday. Then many of the people of the land became Jews because \_\_\_\_\_ of the Jews fell upon them." **ESTHER 8:17**

# ESTHER SAVES HER PEOPLE

(ESTHER 8:1-17)

J S D Q Q Z Z J J H W G U J C U W K J A N J F P U  
S E E R C E D T Q M Y N M K V D J Q I P O S R T H  
T I R R F P C E R W P G D K T K W K P P B M K O A  
A L A I H A C J I S Z Z L P H S I L T A U N K N E  
Z E E P P N J Z L V W J S Z A S S N V X L P Y I C  
F S U H J M Q O S O B P V Y M J O E D V P C R J N  
S P W Z T G I Z Y J M N R Y A H E W N R M D G J A  
D J R G N I R T E N G I S O N Q P K R D E T I Y I  
J F J O B F W K T J W N C J W O T I F R A D K T Z  
Q F N I T H Z R F E R O M F H E C J E Q E L U H S  
I O S V I E O C A A F F L A P W S S J D C T G G N  
H P Z V A N C T Y W I L K H J E C U O V C P T F C  
O E K B O A K T Y L X L B I H B H E U S V R A E Z  
U O B H M W K I O Z G M X A N K U A G M Z G V Y L  
S O R E T P E C S N E D L O G G E V F C W E B Q T  
E C Z Q G V Q O F N Y S A H Q S A D K Z F P O D R  
K F F Y T P J T V P P Z C Z O U C H D L K I L C P  
T K H E Y E B A L J Y F W Y A H N Q A U S K U O J  
D B N L L S B N S H B P J N W P Q T B S M M V M T  
Y Y J N I G R R V G D G U J V E H E K T U P Z P P  
Q U E E N E S T H E R K K T M G L N K M O E A O Q  
H N G V W D B P M E R B O P I V K R A O A P R E M  
U M X Q O S K I A U C U I L F A D Y T E T U U U Q  
Q H G T V E E Q Z W G K T L S R D Y W M M Z E A S  
S L R A Q P F D S D R C E J W L O D L X Z V F Y F

DECREE  
FEAR  
GLADNESS  
GOLDEN SCEPTER  
HAMAN

HONOR  
HOUSE  
JEWS  
JOY

KINDRED  
KING AHASUERUS  
LETTER  
LIGHT

PLOT  
PROTECT  
QUEEN ESTHER  
SIGNET RING





# ESTHER SAVES HER PEOPLE

## (ESTHER 8:1-17)

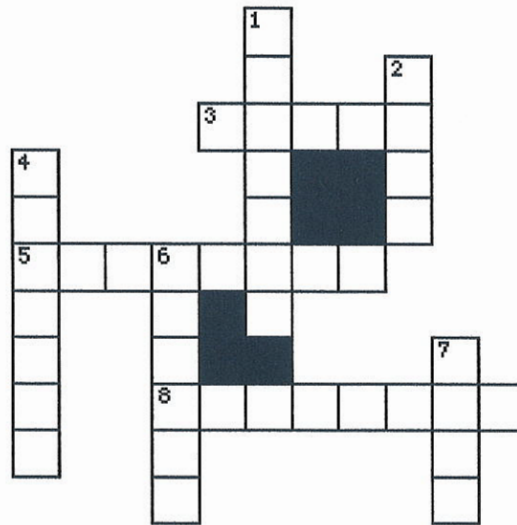

- 8 ACROSS "When it goes well with the righteous, the city \_\_\_\_\_; and when the wicked perish, there is shouting." **PROVERBS 11:10**
- 3 ACROSS "King Ahasuerus gave Queen Esther the \_\_\_\_\_ of Haman, the enemy of the Jews. And Mordecai came before the king, for Esther had told how he was related to her." **ESTHER 8:1**
- 7 DOWN "So the king took off his signet \_\_\_\_\_, which he had taken from Haman, and gave it to Mordecai; and Esther appointed Mordecai over the house of Haman." **ESTHER 8:2**
- 6 DOWN The king said to Queen Esther and Mordecai, "You yourselves write a \_\_\_\_\_ for the Jews, as you please, in the king's name, and seal it with the king's signet ring; for a letter which is written in the king's name and sealed with the king's signet ring no one can revoke." **ESTHER 8:8**
- 1 DOWN "By these letters the king permitted the Jews who were in every city to gather together and \_\_\_\_\_ their lives." **ESTHER 8:11**
- 5 ACROSS "Now \_\_\_\_\_ went out from the presence of the king in royal apparel of blue and white, with a great crown of gold and a garment of fine linen and purple." **ESTHER 8:15**
- 2 DOWN "The \_\_\_\_\_ had. light and gladness, joy and honor." **ESTHER 8:16**
- 4 DOWN "And in every province and city, wherever the king's \_\_\_\_\_ and decree came, the Jews had joy and gladness, a feast and a holiday. Then many of the people of the land became Jews, because fear of the Jews fell upon them." **ESTHER 8:17**

## Year 3

### Week 111

## Ezra Helps God's People

**Scriptures:** Ezra 7, 8, 9, 10

**Key Verse:** Ezra 7:10 “For Ezra had prepared his heart to seek the law of the Lord, and to do it, and to teach in Israel statutes and judgments.”

### Key Points:

1. Some of the Israelites had come back from their captivity in Babylon to Jerusalem. They came of their own free will (7:13). Many were ignorant of God's laws. Ezra was an excellent and skillful scribe of the law as well as a priest of Israel. He also had made plans to come from Babylon, preparing his heart to do the work of the Lord and to teach His statutes to the people returning to Jerusalem.

2. King Artaxerxes wanted the children of Israel to serve God. He had seen what happened when they displeased God. The king knew Ezra and that God's hand was with him. Through a letter, the King gave Ezra the responsibility of bringing gifts and offerings from Babylon to Jerusalem for the restoration of the temple. (outline for the class the commands in the letter)

3. Ezra was encouraged by God's mercy and gathered chief men of Israel to go up with him. He was tempted to ask the King for an escort of soldiers for protection from enemies but instead the men gathered at the river for fasting and prayer. The Lord answered their prayer and they arrived safely.

4. After their arrival in Jerusalem, it came to Ezra's attention that many of the men had taken foreign women for wives which was against God's laws. Ezra was so grieved over this, he tore his robe and plucked out hair from his head and beard. He fell on his knees before God, weeping praying and confessing for the sins of Israel.

5. A very large congregation assembled in front of Ezra. They wanted to confess their sins. With Ezra's help they made a covenant with God to put away their pagan wives and children. Purity was restored to the Israelite nation.



# THE PEOPLE CONFESS THEIR SIN

(EZRA 10:1-17)

Q C O N F E S S I N G  
 P U L M Y E U S D M D  
 A R E O M H W G W O Y  
 G B F S D T N V G U S  
 A U O I T I Q N T R M  
 N W L W Y I I U L N U  
 W N R A I P O U A E D  
 I U R A E N N N O D O  
 V P Y E T L G Q I P G  
 E D W R F H I L A N X  
 S L H F B E Z R A A G

BOWING  
 CONFESSING  
 EZRA  
 GOD

MOURNED  
 PAGAN WIVES  
 PRAYING

QUESTIONING  
 WEEPING  
 WRATH

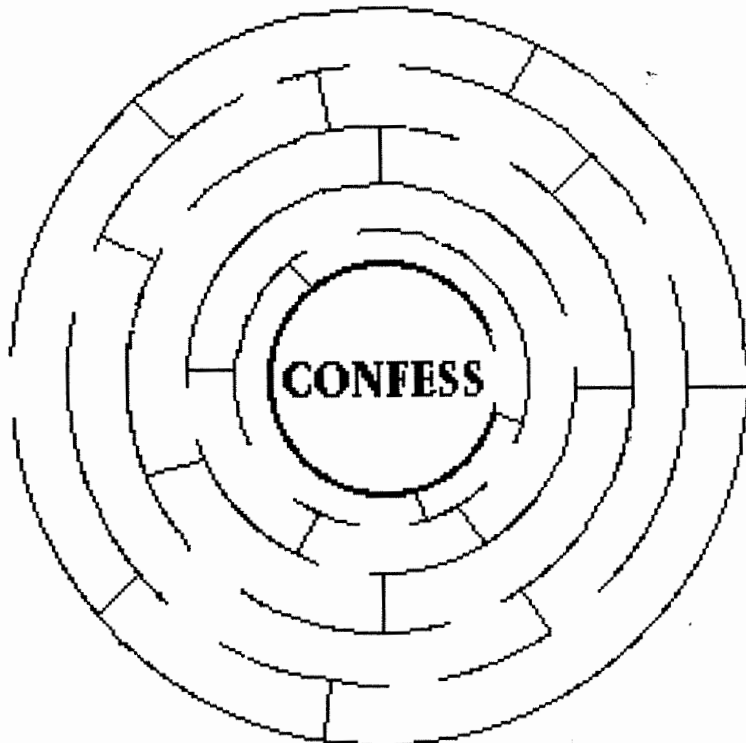

**THE PEOPLE CONFESS THEIR SIN**  
**(EZRA 10:1-17)**



"Now therefore, make confession to the LORD God of your fathers, and do His will; "  
**EZRA 10:11**

# THE PEOPLE CONFESS THEIR SIN

## (EZRA 10:1-17)

### MEMORY VERSE:

"Now therefore, make confession to the LORD God of your fathers, and do His will; separate yourselves from the peoples of the land." EZRA 10:11

### FILL IN THE BLANKS:

1. "Now while Ezra was \_\_\_\_\_, and while he was \_\_\_\_\_, \_\_\_\_\_, and \_\_\_\_\_ down before the house of God, a very large congregation of men, women, and children assembled to him from Israel; for the people wept very bitterly." EZRA 10:1

### UNDERLINE THE CORRECT ANSWER:

2. "Then Ezra rose up from before the house of God, and went into the chamber of Jehohanan the son of Eliashib; and when he came there..." EZRA 10:6
- he ate no bread
  - he drank no water
  - he mourned because of the guilt of those from the captivity
  - all of the above

### TRUE OR FALSE:

3. "They issued a proclamation throughout Judah and Jerusalem to all the descendants of the captivity, that they must gather at Jerusalem." EZRA 10:7

TRUE OR FALSE

4. "All the people sat in the open square of the house of God, trembling because of this matter and because of heavy rain." EZRA 10:9

TRUE OR FALSE

### FILL IN THE BLANKS:

5. "Then Ezra the priest stood up and said to them, 'You have transgressed and have taken \_\_\_\_\_ wives, adding to the guilt of Israel.'" EZRA 10:10
6. "Now therefore, make \_\_\_\_\_ to the LORD God of your fathers, and do His will; separate yourselves from the peoples of the land, and from the pagan wives." EZRA 10:11

### TRUE OR FALSE:

7. Then all the congregation answered and said with a loud voice, "No! As you have said, we will not do." EZRA 10:12

TRUE OR FALSE

### FILL IN THE BLANKS:

8. They said, "Please, let the leaders of our entire congregation stand; and let all those in our cities who have taken pagan wives come at appointed times, together with the elders and judges of their cities, until the fierce \_\_\_\_\_ of our God is turned away from us in the matter." EZRA 10:14

### TRUE OR FALSE:

9. "By the first day of the month they finished questioning all the men who had taken pagan wives." EZRA 10:17

TRUE OR FALSE

# THE PEOPLE CONFESS THEIR SIN (EZRA 10:1-17)

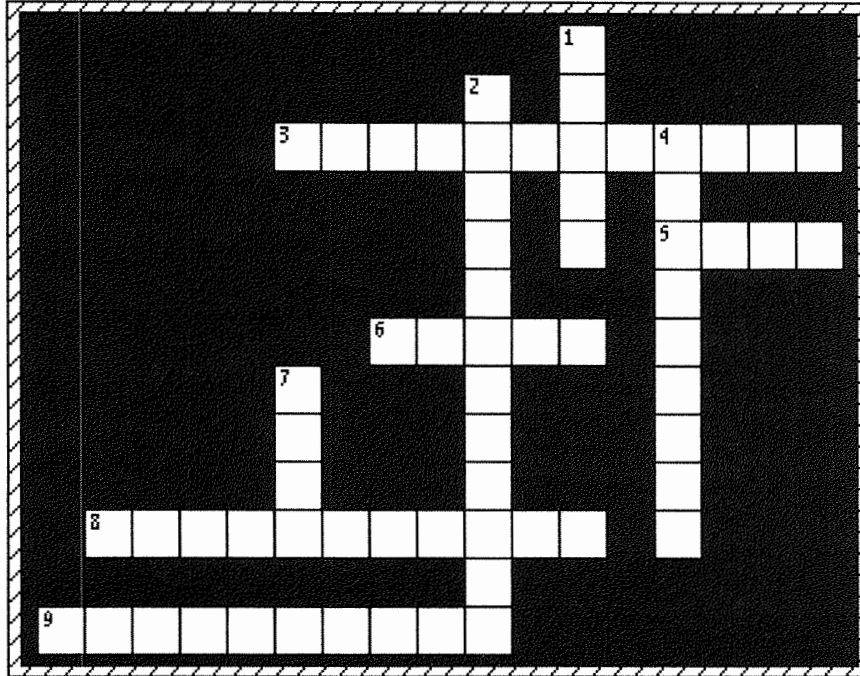

- 7 DOWN "Now while Ezra was praying, and while he was confessing, weeping, and bowing down before the house of God, a very large congregation of men, women, and children assembled to him from Israel; for the people \_\_\_\_\_ very bitterly." **EZRA 10:1**
- 5 ACROSS "Then \_\_\_\_\_ rose up from before the house of God, and went into the chamber of Jehohanan the son of Eliashib." **EZRA 10:6**
- 2 DOWN "They issued a \_\_\_\_\_ throughout Judah and Jerusalem to all the descendants of the captivity, that they must gather at Jerusalem." **EZRA 10:7**
- 4 DOWN "All the people sat in the open square of the house of God, \_\_\_\_\_ because of this matter and because of heavy rain." **EZRA 10:9**
- 1 DOWN "Then Ezra the priest stood up and said to them, 'You have transgressed and have taken \_\_\_\_\_ wives, adding to the guilt of Israel.'" **EZRA 10:10**
- 9 DOWN "Now therefore, make \_\_\_\_\_ to the LORD God of your fathers, and do His will; separate yourselves from the peoples of the land, and from the pagan wives." **EZRA 10:11**
- 3 ACROSS "Then all the \_\_\_\_\_ answered and said with a loud voice, 'Yes! As you have said, so we must do.'" **EZRA 10:12**
- 6 ACROSS They said, "Please, let the leaders of our entire congregation stand; and let all those in our cities who have taken pagan wives come at appointed times, together with the elders and judges of their cities, until the fierce \_\_\_\_\_ of our God is turned away from us in the matter." **EZRA 10:14**
- 8 ACROSS "By the first day of the month they finished \_\_\_\_\_ all the men who had taken pagan wives." **EZRA 10:17**

## Year 3

### Week 112

### Nehemiah Looks to God-Rebuilding the Wall

#### Scriptures: Nehemiah 1 - 6

**Key Verse:** Nehemiah 6:16 'And it happened, when all our enemies heard of it, and all the nations around us saw these things, that they were very disheartened in their own eyes; for they perceived that this work was done by our God.'

#### Key Points:

1. Nehemiah was a cupbearer to the King. Nehemiah had heard of the desolate condition of his homeland in Judah, this was very distressing to Nehemiah. He prayed to God to be able to go work to restore Jerusalem and rebuild the wall. King Artaxerxes saw how this made Nehemiah sad so the king gave his blessing to go and work. Soldiers were sent to help him on his way as well as a letter from the king for permission to pass through the kingdoms and for materials needed.

2. Nehemiah went by night to look over the work that needed to be done. He told the Jews and officials his plans and they were encouraged, wanting to help. Enemies of the Israelites, Sanballat and Tobiah, scoffed at them, desiring to keep them from rebuilding the wall. Nehemiah prayed to God for guidance.

3. Many men worked to rebuild the wall. Half of it was built when Sanballat and Tobiah became angry and conspired to attack. Israelites made their prayer to God. Nehemiah set half the men to the construction and the other half behind the walls with weapons ready to fight against their enemies.

4. The people complained among one another about famine and taxes. Nehemiah worked with the people to help them get along and also helped to feed them by allowing them to eat at his table. He fed as many as 150 Jews, again praying to God to remember him and the work he was there to do.

5. The wall was almost complete and this greatly displeased Sanballat and Tobiah. They falsely accused Nehemiah of rebelling and desiring to be king. They conspired to kill him. Nehemiah uncovered their plan and again prayed to God for his guidance. When the wall was finished all the enemies were disheartened for all could see this work was blessed by God. The wall was finished in 52 days. Nehemiah looked to God to do this work and God was with him.

# The Cupbearer

Solve the puzzle by writing in the SECOND letter of the picture in each square. Then write the words from the puzzle in the paragraph so it makes sense.

\_\_\_\_\_ was a  
 \_\_\_\_\_ for the  
 \_\_\_\_\_ of Persia. It was  
 his duty to \_\_\_\_\_ all  
 the king's \_\_\_\_\_  
 and drink to make sure it had  
 not been \_\_\_\_\_.

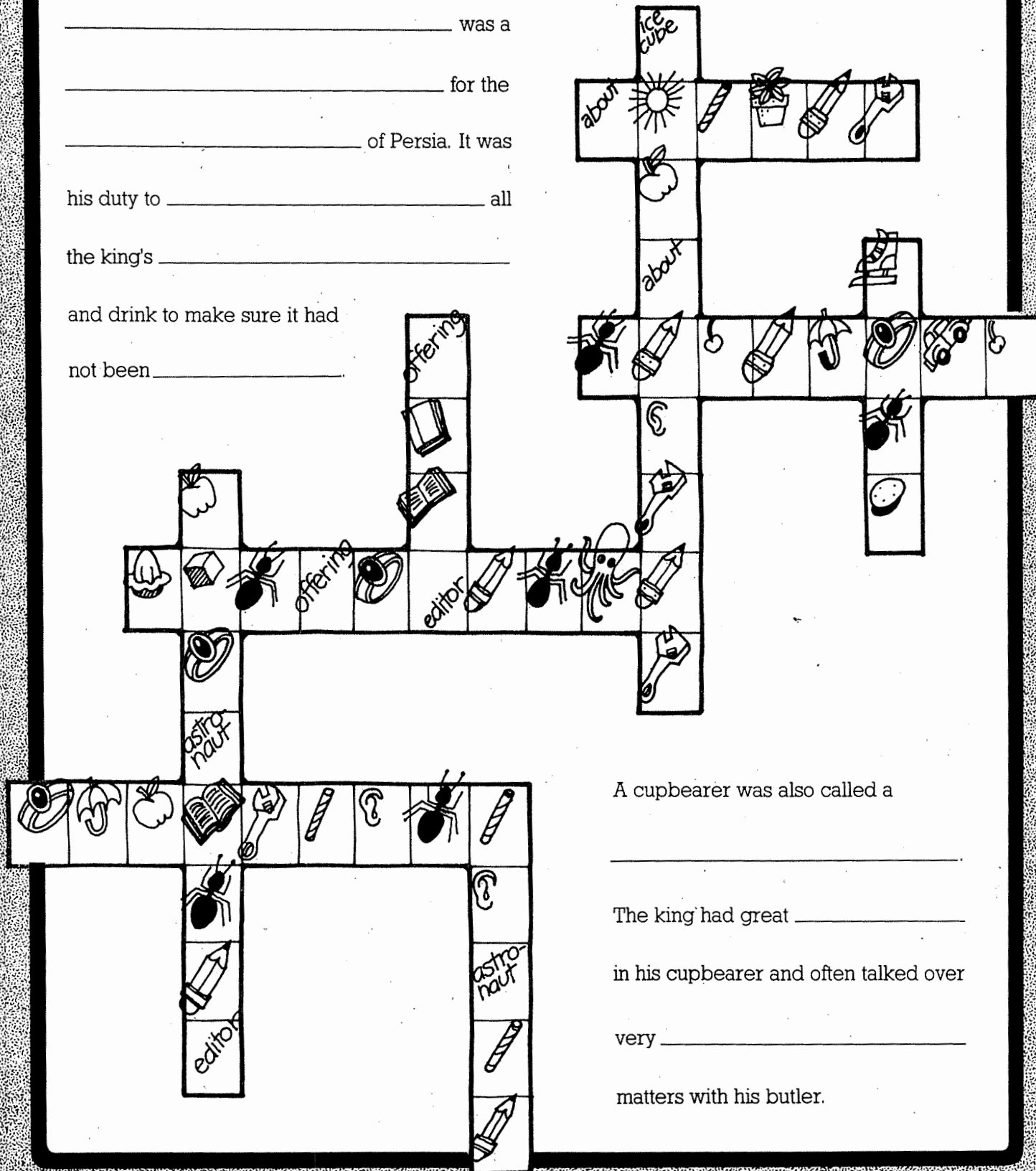

A cupbearer was also called a

The king had great \_\_\_\_\_

in his cupbearer and often talked over

very \_\_\_\_\_

matters with his butler.

# NEHEMIAH'S PRAYER & VIEWING THE WALL

(NEHEMIAH 1:1-2:20)



"O Lord, I pray, please let Your ear be attentive to the prayer of Your servant, and to the prayer of Your servants who desire to fear Your name." **NEHEMIAH 1:11**

# NEHEMIAH'S PRAYER & VIEWING THE WALL

(NEHEMIAH 1:1-2:20)

S L L A W V G O D U O O N D D  
 L G A N H Q S L G R R J B O I  
 M N K P G D H L I J I N U F P  
 S I I M H M P N C Z Y V L M M  
 O K Y N A D E N N F S G Y Q W  
 A L T Q I D P L D E N R U B L  
 L S F Q M V R Z A N Y W L R G  
 K V Z H E F S S E S D H H K S  
 N S A D H R A K P J U D V S Z  
 M P B V E V O S E R L R E D R  
 G Z C T N R B V T I A T E F O  
 G S T Z B D N M U I A Y K J J  
 T E S U U W G B B G N H I H L  
 L M L D Q R E O P F Y G K N L  
 E B S F J R B N U E B B M L G

BROKEN  
 BURNED  
 FASTING  
 GATES  
 GOD

JERUSALEM  
 KING  
 LETTERS  
 NEHEMIAH

PRAYING  
 REBUILD  
 SAD  
 WALLS

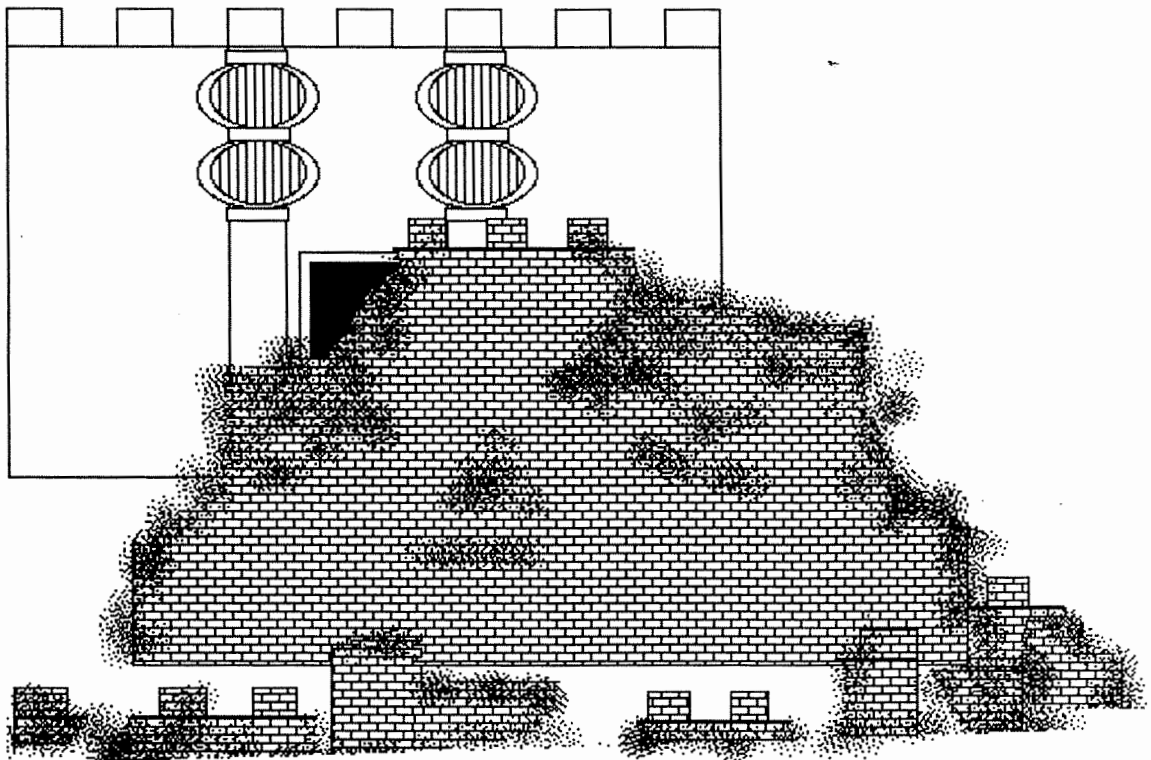



# NEHEMIAH'S PRAYER & VIEWING THE WALL

## (NEHEMIAH 1:1-2:20)

### MEMORY VERSE:

"O Lord, I pray, please let Your ear be attentive to the prayer of Your servant, and to the prayer of Your servants who desire to fear Your name." NEHEMIAH 1:11

### TRUE OR FALSE:

1. Nehemiah asked about "the Jews who had escaped, who had survived the captivity, and concerning Jerusalem." NEHEMIAH 1:2

TRUE OR FALSE

2. And they said to him, "All is well with the survivors. The walls of Jerusalem are tall, and the gates are strong." NEHEMIAH 1:3

TRUE OR FALSE

### FILL IN THE BLANKS:

3. Nehemiah said, "So it was, when I heard these words, that I sat down and wept, and mourned for many days; I was \_\_\_\_\_ and \_\_\_\_\_ before the God of heaven." NEHEMIAH 1:4

### TRUE OR FALSE:

4. Nehemiah was the king's cupbearer. NEHEMIAH 1:11

TRUE OR FALSE

### FILL IN THE BLANKS:

5. "The king said to me, 'Why is your face \_\_\_\_\_, since you are not sick? This is nothing but sorrow of heart.' Then I became dreadfully afraid, and said to the king, 'May the king live forever! Why should my face not be \_\_\_\_\_, when the city, the place of my fathers' tombs, lies waste, and its gates are burned with fire?' " NEHEMIAH 2:2-3

6. "Then the king said to me, 'What do you request?' So I \_\_\_\_\_ to the God of heaven. And I said to the king, 'If it pleases the king, and if your servant has found favor in your sight, I ask that you send me to Judah, to the city of my fathers' tombs, that I might \_\_\_\_\_ it.' " NEHEMIAH 2:4-5

7. "Furthermore I said to the king, 'If it pleases the king, let \_\_\_\_\_ be given to me for the governors of the region beyond the River, that they must permit me to pass through till I come to Judah, and a letter to Asaph the keeper of the king's forest, that he must give me \_\_\_\_\_ to make beams for the gates of the citadel which pertains to the temple, for the city wall, and for the house that I will occupy.' " NEHEMIAH 2:7-8

### TRUE OR FALSE:

8. Nehemiah writes, "So I came to Jerusalem and was there three days." NEHEMIAH 2:11

TRUE OR FALSE

9. He writes, "I went out by night through the Valley Gate to the Serpent Well and the Refuse Gate, and viewed the walls of Jerusalem which were broken down and its gates which were burned with fire." NEHEMIAH 2:14

TRUE OR FALSE

### FILL IN THE BLANKS:

10. Nehemiah told the officials "of the hand of my God which had been good upon me, and also of the king's words that he had spoken to me. So they said, 'Let us rise up and build.' Then they set their \_\_\_\_\_ to do this good \_\_\_\_\_." NEHEMIAH 2:18

# The King Helps His Friend

Read the picture story below to find out how King Artaxerxes helped his friend, Nehemiah.

The  said to , "Why are you ?"

 said to the , "I am  because



the  where my ancestors are  lies in ruins.





Its  have been destroyed by .

The  said, "What do you want?"

 said, "Send me to the  in Judah where my

ancestors are . I will rebuild it."

So the  wrote  for safe passage and gave

  for the  of the  wall.

# NEHEMIAH REBUILDS THE WALLS

Nehemiah 1-8

Trace over the dotted lines to finish this picture.

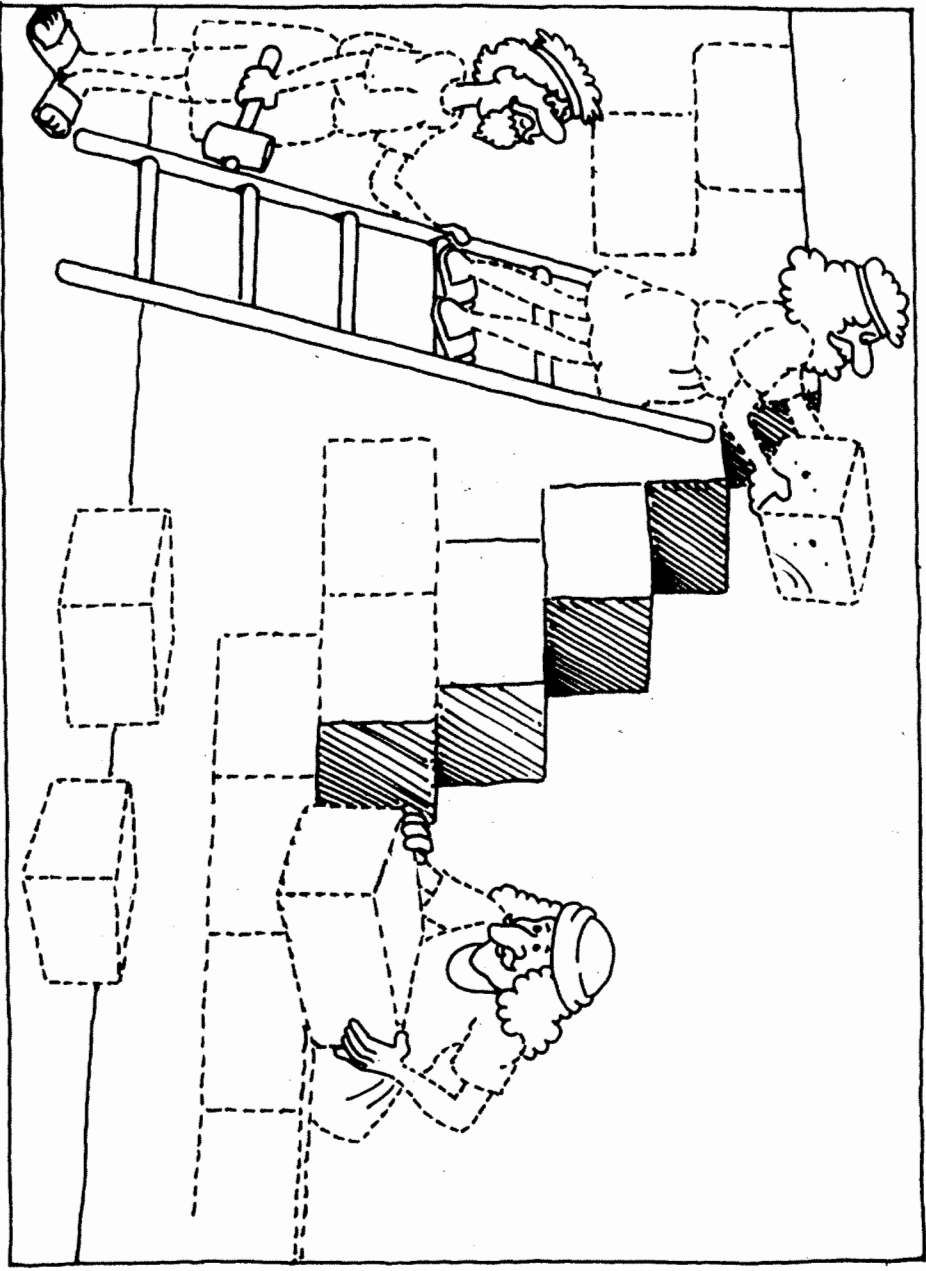

Nehemiah was the cupbearer to the king of Persia. He was upset that the walls around the city of Jerusalem were falling down. Nehemiah led a group of workers to rebuild the walls so the city would be safe from it's enemies.

# Construction Site

How did the Israelites rebuild the city wall? To find out, look at the wall below. For each white brick, find the brick that exactly matches it in the code key. Write the letter in the matching blank brick. Read Nehemiah 6:15, 16 if you need help.

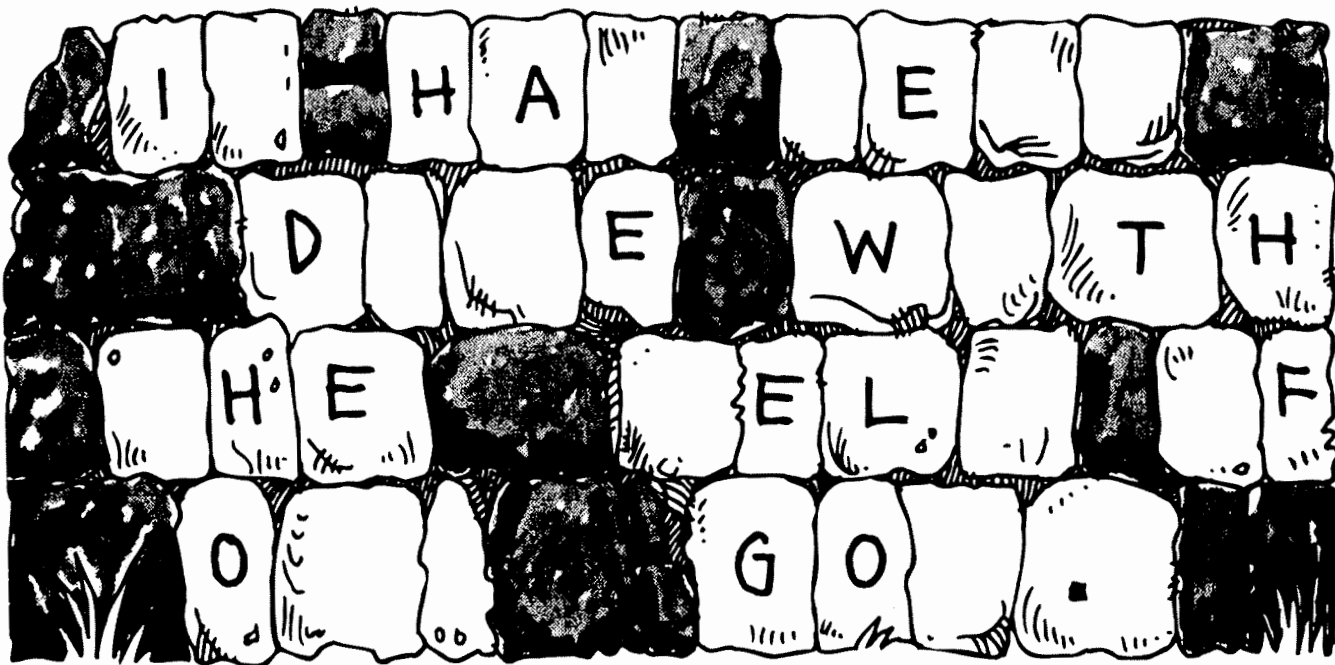
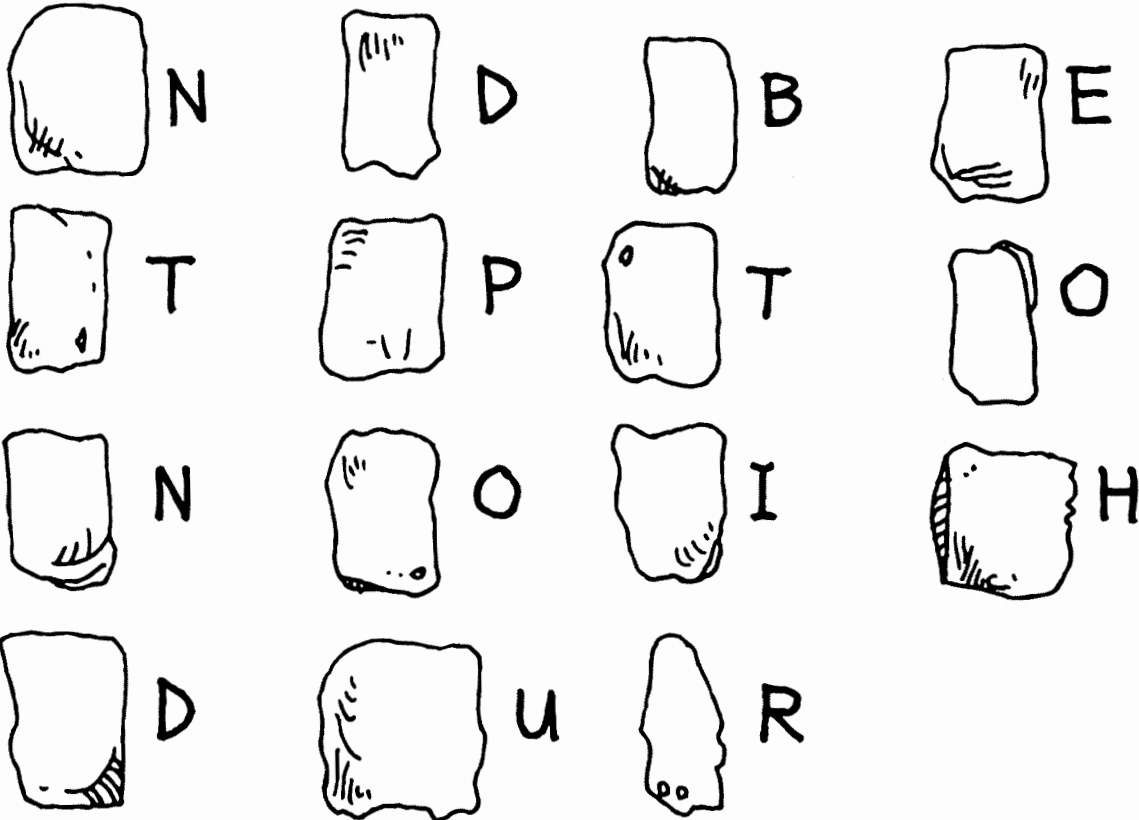

BibleWise

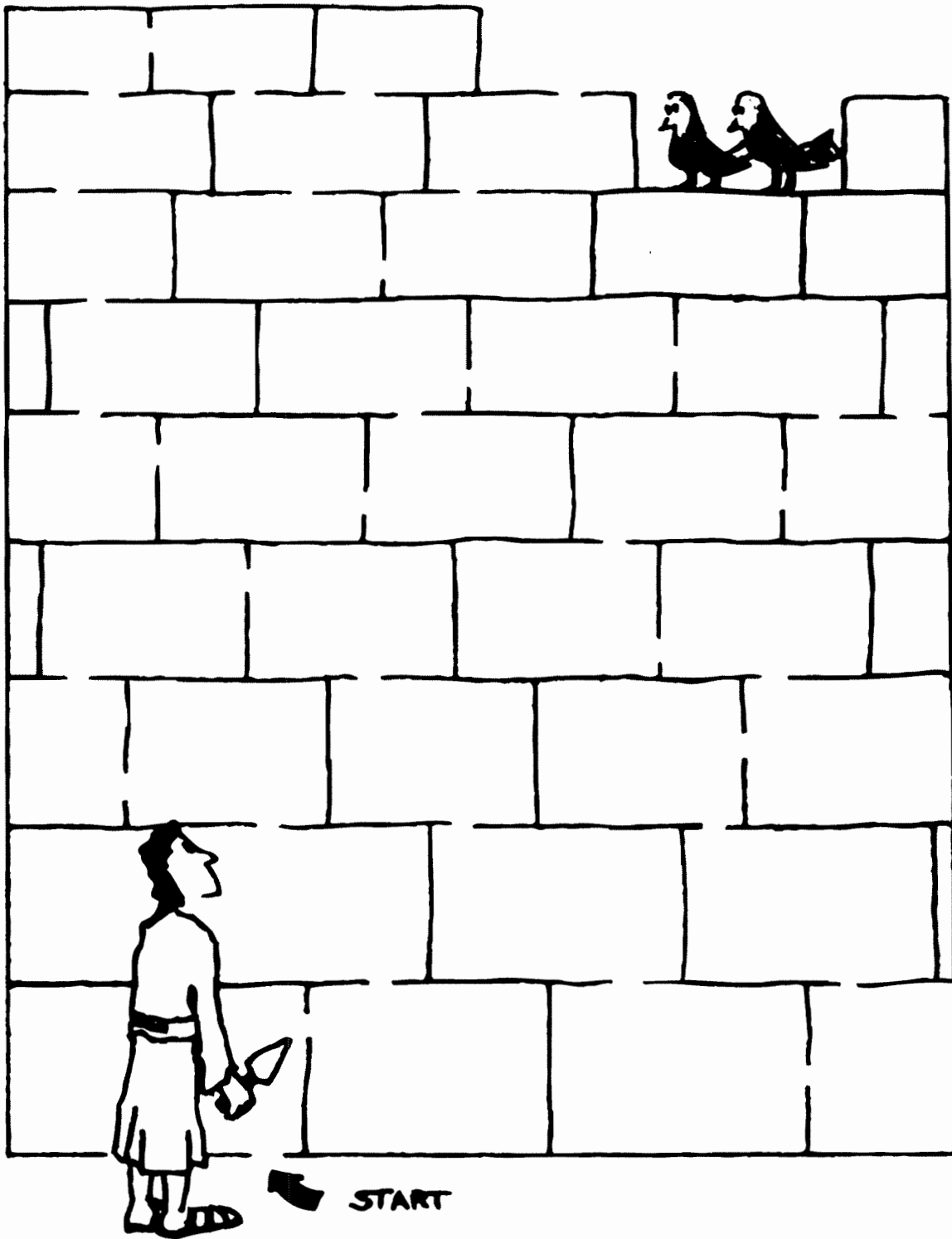

Taken from Amazing Mazes for Kids by Steve and Becky Miller, copyright© 1998 and published by Harvest House Publishers, Eugene, OR. Used by permission.

# THE REBUILDING & COMPLETION OF THE WALL

## (NEHEMIAH 4:1-7:3)

N E H E M I A H N W W O O Y J  
 H W J V D J I B B K H Q H E E  
 F G J D I H L V L Y J A R Q P  
 Q D E H S I N I F Y T U C B G  
 M M S I V N D Q L E S E O G T  
 H W A M E F S O D A R G N O E  
 R D N O M G U V L K V W S J P  
 E I B O N I J E C H A A T M M  
 Y C A F B E M A N L J T R N U  
 A P L U A G T Y L L D N U R R  
 R L L S S T N A V R E S C M T  
 P O A R A W L X K B U B T I G  
 M P T O S T L I U B V K I F L  
 G D C O Z K J C A R C L O J Y  
 Q Q N D W O T J U O G D N Q T

ATTACK	FINISHED	SANBALLAT
BUILT	JERUSALEM	SERVANTS
CONSTRUCTION	NEHEMIAH	TRUMPET
DOORS	PRAYER	WALL

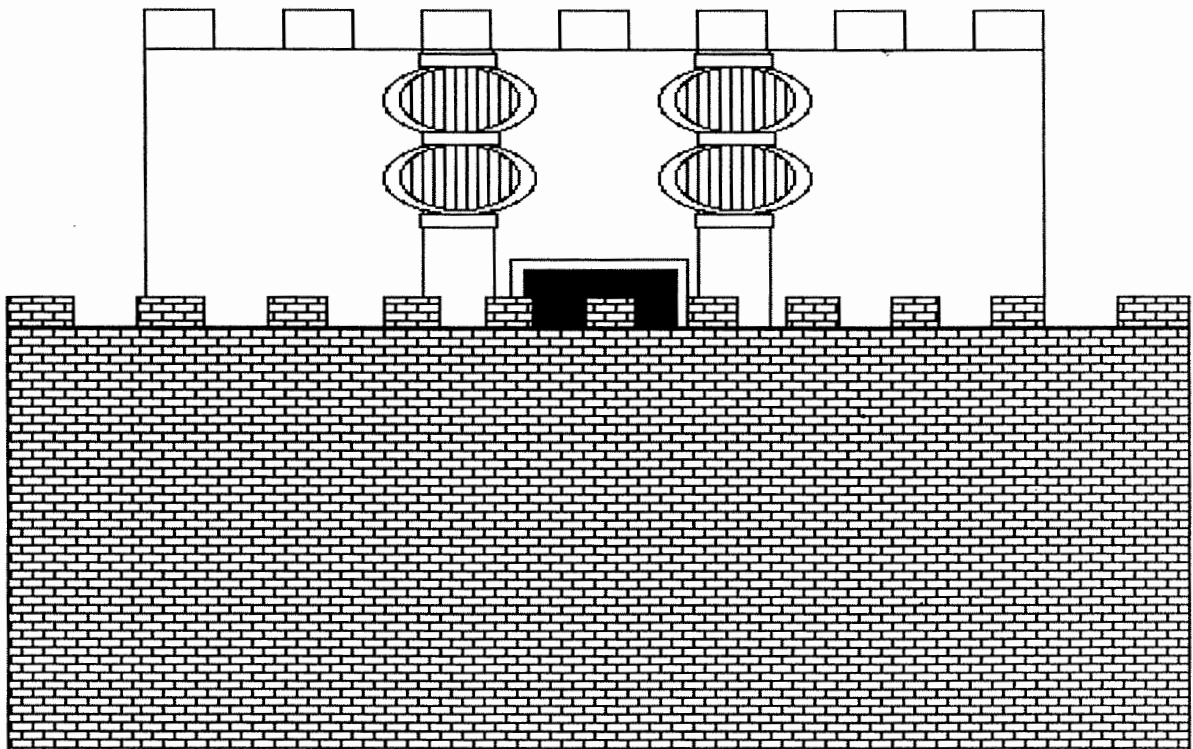

# THE REBUILDING & COMPLETION OF THE WALL

## (NEHEMIAH 4:1-7:3)

A C H H K R I H N L L C V O R L P Q X N  
 L M G P O C Y B S E R V A N T S L T L T  
 S S M P N J A M D D L O M X Q I O H M V  
 V L U O G Z S T O I A Y G M C B E E E B  
 P S Q R N F Y B T P G K D G I V P N J K  
 Z N J B I I D N F A H E O A R V K P S C  
 S P V N C J T U O S G O H Q H T S A L E  
 M M Q G N T Y E E I N J T O N L N T D U  
 D O O R S F E T S M T S C T N B N L Z Z  
 B N D B E E I P M W W C W H A C U Z P B  
 A Q D L B D B E M L B Z U L V M W T E E  
 K Q D L O O L L M U W F L R G G S T B Q  
 I H V D P A O Y Q G R A I K T P C X L A  
 Y V H N S T J L R S T T V N R S T S I L  
 T S V U U L C H K S B N N A I K N M A B  
 A Z R X W I V M B Z V W Y W R S P O I F  
 F E D Z A U G A D R B E V W K M H H C H  
 J U K S L B R K F O R I M X Z P M E R V  
 Z D M V L A W K H J H O U L L E S V D E  
 B F S M U R H N E H E M I A H I D Y O L

AMMONITES  
 ARABS  
 ASHDODITES  
 ATTACK  
 BUILT  
 CONSTRUCTION

DOORS  
 FINISHED  
 JERUSALEM  
 NEHEMIAH  
 PRAYER

SANBALLAT  
 SERVANTS  
 TOBIAH  
 TRUMPET  
 WALL

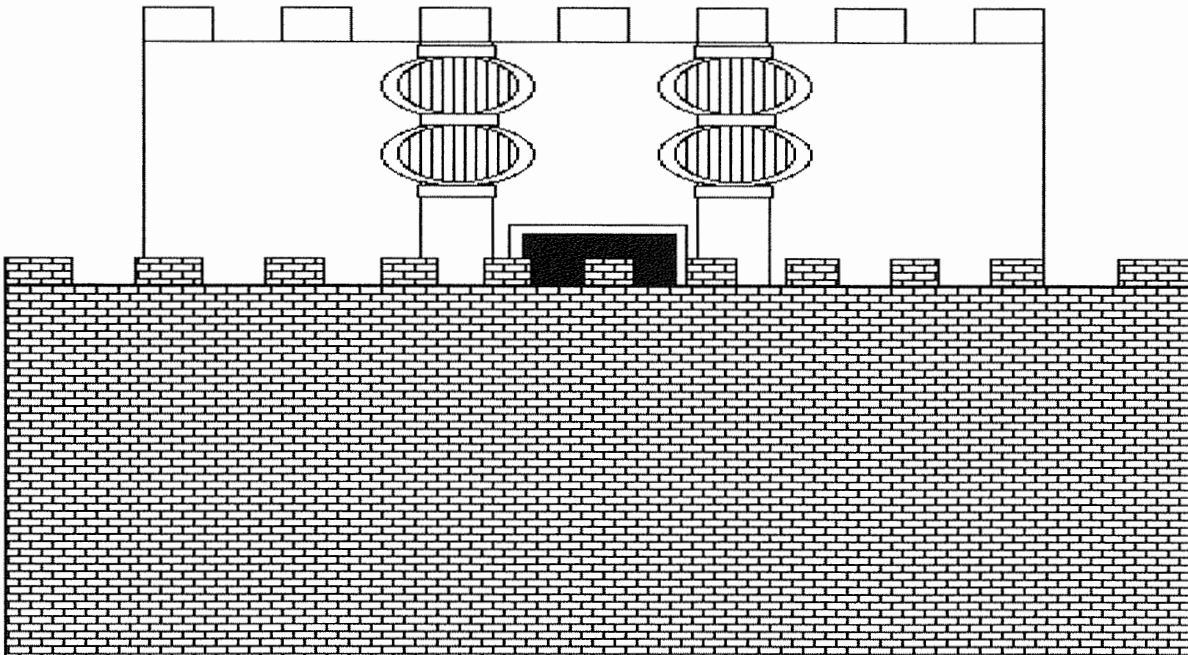

# THE REBUILDING & COMPLETION OF THE WALL (NEHEMIAH 4:1-7:3)

## MEMORY VERSE:

"Our God will fight for us." NEHEMIAH 4:20

## TRUE OR FALSE:

1. "When Sanballat heard that we were rebuilding the wall, that he was furious and very indignant, and mocked the Jews." NEHEMIAH 4:1

TRUE OR FALSE

## UNDERLINE THE CORRECT ANSWER:

2. "So we built the wall, and the entire wall was joined together up to half its height..." NEHEMIAH 4:6  
a. for the people had a mind to work  
b. for the pay was great

## FILL IN THE BLANKS:

3. "Now it happened, when Sanballat, Tobiah, the Arabs, the Ammonites, and the Ashdodites heard that the walls of Jerusalem were being restored and the gaps were beginning to be closed, that they became very \_\_\_\_\_, and all of them conspired together to come and \_\_\_\_\_ Jerusalem and create confusion." NEHEMIAH 4:7-8
4. "Nevertheless we made our \_\_\_\_\_ to our God, and because of them, we set a watch against them day and night." NEHEMIAH 4:9

## TRUE OR FALSE:

5. Nehemiah writes, "half of my servants worked at construction, while the other half held the spears, the shields, the bows, and wore armor; and the leaders were behind all the house of Judah." NEHEMIAH 4:16

TRUE OR FALSE

## FILL IN THE BLANKS:

6. "Those who built on the wall, and those who carried burdens, loaded themselves so that with one hand they worked a \_\_\_\_\_, and with the other held a \_\_\_\_\_." NEHEMIAH 4:17
7. "Then I said to the nobles, the rulers, and the rest of the people, 'The work is great and extensive, and we are separated far from one another on the wall. Therefore, wherever you hear the sound of the \_\_\_\_\_, rally to us there. Our God will fight for us.'" NEHEMIAH 4:19-20
8. "So the wall was \_\_\_\_\_ on the twenty-fifth day of the month of Elul, in fifty-two days." NEHEMIAH 6:15
9. "Then it was, when the wall was built and I had hung the doors, when the gatekeepers, the singers, and the Levites had been appointed, that I gave charge of \_\_\_\_\_ to my brother Hanani, and Hananiah the leader of the citadel." NEHEMIAH 7:1-2

## TRUE OR FALSE:

10. When the seventh month came, the children of Israel were not in their cities. NEHEMIAH 7:73

TRUE OR FALSE



## Matching the Kings

Match which king belongs to the event or information about him. This may not be an easy run for younger children, but pull out the kings they would be familiar with. The Bible reference will help you get the answer.

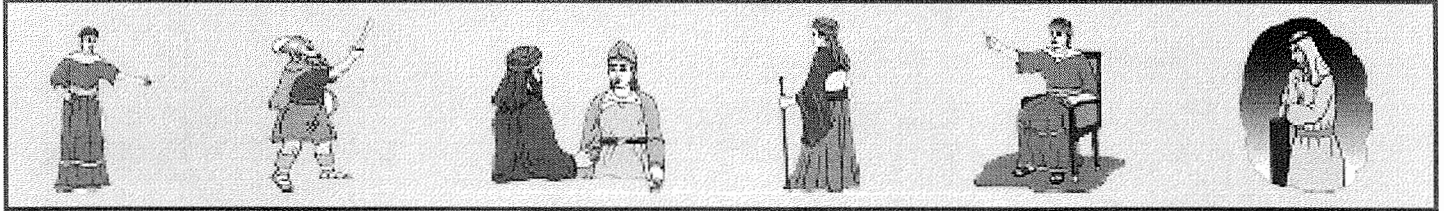

### Event or Information

- \_\_\_ 1. He was 8 years old when he became King (II Kings 22:1)
- \_\_\_ 2. He married Jezebel (I Kings 16:30-31)
- \_\_\_ 3. He was known for his wisdom (I Kings 3)
- \_\_\_ 4. He slew Goliath before he became King (I Samuel 17)
- \_\_\_ 5. He was a terrible king with the longest reign (II Chron. 33:1)
- \_\_\_ 6. He had the shortest reign - 7 days (I Kings 16:15)
- \_\_\_ 7. He put Daniel in with the lions (Daniel 6)
- \_\_\_ 8. He was married to Esther (Esther 7:5)
- \_\_\_ 9. He was the youngest King (II Chron 24:1)
- \_\_\_ 10. He was the first king of Israel at the divided kingdom (I Kings 14:20)
- \_\_\_ 11. He threw the Hebrew boys into a fiery furnace.
- \_\_\_ 12. He asked for the sun to move backwards ten degrees. (II Kings 20:9-11)
- \_\_\_ 13. Nehemiah asked this King if he could return to Jerusalem to rebuild the walls. (Nehemiah 2:1)
- \_\_\_ 14. He was the first king of Judah (I Kings 12:17)
- \_\_\_ 15. He tried to kill David, and sought help from a familiar spirit. (I Samuel 28:7)

### Kings

- A. David
- B. Darius
- C. Joash
- D. Zimri
- E. Saul
- F. Solomon
- G. Josiah
- H. Manasseh
- I. Nebuchadnezzar
- J. Rehoboam
- K. Hezekiah
- L. Jeroboam
- M. Ahab
- N. Ahasuerus
- O. Artaxerxes

Match the name of the person with the description.  
One name will be used twice

- |                                                                               |            |
|-------------------------------------------------------------------------------|------------|
| A prophet God used to tell of the return to Canaan.                           | Ezra       |
| A king who allowed captives to return from Persia to Jerusalem.               | Malachi    |
| A man who led people back to Jerusalem and rebuilt the altar.                 | Cyrus      |
| A man who led people back to Jerusalem and encouraged them to obey God's law. | Jeremiah   |
| A man who led people back to Jerusalem and rebuilt the city wall.             | Zerubbabal |
| A prophet who promised God's law would be written on peoples's hearts.        | Nehemiah   |
| A prophet who promised the coming of the Lord.                                |            |

## Year 3

### Week 113                      Ezra Reads the Law/Wall is Dedicated

*Nehemiah*

**Scriptures: Ezra 8 - 13**

**Key Verse: Nehemiah 13:11** ‘So I contended with the rulers and said “Why is the house of God forsaken?” and I gathered them together and set them in their place’.

#### **Key Points:**

**1.** The children of Israel were living in their cities. All the people gathered together in the open square in Jerusalem. Ezra, the priest and scribe, brought the book of the Law of Moses. Ezra stood on a wooden platform and all the people stood up as he opened the book. Ezra read from the book and the people worshiped God. Ezra, Nehemiah and the Levites taught the people and helped them understand the reading.

**2.** On the next day they assembled again. Ezra read from the book again, teaching about the feast of Tabernacles. They learned they were to be living in “booths” during the feast so they made booths from tree branches and lived in them for the seven days of the feast. During the days of the reading and feast, the children of Israel realized how far they had strayed from God and His laws. As well as not keeping feasts and ceremonies, they had also taken foreign wives and worshiped idols.

**3.** The children of Israel held a special assembly, fasting in sackcloth with ashes on their head. They stood, confessing their sins, and worshiped the Lord. Everyone who understood, separated themselves to God and away from pagan rituals and idol worship. They all joined together with the Levites and priests and sealed a covenant with God.

**4.** Nehemiah dedicated the wall. They celebrated the dedication with singing, thanksgiving, and with cymbals and harps. The priests and Levites purified themselves, the people, the gates and the wall. They offered great sacrifices and rejoiced so that the joy could be heard from afar.

**5.** Nehemiah leaves to serve the king. He comes back and finds the children of Israel were again in sin. He goes about the work of setting things right again.

# EZRA READS THE LAW

## (NEHEMIAH 8:1-9:5)

W O R S H I P E D L O R D N O  
 K R C A T G P L N S G T K P V  
 Y O G P Y O E E Y T F Z E P B  
 Y D E S S E F N O C I N B F N  
 E W S E Q B P Y W P S V O H G  
 H W A G E J O T C Q L K O J N  
 D H C A T M G O U O Y E K K I  
 E J K T A N G A T Y M B O Z T  
 S S C N G R R P N H R M F W S  
 S R L B R E S V R E S S T W A  
 E V O K E M C E G Z A H H V F  
 L J T L T I R N I R U J E H G  
 B D H D A F I J K A V L L W P  
 L U O O W J B A F T W M A S E  
 B V Q H K Q E H T T A B W R I

BLESSED  
 BOOK OF THE LAW  
 BOOTHS  
 CONFESSED  
 EZRA

FASTING  
 LORD  
 OPEN SQUARE  
 PEOPLE  
 SACKCLOTH

SCRIBE  
 WATER GATE  
 WEPT  
 WORSHIPED

ENTER ↓

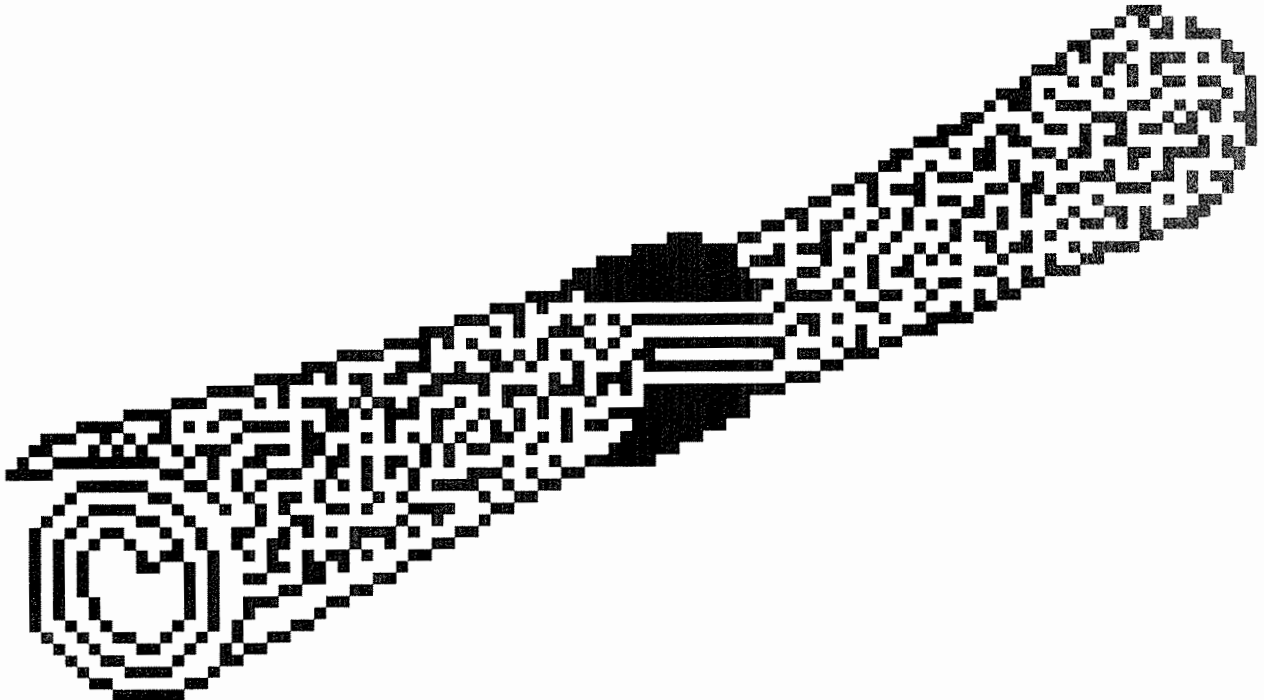

# EZRA READS THE LAW

(NEHEMIAH 8:1-9:5)



“And Ezra opened the book in the sight of all the people; (for he was above all the people;) and when he opened it, all the people stood up: and Ezra blessed the LORD, the great God. And all the people answered, Amen, Amen, with lifting up their hands: and they bowed their heads, and worshipped the LORD with *their* faces to the ground.”

**NEHEMIAH 8:5-6**

# EZRA READS THE LAW

## (NEHEMIAH 8:1-9:5)

### MEMORY VERSE:

*"Stand up and bless the LORD your God forever and ever! Blessed be Your glorious name, which is exalted above all blessing and praise!" NEHEMIAH 9:5*

### FILL IN THE BLANK:

1. "Now all the people gathered together as one man in the open square that was in front of the Water Gate; and they told \_\_\_\_\_ the scribe to bring the Book of the Law of Moses, which the LORD had commanded Israel."  
**NEHEMIAH 8:1**

### TRUE OR FALSE:

2. "And Ezra opened the book in the sight of all the people, for he was standing above all the people; and when he opened it, all the people stood up." **NEHEMIAH 8:5**

**TRUE OR FALSE**

### FILL IN THE BLANKS:

3. "And Ezra \_\_\_\_\_ the LORD, the great God. Then all the people answered, 'Amen, Amen!' while lifting up their hands. And they bowed their heads and worshiped the LORD with their faces to the ground." **NEHEMIAH 8:6**
4. "They read distinctly from the book, in the Law of God; and they gave the sense, and helped them to \_\_\_\_\_ the reading." **NEHEMIAH 8:8**
5. "And Nehemiah, who was the governor, Ezra the priest and scribe, and the Levites who taught the people said to all the people, 'This day is holy to the LORD your God; do not mourn nor weep.' For all the people \_\_\_\_\_, when they heard the words of the Law." **NEHEMIAH 8:9**
6. "Then he said to them, 'Go your way, eat the fat, drink the sweet, and send portions to those for whom nothing is prepared; for this day is holy to our LORD. Do not sorrow, for the joy of the \_\_\_\_\_ is your strength.'" **NEHEMIAH 8:10**
7. "They found written in the Law, which the LORD had commanded by Moses, that the children of Israel should dwell in \_\_\_\_\_ during the feast of the seventh month." **NEHEMIAH 8:14**

### TRUE OR FALSE:

8. But the people said, "We will not dwell in booths!" **NEHEMIAH 8:16**
- TRUE OR FALSE**
9. "The whole congregation of those who had returned from the captivity made booths and sat under the booths."  
**NEHEMIAH 8:17**
- TRUE OR FALSE**
10. "Also day by day, from the first day until the last day, he read from the Book of the Law of God."  
**NEHEMIAH 8:18**

**TRUE OR FALSE**

### FILL IN THE BLANK:

11. "Now on the twenty-fourth day of this month the children of Israel were assembled with fasting, in sackcloth, and with dust on their heads. Then those of the Israelite lineage separated themselves \_\_\_\_\_ from all foreigners; and they stood and \_\_\_\_\_ their sins and the iniquities of their fathers." **NEHEMIAH 9:1-2**

# EZRA READS THE LAW

## (NEHEMIAH 8:1-9:5)

G V C I N A O U J Q K P T H M Z O N D B  
 D D A C D L N U T U B Y O K Q O I I Y H  
 P D L T R B H T A O P E N S Q U A R E J  
 K Z D C B Z H T A Q C F M K N A R S S Y  
 S Z O E A O I T O T D O J G N I T S A F  
 P O Z J P Z O D U L W J K R Y B F V M N  
 P W M W Z I U K E H C W G E M N Y M N P  
 R H F Y E N H D O T K K H N A N B N B G  
 X Q M J B K A S D F I S C C S L D A S N  
 O I Q T S O F Q R E T S D A V D F D E G  
 S W S N M C O C N O S H G E S L B D J P  
 L L A A D O R T Q T W S E V S U E W M S  
 K H Q T W B F I H R E I E L Y S N T G O  
 W T V S E H T M B S P A D F A F E L O T  
 V Y P L T R Q J N E I G V C N W T L V W  
 J O B P Q F G K N R Y W B C K O L A B I  
 X A E P X A H A A W B A G D W L C O S H  
 W W Q U I V R S T P B F R H L Y U A P J  
 E P E O P L E Z Y E P O C R W H W P T D  
 L V J T T I A M E N L U Z E W X Q A W U

**BLESSED**  
**BOOK OF THE LAW**  
**BOOTHS**  
**CONFESSED**  
**EZRA**

**FASTING**  
**LORD**  
**OPEN SQUARE**  
**PEOPLE**  
**SACKCLOTH**

**SCRIBE**  
**WATER GATE**  
**WEPT**  
**WORSHIPED**

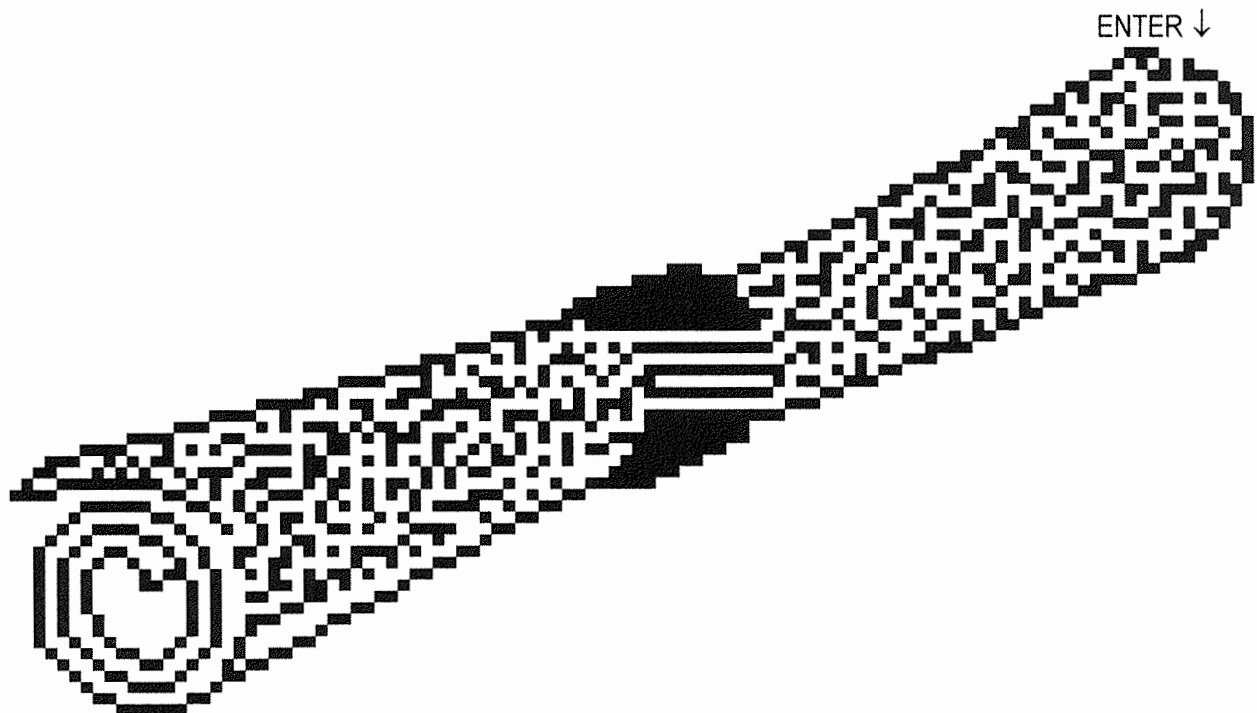

Bible for Children  
presents

# THE GREAT WALL OF NEHEMIAH

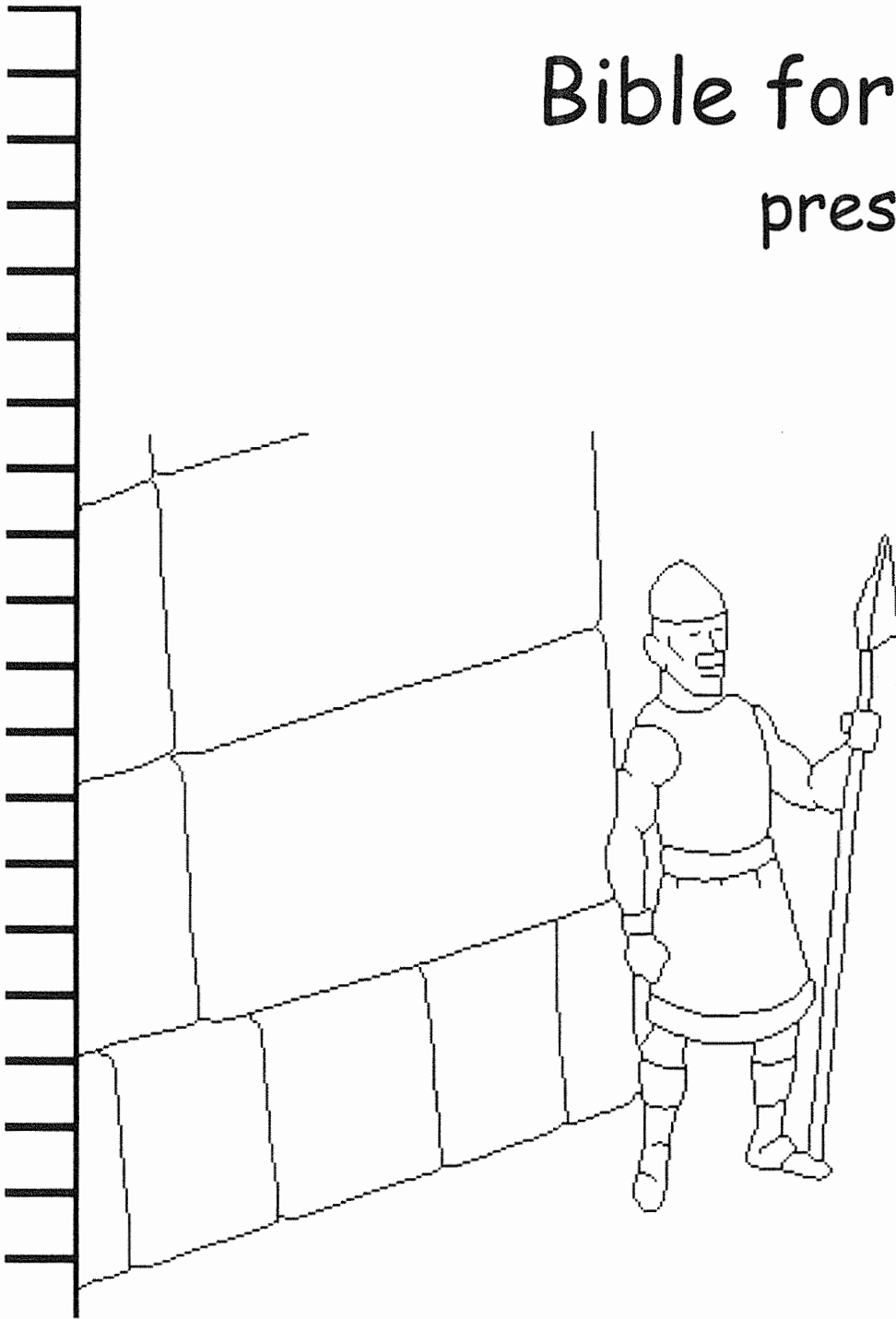



Written by: Edward Hughes  
Illustrated by: Jonathan Hay  
Adapted by: Mary-Anne S.  
Produced by: Bible for Children  
[www.M1914.org](http://www.M1914.org)

BFC  
PO Box 3  
Winnipeg, MB R3C 2G1  
Canada

©2007 Bible for Children, Inc.  
License: You have the right to copy or print this story,  
as long as you do not sell it.



Persia, a powerful nation, ruled the world. And King Artaxerxes ruled Persia. That made him the world's mightiest ruler. One of the king's important helpers was a Jewish man named Nehemiah. His job was to taste the king's food to protect the king from possible poisoning.

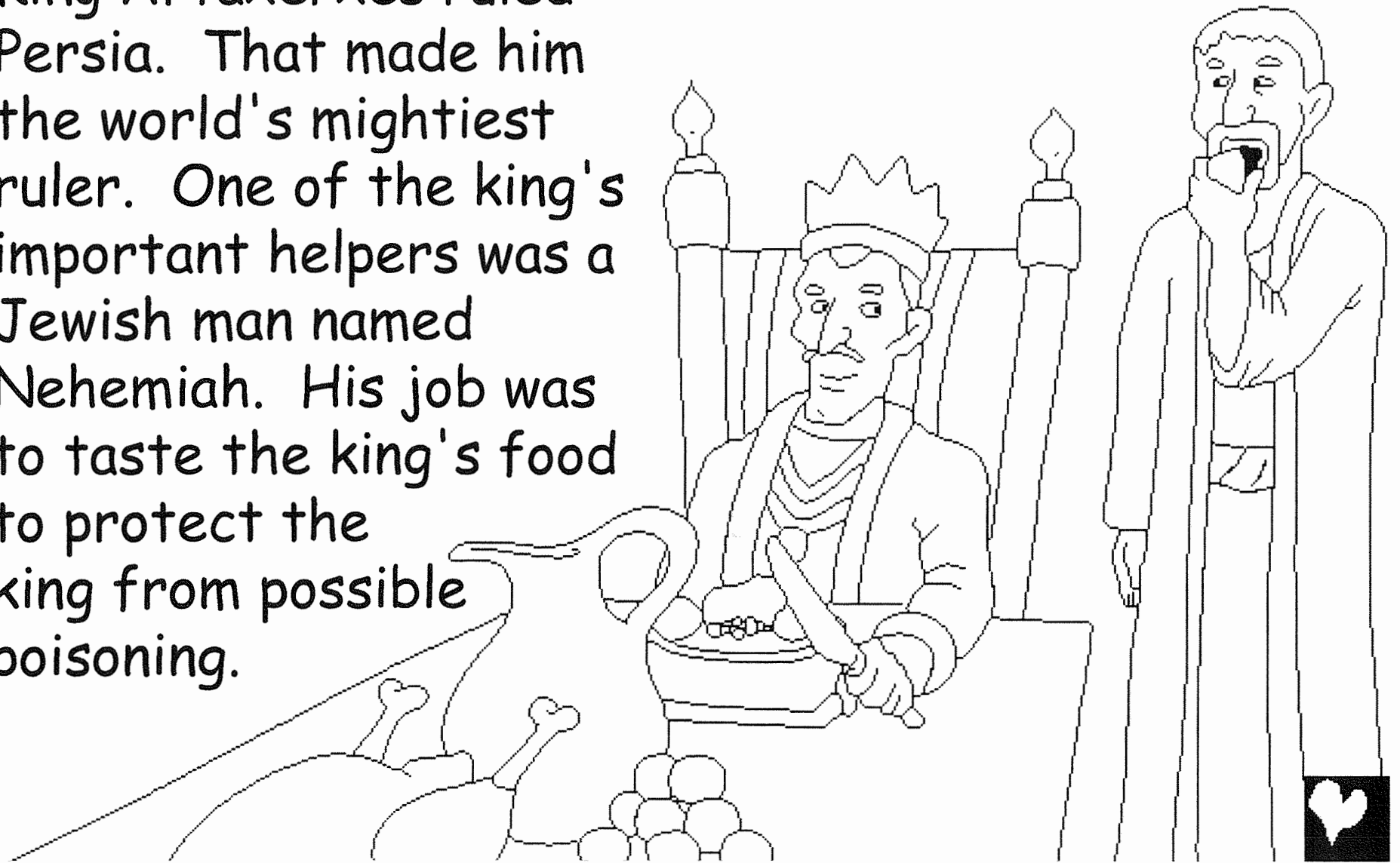

One day, Nehemiah came before the king with a very sad face. The king wanted to know what was wrong. "O king, may you live forever," Nehemiah said. "I'm sad because the city where my fathers are buried is in ruins and the gates have been burned." Nehemiah was talking about Jerusalem, which had been destroyed by war many years before.



King Artaxerxes asked, "What is it you would like?"  
"Let me go to Jerusalem so I can rebuild it,"  
Nehemiah pleaded. King Artaxerxes kindly agreed.  
He also gave Nehemiah official letters to protect  
him as he traveled.



The king helped even more. He gave Nehemiah a letter for Asaph, the keeper of the king's forests. Asaph was ordered to provide as much timber as Nehemiah asked for to build the city walls.

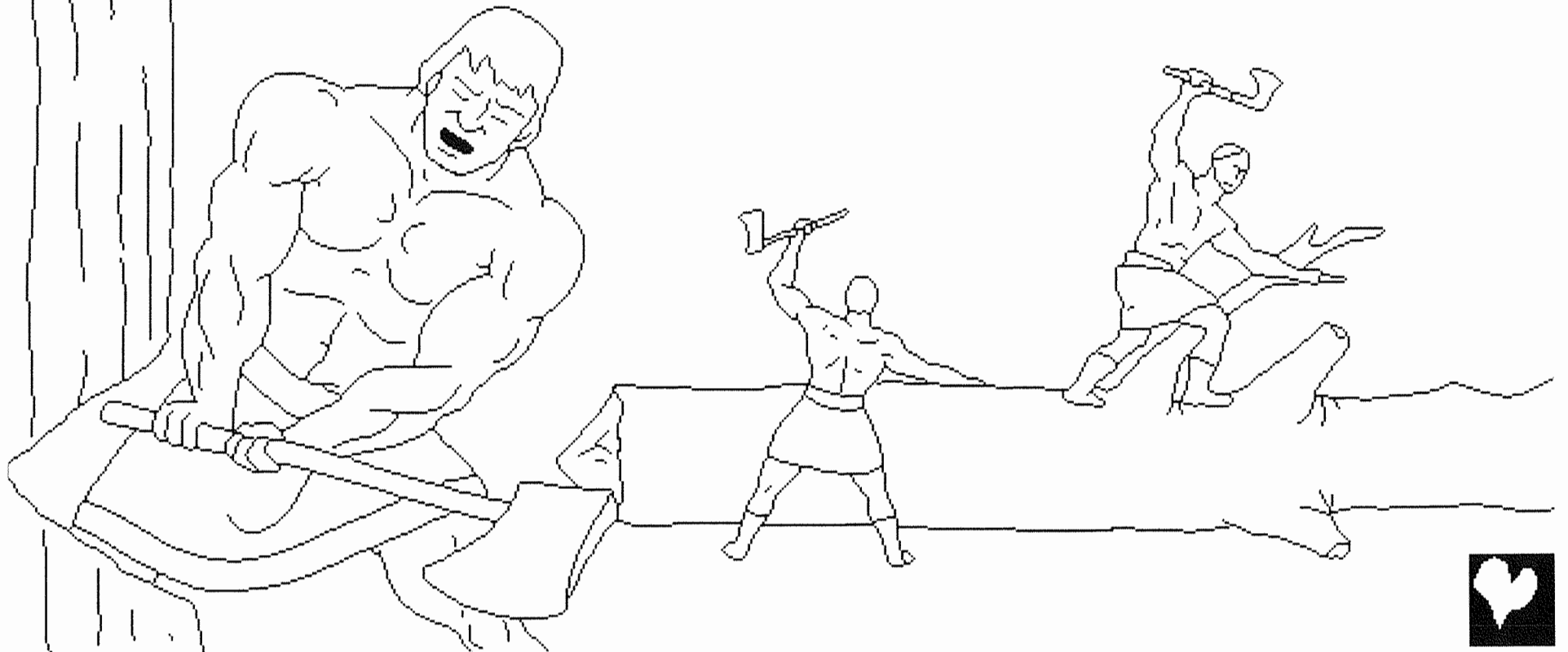

When Nehemiah arrived in Jerusalem, he gathered the city officials and said, "We're in trouble here. The city is in ruins and the gates are burned. Let's start rebuilding." He told them that King Artaxerxes approved and, most important of all, God was on their side.



Nehemiah's faith and enthusiasm must have inspired the people. They agreed, saying, "Let's rebuild." Nehemiah told each family which piece of the wall they should fix.



But, not everybody agreed to rebuild the wall. A man named Sanballat, and his two friends Tobiah and Geshem, were not Jewish and they didn't want the wall rebuilt or the gates fixed.





As the work went on, Sanballat became very angry. He and his friends mocked the Jews. Tobiah said, "When they're finished building that puny wall, one little fox will make it crumble." Nehemiah didn't answer. Instead, he prayed that God would deal with them.



When their mocking insults didn't have any effect, they plotted together to fight against Jerusalem and cause as much trouble as they could. Again, Nehemiah prayed for God's help. He also placed a guard day and night so they wouldn't be taken by surprise.



The Jews worked so hard, they were getting weary. Some became afraid that the enemy would come and kill them while they were working. Still, Nehemiah wouldn't stop the project. He put guards around the workers and reminded them that God was on their side and God is more powerful than any enemy!

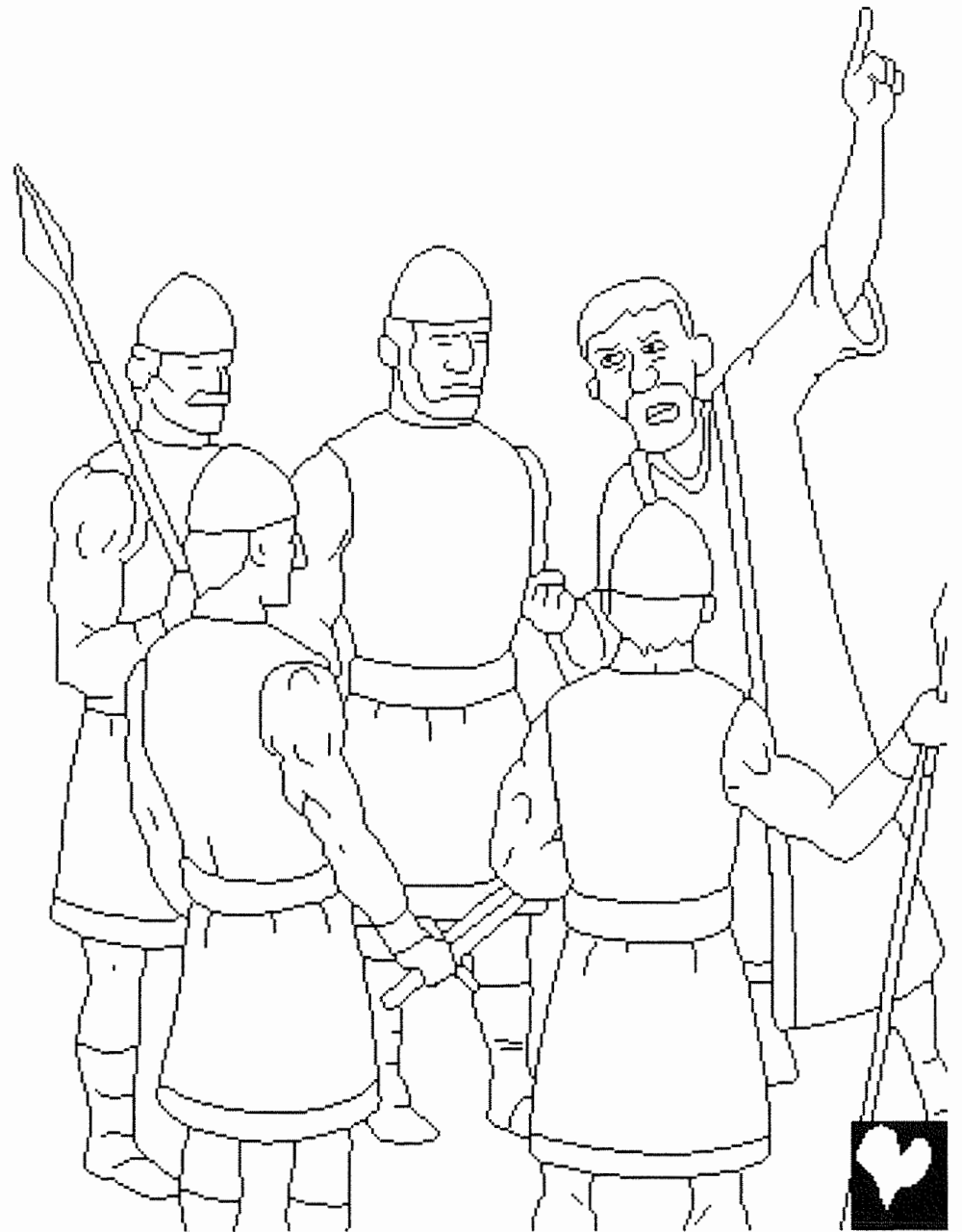



Nehemiah tried to be a good example. King Artaxerxes had made him governor of Jerusalem with the right to demand food and money from the people, but he didn't do it.

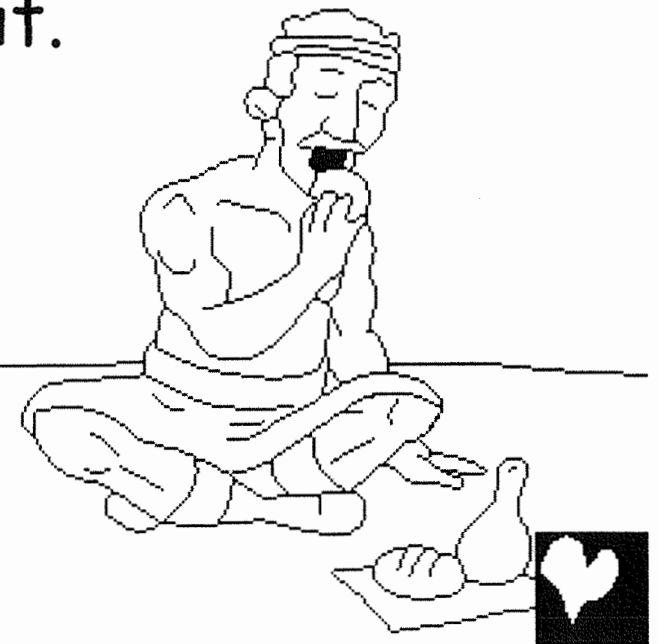



He just worked  
hard alongside  
the people as  
they rebuilt the  
wall. He used  
his own money  
to buy food.



Finally, the people finished the wall, and only the doors had to be put into the main gates. When Sanballat, Tobiah and Geshem heard that there wasn't a gap in the walls anymore, they planned to harm Nehemiah.



They sent messages for Nehemiah to meet them at a place called Ono. But Nehemiah knew they were trying to trick him out of the city so they could harm him. He wrote back telling them that he would not leave the work to go visit with them.



The wall  
was finally  
finished,

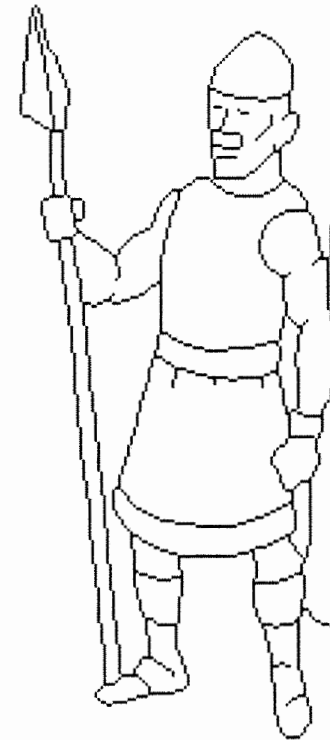

and Nehemiah set guards  
to protect it.





He also made a rule that the gates should not be

opened until well after

the sun came up. Through the night, they were to be shut and barred.



Now that the city was safe, many Jewish exiles from different parts of the world returned to Jerusalem. Nehemiah must have been very happy that he had finished the job God gave him to do, in spite of all the obstacles. He stayed on in Jerusalem and helped the people to always obey God.



# The Great Wall of Nehemiah

A story from God's Word, the Bible,

is found in

Nehemiah

"The entrance of Your Word gives light."

Psalm 119:130



**Year 3**

**Week 114**

**An Angel Visits Two Families**  
*Announcing of the Coming of John the Baptist and Jesus*

**Scriptures: Luke 1**

**Key Verse: Luke 1:76-77** “And you, child, shall be called the prophet of the Highest: for you will go before the face of the Lord to prepare His ways: to give knowledge of salvation to his people by the remission of their sins.”

**Key Points:**

1. Herod is king of Judea at the time. Zechariah is a priest in the temple and his wife’s name is Elizabeth, and they have no children.
2. An angel named Gabriel appears to Zechariah in the temple and tells him his wife would have a son and his name would be John. Zechariah becomes mute and cannot speak because he doesn’t believe the angel.
3. The angel Gabriel comes to Mary who lived in Nazareth and tells her that she shall have a son and shall call his name Jesus. She is espoused to a man named Joseph.
4. Mary goes to see Elizabeth, her cousin, and stays about 3 months and then returns home
5. Zechariah and Elizabeth’s baby is born and the neighbors and cousins call him after his father, but Elizabeth says “No, his name is John.”
6. Zechariah takes a writing tablet and writes the name “John” and immediately Zechariah could speak again.

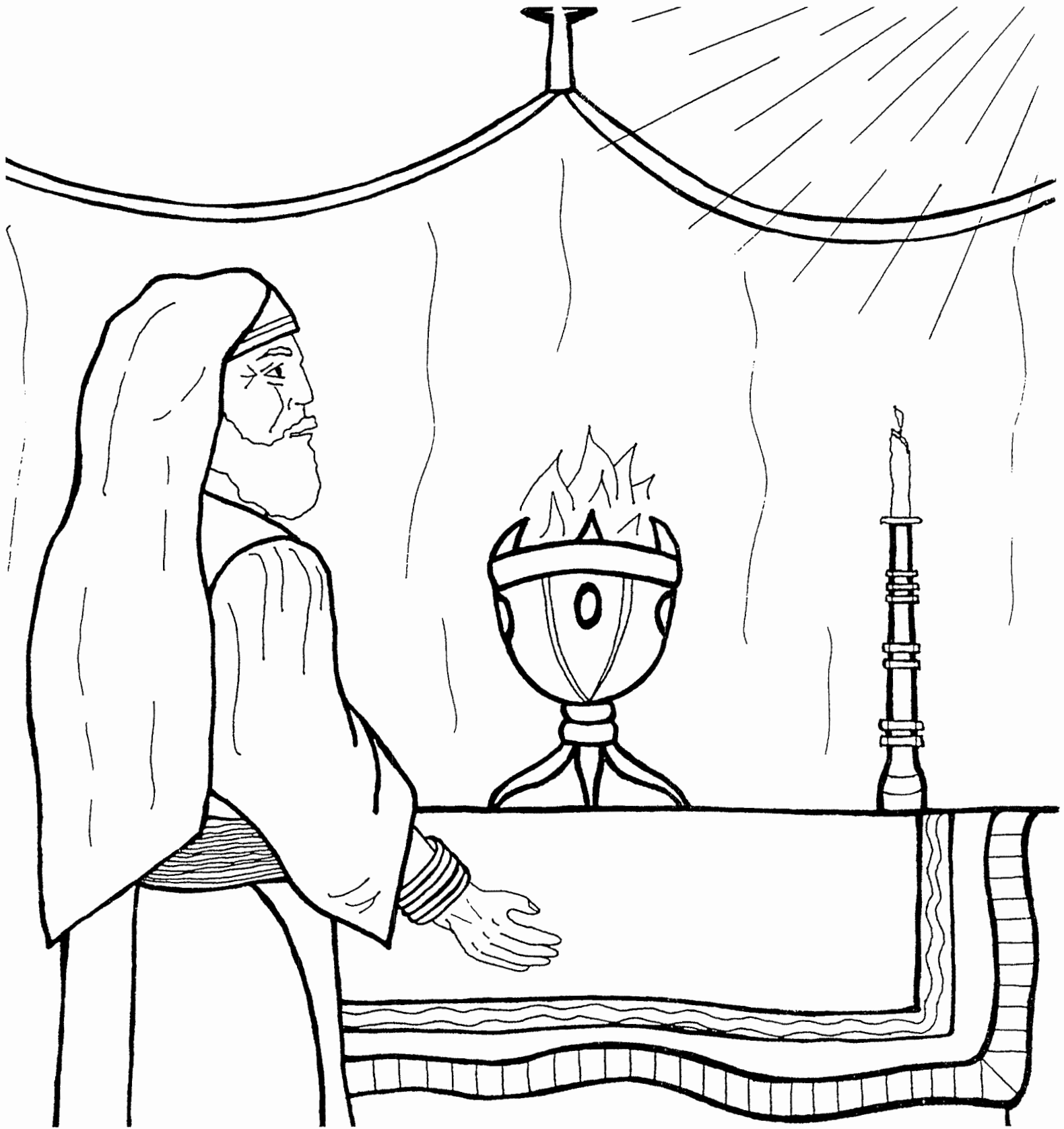

As Zacharias burns incense in the temple of the Lord, an angel of the Lord appears to him to tell him that he shall have a son.

*LUKE 1:5-25*

# Bible Story Word Hunt

**Word List**

- AFRAID
- ANGEL
- BABY
- ELIZABETH
- GABRIEL
- GOD
- JOHN
- JOY
- PRAYER
- PRIEST
- SILENT
- SON
- SPEAK
- TABLET
- TEMPLE
- ZECHARIAH



.....

Important words from the Bible story of John's birth are hidden in this word hunt. See how many you can find, reading forward and backward, up and down, and diagonally.

.....

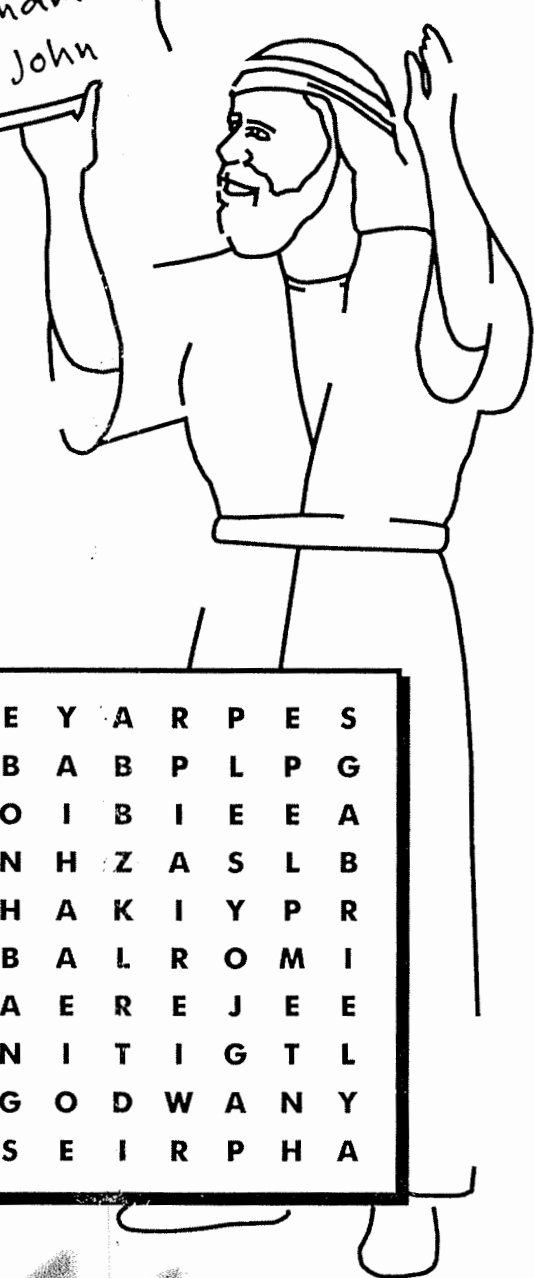



J	Y	R	E	Y	A	R	P	E	S
Z	O	Y	B	A	B	P	L	P	G
T	E	H	O	I	B	I	E	E	A
A	C	C	N	H	Z	A	S	L	B
B	F	R	H	A	K	I	Y	P	R
L	Z	R	B	A	L	R	O	M	I
E	H	E	A	E	R	E	J	E	E
T	T	N	N	I	T	I	G	T	L
H	O	T	G	O	D	W	A	N	Y
S	Q	T	S	E	I	R	P	H	A



ake a puppet to show what happened when Zechariah didn't believe the angel.

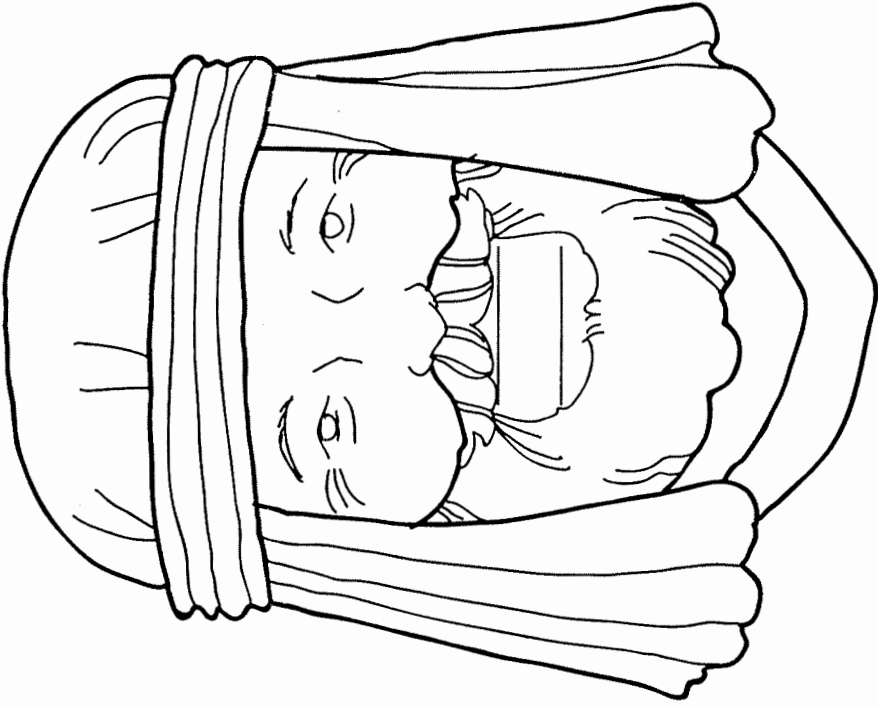

<p>An angel appeared to Zechariah in the temple, and said, "Your prayer has been heard. Your wife Elizabeth will have a son, and you are to call him John."</p> <p>Zechariah asked how his wife could have a baby, since they were both so old. The angel said, I have been sent from God to tell you this good news. But since you do not believe me, you will not be able to speak until the child is born.</p> <p>Zechariah was not able to speak.</p> <p>Soon, Elizabeth had a baby boy. Many people told them names for the baby. But, Elizabeth said, "His name is John."</p> <p>Right then, Zechariah was able to speak. He began to praise God!</p> <p>(Luke 5:2-25 and 57-80)</p>	
	



Zechariah and Elizabeth  
*Luke 1*



# ZACHARIAS AND ELIZABETH

## (LUKE 1:5-25)

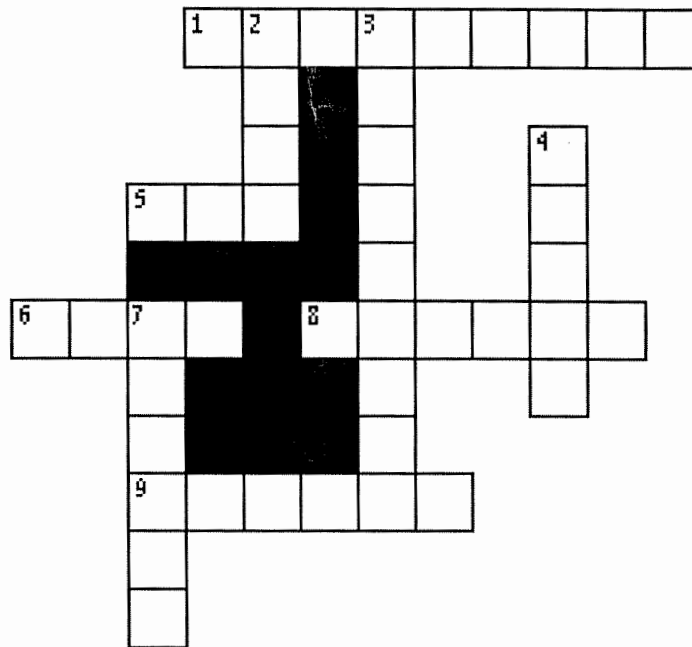

- 3 DOWN "There was in the days of Herod, the king of Judea, a certain priest named \_\_\_\_\_, of the division of Abijah. His wife was of the daughters of Aaron, and her name was Elizabeth." **LUKE 1:5**
- 1 ACROSS "But they had no child, because \_\_\_\_\_ was barren, and they were both well advanced in years." **LUKE 1:7**
- 9 ACROSS "So it was, that while he was serving as \_\_\_\_\_ before God in the order of his division, according to the custom of the priesthood, his lot fell to burn incense when he went into the temple." **LUKE 1:8-9**
- 4 DOWN "Then an \_\_\_\_\_ of the Lord appeared to him, standing on the right side of the altar of incense." **LUKE 1:11**
- 8 ACROSS "But the angel said to him, 'Do not be afraid, Zacharias, for your \_\_\_\_\_ is heard; and your wife Elizabeth will bear you a son, and you shall call his name John.'" **LUKE 1:13**
- 2 DOWN "And he will turn many of the children of Israel to the \_\_\_\_\_ their God." **LUKE 1:16**
- 5 ACROSS "And Zacharias said to the angel, 'How shall I know this? For I am an \_\_\_\_\_ man, and my wife is well advanced in years.'" **LUKE 1:18**
- 6 ACROSS "But behold, you will be \_\_\_\_\_ and not able to speak until the day these things take place, because you did not believe my words which will be fulfilled in their own time." **LUKE 1:20**
- 7 DOWN "But when he came out, he could not speak to them; and they perceived that he had seen a vision in the \_\_\_\_\_, for he beckoned to them and remained speechless." **LUKE 1:22**



G - Green

R - Red

Y - Yellow

B - Blue

P - Pink

W - White



An Angel Visits Mary  
*Luke 1*

## Bookmark Craft Idea;

Use any verse or verses to create a bookmark craft. Print out on card stock. Lace the two parts of the book mark together by punching holes along the dotted line and threading with yarn or plastic thread (you may like to do every second dot if using this method), or just glue the two pieces together.

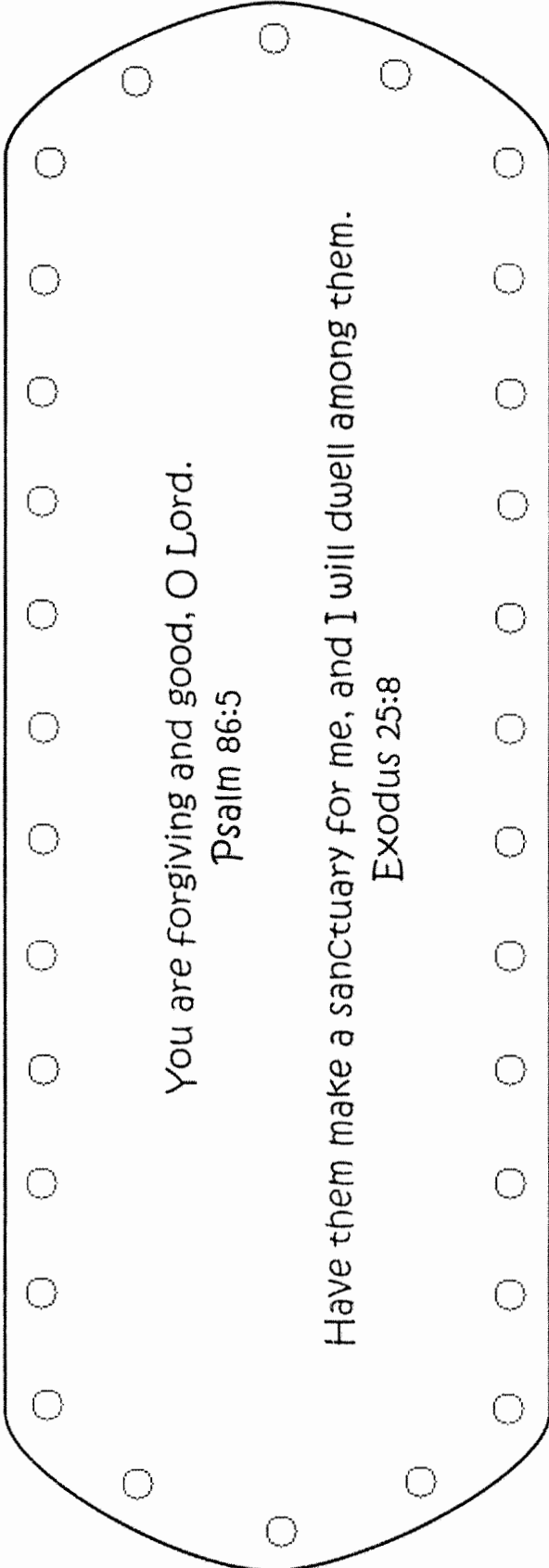

You are forgiving and good, O Lord.

Psalm 86:5

Have them make a sanctuary for me, and I will dwell among them.

Exodus 25:8

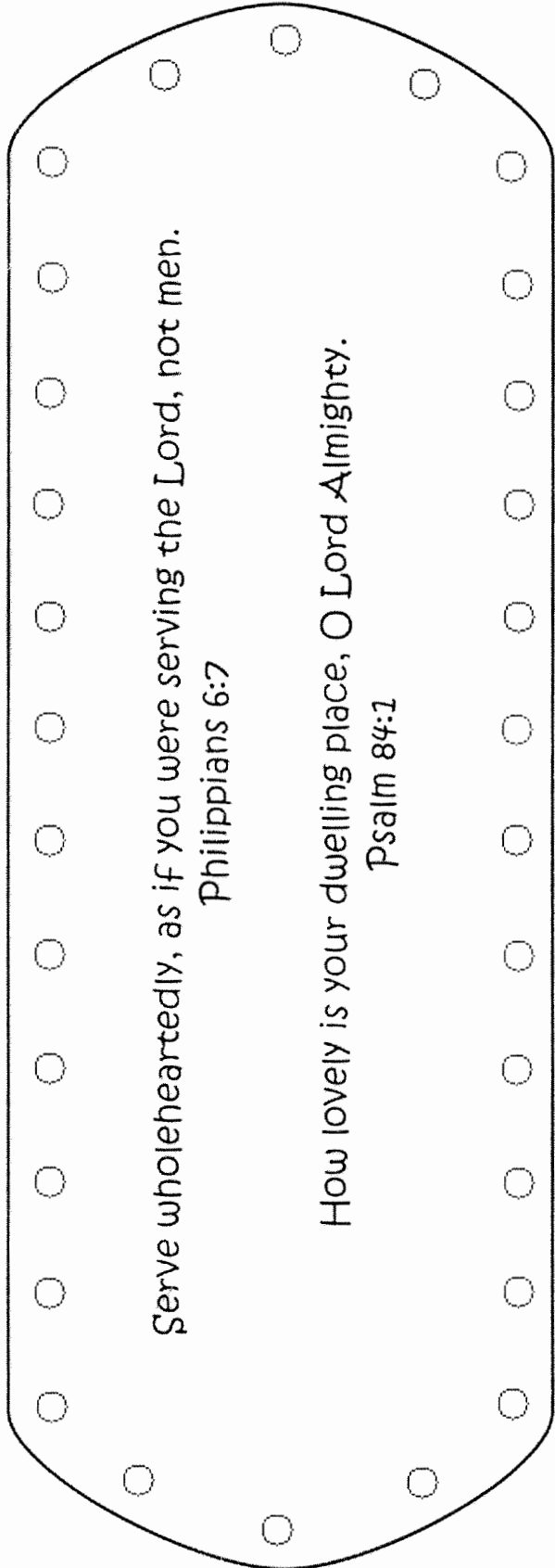

Serve wholeheartedly, as if you were serving the Lord, not men.

Philippians 6:7

How lovely is your dwelling place, O Lord Almighty.

Psalm 84:1

Lace the two parts of the book mark together by punching holes along the dotted line and threading with

AN ANGEL VISITS TWO FAMILIES

A P A A U I H M Y

L E G C N Y H L Y

F Q W T R G J E K

F O Q A B O E U W

S V M L S A R L J

Q L X E L G B I Y

G L P Z Z G O Y W

U H J E S U S W S

E L I Z A B E T H

A K K R P J O H N

MARY

JESUS

JOSEPH

ELIZABETH

ANGEL

BABY

JOHN

## **Year 3**

### **Week 115**

### **Birth of Christ**

#### **Scriptures: Matthew 1:18 - 2:23**

**Key Verse: Matthew 1:21** “And she will bring forth a son, and you shall call his name **JESUS**: for he will save his people from their sins.”

#### **Key Points:**

- 1.** Mary was espoused to Joseph, a just man, and she was with child of the Holy Spirit, and Joseph put her away secretly. An angel of the Lord came to Joseph in a dream and told him to take Mary as his wife.
- 2.** Jesus was born in Bethlehem of Judea when Herod was king. Wise men from the east came to find the child and asked, “Where is He who has been born King of the Jews?” Herod was troubled and demanded to know where Jesus would be born. Herod called wise men and they were told to bring back word where the child was.
- 3.** The wise men followed the star, came to the house, and found Mary and the baby. They fell down and worshipped him, and brought gifts. They were warned in a dream not to return to Herod, but went to their country another way.
- 4.** An angel came to Joseph in a dream and told him that Herod wanted to destroy the child, and to take the young child and mother and to go to Egypt, and stay until word was brought that they could return.
- 5.** When Herod saw he was deceived by the wise men, he was angry and had all children two years old and younger to be killed. Joseph left in the night and went to Egypt and was there until Herod died.
- 6.** When Herod died, an angel came to Joseph and told him to take the child and mother into the land of Israel, and they came and dwelt in Nazareth.

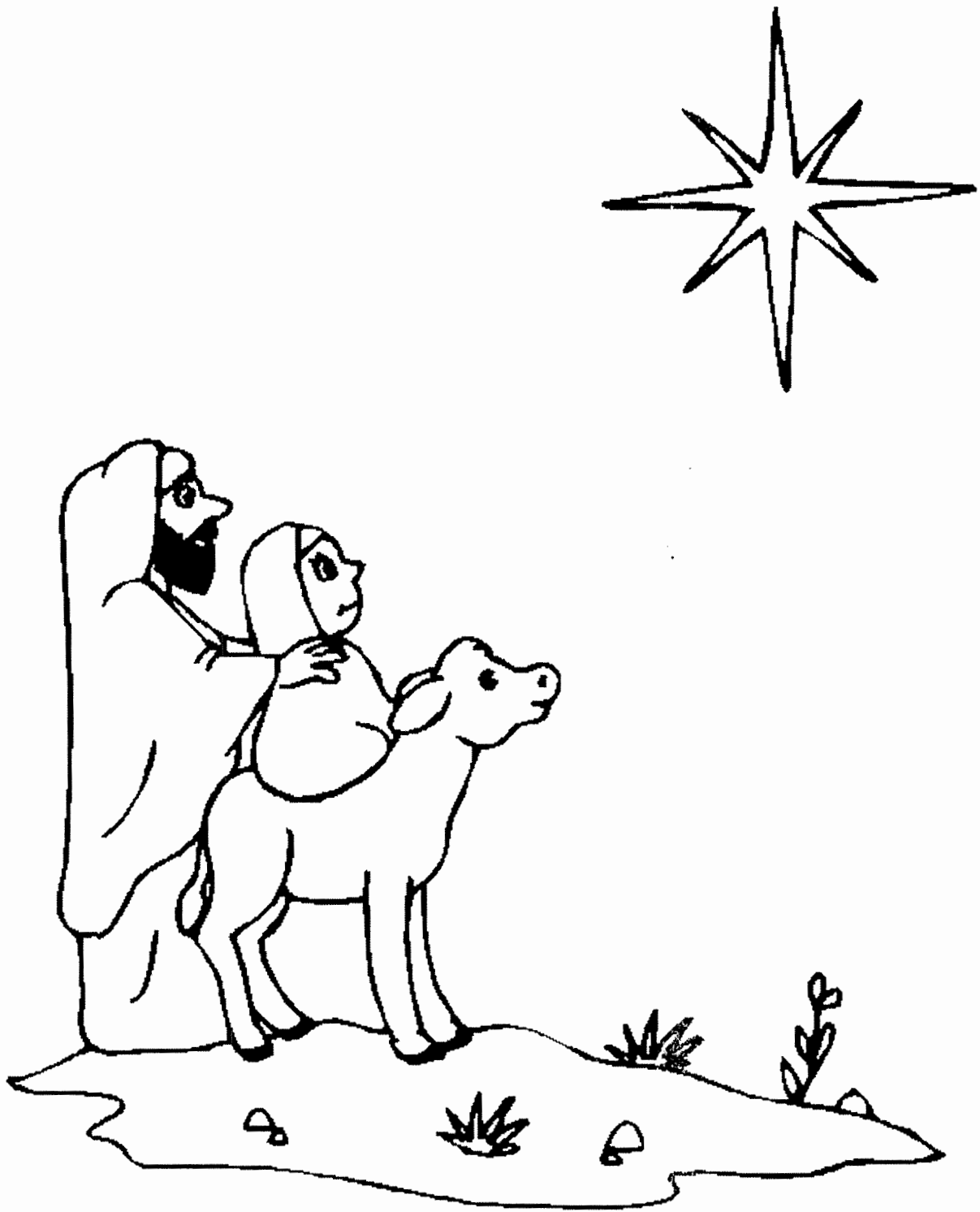

**And Joseph also went up from Galilee, out of the city of Nazareth, into Judaea, unto the city of David, which is called Bethlehem; (because he was of the house and lineage of David:) To be taxed with Mary his espoused wife, being great with child.**

***Luke 2:4-5***



# Draw the way to Bethlehem

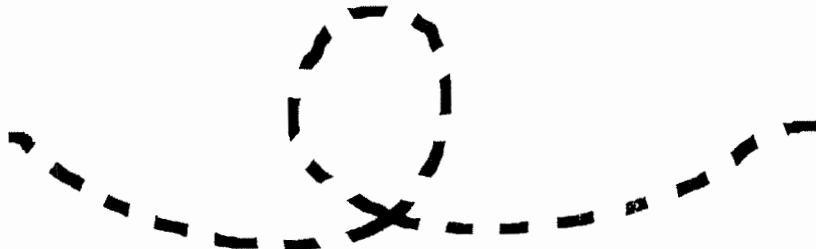
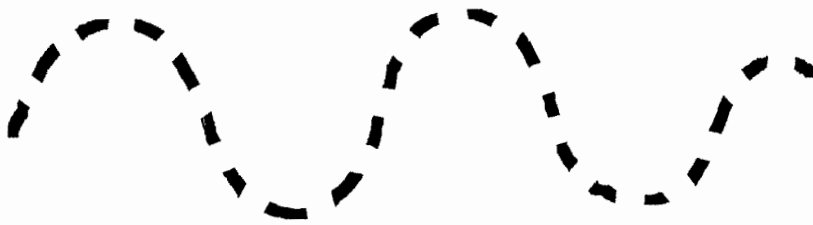



Jesus Is Born  
*Luke 2*



**And so it was, that, while they were there, the days were accomplished that she should be delivered. And she brought forth her firstborn son, and wrapped him in swaddling clothes, and laid him in a manger; because there was no room for them in the inn.**

*Luke 2:6-7*

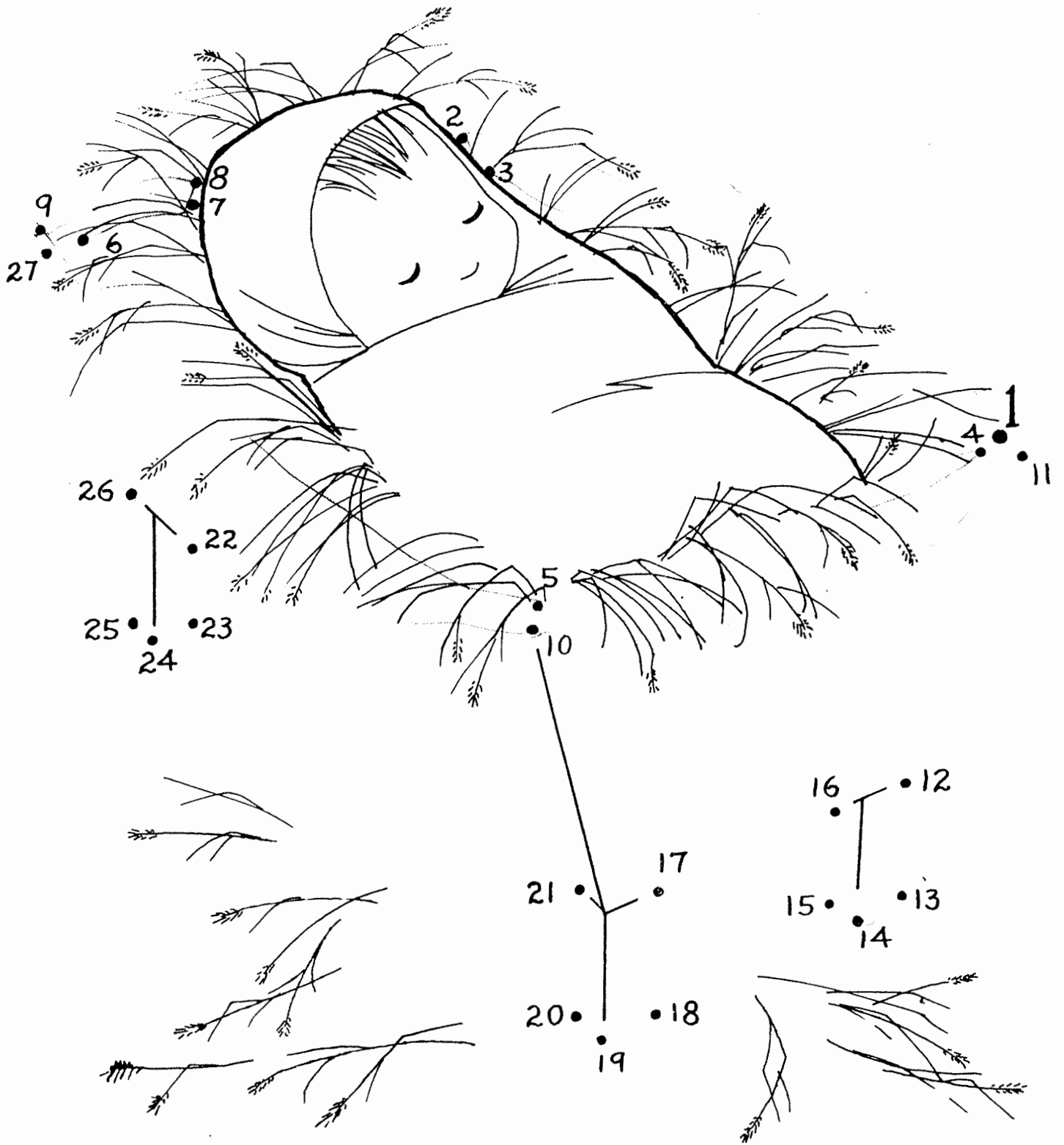

BABY JESUS LAY IN THE \_\_\_\_\_

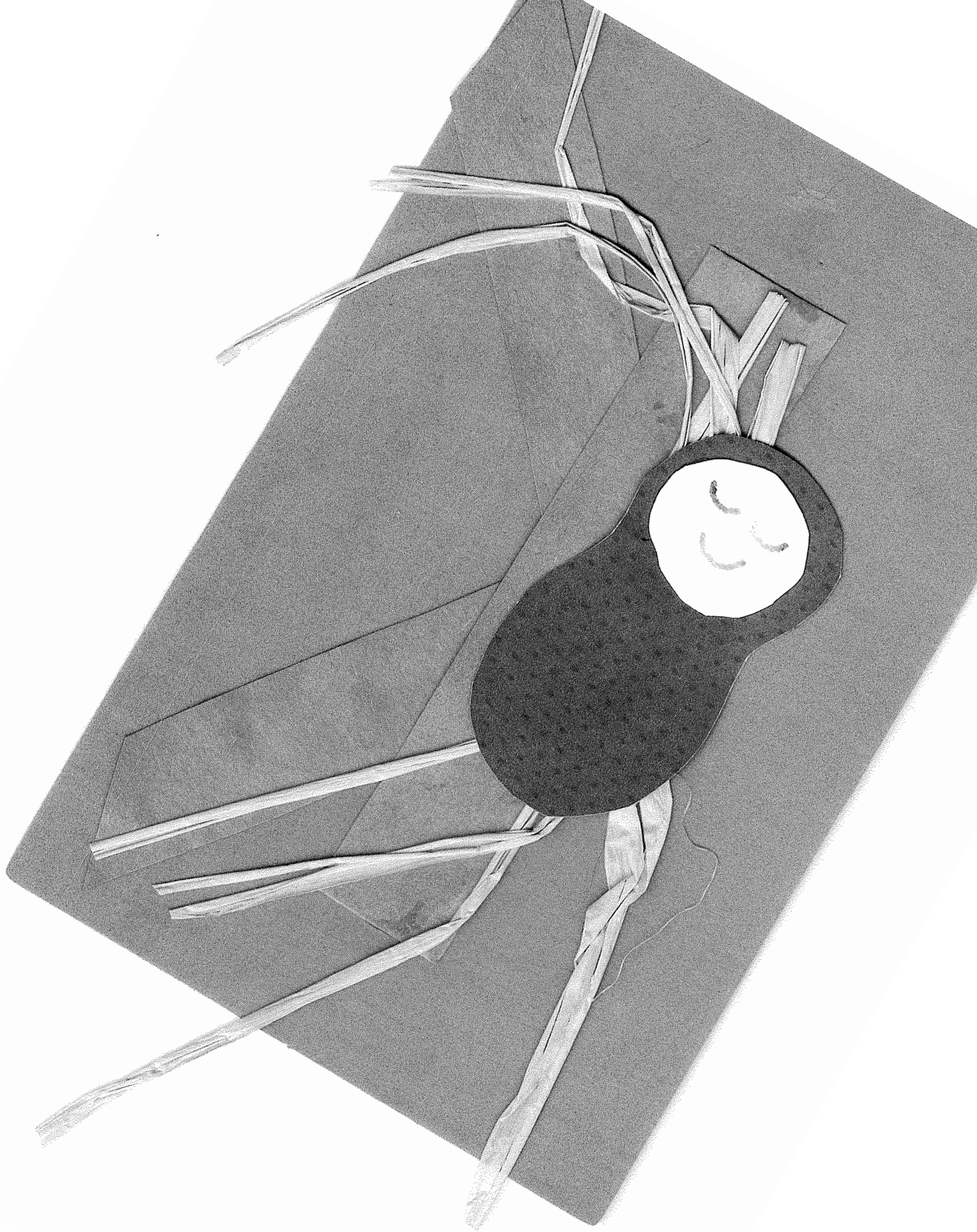

# Birth of Jesus

Matthew 1; Luke 2

# Stable Mates

.....  
Unscramble each set  
of letters in the stable  
and write your  
answer on its line.  
.....

A stable? It was a strange birthplace for a king! But the Bible tells us that is where Mary and Joseph spent the night when Jesus was born. Scripture also tells us that shepherds came. Now think about that night. Who else could have been there?

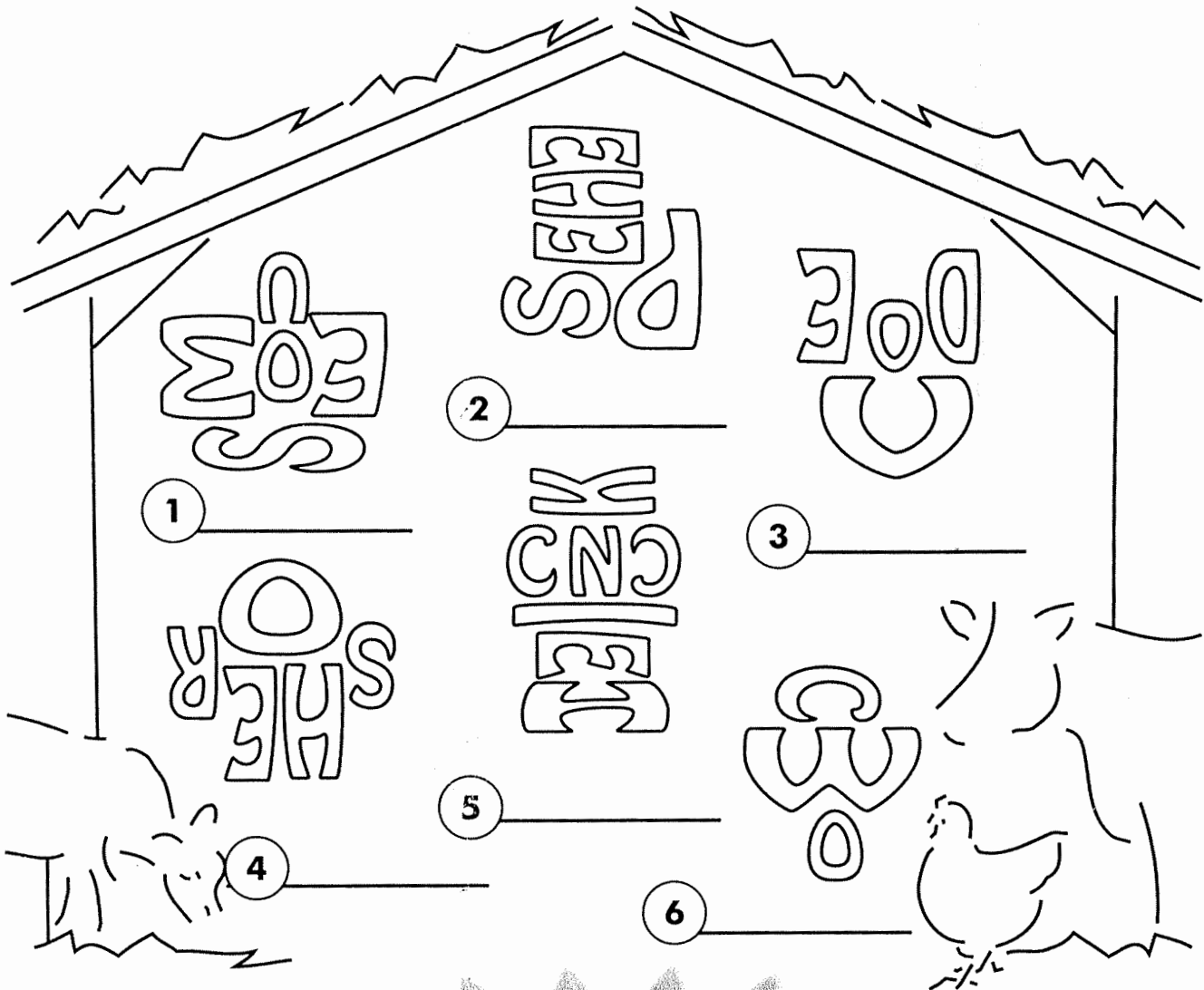



Shepherds and Angels  
Luke 2

Wise Men  
Visit Jesus  
Matthew/2

# Follow the Star

Follow each numbered ray of light from the star to find the letters you need to put in each numbered box. Then you will know what the wise men planned to do when they found the baby Jesus.

1 I 2 O 3 R 4 H 5 W 6 I 7 P 8 S 9 I 10 M



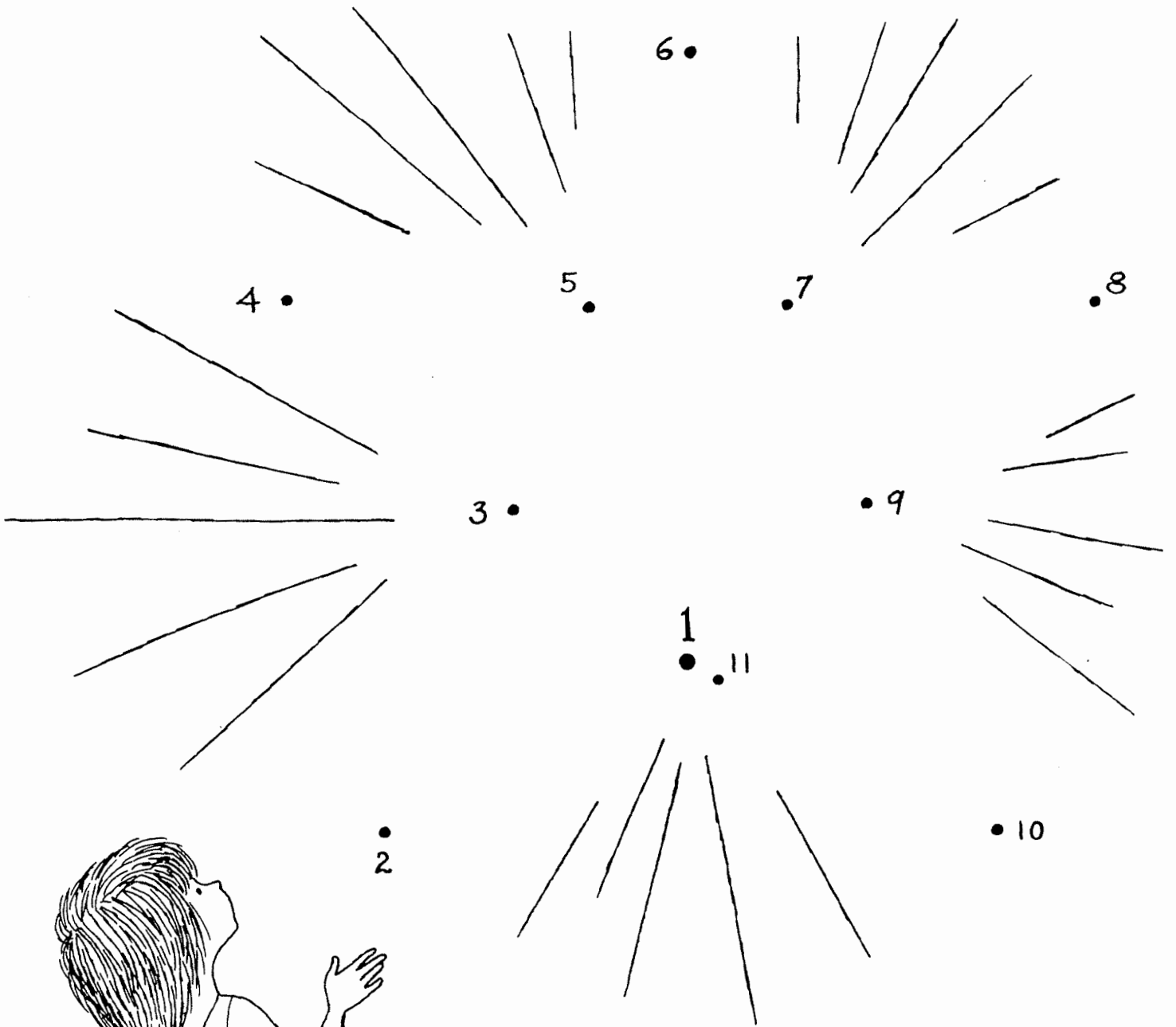

THE SHEPHERD BOY SAW THE \_\_\_\_\_

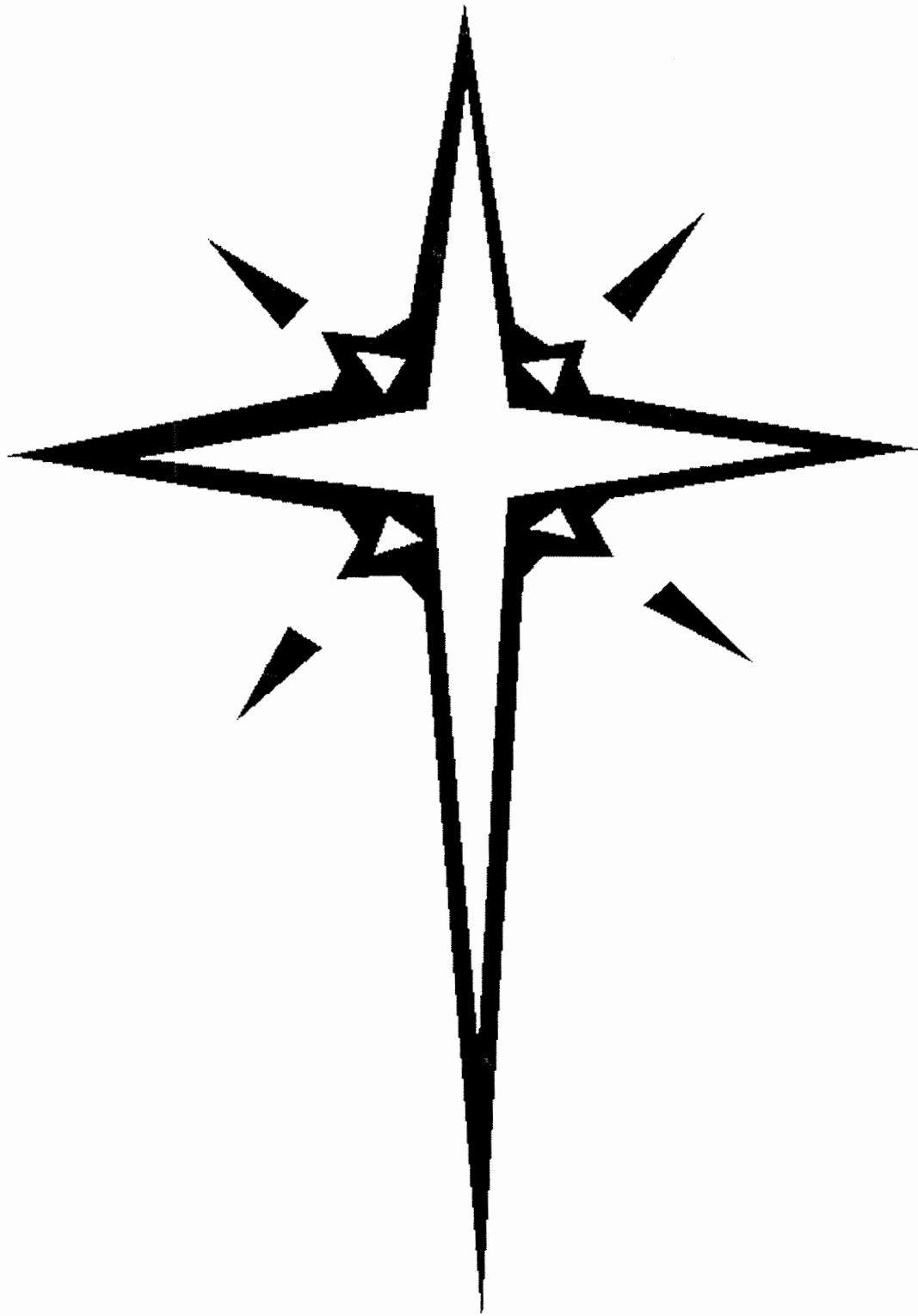

**Saying, Where is he that is born King of the Jews? for we have seen his star in the east, and are come to worship him.**

***Matthew 2:2***

The Angel's  
Announcement  
Luke 2:8-15

# Hark!













"Hark" means "listen." The shepherds listened to the angels' message, and then they listened to many angels praising God. What was the good news the angels delivered? Color in all the circles and triangles on the angel's robe. The uncolored letters will spell the message.

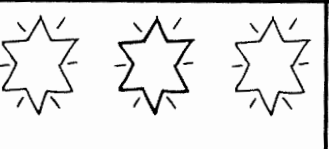

-----  
-----  
-----  
-----  
-----

# Go Tell It!

What is the good news from the angels and shepherds? Find the picture in each group that is different from the others and circle the letter below it. Then write the circled letters in the spaces at the bottom to find the good news. Then, go tell it!

 <b>C J N</b>	 <b>R O E</b>	 <b>S B T</b>
 <b>U E A</b>	 <b>D S V</b>	 <b>H J I</b>
 <b>V Q S</b>	 <b>A B Y</b>	 <b>P F O</b>
 <b>U E R</b>	 <b>N C M</b>	 <b>? ! ;</b>



# Escape to Egypt

## Matthew 2:13,14 (NIV)

Joseph and Mary gave the new baby a special name. An angel appeared to Joseph in a dream to tell him what to name the baby. Read Matthew 1:20 and fill in the blanks below to see what the angel said.

"She (Mary) will give birth to a \_ \_ \_ , and you are to give him the name \_ \_ \_ \_ \_ , because he will \_ \_ \_ \_ \_ his people from their \_ \_ \_ \_ \_ ."

Not everyone was glad about the birth of Jesus.  
When king Herod heard about it he tried to have Jesus killed.  
The angel of the Lord appeared again to Joseph in a dream, this time to warn him.  
Read Matthew 2:13 to see what he told Joseph and fill in the blanks below.

"Take the \_ \_ \_ \_ \_ and his mother and escape to \_ \_ \_ \_ \_ ... for \_ \_ \_ \_ \_ is going to search for the child to \_ \_ \_ \_ \_ him."

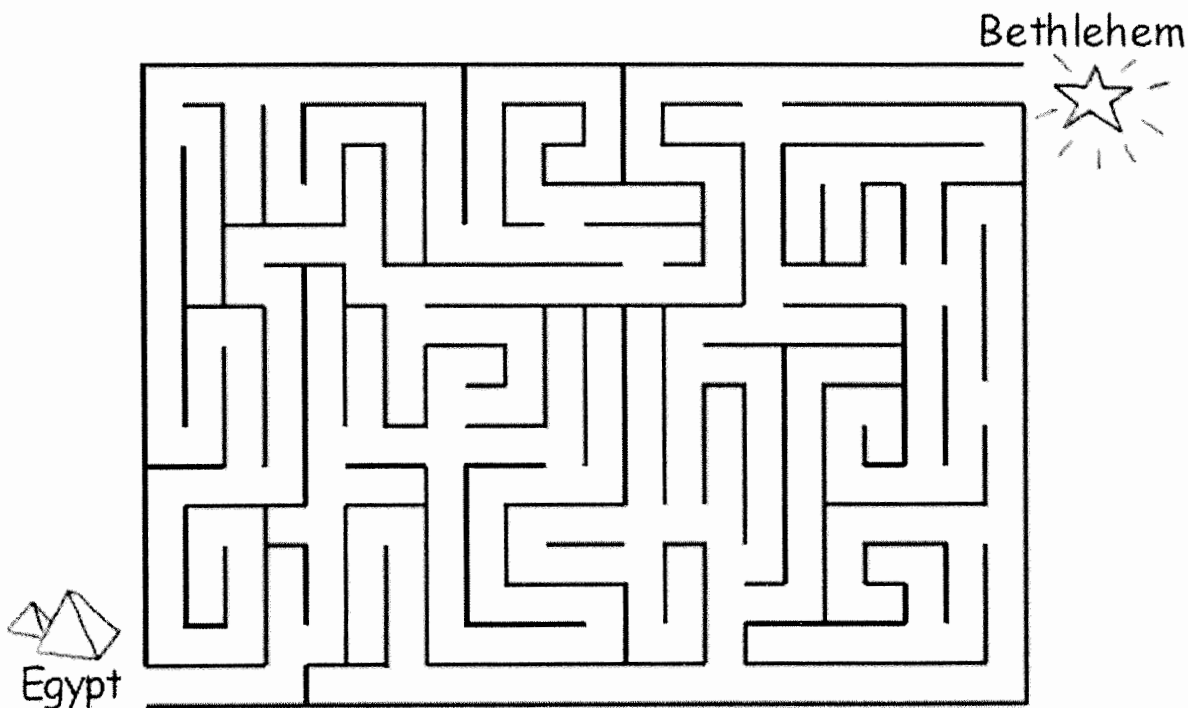

Help them find their way in the maze above

# Wisemen Paper Craft

## Materials

- black and gold card stock OR
- felt, fabric, gift wrap or any similar material
- (optional) decorative items such as glitter, ribbons etc.

## Method

- Print out the following template  
print or trace three of these onto dark/black
- Cut out and glue crowns and gifts in place.
- 

Alternatively, you can:

- Use fabric, gift wrap or other such materials to make  
Wisemen and decorate as desired.

To Finish,

- Place in window as a silhouette. OR
- Paste onto a large piece of card to make a picture. OR
- Make a mobile showing the Wisemen following the star.

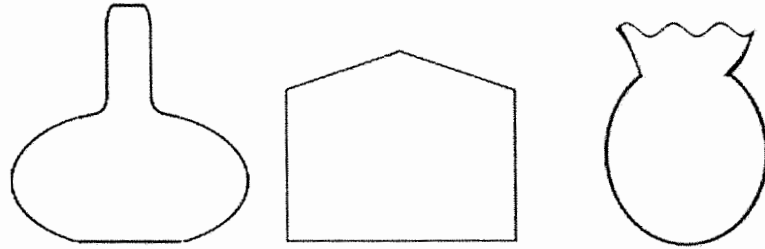
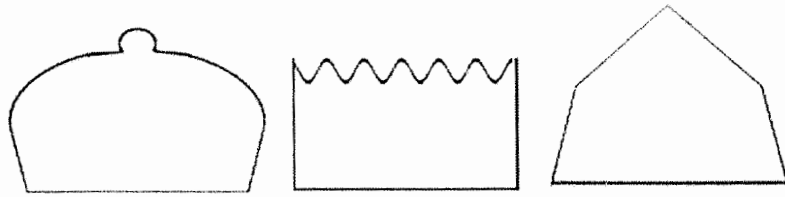

Wise Mer

Paper  
Craft

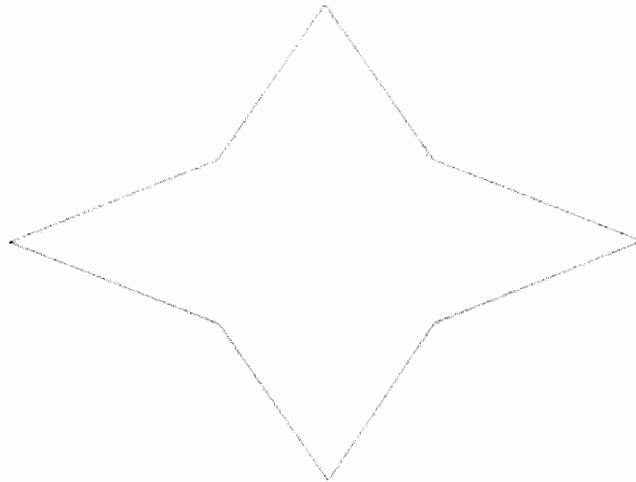

Wise Mer



Wise Men Worship Jesus  
*Matthew 2*





**And they said unto him, In Bethlehem of Judaea: for thus it is written by the prophet, And thou Bethlehem, in the land of Juda, art not the least among the princes of Juda: for out of thee shall come a Governor, that shall rule my people Israel. Then Herod, when he had privily called the wise men, inquired of them diligently what time the star appeared.**

***Matthew 2:5-7***

# The Gifts of Kings

The kings followed a star to Bethlehem, and they brought their gifts to Jesus. It is thought that this event may have inspired today's custom of Christmas giving.

Read the three gift descriptions that follow. Then, to see what the gifts mean, write the first letter of picture names in the blanks.

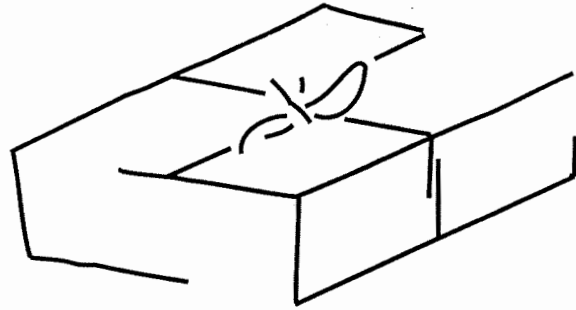

1. This gift from deep in the earth could have been shaped as a beautiful bowl, a crown of jewels, coins, or a shiny statue. . . . GOLD

It is the symbol of \_\_\_\_\_



2. This gift, burned as incense, was collected as sap from a tree that grows in Africa and Asia. . . . FRANKINCENSE

It is the symbol of \_\_\_\_\_

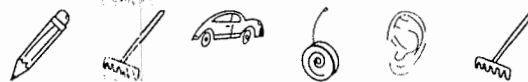

3. This gift, used in perfume and embalming, started out as a gummy substance from a bush. . . . MYRRH

It is the symbol of \_\_\_\_\_



# ★ COME AND ★ WORSHIP!

Read Matthew 2:1-11 which tells the story of the wise men. Then fill in the puzzle using the clues given. The shaded squares will spell the name of an important city.

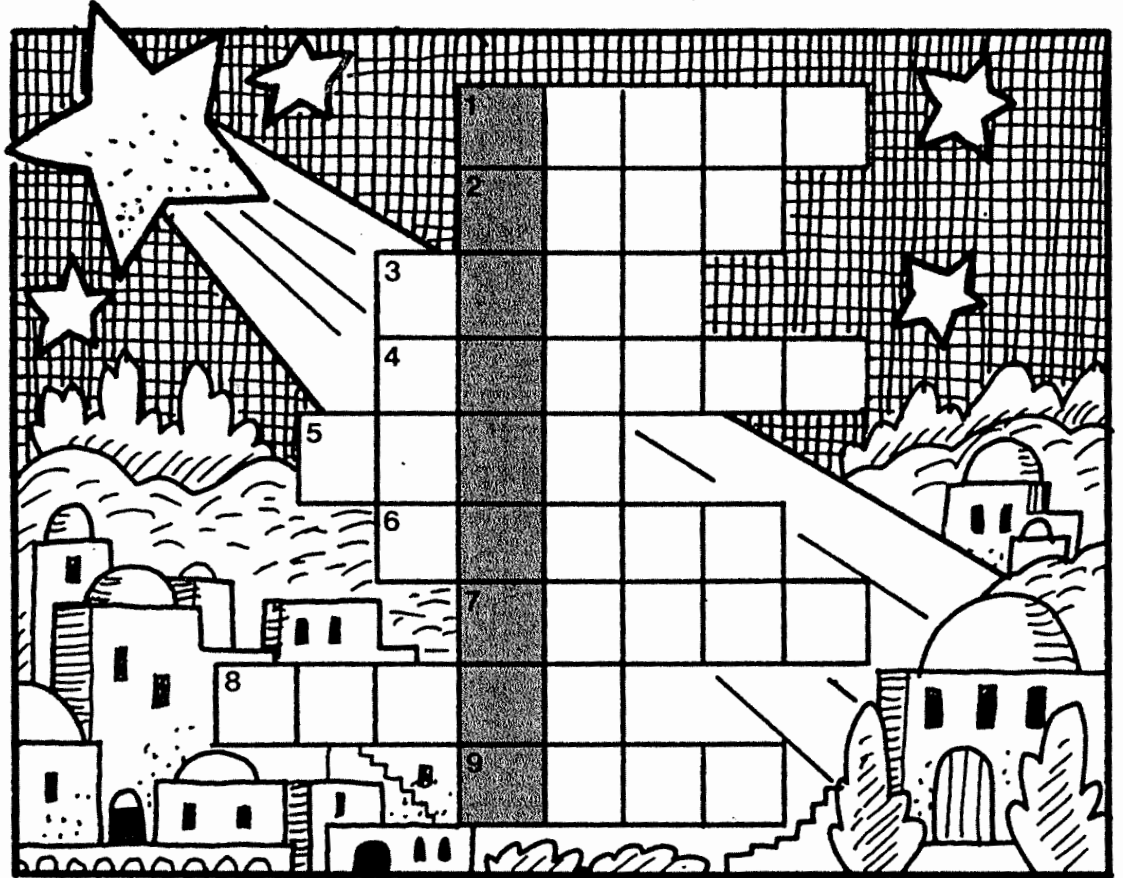

1. When they found the child, they \_\_\_\_\_ down (v. 11).
2. Magi from the \_\_\_\_\_ came to Jerusalem (v. 1).
3. "We saw his \_\_\_\_\_" (v. 2).
4. Herod asked them where the \_\_\_\_\_ was to be born (v. 4).
5. They presented him with gifts of \_\_\_\_\_ (v. 11).
6. The child's name was \_\_\_\_\_ (v. 1).
7. The child was born during the time of King \_\_\_\_\_ (v. 1).
8. Jesus was born in a town in \_\_\_\_\_ (v. 1).
9. \_\_\_\_\_ came from the east to Jerusalem (v. 1).

# What Happened When Jesus was Born?

Matthew 2:1-12

The Bible says that after Jesus was born, some wise men came to visit Him because of something they had seen.

Connect the dots in counterclockwise order to show what the wise men saw. As you connect each dot, write the number beside the dot on the lines at the bottom of the page. Then use the code to find out what happened.

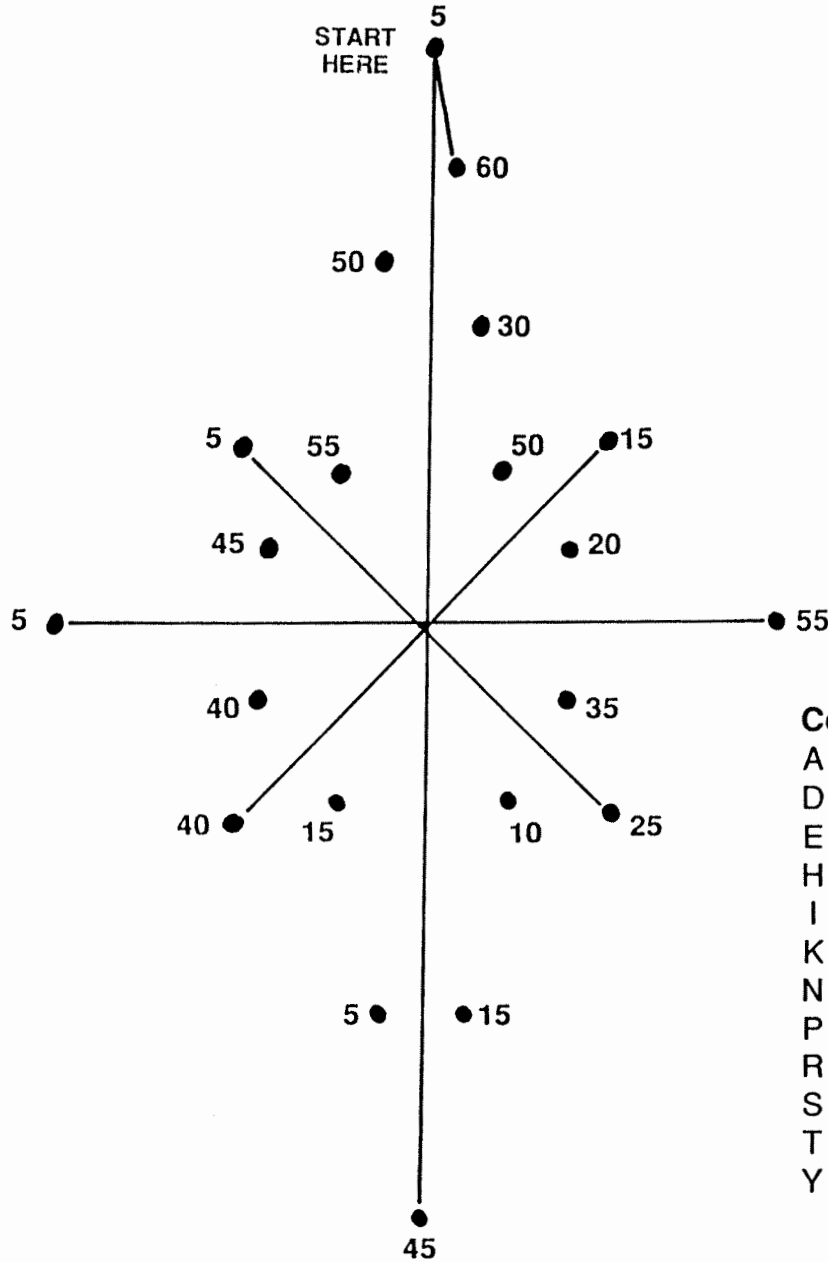

**Code:**

A	=	5
D	=	10
E	=	15
H	=	20
I	=	25
K	=	30
N	=	35
P	=	40
R	=	45
S	=	50
T	=	55
Y	=	60

Letters	<div style="border-bottom: 1px dashed black; height: 15px; width: 100%;"></div>
Numbers	<div style="border-bottom: 1px dashed black; height: 15px; width: 100%;"></div>

# When Jesus Came

Matthew 2; Luke 2

"Glory to God in the highest, and on earth peace, good will toward men," said the angels as they announced Jesus' birth to the shepherds.

Read the story about Jesus' special birth and how God took care of Him. As you read, fill in the blanks with the correct words. If you need help, you can look up the Bible verses at the end of each paragraph. Then use the words you've written in the blanks to fill in the crossword puzzle.

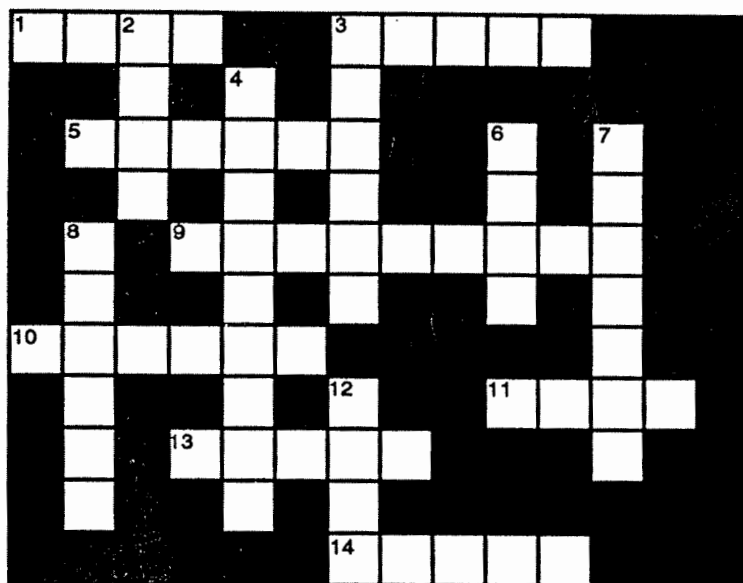

When the angel came to the shepherds, the angel said, "I bring you good tidings of great joy, which shall be to all people. For unto you is born this day in the city of David a Saviour, which is Christ the Lord. And this shall be a sign unto you; Ye shall find the babe wrapped in swaddling clothes, lying in a \_\_\_\_\_ (10 across)." (Luke 2:10-12)

After the \_\_\_\_\_ (5 across) went away, the \_\_\_\_\_ (9 across) said to each other, "Let us now go even unto Bethlehem, and see this thing which is come to pass, which the Lord hath made known unto us." The shepherds hurried to Bethlehem to visit Baby Jesus. (Luke 2:15-16)

A few days later, when Jesus was eight days old, Mary and Joseph took Baby Jesus to Jerusalem to present Him to the Lord. In the temple, an elderly lady named \_\_\_\_\_ (2 down), gave thanks for Jesus. (Luke 2:21-38)

Later, Jesus had other visitors who were happy He was born, but the king was very upset. The Bible says, "Now when \_\_\_\_\_ (3 across) was born in Bethlehem of Judaea in the days of \_\_\_\_\_ (13 across) the king, behold, there came \_\_\_\_\_ (7 down) from the east to Jerusalem, saying, 'Where is He that is born King of the Jews? for we have seen His \_\_\_\_\_ (1 across) in the east, and are come to

worship Him.'" (Matthew 2:1-2)

King Herod was very interested in the wise men's question, so he sent them to \_\_\_\_\_ (4 down) and said, "Go and \_\_\_\_\_ (8 down) diligently for the young child; and when ye have found Him, bring me word again, that I may come and worship Him also." But King Herod really planned to kill Baby Jesus. (Matthew 2:8)

The wise men followed the star to the house where Mary and Joseph and Jesus were living. The Bible says, "They saw the young child with \_\_\_\_\_ (6 down) His mother, and fell down, and worshipped Him: and when they had opened their treasures, they presented unto Him gifts; \_\_\_\_\_ (12 down), and frankincense, and myrrh." God told the wise men in a dream that they should not return to King Herod, and they went home another way. (Matthew 2:9-12)

Then an angel appeared to \_\_\_\_\_ (3 down) in a \_\_\_\_\_ (14 across), and said, "Arise, and take the young child and His mother, and \_\_\_\_\_ (11 across) into Egypt, . . . for Herod will seek the young child to destroy Him." Joseph and Mary and Baby Jesus left at night and went to Egypt to live until King Herod died. This is the way God protected His Son from a cruel and wicked king. (Matthew 2:13-15)

# Who Had a Part?

When Jesus was born as a tiny baby, many people had a part in His birth. Some announced Jesus' birth, some people came to worship Jesus, and some people took special care of Baby Jesus. Every person's part was very important in God's special plan for the birth of His Son, Jesus.

Unscramble the names of several of the people who had a part in the birth of Jesus and write their names on the lines. If you need help, look up the Bible verses. Then find the names hidden in the candle puzzle. Candles are often used as decorations when we celebrate Jesus' birthday, because candles remind us that Jesus came to earth to bring us spiritual light.

1. GLAEN \_\_\_\_\_  
(Luke 2:10)
2. MOENSI \_\_\_\_\_  
(Luke 2:25-32)
3. SEHLETABI \_\_\_\_\_  
(Luke 1:39-40)
4. BLGEAIR \_\_\_\_\_  
(Luke 1:26-31)
5. RHDOE \_\_\_\_\_  
(Matthew 2:13)

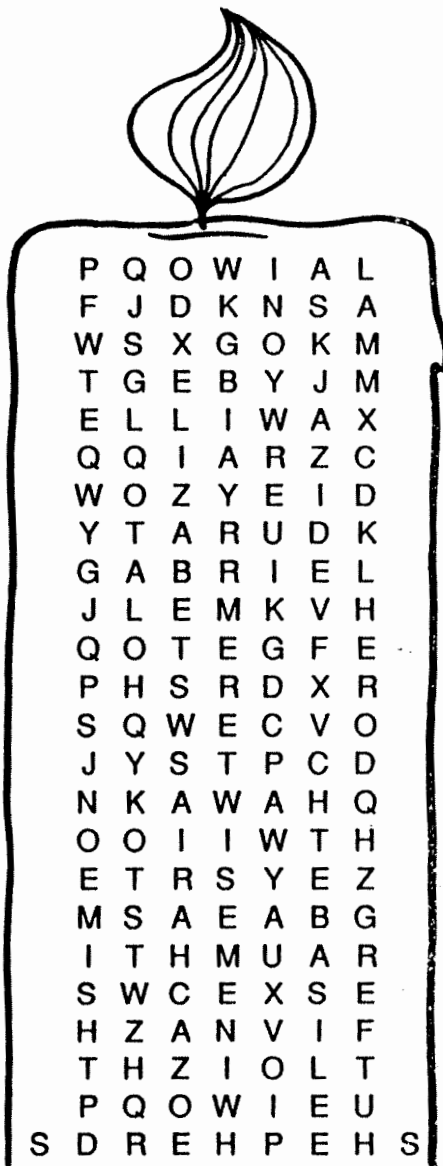

6. HPSOEJ \_\_\_\_\_  
(Luke 2:4)
7. RYMA \_\_\_\_\_  
(Luke 2:5-7)
8. DPHEESRSH \_\_\_\_\_  
(Luke 2:15)
9. SWIE NME \_\_\_\_\_  
(Matthew 2:1)
10. RAZCHAAIS \_\_\_\_\_  
(Luke 1:39-40)

## **Life of Jesus Mini Book**

- **Print out pages**
- **Have children color the book**

### **To create the book~**

#### **NUMBERED PAGES:**

- If you imagine a 'real' book for a second, you know that each page has printing on the front and the back. We're going to fold the pages to make it like a real book.
  - Ignore the cover for now.
  - Fold each page along the center dotted line so the images are on the OUTSIDE and the blank sides of the paper are on the inside (imagine you're making a greeting card).
  - You can use a glue stick, if you like, to glue the pages together (WITH THE EXCEPTION OF THE COVER!)
- Stack the pages, so the odd numbers are on top and the folded edges are lined up. Trim with scissors or paper cutter if needed.

#### **COVER PAGE:**

- Fold the cover page along the dotted line, again with the images on the outside.
- OPTIONAL: You can laminate the cover page or print it on cardstock if you want it to be more like a real book's cover.

#### **ASSEMBLE THE BOOK:**

- Open the cover page (like a folder) and slip the pages inside so that when you open the cover you'll see page 1 -- the unfolded edges of the pages will go against the folded part of the cover.
- Close the cover page and tap the book so everything lines up.
- Put three or four staples along the edge to hold the book together.
- Trim again, if needed.
- Flip through the book once, carefully folding the pages to make the book easier for the children to read.

**DLTK's Mini Books**

# The Life of Jesus

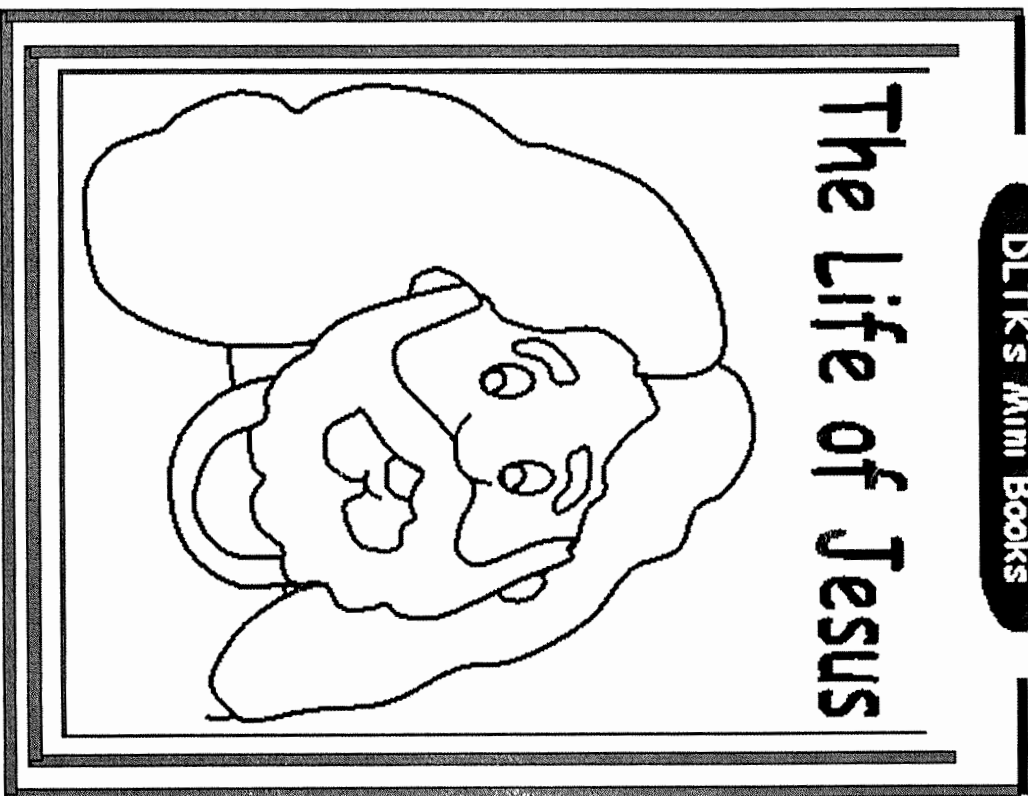

Colored by: \_\_\_\_\_

Created by: Leanne Guenther

**Helping Children Grow**



Free printables from <http://www.dltk-bible.com>



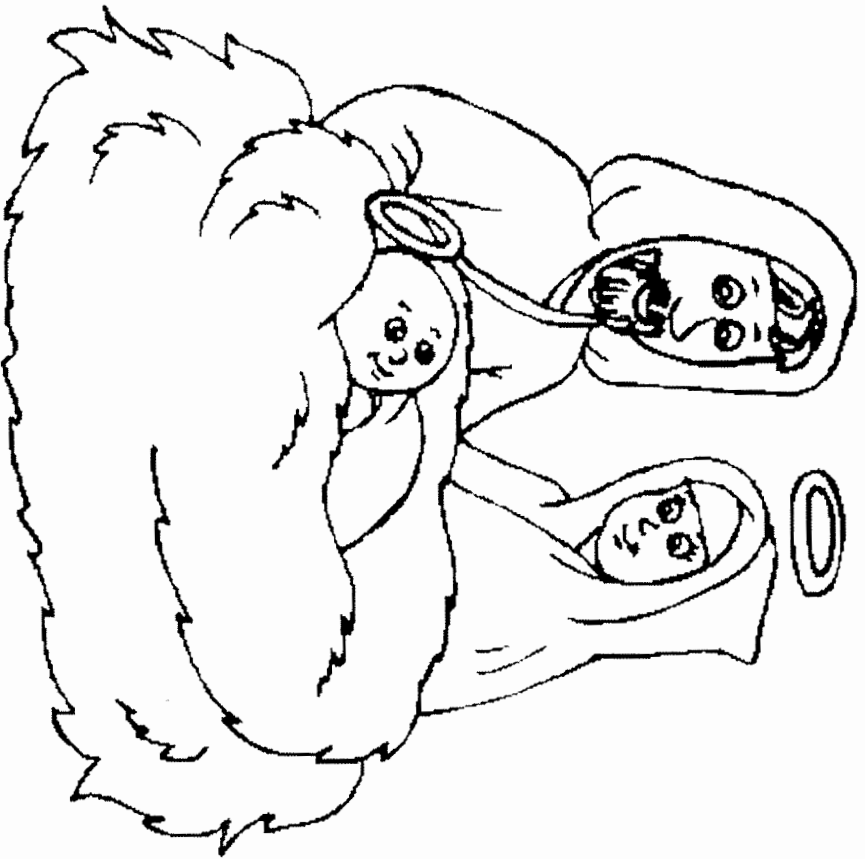

Jesus was born.

1



Jesus was baptized.

2

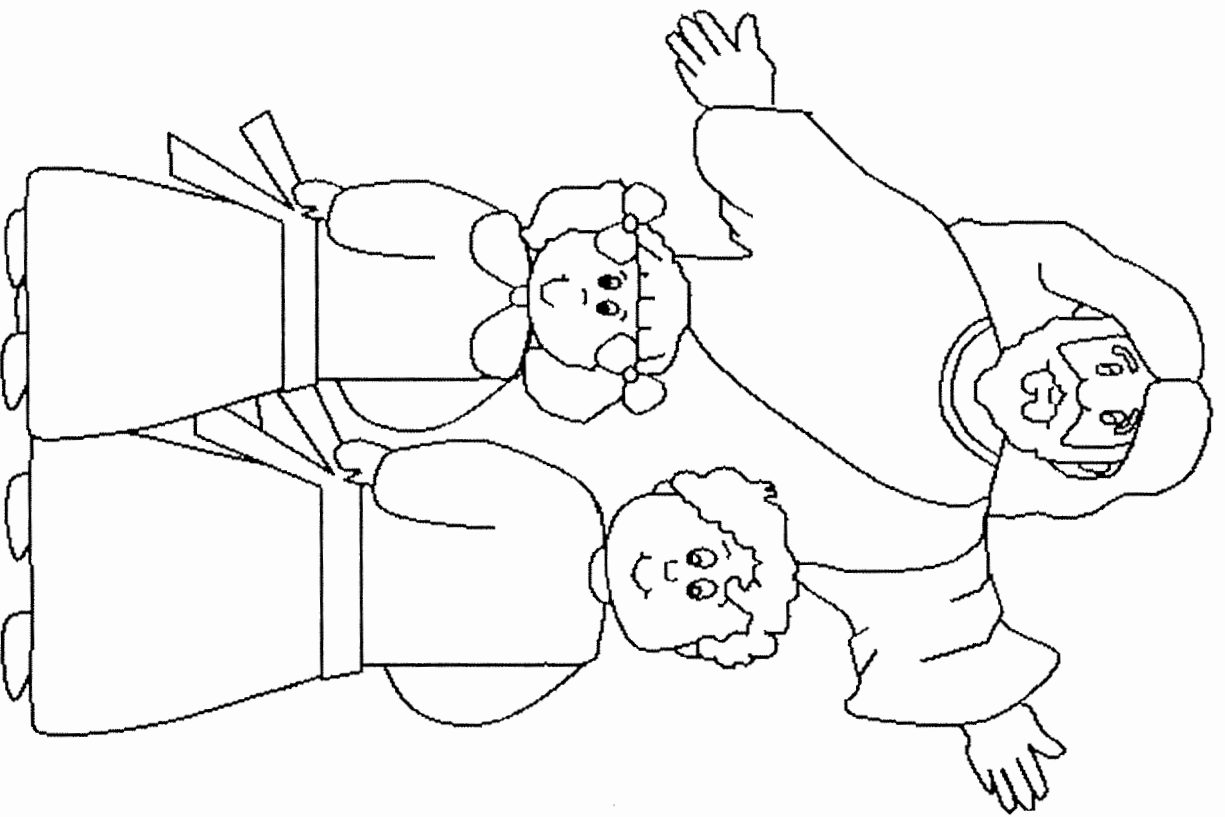

Jesus was a teacher.

3

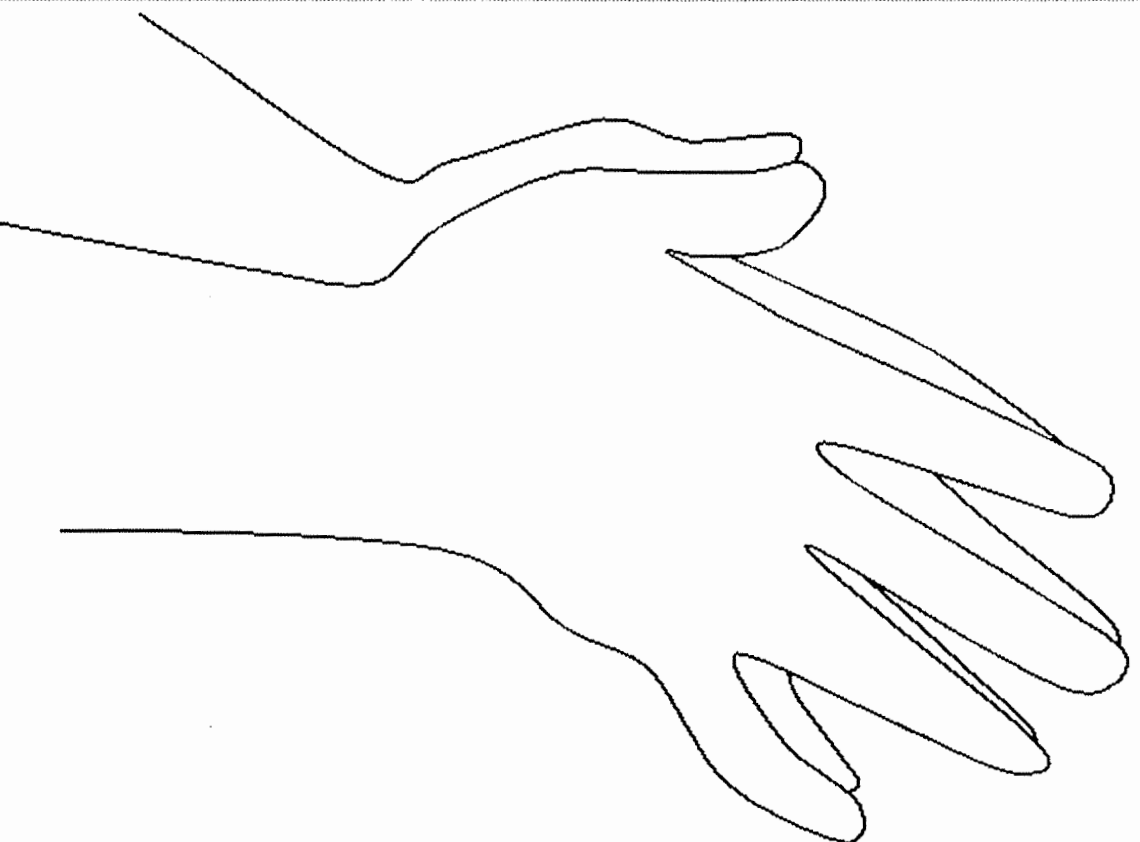

Jesus prayed.

4

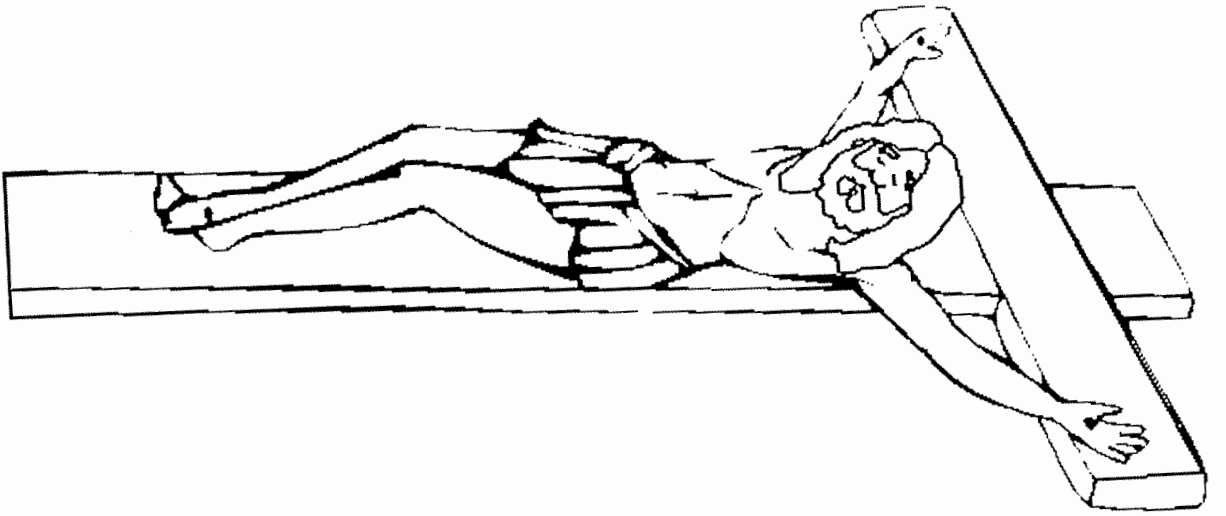

Jesus died for us.

5

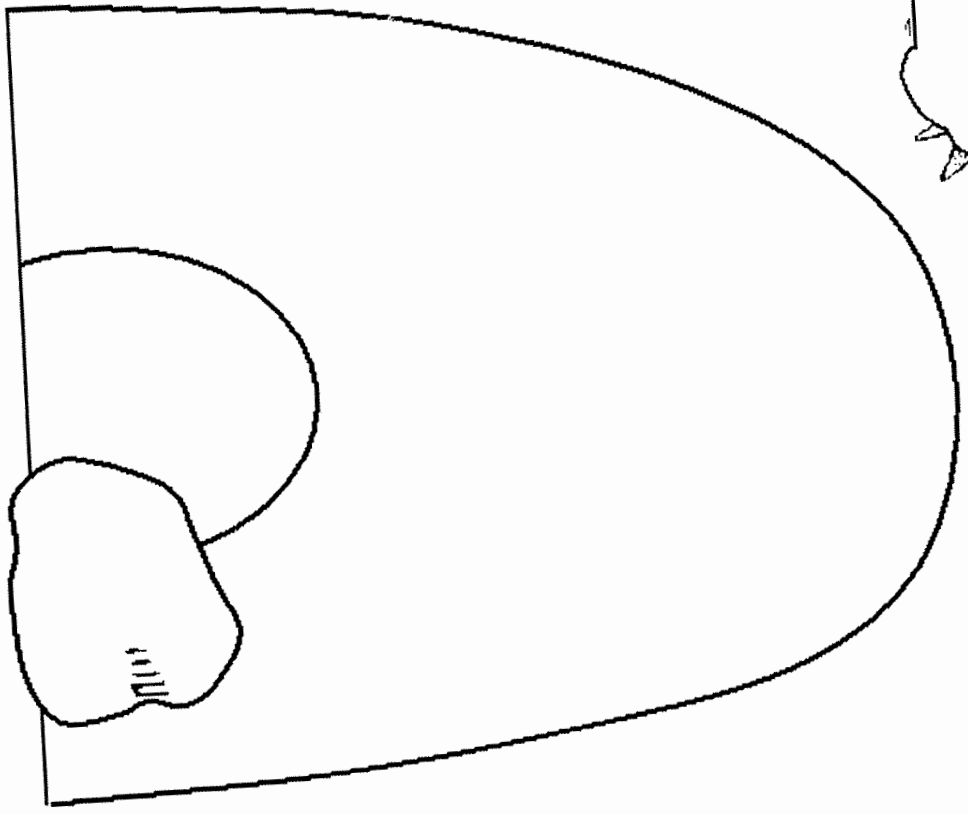
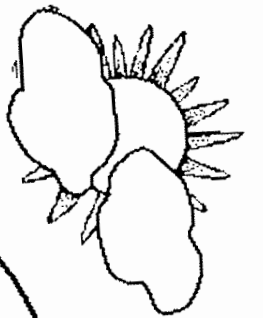

Jesus was buried.

6

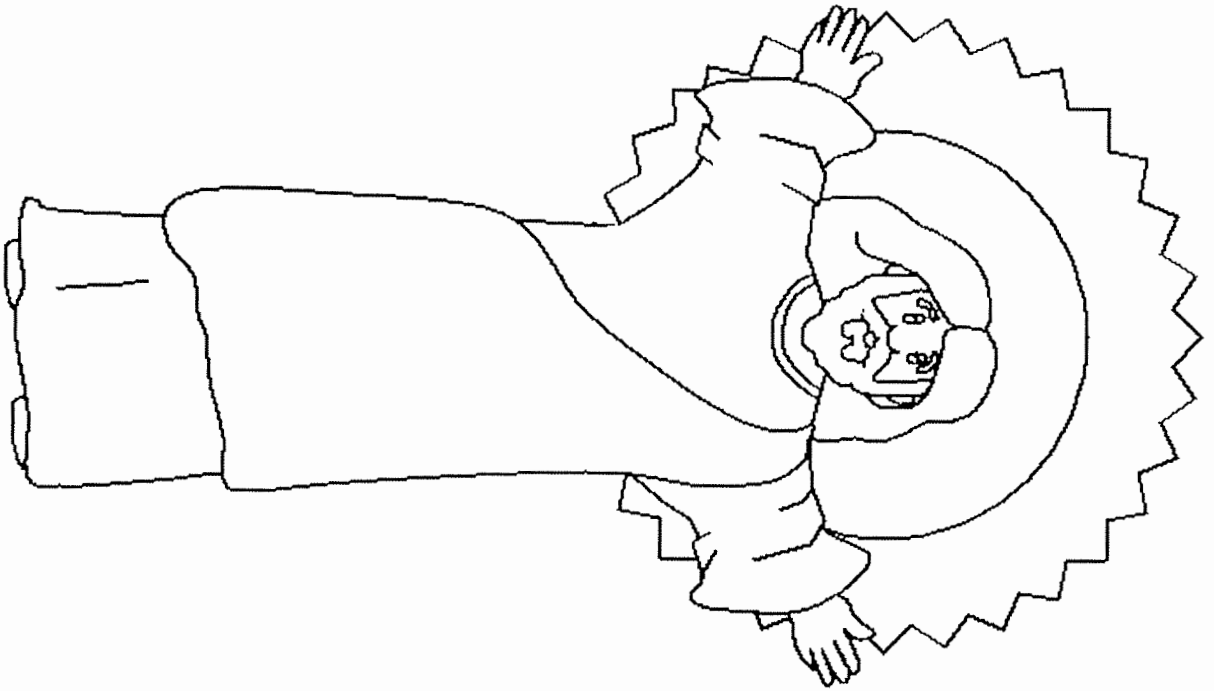

Jesus is risen.

7

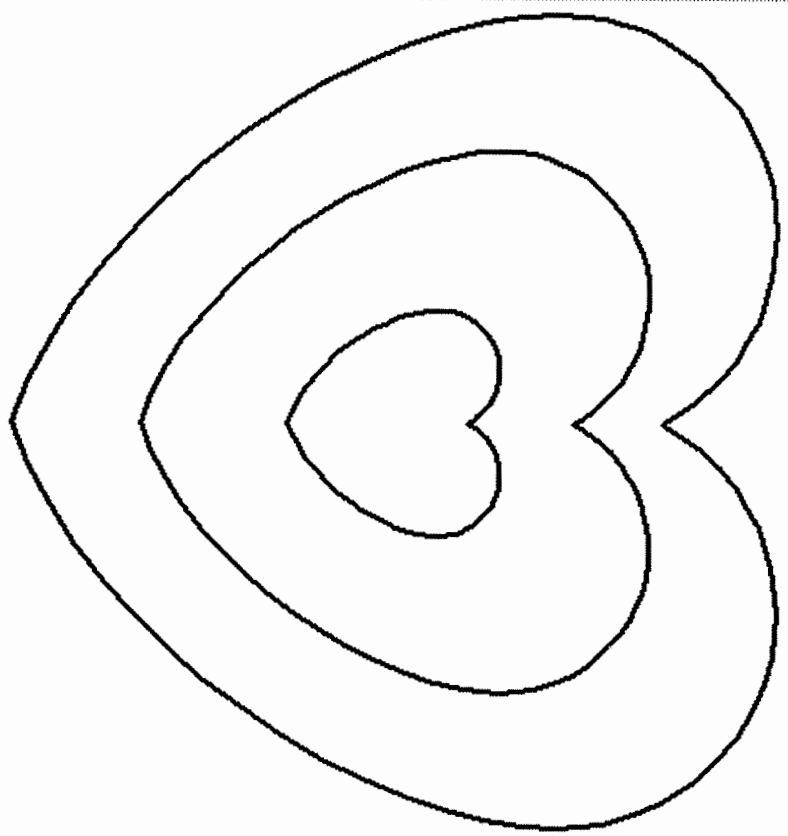

Jesus loves us!

8

## **Year 3**

### **Week 116**

### **God Protects His Son**

**Scriptures: Luke 2:21-52**

**Key Verse: Luke 2:49 “And He said unto them, ‘Why did you seek Me? Did you not know that I must be about my Father’s business?’”**

#### **Key Points:**

1. Joseph and Mary brought Jesus to Jerusalem to present him to the Lord and to offer a sacrifice. Simeon was a just and devout man in Jerusalem, and the Holy Spirit revealed that he would not die before he saw the Lord’s Christ. Simeon took Jesus in his arms and blessed God.

2. Anna, a prophetess, a widow and of great age, departed not from the temple, but served God.

3. When Joseph and Mary had done what the law of Lord required, they returned to Nazareth. Jesus grew and became strong in spirit and wisdom.

4. His parents went to Jerusalem every year for the feast of Passover. When Jesus was 12 years old, they went up to Jerusalem, and when the days were fulfilled they left to return home, but Jesus stayed in Jerusalem and His parents did not know of it.

5. When they were gone a day’s journey, they could not find Jesus. They returned to Jerusalem and it took 3 days to find Him. He was at the temple, sitting with the teachers, and all were astonished at His understanding. When Joseph and Mary saw him, they asked why He had done this. He answered them, but they didn’t understand what He said.

6. Jesus went back to Nazareth and was subject unto His parents. Jesus increased in wisdom, stature, and favor with God and man.

Blessings at  
the Temple  
Luke 2:22-38

# Simeon and Anna Knew

Simeon and Anna were in the temple when Joseph and Mary brought the baby Jesus to be blessed. When Simeon held Jesus, and when Anna saw him, they both knew something very special and important. Color out the names of SIMEON and ANNA in each row of the puzzle. Read the leftover letters to find out what they knew.



SIMEON THEY ANNA SIMEON  
KNEWSIMEONSIMEONANNA  
SIMEON THATSIMEON  
THEY ANNA HAD SIMEON  
SIMEON SEEN ANNA  
THE ANNA SIMEON  
ANNA SAVIORSIMEON

# What Did Jesus Do?

Jesus went to Jerusalem with his parents when he was 12 years old. On their way home, Mary and Joseph could not find him. They were very worried. They looked for three days and finally found Jesus back in Jerusalem. He had been with the teachers in the temple. What did Jesus do when his parents found him?

Color all the spaces not containing a dot to make the answer appear.

**Jesus chose to**

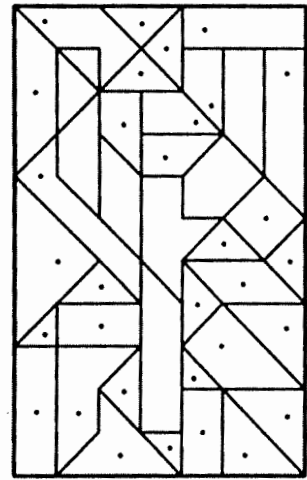
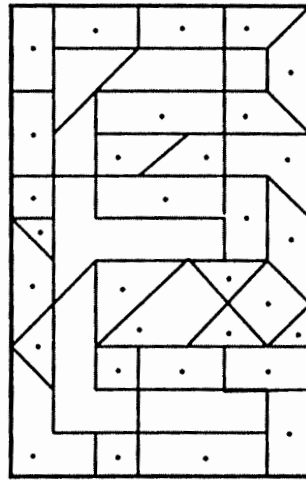
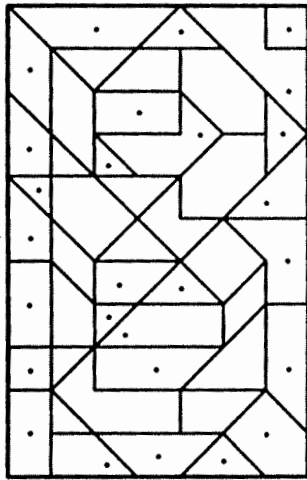
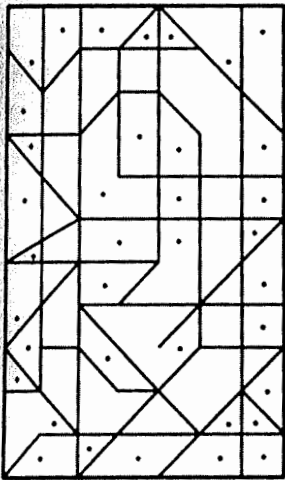

**his parents.**



# Jesus as a Boy

Luke 2:40-51 (NIV)

Jesus "grew and became strong; he was filled with wisdom and the grace of God was upon him." Luke 2:40



Jesus and his family went to Jerusalem every year for a Jewish celebration called the Feast of Tabernacles. When Jesus was twelve years they went once again. After they started to go back home Joseph and Mary discovered that Jesus was not with them, so they turned around and went back to Jerusalem to find him.

Color all the spaces below that have a dot in them to see where they found him.

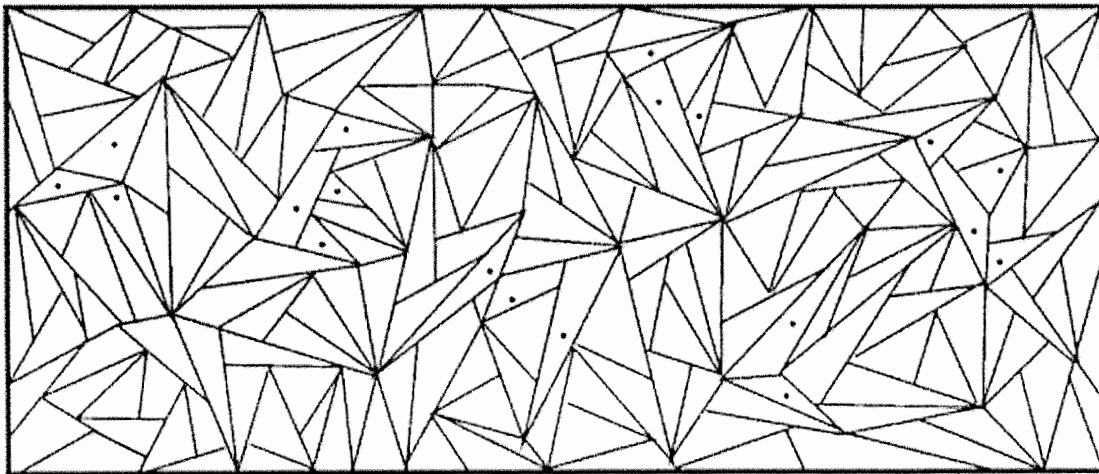

Read Luke 2:46 and fill in the blanks to see what he was doing when they found him.

"sitting among the teachers and \_\_\_\_\_

to them and asking them \_\_\_\_\_ .

Everyone who heard him was \_\_\_\_\_ at

his understanding and his \_\_\_\_\_ ."





At the age of twelve, Jesus went to Jerusalem with His parents for the Passover. On their journey home, Joseph and Mary discovered that Jesus was not in the caravan.

## JESUS IN THE TEMPLE



**They returned to Jerusalem and found Him questioning the wise men in the temple.**

# What Did Jesus Do?

Jesus went to Jerusalem with his parents when he was 12 years old. On their way home, Mary and Joseph could not find him. They were very worried. They looked for three days and finally found Jesus back in Jerusalem. He had been with the teachers in the temple. What did Jesus do when his parents found him?

Color all the spaces not containing a dot to make the answer appear.

**Jesus chose to**

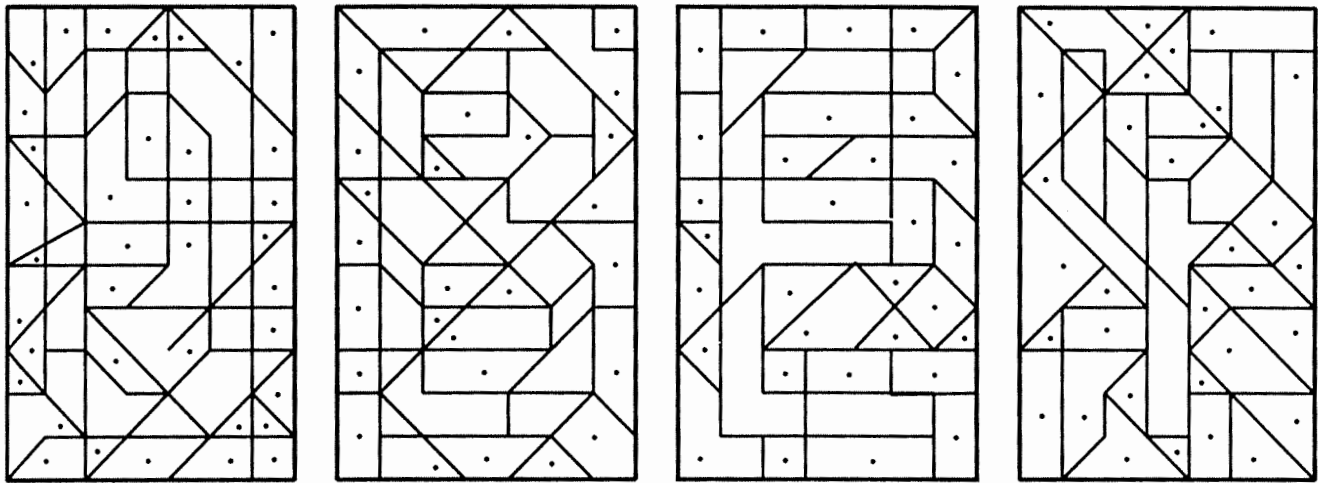

**his parents.**



# The Boy Jesus in the Temple

"Why were you searching for me?" he asked. "Didn't you know I had to be in my Father's house?" Luke 2:49 (NIV)

Each line of the puzzle has one word hidden in a list of random letters. The blank space is a missing letter that belongs to that word. Fill in the missing letter.

1.	L	R	E	L	A	T	I	V		S	A	N	R	D	H	H	W
2.	S	I	E	A	G	P	Q	H		U	S	E	G	O	K	X	V
3.	E	M	R	V	L	B	B	T		M	P	L	E	U	E	Z	K
4.	G	F	D	N	L	Z	H	O		E	P	R	P	O	B	Q	V
5.	Q	X	B	O	F	R	I	E		D	S	V	D	E	K	O	J
6.	Y	H	P	I	A	G	E	F		A	S	T	D	S	Z	X	A
7.	D	E	G	O	S	E	A	R		H	I	N	G	J	C	Q	W
8.	O	V	Y	I	U	P	A	R		N	T	S	B	J	W	S	Y
9.	X	Q	T	E	A	C	H	E		S	T	E	H	P	X	L	L
10.	W	L	B	H	D	K	C	M		T	H	E	R	D	G	E	V

parents	home	friends	teachers	searching
feast	relatives	temple	mother	house

# On the Trail

.....

In this box of letters, trace over the trail that spells out the second question Jesus asked. (Move right, left, up, down, or diagonally.)

.....

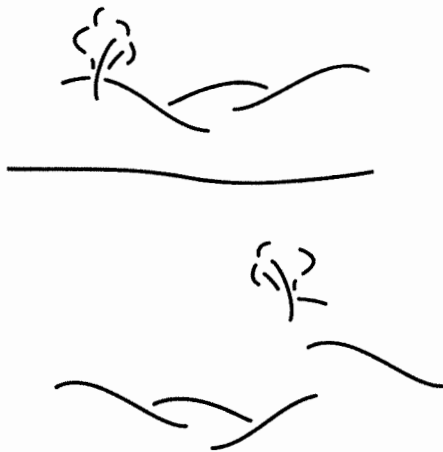
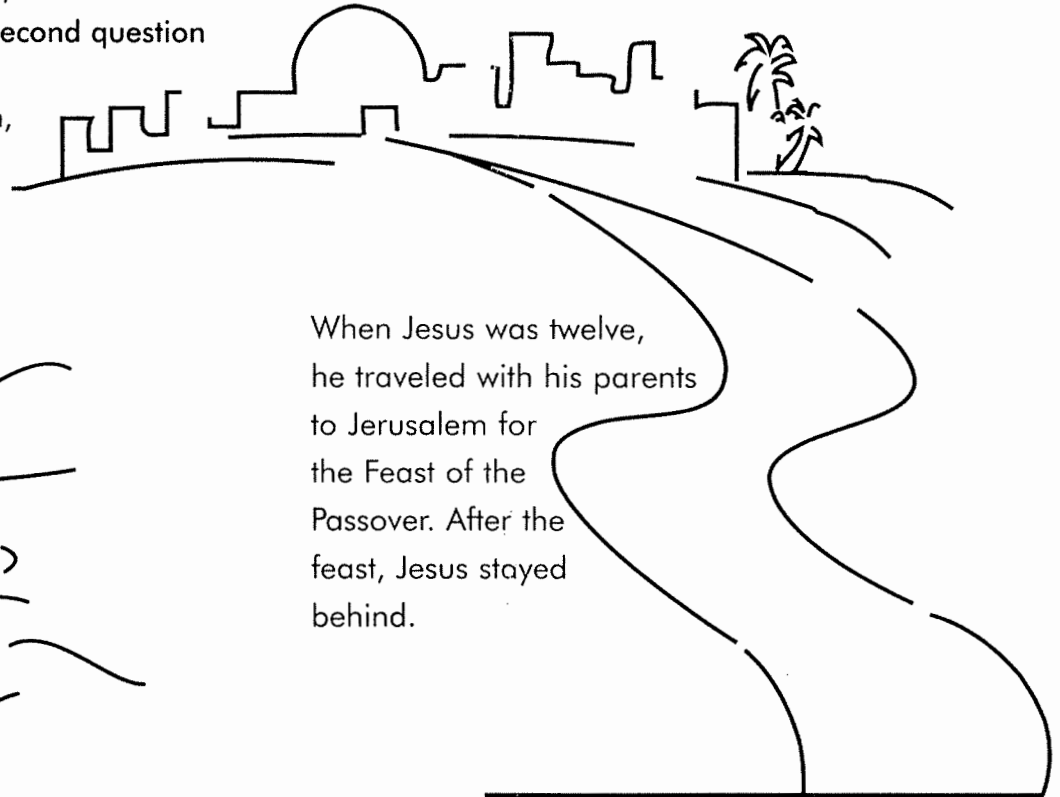

When Jesus was twelve, he traveled with his parents to Jerusalem for the Feast of the Passover. After the feast, Jesus stayed behind.

His parents searched and searched, and finally found him in the temple. Jesus asked them why they were searching. He also asked them another question.

D	O	T	Y	P	A	K	B
I	N	M	L	O	U	N	K
D	H	B	O	I	J	O	W
O	B	E	A	T	G	F	I
M	N	I	D	E	D	A	H
Y	C	A	B	H	E	R	A
G	F	H	T	U	O	H	S
F	E	D	E	S	C	B	A

# THE BOY JESUS VISITS THE TEMPLE

(LUKE 2 :39-52)

U N B P Q Q Z O K T F D Q D L Y G U Y R L K B A U  
 G G K P I J E N S R O V N L U S P O T D U M A I M  
 I K K R L I M H H R J B Y U W M S L W C G Z M L B  
 C B O Y H J D I F P W T E A C H E R U G C B Z R Y  
 E Y R B T C E E M W E G M F Q U O O G S V I B U R  
 U A J O Y T A R J P S S A L N B T U H T U Z T U T  
 M K Q S O S W U U N S C O Y I S W I T C E J B U S  
 B P S L T C Q A T S I Z S J S E I I B Q B M P C T  
 M U P K A J B F A K A H V H V J N B V U N F P Q C  
 K Y M W V W I F A B A L Y B U M A R S E H Z Z L M  
 U F B V C Y T T U C S K E O U G Z W U E B B F N E  
 Y K B J A J A Q E D G U K M A O A G B L A D V R P  
 Y T O B L T L H N W W K S I D V R T H I U K F U M  
 R G C W O N B A Q K A R W E D S E K U L V B H K L  
 F E H H Z A Z P B I F E L R J P T W Q A A U N B C  
 H Y S E I S Z U A E U N W F W T H I T G E Y E I S  
 E G S L M L N U N S T C W Y T W H U P M I E E F G  
 L M R V F L D T A P S V Z B L B E M L J S E M W E  
 M Q V D M P K T Y I O O O D A H V F J Q G J J L Y  
 G H N D Q U O D Q Y M C V F O J L O B L J A Q J U  
 M V G Z S T B D U B J C A E A Y E E J J P V V B W  
 B V D Z Q N H Q Q B K H K B R K W P H T Z K E B I  
 P G P O V D F C T P G R U E P P T K T W F U V K A  
 M S K W P R V U H P H E N H A G J J J K B O V J C  
 W N S H B A I J T Y G M U T D K D F Y M B Z L K L

CHILD  
 FEAST  
 GALILEE  
 JERUSALEM  
 JESUS

JOSEPH  
 MARY  
 NAZARETH  
 PASSOVER

SUBJECT  
 TEACHER  
 TEMPLE  
 TWELVE

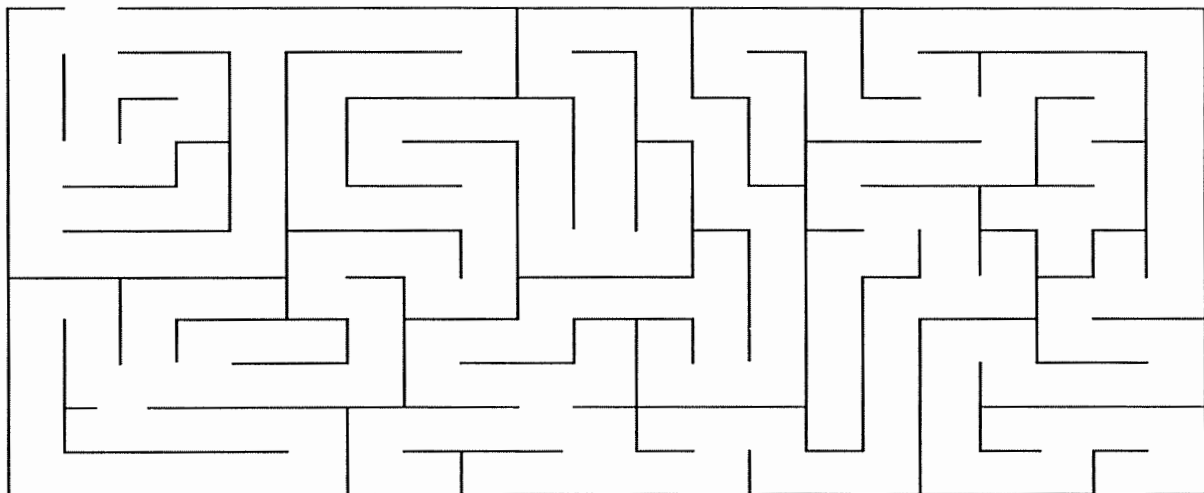

# THE BOY JESUS VISITS THE TEMPLE

## (LUKE 2:39-52)

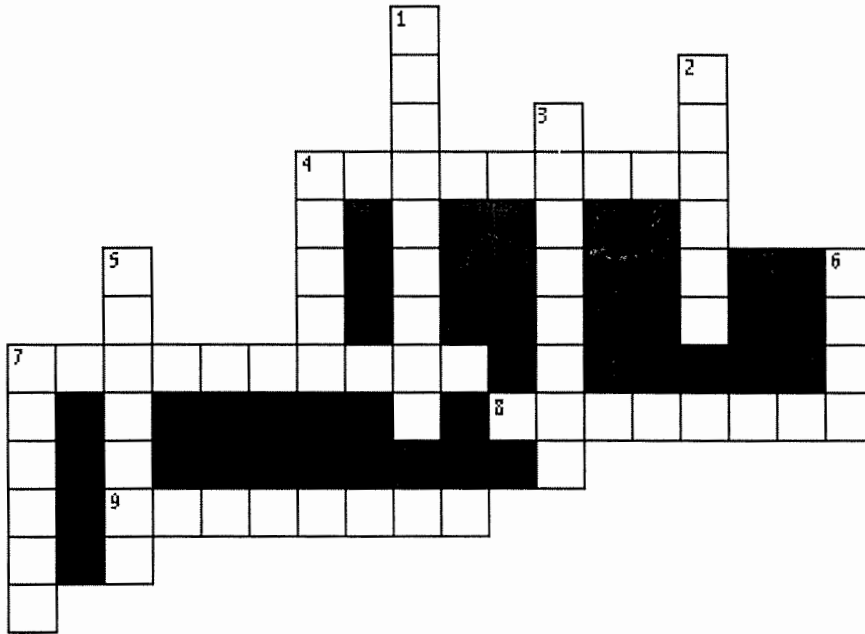

- 3 DOWN "His parents went to Jerusalem every year at the Feast of the \_\_\_\_." **LUKE 2:41**
- 4 ACROSS "And when He was twelve years old, they went up to \_\_\_\_ according to the custom of the feast." **LUKE 2:42**
- 4 DOWN "When they had finished the days, as they returned, the Boy \_\_\_\_ lingered behind in Jerusalem. And Joseph and His mother did not know it." **LUKE 2:43**
- 6 DOWN "...but supposing Him to have been in the company, they went a \_\_\_\_ journey, and sought Him among their relatives and acquaintances." **LUKE 2:44**
- 9 ACROSS "So when they did not find Him, they \_\_\_\_ to Jerusalem, seeking Him." **LUKE 2:45**
- 2 DOWN "Now so it was that after three days they found Him in the \_\_\_\_..." **LUKE 2:46**
- 8 ACROSS "...sitting in the midst of the \_\_\_\_, both listening to them and asking them questions." **LUKE 2:46**
- 7 ACROSS "And all who heard Him were \_\_\_\_ at His understanding and answers." **LUKE 2:47**
- 7 DOWN "So when they saw Him, they were \_\_\_\_; and His mother said to Him, 'Son, why have You done this to us? Look, Your father and I have sought You anxiously.'" **LUKE 2:48**
- 5 DOWN "And He said to them, 'Why is it that you sought Me? Did you not know that I must be about My \_\_\_\_ business?'" **LUKE 2:49**
- 1 DOWN "And Jesus \_\_\_\_ in wisdom and stature, and in favor with God and men." **LUKE 2:52**

**Year 3**

**Week 117**

## **Baptism of Jesus**

**Scriptures: Matthew 3; Mark 1:1-12; Luke 3:1-23**

**Key Verse: Mark 1:10-11** “And immediately, coming up from the water, He saw the heavens parting, and the Spirit descending upon Him like a dove. Then a voice came from heaven, ‘You are my beloved Son, in whom I am well pleased.’”

### **Key Points:**

1. John the Baptist wore clothes of camel’s hair, a girdle of skin about his waist and ate locust and wild honey.
2. John the Baptist baptized in the wilderness of Judea in the Jordan River. He preached a baptism of repentance for the remission of sins. People from all over the land of Judea and of Jerusalem went to him, and were all baptized by him, confessing their sins.
3. Jesus came from Nazareth of Galilee to the Jordan River to be baptized of John
4. When John and Jesus came out of the water, the heaven opened, and the Spirit of God descending like a dove upon him. And there came a voice from heaven, saying, “You are my beloved Son, in whom I am well pleased.”
5. Then Jesus was led up by the Spirit into the wilderness to be tempted of the devil.



# Ready for Jesus



Jesus



clothes



camel



locust



desert



people

























kingdom



Heaven



dove

 and John were cousins. John was called John the Baptist. His  were made of  hair. His food was s and wild honey. He preached in the . He preached to the  of Israel. He said, "Change your hearts. The  of  is coming soon. Get ready." Ready for what? Ready for . Many  listened to John the Baptist preach. Many  changed their hearts. John baptized these . They were ready for . Then one day  came to John.  asked John to baptize Him. When  was baptized,  opened. A  came from . The  sat on . A voice from  said, "You are my Son and I love you. I am very pleased with you."



John Baptizes Jesus  
*Matthew 3, Luke 2, John 1*

# God's Message for His Son

Matthew 3:13-17

When Jesus was about 30 years old, His friend, John the Baptist began to preach to the Jewish people. He told them to repent from their sins and he baptized people who turned away from their sin. Jesus asked John to baptize Him too. John didn't want to baptize Jesus because He wasn't sinful, but Jesus insisted and so John did baptize Him too. By being baptized, Jesus showed that He promised to obey God. After Jesus was baptized, the Holy Spirit came down on Jesus like a dove and God's voice spoke from heaven.

Use the code in the rectangle to decode God's message for His Son, Jesus, and write it on the lines.

Code:

A	B	C	D	E	F	G	H	I	J	K	L	M
N	O	P	Q	R	S	T	U	V	W	X	Y	Z

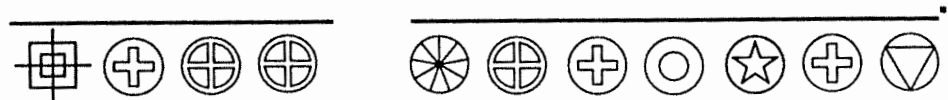
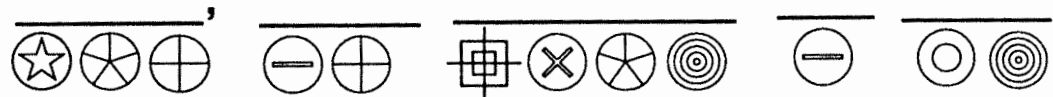

Matthew 3:17

# Ready to Search

Search for the 6-letter words in the story "Ready for Jesus." Circle them in the box of letters below.

Look in all directions!



A	B	L	E	G	O	P	E	N	E	D	G	B
W	D	L	U	F	T	I	U	R	F	N	U	V
S	S	C	A	M	E	L	Z	I	E	A	R	T
G	T	A	D	F	I	N	S	S	H	B	T	R
H	Y	R	B	G	S	R	N	L	D	S	D	E
C	H	E	A	S	A	F	O	L	U	B	C	S
A	E	O	D	E	O	F	C	C	T	H	O	E
E	A	R	L	R	H	R	O	H	D	A	M	D
R	V	I	O	K	S	L	S	U	A	A	I	Q
P	E	O	T	J	O	H	N	E	Z	N	N	U
M	N	K	R	C	A	L	L	E	D	S	G	I
S	S	T	I	E	L	H	E	E	D	E	D	E
D	L	E	L	P	O	E	P	P	R	H	T	R

Matthew 3:14-15

Fill in the blanks using the New King James Version of the Bible.

And John *tried to* \_\_\_\_\_ Him, saying,

“I \_\_\_\_\_ to be \_\_\_\_\_ by You, and

are You \_\_\_\_\_ to me?”

But \_\_\_\_\_ answered and said to him,

“\_\_\_\_\_ *it to be* \_\_\_\_\_ now, for thus

it is \_\_\_\_\_ for us to \_\_\_\_\_ all

\_\_\_\_\_.” Then he \_\_\_\_\_ Him.

"Scripture taken from the New King James Version. Copyright © 1982 by Thomas Nelson, Inc. Used by permission. All rights reserved."

# The Baptism of Jesus

B E V O D S Z T R Q D J  
R N Q N T W N E J U E O  
I I O J O N L E U J V R  
D S K L S A P Y V H O D  
E E Z I T P A B A A L A  
G F R I E N D I K H E N  
R R V M I S S I O N B H  
O E E J B S T I R I P S  
O V O A E M X C I N Z U  
M H Z M T S A B V G Q L  
N O B N E E U L E I L P  
X O X M R G R S R S C C

BAPTIZE  
DOVE  
HEAVENS  
JORDAN  
MISSION  
SIGN

BELOVED  
FRIEND  
JESUS  
LAMB  
RELATIVE  
SON

# John the Baptist

## Prepares the Way for Jesus - Matthew 3 (NIV)

God had a special work for John the Baptist. He was to prepare the people so they could accept God's son. First they needed to repent of their sins. The prophet Isaiah prophesied about John.

Read what he said in Matthew 3:3

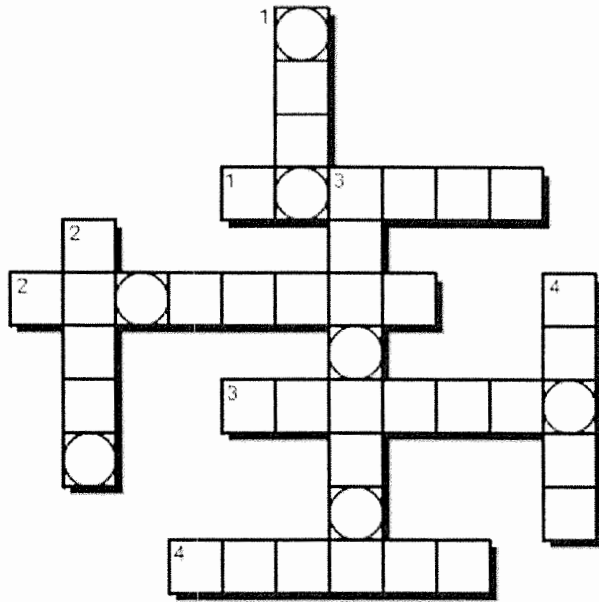

### Across:

1. John's message was to \_\_\_\_\_ .  
(vs.2)
2. Jesus came from Galilee to the Jordan river to be \_\_\_\_\_ by John. (vs.13)
3. John ate \_\_\_\_\_ and honey in the desert. (vs.4)
4. Many people confessed their sins and were baptized by John in the \_\_\_\_\_ river.  
(vs.6)

### Down:

1. When Jesus came out of the water John saw the spirit of God descent like a \_\_\_\_\_ on Jesus. (vs.16)
2. John wore clothes made of \_\_\_\_\_ hair. (vs.4)
3. John \_\_\_\_\_ in the desert of Judea. (vs.1)
4. \_\_\_\_\_ asked John to baptize him.  
(vs.13-15)

Take the letters that are circled in the crossword puzzle above and unscramble them to see what God had to say about His Son Jesus after he was baptized by John.

A voice from heaven said, "This is my Son, whom I love; with him I am well \_\_\_\_\_ ." (vs.17)

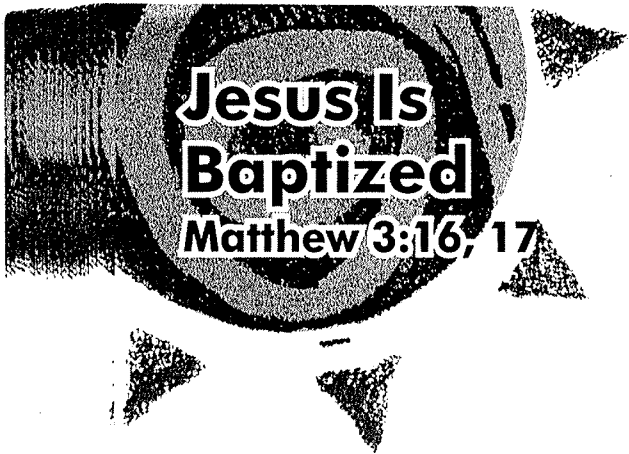

# God's Son

Connect the dots in order from A to Z to make a picture of the word missing from the Scripture below.

Z ● ● A      F ●      G ●  
 Y ●      B ●      E ●      H ●  
           D ●      I ●  
           C ●      J ●      M ●  
 X ●      Jesus was baptized and came  
           up out of the water. Heaven  
           opened, and he saw God's Spirit  
           coming down on him like a \_\_\_\_\_.  
 W ●      And a voice spoke from heaven. The voice said,  
           "This is my Son and I love him.  
           V ●      I am very pleased with him."  
 U ●      O ●  
           R ●      Q ●      P ●  
 T ●  
           S ●





**Jesus Begins  
His Ministry**  
Luke 3, 4

# Wilderness Maze

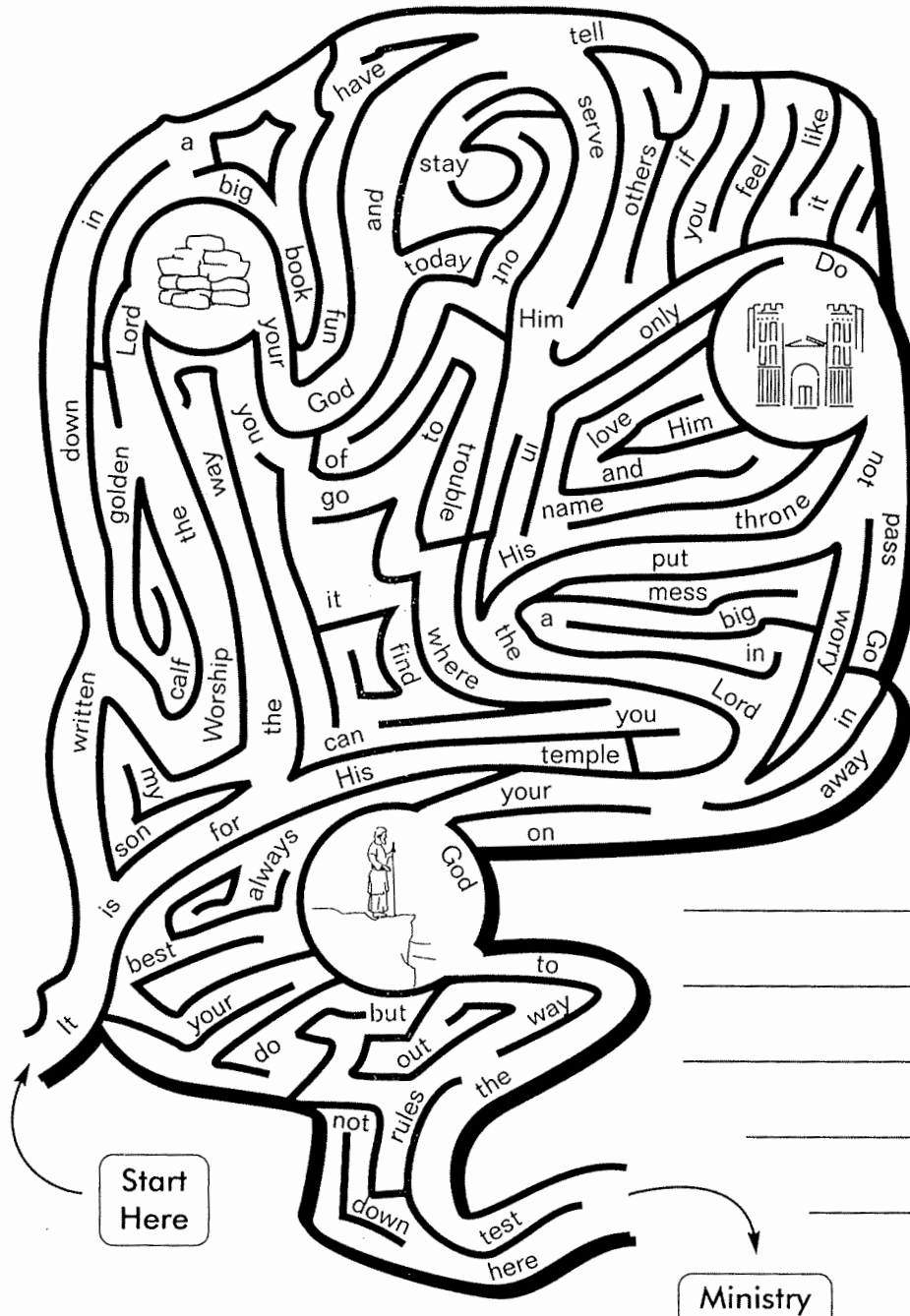

After Jesus was baptized, he went into the wilderness for forty days. There, the devil tempted him three times, but Jesus did not give in.

Find the path that takes Jesus through the devil's temptations and out into the world to begin his ministry. Write the words you find along the path in order on the lines below to find two responses Jesus made to Satan.

---



---



---



---



---

# Jesus is Baptized Crossword

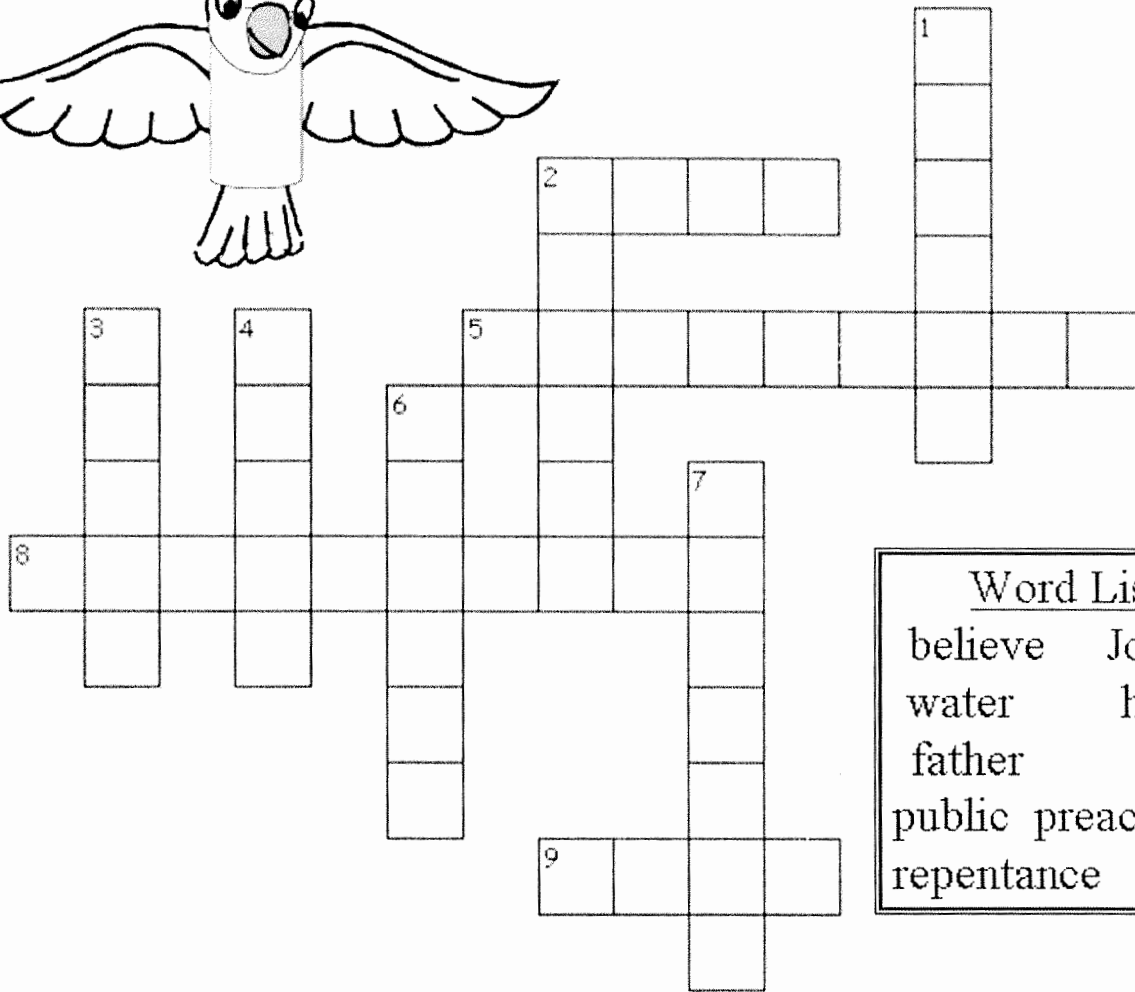
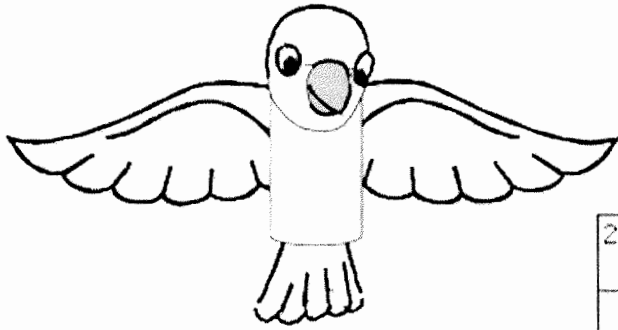

Word List:  
believe    Jordon  
water      honey  
father     John  
public preaching  
repentance    dove

## Across

2. He prepared the way for Jesus.
5. John the Baptist was doing a lot of this along with baptizing others.
8. As a Christian it is important to ask for forgiveness and mean it, this is called\_\_\_\_\_.
9. This came out of the sky to Jesus right after he was baptized.

## Down

1. Baptism is a \_\_\_\_\_ display of our belief in God.
2. The name of the river where Jesus was baptized.
3. Something sweet that John ate in the wilderness.
4. This is used a symbol to wash our sins away.
6. We are should be baptized in the name of the \_\_\_\_\_, Son and the Holy Spirit.
7. This is the main thing you need to do before you are baptized.

## The Baptism of Jesus

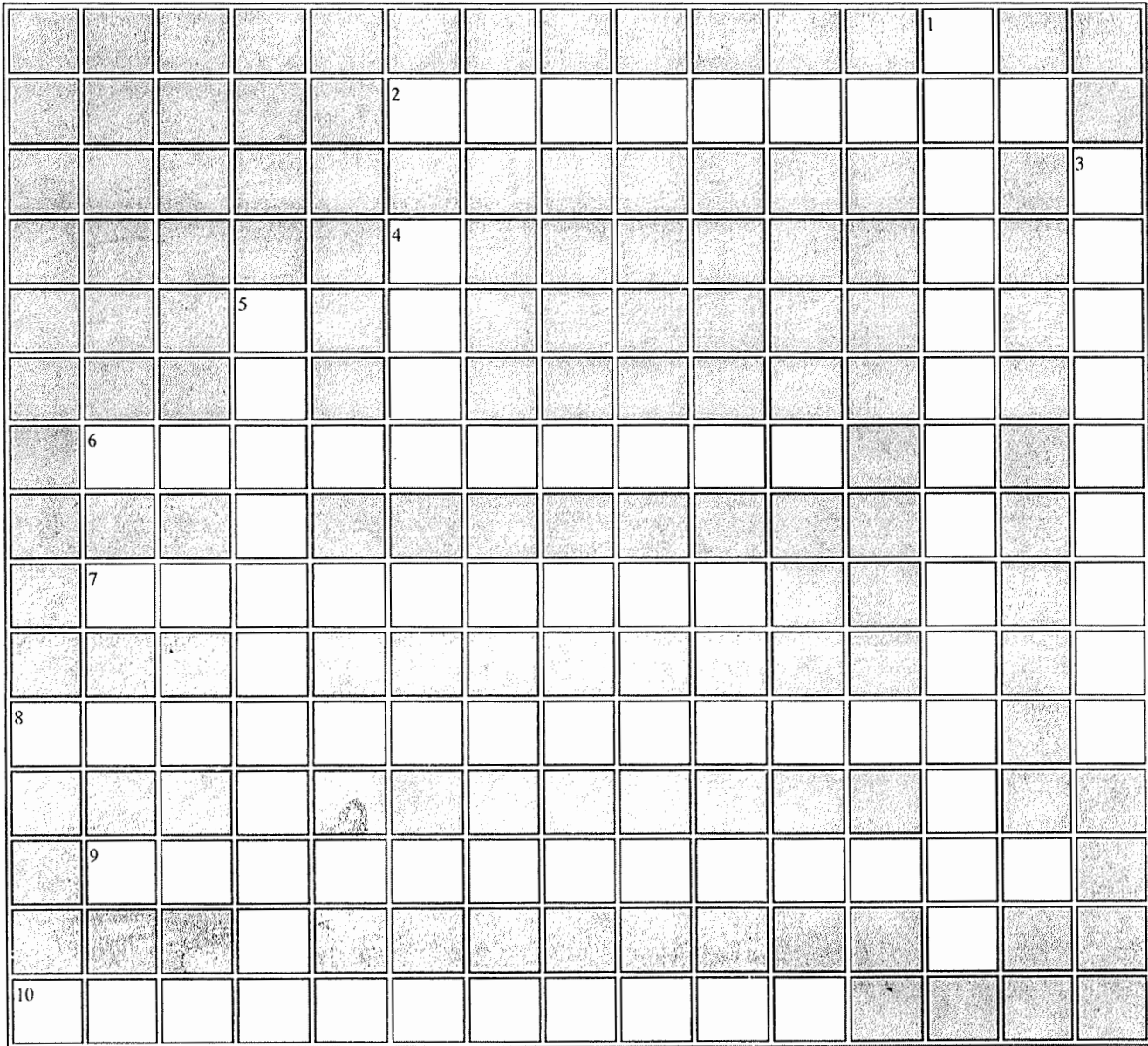

### Across

### Down

- |                                                                                                                                                                                                                                                                     |                                                                                                                                                                                 |
|---------------------------------------------------------------------------------------------------------------------------------------------------------------------------------------------------------------------------------------------------------------------|---------------------------------------------------------------------------------------------------------------------------------------------------------------------------------|
| <p>2. John called Jesus the ____.</p> <p>6. John described himself as a friend of the ____.</p> <p>7. John's mother</p> <p>8. John said Jesus must ____.</p> <p>9. Jesus was baptized to fulfill all ____.</p> <p>10. the place where John was baptizing people</p> | <p>1. John prepared people for the ____.</p> <p>3. Jesus was God in ____.</p> <p>4. a bird that came down and rested on Jesus</p> <p>5. The ____ was in the form of a bird.</p> |
|---------------------------------------------------------------------------------------------------------------------------------------------------------------------------------------------------------------------------------------------------------------------|---------------------------------------------------------------------------------------------------------------------------------------------------------------------------------|

WORD BANK: JORDAN RIVER, RIGHTEOUSNESS, DOVE, SPIRIT OF GOD, ELIZABETH HUMAN FORM, COMING OF CHRIST, BRIDEGROOM, BECOME GREATER, LAMB OF GOD

## **Year 3**

### **Week 118**

#### **Temptation of Jesus**

**Scriptures: Matthew 4:1-10; Luke 4:1-15**

**Key Verse: Matthew 4: 4,7,10** “Man shall not live by bread alone, but by every word that proceeds from the mouth of God; You shall not tempt the Lord your God; You shall worship the Lord your God, and Him only you shall serve.”

#### **Key Points:**

1. Jesus, being full of the Holy Spirit, was led into the wilderness to be tempted of the devil. After Jesus fasted 40 days and 40 nights he was hungry.
2. The devil tempted Jesus three times. The first temptation was, “If you are the Son of God, command stones that these stones become bread.” Jesus replied, “Man shall not live by bread alone, but by every word that proceeds from the mouth of God.”
3. The devil took Jesus to Jerusalem and set him on the pinnacle of the temple. The Devil said, “If your are the Son of God, throw Yourself down.” Jesus said, “You shall not tempt the Lord your God.”
4. The devil took Jesus to a high mountain and showed him all the kingdoms of the world. The Devil said he would give Jesus all things, if Jesus would fall down and worship him. Jesus said, “You shall worship the Lord your God and Him only you shall serve.”
5. When the devil ended all his temptations, he departed from Jesus and the angels came and ministered until him. Jesus returned to Galilee and the fame of Jesus went throughout the region. Jesus taught in their synagogues.



Satan Tempts Jesus  
*Matthew 4*

**Jesus Is  
Tempted  
Matthew 4:10**

# No! No! No!

Jesus was led by God's Spirit into the desert to spend time praying. He ate nothing for 40 days and nights. When he was very hungry, Satan tried to tempt him with food. Jesus said, "No!" Then Satan tried to make him prove that he was God's Son. Jesus said, "No!" Then Satan promised to give Jesus power if he would bow down to him. Jesus said, "No!" Find the other words that Jesus used to send Satan away by coloring all the spaces containing the word "NO."

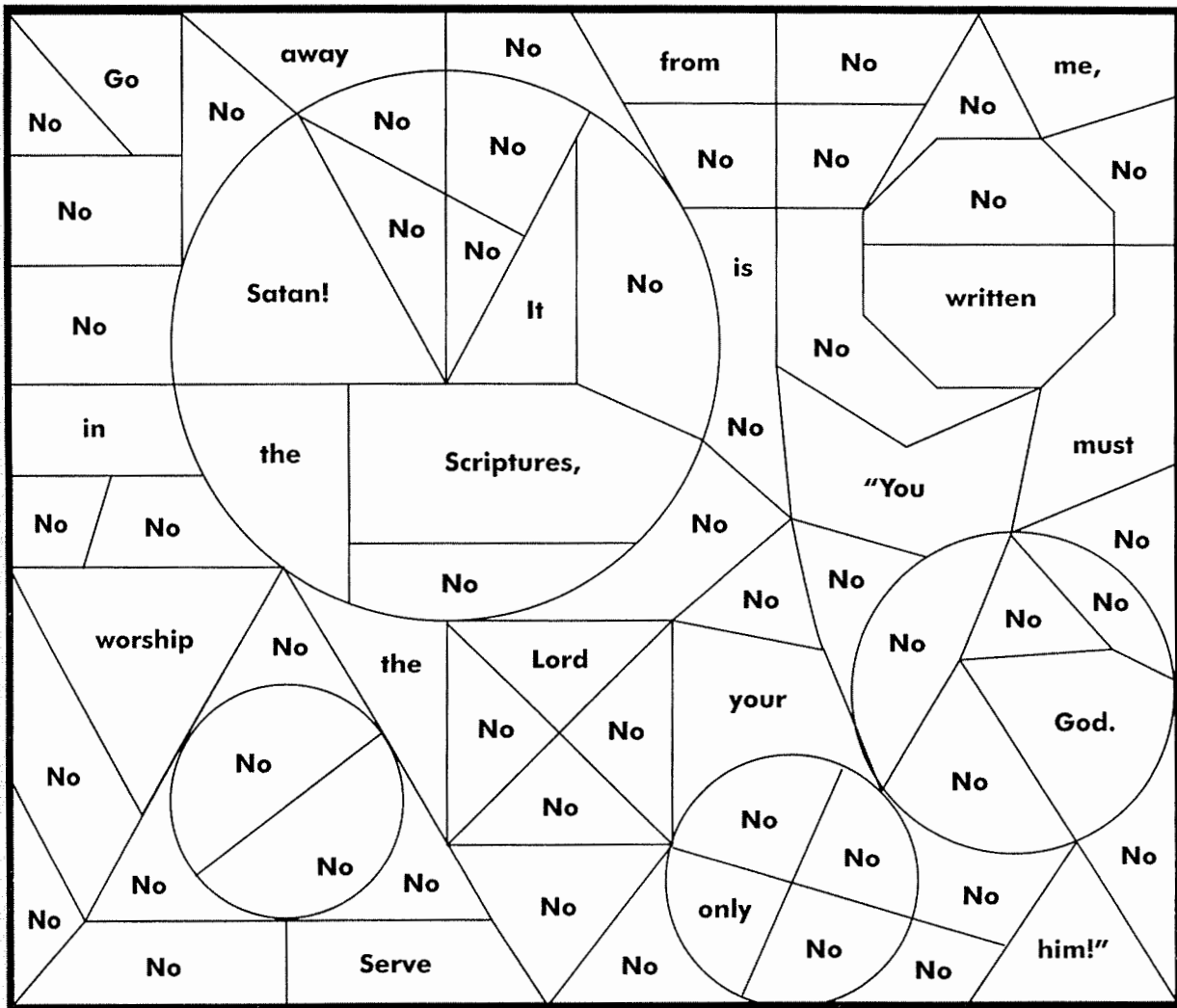

# Jesus' Temptation

Matthew 4:1-11

Then \_\_\_\_\_ was led by the \_\_\_\_\_ into the \_\_\_\_\_ to be tempted by the devil. After \_\_\_\_\_ forty days and forty nights, he was \_\_\_\_\_ . The tempter came to him and said, "If you are the Son of God, tell these \_\_\_\_\_ to become bread." Jesus answered, "It is \_\_\_\_\_: 'Man does not \_\_\_\_\_ on bread alone, but on every \_\_\_\_\_ that comes from the \_\_\_\_\_ of God.'" Then the \_\_\_\_\_ took him to the holy \_\_\_\_\_ and had him stand on the \_\_\_\_\_ point of the \_\_\_\_\_ . "If you are the \_\_\_\_\_ of God," he said, "throw yourself \_\_\_\_\_ . For it is written: "'He will command his \_\_\_\_\_ concerning you, and they will \_\_\_\_\_ you up in their \_\_\_\_\_ , so that you will not strike your \_\_\_\_\_ against a stone.'" Jesus \_\_\_\_\_ him, "It is also written: 'Do not \_\_\_\_\_ the Lord your God to the \_\_\_\_\_.'" Again, the devil \_\_\_\_\_ him to a very high \_\_\_\_\_ and showed him all the \_\_\_\_\_ of the \_\_\_\_\_ and their \_\_\_\_\_ . "All this I will \_\_\_\_\_ you," he said, "if you will bow down and \_\_\_\_\_ me." Jesus said to him, "\_\_\_\_\_ from me, \_\_\_\_\_ ! For it is written: 'Worship the \_\_\_\_\_ your God, and \_\_\_\_\_ him only.'" Then the devil \_\_\_\_\_ him, and angels came and \_\_\_\_\_ him.

A E H M I P F J A S T R O Z H O F W R E D I  
 A T X D O R Y O T R S Z L T N D S F I L T E J J  
 T T E N D E R A S G D K A F N B G O U H D V Z A W A Y L  
 H U N G I V V E N Q T W S E L V I T U P R  
 U N G I V V E N Q T W S E L V I T U P R  
 T T E N D E R A S G D K A F N B G O U H D V Z A W A Y L  
 H U N G I V V E N Q T W S E L V I T U P R  
 A T X D O R Y O T R S Z L T N D S F I L T E J J  
 A E H M I P F J A S T R O Z H O F W R E D I



# Jesus is Tempted by Satan

Luke 4:1-13

After Jesus was baptized, He went to the wilderness. He did not eat for 40 days. When He was weak and hungry, Satan came to tempt Jesus. Temptation is wanting to do something that seems attractive or good, but is really wrong. Satan offered Jesus many things that seemed attractive or good, but Jesus did not do the wrong things. Jesus will help people who trust Him overcome their temptations too.

The hidden words in this puzzle come from this story in Luke 4:1-13. The code following each word tells the coordinates where one of the letters of the word is found in the puzzle. After you have found and circled all the hidden words, start at the upper left and use all the leftover letters to fill in the blanks at the bottom of the page with the words of a Bible verse which tells what we should do when we are tempted.

	A	B	C	D	E	F	G	H	I	J	K	L	M	N			
ALONE (9D)	1	D	S	N	O	I	T	A	T	P	M	E	T	P	U	1	MOMENT (5J)
ANGELS (6H)	2	E	H	B	M	I	I	T	S	E	O	Y	O	O	U	2	PINNACLE (11G)
ANSWERED (16F)	3	W	V	U	R	R	S	E	L	L	M	W	V	E	S	3	POWER (5I)
BEHIND (13M)	4	E	T	I	N	O	S	A	E	S	E	P	H	E	R	4	RETURNED (8G)
BREAD (9L)	5	H	P	E	L	G	S	F	G	R	N	O	L	R	T	5	SEASON (4E)
CAST (10G)	6	S	E	T	O	U	E	G	N	S	T	O	N	E	S	6	SERVE (15M)
DASH (13B)	7	O	D	R	R	E	N	R	A	S	R	I	S	U	O	7	SHEWED (3A)
DELIVERED (15K)	8	T	R	E	T	U	R	N	E	D	T	D	S	H	H	8	SPIRIT (2E)
ENDED (12D)	9	E	J	D	N	E	E	N	V	D	A	E	R	B	G	9	STONE (6I)
HANDS (16C)	10	P	I	L	A	O	D	C	N	D	J	L	H	E	Y	10	TEMPLE (4K)
HOLY GHOST (13N)	11	E	I	W	I	E	L	C	A	N	N	I	P	H	L	11	TEMPTATION (1L)
HUNGERED (7G)	12	L	L	H	D	F	I	A	L	S	S	V	E	I	O	12	TIME (15J)
JERUSALEM (6E)	13	E	D	A	S	H	W	R	I	T	T	E	N	N	H	13	WILDERNESS (12F)
JESUS (10J)	14	F	R	N	O	R	M	Y	O	U	I	R	R	D	J	14	WORSHIP (14E)
LIVE (5D)	15	A	M	D	E	S	O	F	O	U	M	E	R	V	S	15	WRITTEN (13I)
LORD (7J)	16	E	V	S	A	N	S	W	E	R	E	D	E	N	E	16	
		A	B	C	D	E	F	G	H	I	J	K	L	M	N		

**HIDDEN VERSE:** \_\_\_\_\_  
 \_\_\_\_\_  
 \_\_\_\_\_



## **Year 3**

### **Week 119**

#### **Jesus Calls His Apostles**

**Scriptures: Matthew 4:18-25; John 1:35-51; John 2:1-12**

**Key Verse: Matthew 4:19** “Then He said to them, ‘Follow Me, and I will make you fishers of men’.”

#### **Key Points:**

1. Jesus was walking by the Sea of Galilee and saw two brothers, Peter and Andrew, fishing. Jesus asked them to follow Him, and they left their nets and followed Jesus.

2. Jesus saw two other brothers, James and John, sons of Zebedee, in a ship with their father mending nets. Jesus called them, and immediately they left the ship and their father, and followed Jesus.

3. Jesus went about Galilee teaching in the synagogues, healing all sickness and diseases among the people, and his fame went throughout all Syria and great multitudes of people followed him.

4. Philip was from the city of Bethsaida, the same city as Peter and Andrew. Philip finds Nathanael and tells him to come and see, that they had found Jesus of Nazareth. Jesus saw Nathanael under a fig tree before Philip spoke to him.

5. The mother of Jesus, his disciples, and Jesus were at a wedding in Cana. They ran out of wine at the feast, and Jesus’ mother told the servants to do whatever Jesus told them to do. The servants filled 6 water pots with water and took it to the master of the feast. When the master tasted the water that was made into wine, he didn’t know where it came from, but he said that they had saved the good wine until the last of the feast.

6. This was the first miracle that Jesus performed.

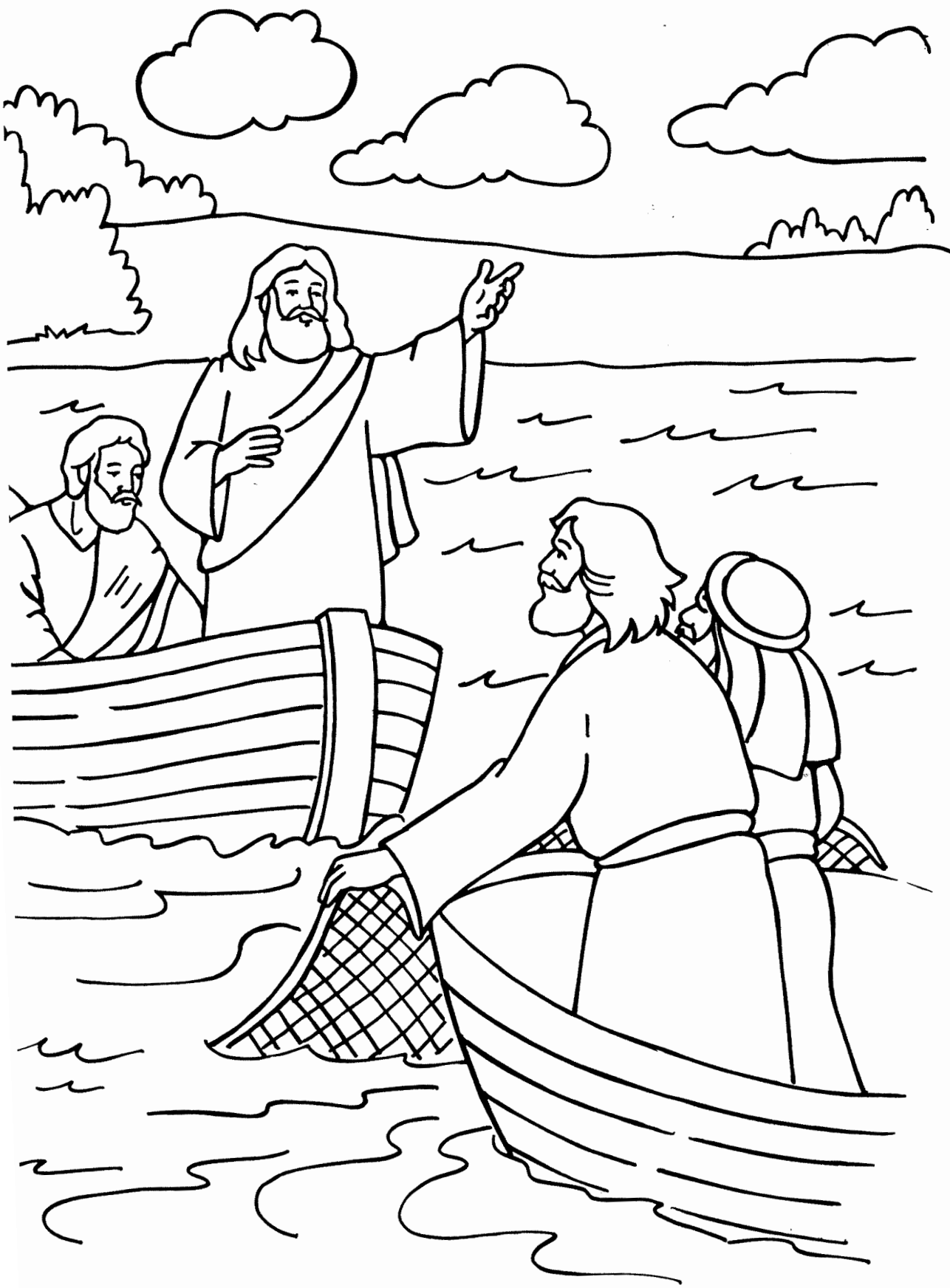

Jesus Chooses Four Followers  
*Mark 1, Luke 5*

Word Bank:

Peter	Andrew	James	John	Philip
Bartholomew	Thomas	Matthew	James	
Thaddaeus	Simon		Judas	

\_\_\_ h \_\_\_

J \_\_\_\_\_ son of Alphaeus

\_\_\_ d \_\_\_

\_\_\_ i \_\_\_

A \_\_\_\_\_

\_\_\_ a d \_\_\_\_\_

\_\_\_ a \_\_\_

P \_\_\_\_\_ e \_\_\_\_\_

\_\_\_ i \_\_\_\_\_ the Cananite

\_\_\_ a r \_\_\_\_\_

M \_\_\_\_\_

\_\_\_ h \_\_\_



ake a happy smile on each follower's face. Can you say the name of each follower?

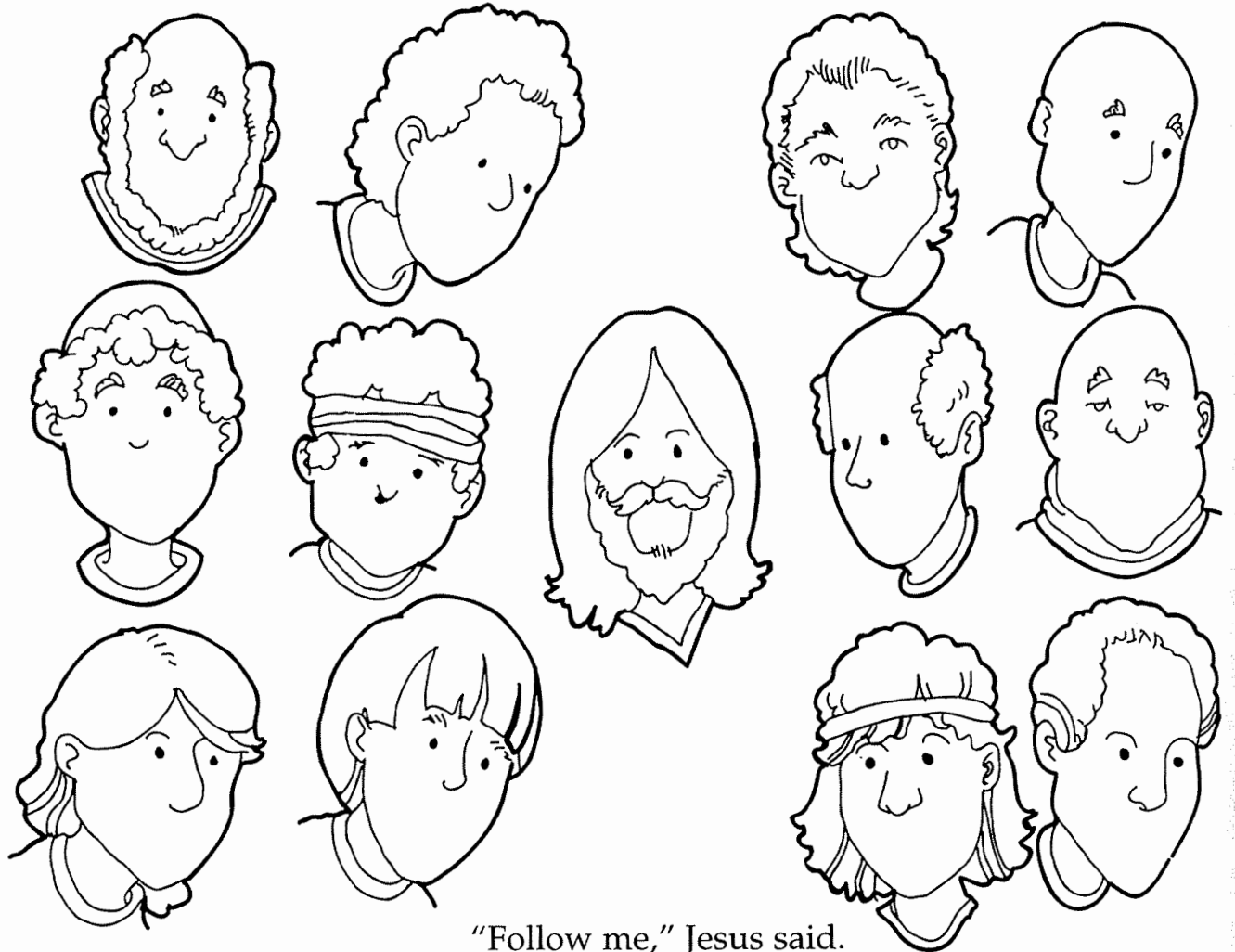

"Follow me," Jesus said.  
Luke 5:27

**The Twelve**  
**Matthew 9;**  
**Luke 6; John 1**

# Following Jesus

.....  
The apostles  
are ready  
to follow  
Jesus. They  
want to  
learn from  
him and  
help him in  
his ministry.  
Can you help  
them find  
the right  
path? Mark  
the route.  
There's only  
one right  
way to go!  
.....

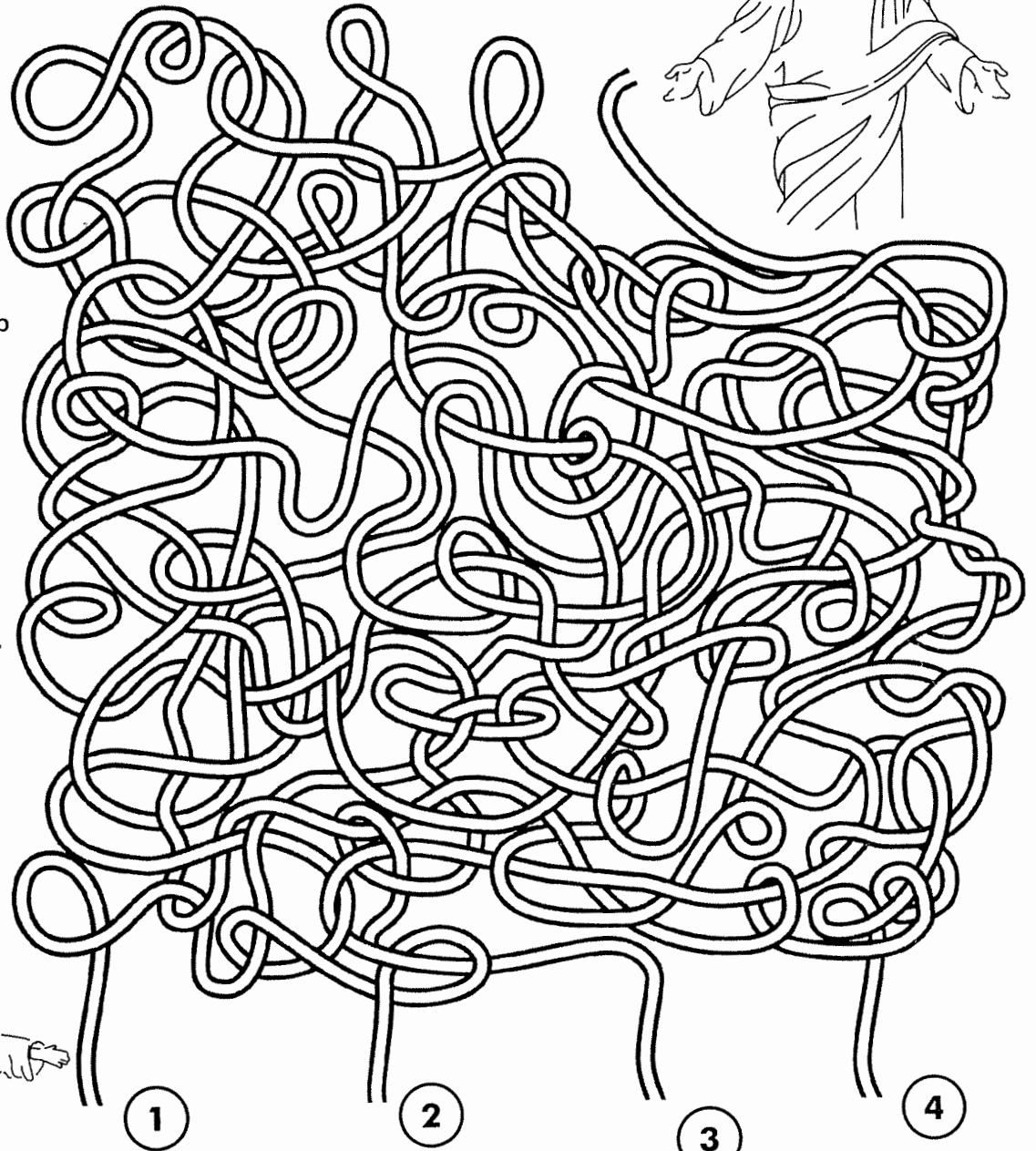
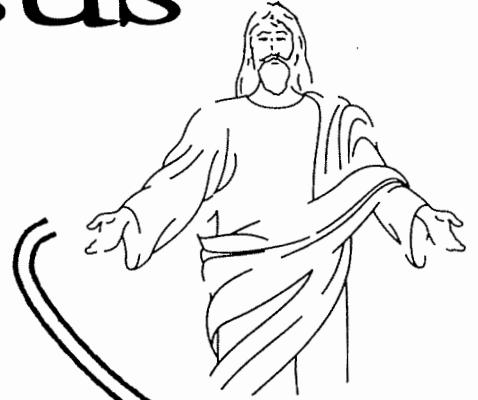

## Disciples Story Board

Let the children draw a picture above each part of the story. Let the children color them then cut them out and place them on construction paper.

## The Twelve Friends

<p>Pictures</p>		
<p>One day there was a crowd of people who came to watch Jesus teach by Lake Galilee.</p>	<p>"Row me out into the lake" said Jesus to a fisherman named Peter. He preached to the people from a boat.</p>	<p>Afterwards, Jesus and the fishermen rowed the boat out further to try and catch some fish.</p>
<p>Pictures</p>		
<p>They had not caught any fish the night before and were very sad.</p>	<p>But the night that Jesus was on the boat with them they caught so many fish their nets nearly broke!</p>	<p>"I want you to stop fishing in the sea and become a fisher of men!" said Jesus. And so these fishermen became the first of the twelve disciples.</p>

# Twelve Disciples Crossword

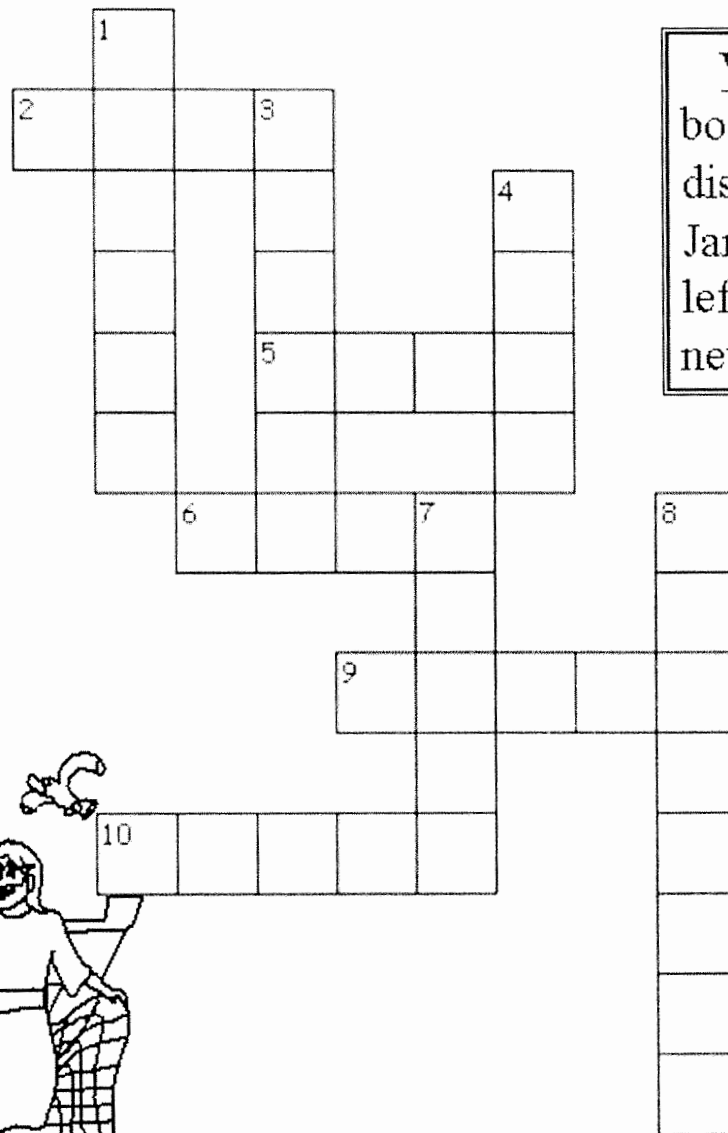

Word List:	
boat	follow
disciple	heal
James	learn
left	Simon
nets	twelve



## Across

2. Jesus sometimes taught from inside this.
5. The disciples \_\_\_\_ everything and followed Jesus.
6. Jesus gave the disciples authority to drive out evil spirits and \_\_\_\_ every disease.
9. John's brothers' name.
10. From this disciple's boat Jesus taught and performed a miracle with fish.

## Down

1. Jesus said, "\_\_\_\_ me and I will make you fishers of men".
3. This is the number of disciples Jesus chose.
4. Jesus told the disciples to let down their \_\_\_\_ and suddenly were able to catch fish.
7. We can be Jesus' disciples by trying to \_\_\_\_ all we can about Him.
8. The name for follower of Jesus Christ.



# Jesus Chooses 12 Apostles

Luke 5:1-11, Mark 3:13-18 (NIV)



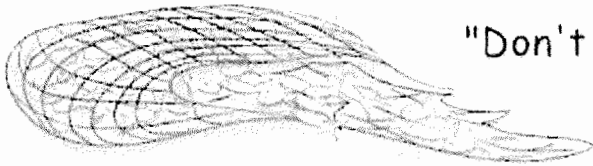





Jesus chose 12 special friends to help him in preaching to the people. You can read the story of how he invited Peter the fisherman to be one of his Apostles in Luke 5:1-11. Jesus performed a miracle to illustrate to Peter what he wanted Peter to do. Read what he did and fill in the blanks below from verse 10.



"Don't be afraid; from now on you will \_\_\_\_\_."

Luke 5:10

In Mark 3:13-18 we read the names of the 12 that he chose. Unscramble the names below and place the letters from the shapes into the matching shapes below.

ERTPE		_____
SMJAE	_____	
OJNH	_____	_____
NDAEWR		_____
PLPIHI	_____	
ARMEWTHOLOB	_____	
THMATWE	_____	_____
OMHSAT	_____	
MESAJ	_____	_____
DTHDAESU		_____
MISON	_____	_____
ASJUD	_____	

These were the names of the 12

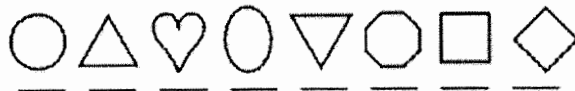

**Jesus'  
Disciples  
Matthew 4, 10**

# Disciple Kriss Kross

Look up Matthew 10:2-4 to get the facts. Then fill in the twelve disciples' names in the puzzle below.

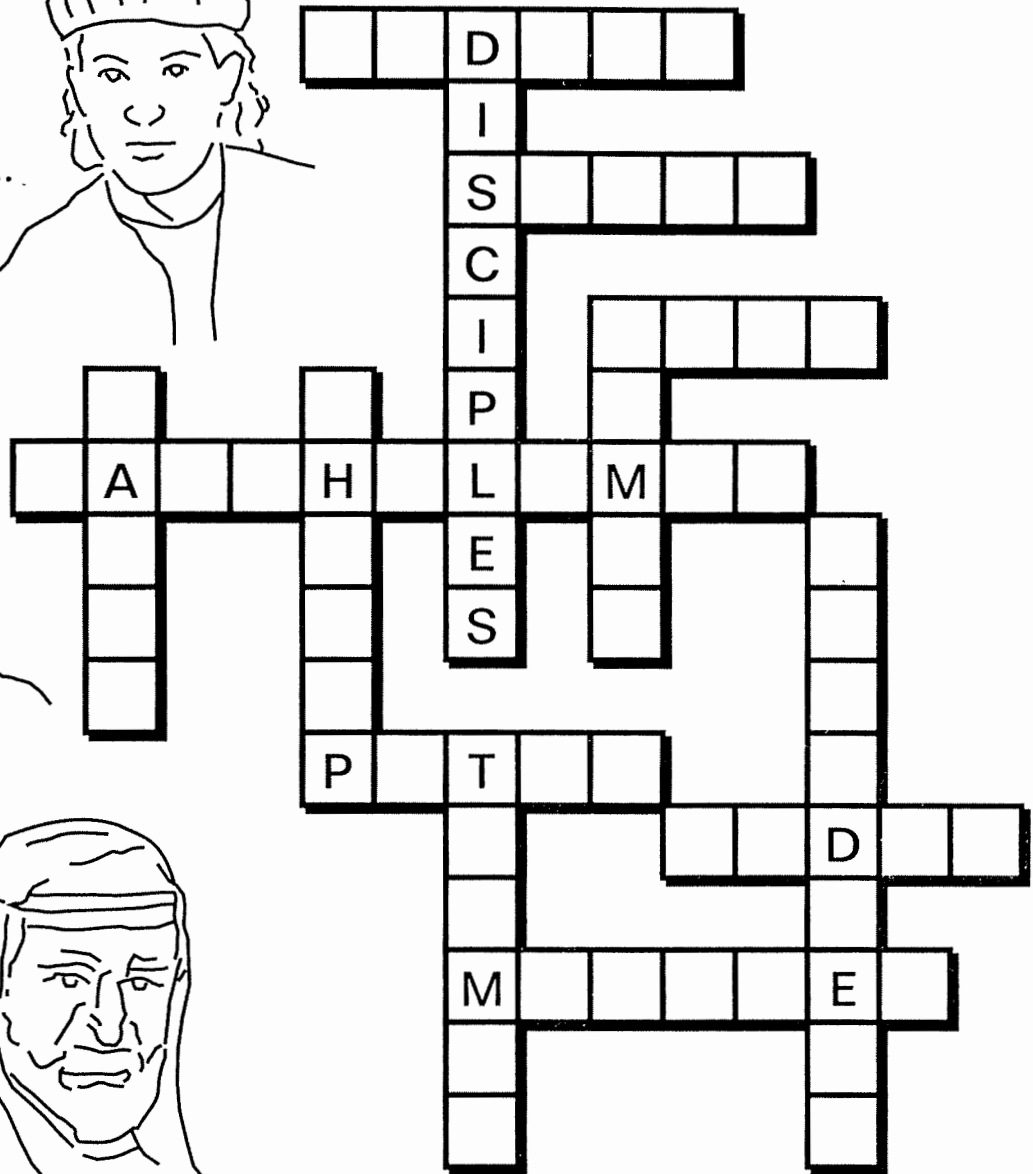



**Jesus Calls  
Followers  
John 1:35-51**

# Follow Me

When Jesus chose some of his followers he said to them, "Come and follow me. I will make you fishermen for men." Follow the paths to find the four men Jesus found by Lake Galilee. When you reach each name, unscramble the letters. All four paths begin at START.

Start

TANALENAH      DWEARN      MISNO TEREP      PPLIIH

# Meet the Twelve Disciples

Mark 3:16-19

Jesus chose twelve men to be His special helpers as He preached and told God's messages to the people. Jesus also sent these twelve men out to preach and teach. Jesus chose many different kinds of men to help Him. Some of the disciples were fisherman, one was a tax collector, and others did different work. This shows us that Jesus can use anybody to do His work.

Unscramble the names of the twelve disciples. Then use the clues and Scripture verses to write the number of each disciple on the line in front of the correct statement about him.

- |                                       |                                                                                                                                        |
|---------------------------------------|----------------------------------------------------------------------------------------------------------------------------------------|
| 1. SMNOI TREPE _____                  | _____ I am called "Zelotes" because I was part of a group called the Zealots who wanted to turn against the Romans. <i>(Luke 6:15)</i> |
| 2. WRENAD _____                       | _____ I am the brother of Peter. We were both fishermen. <i>(Matthew 4:18)</i>                                                         |
| 3. MAJES _____                        | _____ I cried after I denied I knew Jesus three times. <i>(Matthew 26:69-75)</i>                                                       |
| 4. HNOJ _____                         | _____ I introduced my friend Nathanael to Jesus. <i>(John 1:43-51)</i>                                                                 |
| 5. HILIPP _____                       | _____ I wanted to actually touch Jesus before I would believe He was alive. <i>(John 20:24-29)</i>                                     |
| 6. WAMOLOBHTER _____                  | _____ I was a tax collector when Jesus said, "Follow Me." <i>(Matthew 9:9)</i>                                                         |
| 7. WATHMET _____                      | _____ I'm the one who betrayed Jesus for money. <i>(Matthew 26:14-16)</i>                                                              |
| 8. STAMOH _____                       | _____ Jesus took me, my brother James, and Peter with Him when He was transfigured. <i>(Matthew 17:1-2)</i>                            |
| 9. SEMAJ HET NSO<br>FO SHUEPALA _____ | _____ My brother John, our father Zebedee and I were fishermen too. <i>(Matthew 4:21)</i>                                              |
| 10. DHTAASEUD _____                   | _____ My father's name is Alphaeus. Another disciple has the same name as I do. <i>(Luke 6:14-15)</i>                                  |
| 11. MSONI HTE<br>AAANNCETI _____      | _____ My other name is Lebbaeus. <i>(Matthew 10:3)</i>                                                                                 |
| 12. DUJSA SROATIIC _____              | _____ If I were alive today, I might be called "Bart." <i>(Mark 3:18)</i>                                                              |

## **Year 3**

### **Week 120**

#### **Jesus Has Many Followers**

##### **Scriptures: Matthew 9**

**Key Verse: Matthew 9:12** “Jesus said, ‘Those who are well have no need of a physician, but those who are sick.’”

##### **Key Points:**

1. Jesus sees a man named Matthew, who is a tax collector, and says, “Follow me.” Matthew obeys. Jesus and His disciples eat meat at Matthew’s house, and the Pharisees ask why Jesus is eating with publicans and sinners. Jesus tells them, “Those who are well have no need of a physician, but those who are sick.”

2. A certain ruler came and worshipped Jesus, saying that his daughter was dead. He told Jesus to come, lay His hand upon her, and she would live. Jesus and His disciples followed the man home.

3. Two blind men came to Jesus. He asked if they believed that He could heal them, and when they said, “Yes,” Jesus touched their eyes and they were opened. When the blind men left, they spread his fame in all the country.

4. Jesus went around to all the cities and villages teaching in the synagogues of the gospel of the kingdom. He healed every sickness and disease among the people.

5. When Jesus saw the multitudes, he had compassion for them because they were like sheep without a shepherd. “The harvest truly is plentiful, but the laborers are few; therefore pray the Lord of the harvest to send out laborers into His harvest.”

## Matthew 9:9

And when Jesus was going from there, he saw a man whose name was Matthew, seated at the place where taxes were taken; and he said to him, Come follow me. And he got up and followed him.



# Matthew

Matthew 9:9-13

As \_\_\_\_\_ went on from there, he saw a \_\_\_\_\_ named \_\_\_\_\_ sitting at the \_\_\_\_\_ collector's \_\_\_\_\_.

Matthew got up and \_\_\_\_\_ me," he told him, and \_\_\_\_\_ him.

While Jesus was having \_\_\_\_\_ at Matthew's \_\_\_\_\_, many tax \_\_\_\_\_ and \_\_\_\_\_ came and \_\_\_\_\_ with him and his \_\_\_\_\_.

When the \_\_\_\_\_ saw this, they \_\_\_\_\_ his disciples, "Why \_\_\_\_\_ your \_\_\_\_\_ eat with tax collectors and 'sinners'?"

On \_\_\_\_\_ this, Jesus said, "It is not the \_\_\_\_\_ who need a \_\_\_\_\_, but the \_\_\_\_\_.

But go and \_\_\_\_\_ what \_\_\_\_\_ means: 'I desire \_\_\_\_\_, not \_\_\_\_\_.

' For I have not \_\_\_\_\_ to \_\_\_\_\_ the \_\_\_\_\_, but sinners."

Y X E W V U L E A R N T S X  
 R T S E L P I C S I D Q A P  
 A J O N M H L K J I H T R G  
 I E E S A R Z I Y X S W N V  
 T C B S A R I T G S I R N Q  
 E S U U I T H H N M I L  
 A R P O S N T G H N F D K  
 C O K H J E D E M A E C C R  
 H T B I E E S Z O W R I S T O  
 R E F X O W C U E I S T D T  
 S L O U V T R S H N Q E P C  
 O L L N M L H K T G K J O D  
 F O L L O W E D T S I M H A Q  
 G C O F Y H T L A M E R C Y  
 C B W C A L L A M E R C Y







Jesus Heals a Sick Boy  
John 4





Jesus heals a blind man.



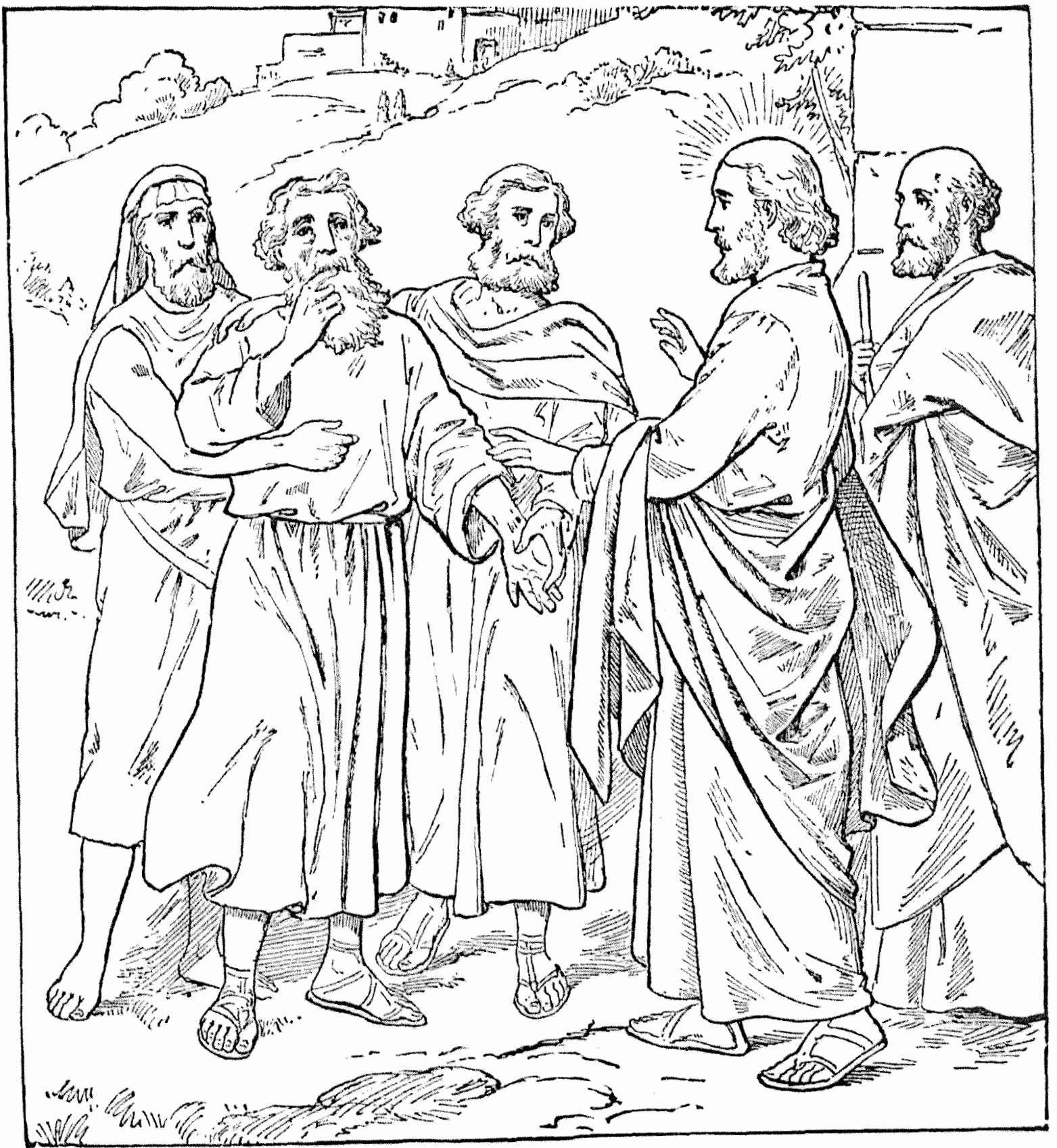

## Year 3

### Week 121

## Jesus In The Temple

**Scriptures: John 2:12-25, 3:1-21**

**Key Verse: John 2:16** “And He said to those who sold doves, ‘Take these things away; Do not make My Father’s house a house of merchandise.’”

### Key Points:

1. Passover was near and Jesus went to Jerusalem. Jesus found oxen, sheep, and doves being sold in the temple. Money changers were in the temple also.
2. Jesus made a whip of small cords and drove the people out of the temple along with the oxen and sheep, and he overturned the tables of the money changers.
3. When Jesus was in Jerusalem for Passover, many believed in His name, when they saw the miracles that He did.
4. Nicodemus was a Pharisee and a ruler of the Jews. He came to Jesus by night to ask him questions. He said, “Rabbi, we know that You are a teacher come from God; for no one can do these signs that You do, unless God is with him.”
5. Nicodemus wanted to know how to be born again, and Jesus said he must be born again of water and the Spirit to enter into the kingdom of God.
6. Jesus taught him about being born again, and the love that God has for the world. “For God so loved the world, that He gave His only begotten Son, that whoever believes in Him should not perish, but have everlasting life.”

# Jesus at the Temple

Read the Bible story at <http://gardenofpraise.com/bibl39s.htm>

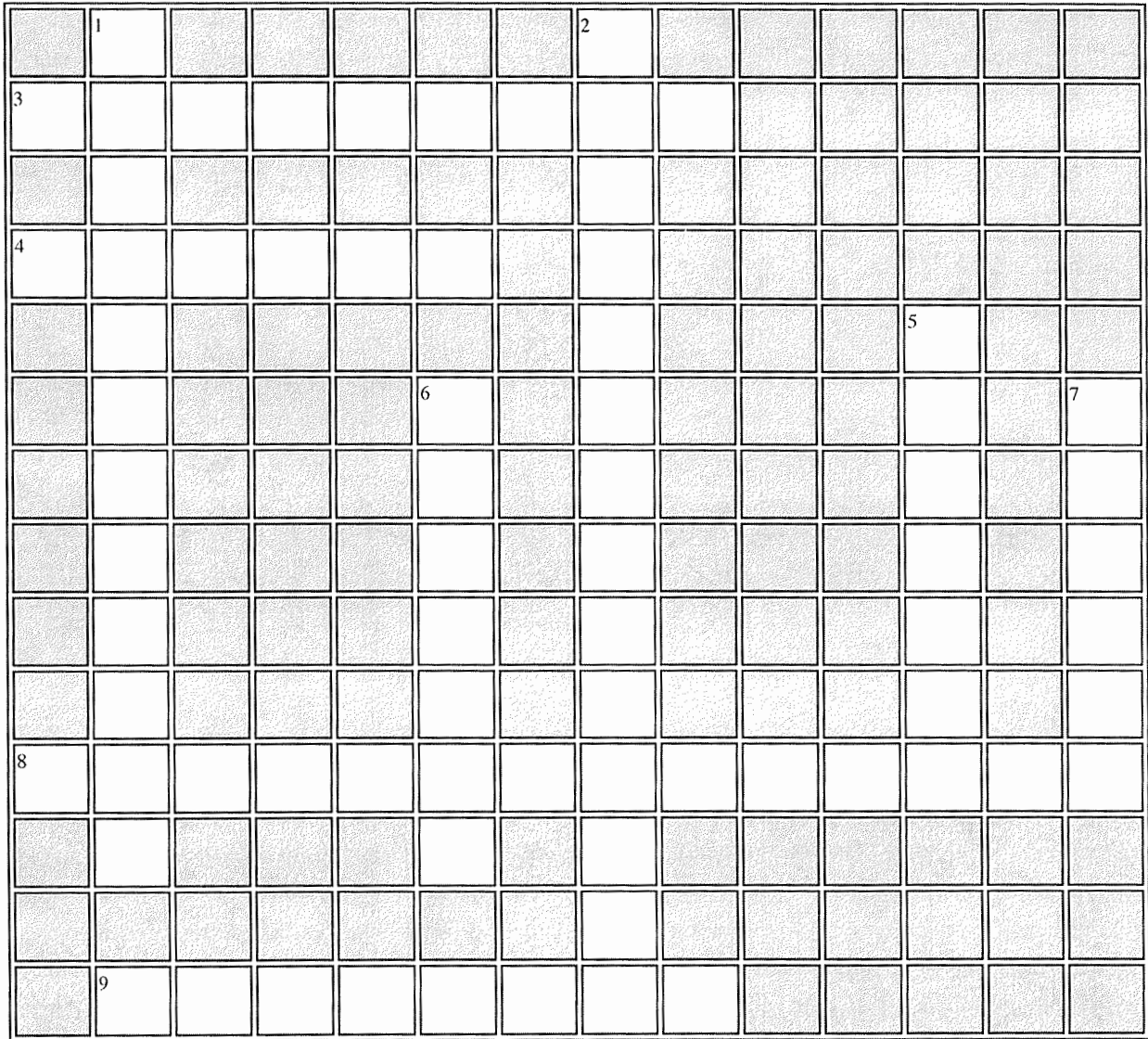

### Across

- 3. location of the temple
- 4. Jesus rode on a \_\_\_\_\_ when entering Jerusalem.
- 8. Men were \_\_\_\_\_ for sacrifices.
- 9. annual Jewish feast

### Down

- 1. Jesus said they had made the temple a \_\_\_\_\_.
- 2. Jesus said \_\_\_\_\_ came from the lips of children.
- 5. The people shouted, "\_\_\_\_\_ in the highest".
- 6. After the first temple visit he returned to \_\_\_\_\_.
- 7. Jesus turned these over.

WORD BANK: PASSOVER, DONKEY, HOSANNA, SELLING ANIMALS, TABLES, JERUSALEM, PERFECT PRAISE, DEN OF THIEVES, BETHANY

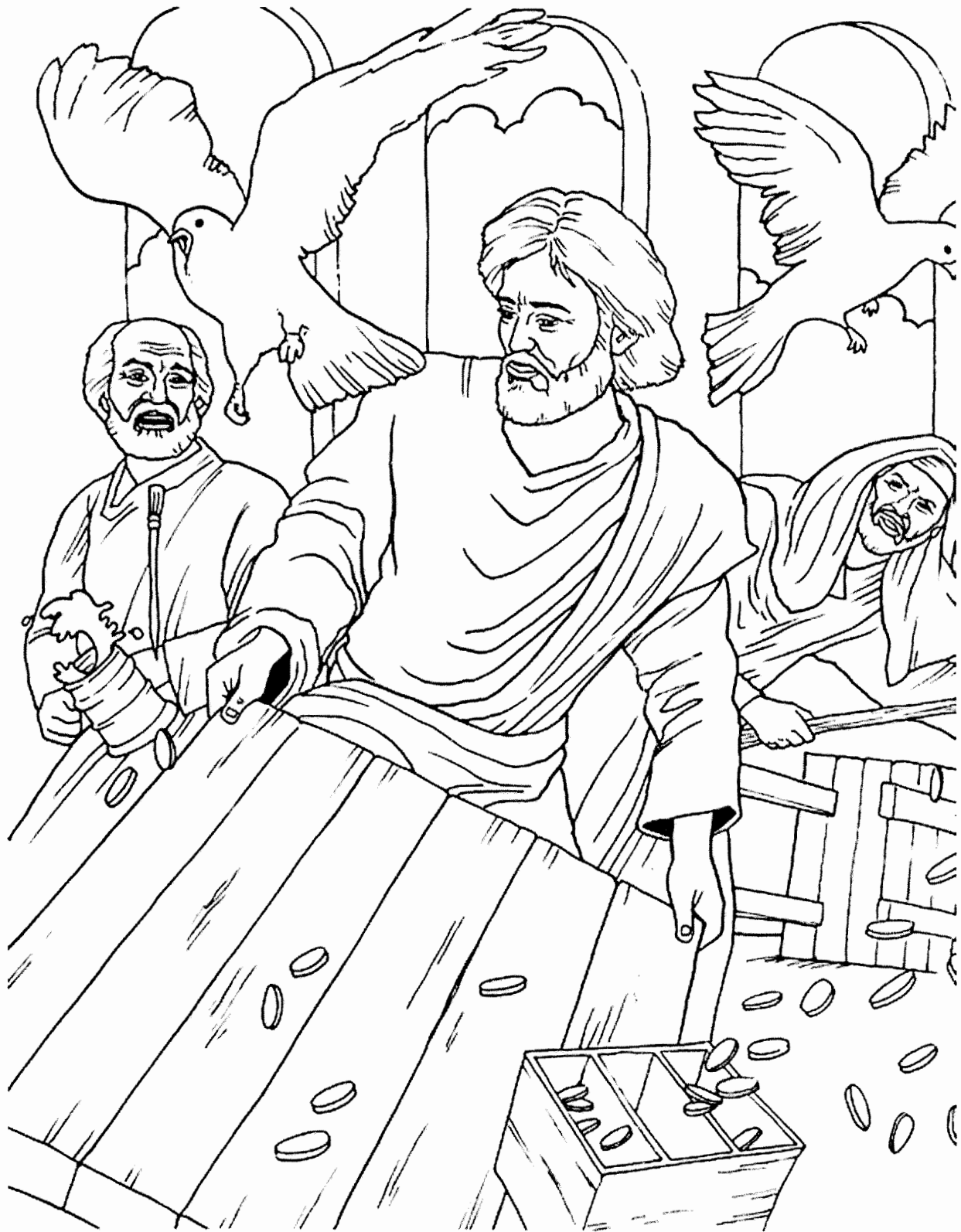

## Cleansing the Temple

From BibleStoryCard Learning System(tm) Coloring Book © 1996 Wesleyan Publishing House  
Used by permission. Additional BibleStoryCard resources available by calling 1-800-493-7539 or visiting online  
[http://www.parable.com/wph/group\\_1052.htm](http://www.parable.com/wph/group_1052.htm)



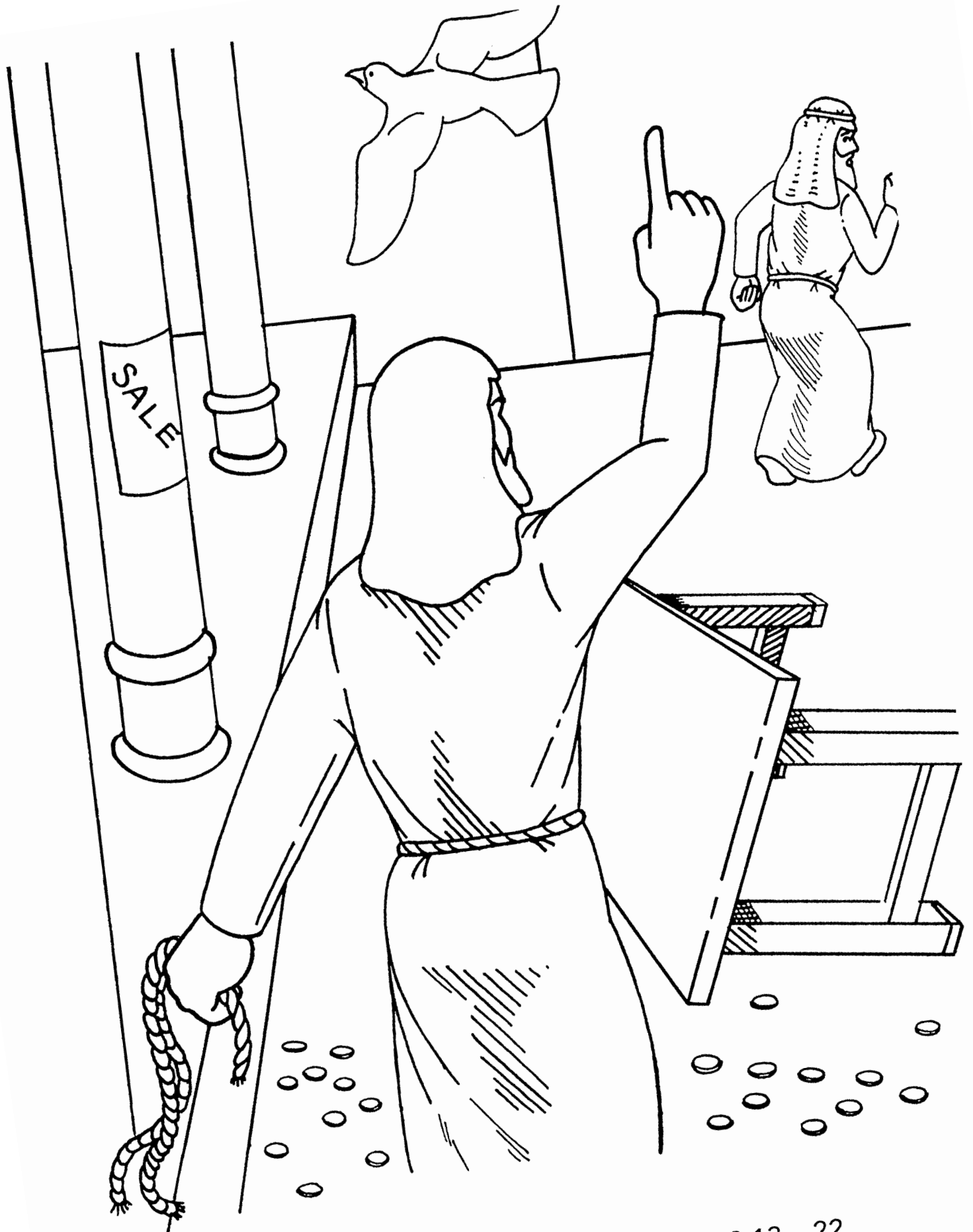

"Jesus cleanses the temple." John 2:13 - 22

Luke 19:45-46

Fill in the blanks using the New King James Version of the Bible.

Then \_\_\_\_\_ went into the \_\_\_\_\_ and  
began to \_\_\_\_\_ out those who  
\_\_\_\_\_ and \_\_\_\_\_ in it, saying to  
them, "It is \_\_\_\_\_, 'My \_\_\_\_\_ is a  
*house of* \_\_\_\_\_,' but \_\_\_\_\_ have  
made it a '\_\_\_\_\_ of \_\_\_\_\_.'"

"Scripture taken from the New King James Version. Copyright © 1982 by Thomas Nelson, Inc. Used by permission. All rights reserved."

# THE CLEANSING OF THE TEMPLE

(JOHN 2:13-22)

## MEMORY VERSE:

"Then His disciples remembered that it was written, 'Zeal for Your house has eaten Me up.'" JOHN 2:17

## CIRCLE THE CORRECT WORDS:

1. "Now the (PASSOVER, SABBATH) of the Jews was at hand, and Jesus went up to (BETHLEHEM, JERUSALEM)." JOHN 2:13

## UNDERLINE THE CORRECT ANSWER:

2. "And He found in the temple those who sold oxen and sheep and doves, and the money changers..." JOHN 2:14
- ministering to the people
  - doing business

## TRUE OR FALSE:

3. "When He had made a whip of cords, He drove them all out of the temple..." JOHN 2:15  
TRUE OR FALSE

4. "...and poured out the changers' money and overturned the tables." JOHN 2:15  
TRUE OR FALSE

5. "And He said to those who sold doves, 'Take these things away! Do not make My Father's house a house of merchandise!' " JOHN 2:16  
TRUE OR FALSE

## FILL IN THE BLANKS:

6. "Jesus answered and said to them, 'Destroy this temple, and in \_\_\_\_\_ days I will \_\_\_\_\_ it up.'" JOHN 2:19

## CIRCLE THE CORRECT WORD:

7. "Then the Jews said, 'It has taken (FORTY-SIX, FOUR) years to build this temple, and will You raise it up in (THREE, THIRTY) days?' " JOHN 2:20

## TRUE OR FALSE:

8. "But He was speaking of the temple of His body." JOHN 2:21  
TRUE OR FALSE

# THE CLEANSING OF THE TEMPLE

(JOHN 2:13-22)

B P L A Q S W K U T A T I G B H W B N Y  
K K V V J L Q O A D U R Y W G R W O I S  
K S D C I P D B F W H I P O F C O R D S  
O P R A M U B E F D E R B A C E Z I S M  
J P D E C O I H N Q N W B Y O R T S E D  
Q R Z L V T N F T R Q P P F Z M O R V U  
S B Z O T O T E Q C U B P B H Q A F U B  
P B O Z C N S V Y U B T Y T K N K Y U S  
M S W M S D A S H C B K R O M Y U B A E  
B L H F J H L I A J H B E E K M N D D J  
B T Q M J E E O A P A A L L V A U F D M  
O K H Q W R S E U K Y A N M P O D B W G  
H W I R Y A B U P S S C F G R M L E T O  
S V L S E Z Z N S U Q D O J E S E H L V  
S J H Q N E Z H R M U W J K E R U T A S  
R B T E J E D E U J Q D W G N V S T O P  
V W X V T Y J A T T O K S H C Y F L A T  
N O Y P N M D I Y V T I S G V K L U P W  
G T A B L E S O E S H E I D C W Y W A B  
D E O B A D N S B A T P A V C L H Q D H

BODY

MONEYCHANGERS

TABLES

DESTROY

OVERTURNED

TEMPLE

DOVES

OXEN

THREE DAYS

JERUSALEM

PASSOVER

WHIP OF CORDS

JESUS

SHEEP

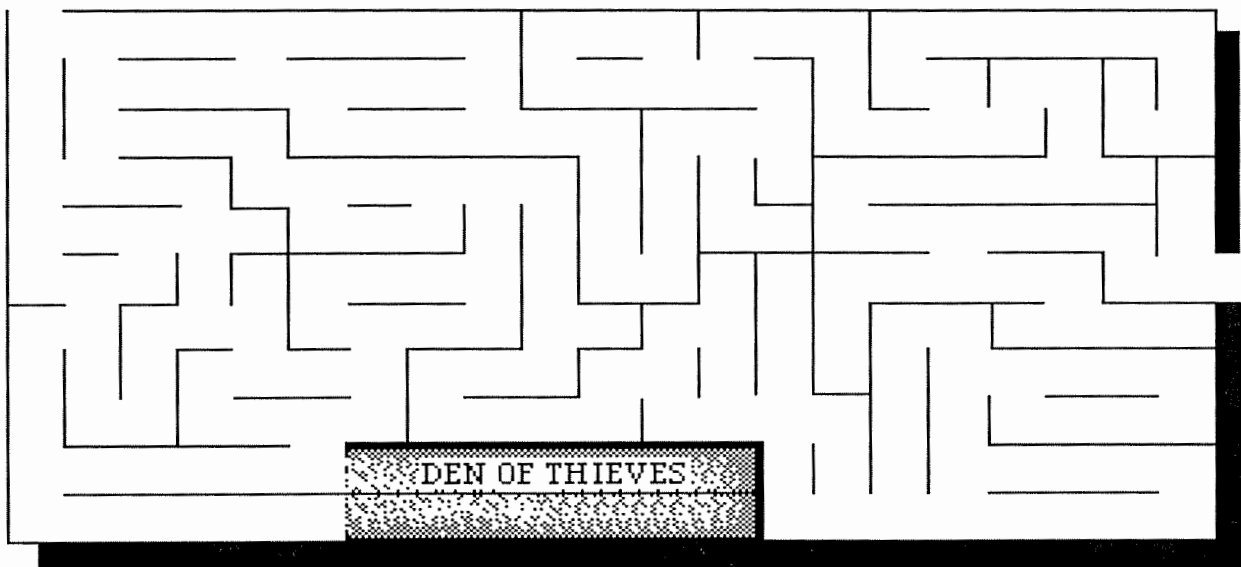

# THE CLEANSING OF THE TEMPLE

## (JOHN 2:13-22)

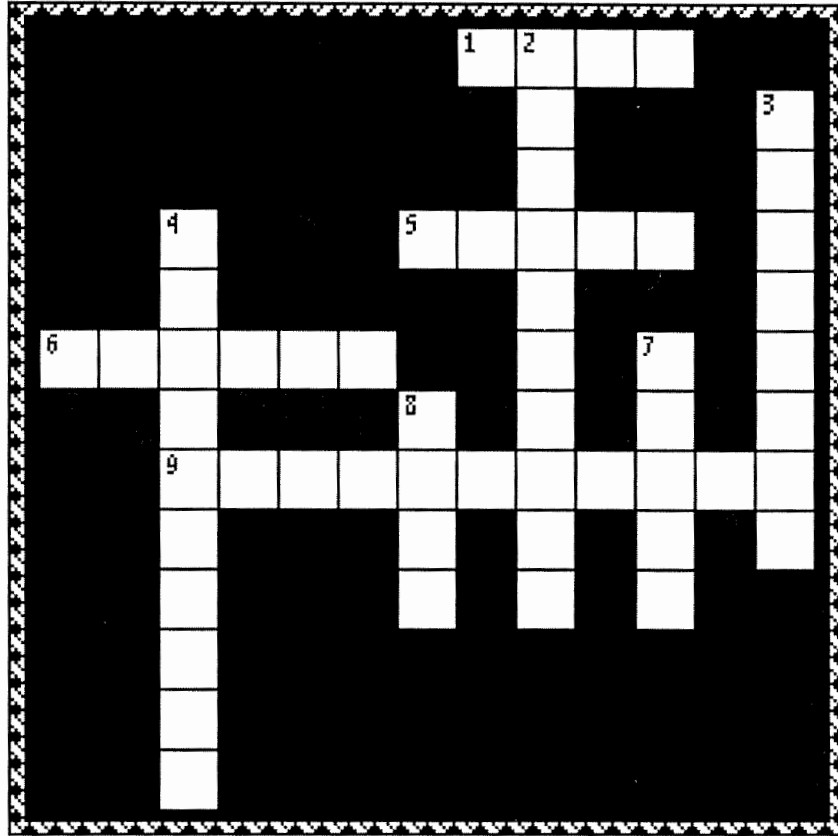

- 3 DOWN "Now the \_\_\_\_\_ of the Jews was at hand, and Jesus went up to Jerusalem." **JOHN 2:13**
- 6 ACROSS "And He found in the \_\_\_\_\_ those who sold oxen and sheep and doves, and the money changers doing business." **JOHN 2:14**
- 8 DOWN "When He had made a \_\_\_\_\_ of cords, He drove them all out of the temple..." **JOHN 2:15**
- 2 DOWN "...and poured out the changers' money and \_\_\_\_\_ the tables." **JOHN 2:15**
- 9 ACROSS "And He said to those who sold doves, 'Take these things away! Do not make My Father's house a house of \_\_\_\_\_!'" **JOHN 2:16**
- 4 DOWN "Then His disciples \_\_\_\_\_ that it was written, 'Zeal for Your house has eaten Me up.'" **JOHN 2:17**
- 7 DOWN "Jesus answered and said to them, 'Destroy this temple, and in three days I will \_\_\_\_\_ it up.'" **JOHN 2:19**
- 5 ACROSS "Then the Jews said, 'It has taken forty-six years to build this temple, and will You raise it up in \_\_\_\_\_ days?'" **JOHN 2:20**
- 1 ACROSS "But He was speaking of the temple of His \_\_\_\_\_." **JOHN 2:21**

# Jesus Cleanses the Temple

John 2:13-22



R F E T A B L E S J E W I S H  
T S X D T C W D I J W L S V X  
T E O D M A R R T E C Y I U C  
Z C M X T T F O T R D E P Y E  
X X A P C T P V I U P O K V A  
L S O R L L T E N S A Z V D Z  
C X C B L E I J G A S W L E X  
H V G A K M G Y S L S H V Q S  
T I O R T N W D I E O I E M C  
V I A J I T R D P M V P Y F Y  
F M M L T O E S M A E V K E E  
C I L E C U Y R E F R T N S J  
K E K C H A N G E R S O U Z S  
S K S H E E P M V D M O E N X  
K G Z C O U R T S Q H Y M Z R

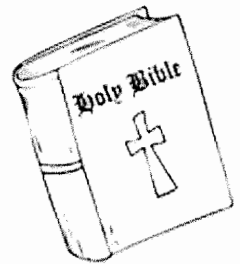

time  
Jewish  
Passover  
Jerusalem  
temple

courts  
selling  
cattle  
sheep  
doves

money  
changers  
sitting  
tables  
whip

corde  
drove  
scattered  
house  
market

## Bible Memory Verse

"Get these out of here! How dare you turn my Father's house into a market!"  
John 2:16 (NIV)

# THE CLEANSING OF THE TEMPLE

(JOHN 2:13-22)

O I B O D Y L A Z J Z J B F E  
V U U X Y L U E E F B Y P H V  
E M G E R J G R M B I O E N V  
R F H N D T U I O B Z R E E L  
T O B P C S C S N R F T H E A  
U E V L A W V G E E Z S S M I  
R P S L G D U S Y V B E A J L  
N K E J S O B E C O D D M E P  
E M U B Q V N L H S K A Z L I  
D J B J U E H B A S B V B P H  
W F H H M S B A N A U K T M W  
G Y U T J K A T G P Y U P E R  
T T Q S Y A D E E R H T Z T U  
K W T J Q M U J R K E O F Q U  
W S U S E J V P S M E Z V V C

BODY

MONEYCHANGERS

TABLES

DESTROY

OVERTURNED

TEMPLE

DOVES

OXEN

THREE DAYS

JERUSALEM

PASSOVER

WHIP

JESUS

SHEEP

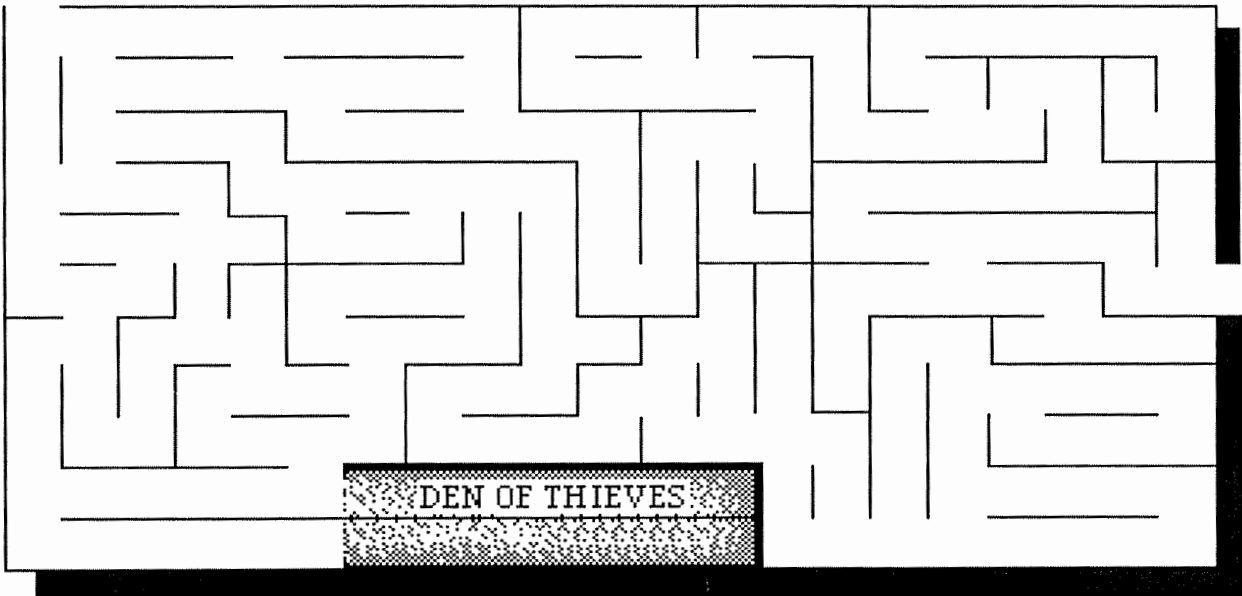

**Jesus Cleanses  
the Temple**  
John 2

# My Father's House

.....  
 Jesus was angry when he saw the house of the Lord used as a market for buying and selling. Use details from both stories (Matthew 21:12, 13; John 2:13-16) to solve the crossword puzzle below.  
 .....

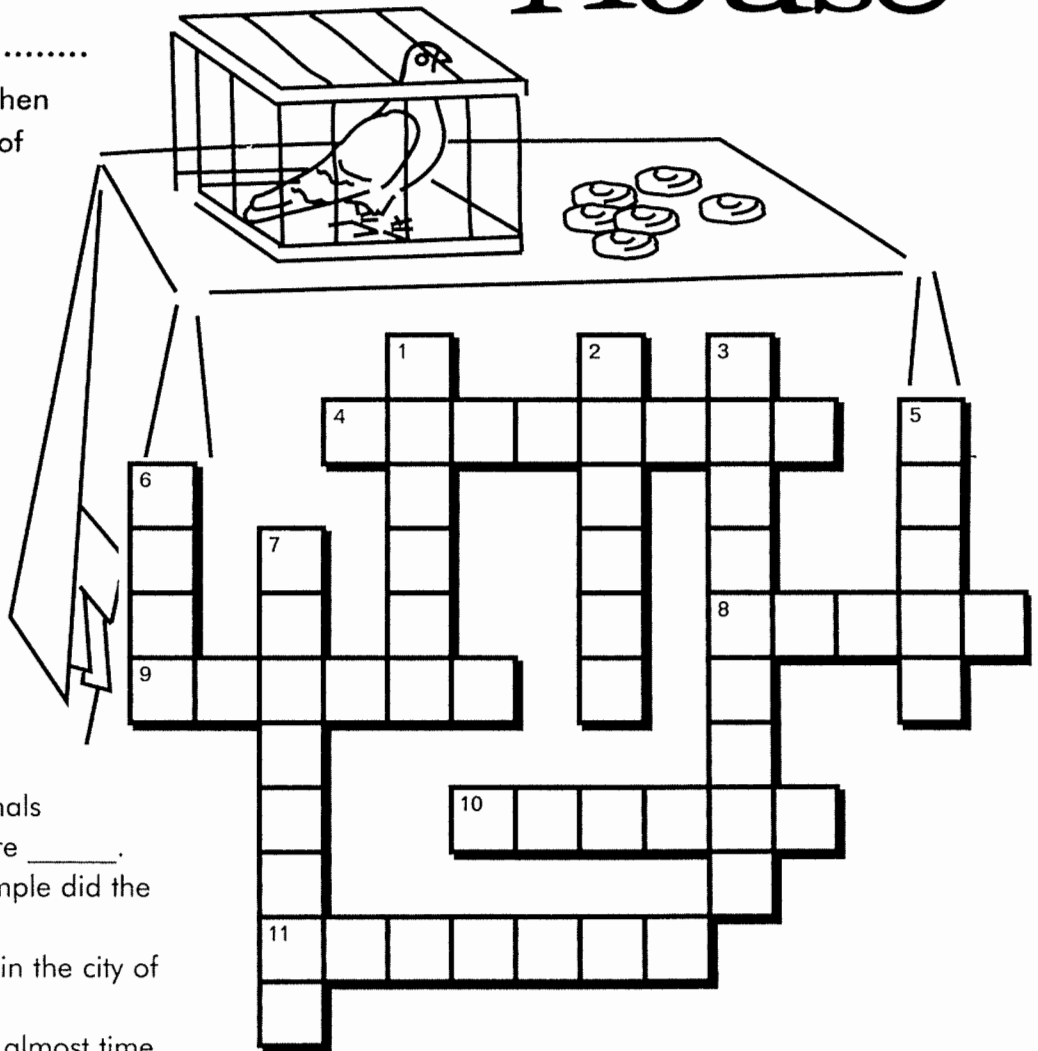

**CLUES**

1. The largest animals sold in the temple were \_\_\_\_\_.
2. Where in the temple did the selling take place?
3. The temple was in the city of \_\_\_\_\_.
4. In this story, it is almost time for the Jewish holiday of \_\_\_\_\_.
5. The smallest animals sold in the temple were \_\_\_\_\_.
6. In the story, what did Jesus make from cords?
7. In the temple, those who traded one type of money for another were called money \_\_\_\_\_.
8. Name another animal sold in the temple.
9. Jesus said the temple was to be a "house of \_\_\_\_\_."
10. What did Jesus tip over?
11. Jesus said that the temple was not supposed to be a "den of \_\_\_\_\_."



Bible for Children

presents

A TEMPLE  
LEADER  
VISITS  
JESUS

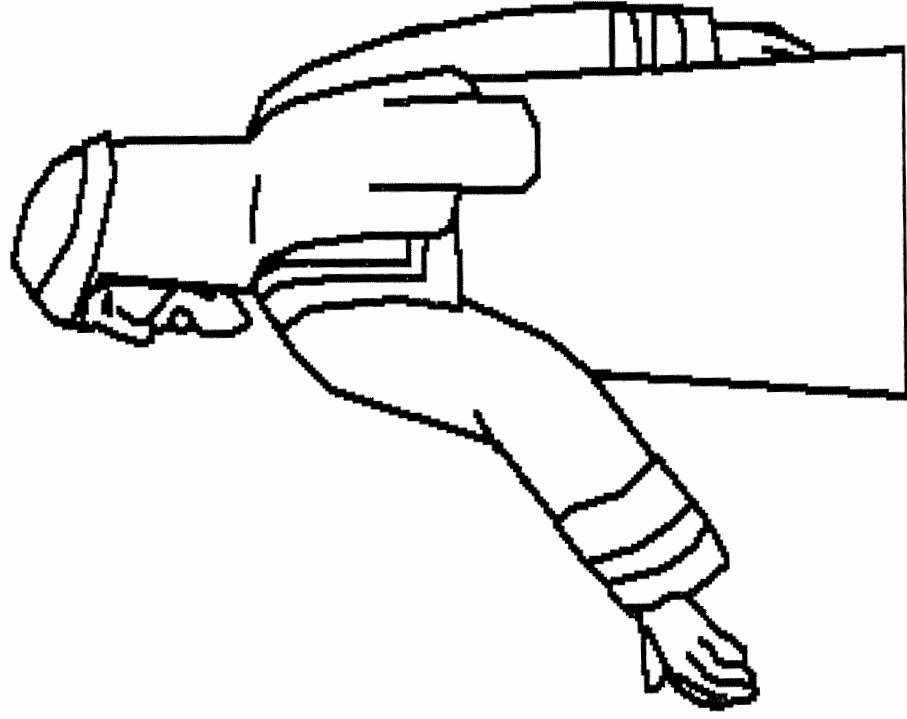

When Jesus went to the Temple one day,  
He found people dishonoring God's House.  
They were selling animals and exchanging  
money right in the Temple!

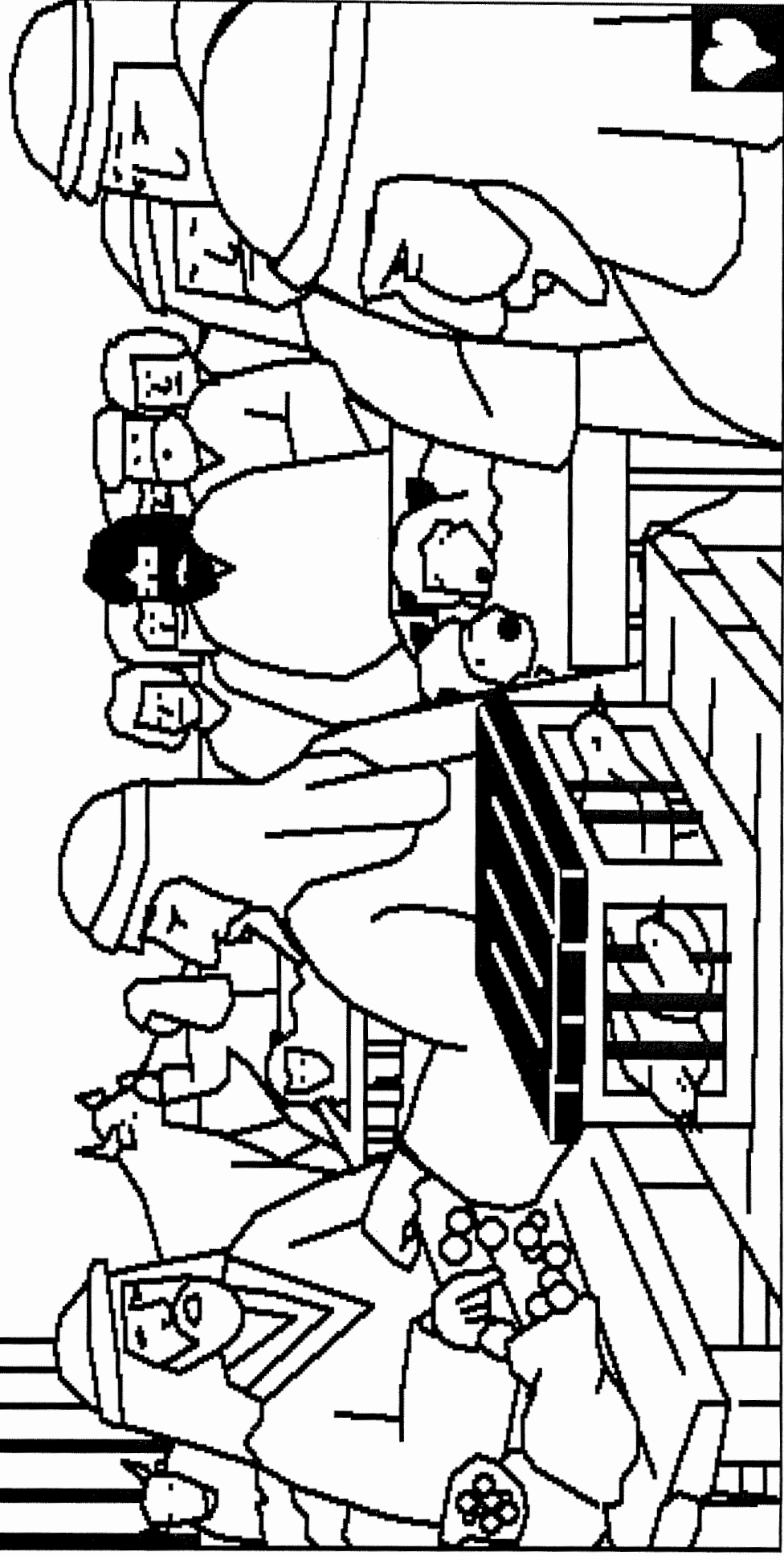

Making a whip from cords, Jesus drove the dealers out of the Temple. "Take these things away," He commanded. "Don't make my Father's House a place of business." Jesus loved His Father's House.

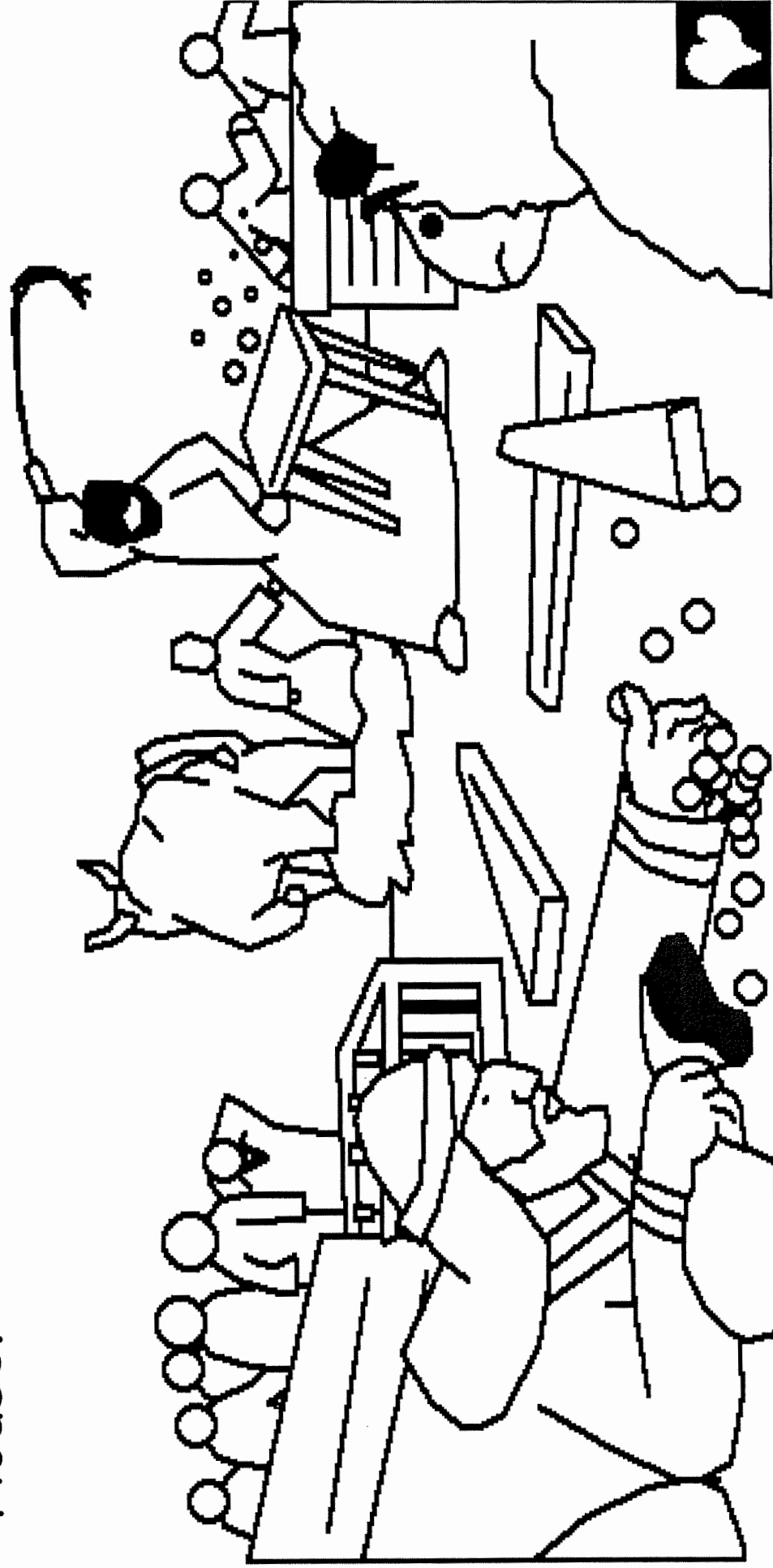

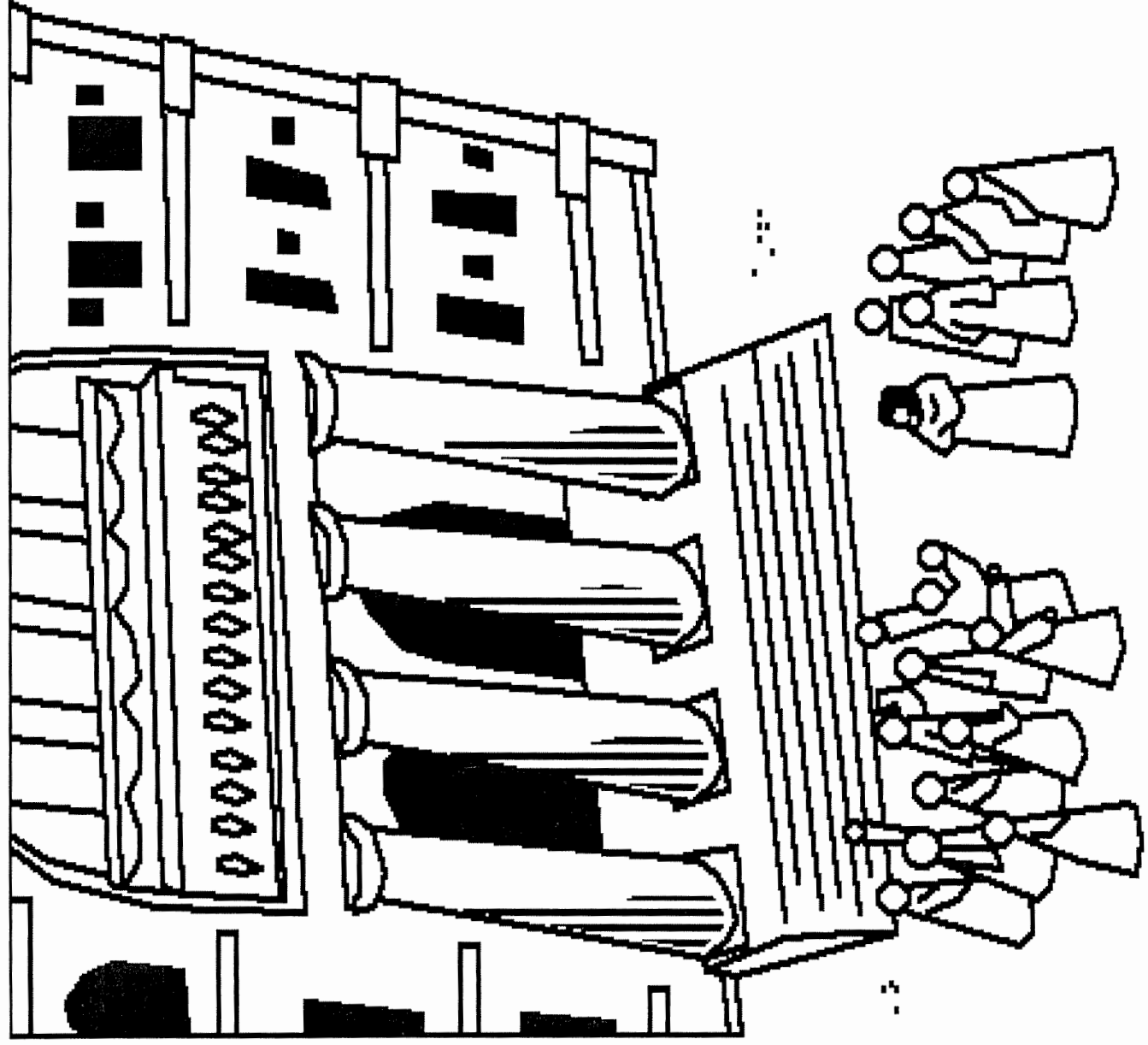

The leaders demanded a sign to show that Jesus had the right to clear the Temple.

"Destroy this temple and I will raise it in three days," Jesus replied.

Impossible! The Temple took forty-six years to build.



But Jesus spoke of  
His body. Like the  
Temple, His body was  
God's dwelling place.  
Though Jesus would  
die on the cross He  
knew God would raise  
Him from death on  
the third day.

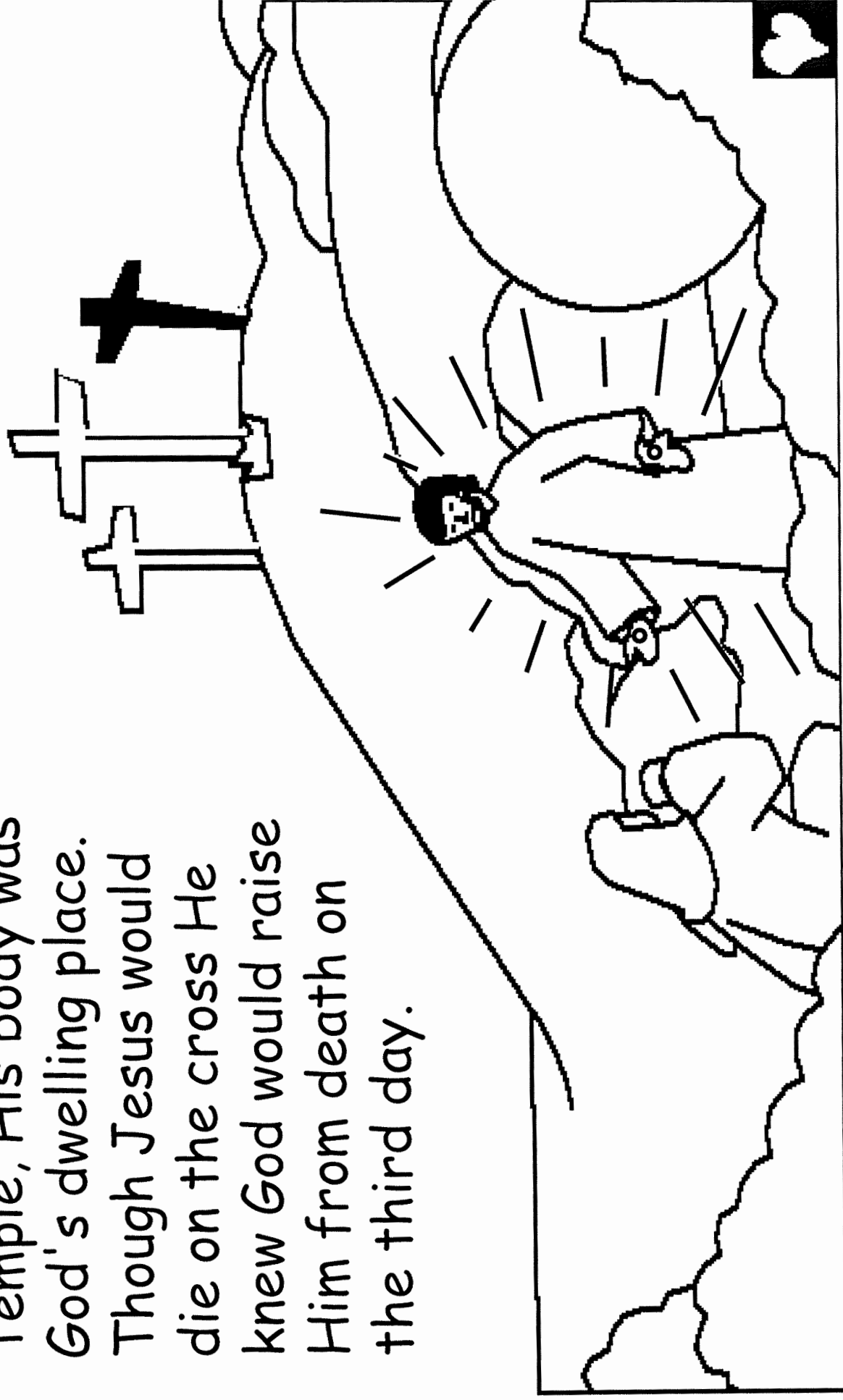

At night, one of the temple leaders visited Jesus. He knew by the miracles that Jesus was sent by God. Nicodemus came to Jesus to learn more about God.

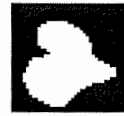
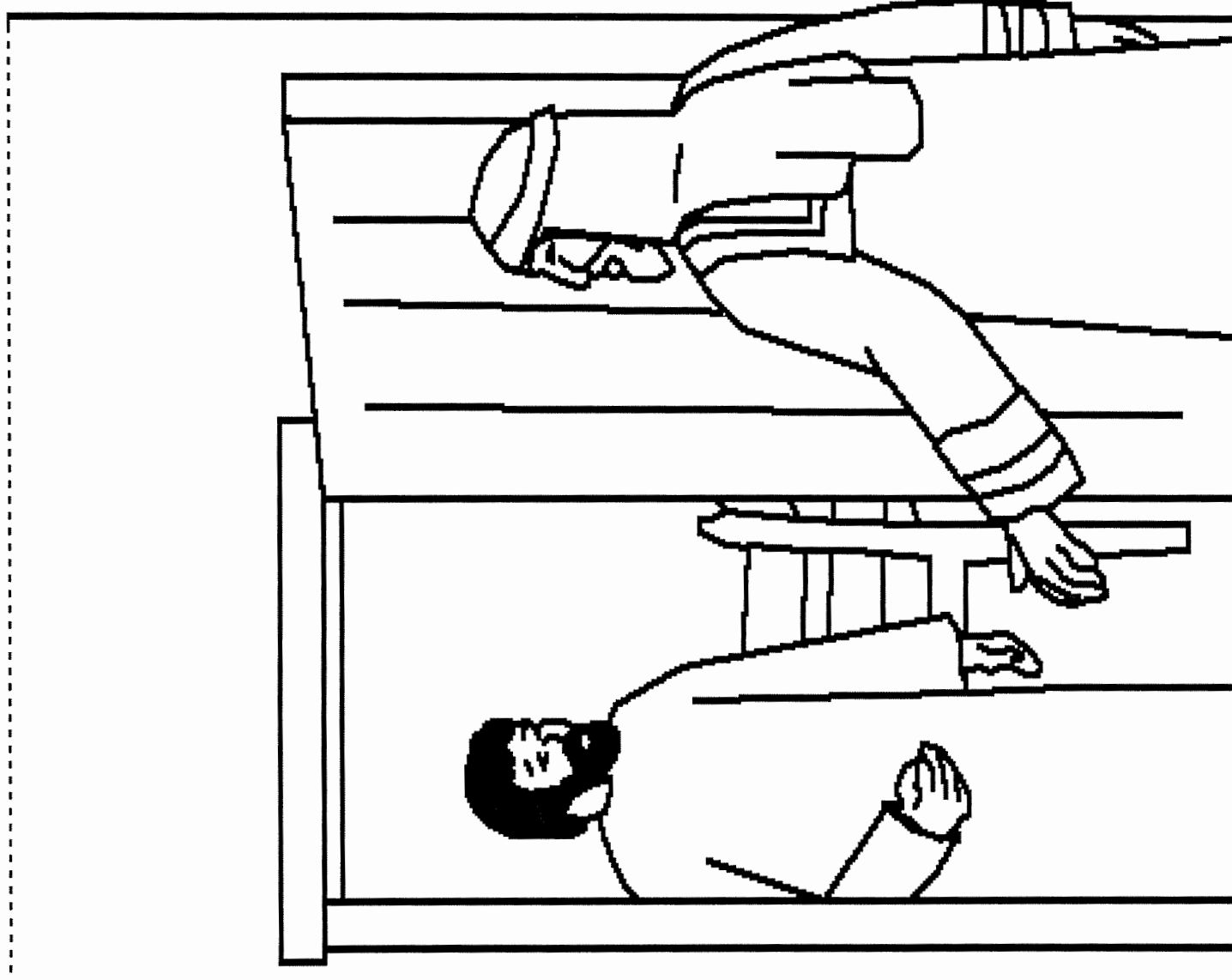

Jesus told Nicodemus that people must be born again to enter God's Kingdom. Nicodemus did not understand. How could a grown man become a baby again? Besides, he was religious. Was that not enough?

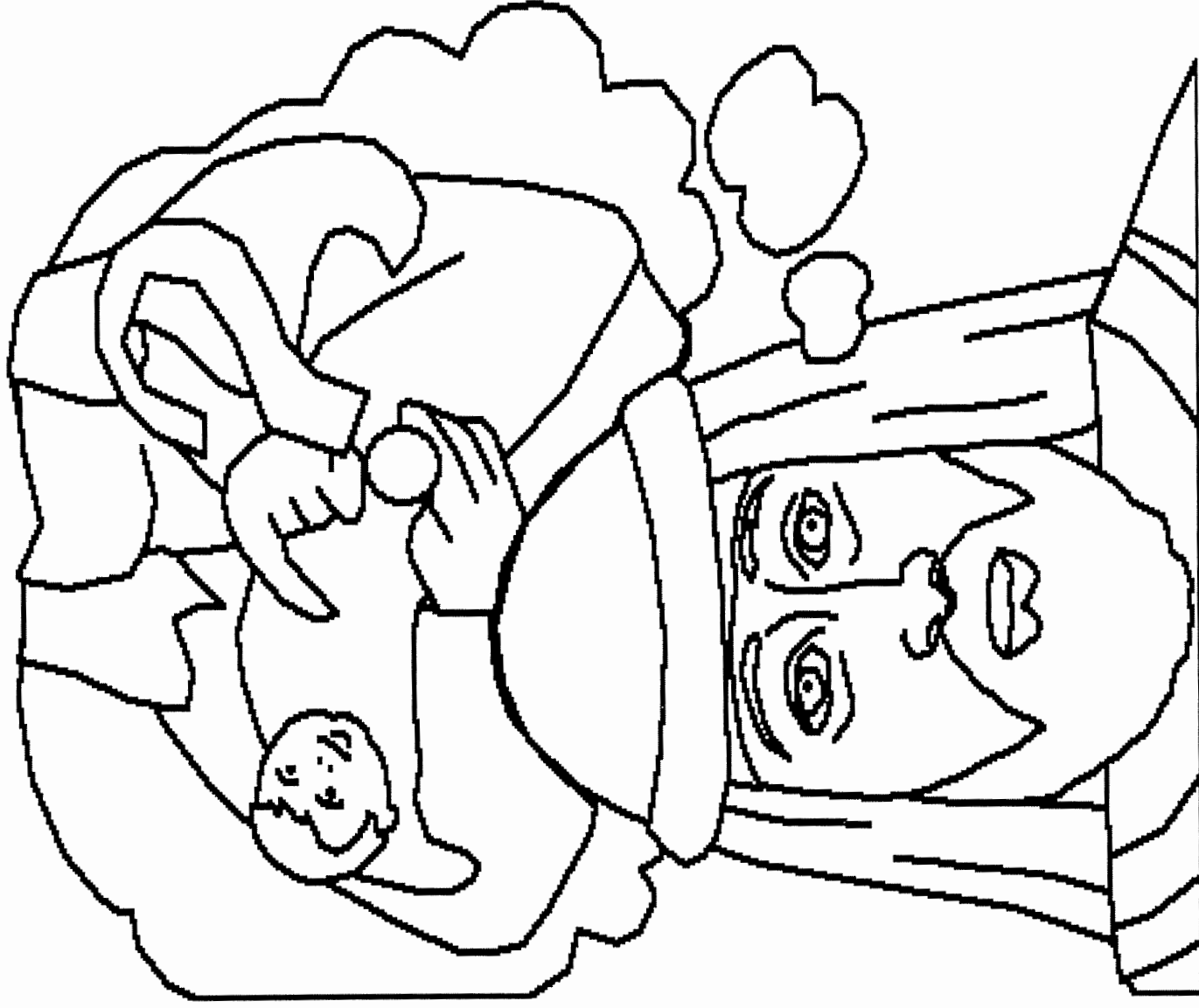

"That which is  
born of the  
spirit is spirit,"  
Jesus explained.  
"God's Spirit is  
like the wind.  
People do not  
see or  
understand the  
wind. They only  
see what the  
wind does."

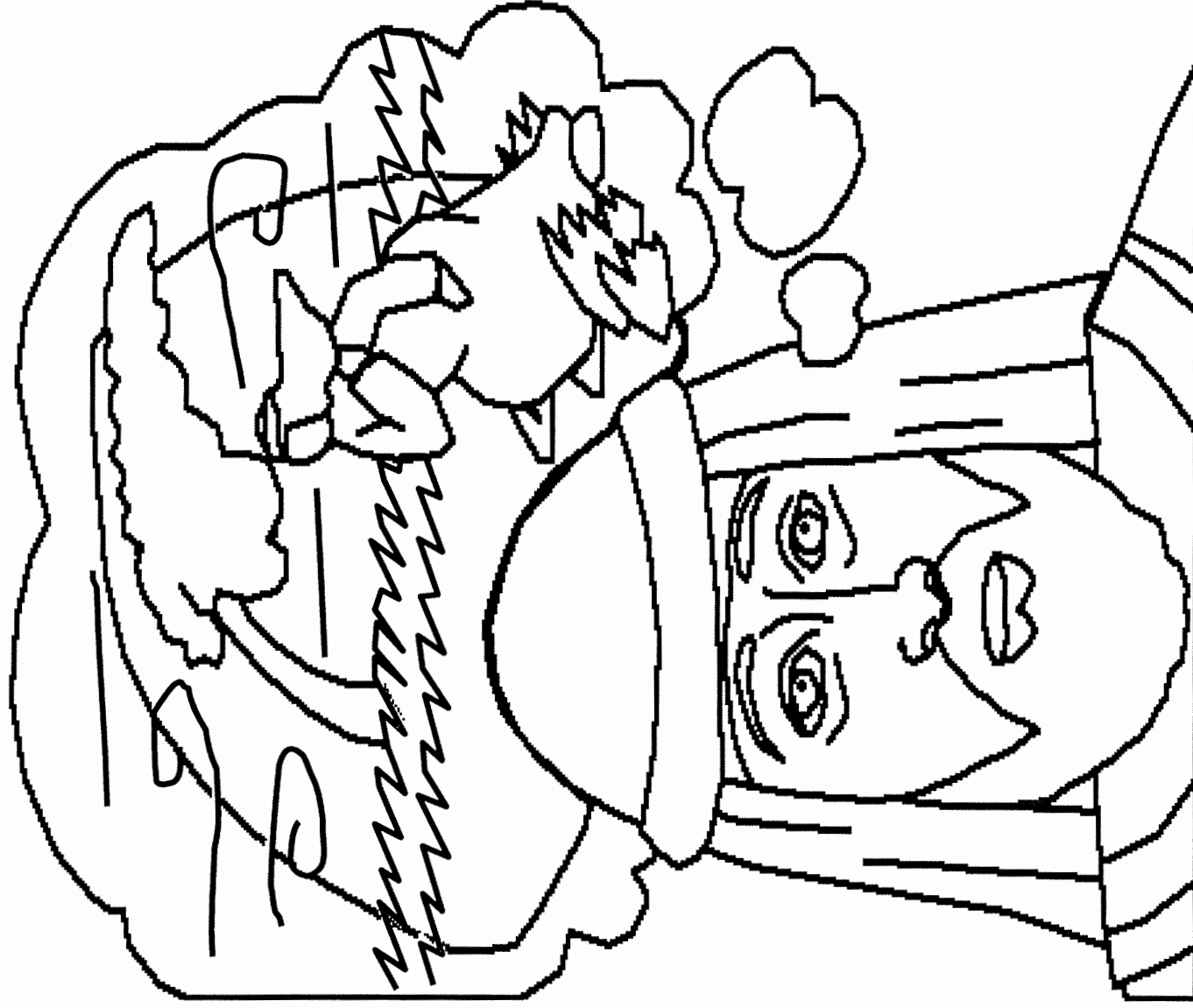



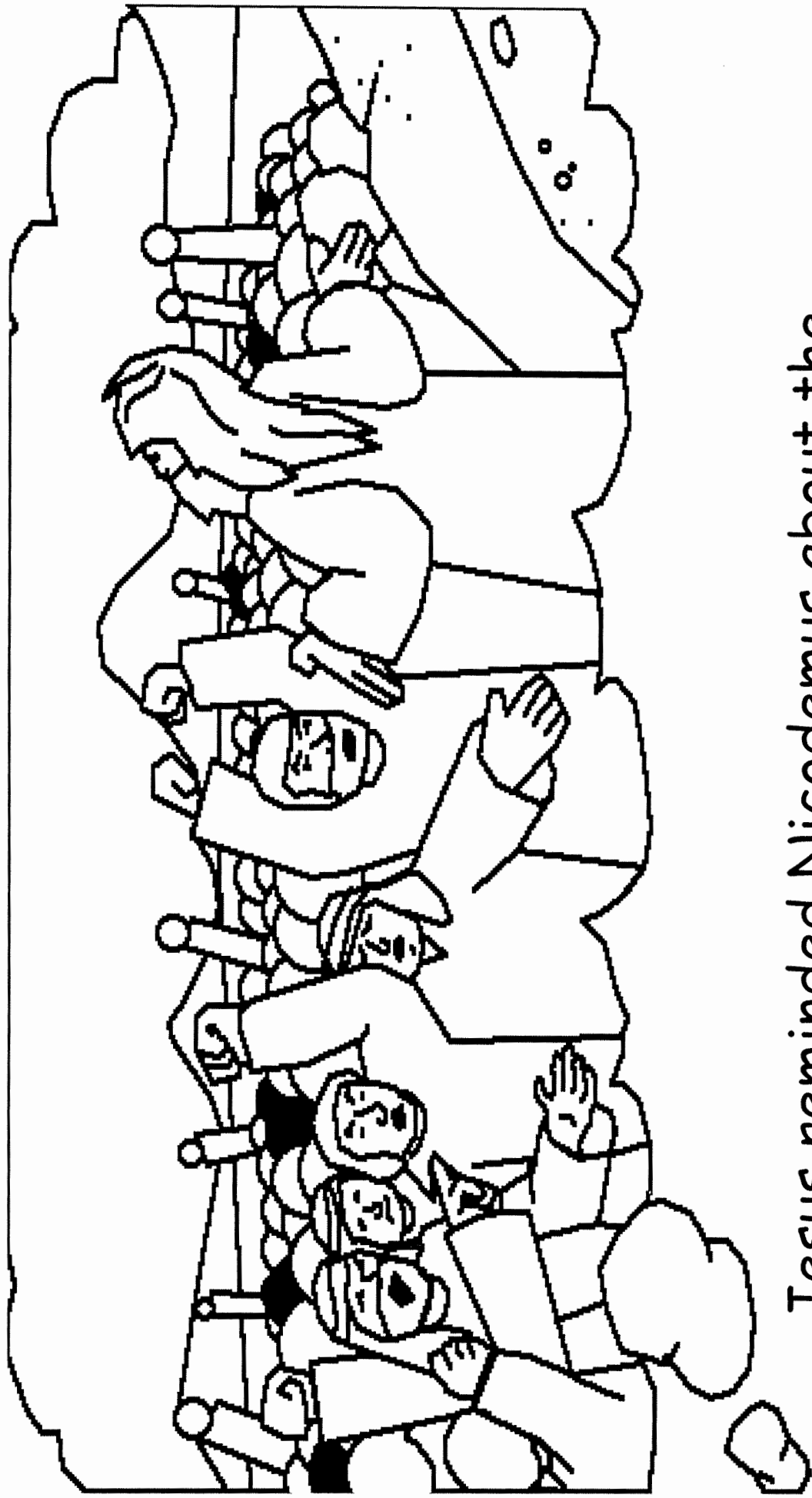

Jesus reminded Nicodemus about the children of Israel complaining to Moses long ago. "We have no food, no water, and we hate the bread God gives us," they cried.



The people's sin angered God.  
He sent fiery serpents among  
them. The serpents bit the  
people. Many died.

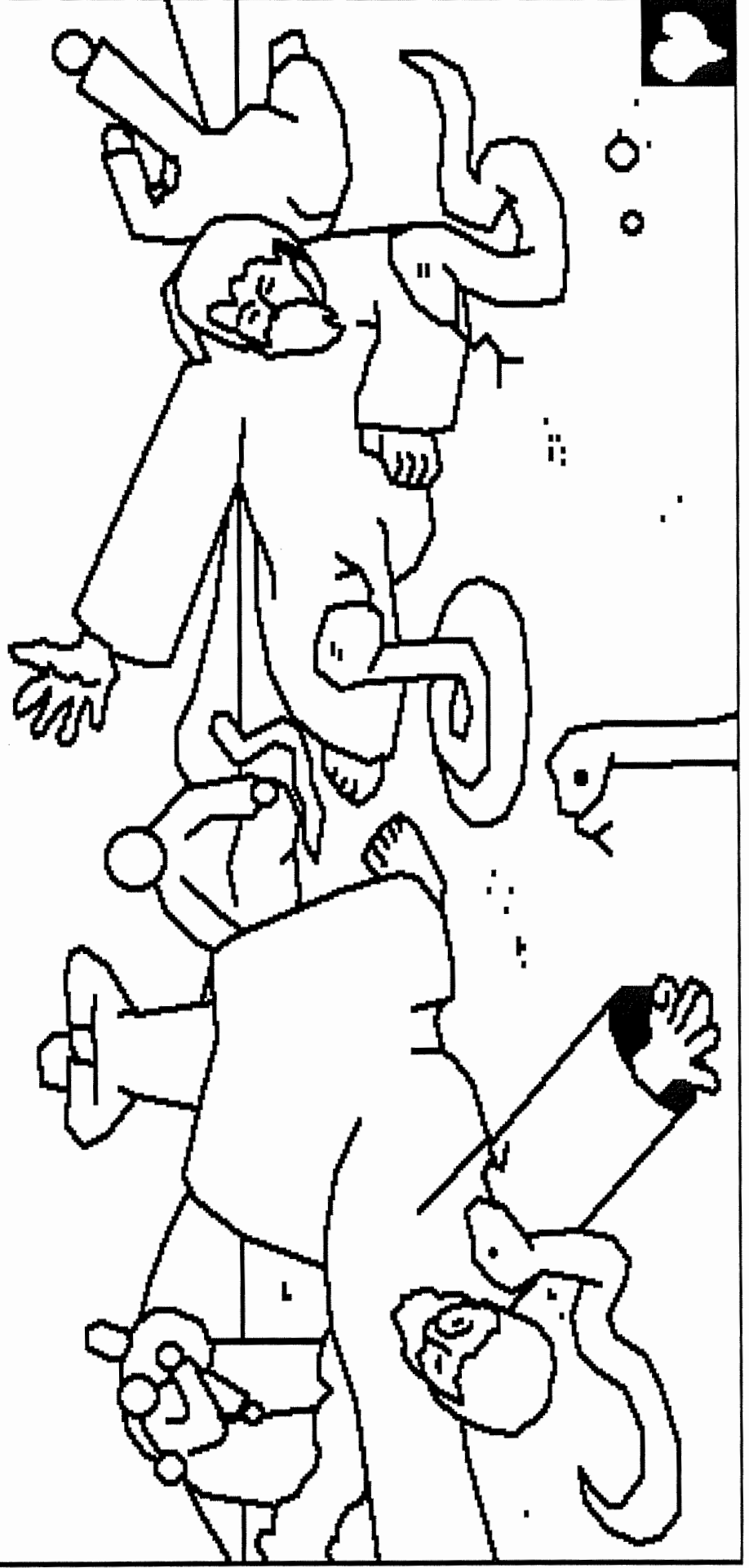

"We have sinned. Pray that the LORD will take away the serpents," the people begged. So Moses prayed for them. But God did not take away the serpents.

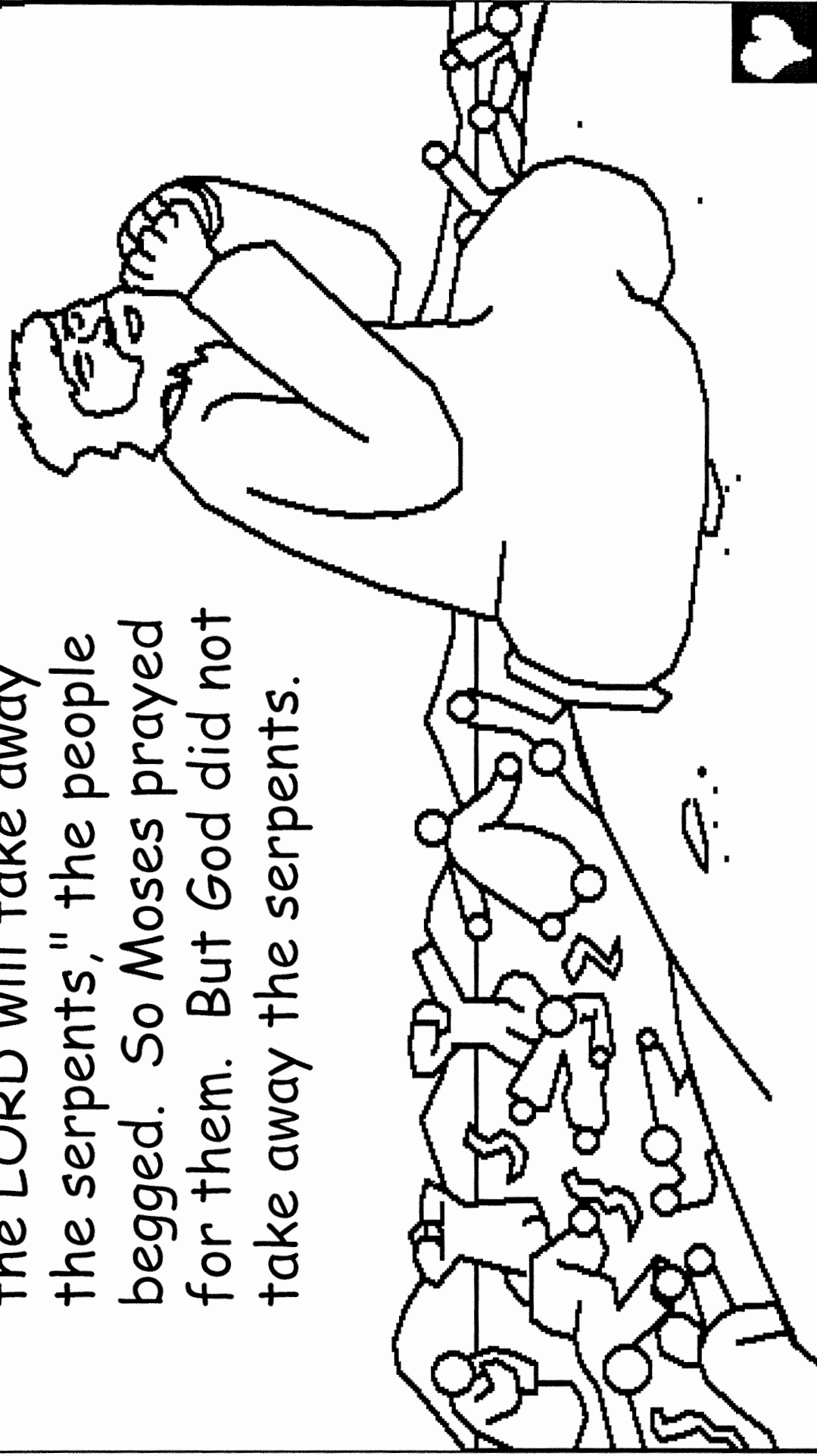

God told Moses to make a fiery serpent and set it on a pole.

"Everyone who is bitten will live when he looks at the serpent on the pole," God promised. Moses made a brass serpent and those who looked at it were healed.

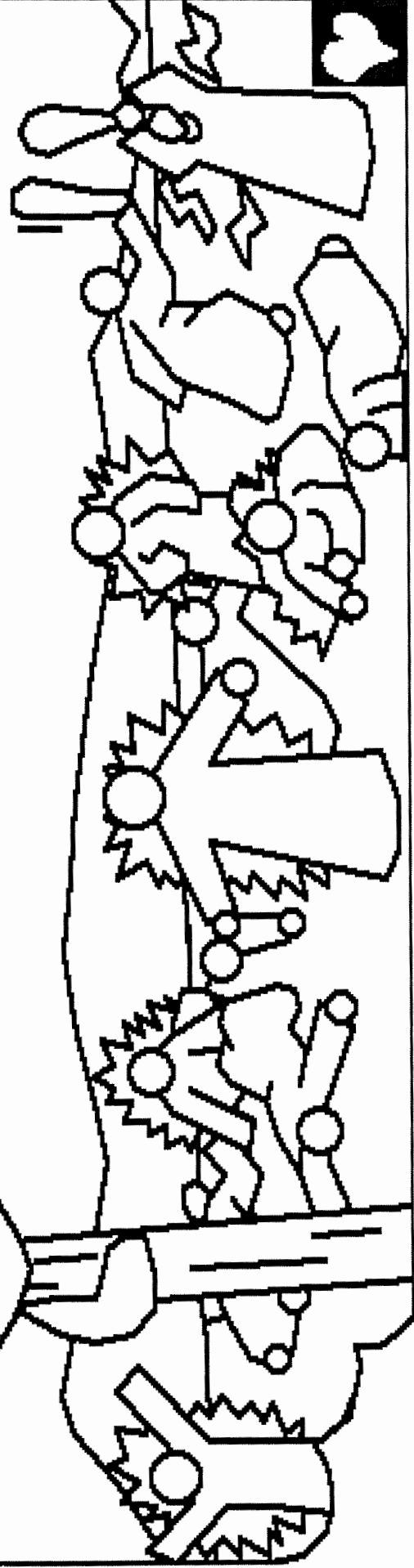
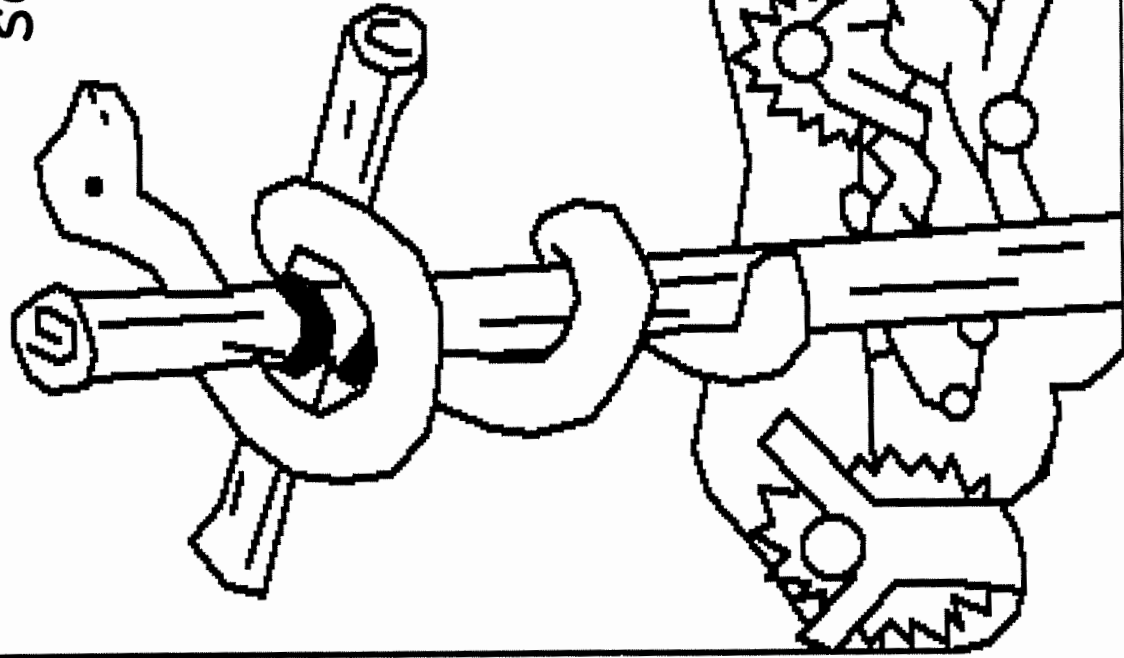



Jesus told Nicodemus that the Son of man must be lifted up just like the brass serpent. Jesus spoke of the cross where He would die for sinners.

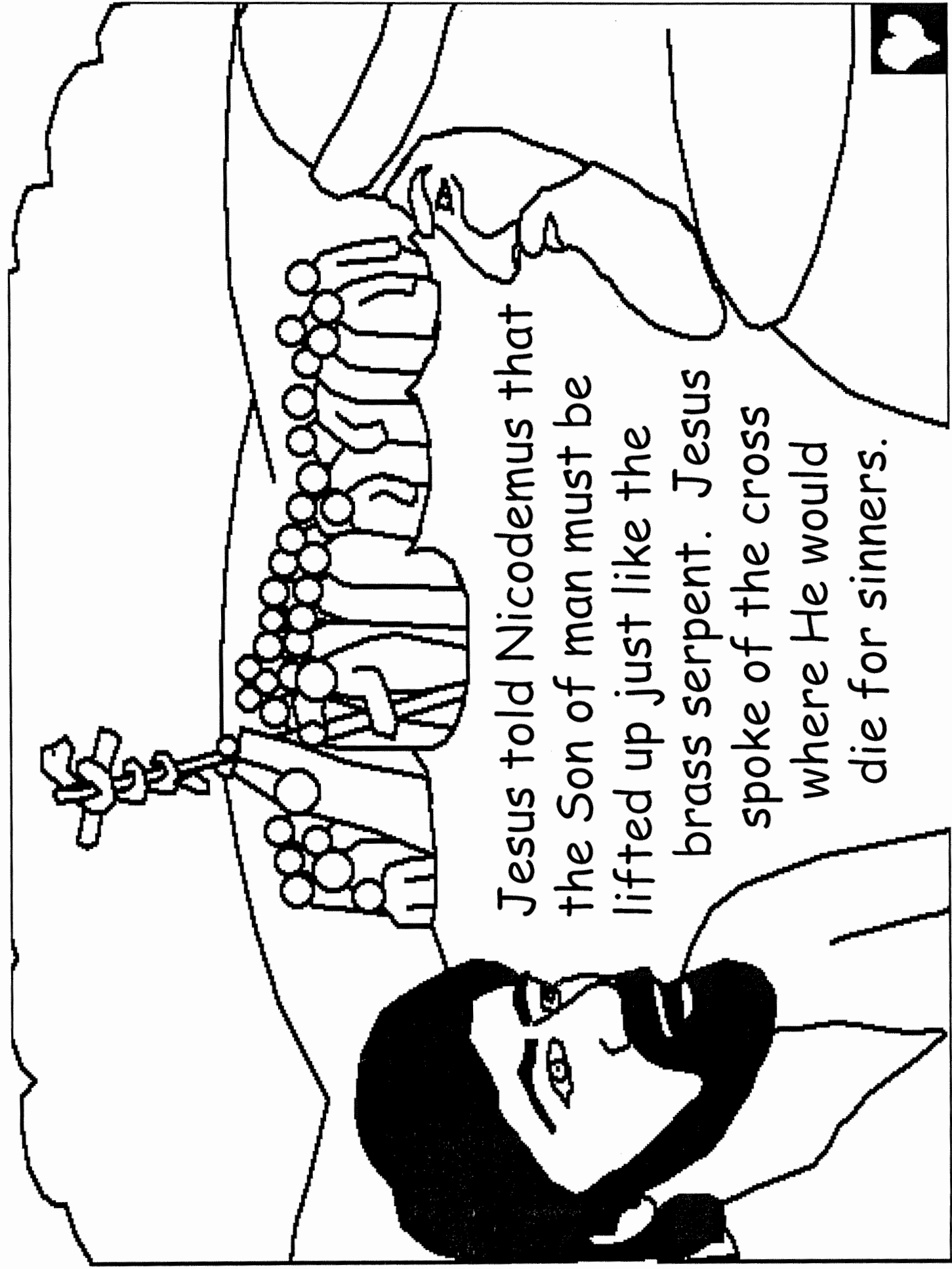

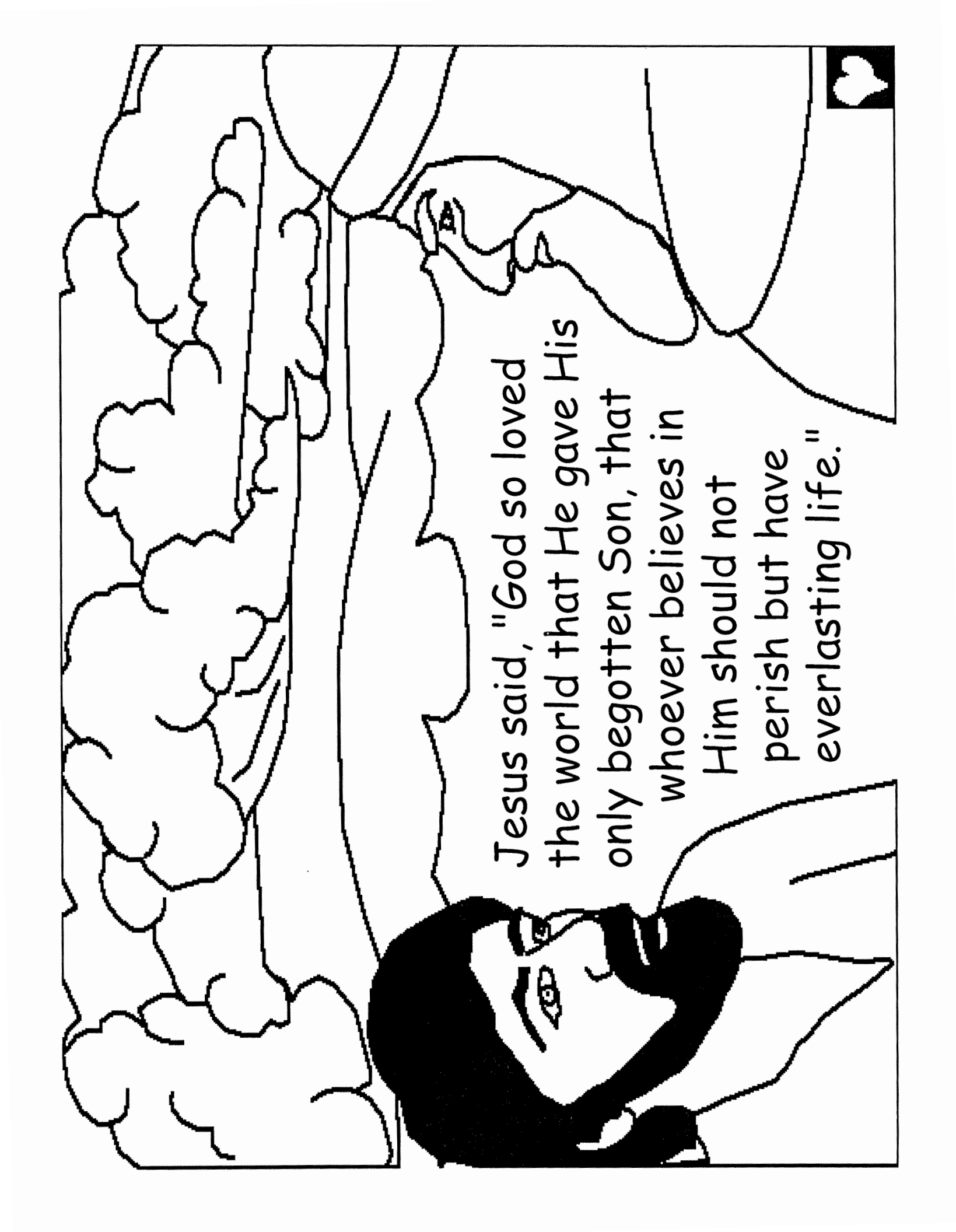

Jesus said, "God so loved  
the world that He gave His  
only begotten Son, that  
whoever believes in  
Him should not  
perish but have  
everlasting life."

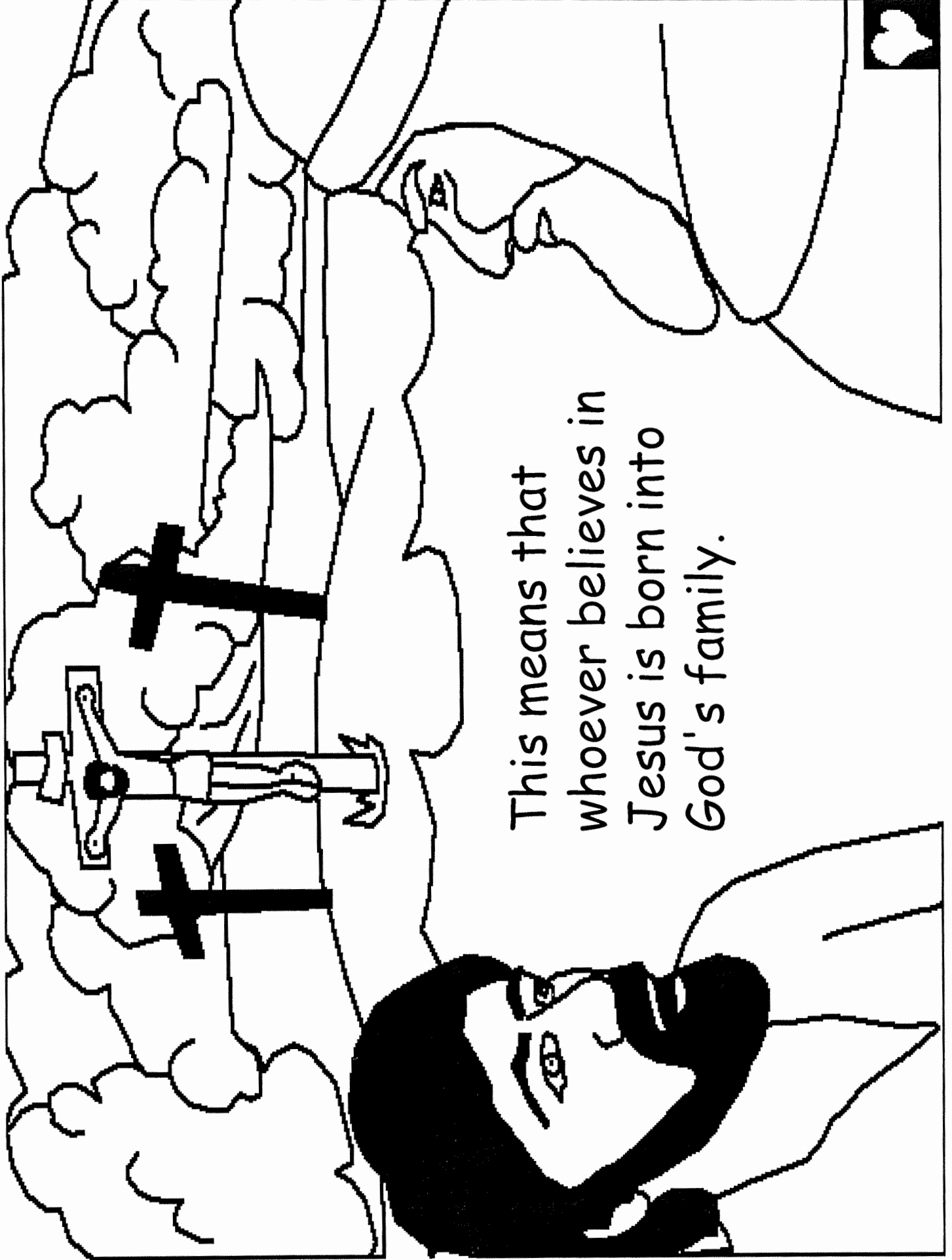

This means that  
whoever believes in  
Jesus is born into  
God's family.



Maybe Nicodemus did not become a disciple of Jesus that night. But years later, Nicodemus showed that he loved and believed in Jesus by helping to bury the crucified Son of God.

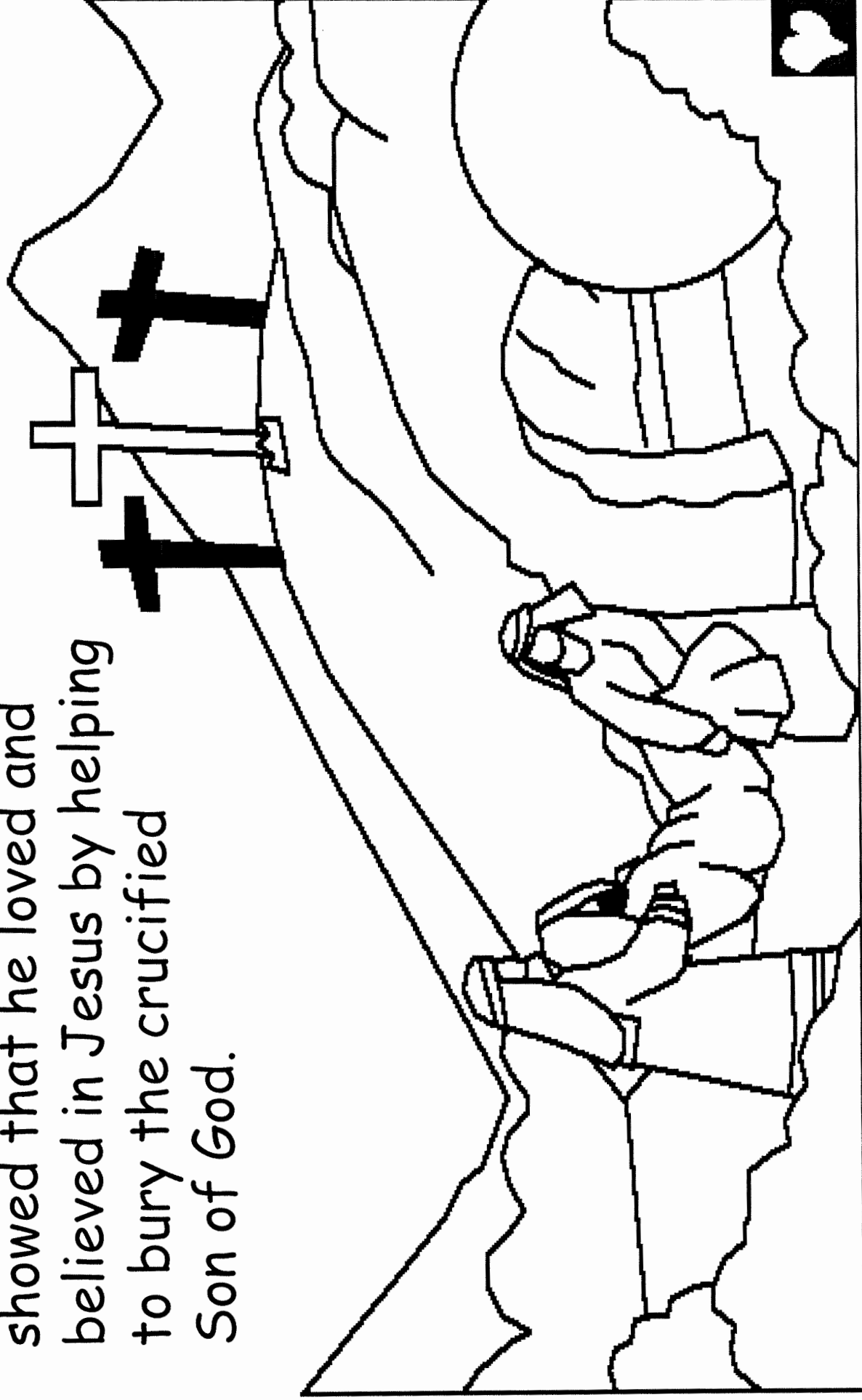



After this, Jesus and His disciples set out to travel North. Other people needed to hear about God's Kingdom, and have the chance to believe in Jesus of Nazareth, the Son of God.

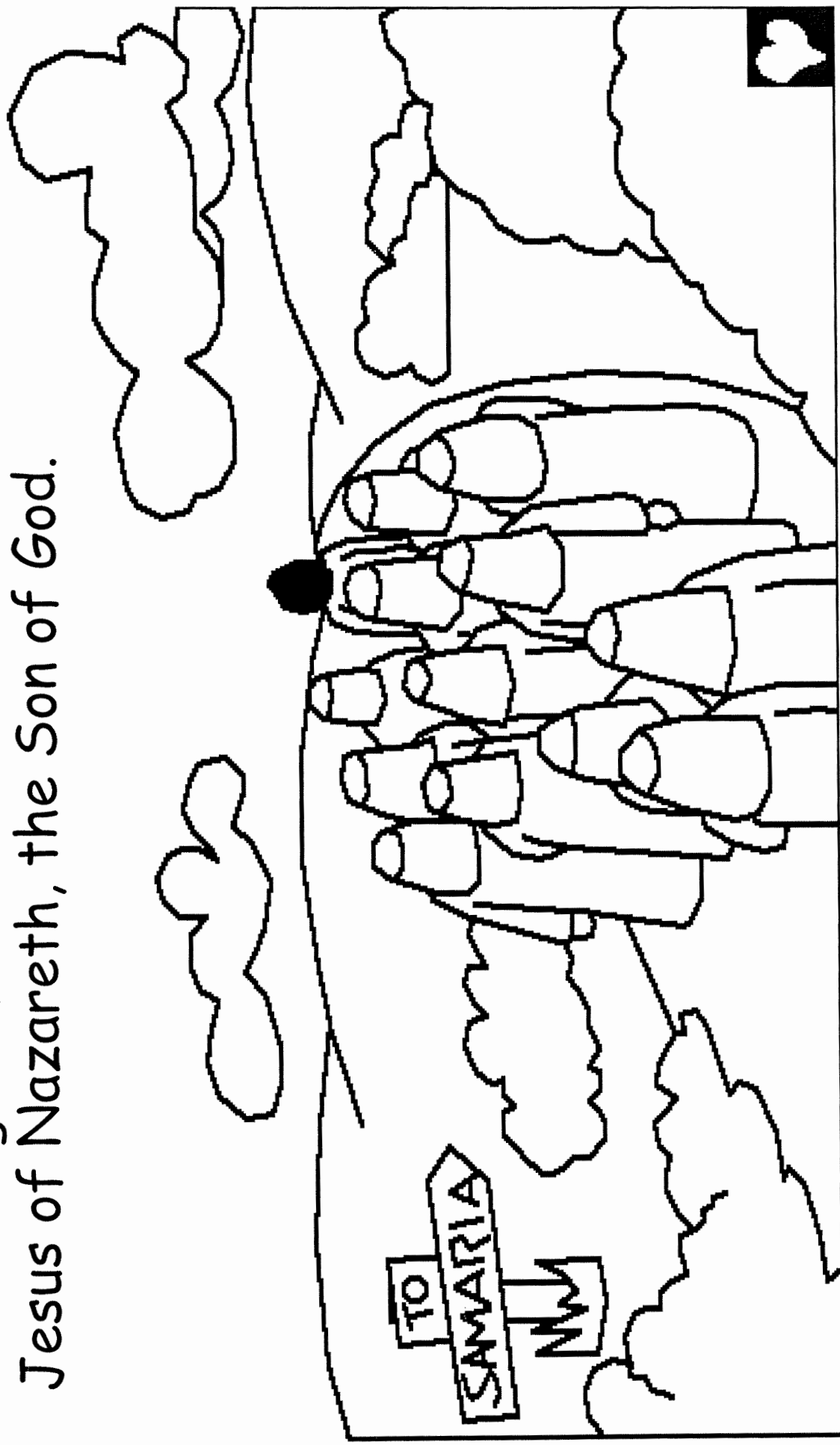



Jesus and Nicodemus  
*John 3*

**Jesus and  
Nicodemus**  
John 3

# A Bible Verse for Everyone

.....  
 In the puzzle, there is a special place for every word in this Scripture. All shared letters have been filled in for you to give you a good start.  
 Can you find the right fit?  
 .....

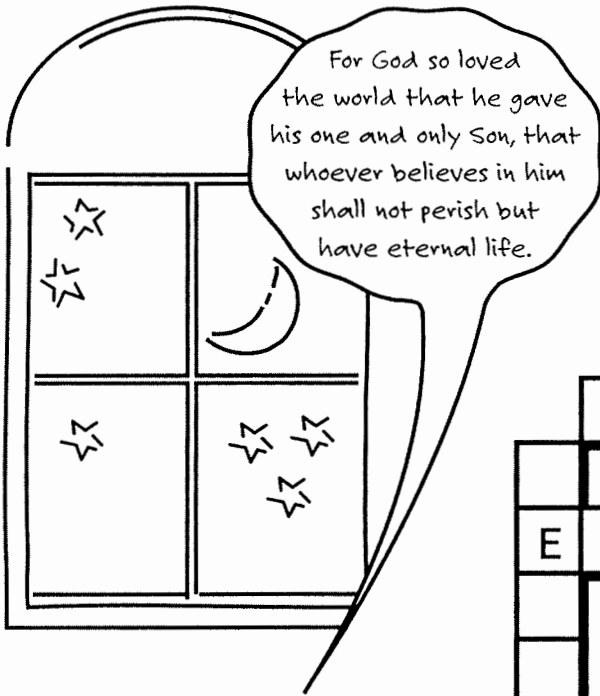

When Nicodemus came with questions, Jesus tried to help him understand God's love and the promise of eternal life.

This explanation includes a Bible verse that has become a favorite for all who hear it—John 3:16.

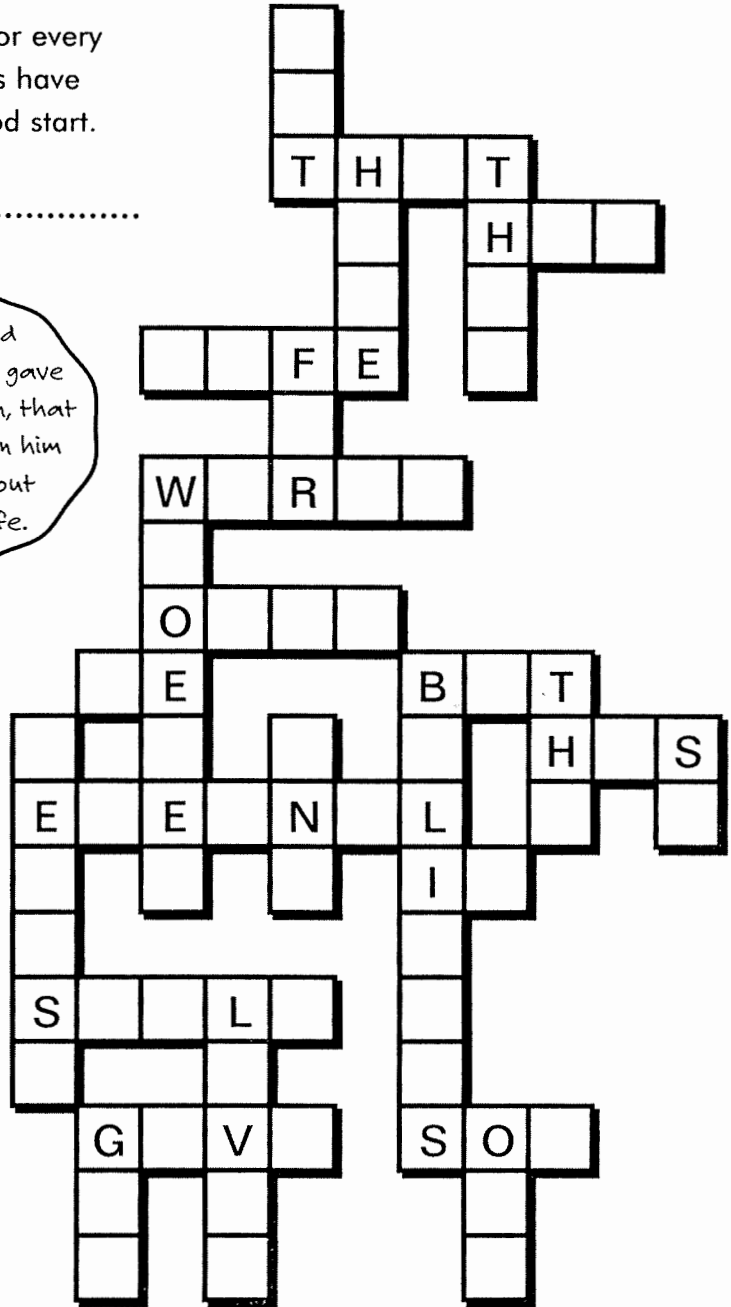

# How Much?

Add these numbers to give you the code you need to find out how much God loves us.

1 <u>+2</u> = A	8 <u>+9</u> = C	10 <u>+5</u> = D	3 <u>+3</u> = E	5 <u>+4</u> = G
2 <u>+2</u> = H	7 <u>+6</u> = I	4 <u>+4</u> = L	9 <u>+9</u> = M	10 <u>+1</u> = N
1 <u>+0</u> = O	3 <u>+2</u> = R	1 <u>+1</u> = S	4 <u>+3</u> = T	8 <u>+8</u> = U
6 <u>+6</u> = V	5 <u>+5</u> = W	13 <u>+1</u> = Y		

9	1	15		8	1	12	6	15		7	4	6		10	1	5	8	15
---	---	----	--	---	---	----	---	----	--	---	---	---	--	----	---	---	---	----

2	1		18	16	17	4		7	4	3	7		4	6
---	---	--	----	----	----	---	--	---	---	---	---	--	---	---

9	3	12	6		4	13	2		1	11	8	14		2	1	11
---	---	----	---	--	---	----	---	--	---	----	---	----	--	---	---	----



## **Year 3**

### **Week 122**

#### **Jesus Helps Those Who Believe**

**Scriptures: John 4**

**Key Verse: John 4:24 “God is Spirit, and those who worship Him must worship him in spirit and in truth.”**

#### **Key Points:**

1. Jesus came to the land of Samaria on his way to Galilee. Jacob’s well was there and Jesus being tired, went to the well to sit and drink water. A woman from Samaria also came to drink. Jesus asked her to draw water from the well for him. She asked him why he would bother with her being a Samaritan. Jews don’t fellowship with Samaritans. Jesus told her that if she knew who had asked her for a drink, he would have given her “living water”.

2. The woman asked him where would he get this “living water” since he had nothing to draw the water with. Jesus told her anyone drinking His water would never thirst again. Jesus could provide peace and forgiveness that no one else could give. The woman wanted the living water so Jesus told her to take the sin out of her life. She was not living in a way God wanted. Jesus also talked to her about worshiping God. We should worship Him in spirit and in truth. The woman left Jesus and went into the city, telling her relatives about Jesus. Many of them went to him and believed in Jesus because of the testimony of the woman at the well.

3. Jesus then went to Cana. This is where he turned water into wine at a wedding feast, so the miracles of Jesus were well known there. A nobleman from the nearby city of Capernaum had a son who was very ill. He heard about Jesus and went to where he was. He implored Jesus to come visit his son because he had a high fever and was close to death. Jesus told him to go on his way, for his son lived. When he got home, his servant told him “Your son lives”! He asked his servant at what time he son’s fever had left and the servant told him. It was at the same time the man had seen Jesus. So the nobleman believed along with his whole household.

**Jesus Heals  
Many  
Luke 4**

# Circle Search

Hidden in this circle are ten different health problems that Jesus healed during his ministry on earth. Write them in a list as you find them. Can you think of others? Add them to the bottom of the list.

1. \_\_\_\_\_
2. \_\_\_\_\_
3. \_\_\_\_\_
4. \_\_\_\_\_
5. \_\_\_\_\_
6. \_\_\_\_\_
7. \_\_\_\_\_
8. \_\_\_\_\_
9. \_\_\_\_\_
10. \_\_\_\_\_

**EXTRAS**

\_\_\_\_\_

\_\_\_\_\_

\_\_\_\_\_

\_\_\_\_\_

\_\_\_\_\_

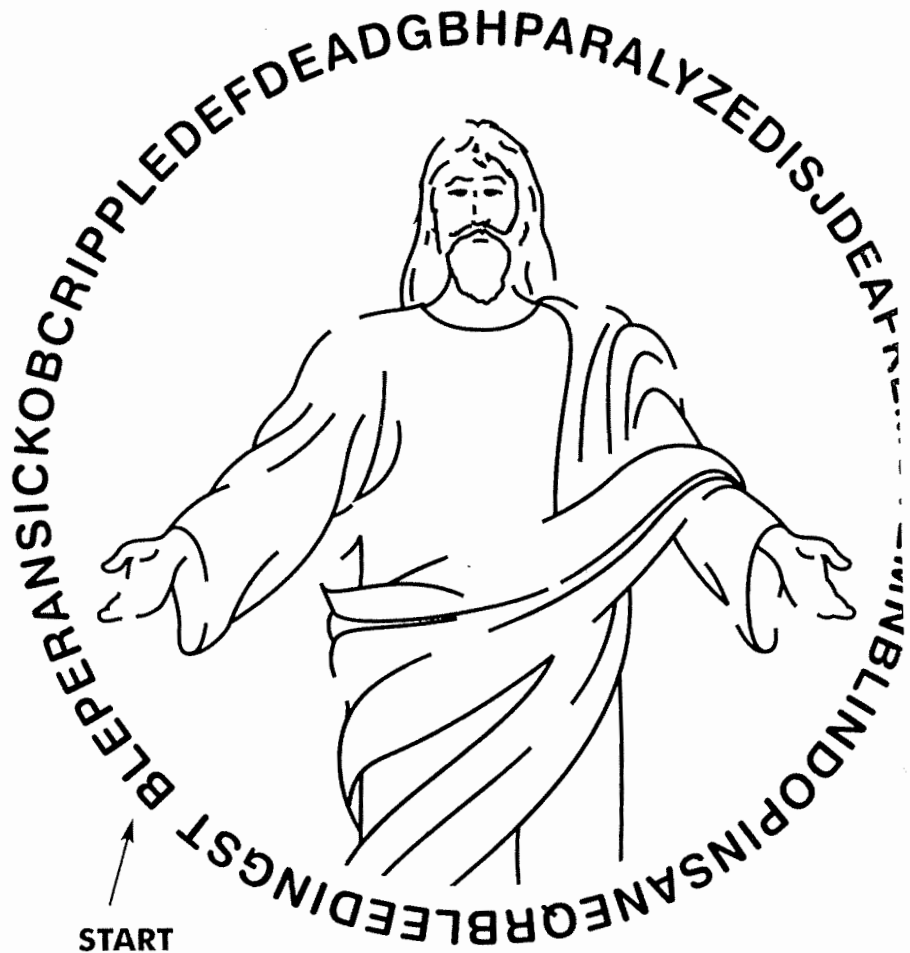

Jesus and a Samaritan Woman  
John 4:3-26

# Living Water

When Jesus lived on earth, Jewish people and Samaritan people did not like each other. But Jesus, who was a Jew, stopped at a well and asked a Samaritan woman for a drink of water. She was surprised that Jesus would talk to her.

For each stone in the well, find the stone in the code that exactly matches it. Write the letter from the code in the matching stone to find out why Jesus talked to this woman.

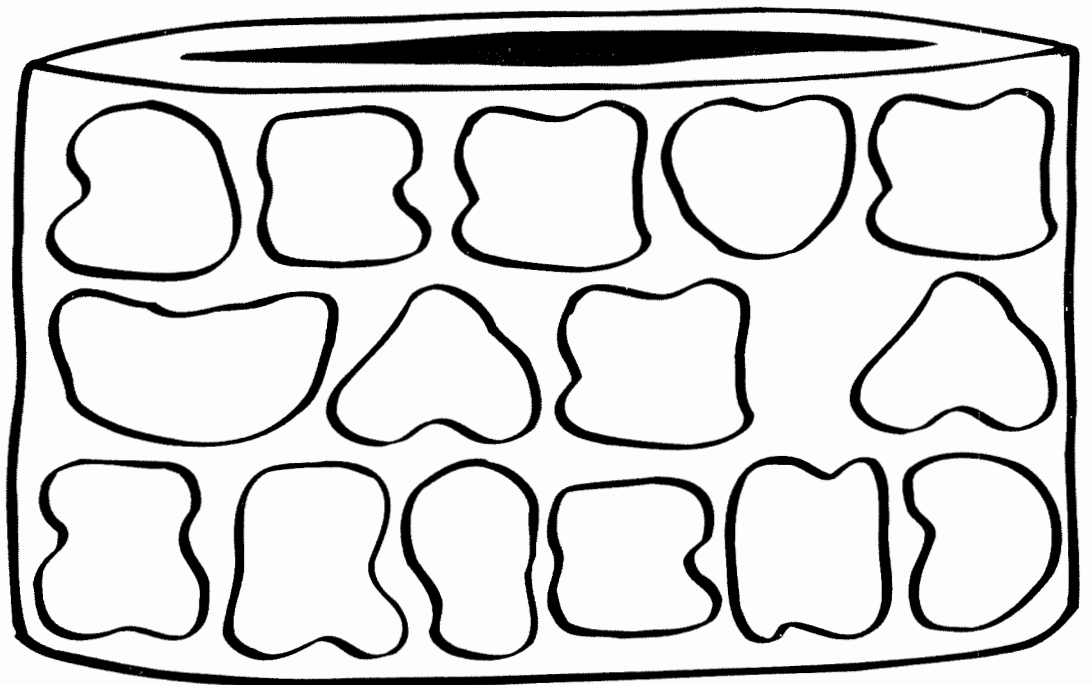
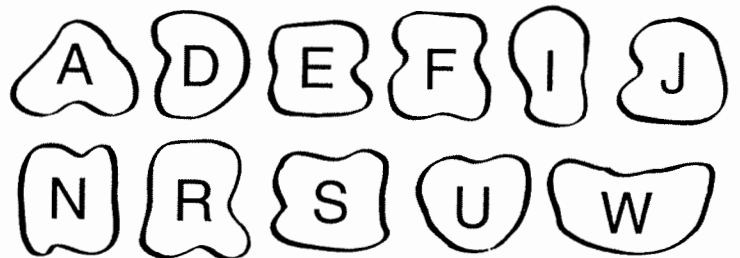



Jesus and the Samaritan Woman  
*John 4*



# JESUS AT THE WELL

(John 4:3-42)

While traveling to Galilee, Jesus and his followers stopped in a town of Samaria. The disciples went to get something to eat and Jesus sat down by the well known as Jacob's Well. Soon a woman came by the well. Jesus asked her for a drink of water. After she gave him the water, Jesus began talking to her about the kind of life God wants to give to his children. By doing so, he gave her a new sense of hope about her own life. She went back to town and returned with many others who wanted to meet him. Jesus and the disciples stayed in Samaria two more days.

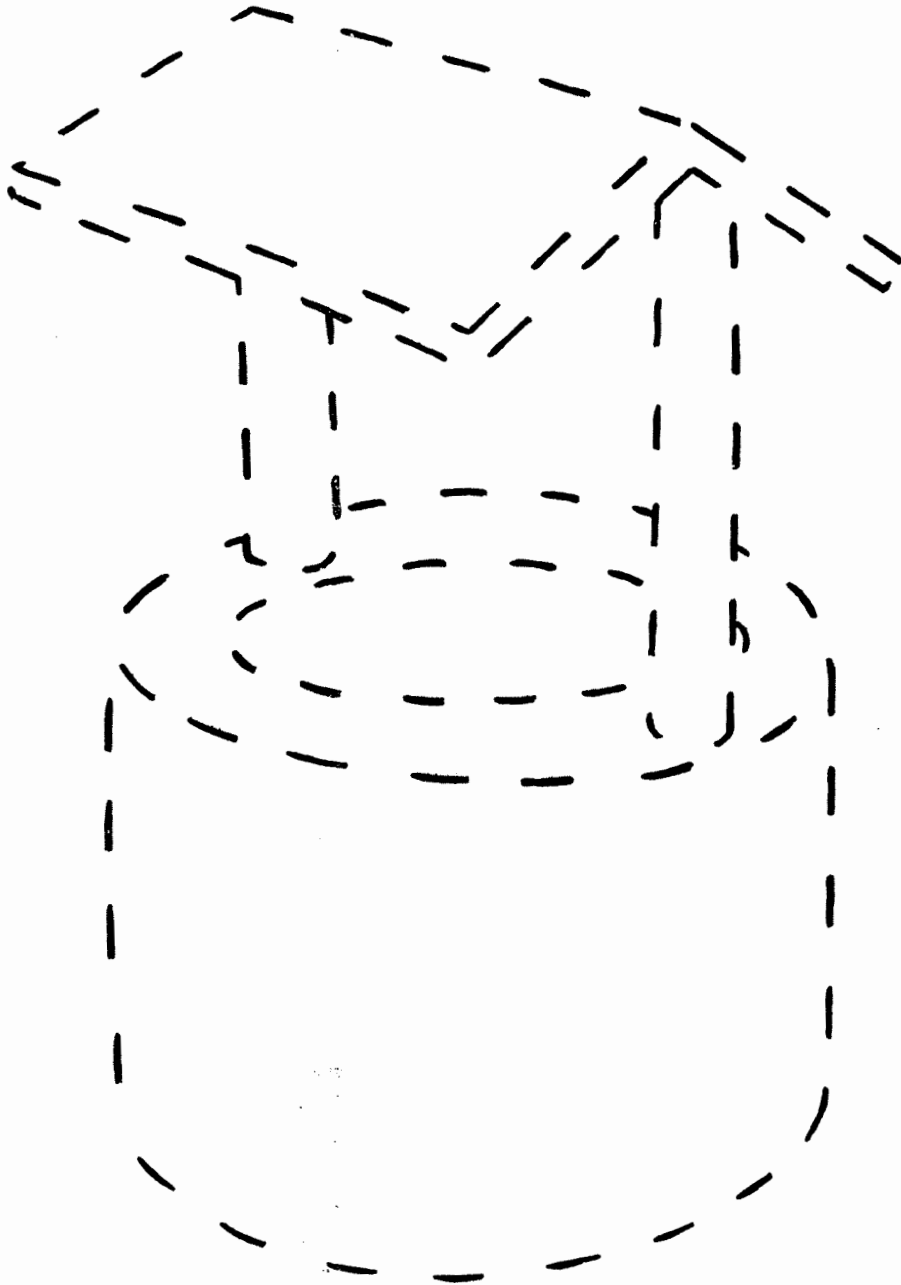

Draw a picture of a well by connecting the lines.

# Take A Journey

Unscramble the names below to discover some of the many places Jesus visited during his ministry on earth.

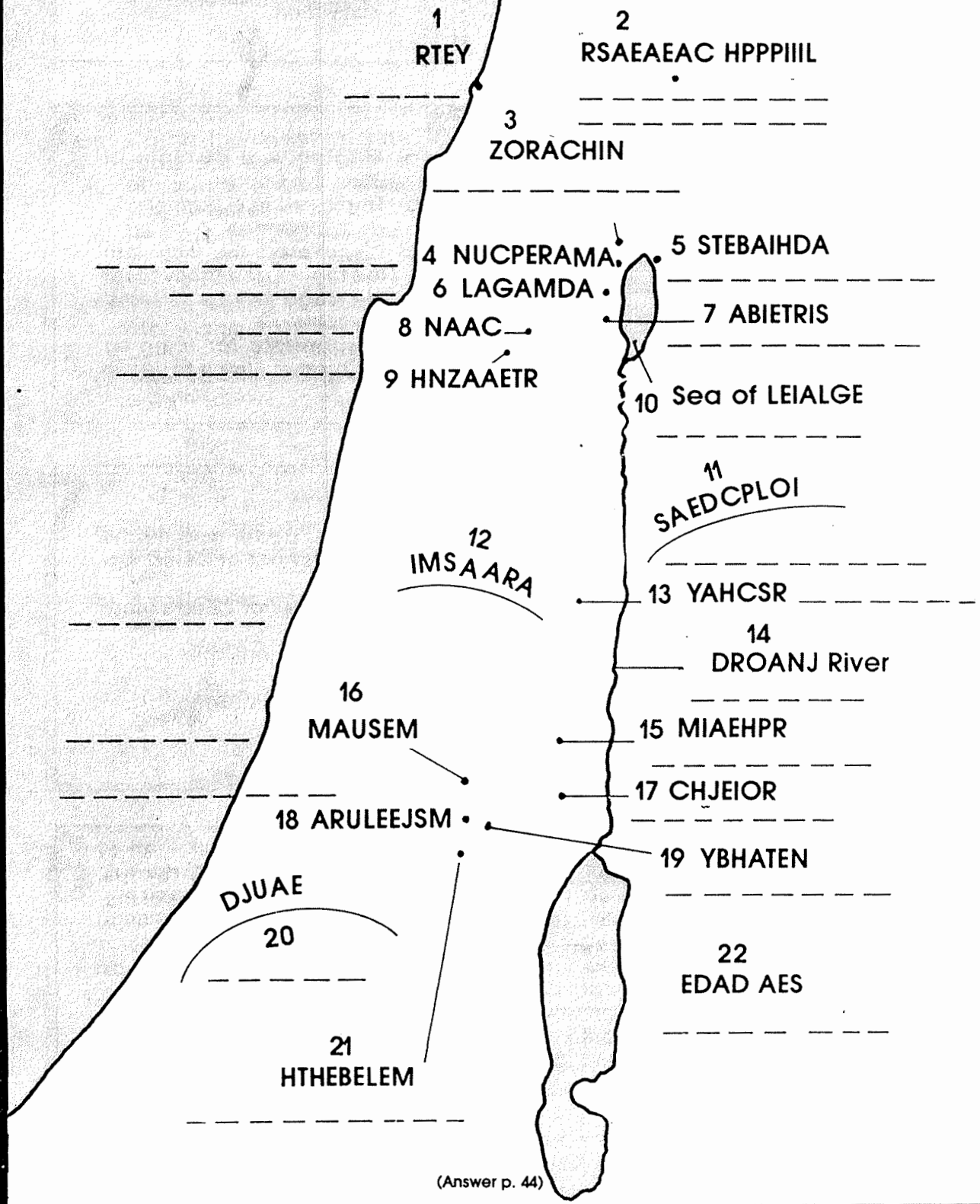

(Answer p. 44)

**Year 3**

**Week 123**

## **Man Healed at Pool of Bethesda**

**Scriptures: John 5:1-18 and Luke 4:16-32**

**Key Verse: Luke 4:2** And they were astonished at his doctrine: for his word was with power.

### **Key Points:**

- 1.** Jesus went to the pool of Bethesda in Jerusalem. Here many blind and ill people would go and sit. At certain times an angel would make the waters stir and whoever reached the pool first would be healed.
- 2.** There was a man who came to the pool who had been paralyzed 38 years. No one ever helped him into the pool when it was stirred. Jesus saw him lying there and healed him. He told him to take his bed and walk. This was on the Sabbath.
- 3.** Jesus healing this man on the Sabbath caused quite a lot of hatred and animosity towards him from the Jews. Their interpretation of the Sabbath laws caused them to believe he should not heal on the Sabbath. They also thought the man being healed should not have picked up his bed because it was a work.
- 4.** Jesus went to Nazareth and read in the synagogue and taught the people. The crowd became so angry they intended to push Jesus off a cliff at the edge of town. Jesus miraculously escaped his presence. Everyone was amazed at Jesus.

# 188. THE POOL AT BETHESDA

(JOHN 5:1-15)



"Jesus said to him, 'Rise, take up your bed and walk.' And immediately the man was made well, took up his bed, and walked..."  
JOHN 5:8-9

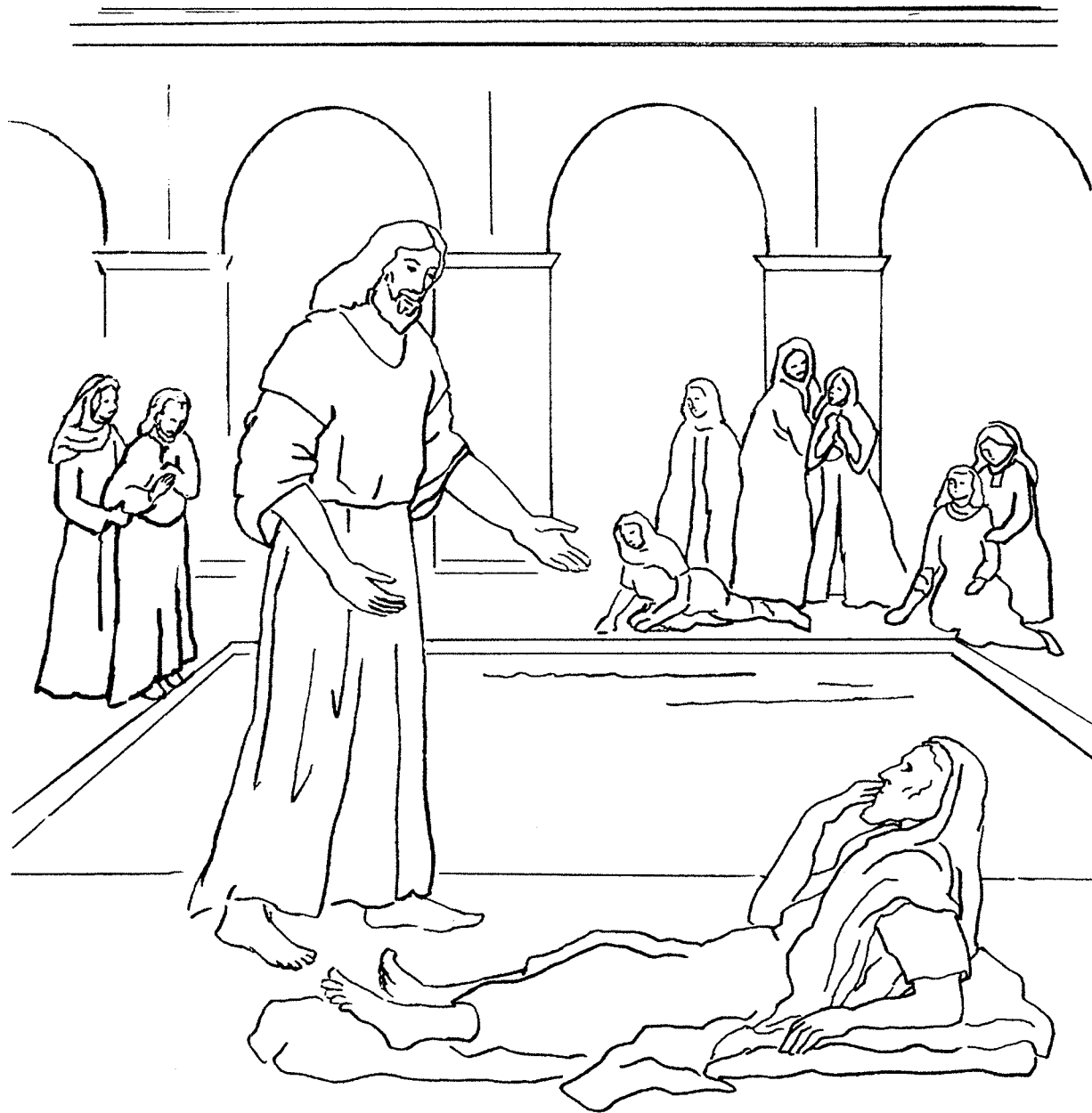

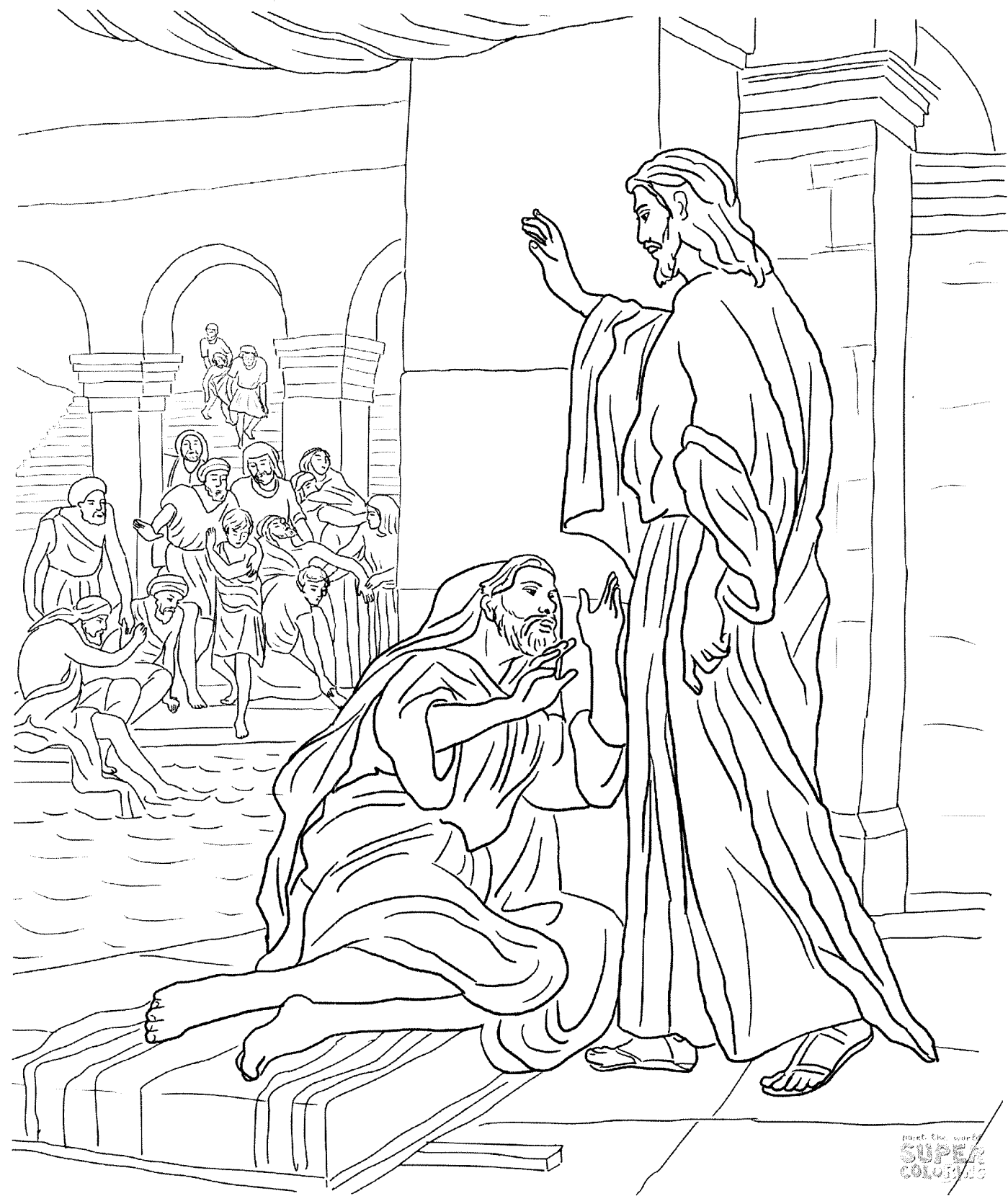

# THE POOL AT BETHESDA

## (JOHN 5:1-15)

### MEMORY VERSE:

*"Jesus said to him, 'Rise, take up your bed and walk.' And immediately the man was made well, took up his bed, and walked..." JOHN 5:8-9*

### CIRCLE THE CORRECT WORDS:

1. "After this there was a feast of the Jews, and (JESUS, HEROD) went up to Jerusalem." **JOHN 5:1**
2. "Now there is in Jerusalem by the Sheep Gate a pool, which is called in Hebrew, Bethesda, having five (WINDOWS, PORCHES)." **JOHN 5:2**
3. "In these lay a great multitude of sick people, blind, lame, paralyzed, waiting for the moving of the (PEOPLE, WATER)." **JOHN 5:3**

### FILL IN THE BLANKS:

4. "For an \_\_\_\_\_ went down at a certain time into the pool and stirred up the water; then whoever stepped in \_\_\_\_\_, after the stirring of the water, was made well of whatever disease he had." **JOHN 5:4**

### TRUE OR FALSE:

5. "Now a certain man was there who had an infirmity thirty-eight years." **JOHN 5:5**  
**TRUE OR FALSE**
6. "When Jesus saw him lying there, and knew that he had already been in that condition a long time, He said to him, 'Do you want to be made well?' " **JOHN 5:6**  
**TRUE OR FALSE**
7. Jesus said to him, "Rise, take up your bed and get into the water." **JOHN 5:8**  
**TRUE OR FALSE**
8. "And immediately the man was made well, took up his bed, and walked..." **JOHN 5:9**  
**TRUE OR FALSE**
9. "...And that day was the Sabbath." **JOHN 5:9**  
**TRUE OR FALSE**
10. The Jews therefore said to him who was cured, "It is the Sabbath; Praise God the man has been healed!" **JOHN 5:10**  
**TRUE OR FALSE**

# THE POOL AT BETHESDA

(JOHN 5:1-15)

G K H P V Z T Z B J N Q N I T  
E K S P A W P A R A L Y Z E D  
Y L S S A D Y M Q T D B K U D  
G O B L H Z S W E L L E G N A  
M J K F J E O E J N R I O A D  
Q E R R W O E F H A A T B F Q  
D Q V M B A D P I T Z A H F C  
H S N B A W L E G S E L F T U  
V S G O W N A M R A U B V Q J  
V P A S E H V Q C R T S I H K  
G M D B L Q C S T S I E E A S  
S B P L B I A Q C L E T O J M  
N B K K V A L V J P M B S U J  
P O O L D L T P W U D Z N U T  
B O S W D H O H Y T W Z H T A

ANGEL  
BETHESDA  
JESUS  
LAWFUL

MAN  
PARALYZED  
POOL  
SABBATH

SHEEP GATE  
STIRRED  
WALKED  
WELL

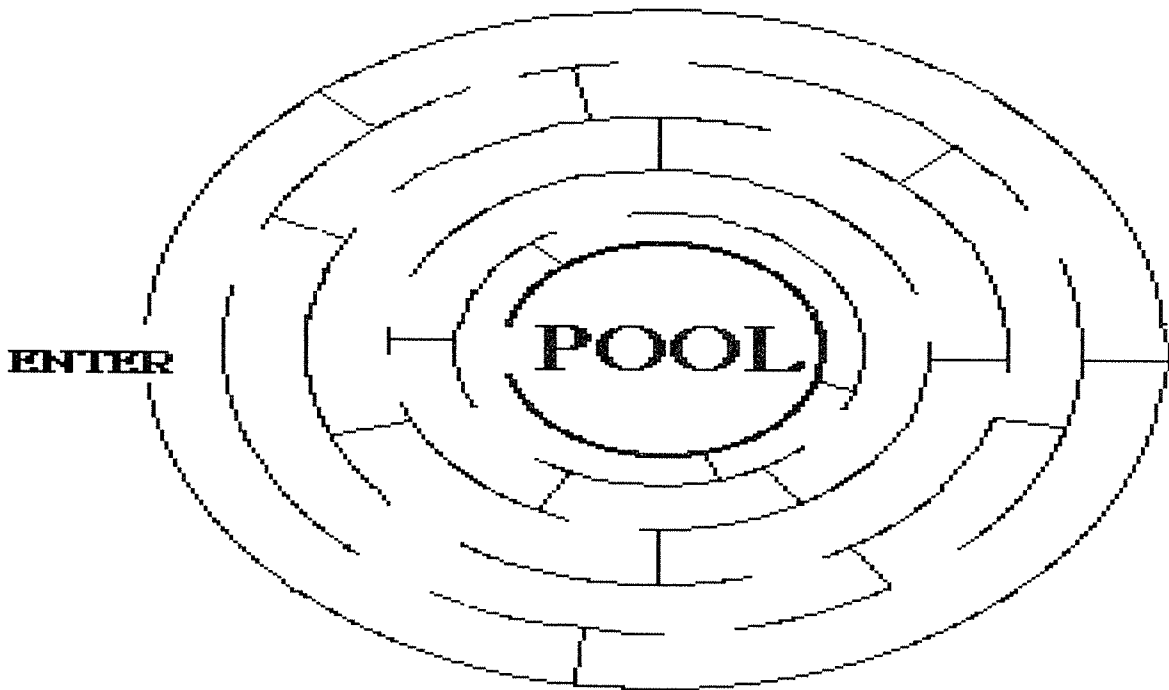



# THE POOL AT BETHESDA

## (JOHN 5:1-15)

C R S U H J G C Z T J W F L F H O E L T A E O P U  
 U L O O P T L C Z F E U L B A P E P W V B L I N D  
 Q J J W Z B U Q K A A F L B H S W T K R P M A U E  
 D S F J I I F I C Y W I M A W D A C I F P B T Z F  
 C T F N V A W W T Y L B S C E J E B J E A N M V P  
 N A O S V M A Z I O Z G Z W L H E R B W A L K E D  
 W F P Z B B L K O F B Y F K L Q B S R A B O Z F T  
 T Z E D E Z Y L A R A P P J C O K C S I T B J R O  
 I S E A Q T F K T V P P G U A I S H U S T H S K N  
 W D O K S Y H N A B J Y K K H A S U E J U S M K I  
 P J O B Y T A Q N S H B B O Z W L E G N A S B Y J  
 J Q C Z E M A J R V A D F I Y E U E A O V U E R J  
 E I F F L L W B P D G R U I M V H C V U Q L P J Y  
 W K K H N I B B S M E C K A V M P N D G D P C G T  
 S T E T A G P E E H S G L T N E E Q Q F V M D I H  
 P D B N V O H R I A U R C E J F P L E K S C T K G  
 W Y Y G Q T P B Q Z W G U J T S V O N D M C B U F  
 Q H N B E V E K D S D N M K P W A K R B C V B A Y  
 T U M B T Q S E J H W G D K L U R E R C Z Z G V Q  
 A Q H G A Z G F Q M Y Z L P J D S D Y K H K E B D  
 I N F I R M I T Y B P J S Z C I L D Y K L E I O C  
 U S L R Q U D J R S Z P V Y R S W O D A U F S U M  
 U S D Q F A E T I V W N R Y V J K J T T K K V P  
 H I R I H N P E L O B U C O T H U Q I W M S B Z O  
 E L E P P M Z J S J M O M J W Q O K P L O M P A E

- |              |           |           |            |
|--------------|-----------|-----------|------------|
| ANGEL        | INFIRMITY | MAN       | SHEEP GATE |
| BETHESDA     | JESUS     | PARALYZED | SICK       |
| BLIND        | JEWS      | POOL      | STIRRED    |
| FEAST        | LAME      | RISE      | WALKED     |
| FIVE PORCHES | LAWFUL    | SABBATH   | WELL       |

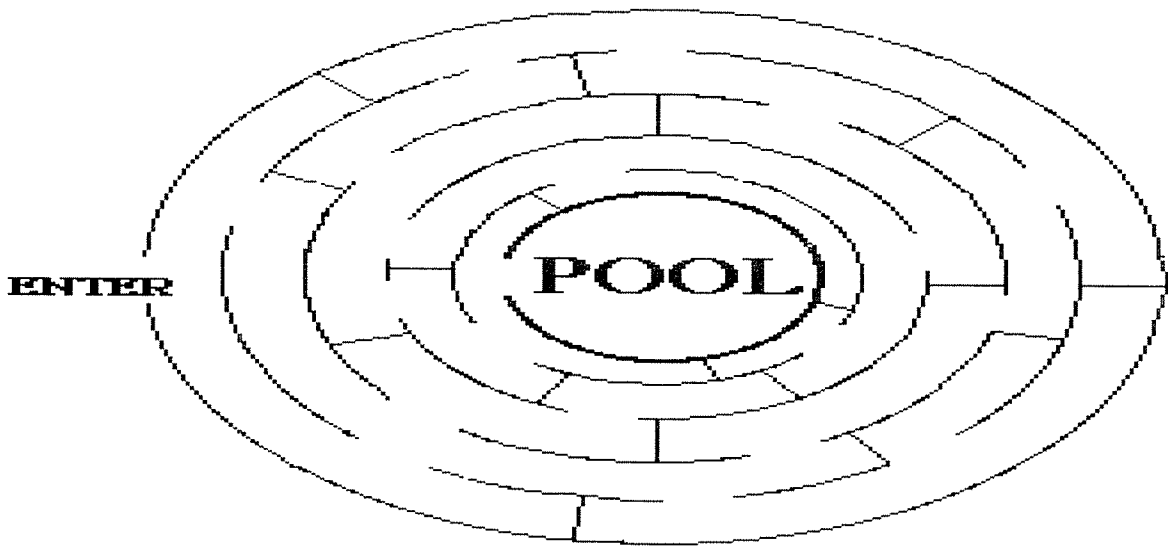

# THE POOL AT BETHESDA

## (JOHN 5:1-15)

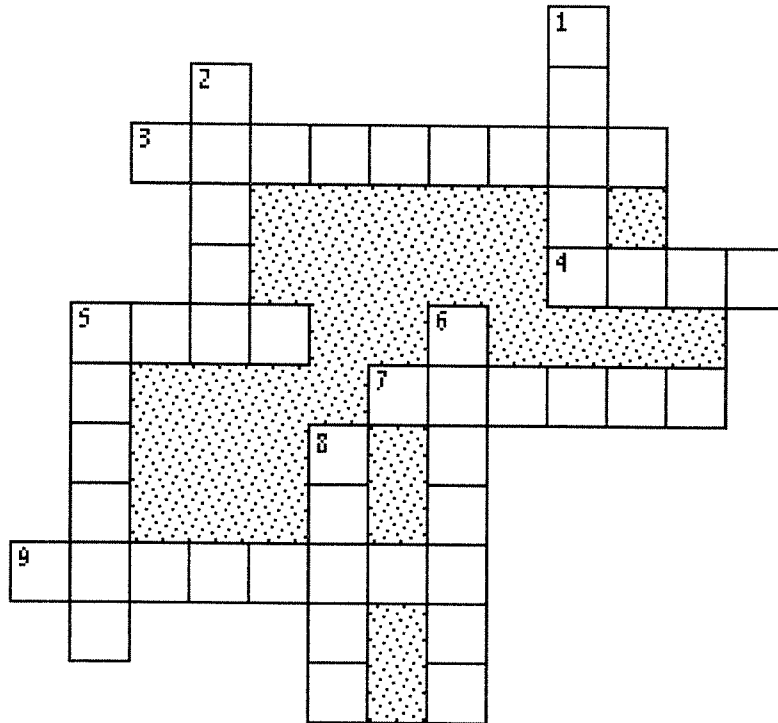

- 8 DOWN "After this there was a feast of the Jews, and \_\_\_\_\_ went up to Jerusalem." **JOHN 5:1**
- 9 ACROSS "Now there is in Jerusalem by the Sheep Gate a pool, which is called in Hebrew, \_\_\_\_\_, having five porches." **JOHN 5:2**
- 1 DOWN "In these lay a great multitude of sick people, blind, lame, paralyzed, waiting for the moving of the \_\_\_\_\_." **JOHN 5:3**
- 2 DOWN "For an \_\_\_\_\_ went down at a certain time into the pool and stirred up the water; then whoever stepped in first, after the stirring of the water, was made well of whatever disease he had." **JOHN 5:4**
- 3 ACROSS "Now a certain man was there who had an \_\_\_\_\_ thirty-eight years." **JOHN 5:5**
- 5 ACROSS "When Jesus saw him lying there, and knew that he had already been in that condition a long time, He said to him, 'Do you want to be made \_\_\_\_\_?'" **JOHN 5:6**
- 4 ACROSS "Jesus said to him, '\_\_\_\_\_, take up your bed and walk.'" **JOHN 5:8**
- 5 DOWN "And immediately the man was made well, took up his bed, and \_\_\_\_\_." **JOHN 5:9**
- 6 DOWN "...And that day was the \_\_\_\_\_." **JOHN 5:9**
- 7 ACROSS "The Jews therefore said to him who was cured, 'It is the Sabbath; it is not \_\_\_\_\_ for you to carry your bed.'" **JOHN 5:10**

## Year 3

### Week 124

#### Jesus Shows His Power

**Scriptures:** Matt 8:16-34, Luke 5:12-17, 5:1-11

**Key Verse: Luke 5:5** However, the report went around concerning Him all the more; and great multitudes came together to hear, and to be healed by Him of their infirmities.

#### Key Points:

1. Jesus began to do many miracles. Each day he was quite busy. People crowded around him to hear his teachings. There were so many that houses could not contain them nor could they hear what Jesus had to say. For this reason, he went out to the side the Sea of Galilee where he taught from inside a boat. This boat belonged to Simon Peter.
2. After Jesus finished teaching he spoke to Simon. He and two other fishermen, James and John, had fished all night and had not caught any fish. Jesus told him to cast their nets out on the other side of the boat. So thinking it would do no good, they cast their nets as Jesus said. When they tried to pull their nets out there were so many fish caught that it almost sank the two boats they were using. They were astonished at this. Jesus told him that from now on they would be fishers of men. They left their home and became followers of Jesus.
3. A man had leprosy and asked Jesus to heal him and so He did. A storm arose while Jesus and his followers were in a boat on the sea. Many were afraid and Jesus asked them about their faith. He calmed the sea and many marveled. Jesus did many other miracles. People were healed and demons were cast out. At times Jesus needed a quiet place to pray. He would withdraw to a lonely place to be with His father in prayer.

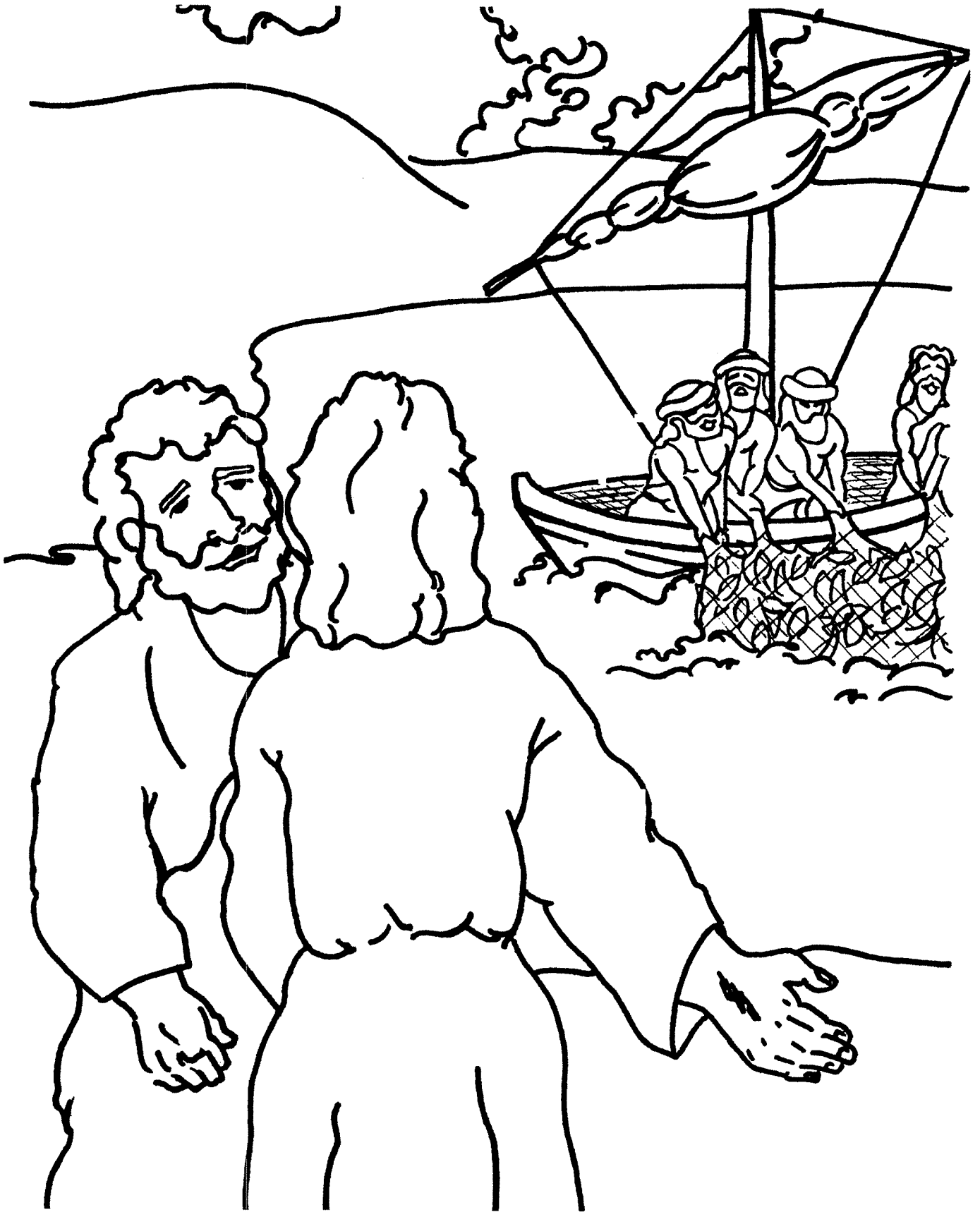

"Jesus said to them, 'Follow Me, and I will make you fishers of men.' Then they immediately left their nets and followed Him." *Matthew 4:19 – 20*

Jesus Calms a Storm  
Mark 4:35-41

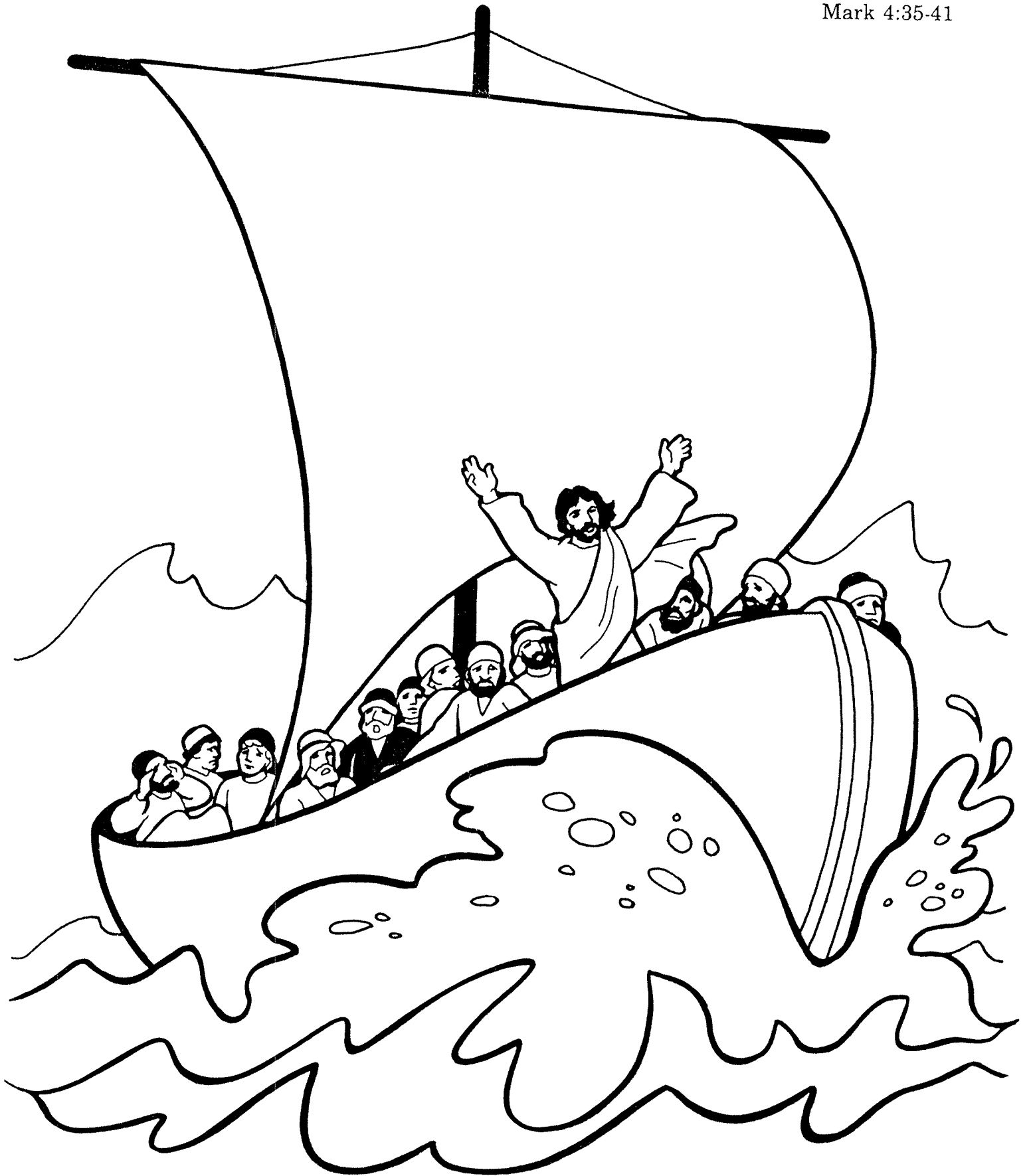



Jesus Heals the Leper



Jesus Heals a Paralyzed Man  
Mark 2

# JESUS CALMS A STORM

## (MATTHEW 8:23-27)

### MEMORY VERSE:

*"Then they cry out to the LORD in their trouble, and He brings them out of their distresses. He calms the storm, so that the waves are still. Then they are glad because they are quiet; so He guides them to their desired haven." PSALM 107:28-30*

### UNDERLINE THE CORRECT ANSWER:

1. "Now when He got into a boat,..." **MATTHEW 8:23**
  - a. the Pharisees followed Him
  - b. His disciples followed Him

### CIRCLE THE CORRECT WORD:

2. "And suddenly a great tempest arose on the sea, so that the boat was covered with (**WAVES, BIRDS**)..." **MATTHEW 8:24**

### TRUE OR FALSE:

3. "...But He was asleep." **MATTHEW 8:24**  
TRUE OR FALSE
4. Then His disciples came to Him and awoke Him, saying, "Lord, let's do some fishing!" **MATTHEW 8:25**  
TRUE OR FALSE

### CIRCLE THE CORRECT WORDS:

5. "But He said to them, 'Why are you fearful, O you of little (**FISH, FAITH**)?'..." **MATTHEW 8:26**
6. "...Then He arose and rebuked the winds and the sea, and there was a great (**CALM, WAVE**).'" **MATTHEW 8:26**

### FILL IN THE BLANK:

7. "So the men marveled, saying, 'Who can this be, that even the winds and the sea \_\_\_\_\_ Him?' " **MATTHEW 8:27**



# JESUS CALMS A STORM

## (MATTHEW 8:23-27)

### MEMORY VERSE:

*"Then they cry out to the LORD in their trouble, and He brings them out of their distresses. He calms the storm, so that the waves are still. Then they are glad because they are quiet; so He guides them to their desired haven." PSALM 107:28-30*

### UNDERLINE THE CORRECT ANSWER:

1. "Now when He got into a boat,..." **MATTHEW 8:23**
  - a. the Pharisees followed Him
  - b. His disciples followed Him

### FILL IN THE BLANK:

2. "And suddenly a great tempest arose on the sea, so that the boat was covered with \_\_\_\_\_..." **MATTHEW 8:24**

### TRUE OR FALSE:

3. "...But He was asleep." **MATTHEW 8:24**  
TRUE OR FALSE
4. Then His disciples came to Him and awoke Him, saying, "Lord, let's do some fishing!"  
**MATTHEW 8:25**  
TRUE OR FALSE

### FILL IN THE BLANKS:

5. "But He said to them, 'Why are you fearful, O you of little \_\_\_\_\_?'..." **MATTHEW 8:26**
6. "...Then He arose and rebuked the winds and the sea, and there was a great \_\_\_\_\_." **MATTHEW 8:26**
7. "So the men marveled, saying, 'Who can this be, that even the winds and the sea \_\_\_\_\_ Him?' " **MATTHEW 8:27**

# JESUS CALMS A STORM

## (MATTHEW 8:23-27)

P G K W P R H T N I U C W Y W P L W Q W A Y E I S  
 M S S H B A F T A E T V Z B T T O I T K E E E F G  
 W N P Q Q Z V D S P O C O D L W U U P M I E M W E  
 N B P Y J P I D C D M T E M P E S T L L S J J L Y  
 G K E I I E E A Y I N C A F A B I M J U G A Q Q J U  
 K B R L C M L R Q Y J I K B O H I F B J J V V B W  
 O K B H T M O Q I B K H W E A J B O P E E L S A I  
 B O O T C D N C U S G R U H P Y R E J G P S E B A  
 Y J S Y J W H U Q B H E N T A K M P H C Z B U B C  
 K Q L O W Q I J T P H I U L D P A K T L F U V S L  
 P S K A L O R D H P S M N U Y G R J J U B O V J P  
 U P W V Y B U K T Y G E D G S K V F Y F B Z L K A  
 Y M V C J I A S T F D Q V W M G E Y R R K B A U I  
 F B S A T T E M R O V N L A U P L T D A M A I M E  
 K B J A N A S D R J B Y U Q W S E W C E Z M L B Y  
 T O B L V L A J I W G M F N N O D U G F B Z R Y A  
 G H W O A E F T W S C A L I S T W G S V I B U R Q  
 E S E Z S B F A P S C S Y S E W H H Q U Z T U T A  
 Y S L M L Z T A N S Z I H V J I T B U B F P C T O  
 G R V F P Z Q U K I H V P U M H I V M N Z Z Q C Y  
 M V D M U N H E B A K Y B L G J A S J H B F N M E  
 Q N D Q T N A T C G K K O U E D F U Q B D V R P A  
 H G Z S N O A N D W R W I A O S G B L A K N U M E  
 V D Z Q D O U Q W A E L R D V U T H J U B H N L Q  
 V P O V B B U B N F N W F D S O K U T V U N B C U

ASLEEP  
 BOAT  
 CALM  
 DISCIPLES  
 FAITH  
 FEARFUL

JESUS  
 LORD  
 MARVELED  
 OBEY  
 PERISHING

SAVE  
 SEA  
 TEMPEST  
 WAVES  
 WINDS

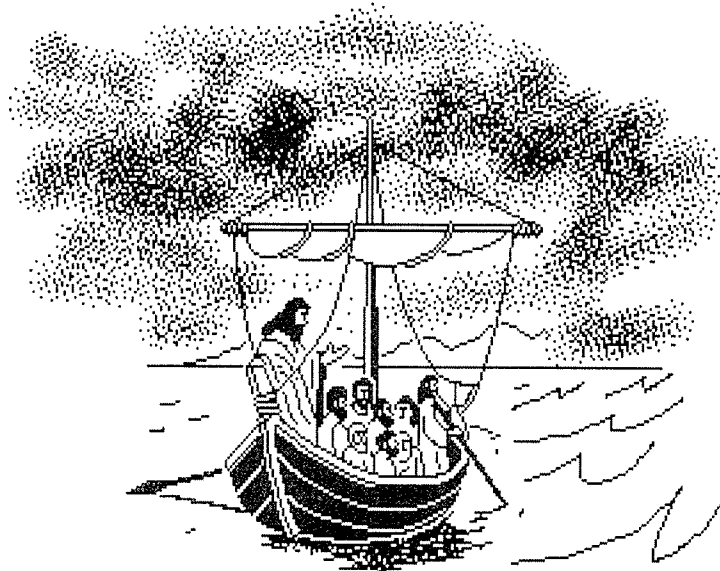

# 52. Jesus Calms the Storm

Find as many words as you can in the letters below. Go from left to right.

**STORMSEASTILLOBEYWINDISHIPAWAKEPEACE**

1. **STORM** \_\_\_\_\_

2. \_\_\_\_\_

3. \_\_\_\_\_

4. \_\_\_\_\_

5. \_\_\_\_\_

6. \_\_\_\_\_

7. \_\_\_\_\_

8. \_\_\_\_\_

9. \_\_\_\_\_

10. \_\_\_\_\_

11. \_\_\_\_\_

12. \_\_\_\_\_

13. \_\_\_\_\_

14. \_\_\_\_\_

15. \_\_\_\_\_

16. \_\_\_\_\_

17. \_\_\_\_\_

18. \_\_\_\_\_

19. \_\_\_\_\_

20. \_\_\_\_\_

## Super Word Finder!

21. \_\_\_\_\_

22. \_\_\_\_\_

23. \_\_\_\_\_

24. \_\_\_\_\_

25. \_\_\_\_\_

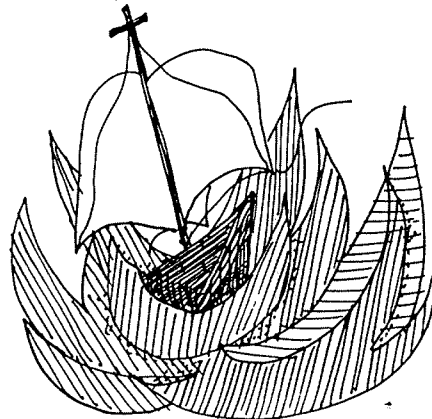

# Jesus Calms the Sea Matthew 8

# SOS

Use the letter code to find out what Jesus did.

In Morse code, SOS is a call for help. Jesus and his disciples were on the Sea of Galilee when a furious storm came up on the lake. The disciples immediately went to Jesus for help. What miraculous way did Jesus use to save his disciples from the storm?

A	B	C	D	E	F	G	H	I	J	K	L	M
F	M	H	Q	L	Y	P	V	N	U	R	D	J
N	O	P	Q	R	S	T	U	V	W	X	Y	Z
C	T	I	A	W	K	E	Z	S	G	O	B	X

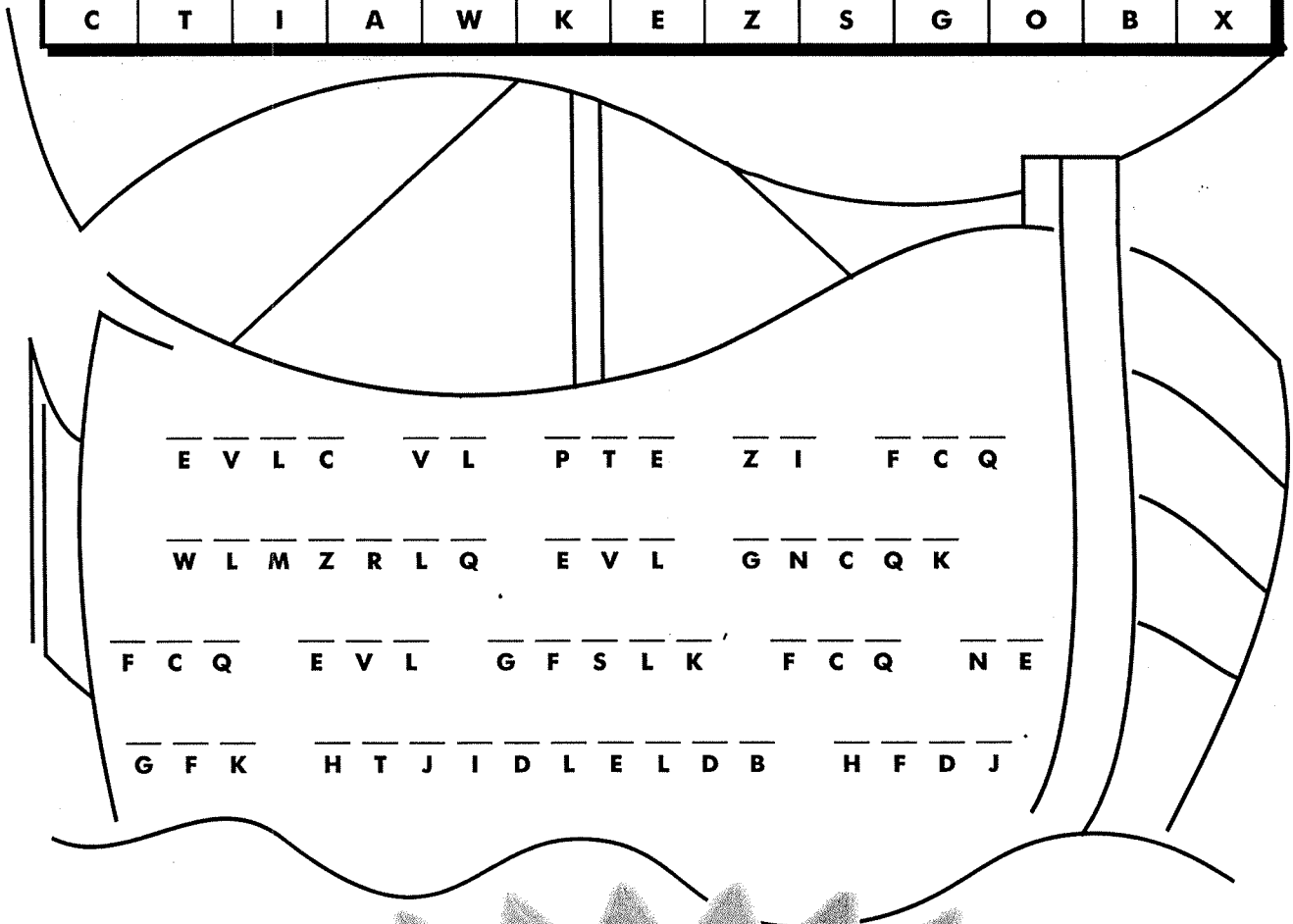

# Calm<sup>ing</sup> of the Sea

(Matthew 8:23-27)

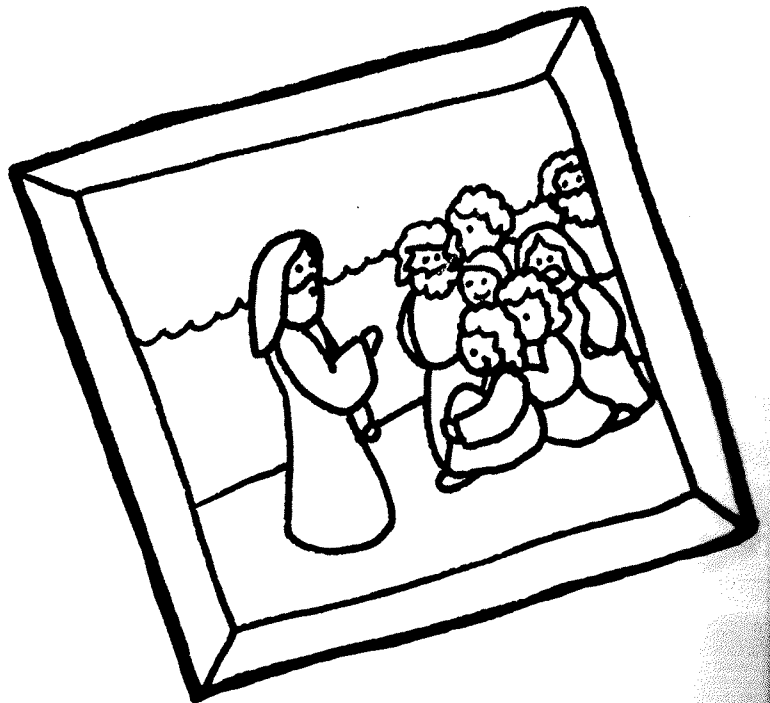
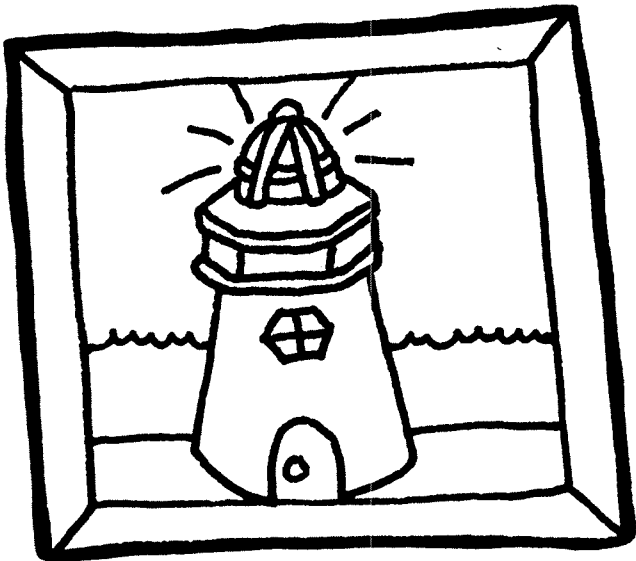
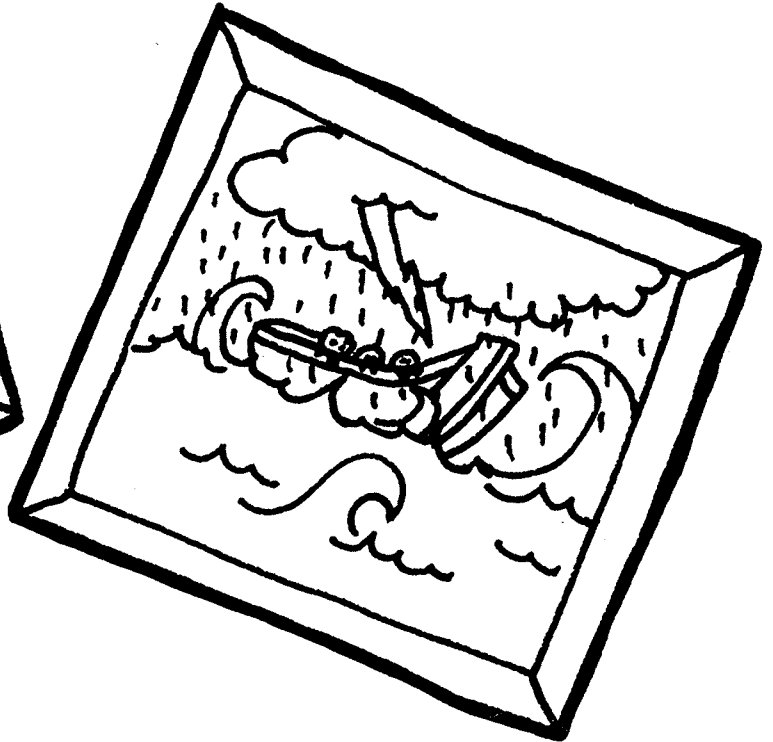
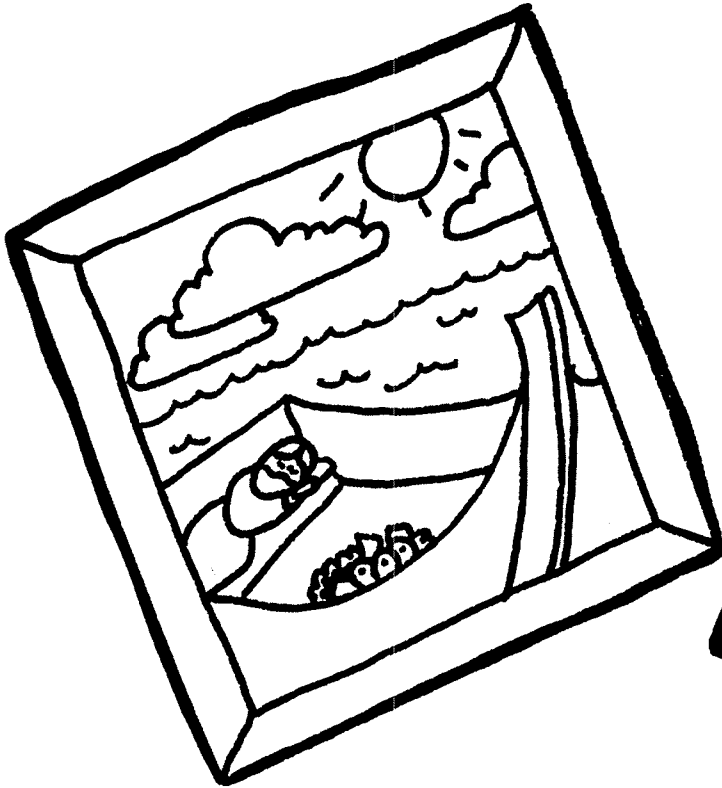

Circle the picture  
that does not belong.

**Year 3**

**Week 125**

## **Sermon on the Mount**

**Scriptures: Mathew 5 - 7**

**Key Verse: Matt 5:14 “You are the light of the world. A city sat on a hill that can not be hidden.”**

**Key Points:**

1. Many people followed Jesus to hear his teachings. He went to a mountain, his disciples with him, and sat down to teach.
2. Jesus taught on many topics. Cover as many as you feel your students can comprehend and time permits.

Some you can cover:

Beatitudes

Salt of the earth

Light of the world

The words we say are important

Our deeds should not be seen of men

The Lord's Prayer

Do not worry about our life, God knows what we need

Seek first the kingdom of God

Don't judge others

Foolish and wise builders

Jesus teaches with authority



For three days Jesus taught the doctrine of love and prayer, giving comfort to all who heard "The Sermon on the Mount."

# 47. The Beatitudes

Have you memorized the Beatitudes? They are found in Matthew 5:3-11. Try doing the puzzle without looking up the passage in your Bible.

Blessed are the poor in (5): for theirs is the kingdom of heaven. Blessed are they that (1 down): for they shall be comforted. Blessed are the meek: for they shall inherit the (10). Blessed are they which do (11) and thirst after righteousness: for they shall be filled. Blessed are the merciful: for they shall obtain (1 across). Blessed are the (8) in heart: for they shall see God. Blessed are the (7): for they shall be called the (2) of God. Blessed are they which are persecuted for righteousness' sake: for theirs is the kingdom of (3). Blessed are ye, when men shall (6) you, and persecute you, and shall say all manner of (9) against you falsely, for my (4).

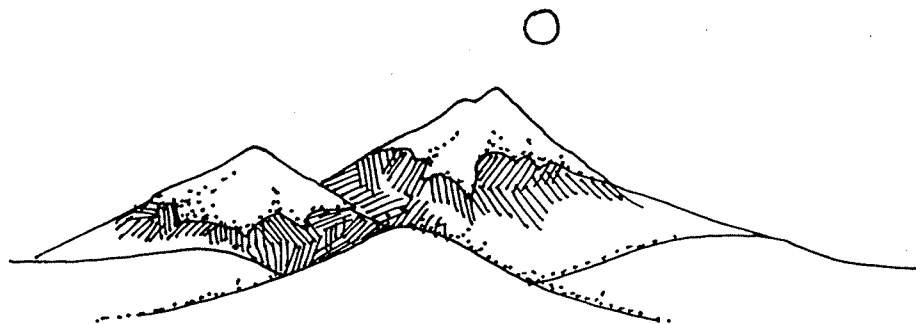
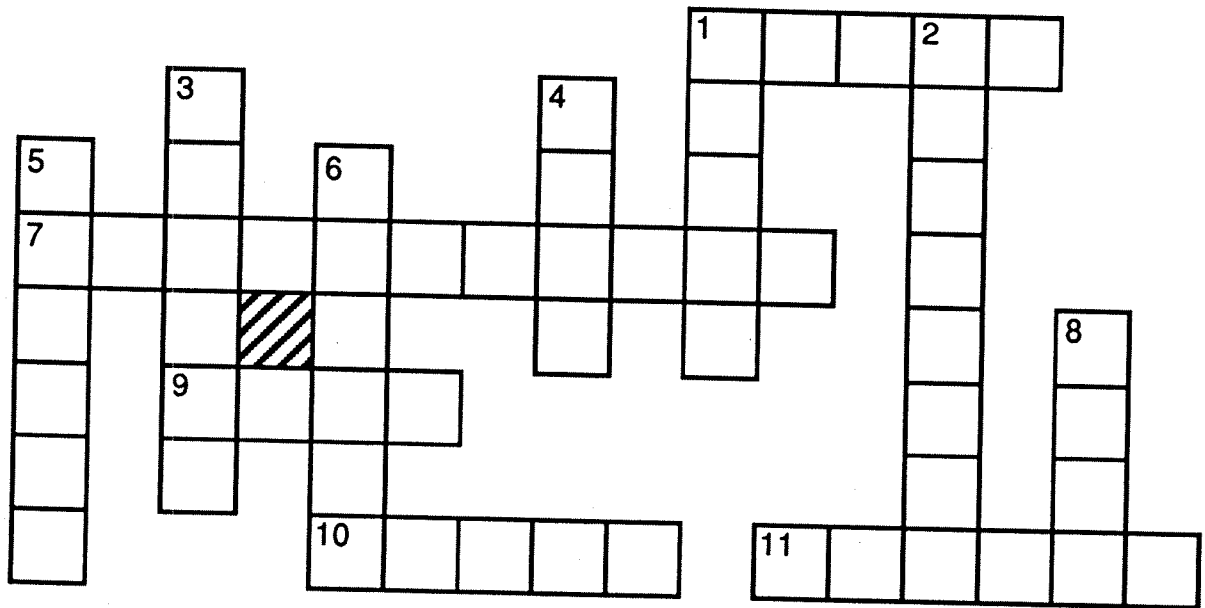



# 48. Sermon on the Mount

To find one of Jesus' messages from the Sermon on the Mount, write the first letter of each picture below it.

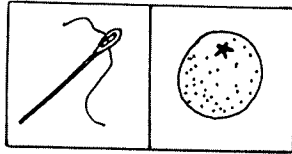

\_\_\_\_\_

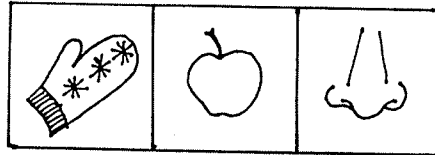

\_\_\_\_\_

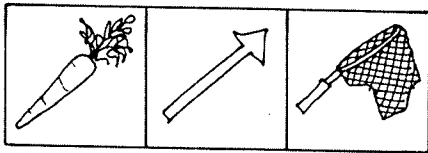

\_\_\_\_\_

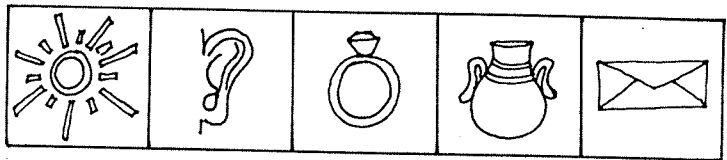

\_\_\_\_\_

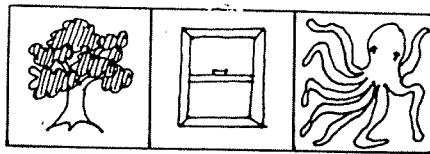

\_\_\_\_\_

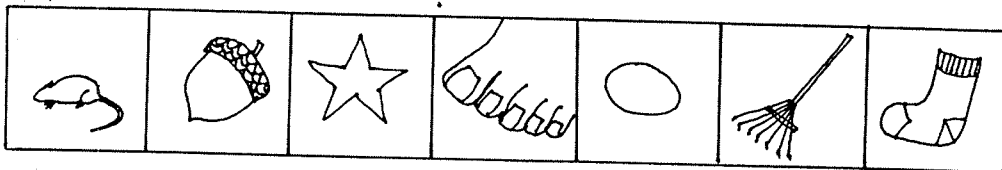

\_\_\_\_\_

Matthew 6:24



# Light of the World

Matthew 5:13-16 (NIV)

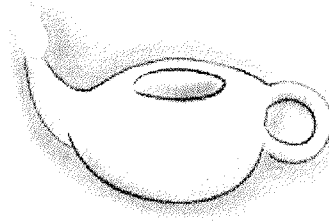

Jesus wanted the people to know that they should live lives that would please God and bless others. Unscramble the words below to see what he had to say.

You are the <sup>GLITH</sup> \_\_\_\_\_ of the <sup>OWRDL</sup> \_\_\_\_\_.

A <sup>TCYI</sup> \_\_\_\_\_ on a <sup>ILLH</sup> \_\_\_\_\_ cannot be hidden.

Neither do people light a <sup>AML P</sup> \_\_\_\_\_

and put it under a <sup>LOBW</sup> \_\_\_\_\_. Instead they

put it on a <sup>SANTD</sup> \_\_\_\_\_, and it gives light

to <sup>VEREYNOE</sup> \_\_\_\_\_ in the house.

In the same way, let your light <sup>HSNIE</sup> \_\_\_\_\_

before <sup>ENM</sup> \_\_\_\_\_, that they may see your













<sup>DOOG</sup> \_\_\_\_\_ <sup>EDEDS</sup> \_\_\_\_\_ and

Unscramble the letters in the circles and see what he said this would do for God.

\_\_\_\_\_ your Father in heaven.

# What Am I?

Read the story below by changing its letters and pictures into words. Then read Matthew 5:13-16.

U R the  of the  
rth. U R the  of  
the . A  On a  
  +    
hidden. But if the   
Lu + ziz its  + e + ness,  
how  it  ma +  
de  + e again ?

# A Wise Builder

People use many different things to build their houses. Jesus talked about how to build wisely or foolishly. Choose the right materials to solve the code that tells you who is a wise builder. Read Matthew 7:24-29 to find out more.

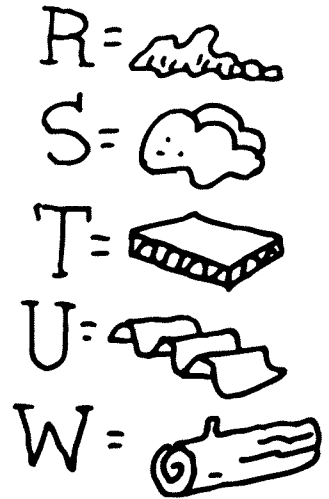
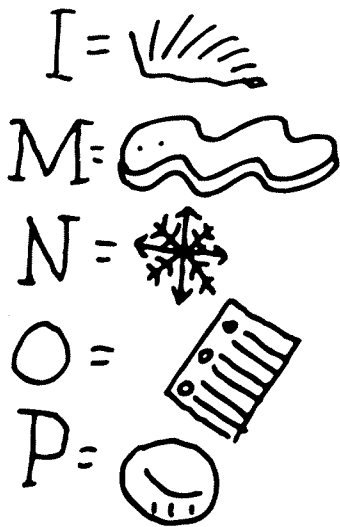
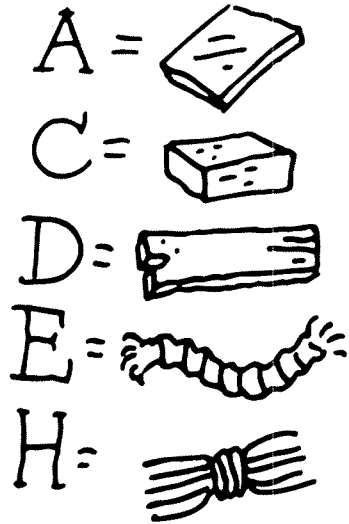

A wise builder is one who . . .

“

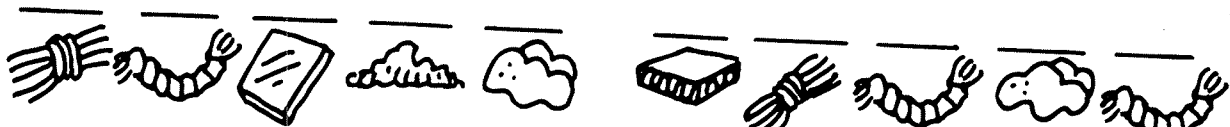

# THE SERMON ON THE MOUNT

## LUKE 6:20-45

### Across

1. Do not judge, and you \_\_\_\_\_ not be judged. v. 37
6. If someone takes your cloak, do not stop him from taking your \_\_\_\_\_ v. 29
8. Blessed are you \_\_\_\_\_, for yours is the kingdom of God. v. 20
9. A student is not above his \_\_\_\_\_ v. 40
12. For with the \_\_\_\_\_ you use, it will be measured to you. v. 38
14. And from him who takes away your \_\_\_\_\_ do not withhold your tunic as well. v. 29
15. \_\_\_\_\_ not and you will not be judged. v. 37

### Down

2. Blessed are you that \_\_\_\_\_ now, for you shall laugh. v. 21
3. Blessed are you when men \_\_\_\_\_ you. v. 22
4. Blessed are you that \_\_\_\_\_ now, for you shall be satisfied. v. 21
5. If you love those who love you, what \_\_\_\_\_ is that to you? v. 32
7. \_\_\_\_\_ your enemies. v. 27
10. Bless those who \_\_\_\_\_ you. v. 28
11. Your \_\_\_\_\_ will be great. v. 35
13. But woe to you who are \_\_\_\_\_. v. 24

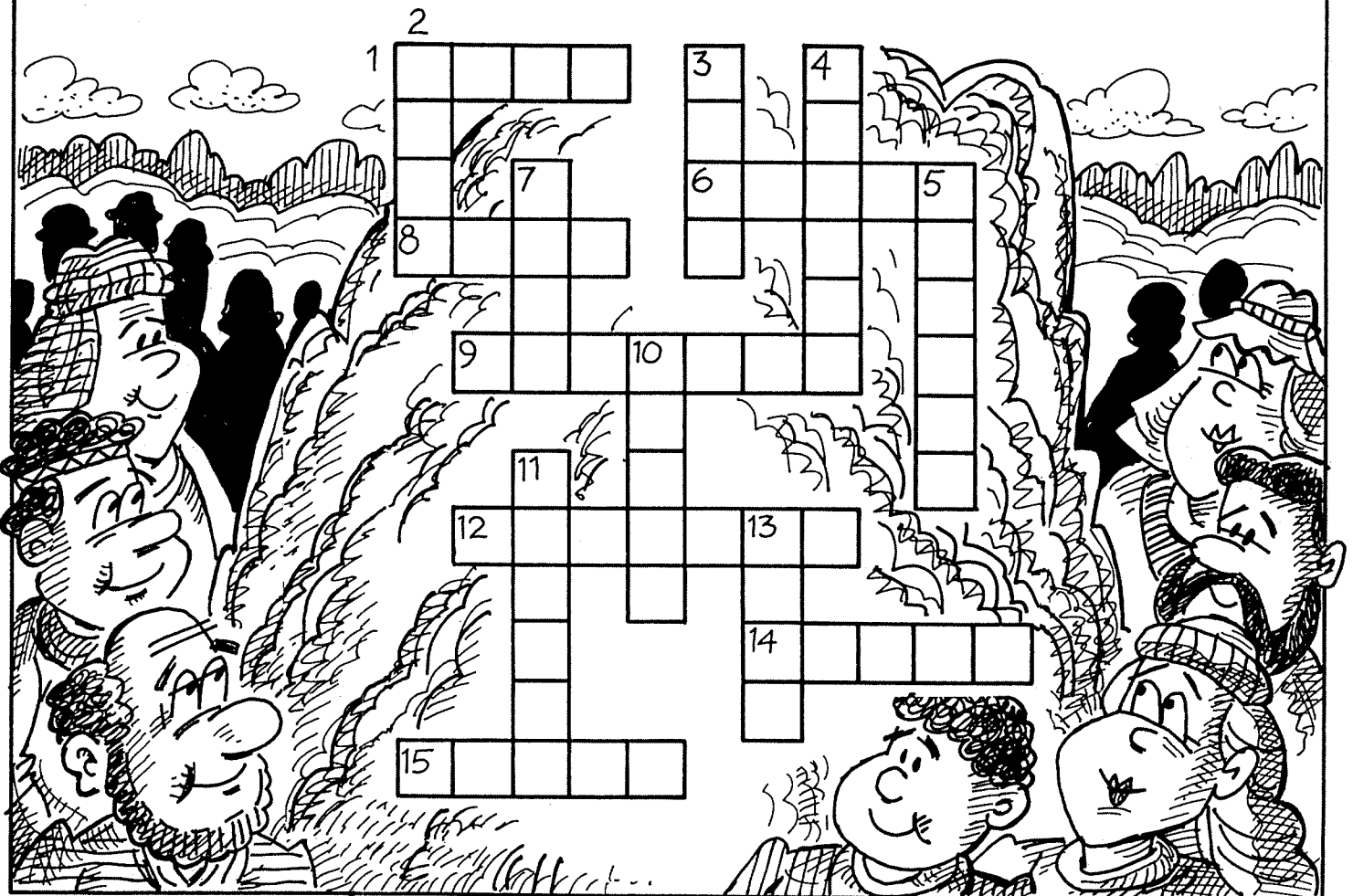

WORD SEARCH PUZZLE

MATTHEW 5:1-12 TELLS US THAT JESUS SAW THE CROWDS AND WENT TO SIT ON A MOUNTAIN-SIDE. HIS DISCIPLES CAME TO HIM AND HE BEGAN TO TEACH THEM, GIVING THEM THE BEATITUDES. FIND AND CIRCLE THE BOLD WORDS IN THIS PUZZLE. THEY MAY BE SPELLED IN A FORWARD, BACKWARD, VERTICAL, HORIZONTAL, OR DIAGONAL WAY.

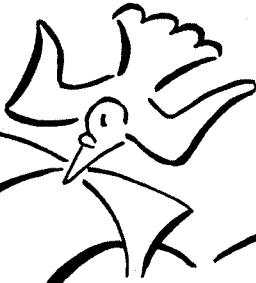

The Beatitudes



- Vs. 3. BLESSED ARE THE **POOR IN SPIRIT**, FOR THEIRS IS THE KINGDOM OF HEAVEN.
- Vs. 4. BLESSED ARE THOSE WHO **MOURN**, FOR THEY WILL BE COMFORTED.
- Vs. 5. BLESSED ARE THE **MEEK**, FOR THEY WILL INHERIT THE EARTH.
- Vs. 6. BLESSED ARE THOSE WHO **HUNGER AND THIRST** FOR RIGHTEOUSNESS, FOR THEY WILL BE FILLED.
- Vs. 7. BLESSED ARE THE **MERCIFUL**, FOR THEY WILL BE SHOWN MERCY.
- Vs. 8. BLESSED ARE THE **PURE IN HEART**, FOR THEY WILL SEE GOD.
- Vs. 9. BLESSED ARE THE **PEACEMAKERS**, FOR THEY WILL BE CALLED SONS OF GOD.
- Vs. 10. BLESSED ARE THOSE WHO ARE PERSECUTED BECAUSE OF RIGHTEOUSNESS, FOR THEIRS IS THE **KINGDOM** OF HEAVEN.
- Vs. 11. BLESSED ARE YOU WHEN PEOPLE INSULT YOU, PERSECUTE YOU AND FALSELY SAY ALL KINDS OF **EVIL** AGAINST YOU BECAUSE OF ME.
- Vs. 12. REJOICE AND BE GLAD, BECAUSE GREAT IS YOUR REWARD IN **HEAVEN**, FOR IN THE SAME WAY THEY PERSECUTED THE PROPHETS WHO WERE BEFORE YOU.

L T I R I P S  
 U N S P I C T R  
 F E M O S E  
 I V O O N R K  
 C A D R R I A  
 R E G N U H M  
 E H N L O T K E  
 M P A K I V E A  
 E R R E T D E  
 R T M E R U D

AFTER YOU HAVE CIRCLED THE HIDDEN WORDS, USE THE REMAINING LETTERS TO SPELL A WORD FROM VERSE 12.

\_\_\_\_\_



# R·E·B·U·S

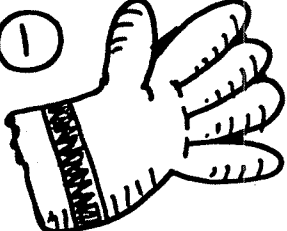

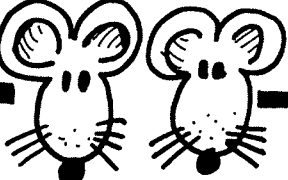
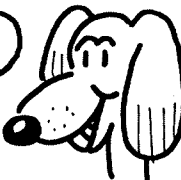
## A MESSAGE FROM JESUS

①  - G    ② Y + 4 - F

③ E + 1 - 0 +  - G + S    ④  - G

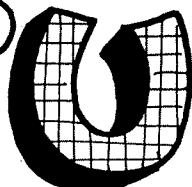
⑤  - LBE + OD    ⑥ 2    ⑦ T + 

⑧ W +  - SE    ⑨ CU +  - HO    ⑩ 

⑪ P +  - ke + Y    ⑫ 4    ⑬ T +  - U

⑭  - IP + O    ⑮  - SLE + S +  - E +  - C

⑯ U    • LUKE 6: 27, 28 NIV



## **Year 3**

### **Week 126**

#### **Jesus Heals and Forgives**

**Scriptures:** Luke 7:1-17, Luke 7:36-50, Matt 26:6-13

**Key Verse:** Luke 7:50 “And he said to the woman, ‘Your faith has saved you, go in peace.’”

#### **Key Points:**

1. Jesus came to Capernaum. There was a certain centurion who had a servant who was sick and about to die. The centurion sent elders to Jesus to ask Him if He could heal his servant. The centurion felt unworthy for Jesus to come into his home and asked that Jesus just speak the words to save his servant. Jesus was amazed at the faith of this centurion. When those who were sent returned home, they found the servant healed.
2. Jesus went to the city of Nain. A large crowd was with him as well as his disciples. When he came close to the city, a man was being carried out in a coffin, his mother weeping beside him. He was her only son. Jesus had compassion on her and told her not to weep. Jesus touched the open coffin and told the dead man to rise up. He did and started speaking. Fear came upon those who witnessed and they glorified God. News of this quickly went throughout the region.
3. Jesus ate with the Pharisees. As He ate, a sinful woman came to Jesus weeping, anointing his feet with fragrant oil. She then wiped His feet with her own hair. The Pharisees and Jesus’ disciples acted as though Jesus should have pushed the woman away. Yet, Jesus recognized her repentance and sorrow. He forgave her sins.

# 189. THE HEALING OF THE CENTURION'S SERVANT

(LUKE 7:1-10)



"And a certain centurion's servant, who was dear unto him, was sick, and ready to die. And when he heard of Jesus, he sent unto him the elder of the Jews, beseeching him that he would come and heal his servant."  
LUKE 7:2-3

# THE HEALING OF THE CENTURION'S SERVANT (LUKE 7:1-10)

## MEMORY VERSE:

"Humble yourselves in the sight of the Lord, and He will lift you up." JAMES 4:10

## TRUE OR FALSE:

1. "And a certain centurion's servant, who was dear to him, was sick and ready to die." LUKE 7:2  
TRUE OR FALSE

## CIRCLE THE CORRECT WORDS:

2. "So when he heard about Jesus, he sent (CHILDREN, ELDERS) of the Jews to Him, pleading with Him to come and (HEAL, RELEASE) his servant." LUKE 7:3
3. "And when they came to Jesus, they begged Him earnestly, saying that the one for whom He should do this was (DIRTY, WORTHY), 'for he (LOVES, HATES) our nation, and has built us a synagogue.'" LUKE 7:4-5

## TRUE OR FALSE:

4. But Jesus did not go with them... LUKE 7:6  
TRUE OR FALSE
5. "...the centurion sent friends to Him, saying to Him, 'Lord, do not trouble Yourself, for I am not worthy that You should enter under my roof.'" LUKE 7:6  
TRUE OR FALSE
6. "Therefore I did not even think myself worthy to come to You. But say the word, and my servant will be healed." LUKE 7:7  
TRUE OR FALSE

## MATCHING-DRAW A LINE :

7. "For I also am a man placed under authority, having soldiers under me. And..." LUKE 7:8  
CONNECT THE CENTURION'S ORDER TO THE SOLDIER'S RESPONSE.
- |                              |                |
|------------------------------|----------------|
| I SAY TO ONE 'GO'            | AND HE DOES IT |
| AND TO ANOTHER 'COME'        | AND HE GOES    |
| AND TO MY SERVANT, 'DO THIS' | AND HE COMES   |

## UNDERLINE THE CORRECT ANSWER:

8. "When Jesus heard these things, He marveled at him, and turned around and said to the crowd that followed Him..." LUKE 7:9
- a. 'I say to you, I have not found such great faith, not even in Israel!'
- b. 'I cannot enter the house of a centurion!'

## TRUE OR FALSE:

9. "And those who were sent, returning to the house, found the servant well who had been sick." LUKE 7:10  
TRUE OR FALSE

# THE HEALING OF THE CENTURION'S SERVANT (LUKE 7:1-10)

## MEMORY VERSE:

"Humble yourselves in the sight of the Lord, and He will lift you up." JAMES 4:10

## TRUE OR FALSE:

1. "And a certain centurion's servant, who was dear to him, was sick and ready to die." LUKE 7:2  
TRUE OR FALSE

## FILL IN THE BLANKS:

2. "So when he heard about Jesus, he sent \_\_\_\_\_ of the Jews to Him, pleading with Him to come and \_\_\_\_\_ his servant." LUKE 7:3
3. "And when they came to Jesus, they begged Him earnestly, saying that the one for whom He should do this was \_\_\_\_\_, 'for he \_\_\_\_\_ our nation, and has built us a synagogue.'" LUKE 7:4-5

## TRUE OR FALSE:

4. But Jesus did not go with them... LUKE 7:6  
TRUE OR FALSE
5. "...the centurion sent friends to Him, saying to Him, 'Lord, do not trouble Yourself, for I am not worthy that You should enter under my roof.'" LUKE 7:6  
TRUE OR FALSE
6. "Therefore I did not even think myself worthy to come to You. But say the word, and my servant will be healed." LUKE 7:7  
TRUE OR FALSE

## MATCHING-DRAW A LINE :

7. "For I also am a man placed under authority, having soldiers under me. And..." LUKE 7:8  
CONNECT THE CENTURION'S ORDER TO THE SOLDIER'S RESPONSE.
- |                              |                |
|------------------------------|----------------|
| I SAY TO ONE 'GO'            | AND HE DOES IT |
| AND TO ANOTHER 'COME'        | AND HE GOES    |
| AND TO MY SERVANT, 'DO THIS' | AND HE COMES   |

## UNDERLINE THE CORRECT ANSWER:

8. "When Jesus heard these things, He marveled at him, and turned around and said to the crowd that followed Him..." LUKE 7:9
- a. 'I say to you, I have not found such great faith, not even in Israel!'
- b. 'I cannot enter the house of a centurion!'

## FILL IN THE BLANKS:

9. "And those who were sent, returning to the house, found the servant \_\_\_\_\_ who had been \_\_\_\_\_." LUKE 7:10

# THE HEALING OF THE CENTURION'S SERVANT

## (LUKE 7:1-10)

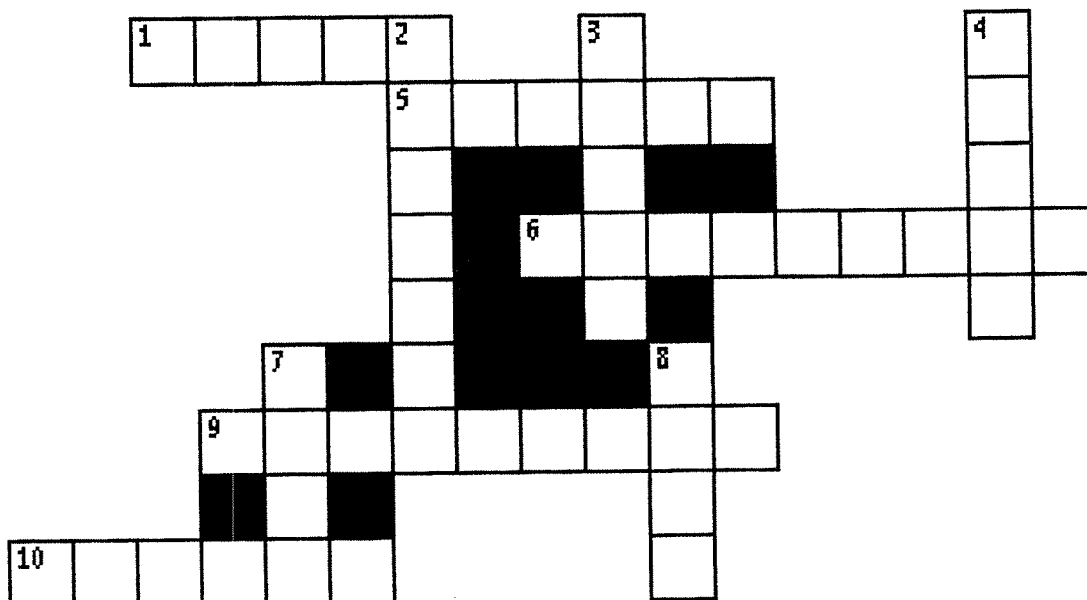

- 10 ACROSS " \_\_\_\_\_ yourselves in the sight of the Lord, and He will lift you up." **JAMES 4:10**
- 2 DOWN "And a certain centurion's \_\_\_\_\_, who was dear to him, was sick and ready to die." **LUKE 7:2**
- 5 ACROSS "So when he heard about Jesus, he sent \_\_\_\_\_ of the Jews to Him, pleading with Him to come and heal his servant." **LUKE 7:3**
- 1 ACROSS "And when they came to Jesus, they begged Him earnestly, saying that the one for whom He should do this was worthy, 'for he \_\_\_\_\_ our nation, and has built us a synagogue.'" **LUKE 7:4-5**
- 3 DOWN "Then \_\_\_\_\_ went with them..." **LUKE 7:6**
- 9 ACROSS "...the \_\_\_\_\_ sent friends to Him, saying to Him, 'Lord, do not trouble Yourself, for I am not worthy that You should enter under my roof.'" **LUKE 7:6**
- 8 DOWN "Therefore I did not even think myself worthy to come to You. But say the \_\_\_\_\_, and my servant will be healed." **LUKE 7:7**
- 6 ACROSS "For I also am a man placed under \_\_\_\_\_, having soldiers under me. And I say to one 'Go,' and he goes, and to another 'Come,' and he comes; and to my servant, 'Do this,' and he does it." **LUKE 7:8**
- 4 DOWN "When Jesus heard these things, He marveled at him, and turned around and said to the crowd that followed Him, 'I say to you, I have not found such great \_\_\_\_\_, not even in Israel!'" **LUKE 7:9**
- 7 DOWN "And those who were sent, returning to the house, found the servant \_\_\_\_\_ who had been sick." **LUKE 7:10**

# THE HEALING OF THE CENTURION'S SERVANT

## (LUKE 7:1-10)

S E L D E R S Y N H F E B U H  
 Y N L K D L O O J P S H K O E  
 N G M B L B I J T U S Q S T A  
 A Z D R O W T F O J F B U N L  
 G J Y T I R O H T U A E H A C  
 O J E U S B E A P H I G P V H  
 G P S W V A J H L Q T G E R U  
 U N Z K S C L M J O H E V E E  
 E M U A N R E P A C W D A S C  
 R U R C R W K A C R U O J E N  
 C O Y H T R O W V A V E R P Q  
 G K C I S J P H T W S E L T L  
 C E N T U R I O N U M E L C K  
 R F P U C U Z Z S V S W W E D  
 G L G M M K Y Y W M J E J S D

AUTHORITY  
 BEGGED  
 CAPERNAUM  
 CENTURION  
 ELDERS  
 FAITH

HEAL  
 HOUSE  
 JESUS  
 JEWS  
 MARVELED

SERVANT  
 SICK  
 SYNAGOGUE  
 WORD  
 WORTHY

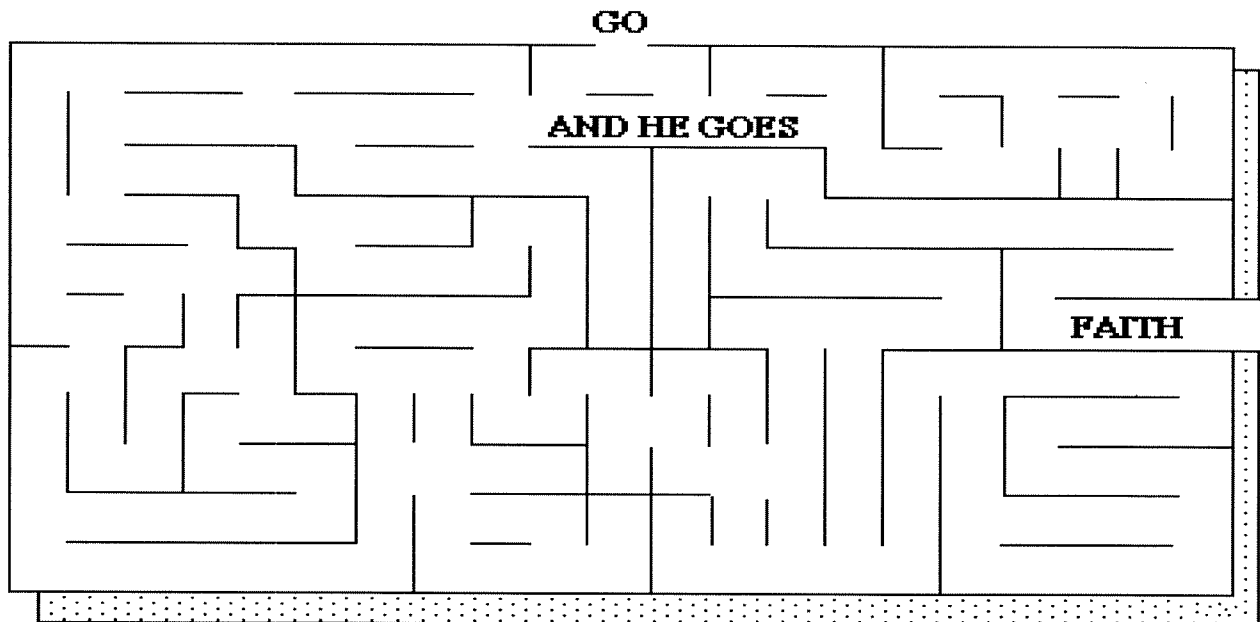



Jesus Raises a Young Man to Life

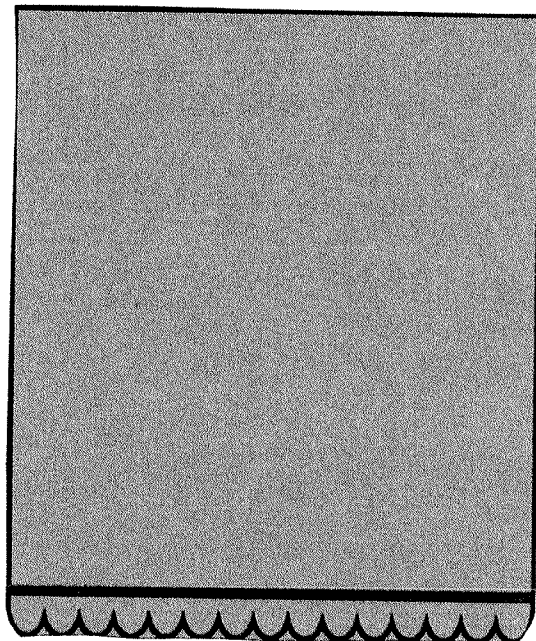
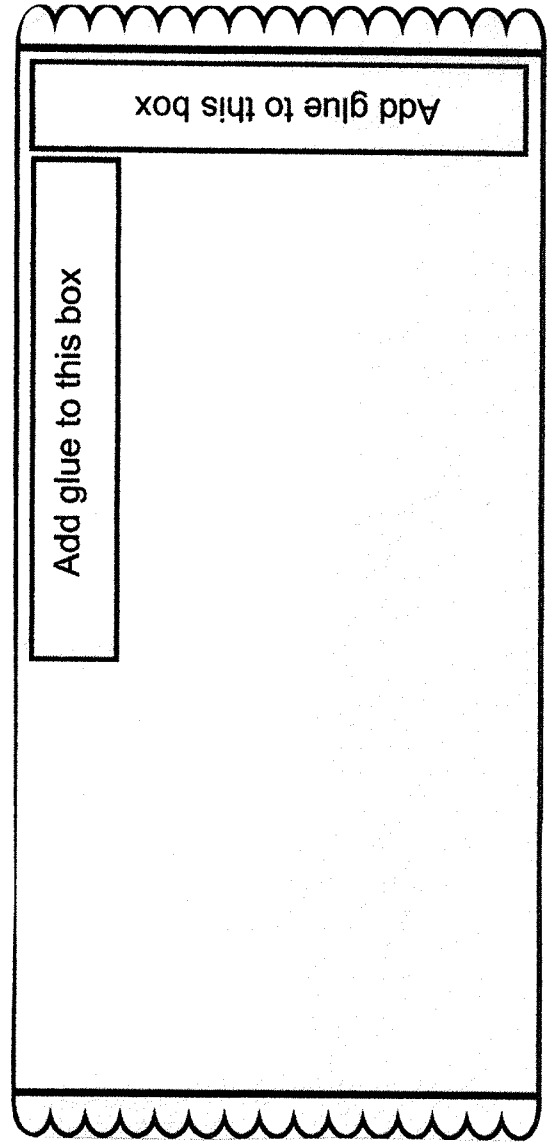
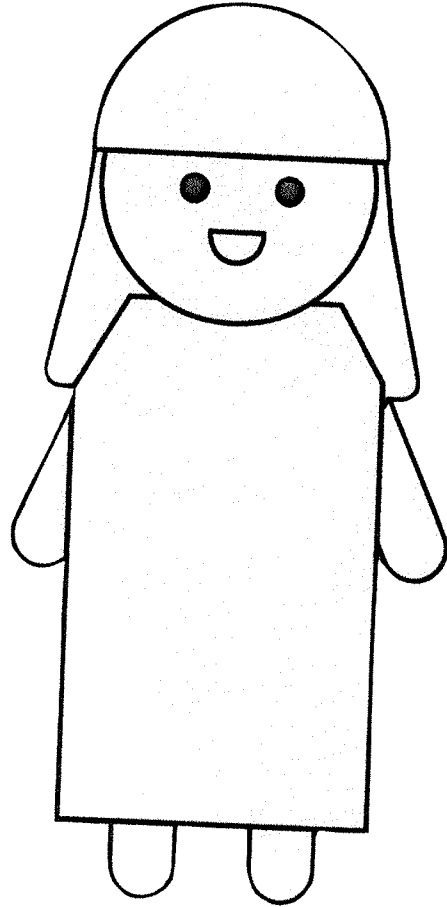



# THE SON OF THE WIDOW OF NAIN

## (LUKE 7:11-17)

### MEMORY VERSE:

*"Then fear came upon all, and they glorified God, saying, 'A great prophet has risen up among us'; and, 'God has visited His people.'" LUKE 7:16*

### FILL IN THE BLANKS:

1. "He went into a city called \_\_\_\_\_; and many of His disciples went with Him, and a large crowd." **LUKE 7:11**
2. "And when He came near the gate of the city, behold, a \_\_\_\_\_ man was being carried out, the only son of his mother; and she was a widow..." **LUKE 7:12**

### TRUE OR FALSE:

3. "When the Lord saw her, He had compassion on her and said to her, 'Do not weep.'" **LUKE 7:13**  
**TRUE OR FALSE**
4. But Jesus would not come near to them and walked away. **LUKE 7:14**  
**TRUE OR FALSE**

### FILL IN THE BLANKS:

5. "And he who was dead \_\_\_\_\_ and began to \_\_\_\_\_..." **LUKE 7:15**

### TRUE OR FALSE:

6. "...And He presented him to his mother." **LUKE 7:15**  
**TRUE OR FALSE**

### UNDERLINE THE CORRECT ANSWER:

7. "Then fear came upon all, and they glorified God, saying..." **LUKE 7:16**
  - a. 'A great prophet has risen up among us'
  - b. 'God has visited His people'
  - c. all of the above

### FILL IN THE BLANK:

8. "And this report about Him went throughout all \_\_\_\_\_ and all the surrounding region."  
**LUKE 7:17**

# THE SON OF THE WIDOW NAIN

(LUKE 7:11-17)

I	A	E	D	U	J	S	K	T	I	A	M	V	G	U
V	V	B	O	F	O	W	E	A	W	Y	A	O	E	F
V	Q	I	V	N	G	Z	F	R	D	I	Z	J	U	I
B	N	A	I	N	D	K	J	I	Q	W	D	J	W	B
Q	T	R	E	H	T	O	M	S	D	Y	O	O	D	G
Y	A	A	Q	H	E	K	A	E	J	D	S	R	W	Y
T	Q	M	Z	A	P	T	T	I	Q	E	H	E	C	P
O	F	M	U	W	Z	Q	E	O	R	A	M	A	W	Y
U	S	E	L	P	I	C	S	I	D	D	S	W	Y	B
C	H	T	A	B	C	J	J	T	I	O	U	L	P	D
H	P	Y	N	P	K	B	Z	A	L	F	S	Z	Z	R
E	J	L	M	E	C	A	Z	N	S	V	E	F	W	C
C	O	F	F	I	N	B	E	R	T	M	J	P	B	G
L	T	I	G	S	Q	R	K	P	F	S	M	J	M	R
N	P	E	E	W	I	B	C	P	S	V	S	H	W	G

ARISE  
COFFIN  
CROWD  
DEAD  
DISCIPLES

JESUS  
JUDEA  
MOTHER  
NAIN  
SAT

SON  
SPEAK  
TOUCH  
WEEP  
WIDOW

← ENTER THE CITY GATE HERE

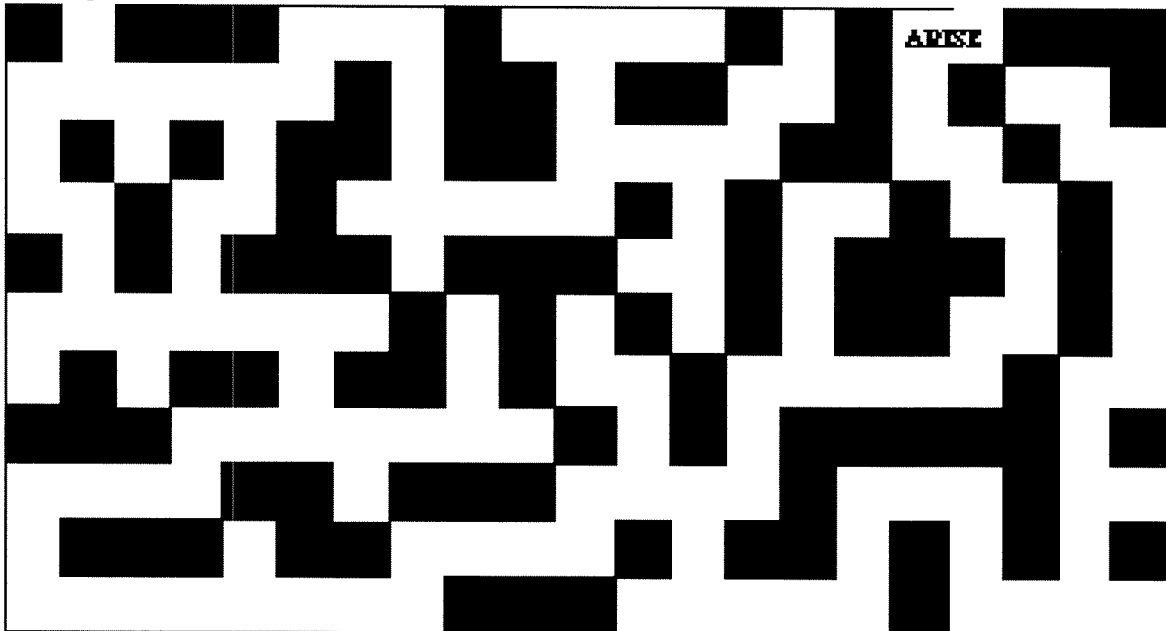

# ANOINTING JESUS' FEET

(LUKE 7:36-50)

## MEMORY VERSE:

*"We love Him because He first loved us."* 1 JOHN 4:19

## FILL IN THE BLANKS:

1. "Then one of the \_\_\_\_\_ asked Him to eat with him..." **LUKE 7:36**
2. "And behold, a woman in the city who was a sinner, when she knew that Jesus sat at the table in the Pharisee's house, brought an alabaster flask of fragrant \_\_\_\_\_." **LUKE 7:37**

## TRUE OR FALSE:

3. "...and stood at His feet behind Him weeping; and she began to wash His feet with her tears, and wiped them with the hair of her head; and she kissed His feet and anointed them with the fragrant oil." **LUKE 7:38**

**TRUE OR FALSE**

## FILL IN THE BLANKS:

4. "Now when the Pharisee who had invited Him saw this, he spoke to himself, saying, 'This man, if He were a prophet, would know who and what manner of woman this is who is touching Him, for she is a \_\_\_\_\_.'" **LUKE 7:39**
5. "Then He turned to the woman and said to Simon, 'Do you see this woman? I entered your house; you gave Me no water for My feet, but she has washed My feet with her \_\_\_\_\_ and wiped them with the hair of her head.'" **LUKE 7:44**
6. "You gave Me no kiss, but this woman has not ceased to kiss My \_\_\_\_\_ since the time I came in." **LUKE 7:45**
7. "You did not anoint My head with oil, but this woman has anointed My feet with \_\_\_\_\_ oil." **LUKE 7:46**

## TRUE OR FALSE:

8. "Therefore I say to you, her sins, which are many, are forgiven, for she loved much..." **LUKE 7:47**

**TRUE OR FALSE**

9. "Then He said to the woman, 'Your faith has saved you. Go in peace.'" **LUKE 7:50**

**TRUE OR FALSE**

## **Year 3**

### **Week 127**

#### **Jesus Teaches in Parables/Parable of the Sower**

**Scriptures:** Mark 4:1-20, Luke 8:1-18

**Key Verse:** Luke 8:15 “But the ones that fell on the good ground are those who, having heard the word with a noble and good heart, keep it and bear fruit with patience.”

#### **Key Points:**

1. A great crowd had gathered from every city. He spoke to them in a parable.
2. A farmer went out to plant seed by broadcasting it. Some seed fell where the birds could easily eat it. Some seed fell on rocks and sprouted only to die. Some seed started to grow, but thorns choked it out. Some seed did land on good soil and grew to produce a good crop.
3. The disciples asked him what the parable meant. Jesus explained the parable. The seed is God’s word. Those by the wayside are those who believe but the devil takes the word out of their heart lest they be saved. The ones on the rock are those who hear but have no root and fall away. Those in the tares consumed by the cares of the world and bear no fruit. Those who are the good soil are those who hear with a good and noble heart and bear good fruit with patience and maturity.



Jesus told the parable of a sower who went out to sow his seed.  
**LUKE 8:4-18**

"A farmer went out to sow his seed. As he was scattering the seed...



Some fell along the path and the birds came and ate it up...

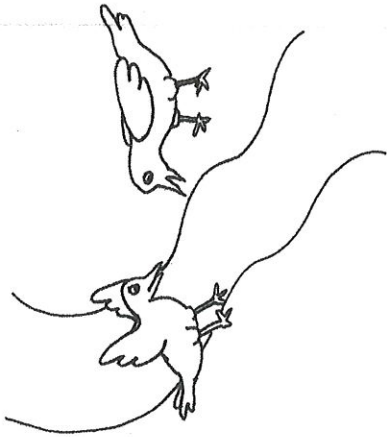

Some fell on rocky places, where it did not have much soil...

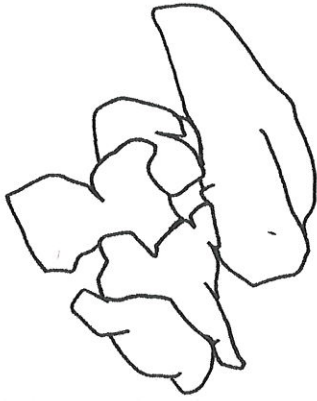

Other seeds fell among thorns which grew up and choked the plants

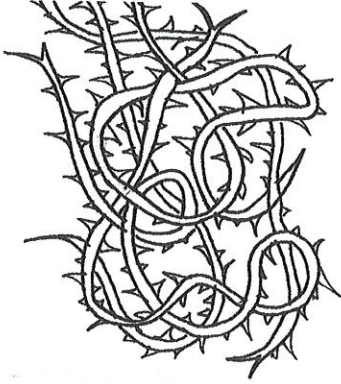

— a hundred, sixty or thirty times what was sown."

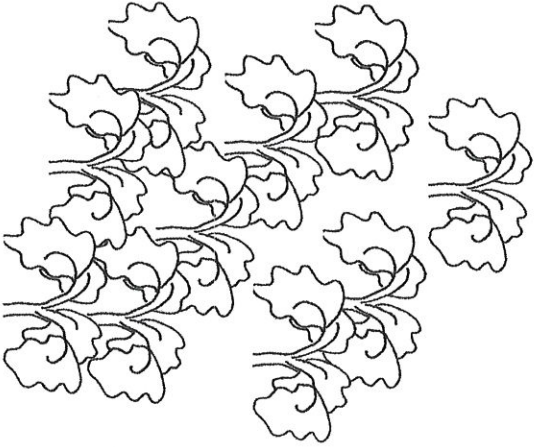

Still other seed fell on good soil, where it produced a good crop

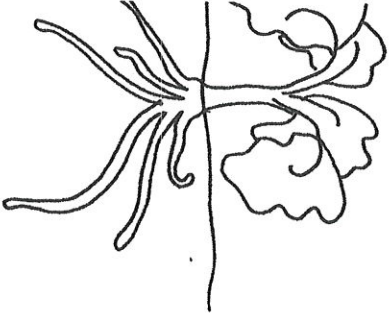

## The Parable of the Sower

Matthew 13:3b-9

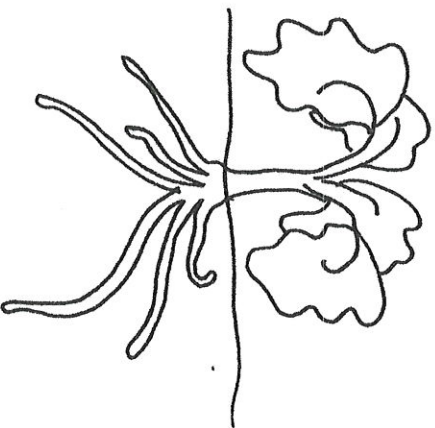



In the parable of the sower, which creature ate the seeds?



# PARABLE OF THE SOWER

(LUKE 8:4-18)

## MEMORY VERSE:

*"Therefore take heed how you hear. For whoever has, to him more will be given; and whoever does not have, even what he seems to have will be taken from him." LUKE 8:18*

*"A sower went out to sow his seed. And as he sowed..." LUKE 8:5*

## CIRCLE THE CORRECT WORDS:

1. "...some fell by the (**SEASHORE, WAYSIDE**); and it was trampled down, and the birds of the air devoured it." LUKE 8:5
2. "Some fell on (**ROCK, GRASS**); and as soon as it sprang up, it withered away because it lacked moisture." LUKE 8:6
3. "And some fell among (**BUSHES, THORNS**), and the (**THORNS, BUSHES**) sprang up with it and choked it." LUKE 8:7
4. "But others fell on (**GOOD, BAD**) ground, sprang up, and yielded a crop a hundredfold..." LUKE 8:8

*"Then His disciples asked Him, saying, 'What does this parable mean?'" LUKE 8:9*

## CIRCLE TRUE OR FALSE:

- |    |          |                                                                |      |       |
|----|----------|----------------------------------------------------------------|------|-------|
| 5. | Verse 11 | The seed is the Word of God.                                   | TRUE | FALSE |
|    | Verse 12 | Those by the wayside have never heard the Word of God.         | TRUE | FALSE |
|    | Verse 13 | The ones on the rock receive the Word with joy, but fall away. | TRUE | FALSE |
|    | Verse 14 | The ones who fell among thorns bear great fruit.               | TRUE | FALSE |
|    | Verse 15 | The ones who fell on good ground bear fruit with patience.     | TRUE | FALSE |



# PARABLE OF THE SOWER

(LUKE 8:4-18)

**MEMORY VERSE:**

*"Therefore take heed how you hear. For whoever has, to him more will be given; and whoever does not have, even what he seems to have will be taken from him." LUKE 8:18*

*"A sower went out to sow his seed. And as he sowed..." LUKE 8:5*

**FILL IN THE BLANKS:**

1. "...some fell by the \_\_\_\_\_; and it was trampled down, and the birds of the air devoured it." **LUKE 8:5**
2. "Some fell on \_\_\_\_\_; and as soon as it sprang up, it withered away because it lacked moisture." **LUKE 8:6**
3. "And some fell among \_\_\_\_\_, and the \_\_\_\_\_ sprang up with it and choked it." **LUKE 8:7**
4. "But others fell on \_\_\_\_\_ ground, sprang up, and yielded a crop a hundredfold..." **LUKE 8:8**

*"Then His disciples asked Him, saying, 'What does this parable mean?'" LUKE 8:9*

**CIRCLE TRUE OR FALSE:**

- |             |                                                                |             |              |
|-------------|----------------------------------------------------------------|-------------|--------------|
| 5. Verse 11 | The seed is the Word of God.                                   | <b>TRUE</b> | <b>FALSE</b> |
| Verse 12    | Those by the wayside have never heard the Word of God.         | <b>TRUE</b> | <b>FALSE</b> |
| Verse 13    | The ones on the rock receive the Word with joy, but fall away. | <b>TRUE</b> | <b>FALSE</b> |
| Verse 14    | The ones who fell among thorns bear great fruit.               | <b>TRUE</b> | <b>FALSE</b> |
| Verse 15    | The ones who fell on good ground bear fruit with patience.     | <b>TRUE</b> | <b>FALSE</b> |

# The Sower and the Seed

Jesus told many stories about familiar things to help people understand Jesus' messages about God. One of the stories Jesus told was about a farmer who planted seeds. Some of the seed fell on ground the farmer had prepared, but some of the seed fell on rocky places. After Jesus finished telling the story, His disciples wanted to know what it meant.

What Jesus might tell His disciples if He were talking to them today is written below. Use the code to fill in the blanks. When you have completed the puzzle, read what Jesus told His disciples in Matthew 13: 18-23.

Code:													
A	B	C	D	E	F	G	H	I	J	K	L	M	N
△△	○○	□	△	○	□□	△△△	●	○○○	●●	xx	x	xxx	■
O	P	Q	R	S	T	U	V	W	X	Y	Z		
■■	■■■	▲	▲▲	▲▲▲	□	□□	□□□	≡	≡≡	≡≡≡	●●●		

Here is the explanation of the story I told about the farmer planting grain:

The hard ■■■-△△-□-● where some of the seeds fell represents the ●-○-△△-▲▲-□ of a person who hears the △△△-■■-■■-△ about the ■-○-□-▲▲▲ of God and doesn't understand it; then XX-○○○-■-△△△-△-■■-xxx comes and snatches away the seeds from the person's ▲▲▲-△△-□-△△-■

●-○-△△-▲▲-□  
The shallow, ▲▲-■■-□-xx-≡ soil represents the heart of a ■■■■-○-▲▲-▲▲-■■-■ who ●-○-△△-▲▲-▲▲ the message and receives it with real ●●-■■-≡, but he or she doesn't have much depth in his or her x-○○○-□□-○, and the seeds don't ▲▲-■■-■■-□ very deeply. After a while when □-▲▲-■■-□□-○○-x-○ comes, or ■■■-○-▲▲-▲▲-○-□□-□□-○○-■■-■ begins because of his or her beliefs, his or her enthusiasm □□-△△-△-○-▲▲▲, and the person △-▲▲-■■-■■-■■-▲▲▲ out.

The ground covered with □-△△-▲▲-○-▲▲▲ represents a person who hears the message, but the □-△△-▲▲-○-▲▲▲ of this life and the longing for xxx-■■-■-○-≡ choke out God's Word, and the person does x-○-▲▲▲-▲▲▲ and less for God.

The △△△-■■-■■-△ ground represents the ●-○-△△-▲▲-□ of a person who listens to the message and □□-■-△-○-▲▲-▲▲-□-△△-■-△-▲▲▲ it and goes out and ○○-▲▲-○○○-■-△△△-▲▲▲ thirty, ▲▲▲-○○○-≡-□-≡, or even a ●-□□-■-△-▲▲-○-△ others into the Kingdom.



# Sowing Seeds

Luke 8:4-15 (NIV)

Jesus often used word pictures to teach the people. These stories were called Parables. They were meant to illustrate some truth. The people did not always understand, but Jesus was happy to give an explanation to those who wanted to know more. A picture story often helps us to see the point being made and to remember it better. One such story is the parable of the Sower in Luke 8:4-15. Below you can see the story in a picture.

A Farmer went out to sow his seed ...

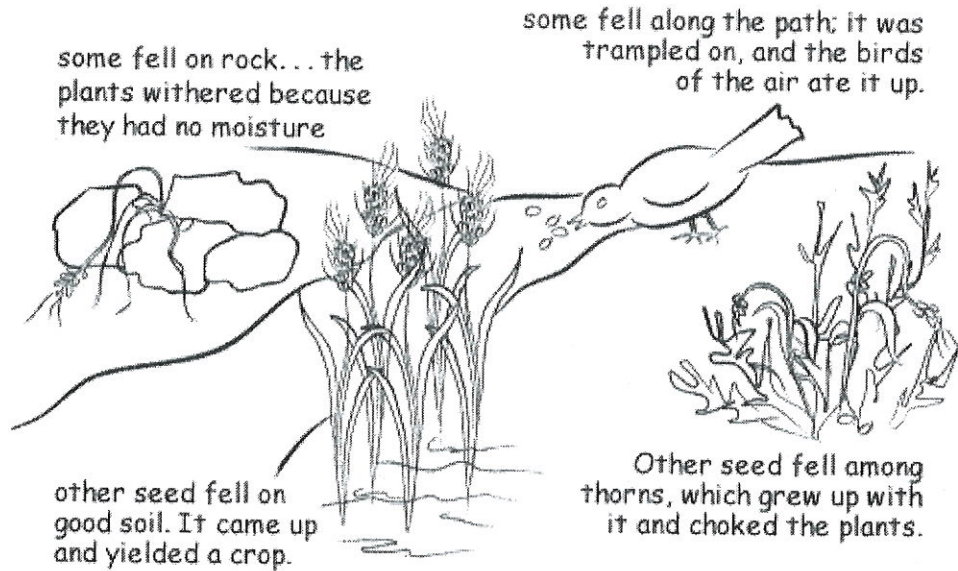

Read Luke 8:11-15 to see how Jesus explained this Parable and fill in the blanks below. Draw a line from the answer to the part of the picture that illustrates it.

The seed is the \_\_\_\_\_ of God. (vs.11)

<p>... the _____ comes and takes away the word from their hearts, so that they may not _____. (vs.12)</p>	<p>... believe for a while, but in time of _____ they fall away. (vs.13)</p>
<p>... hear, but as they go on their way they are _____ by life's worries, _____ and pleasures, and they do not mature. (vs.14)</p>	<p>... those with a noble and _____, who hear the _____, retain it, and by persevering produce a _____. (vs.15)</p>

Unscramble the letters to find the words in our

# Sower and the Seed Anagram



elnoss \_\_\_\_\_

hnorst \_\_\_\_\_

aeilnpx \_\_\_\_\_

aefmrr \_\_\_\_\_

adegnr \_\_\_\_\_

agilnpt \_\_\_\_\_

deess \_\_\_\_\_

deesw \_\_\_\_\_

ckors \_\_\_\_\_

gginorw \_\_\_\_\_



**Parable of  
the Sower  
Luke 8**

# Will It Grow?

.....  
Add the numbers in the box to  
get the code number for each  
letter. Then solve the puzzle.  
.....

Farmers plant seeds in all types of soils. Fertilizer is used in order to grow a good crop. But the question is still there—will it grow? Christians spread the Word of God to all types of listeners. What is necessary for the seed of faith to grow in each person's heart?

- A 17+34 = \_\_\_\_\_
- B 28+44 = \_\_\_\_\_
- C 39+57 = \_\_\_\_\_
- D 16+65 = \_\_\_\_\_
- E 62+37 = \_\_\_\_\_
- F 41+38 = \_\_\_\_\_
- G 24+33 = \_\_\_\_\_
- H 47+29 = \_\_\_\_\_
- I 24+58 = \_\_\_\_\_
- L 41+25 = \_\_\_\_\_
- N 23+15 = \_\_\_\_\_
- O 29+49 = \_\_\_\_\_
- P 22+11 = \_\_\_\_\_
- R 55+34 = \_\_\_\_\_
- S 29+16 = \_\_\_\_\_
- T 44+26 = \_\_\_\_\_
- U 13+14 = \_\_\_\_\_
- V 23+68 = \_\_\_\_\_
- W 23+19 = \_\_\_\_\_
- Y 36+25 = \_\_\_\_\_

72	27	70	70	76	99	45	99	99	81	78	38			
57	78	78	81	45	78	82	66	45	70	51	38	81	45	
79	78	89	70	76	78	45	99	42	82	70	76	51		
38	78	72	66	99	51	38	81	57	78	78	81			
76	99	51	89	70	42	76	78	76	99	51	89	70	76	99
42	78	89	81	89	99	70	51	82	38	82	70	51	38	81
72	61	33	99	89	45	99	91	99	89	82	38	57		
33	89	78	81	27	96	99	51	96	89	78	33			

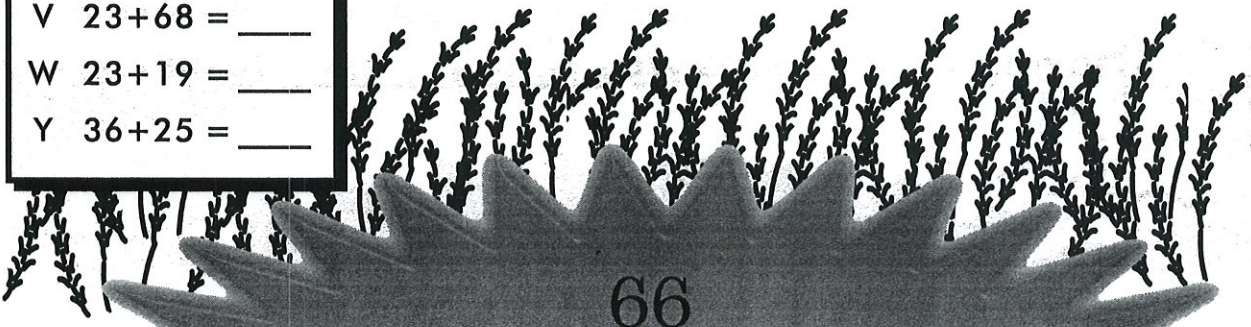



A farmer went out to sow  
his seed. As he  
was scattering  
the seed....





Some fell along  
the path, and the  
birds  
came and  
ate it up...

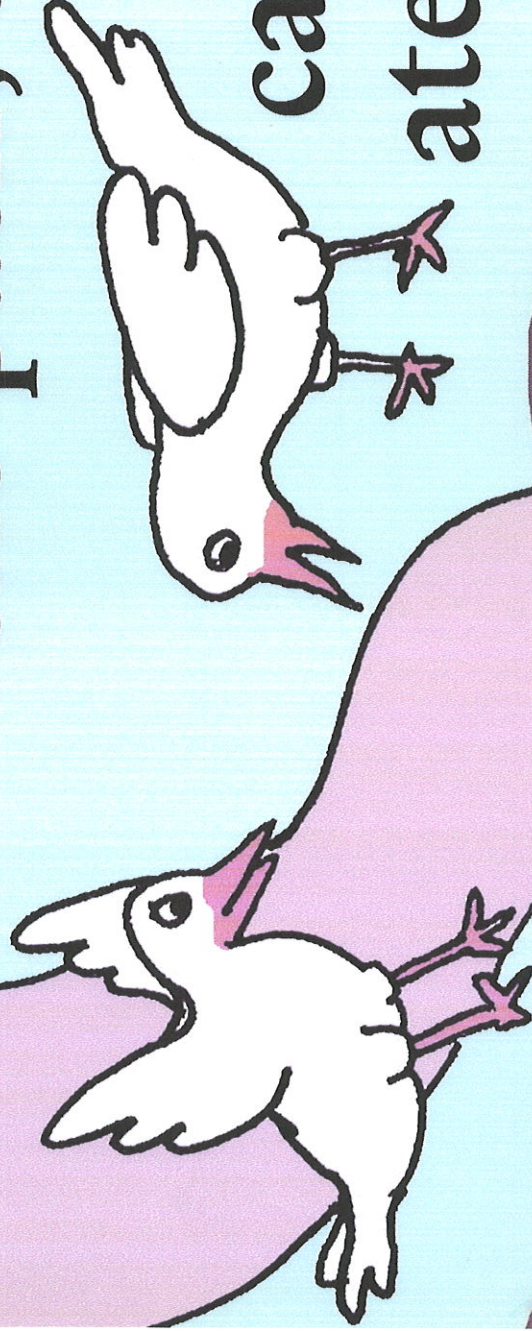



**Some fell on  
rocky places,  
where it did not  
have much  
soil...**

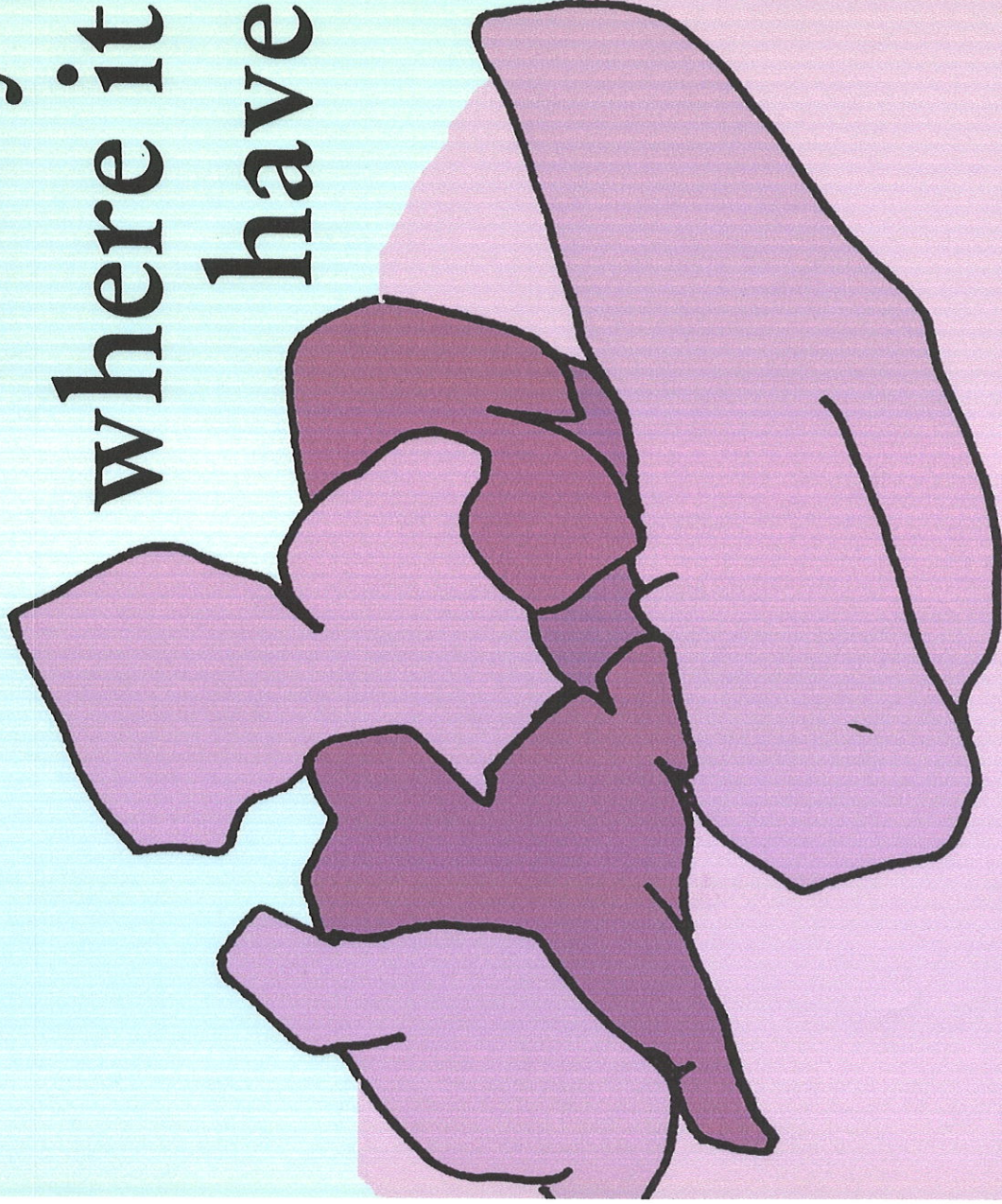



Other seed  
fell among  
thorns  
which  
grew up  
and  
choked  
the plants...





Still other seed fell on good soil, where it produced a crop



-a hundred, sixty  
or thirty times  
what was sown.



## **Year 3**

### **Week 128**

#### **Jesus Teaches about His Kingdom**

**Scriptures:** Matt 13:31-52

**Key Verse:** Matt 13:44 “Again, the kingdom of heaven is like treasure hidden in a field, which a man found and hid; and for joy over it he goes and sells all that he has and buys that field”.

#### **Key Points:**

1. Jesus spoke to them in more parables. He tries to teach about the coming of His church. He wanted so much for those who would see it come or those who live now to realize it was to be a growing, nurturing institution of great value. He compared it to a mustard seed. It grows from the tiniest of seeds but when it's full grown it is as big as a tree and birds can nest in its branches.
2. To illustrate His point further, He teaches that the church is like yeast, which has the ability to leaven a large amount of flour until the whole amount is leavened.
3. Jesus again tried to show the church's value by comparing it to a treasure hidden in a field. A man wanted that treasure badly enough to sell everything he owned so that he could look for the treasure in the field. Finally he compared His church to a merchant searching for beautiful pearls. When the merchant found just one pearl of great price he sold all he had to buy it. All these illustrations teach that the church is of great value and can affect a lot of people if sought after and nurtured.



"Jesus told His disciples a parable about wheat and tares."  
Matthew 13:24 – 30, 36 – 43



# Parables of Jesus

Each of these illustrations is related to one of the parables used by Jesus to teach his followers. Can you identify them? (Scripture clues are at the bottom of the page.)



1 \_\_\_\_\_



2 \_\_\_\_\_

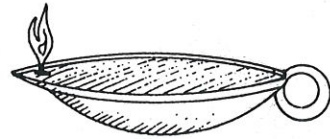

3 \_\_\_\_\_

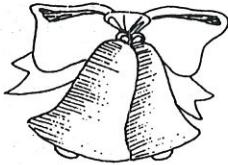

4 \_\_\_\_\_



5 \_\_\_\_\_

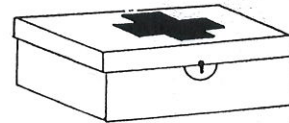

6 \_\_\_\_\_

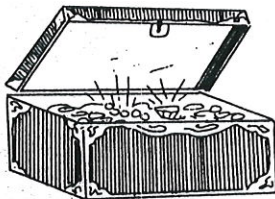

7 \_\_\_\_\_



8 \_\_\_\_\_



9 \_\_\_\_\_



10 \_\_\_\_\_



11 \_\_\_\_\_



12 \_\_\_\_\_

(Clues: 1. Matthew 13 2. Matthew 13 3. Matthew 25  
4. Matthew 22 5. Luke 15 6. Luke 10  
7. Matthew 13 8. Matthew 13 9. Matthew 13  
10. Matthew 13 11. Luke 15 12. Matthew 25)



# PARABLES OF THE TREASURE & THE PEARL

(MATTHEW 13:44-46)



“Again, the kingdom of heaven is like unto treasure hid in a field; the which when a man hath found, he hideth, and for joy thereof goeth and selleth all that he hath, and buyeth that field.”

**MATTHEW 13:44**



# Find the Treasure

Find the missing words of Matthew 13:44-46 hidden in and on the treasure chest. A number is included with each word. Place the word in the blank with the same number.

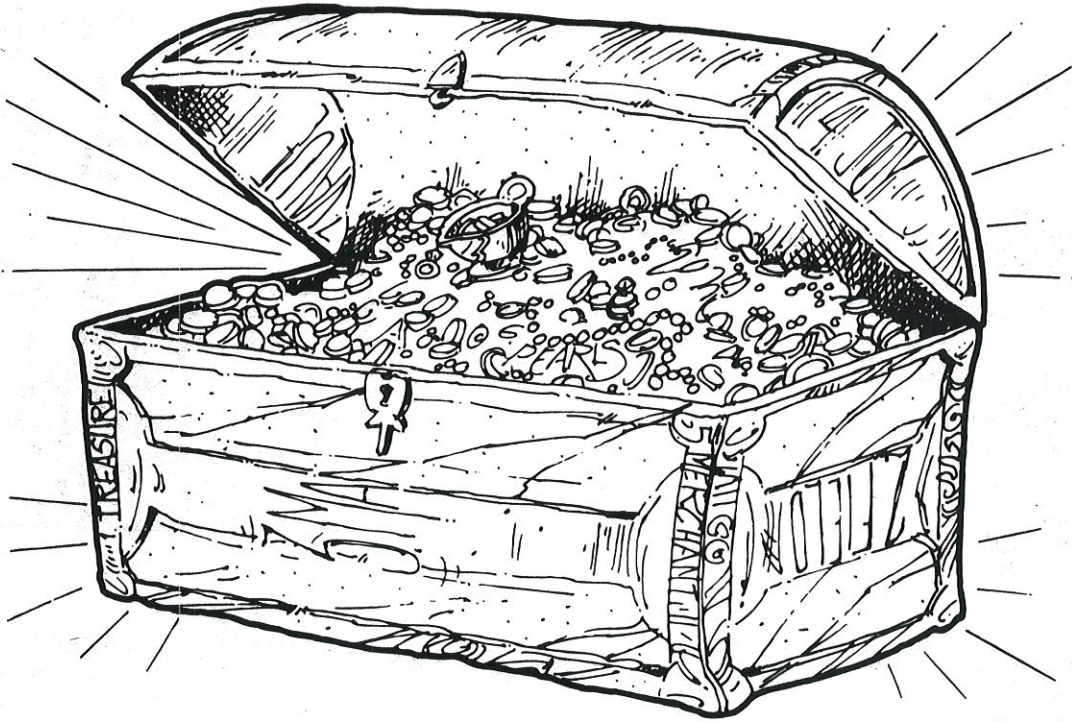

44 The kingdom of heaven is like a \_\_\_\_\_ hidden in a \_\_\_\_\_.

When a \_\_\_\_\_ found it, he hid it again, and then in his \_\_\_\_\_ went

and sold all he had and bought that \_\_\_\_\_.

45 Again, the kingdom of heaven is like a \_\_\_\_\_ looking for fine \_\_\_\_\_.

46 When he found one of great \_\_\_\_\_, he went away and sold everything he had

and bought it.





# PARABLES OF THE TREASURE & THE PEARL

## (MATTHEW 13:44-46)

### MEMORY VERSE:

*"For you were bought at a price; therefore glorify God in your body and in your spirit, which are God's." 1 CORINTHIANS 6:20*

### FILL IN THE BLANK:

1. "Again, the kingdom of heaven is like \_\_\_\_\_ hidden in a field..." **MATTHEW 13:44**

### TRUE OR FALSE:

2. "...which a man found and hid..." **MATTHEW 13:44**  
**TRUE OR FALSE**

### FILL IN THE BLANK:

3. "And for joy over it he goes and sells all that he has and \_\_\_\_\_ that field." **MATTHEW 13:44**

### UNDERLINE THE CORRECT ANSWER:

4. "Again, the kingdom of heaven is like a merchant seeking beautiful..." **MATTHEW 13:45**
- a. diamonds
  - b. rubies
  - c. pearls
  - d. wheat

### TRUE OR FALSE:

5. "...who when he had found one pearl of great price, went and sold all that he had and bought it." **MATTHEW 13:46**

**TRUE OR FALSE**

# PARABLES OF THE TREASURE & THE PEARL

## (MATTHEW 13:44-46)

Q J H B N Z Y J B B R M L B K  
 J V P E C I R P T A E R G I Z  
 Q O P Z E F S C B K K W N V N  
 H Q Y N E D D I H K D G L B W  
 V D R S B J Y V B B D L A L T  
 Z D B V P F D G U O F N R R I  
 F O U N D E Y W M D H A E H O  
 U D N M U O S O D O E A N C V  
 D V G O U E F I L P S S H O M  
 F V B N L H H H Y U L F G Y G  
 H D L L E R N S R F I Z N K D  
 G N S A R A Y E L E D R W E O  
 U F V G M U B H L B I O B O T  
 Q E L I B I O D H Q P J W J C  
 N S N C J P A R A B L E S S U

BUYS  
 FIELD  
 FOUND  
 GREAT PRICE  
 HIDDEN

HID  
 JOY  
 KINGDOM OF HEAVEN  
 MAN

PARABLES  
 PEARL  
 SELLS  
 TREASURE

*BEGIN SEEKING HERE*

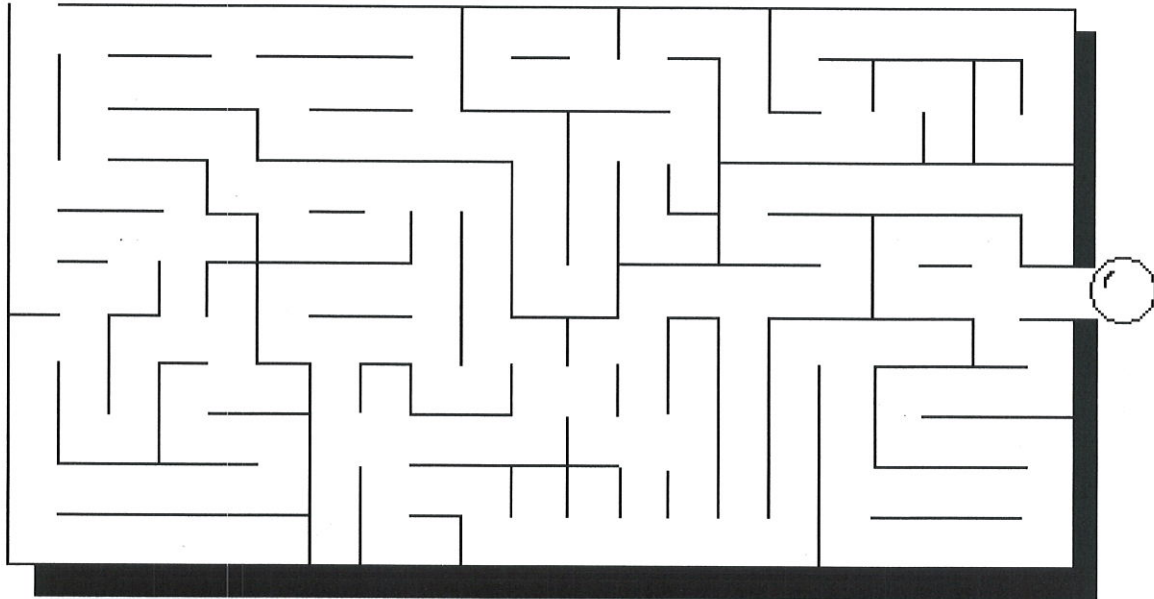



# PARABLE of the KINGDOM

WHAT DOES JESUS SAY ABOUT THE FAITHFUL? READ THE BIBLE VERSE MATTHEW 13:24-30 AND CROSS OUT ALL THE "WEEDS" BELOW FOR THE ANSWER.

WEEDSWHENWEEDSJESUS  
WEEDSCOMESWEEDSHEWE  
EDSWILLWEEDSGATHERW  
EEDSTHEWEEDSWHEAT(T  
HEFAITHFUL)WEEDSINT  
OWEEDSWEEDSHISWEEDS  
BARN(HEAVEN)WEEDS





# The Parables of Jesus

As Jesus traveled and helped people, He taught the people about God. Often Jesus told special stories to help His listeners understand important truths about God. These stories are called parables. Today, these stories and teachings still help us to understand Who God is and how we can please Him.

Jesus told several stories to help us understand God's kingdom. Unscramble the parables listed on the left and match them to the Scripture reference on the right. Then find and circle the parables in the puzzle. The first letter of each scrambled word is underlined.

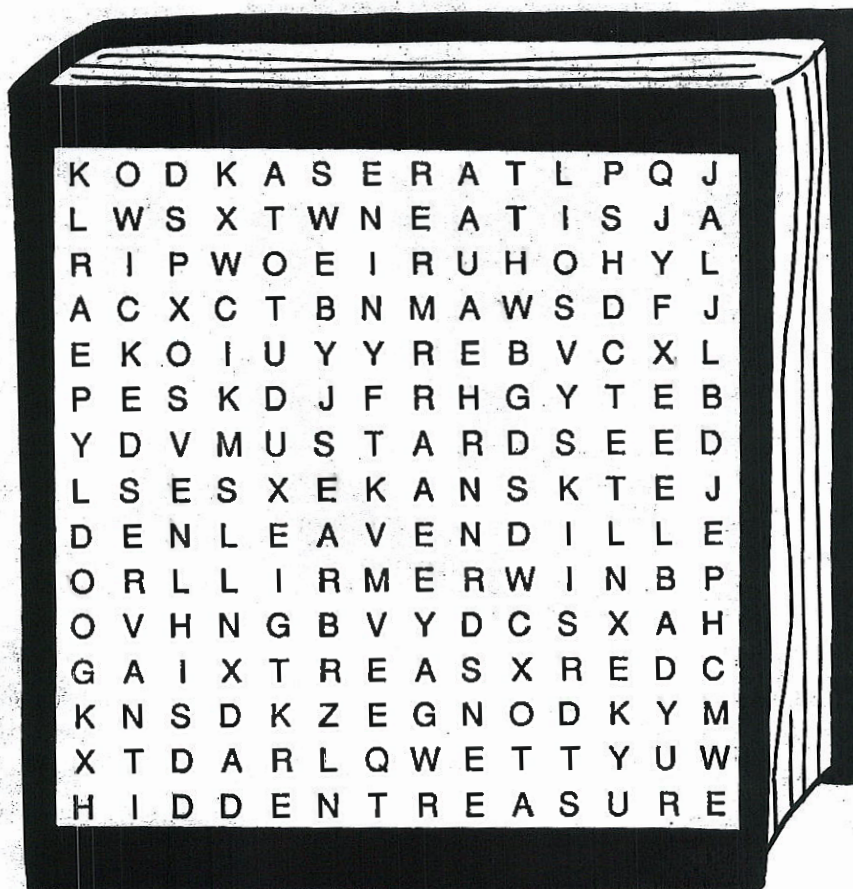

## Jesus told parables of:

1. WESOR \_\_\_\_\_
2. RSEAT \_\_\_\_\_
3. TEN \_\_\_\_\_
4. TSARMD EDSE \_\_\_\_\_
5. VEENLA \_\_\_\_\_
6. DHIEND SEERRAI \_\_\_\_\_
7. OOYLDQ ALRPE \_\_\_\_\_
8. KEDIWC RVTNAES \_\_\_\_\_

- \_\_\_\_\_ *Matthew 13:33*
- \_\_\_\_\_ *Luke 13:18-19*
- \_\_\_\_\_ *Matthew 13:45-46*
- \_\_\_\_\_ *Matthew 18:23-35*
- \_\_\_\_\_ *Matthew 13:44*
- \_\_\_\_\_ *Matthew 13:24-30*
- \_\_\_\_\_ *Luke 8:5-15*
- \_\_\_\_\_ *Matthew 13:47-50*

## **Year 3**

### **Week 129**

#### **Jesus Feeds the 5,000 and Walks on Water**

**Scriptures:** Matt 14:15-33, Mark 6:30-51

**Key Verse:** Matt. 14:33 Then those who were in the boat came and worshiped Him, saying, "Truly You are the Son of God."

#### **Key Points:**

1. Jesus went out and found a large multitude that wanted to be near him. Jesus had compassion on them and healed their sick. The disciples encouraged him to send the people away to get food for themselves for it was late and they would be getting hungry. Jesus told his disciples not to send them away that they could feed them. He asked His disciples about the food they had. They only had 5 loaves and 2 fish. He had them sit on the grass in groups of 50 and 100. He blessed the food then gave it to his disciples to pass out. When it had all been passed out they had fed 5000 men and gathered 12 baskets of leftover food.
2. Immediately Jesus had the disciples get into a boat and go before Him to the other side of the sea, while Jesus sent the multitude away. Jesus then went to the mountain to pray. At evening, the boat was in the middle of the sea. Jesus was alone on the land.
3. As a great storm came up, Jesus came to them, walking on the sea. They saw him and were afraid, thinking he was ghost. Jesus told them to be of good cheer and not to be afraid. Peter wanted to walk on the water to Jesus. He started to walk out to Jesus but became afraid and began to sink. But Jesus caught him and asked him why he doubted. He calmed the sea and those on the boat were greatly amazed at Jesus and worshiped him saying "You truly are the Son of God!"



# 197. FEEDING THE 5,000

(JOHN 6:1-14)

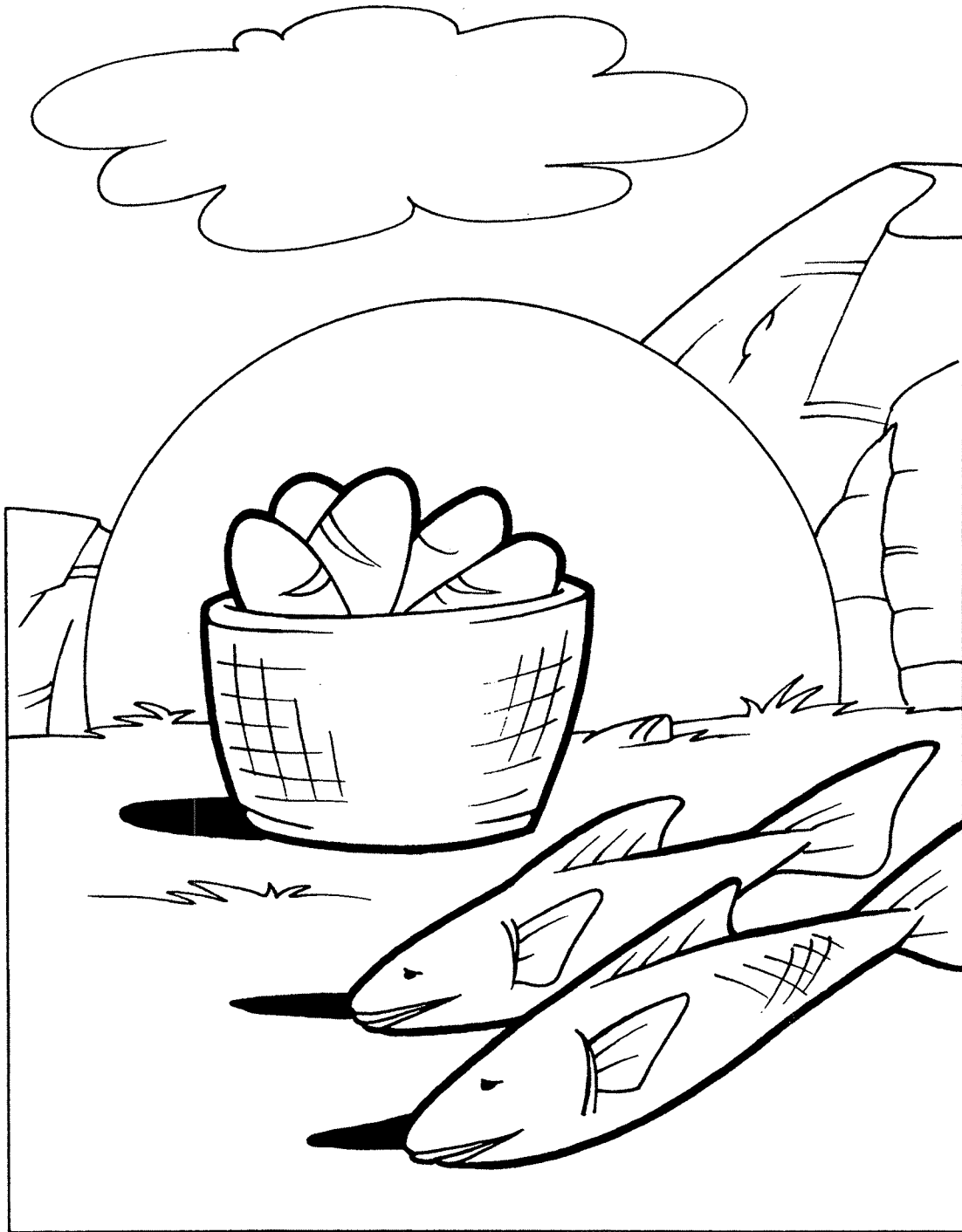

“One of his disciples, Andrew, Simon Peter's brother, saith unto him, There is a lad here, which hath five barley loaves, and two small fishes: but what are they among so many?”  
JOHN 6:8-9

# JESUS FEEDS THE 5000

One time when Jesus was at a desert place, a large group gathered to hear him speak. After teaching them all day, Jesus was concerned about them not having eaten. One disciple found a little boy who was willing to share his lunch of five loaves of bread and two fish. Jesus blessed the lunch and told the disciples to feed the people. There were more than 5000 people present! Yet there was plenty of food—and twelve baskets of food were collected after everyone was done.

(John 6:1-15)





# The Boy's Lunch

(Mark 6:30-44, Luke 9:10-17)

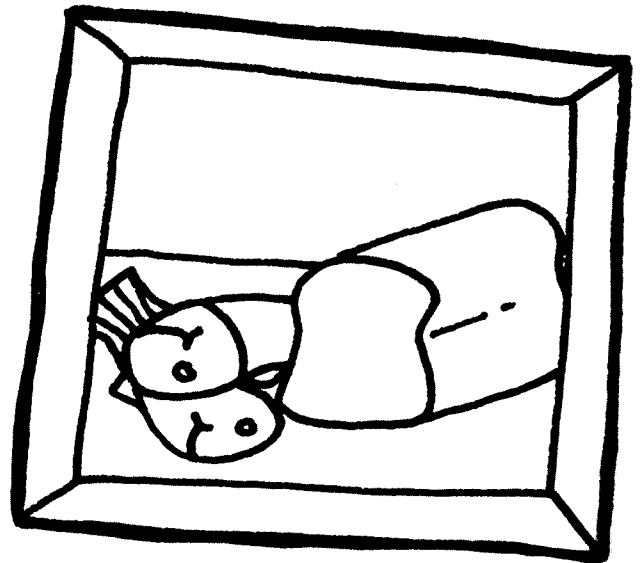
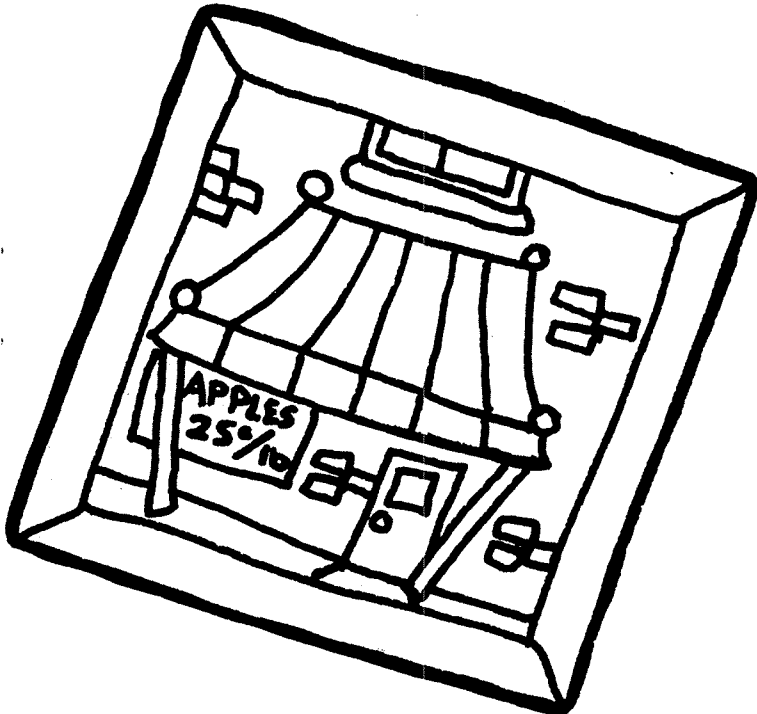
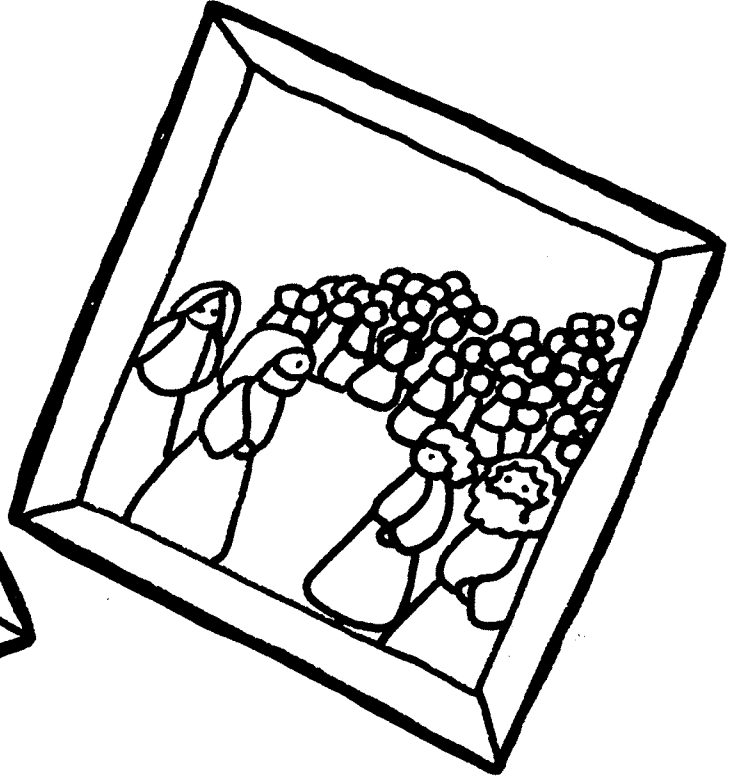
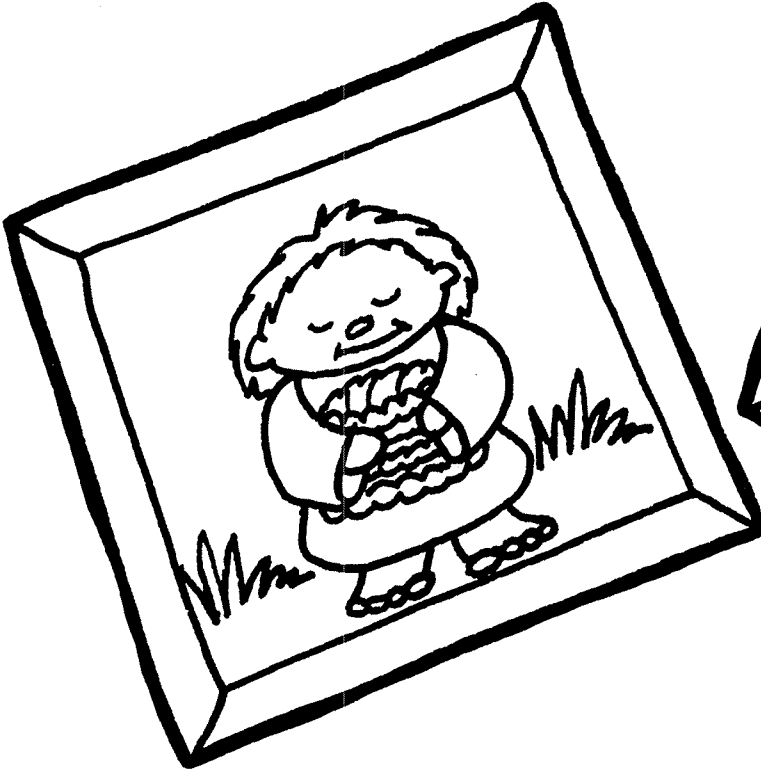

Circle the picture that does not belong.

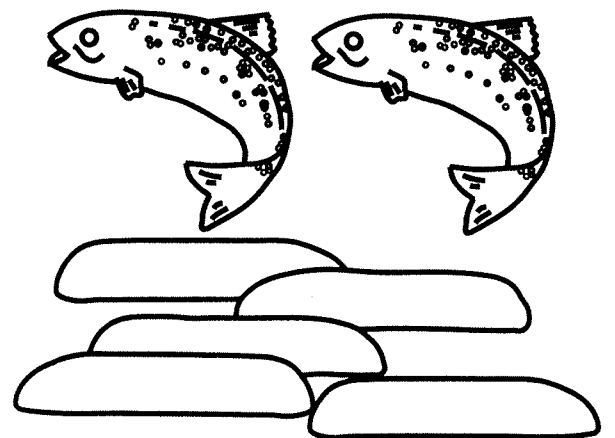
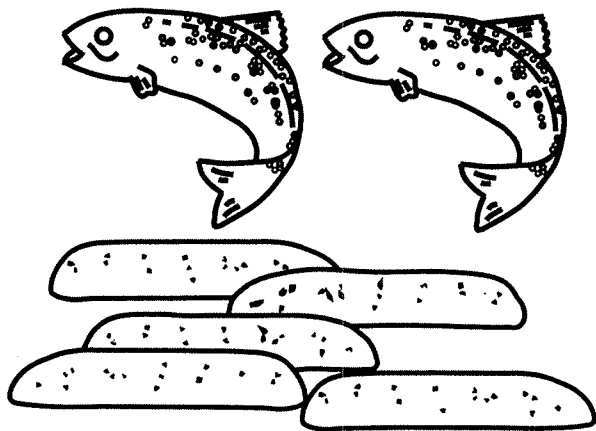
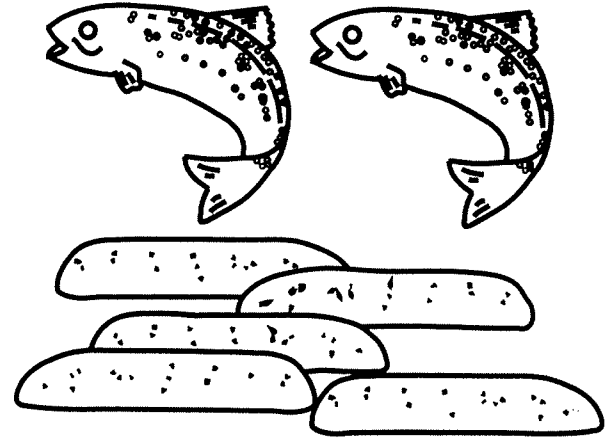
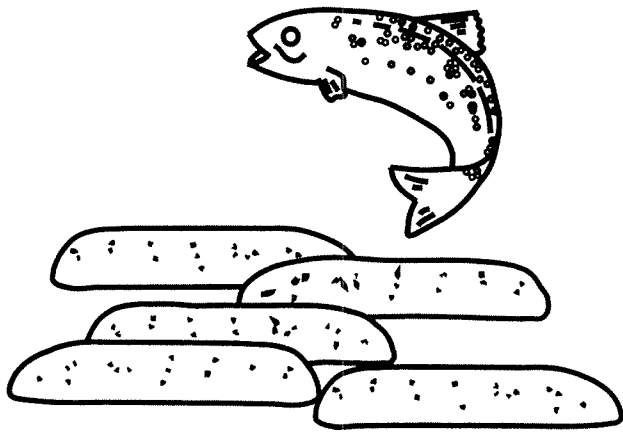
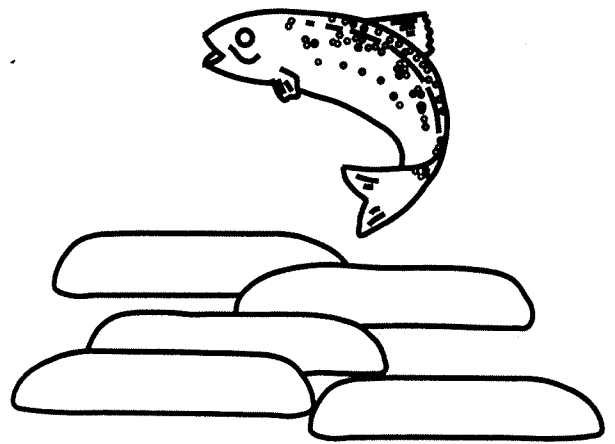
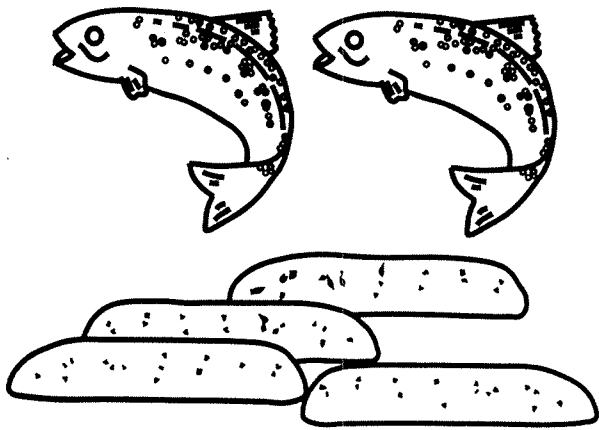

Many people came to hear Jesus. They listened a long time. Soon they got hungry. There was no food. Jesus took 5 loaves of bread and 2 fish. He prayed for them. They fed all the people. Matthew 14:17

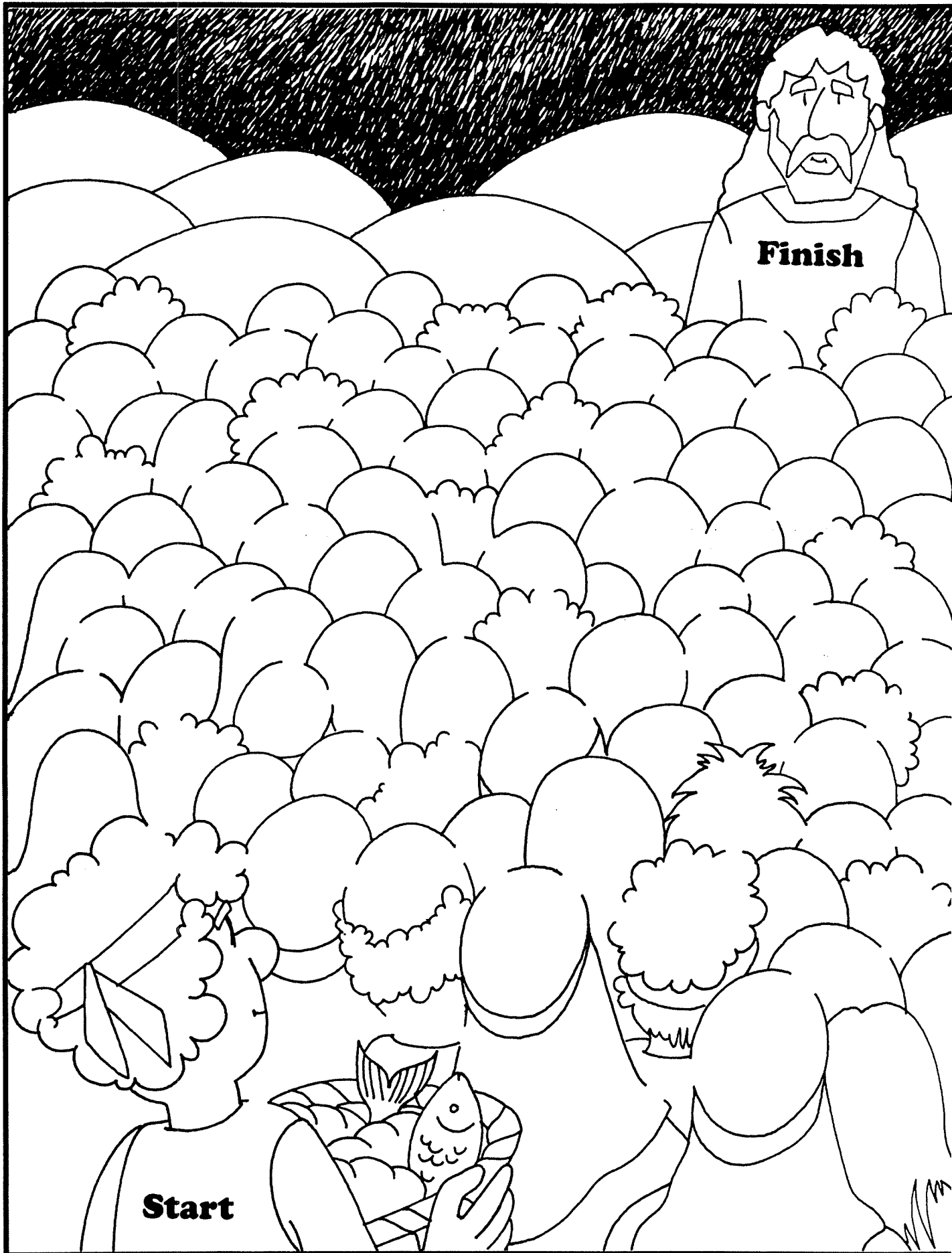

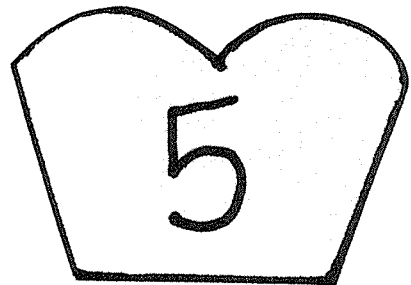
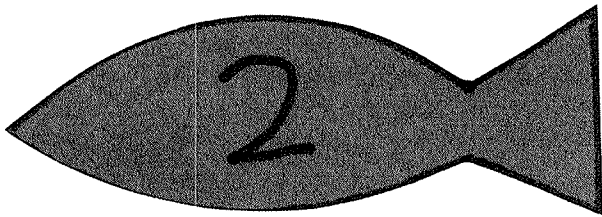
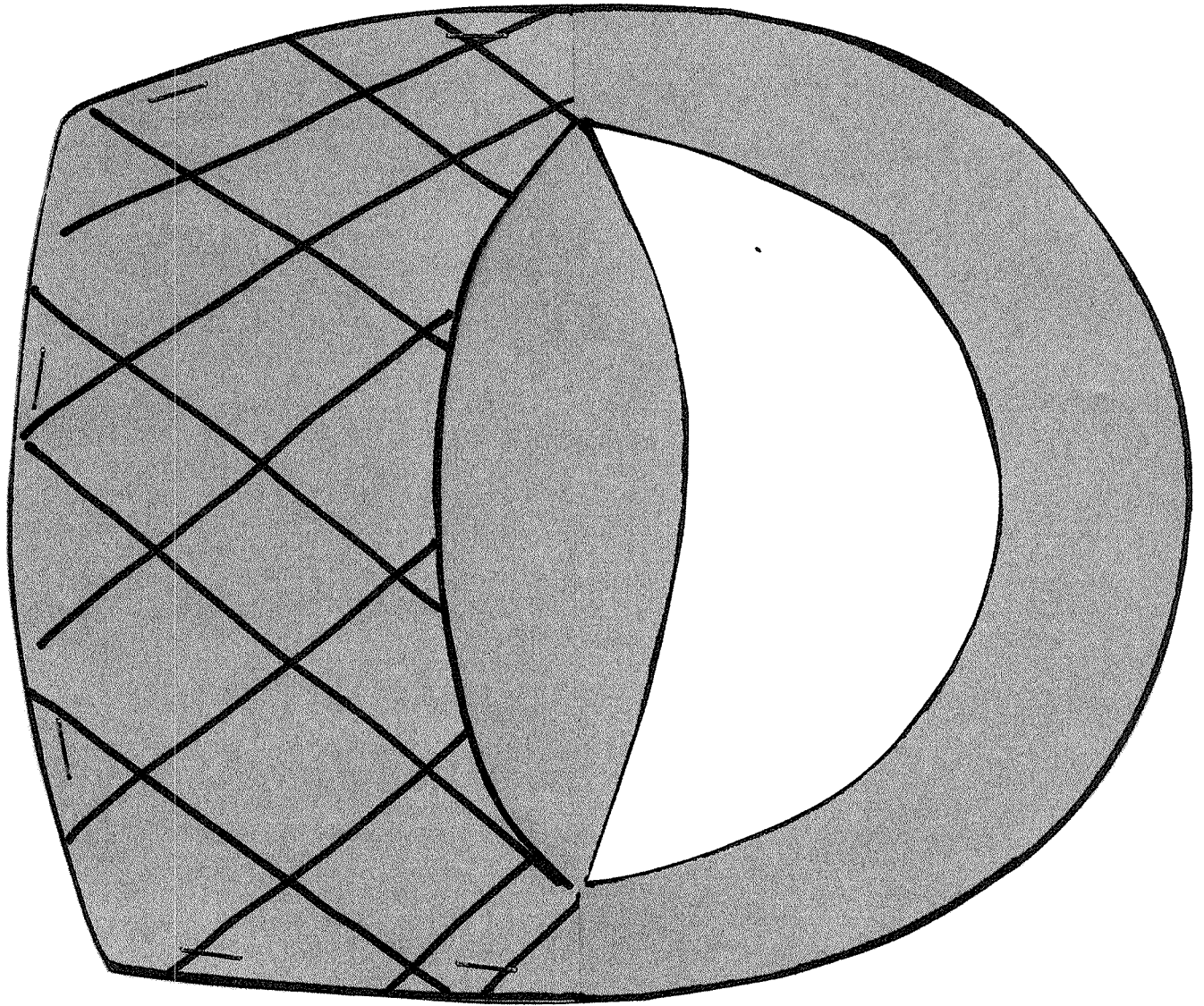

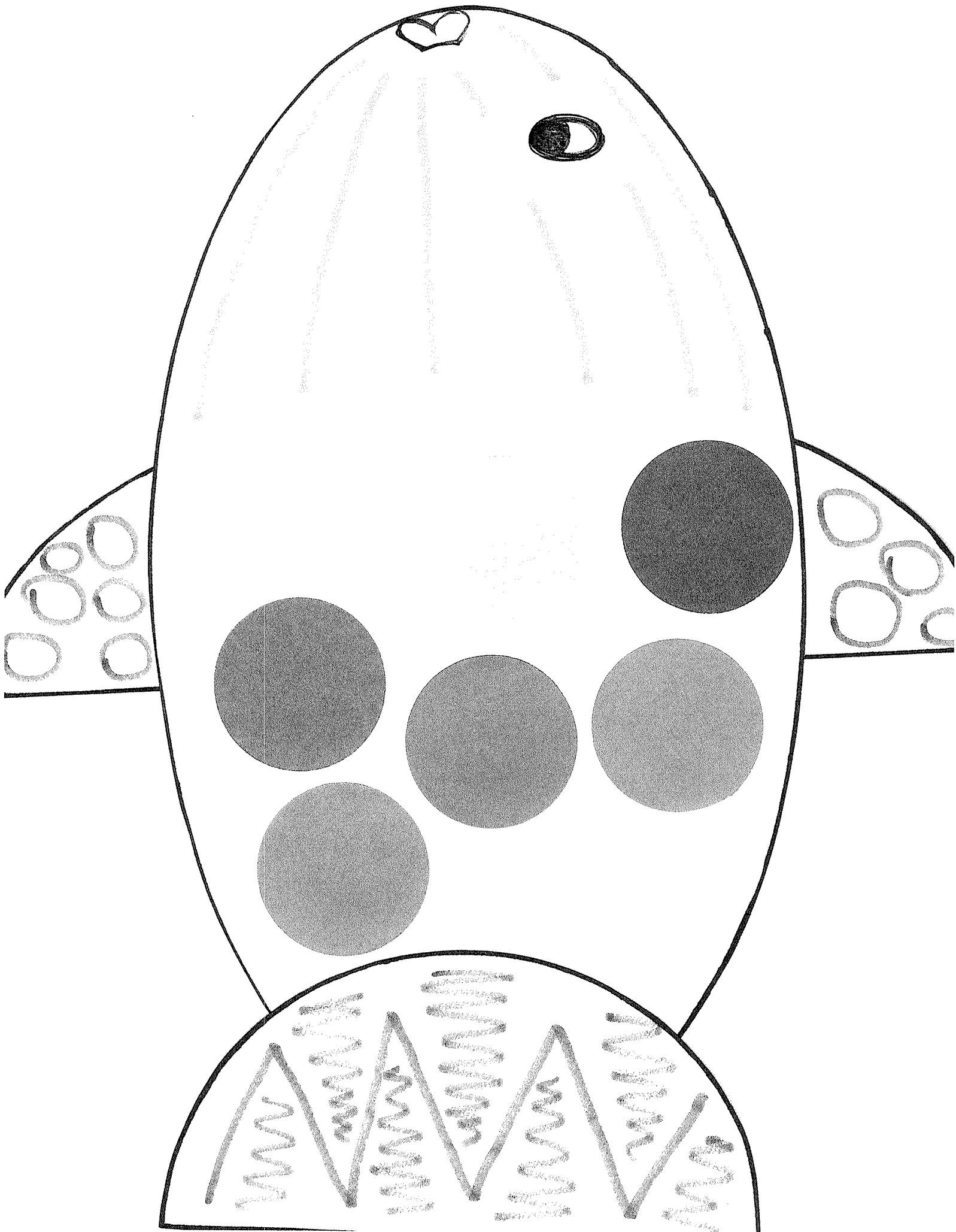

# Jesus Feeds 5,000

John 6:5-14

When Jesus \_\_\_\_\_ up and saw a great \_\_\_\_\_

\_\_\_\_\_ coming toward him, he said to \_\_\_\_\_  
 "Where shall we buy \_\_\_\_\_ for these \_\_\_\_\_

to eat?" He asked this only to \_\_\_\_\_ him, for he already had  
 in \_\_\_\_\_ what he was going to do.

Philip answered him, "Eight months' \_\_\_\_\_ would not  
 buy enough bread for each one to have a \_\_\_\_\_!"

Another of his \_\_\_\_\_, Andrew, Simon  
 Peter's \_\_\_\_\_, spoke up, "Here is a \_\_\_\_\_ with

five small barley \_\_\_\_\_ and two small \_\_\_\_\_,  
 but how far will they go \_\_\_\_\_ so many?"

\_\_\_\_\_ said, "Have the people \_\_\_\_\_ down." There  
 was plenty of \_\_\_\_\_ in that place, and the \_\_\_\_\_ sat

down, about five \_\_\_\_\_ of them. Jesus then took  
 the loaves, gave \_\_\_\_\_, and distributed to those who

were \_\_\_\_\_ as much as they wanted. He did the  
 \_\_\_\_\_ with the fish.

When they had all had enough to \_\_\_\_\_, he said to his  
 disciples, "\_\_\_\_\_ the pieces that are left over. Let

nothing be \_\_\_\_\_." So they gathered them and filled  
 \_\_\_\_\_ baskets with the pieces of the \_\_\_\_\_

barley loaves left over by those who had eaten.  
 After the people saw the \_\_\_\_\_ sign  
 that Jesus did, they began to say, "Surely this is the \_\_\_\_\_

\_\_\_\_\_ who is to come into the \_\_\_\_\_."

M D M B F D E K O O L J W N  
 Q I F I S H U Y A C B I S E  
 O S R G N S W B R O P H E T C  
 I C M A B D P R O P H E T C  
 E I D T C F H E N Y G I E E  
 J P K H L U M H G N E O D P  
 Q L N E R D L T S S X M T Y U  
 V E Z R L T H O U S S A N D W  
 M S A R J B D R U C S W F T  
 E I O T F E J B G S O I H H  
 S W E W B P S S K S R V Q O A  
 I S N E I R S U C S E A T M N  
 T P U L Q V E R S S E V T A K K  
 G C I V T Q A G A W D S A R G L  
 M H I E E A A W D S S A R G L  
 P E O P L E A W D S S A R G L



Jesus Comes to  
the Followers  
John 6:16-21

# Jesus Can Do Anything!

Jesus' friends got into a boat and started across Lake Galilee. Later, Jesus wanted to join them, but they were already three or four miles away. What did Jesus do then?

Cross out the letters F, G, I, P, and Q every time you see them in the puzzle. Transfer the left-over letters to the spaces below to read the answer.

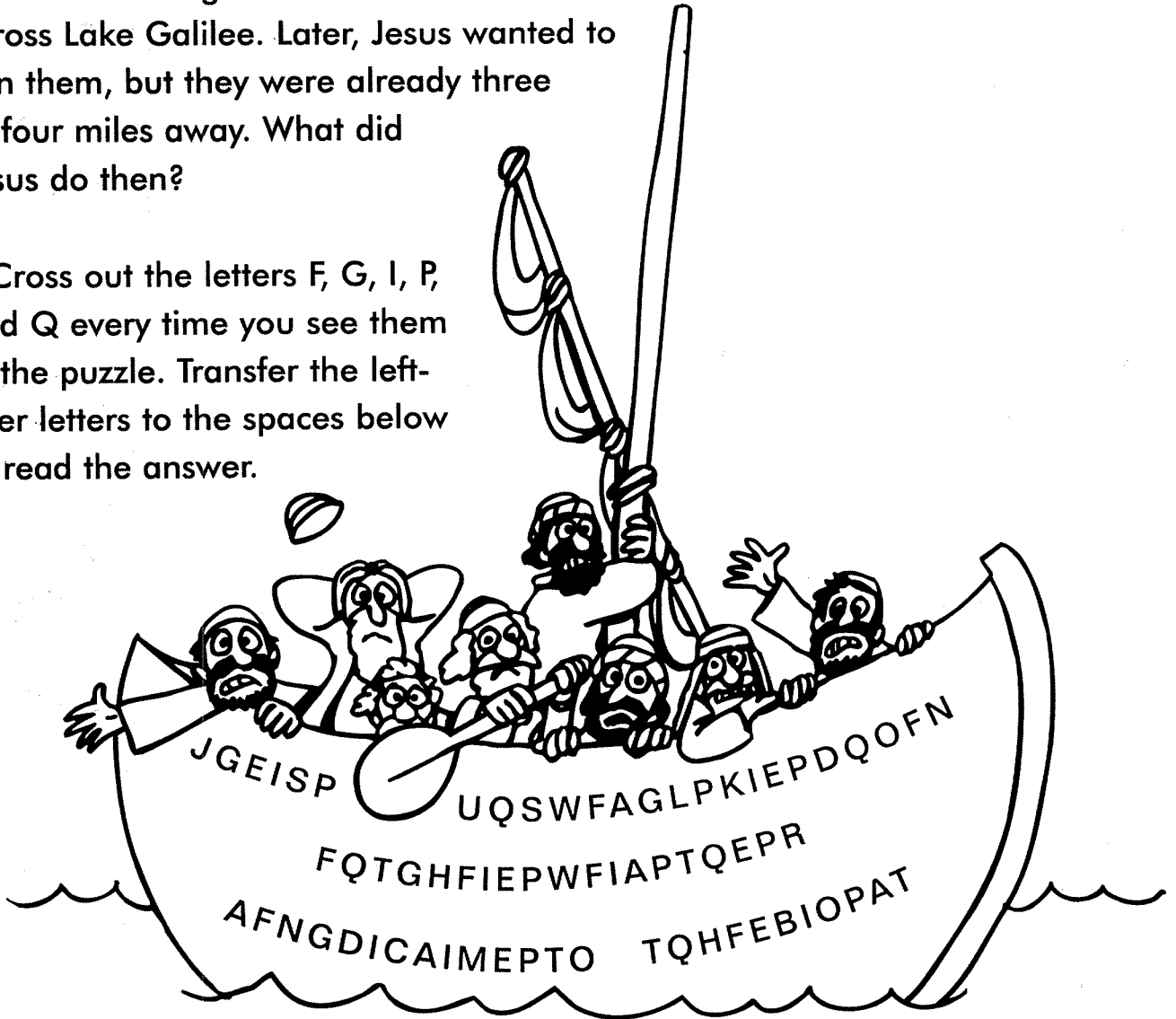

-----  
-----  
-----

# Miracles of Jesus

IDENTIFY THE MIRACLES OF JESUS USING THE PICTURE CLUES BELOW.



1

LUKE 5: 18-25

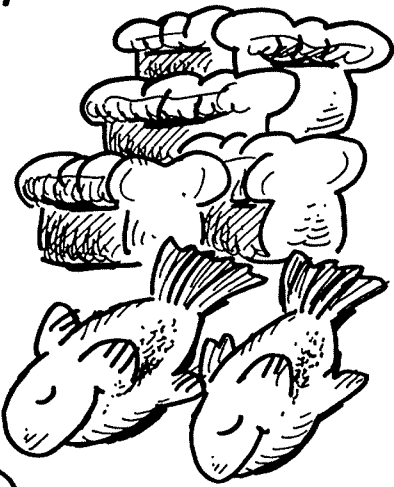

2

JOHN 6:1-13



3

MARK 5:8-14

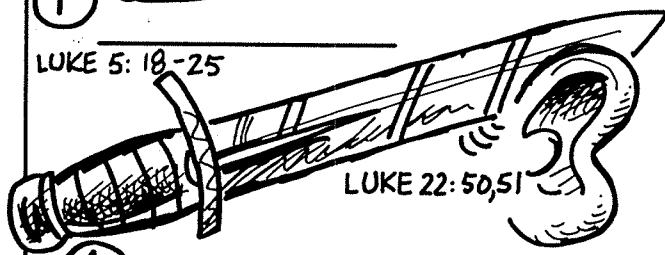

LUKE 22:50,51

4

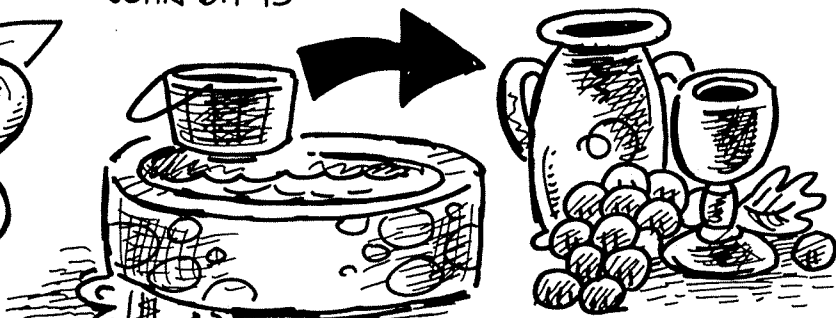

5

JOHN 2:1-11

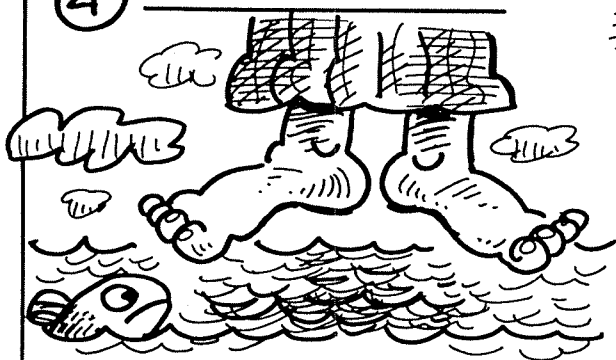

6

MARK 6:48-51

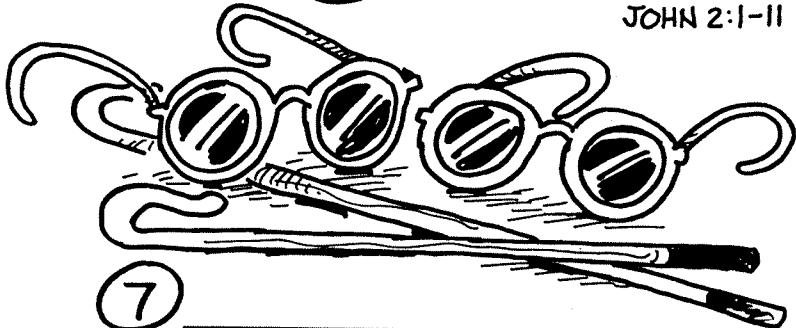

7

MATTHEW 9:27-31



MATTHEW 12:10-13

8

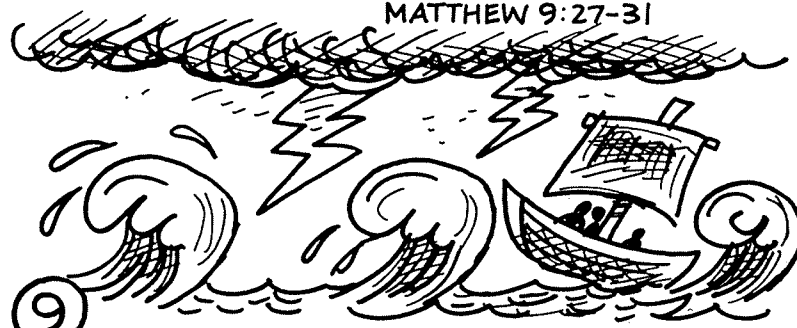

9



MATT. 8:23-27





# Jesus Walked on Water

Read Matthew 14:22-33. Unscramble the large letters to find a name. Then write the large letters in the correct order in the top of the empty box. Copy the columns under each bold letter in the correct order. Now read from left to right to find the answer from Matthew 14:33.

<b>E</b>	<b>U</b>	<b>J</b>	<b>S</b>	<b>S</b>
those	were	Then	who	in
boat	him	the	worshipped	saying
you	the	Truly	are	Son
God		of		

# Who Walks on Water?



bird



fish



people



walk



Jesus



lake



boat



wind



afraid



s fly in the air.



swim in the water.



on land. do not fly like s. They do not live in the water like . But can on water?

One man did. That man was . One night ' followers were on Galilee. They were rowing a across the . A strong , made waves.

The waves got bigger and bigger. ' followers rowed the harder and harder in the big

waves. Then they saw something ing on the waves. They were ! It was . said to

them, "Don't be . It is I." They took into the . Suddenly the was on land right where

they wanted to go. had great power!

# JESUS WALKS ON THE WATER

(MARK 6:45-52)

## MEMORY VERSE:

"Be of good cheer! It is I; do not be afraid." MARK 6:50

## FILL IN THE BLANK:

1. "Immediately He made His disciples get into the \_\_\_\_\_ and go before Him to the other side, to Bethsaida, while He sent the multitude away." **MARK 6:45**

## TRUE OR FALSE:

2. "And when He had sent them away, He departed to the mountain to pray." **MARK 6:46**  
**TRUE OR FALSE**

3. "Now when evening came, the boat was in the middle of the sea; and He was alone on the land." **MARK 6:47**

**TRUE OR FALSE**

## FILL IN THE BLANKS:

4. "Then He saw them straining at rowing, for the \_\_\_\_\_ was against them..." **MARK 6:48**

5. "...He came to them, \_\_\_\_\_ on the sea, and would have passed them by." **MARK 6:48**

## TRUE OR FALSE:

6. And when they saw Him walking on the sea, they supposed it was John... **MARK 6:49**  
**TRUE OR FALSE**

7. "And immediately He talked with them and said to them, 'Be of good cheer! It is I; do not be afraid.'" **MARK 6:50**

**TRUE OR FALSE**

## FILL IN THE BLANKS:

8. "Then He went up into the boat to them, and the wind \_\_\_\_\_..." **MARK 6:51**

9. "And they were greatly \_\_\_\_\_ in themselves beyond measure, and marveled." **MARK 6:51**

# JESUS WALKS ON THE WATER

## (MARK 6:45-52)

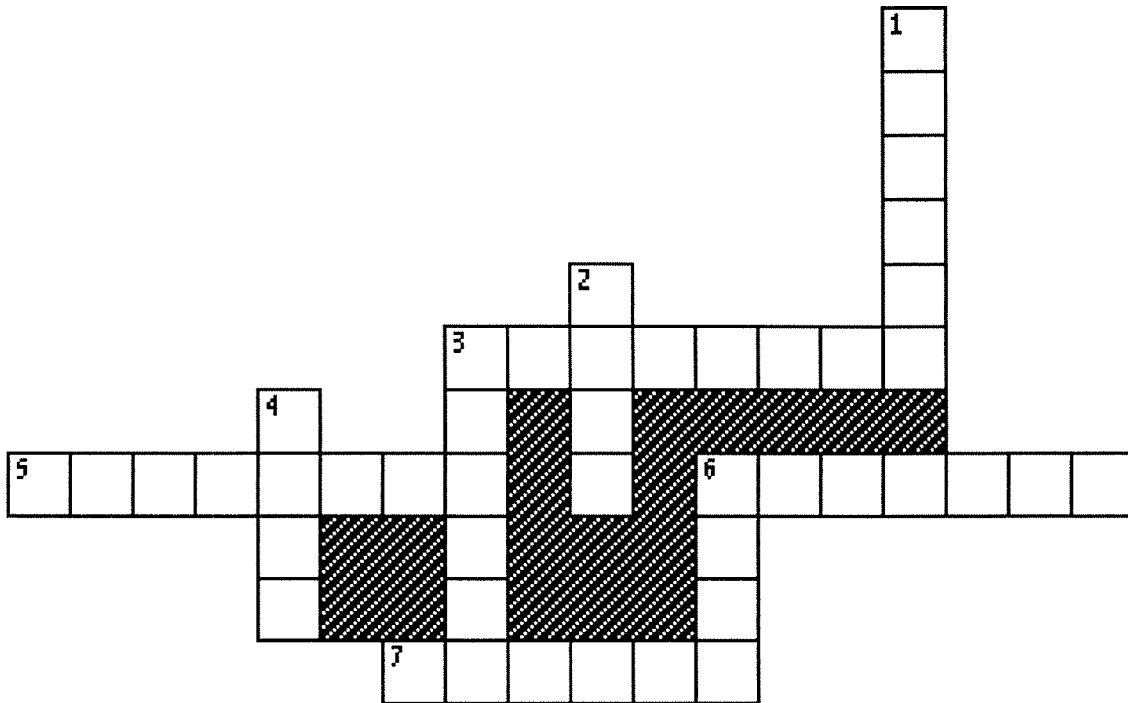

- 4 DOWN "Immediately He made His disciples get into the \_\_\_\_\_ and go before Him to the other side, to Bethsaida, while He sent the multitude away." **MARK 6:45**
- 2 DOWN "And when He had sent them away, He departed to the mountain to \_\_\_\_\_." **MARK 6:46**
- 3 DOWN "Now when evening came, the boat was in the \_\_\_\_\_ of the sea; and He was alone on the land." **MARK 6:47**
- 6 DOWN "Then He saw them straining at rowing, for the \_\_\_\_\_ was against them..." **MARK 6:48**
- 6 ACROSS "...He came to them, \_\_\_\_\_ on the sea, and would have passed them by." **MARK 6:48**
- 5 ACROSS "But when they saw Him walking on the sea, they \_\_\_\_\_ it was a ghost..." **MARK 6:49**
- 1 DOWN "And immediately He talked with them and said to them, 'Be of good cheer! It is I; do not be \_\_\_\_\_.'" **MARK 6:50**
- 7 ACROSS "Then He went up into the boat to them, and the wind \_\_\_\_\_..." **MARK 6:51**
- 3 ACROSS "And they were greatly amazed in themselves beyond measure, and \_\_\_\_\_" **MARK 6:51**

# Miracle Numbers

Jesus did many miracles that showed how much He loves and cares for people. Just as when He was on earth, Jesus has power over nature, evil spirits, sickness and death today too.

Choose a number from below to write in each of the blanks in the statements about Jesus' miracles. You will need to use some numbers more than once. If you need help, look up the Bible verses.

**1**      **153**      **6**      **18**

**2**      **5000**      **10**

**5**      **12**      **7**      **38**      **4**

1. Jesus raised to life a girl who was \_\_\_\_\_ years old. (*Mark 5:22-24; 35-43*)
2. Jesus healed a woman who had an "issue of blood" for \_\_\_\_\_ years. (*Mark 5:25-34*)
3. Jesus used a boy's lunch of \_\_\_\_\_ loaves of bread and \_\_\_\_\_ fish to feed \_\_\_\_\_ people. (*John 6:9-13*)
4. Jesus healed a man who was laying by a pool of water. He had been sick for \_\_\_\_\_ years. (*John 5:1-9*)
5. \_\_\_\_\_ lepers came to Jesus to be healed, but only \_\_\_\_\_ of the men told Jesus, "Thank You." (*Luke 17:12-19*)
6. Peter and the disciples caught \_\_\_\_\_ fish when Jesus told them where to put their nets. (*John 21:1-11*)
7. Jesus made the water in \_\_\_\_\_ waterpots into wine at a wedding in Cana. (*John 2:1-11*)
8. Jesus healed a woman who had a spirit of infirmity and was crippled for \_\_\_\_\_ years. (*Luke 13:11-17*)
9. Lazarus had been dead for \_\_\_\_\_ days when Jesus came and brought him back to life. (*John 11:1-45*)
10. Jesus fed more than 4000 people with \_\_\_\_\_ loaves of bread, plus there were \_\_\_\_\_ baskets of leftovers. (*Matthew 15:32-38*)

# Crossword Boat

All the words in the puzzle are from the story "Who Walks on Water?" Look for the clues in the story. Find the missing words. Fill in the empty boxes with the words that fit the clues.

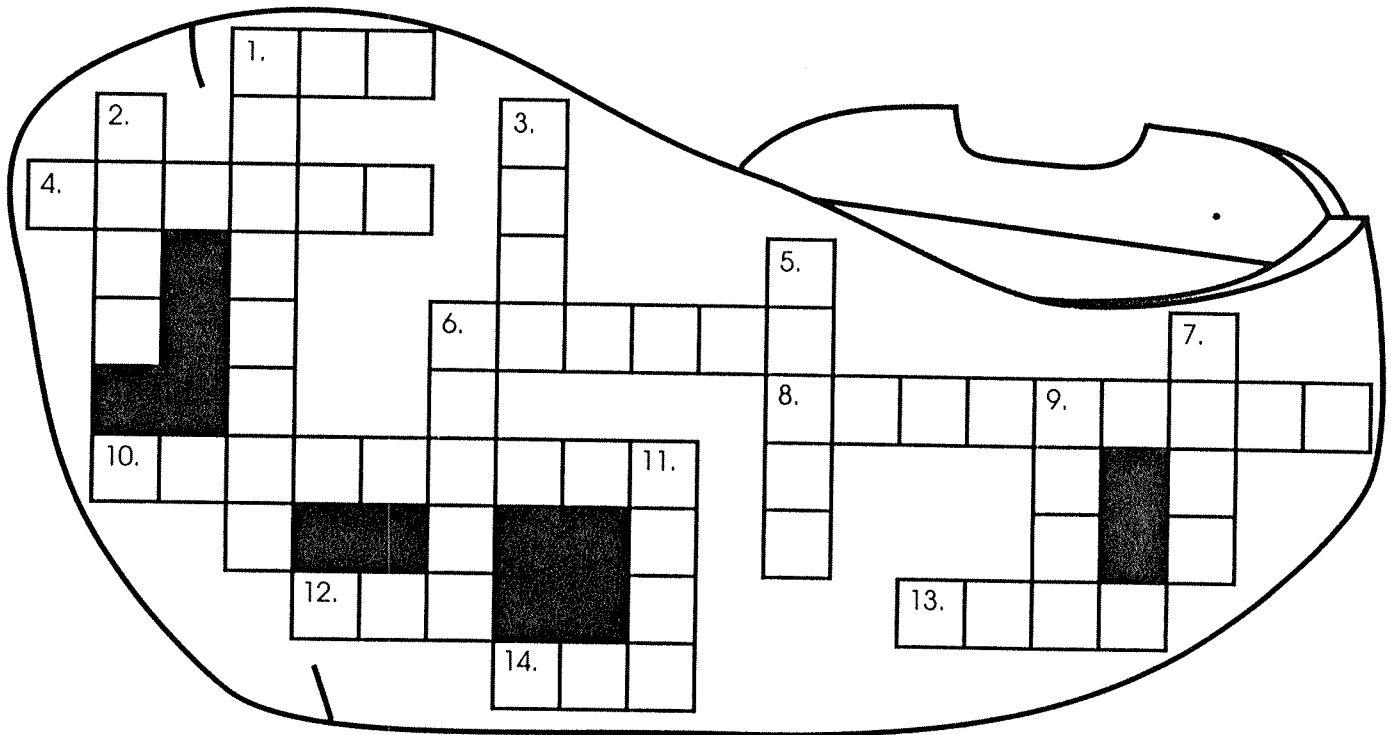

Clues Across:

1. they \_\_\_\_\_ something
4. rowed the boat \_\_\_\_\_
6. \_\_\_\_\_ do not fly
8. \_\_\_\_\_ walking on waves
10. One night Jesus' \_\_\_\_\_
12. Birds fly in the \_\_\_\_\_
13. a boat across the \_\_\_\_\_
14. One man \_\_\_\_\_.

Clues Down:

1. \_\_\_\_\_ the boat was on
2. people \_\_\_\_\_ on water?
3. They do not \_\_\_\_\_ in
5. It was \_\_\_\_\_.
6. Jesus had great \_\_\_\_\_!
7. \_\_\_\_\_ swim in the water.
9. \_\_\_\_\_ Jesus into the boat.
11. Jesus \_\_\_\_\_ to them,

# Jesus Walks on Water

Matthew 14:22-34 (NIV)

Jesus performed many miracles. One night he even walked on water to meet his disciples who were in a boat on the Lake. The disciples were very startled to see Jesus walking on the water towards them. Peter said to Jesus, "tell me to come to you on the water." Jesus said "Come" and Peter got out of the boat and started to walk on the water toward Jesus. That took a lot of faith. But then he became afraid because of the wind and began to sink and cried out to the Jesus to save him. Read Matthew 14:31 (NIV) and fill in the blanks below to see what Jesus did and said to Peter.

Jesus reached out his hand and caught him. " You of \_\_\_\_\_  
\_\_\_\_\_, " he said, "why did you \_\_\_\_\_?"

Just as Jesus wanted Peter to have greater faith in Him and the power of God so he wants us to have faith that God will help us to do the things that we know God wants us to do. Read verse 32 and fill in the blanks to see what the disciples said after Jesus climbed into the boat with them.

"Truly you are the \_\_\_\_\_ "

Lead Jesus through the water maze to reach the disciples in the boat.

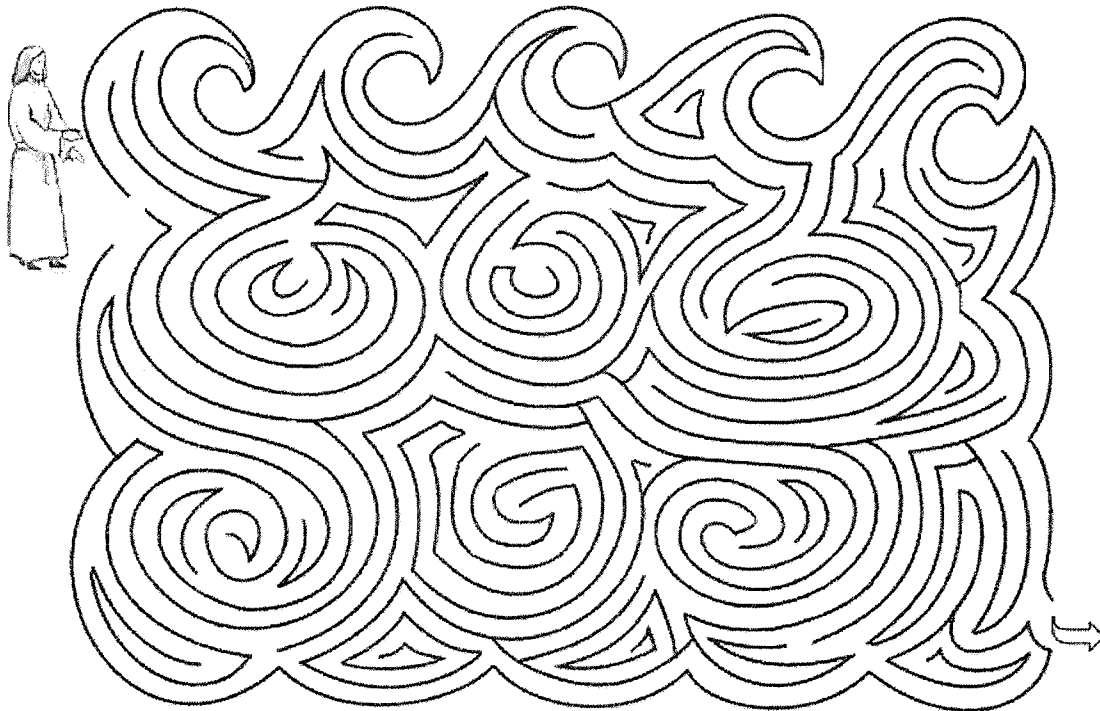

copyright 1999 Sharon Whittaker  
<http://sewhttkr.home.comcast.net>



# The Miracles of Jesus

When Jesus was on earth, He did many miracles that helped people and showed that He was sent from God. Jesus' miracles also showed His power and how much God loves all people.

The Bible tells us about four kinds of miracles Jesus did. The names of several people Jesus helped or miracles Jesus did are scrambled and listed below. Unscramble the words and write them on the lines. The first letter of each word is underlined. Then match the miracle to where it is told about in the Bible by writing the number of the miracle on the line in front of the Scripture reference.

## Jesus has power over sickness

1. LPEER \_\_\_\_\_          *Matt. 17:14-21*
2. LDBIN NMA \_\_\_\_\_          *Luke 8:41-56*
3. MWANO HTWI DEEBGLNI \_\_\_\_\_          *John 11: 38-44*
4. AEFD NAD BMUD NMA \_\_\_\_\_          *Luke 7:11-16*
5. NMA HWIT OPSDRY \_\_\_\_\_          *Luke 17:12-19*
6. EVRNTSAS REA \_\_\_\_\_          *Luke 4:33-37*
7. NIE PRESEL \_\_\_\_\_          *Luke 22:50-51*

## Jesus has power over nature

8. RTEWA UINRS OI ENIW \_\_\_\_\_          *Luke 13:11-17*
9. EUJSS ALKWS NQ TERAW \_\_\_\_\_          *Matt. 8:2-4*
10. SRHIWTE GIE ERTE \_\_\_\_\_          *John 9:1-12*
11. NYEMO MREO SIHE \_\_\_\_\_          *Luke 14:1-4*

## Jesus has power over evil spirits

12. RIITSP FQ FRITIYMIN \_\_\_\_\_          *Mark 7:31-37*
13. AMN IHTW LNUAECN VDLIE \_\_\_\_\_          *Mark 5:25-34*
14. HILQD \_\_\_\_\_          *John 2:1-11*
- \_\_\_\_\_          *Matt. 17:24-27*
- \_\_\_\_\_          *Matt. 21:19-22*
- \_\_\_\_\_          *Mark 6:45-51*

## Jesus has power over death

15. IAUJRS EHUDAGTR \_\_\_\_\_
16. DWWISO NOS \_\_\_\_\_
17. AALZSUR \_\_\_\_\_

# 52. Jesus Calms the Storm

Find as many words as you can in the letters below. Go from left to right.

**STORM**SEASTILLOBEYWINDISHIPAWAKEPEACE

1. **STORM** \_\_\_\_\_

14. \_\_\_\_\_

2. \_\_\_\_\_

15. \_\_\_\_\_

3. \_\_\_\_\_

16. \_\_\_\_\_

4. \_\_\_\_\_

17. \_\_\_\_\_

5. \_\_\_\_\_

18. \_\_\_\_\_

6. \_\_\_\_\_

19. \_\_\_\_\_

7. \_\_\_\_\_

20. \_\_\_\_\_

8. \_\_\_\_\_

## Super Word Finder!

9. \_\_\_\_\_

21. \_\_\_\_\_

10. \_\_\_\_\_

22. \_\_\_\_\_

11. \_\_\_\_\_

23. \_\_\_\_\_

12. \_\_\_\_\_

24. \_\_\_\_\_

13. \_\_\_\_\_

25. \_\_\_\_\_

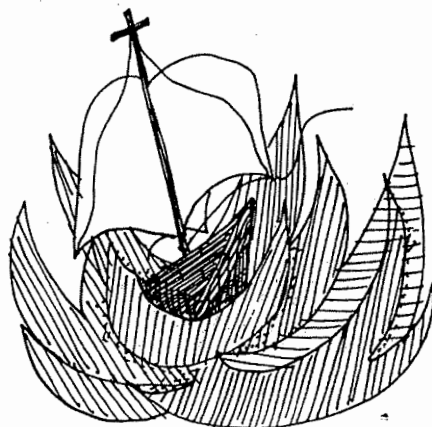

**Jesus Calms  
the Sea  
Matthew 8**

# SOS

Use the letter code to find out what Jesus did.

In Morse code, SOS is a call for help. Jesus and his disciples were on the Sea of Galilee when a furious storm came up on the lake. The disciples immediately went to Jesus for help. What miraculous way did Jesus use to save his disciples from the storm?

A	B	C	D	E	F	G	H	I	J	K	L	M
F	M	H	Q	L	Y	P	V	N	U	R	D	J
N	O	P	Q	R	S	T	U	V	W	X	Y	Z
C	T	I	A	W	K	E	Z	S	G	O	B	X

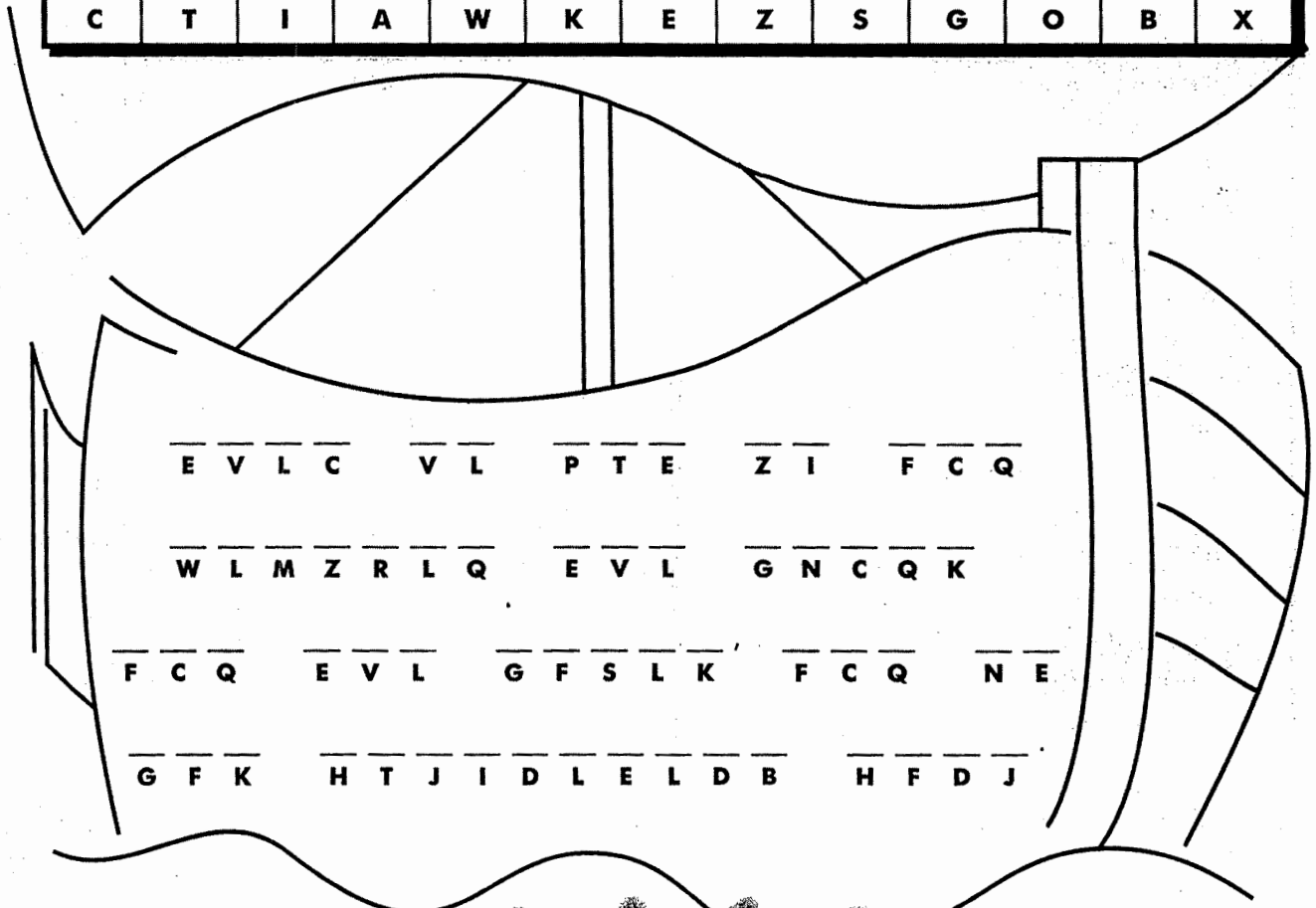

# JESUS CALMS A STORM

## (MATTHEW 8:23-27)

### MEMORY VERSE:

*"Then they cry out to the LORD in their trouble, and He brings them out of their distresses. He calms the storm, so that the waves are still. Then they are glad because they are quiet; so He guides them to their desired haven." PSALM 107:28-30*

### UNDERLINE THE CORRECT ANSWER:

1. "Now when He got into a boat,..." **MATTHEW 8:23**
  - a. the Pharisees followed Him
  - b. His disciples followed Him

### CIRCLE THE CORRECT WORD:

2. "And suddenly a great tempest arose on the sea, so that the boat was covered with (**WAVES, BIRDS**)..." **MATTHEW 8:24**

### TRUE OR FALSE:

3. "...But He was asleep." **MATTHEW 8:24**  
TRUE OR FALSE
4. Then His disciples came to Him and awoke Him, saying, "Lord, let's do some fishing!" **MATTHEW 8:25**  
TRUE OR FALSE

### CIRCLE THE CORRECT WORDS:

5. "But He said to them, 'Why are you fearful, O you of little (**FISH, FAITH**)?'" **MATTHEW 8:26**
6. "...Then He arose and rebuked the winds and the sea, and there was a great (**CALM, WAVE**).'" **MATTHEW 8:26**

### FILL IN THE BLANK:

7. "So the men marveled, saying, 'Who can this be, that even the winds and the sea \_\_\_\_\_ Him?'" **MATTHEW 8:27**

**Year 3**

**Week 130**

## **The Transfiguration**

**Scriptures: Mark 9:1-10, 9:33-37**

**Key Verse: Mark 9:7 And a cloud came and overshadowed them; and a voice came out of the cloud, saying, "This is My beloved Son. Hear Him!"**

**Key Points:**

1. Jesus, with Peter, James and John went up to a high mountain. His clothes became extremely white and his face was shining. He became transfigured.
2. Elijah appeared to them with Moses and they were talking to Jesus. This was unusual since Elijah and Moses had already died. Peter impulsively wanted to make three temples in honor of Jesus, Moses and Elijah. God spoke, acknowledging Jesus as his son.
3. Suddenly they looked around and only saw Jesus. He instructed them not to tell anyone about what they had seen until he had risen from the dead. So they kept it to themselves, wondering what rising from the dead meant.
4. Jesus taught and reminded them that all people who pleased God must be humble as a child and be willing to serve.

# 199. THE TRANSFIGURATION

(MATTHEW 17:1-13)



“And after six days Jesus taketh Peter, James, and John his brother, and bringeth them up into an high mountain apart, and was transfigured before them: and his face did shine as the sun, and his raiment was white as the light.”  
MATTHEW 17:1-2



The Mount of Transfiguration  
*Matthew 17*

I AM THE LIGHT OF THE WORLD

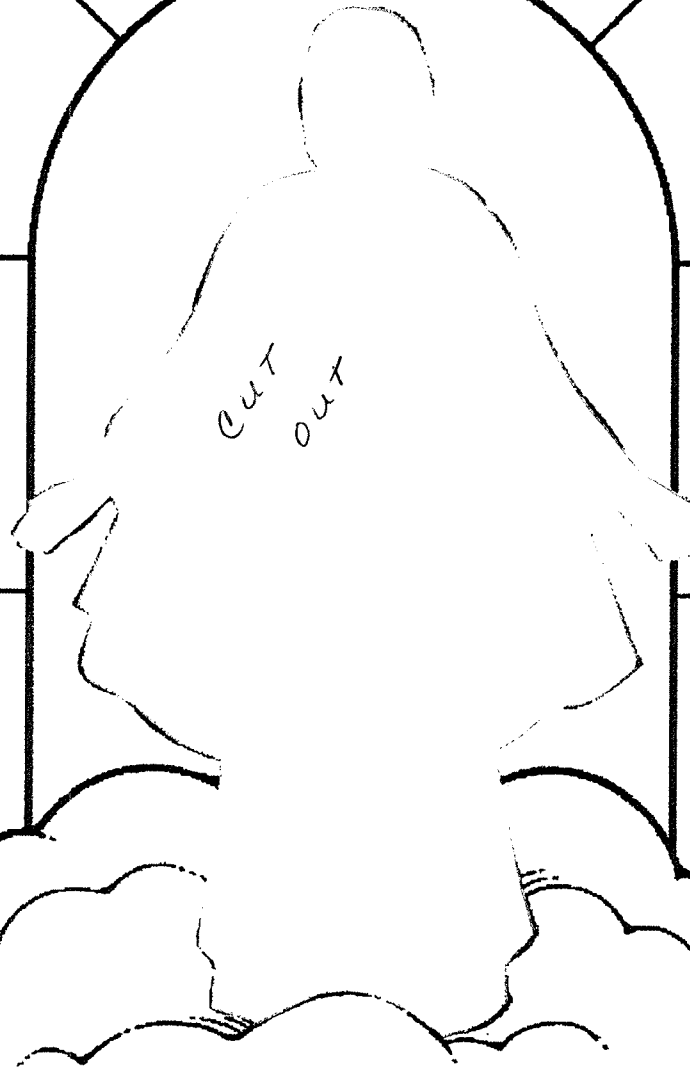

JOHN 8:12



I AM THE LIGHT OF THE WORLD



JOHN 8:12

# 63. Jesus' Transfiguration

## Matthew 17

Jesus was on a mountain with three of his disciples—Peter, James, and John. Suddenly Jesus' face shone as bright as the sun, and his clothes were as white as light. Moses and Elijah appeared and talked to Jesus. A bright cloud came over them, and God spoke.

Cross out the letters of the alphabet in order. The remaining letters will spell out what God said.

T A H I B S I C S D M Y E  
B F E L G O V H E D I S O  
J N I N K W H L O M M I A  
N M W O E L P L P Q L R E  
S A S T E D U H V E A W R  
Y X E Y H I Z M

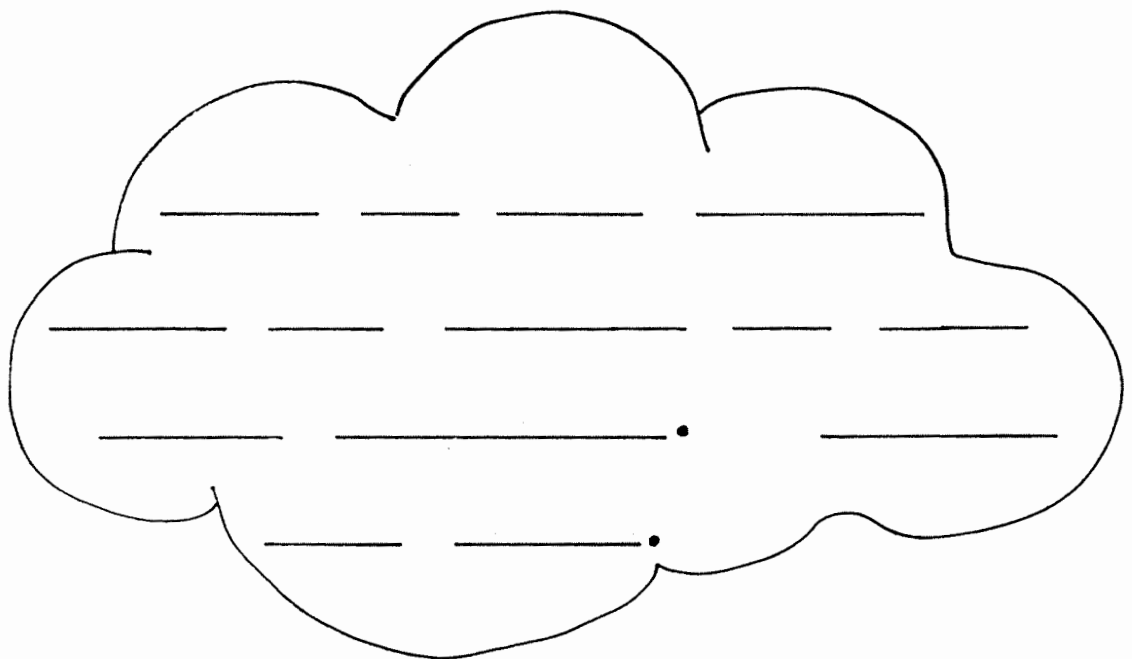

# THE TRANSFIGURATION

(MATTHEW 17:1-13)

R	P	F	A	H	Z	T	U	M	D	T	F	D	G	B
O	D	Y	A	S	U	H	P	O	E	G	H	H	P	O
E	J	F	Z	C	O	H	F	S	R	B	O	Q	C	E
C	P	Z	T	T	E	L	Q	E	U	G	C	B	Q	J
I	B	E	L	O	V	E	D	S	G	A	G	K	I	L
O	D	W	U	O	W	Z	N	S	I	L	S	Q	J	B
V	Q	R	S	U	S	E	J	E	F	L	M	O	Y	N
Z	A	G	E	L	E	R	B	H	S	V	H	I	R	Z
N	O	S	J	T	C	L	Q	T	N	N	E	S	O	Z
G	F	Z	Q	S	E	P	C	O	A	C	Z	E	I	Q
E	A	T	K	T	U	P	J	L	R	B	B	M	T	B
H	A	J	I	L	E	J	Y	C	T	B	O	A	E	B
C	H	T	M	O	U	N	T	A	I	N	B	J	H	P
J	D	J	K	R	C	Z	C	G	B	B	V	J	I	G
B	W	G	V	B	J	Z	T	U	B	D	R	O	L	D

BELOVED  
CLOTHES  
ELIJAH  
FACE  
JAMES

JESUS  
JOHN  
LORD  
MOSES  
MOUNTAIN

PETER  
SON  
TRANSFIGURED  
VOICE

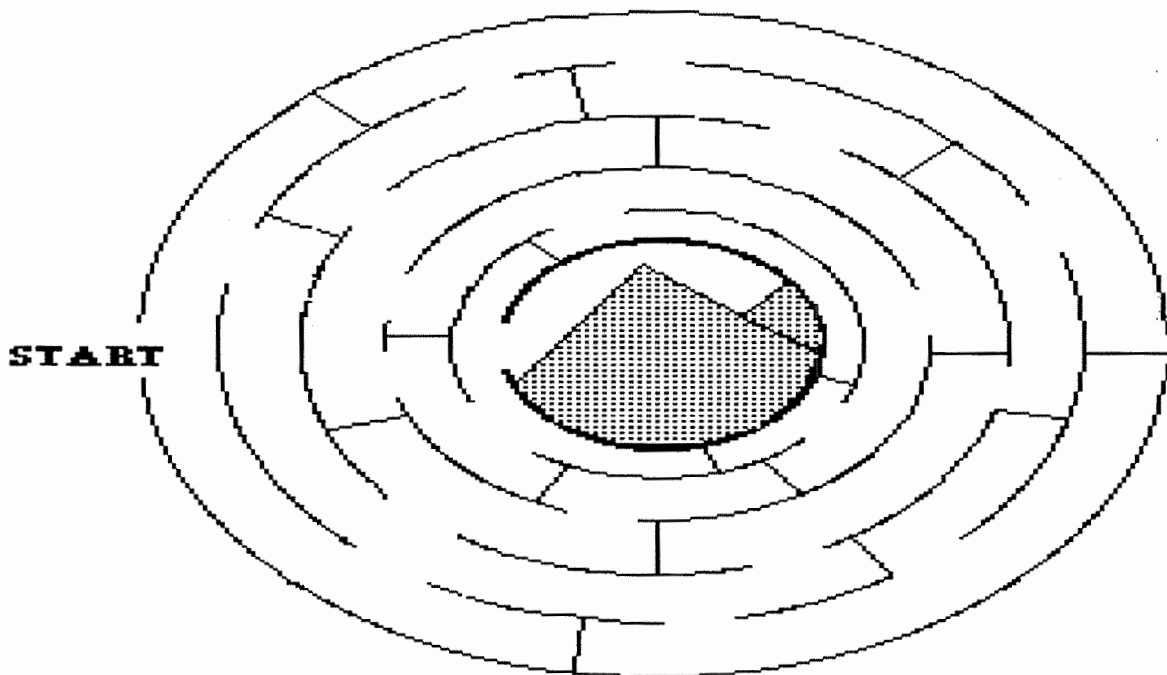

# THE TRANSFIGURATION

## (MATTHEW 17:1-13)

### MEMORY VERSE:

*"This is My beloved Son, in whom I am well pleased. Hear Him!"* MATTHEW 17:5

### TRUE OR FALSE:

1. "Now after six days Jesus took Peter, James, and John his brother, brought them up on a high mountain by themselves, and was transfigured before them..." MATTHEW 17:1-2  
TRUE OR FALSE
2. "And behold, Moses and Elijah appeared to them, talking with Him." MATTHEW 17:3  
TRUE OR FALSE
3. Then Peter answered and said to Jesus, "Lord, it is not good for us to be here..." MATTHEW 17:4  
TRUE OR FALSE

### CIRCLE THE CORRECT WORDS:

4. "While he was still speaking, behold, a bright cloud overshadowed them; and suddenly a (DOVE, VOICE) came out of the cloud, saying, 'This is My beloved Son, in whom I am well pleased. Hear Him!' " MATTHEW 17:5
5. "And when the disciples heard it, they fell on their faces and were greatly (INJURED, AFRAID)." MATTHEW 17:6

### TRUE OR FALSE:

6. "But Jesus came and touched them and said, 'Arise, and do not be afraid.'" MATTHEW 17:7  
TRUE OR FALSE
7. "And when they had lifted up their eyes, they saw no one but Jesus only." MATTHEW 17:8  
TRUE OR FALSE

### CIRCLE THE CORRECT WORDS:

8. "Now as they came down from the mountain, Jesus commanded them, saying, 'Tell the vision to (NO ONE, EVERYONE) until the Son of Man is risen from the dead.'" MATTHEW 17:9
9. "And His disciples asked Him, saying, 'Why then do the scribes say that (AMOS, ELIJAH) must come first?' " MATTHEW 17:10

### TRUE OR FALSE:

10. "Then Jesus answered and said to them, 'Elijah truly is coming first and will restore all things.'" MATTHEW 17:11  
TRUE OR FALSE
11. "Then the disciples understood that He spoke to them of John the Baptist." MATTHEW 17:13  
TRUE OR FALSE

# THE TRANSFIGURATION

## (MATTHEW 17:1-13)

### MEMORY VERSE:

*"This is My beloved Son, in whom I am well pleased. Hear Him!"* MATTHEW 17:5

### TRUE OR FALSE:

1. "Now after six days Jesus took Peter, James, and John his brother, brought them up on a high mountain by themselves, and was transfigured before them..." MATTHEW 17:1-2  
TRUE OR FALSE
2. "And behold, Moses and Elijah appeared to them, talking with Him." MATTHEW 17:3  
TRUE OR FALSE
3. Then Peter answered and said to Jesus, "Lord, it is not good for us to be here..." MATTHEW 17:4  
TRUE OR FALSE

### FILL IN THE BLANKS:

4. "While he was still speaking, behold, a bright cloud overshadowed them; and suddenly a \_\_\_\_\_ came out of the cloud, saying, 'This is My beloved Son, in whom I am well pleased. Hear Him!' " MATTHEW 17:5
5. "And when the disciples heard it, they fell on their faces and were greatly \_\_\_\_\_." MATTHEW 17:6

### TRUE OR FALSE:

6. "But Jesus came and touched them and said, 'Arise, and do not be afraid.'" MATTHEW 17:7  
TRUE OR FALSE
7. "And when they had lifted up their eyes, they saw no one but Jesus only." MATTHEW 17:8  
TRUE OR FALSE

### FILL IN THE BLANKS:

8. "Now as they came down from the mountain, Jesus commanded them, saying, 'Tell the vision to \_\_\_\_\_ until the Son of Man is risen from the dead.'" MATTHEW 17:9
9. "And His disciples asked Him, saying, 'Why then do the scribes say that \_\_\_\_\_ must come first?' " MATTHEW 17:10

### TRUE OR FALSE:

10. "Then Jesus answered and said to them, 'Elijah truly is coming first and will restore all things.'" MATTHEW 17:11  
TRUE OR FALSE
11. "Then the disciples understood that He spoke to them of John the Baptist." MATTHEW 17:13  
TRUE OR FALSE

# THE TRANSFIGURATION

(MATTHEW 17:1-13)

R P F A H Z T U M D T F D G B  
O D Y A S U H P O E G H H P O  
E J F Z C O H F S R B O Q C E  
C P Z T T E L Q E U G C B Q J  
I B E L O V E D S G A G K I L  
O D W U O W Z N S I L S Q J B  
V Q R S U S E J E F L M O Y N  
Z A G E L E R B H S V H I R Z  
N O S J T C L Q T N N E S O Z  
G F Z Q S E P C O A C Z E I Q  
E A T K T U P J L R B B M T B  
H A J I L E J Y C T B O A E B  
C H T M O U N T A I N B J H P  
J D J K R C Z C G B B V J I G  
B W G V B J Z T U B D R O L D

BELOVED  
CLOTHES  
ELIJAH  
FACE  
JAMES

JESUS  
JOHN  
LORD  
MOSES  
MOUNTAIN

PETER  
SON  
TRANSFIGURED  
VOICE

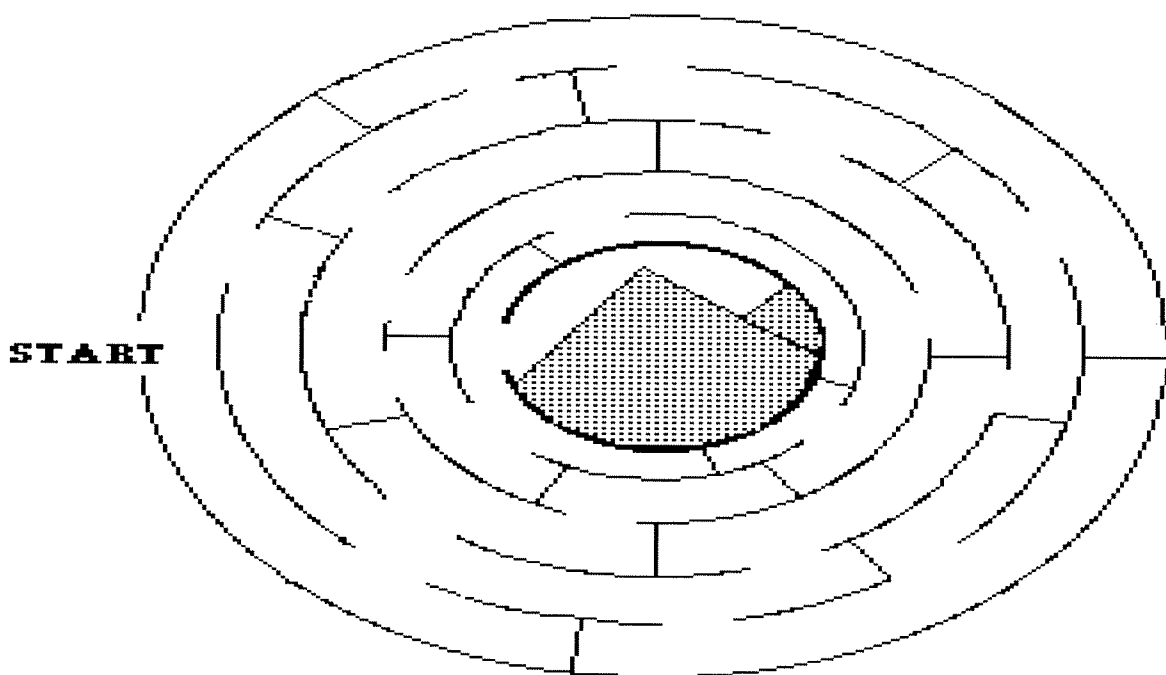

# THE TRANSFIGURATION

## (MATTHEW 17:1-13)

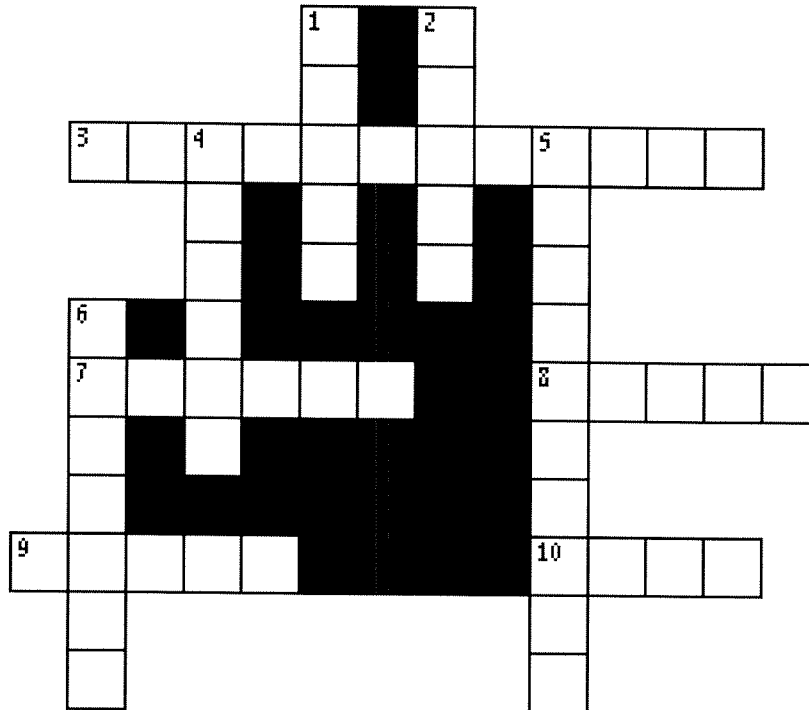

- 3 ACROSS "Now after six days Jesus took Peter, James, and John his brother, brought them up on a high mountain by themselves, and was \_\_\_\_\_ before them..." **MATTHEW 17:1-2**
- 9 ACROSS "And behold, \_\_\_\_\_ and Elijah appeared to them, talking with Him." **MATTHEW 17:3**
- 2 DOWN "While he was still speaking, behold, a bright cloud overshadowed them; and suddenly a \_\_\_\_\_ came out of the cloud, saying, 'This is My beloved Son, in whom I am well pleased. Hear Him!' " **MATTHEW 17:5**
- 4 DOWN "And when the disciples heard it, they fell on their faces and were greatly \_\_\_\_\_." **MATTHEW 17:6**
- 1 DOWN "But \_\_\_\_\_ came and touched them and said, 'Arise, and do not be afraid.'" **MATTHEW 17:7**
- 10 ACROSS "And when they had lifted up their eyes, they saw no one but Jesus \_\_\_\_\_." **MATTHEW 17:8**
- 8 ACROSS "Now as they came down from the mountain, Jesus commanded them, saying, 'Tell the vision to no one until the Son of Man is \_\_\_\_\_ from the dead.'" **MATTHEW 17:9**
- 7 ACROSS "And His disciples asked Him, saying, 'Why then do the scribes say that \_\_\_\_\_ must come first?' " **MATTHEW 17:10**
- 6 DOWN "Then Jesus answered and said to them, 'Elijah truly is coming first and will \_\_\_\_\_ all things.'" **MATTHEW 17:11**
- 5 DOWN "Then the disciples \_\_\_\_\_ that He spoke to them of John the Baptist." **MATTHEW 17:13**

# A Flash of Lightning

A flash of lightning may light up the entire sky. Jesus' clothes became as bright as a flash of lightning at his transfiguration. How are Jesus and a flash of lightning similar? Write the letter that comes between the two letters given to discover the light of Jesus.

\_\_\_\_ KM HJ FH GI SU MO HJ MO FH \_\_\_\_ KM HJ FH GI SU RT

\_\_\_\_ TV OQ \_\_\_\_ SU GI DF \_\_\_\_ RT JL XZ \_\_\_\_ VX GI HJ KM DF

\_\_\_\_ IK DF RT TV RT \_\_\_\_ KM HJ FH GI SU RT \_\_\_\_ TV OQ

\_\_\_\_ NP TV QS \_\_\_\_ GI DF ZB QS SU RT \_\_\_\_ IK DF RT TV RT

\_\_\_\_ HJ RT \_\_\_\_ SU GI DF \_\_\_\_ KM HJ FH GI SU

\_\_\_\_ SU GI ZB SU \_\_\_\_ FH TV HJ CE DF RT

\_\_\_\_ TV RT \_\_\_\_ SU NP \_\_\_\_ NP TV QS

\_\_\_\_ GI DF ZB UW DF MO KM XZ \_\_\_\_ GI NP LN DF





# Jesus' Transfiguration

Luke 9:28-36

About eight days after \_\_\_\_\_ said this, he took \_\_\_\_\_ and \_\_\_\_\_ with him and went up onto a \_\_\_\_\_ to pray. As he was praying, the \_\_\_\_\_ of his face \_\_\_\_\_, and his clothes became as \_\_\_\_\_ as a flash of lightning. Two men, \_\_\_\_\_ and \_\_\_\_\_, appeared in \_\_\_\_\_ splendor, talking with Jesus. They \_\_\_\_\_ about his \_\_\_\_\_, which he was about to \_\_\_\_\_ to fulfillment at \_\_\_\_\_.

Peter and his companions were very \_\_\_\_\_, but when they became fully \_\_\_\_\_, they saw his glory and the two men \_\_\_\_\_ with him. As the men were \_\_\_\_\_ Jesus, Peter said to him, "\_\_\_\_\_, it is good for us to be \_\_\_\_\_. Let us put up \_\_\_\_\_ shelters—one for you, \_\_\_\_\_ for Moses and one for Elijah." (He did not know \_\_\_\_\_ he was saying.)

While he was speaking, a \_\_\_\_\_ appeared and \_\_\_\_\_ them, and they were \_\_\_\_\_ as they entered the cloud. A \_\_\_\_\_ came from the cloud, saying, "\_\_\_\_\_ is my \_\_\_\_\_, whom I have \_\_\_\_\_; listen to him." When the voice had spoken, they \_\_\_\_\_ that Jesus was alone. The \_\_\_\_\_ kept this to themselves, and \_\_\_\_\_ no one at that time what they had seen.

S R B R I G H T H A J I L L E  
 G G D N U O F N S E S O M Q  
 L N P R E T E P L E R H T U E  
 O I D J L S K E A N D I N G  
 R R I T O I S T V H E P K A H  
 I B S H J H J T V I E P O I H  
 O D C I E H N A I E P O I H  
 U L L I S R C G H N R E L P I H  
 S O P F S U E N W G E L P N C  
 D T L C S A B A Z J E S U S  
 V D E P A R T U R E V X Y W  
 D O S S L S O N K S E M A J  
 U O I N E M L S T E R J P G E  
 O I H C M A S T E R J E P Y  
 L F D B E M I T S L E K A W  
 C A F R A I D C A E K A W . A



## Year 3

### Week 131

#### The Good Samaritan

**Scriptures: Luke 10:25-37**

**Key Verse: Luke 10:27: “You shall love the Lord thy God with all your heart, and with all your soul, and with all your strength, and with you’re your mind, and thy neighbor as yourself.”**

#### **Key Points:**

1. A lawyer was questioning Jesus about what it took to inherit eternal life. When Jesus asked him what the law says, he quoted the old law, saying to love the Lord with all your heart, soul, strength and mind, and to love your neighbor as yourself.
2. Jesus said this was correct, and that he did well to follow these commandments. The lawyer then asked who his neighbor was. Jesus then told the story of the Good Samaritan.
3. A man traveling was attacked by thieves, beaten and robbed. While he was lying half dead on the road, a priest and a Levite passed by on the opposite side of the road. A Samaritan, whose people are not liked by the Jews, stopped, bound up his wounds, and took him to the inn.
4. When he left the inn the next morning, he left money for his care, and told the innkeepers that he would pay any additional costs when he returned.
5. Jesus then asked the lawyer which of these three men was a neighbor to the man that fell among the thieves.
6. The lawyer answered the one that cared for him. Jesus told him to go and do likewise.

# The Good Samaritan

(Luke 10:25-37)

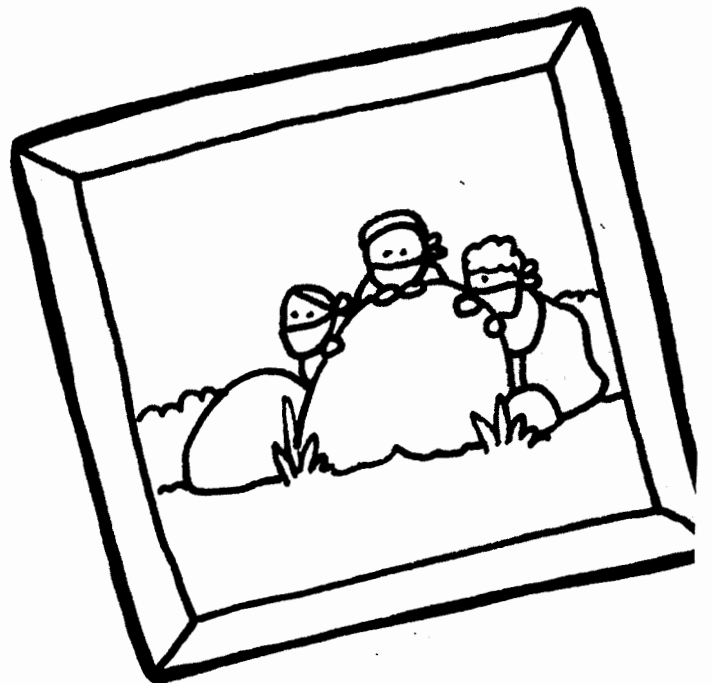
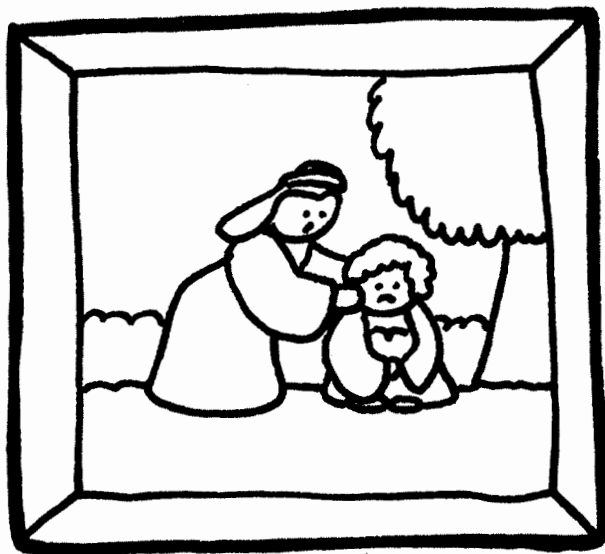
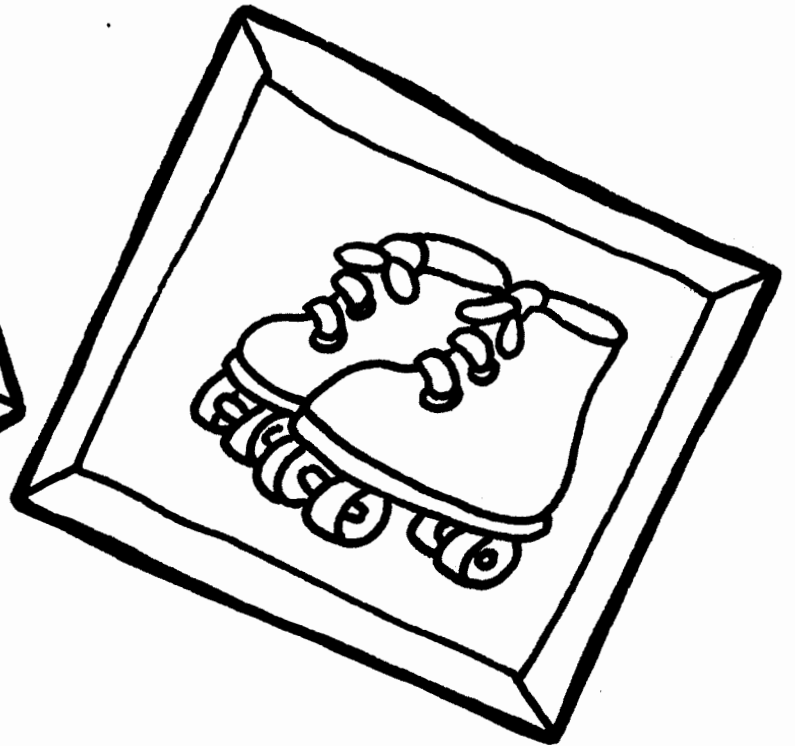
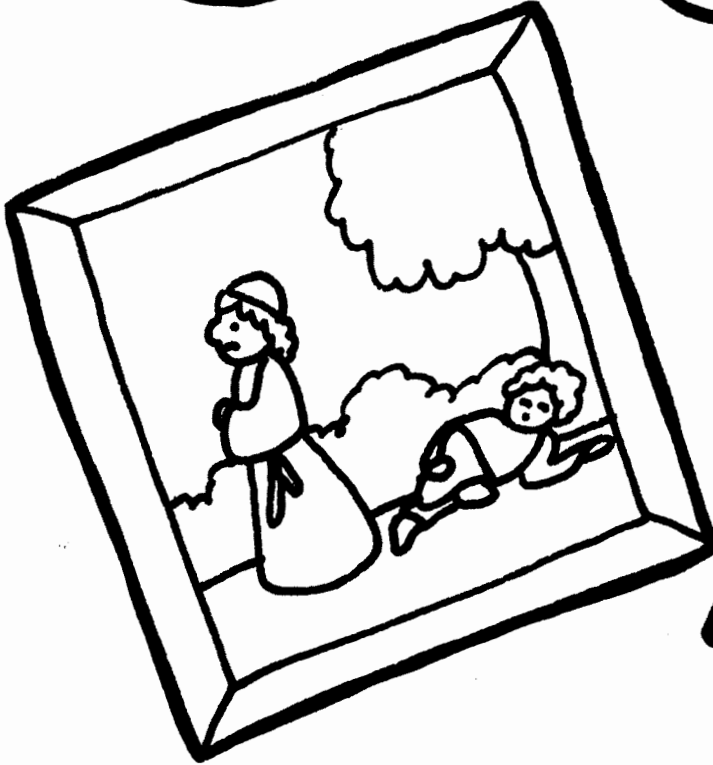

Circle the picture that does not belong.

# 49. The Good Samaritan

Read the story of the Good Samaritan in Luke 10:25–37. The following words are taken from that passage. Fit the words into the crossword puzzle.

DO

GO

ALL

LAW

GOD

OIL

INN

TWO

LIFE

LOVE

SIDE

SOUL

DEAD

BOUND

BEAST

PENCE

MERCY

LAWYER

PRIEST

LEVITE

WOUNDS

LOOKED

THIEVES

RAIMENT

JERUSALEM

NEIGHBOUR

COMPASSION

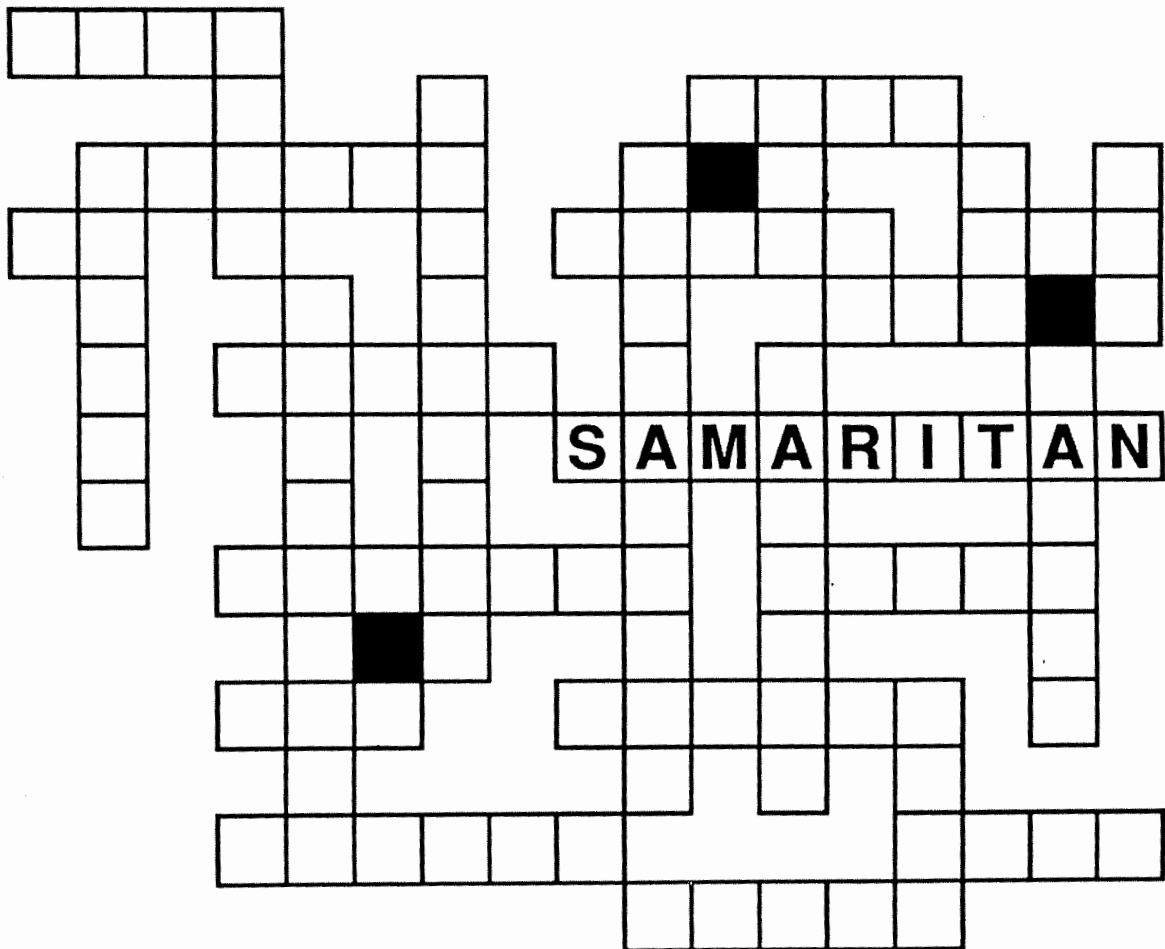



"The good Samaritan has compassion on the man who had been beaten."  
*Luke 10:25-37*

# THE GOOD SAMARITAN

## (LUKE 10:25-37)

### MEMORY VERSE:

*"Blessed are the merciful, for they shall obtain mercy. Blessed are the pure in heart, for they shall see God."* MATTHEW 5:7-8

### TRUE OR FALSE:

1. "And behold, a certain lawyer stood up and tested Him, saying, 'Teacher, what shall I do to inherit eternal life?' " **LUKE 10:25**

TRUE OR FALSE

*Jesus told this parable...*

### FILL IN THE BLANKS:

2. "...A certain man went down from Jerusalem to Jericho, and fell among \_\_\_\_\_, who stripped him of his clothing, wounded him, and departed, leaving him half dead." **LUKE 10:30**
3. "Now by chance a certain \_\_\_\_\_ came down that road. And when he saw him, he passed by on the other side." **LUKE 10:31**
4. "Likewise a \_\_\_\_\_, when he arrived at the place, came and looked, and passed by on the other side." **LUKE 10:32**
5. "But a certain \_\_\_\_\_, as he journeyed, came where he was. And when he saw him, he had compassion on him." **LUKE 10:33**

### TRUE OR FALSE:

6. "...and went to him and bandaged his wounds, pouring on oil and wine; and he set him on his own animal, brought him to an inn, and took care of him." **LUKE 10:34**

TRUE OR FALSE

7. On the next day, he told the innkeeper, "I have done all I am going to do for this man." **LUKE 10:35**

TRUE OR FALSE

### FILL IN THE BLANKS:

8. "So which of these three do you think was \_\_\_\_\_ to him who fell among the thieves?" **LUKE 10:36**

9. "And he said, 'He who showed mercy on him.' Then Jesus said to him, 'Go and do \_\_\_\_\_.'" **LUKE 10:37**

# To Love and to Help



help



people



man



Israel

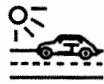

road



clothes































priest



donkey



love

Jesus told stories to   learn. Here is one of Jesus' stories. A  from  was walking on a . Some robbers came. They beat up the . They tore his . Then they left him lying by the . Soon a  came. The  saw the hurt  lying by the . The  did not . Then a 's  er came. The 's  er did not . A third  came. This  was not from . He was a neighbor. He saw the hurt . He cleaned the hurt 's wounds. Then he put the hurt  on his  and took him to an inn. "Take care of him," he said. "I will pay you." What did Jesus want  to learn from this story? To  and  their neighbors.

# Code-A-Gram

Each letter has a number that takes its place. To decode the secret message, match the numbers with their letters. Write the letters on the lines above the numbers.

A	B	C	D	E	F	G	H	I
1	21	13	16	2	14	20	7	3
J	K	L	M	N	O	P	Q	R
12	18	11	6	19	4	9	25	8
S	T	U	V	W	X	Y	Z	
10	24	5	17	15	23	22	26	

12 2 10 5 10

15 1 19 24 10

5 10

24 4

10 7 4 15

11 4 17 2

21 22

21 2 3 19 20

18 3 19 16

24 4

9 2 4 9 11 2

15 7 4

19 2 2 16

7 2 11 9



Unscramble the letters to find the words in our

# Good Samaritan Anagram



beghinor \_\_\_\_\_

ejnoruy \_\_\_\_\_

bbeorry \_\_\_\_\_

deginor \_\_\_\_\_

aaaimnrst \_\_\_\_\_

deehlp \_\_\_\_\_

emnoy \_\_\_\_\_

acimnoopss \_\_\_\_\_

abeent \_\_\_\_\_

eehrt \_\_\_\_\_

# A Good Neighbor

Read Luke 10:29-37 and answer the questions. Circle the letter of each correct answer. Find the spaces in section 1 that contain the same letter as the answer to the question #1, and color them in. Do the same with the other three sections.

1. A man was going to Jericho when he fell into whose hands?
  - a. hermits
  - b. robbers
  - c. soldiers
2. A priest passed by the man. Who else passed by?
  - a. a merchant
  - b. a Jew
  - c. a Levite
3. Who took pity on the man?
  - a. a Samaritan
  - b. an innkeeper
  - c. the governor
4. Which of the three was a neighbor to the hurt man?
  - a. the priest
  - b. the Levite
  - c. the Samaritan

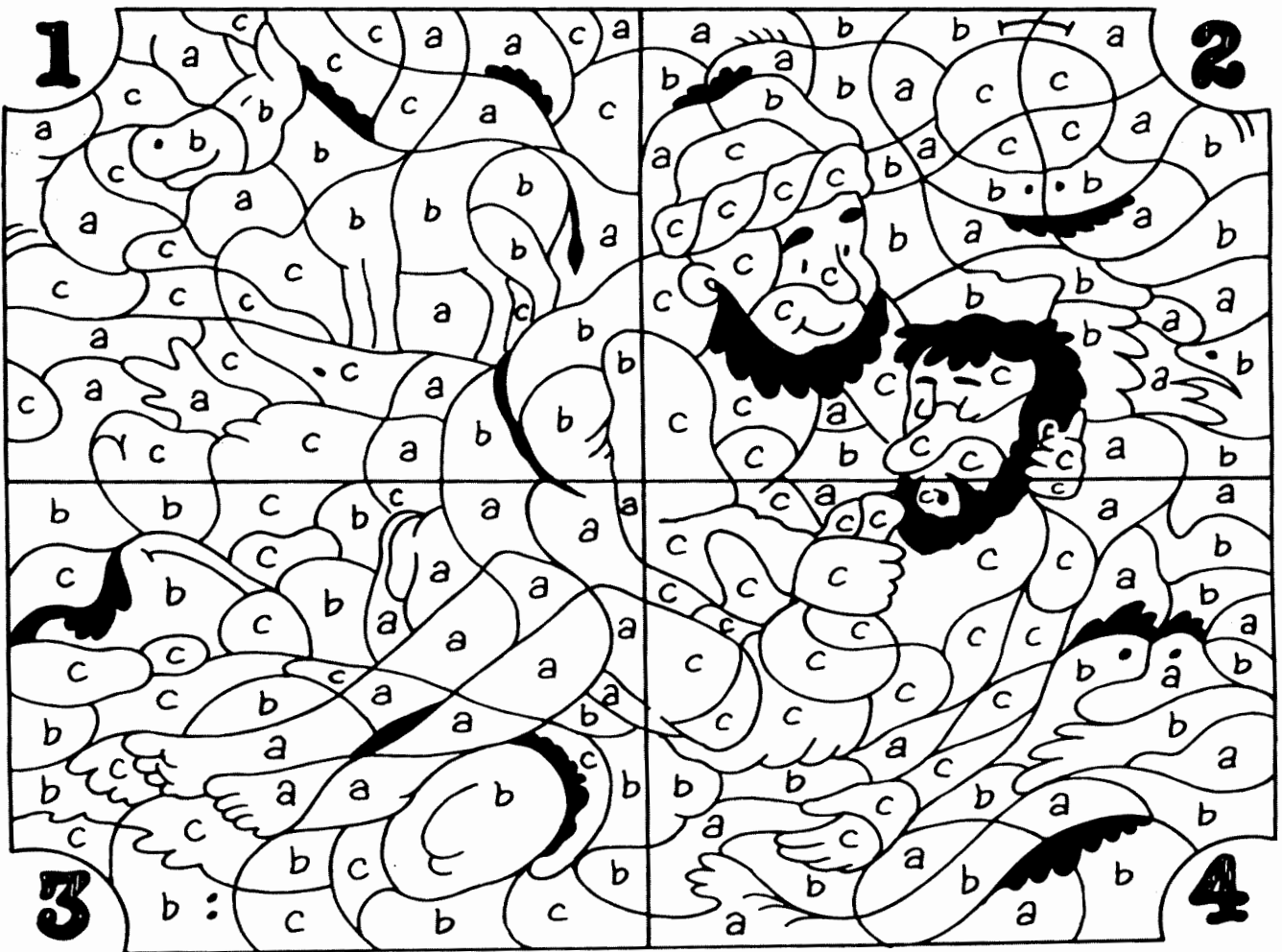

**The Good Samaritan**  
**Luke 10:25-37**

# Who Is My Neighbor?

The teachers of the law knew that they were supposed to love God and their neighbors. They were trying to test Jesus when they asked, "Who is my neighbor?" To answer them, Jesus told the story of "The Good Samaritan."

Follow the path that the man took from Jerusalem to Jericho. Every time you come to a capital letter, write that letter in the spaces below. When you are finished, you will know who your neighbor is.



**START**

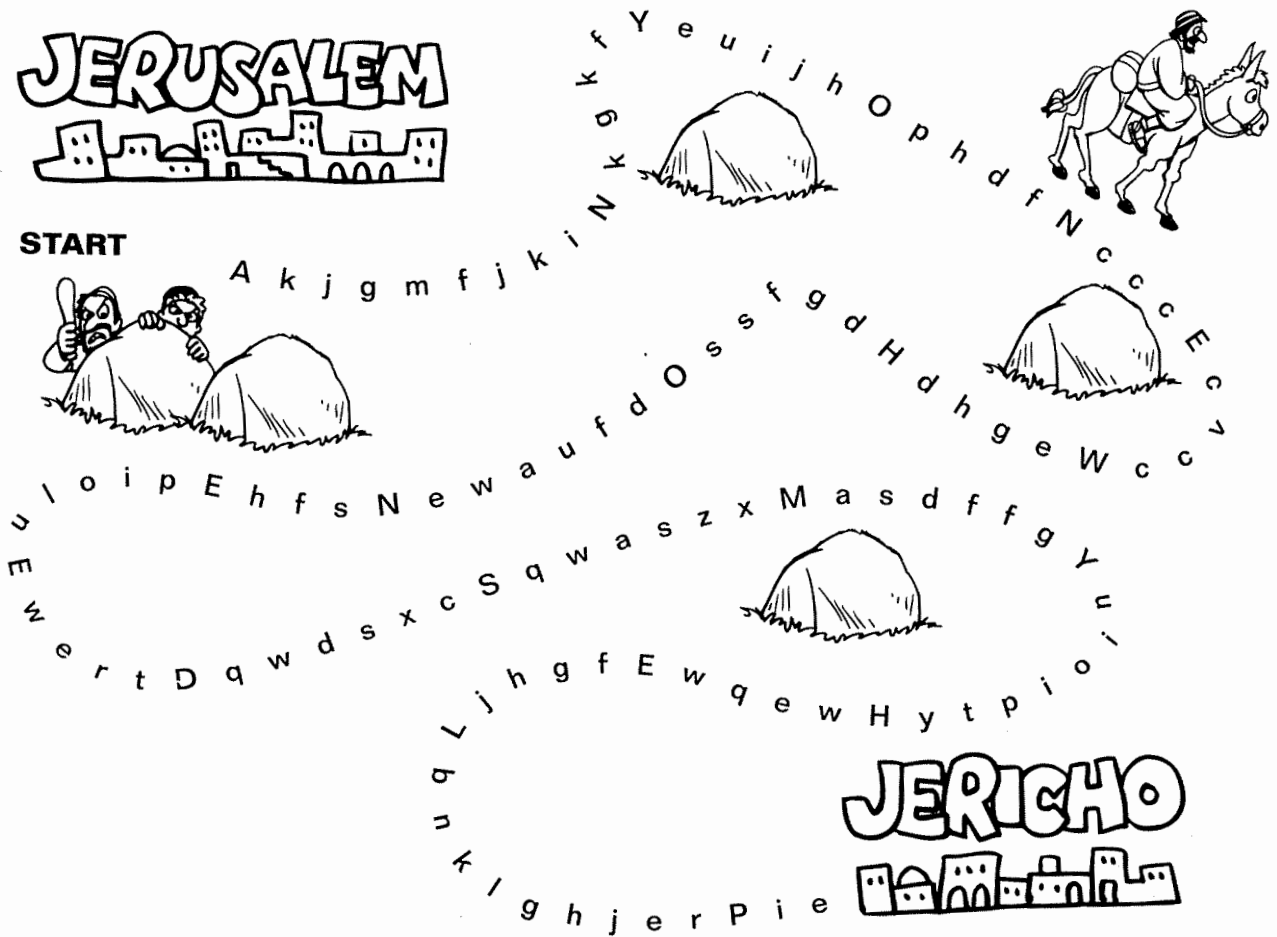

# THE GOOD SAMARITAN

## LUKE 10: 30-37

- 1) THE MAN WHO ASKED JESUS THE QUESTION. A \_\_\_\_\_.
- 2) JESUS TOLD HIM TO \_\_\_\_\_ THE LAW.
- 3) THE LAWYER WONDERED WHAT HE COULD \_\_\_\_\_ TO INHERIT ETERNAL LIFE.
- 4) HE ASKED \_\_\_\_\_ MORE QUESTION, "WHO IS MY NEIGHBOR?"
- 5) JESUS \_\_\_\_\_ USING A PARABLE.
- 6) A MAN WENT \_\_\_\_\_ FROM JERUSALEM TO JERICHO.
- 7) THIS MAN WAS BEATEN AND ROBBED AND LEFT \_\_\_\_\_.
- 8) HE WAS ALMOST \_\_\_\_\_.
- 9) A PRIEST AND A LEVITE WALKED BY AND \_\_\_\_\_ STOP TO HELP HIM.
- 10) A SAMARITAN \_\_\_\_\_ PITY ON HIM.
- 11) HE \_\_\_\_\_ TREATED THE INJURED MAN.
- 12) "I WILL PUT \_\_\_\_\_ ON MY DONKEY," THE SAMARITAN SAID.
- 13) THE SAMARITAN PUT THE WOUNDED MAN \_\_\_\_\_ HIS CARE.
- 14) HE FOUND \_\_\_\_\_ AT AN INN.
- 15) THE INNKEEPER WAS \_\_\_\_\_ TO CARE FOR THE MAN.
- 16) THE SAMARITAN \_\_\_\_\_.
- 17) WHO DID YOU \_\_\_\_\_ WAS THE NEIGHBOR IN THIS PARABLE?

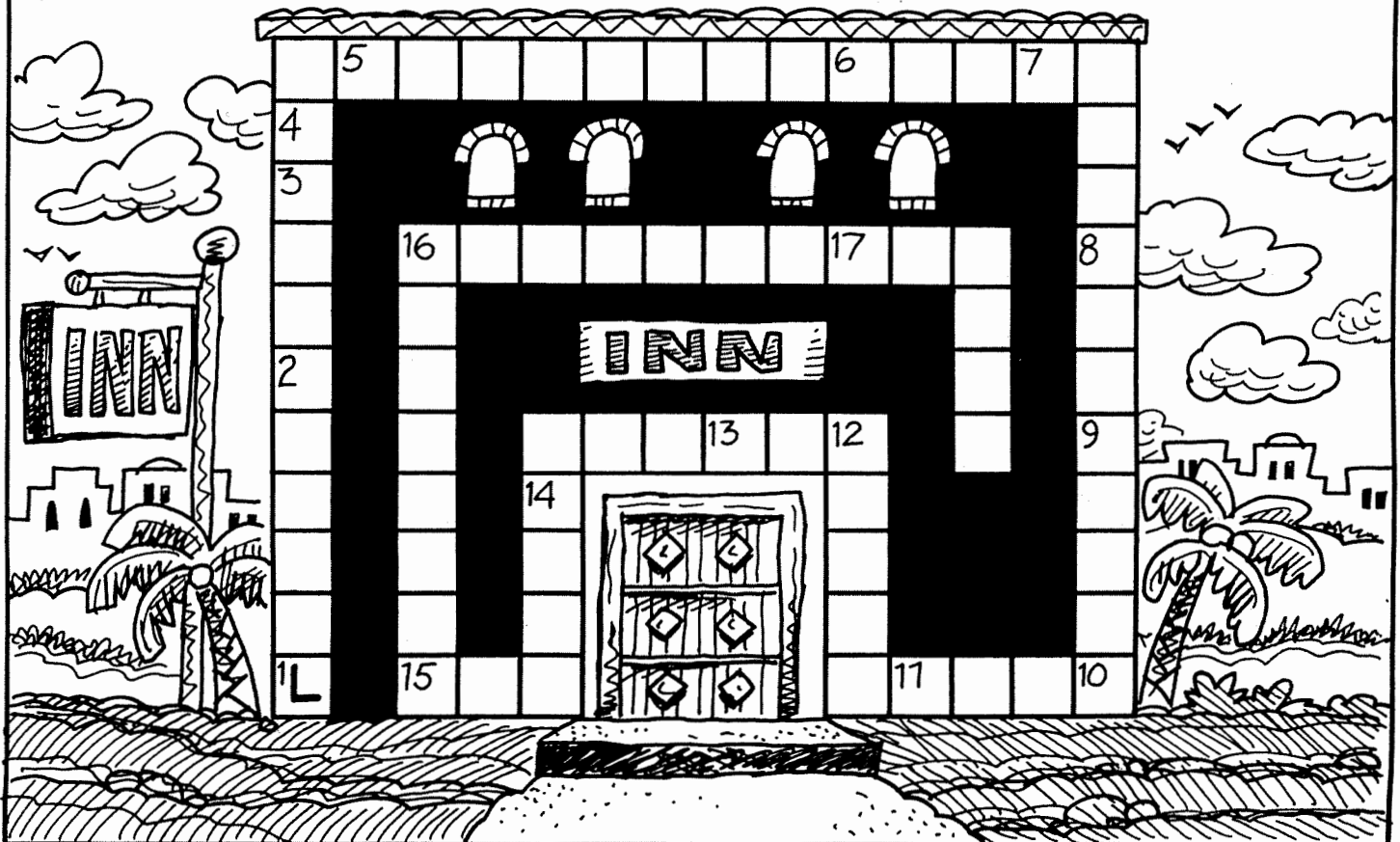

# Memory Verse...

First and Second Grade

**"Blessed are the merciful, for they shall obtain mercy."**

Third Grade and Above

**"Blessed are the merciful, for they shall obtain mercy. Blessed are the pure in heart, for they shall see God."**

**Matthew 5:7-8**

## **Year 3**

### **Week 132**

#### **Mary and Martha/Rich Farmer – Putting First Things First**

**Scriptures: Luke 10:38-42, 12:13-41**

**Key Verse: Luke 12:31: “But seek the kingdom of God, and all these things shall be added unto you.”**

#### **Key Points:**

1. As Jesus was traveling, He entered the home of Martha and Mary. Mary sat at the feet of the Savior and listened to His teaching, while Martha was busy with much serving and preparations.

2. When Martha asked Jesus to tell Mary to help her with the chores, Jesus answered her that while Martha was full of care for many things, Mary had chosen the one thing that was needful, and she must not be scolded for that.

3. While Jesus was teaching to the multitudes, people began to question him concerning matters of money. Jesus told them to take care not to become too worried about money.

4. Jesus tells the story of the rich farmer, who when he had an abundant harvest, thought to tear down his barns and build bigger barns to store the fruits of his labor in. He congratulated himself and decided to eat, drink, and be merry.

5. However, God called him a fool, and told him that his soul would be required of him for not giving God the glory for his success.

6. Jesus preaches about many money matters to the multitudes, teaching them to not worry about material things, for God will care for His own, and to be good stewards of the things that God has given to us. He finishes His teachings by telling the multitudes to be prepared, for no one knows the day or the hour that the Lord will return.



# JESUS VISITS MARY AND MARTHA

(LUKE 10:38-42)

Q	Q	E	C	M	Y	R	Z	Y	D	I	P	B	F	Q
G	F	Q	T	P	I	C	V	N	E	L	U	P	Z	B
Y	T	G	B	M	A	B	B	B	D	Q	M	D	W	B
R	N	A	N	H	W	R	O	J	E	S	J	J	G	V
N	A	N	D	W	Z	R	T	J	E	Z	Y	P	Z	H
G	B	D	C	V	L	N	A	T	N	G	B	R	T	S
W	T	O	Y	H	M	V	O	U	H	I	O	D	A	T
R	I	B	N	V	O	N	D	B	E	K	J	Q	T	M
E	T	D	T	E	O	S	H	O	G	W	R	A	J	O
B	L	L	T	N	H	O	E	N	O	B	O	F	G	L
S	K	H	S	I	A	L	I	N	A	G	Z	A	A	S
A	A	V	F	C	S	H	B	G	T	N	G	H	Z	T
T	W	G	B	B	T	O	W	J	E	K	E	D	T	R
T	Q	L	Y	N	B	B	B	V	H	C	C	W	U	B
E	I	J	Z	Z	D	Z	K	N	D	H	J	Y	J	Z

FIND THE WORDS OF THE VERSE BELOW IN THE PUZZLE ABOVE

**"BUT ONE THING IS NEEDED, AND MARY HAS CHOSEN THAT GOOD PART" LUKE 10:42**

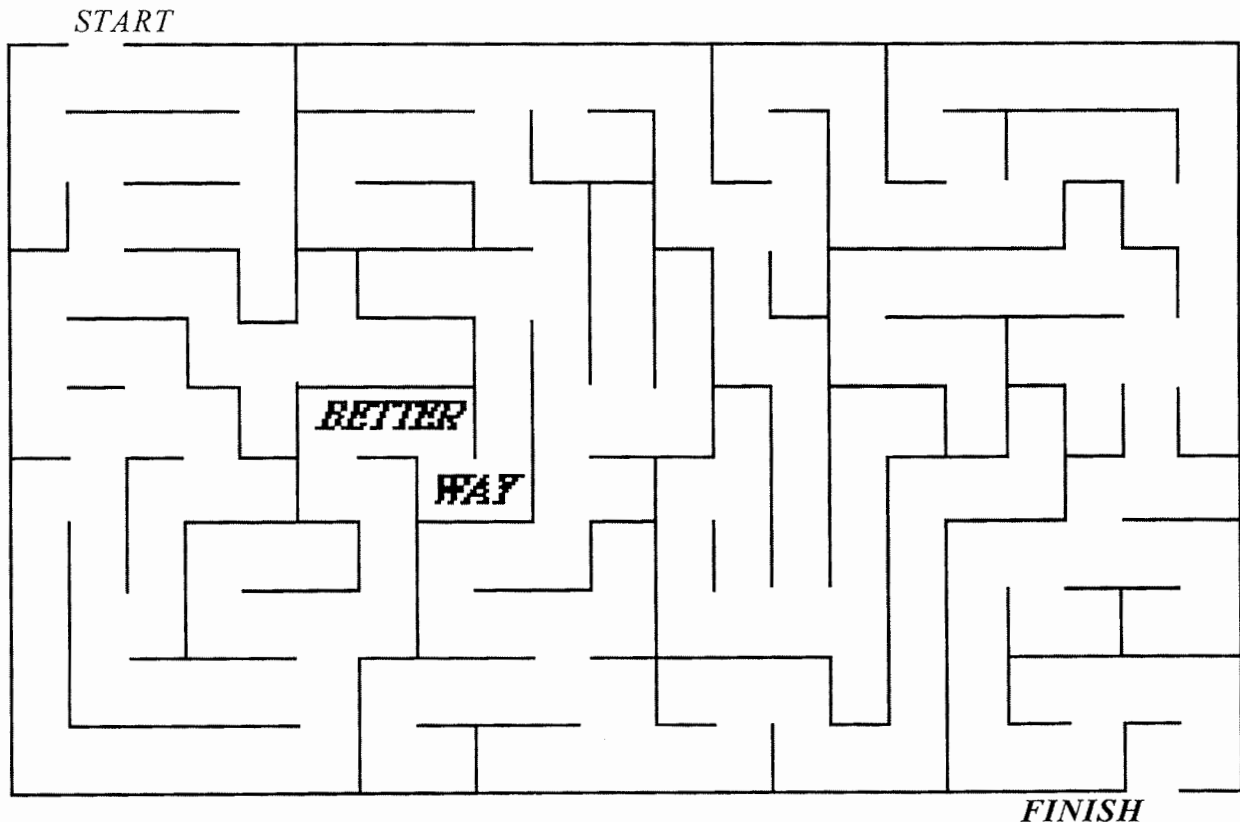



# What Did Martha Open?

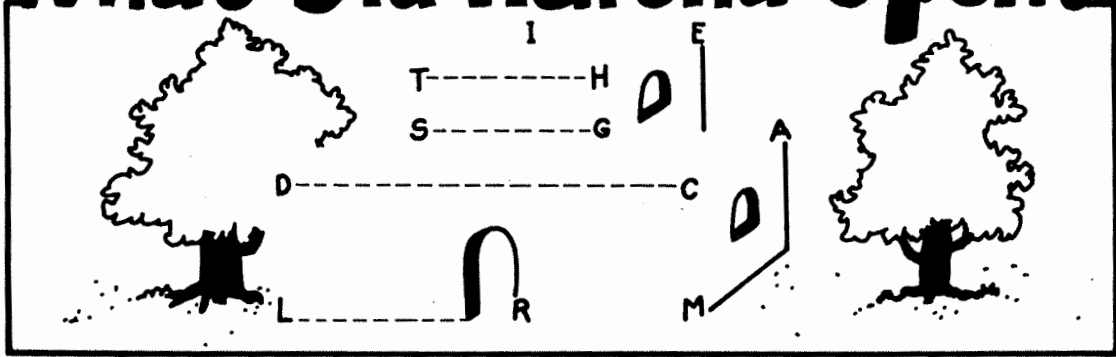

Read Luke 10:38-42; Romans 10:17; 15:4. Answer the questions below with the most correct word from the list.

1. At whose feet did Mary sit? \_\_\_\_\_
2. Martha was worried and \_\_\_\_\_.
3. Mary \_\_\_\_\_ to Jesus.
4. Faith comes from \_\_\_\_\_ the message.
5. Everything that was written in the past was written to \_\_\_\_\_ us.
6. Who did the better thing: Martha, Mary, or the disciples? \_\_\_\_\_

Ⓜ a Ⓡ y

T e ⓐ c h

L i s t e n e d

ⓗ e l p

U p s e t

Ⓣ a l k e d

ⓗ e a r i n g

T h e Ⓛ o r d ' s

Ⓜ a r t h a ' s

Now complete the picture above by drawing a line from the first circled letter in answer 1 to the following circled letter and so on through answer 6. The picture you draw is the answer to the title question.

# JESUS VISITS MARY AND MARTHA

(LUKE 10:38-42)

## MEMORY VERSE:

"Give unto the LORD the glory due to His name; worship the LORD in the beauty of holiness." PSALM 29:2

## TRUE OR FALSE:

1. "...He entered a certain village; and a certain woman named Martha welcomed Him into her house." **LUKE 10:38**

**TRUE OR FALSE**

2. "And she had a sister called Mary, who also sat at Jesus' feet and heard His word." **LUKE 10:39**

**TRUE OR FALSE**

## FILL IN THE BLANK:

3. "But Martha was distracted with \_\_\_\_\_ serving..." **LUKE 10:40**

## TRUE OR FALSE:

4. "...and she approached Him and said, 'Lord, do You not care that my sister has left me to serve alone?' " **LUKE 10:40**

**TRUE OR FALSE**

## FILL IN THE BLANK:

5. "...Therefore tell her to \_\_\_\_\_ me." **LUKE 10:40**

## TRUE OR FALSE:

6. And Jesus answered and said to her, "Martha, Martha, you are never worried or troubled." **LUKE 10:41**

**TRUE OR FALSE**

7. "...But one thing is needed, and Mary has chosen that good part, which will not be taken away from her." **LUKE 10:42**

**TRUE OR FALSE**

# JESUS VISITS MARY AND MARTHA

## (LUKE 10:38-42)

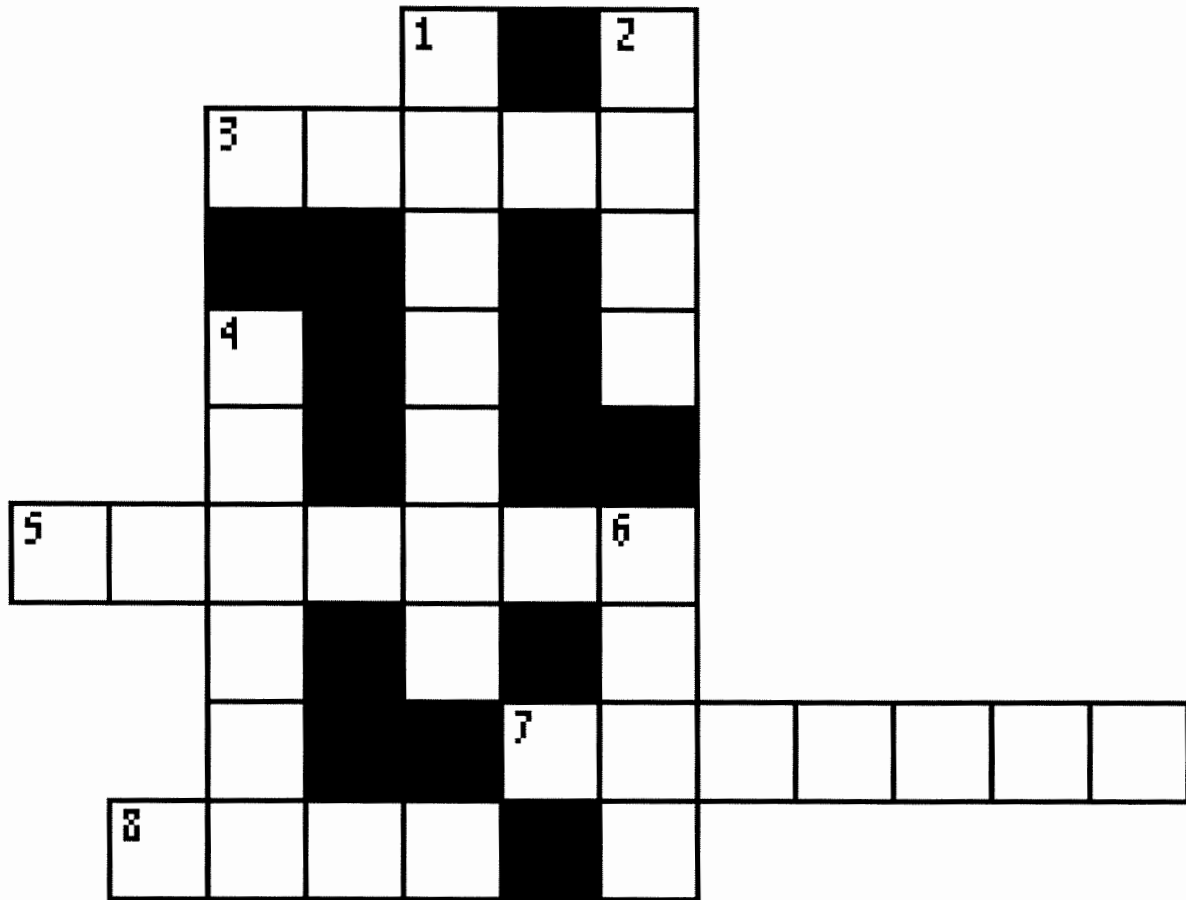

- 1 DOWN "Give unto the LORD the glory due to His name; \_\_\_\_\_ the LORD in the beauty of holiness." **PSALM 29:2**
- 4 DOWN "...He entered a certain village; and a certain woman named \_\_\_\_\_ welcomed Him into her house." **LUKE 10:38**
- 8 ACROSS "And she had a sister called \_\_\_\_\_, who also sat at Jesus' feet and heard His word." **LUKE 10:39**
- 5 ACROSS "But Martha was distracted with much \_\_\_\_\_." **LUKE 10:40**
- 3 ACROSS "...and she approached Him and said, 'Lord, do You not care that my sister has left me to serve \_\_\_\_\_?'" **LUKE 10:40**
- 2 DOWN "...Therefore tell her to \_\_\_\_\_ me." **LUKE 10:40**
- 7 ACROSS "And Jesus answered and said to her, 'Martha, Martha, you are \_\_\_\_\_ and troubled about many things.'" **LUKE 10:41**
- 6 DOWN "...But one thing is needed, and Mary has chosen that \_\_\_\_\_ part, which will not be taken away from her." **LUKE 10:42**

Jesus Warns  
Against  
Selfishness  
Luke 12:13-21

# Who Has Told You...

don't be \_\_\_\_\_ !

Jesus taught an important lesson in Luke 12:13-21. It's a lesson that our parents want us to learn too. Use your Bible to fill in the missing words from the story. Then take the letters in the boxes and put them on the spaces above.

There was a rich man who had some land, which  \_\_\_\_\_ a good crop of food.

"What will I do? I have no place to keep all my  \_\_\_\_\_. I will

\_\_\_\_\_ down my barns and build bigger ones! Then I can say to myself, I have

enough good things \_\_\_\_\_  \_\_\_\_\_ to last for many years. Rest, eat,

\_\_\_\_\_, and enjoy life!" But God said to that man, "Foolish man!

Tonight you will die. So who will get those things

you have prepared for

\_\_\_\_\_?"

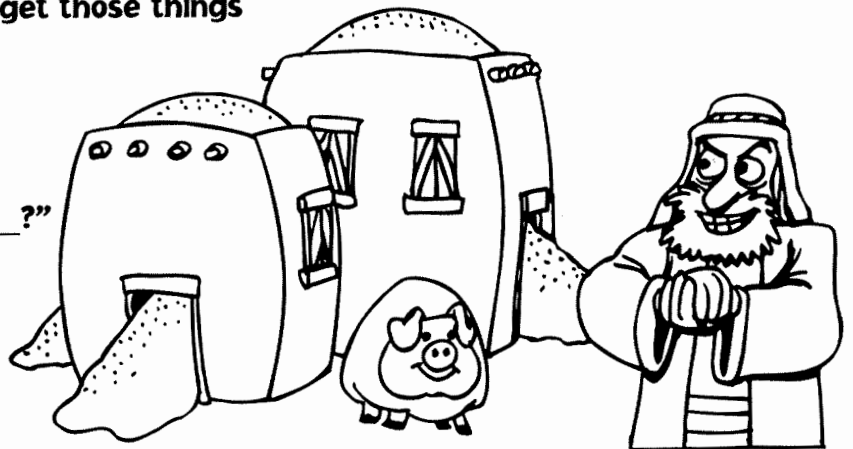

# 50. The Foolish Rich Man

Jesus told a parable about a rich man who had more crops than he had storage room. He wanted to keep everything for himself, so he decided to build bigger barns. That way he wouldn't have to work as hard the next year. All he could think about was keeping everything (his treasures) for himself.

Starting at the arrow, cross out every other letter in the barn. Write the remaining letters down to find out what Jesus taught about treasures (Matt. 6:19-21).

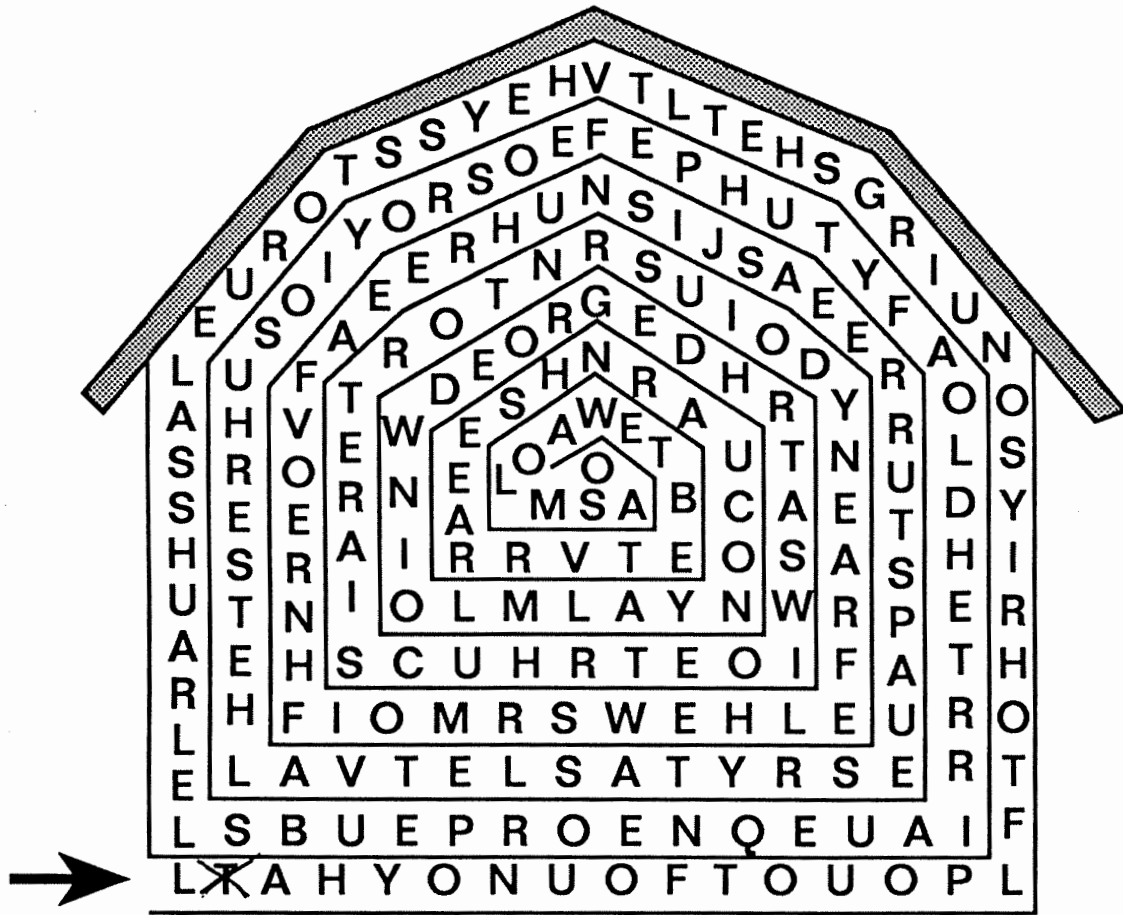

---

---

---

---

---

---

---

---

# Rich Man

Read Luke 12:16-21. Start with chain #1 and follow the line of letters to find the first word. Write the word in the first blank. Fill in the other words to find out what happened to the rich man.

“But God said to him, ‘You \_\_\_\_\_ 1 ! This very \_\_\_\_\_ 2 your \_\_\_\_\_ 3 will be \_\_\_\_\_ 4 from you. Then \_\_\_\_\_ 5 will \_\_\_\_\_ 6 what you have \_\_\_\_\_ 7 for \_\_\_\_\_ 8?’” “This is how it will be with anyone who \_\_\_\_\_ 9 up things for \_\_\_\_\_ 10 but is not \_\_\_\_\_ 11 \_\_\_\_\_ 12 \_\_\_\_\_ 13.” Luke 12:20, 21

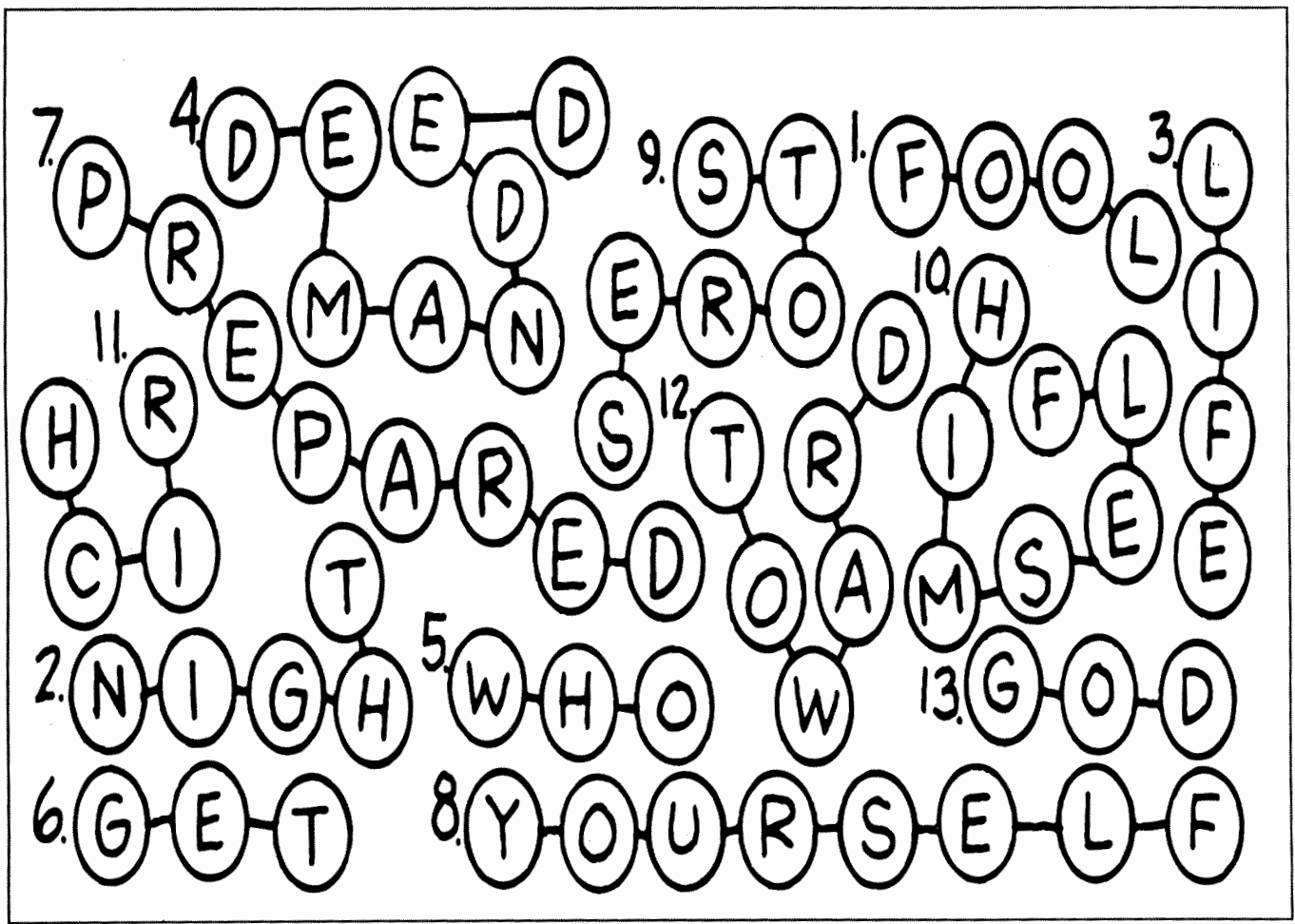

# Do Not Worry

## LUKE 12:22-34

- 1) DO NOT WORRY ABOUT YOUR \_\_\_\_\_.
- 2) DO NOT WORRY ABOUT WHAT YOU WILL \_\_\_\_\_.
- 3) LIFE IS MORE \_\_\_\_\_ FOOD.
- 4) WE SHOULD \_\_\_\_\_ THE RAVEN.
- 5) GOD GIVES THEM \_\_\_\_\_ TO EAT.
- 6) \_\_\_\_\_ MUCH MORE VALUABLE YOU ARE THAN BIRDS.
- 7) \_\_\_\_\_ WILL NOT ADD AN HOUR TO YOUR LIFE.
- 8) CONSIDER HOW THE LILIES \_\_\_\_\_.
- 9) \_\_\_\_\_ KING SOLOMON WAS NOT DRESSED IN SUCH SPLENDOR.
- 10) GOD WILL TAKE CARE OF \_\_\_\_\_ NEED.
- 11) DO NOT SET \_\_\_\_\_ HEART ON FOOD OR DRINK.
- 12) THE PAGAN WORLD \_\_\_\_\_ AFTER SUCH THINGS.
- 13) \_\_\_\_\_ HIS \_\_\_\_\_.
- 14) SEEK TREASURE THAT NO \_\_\_\_\_ DESTROYS.
- 15) SEEK A TREASURE IN \_\_\_\_\_.
- 16) THIS TREASURE WILL \_\_\_\_\_ BE EXHAUSTED.
- 17) WHERE YOUR \_\_\_\_\_ IS, YOUR HEART WILL BE ALSO.

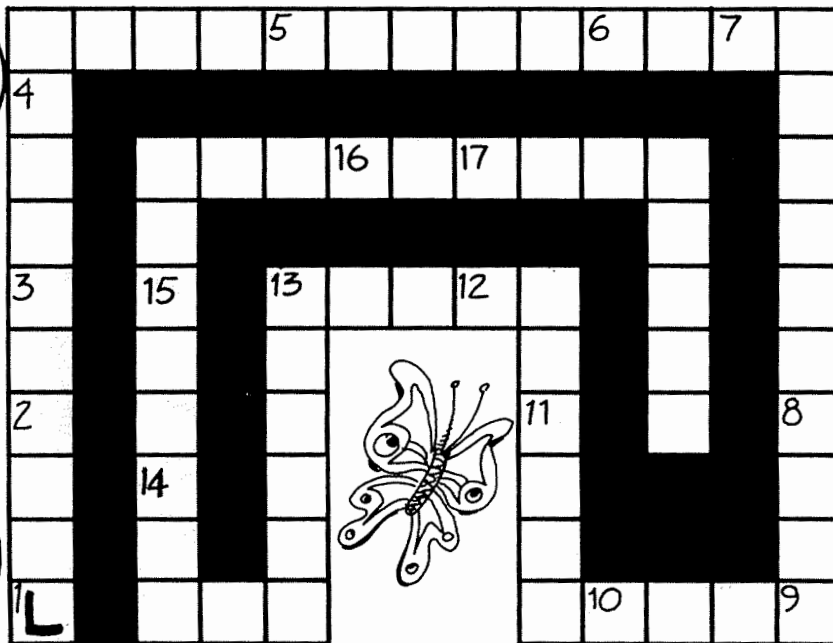

# Memory Verse...

First and Second Grade

**"Worship the LORD in the beauty of holiness."**

Third Grade and Above

**"Give unto the LORD the glory due to His name; Worship the LORD in the beauty of holiness."**

**Psalm 29:2**





The Greedy Farmer  
*Luke 12*

## Year 3

### Week 133

#### The Prodigal Son

**Scriptures: Luke 15:11-32**

**Key Verse: Luke 15:32: “It is right that we should make merry and be glad, for your brother was dead and is alive again, was lost and is found.”**

#### **Key Points:**

1. Jesus spoke again to His followers in a parable, telling the story of a man who had two sons. The younger son asked for his share of his inheritance and, when he had received it, traveled to a far away county and spent all his money in wasteful living.
2. When he was all out of money, there was a famine in the land, and the son went to work for a man, feeding his swine. The son was so hungry, he wished to eat the food that was fed to the pigs.
3. When he came to himself, he thought to himself that the servants in his father’s house were better off than he was, and that he would go to his father and beg forgiveness, and ask to work for him. So he began to travel towards home.
4. And while he was still a long way off, his father saw him, and rejoiced, and ran to meet him. After the son had asked his forgiveness, the father dressed him in a robe, put a ring on his finger, and shoes on his feet, and had a great feast prepared for him.
5. When the older son learned of all the festivities, he was angry and refused to come in. His father explained to him that what was lost had been found.

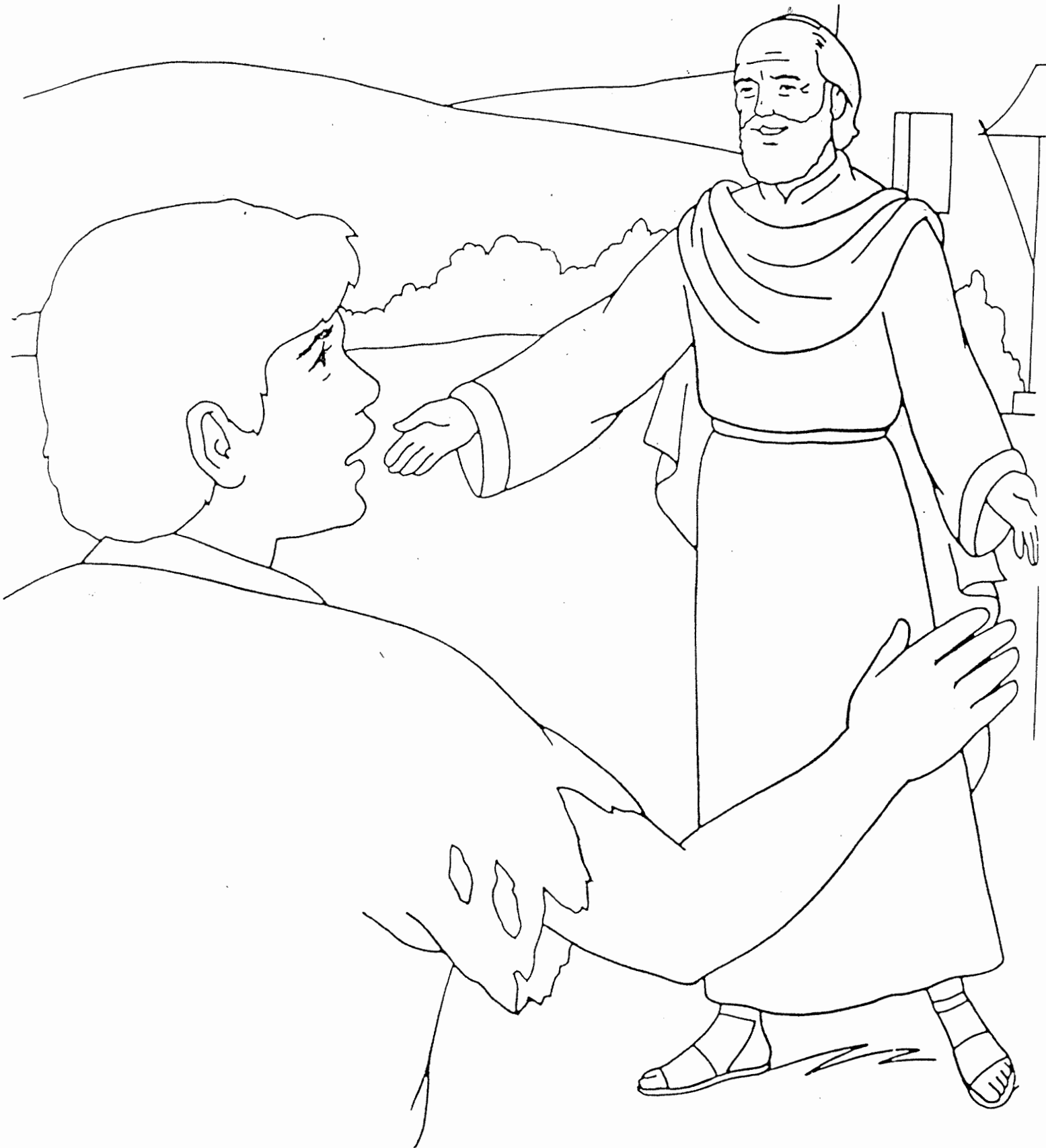

The younger son was sorry he had left home.  
He went back to his father and said, "I'm sorry."  
The father was happy that his son came back because he loved  
his son very much.

*Luke 15:11-24*



# The Prodigal Son

READ LUKE 15:11-31 AND NUMBER THE PICTURES IN THEIR PROPER ORDER.

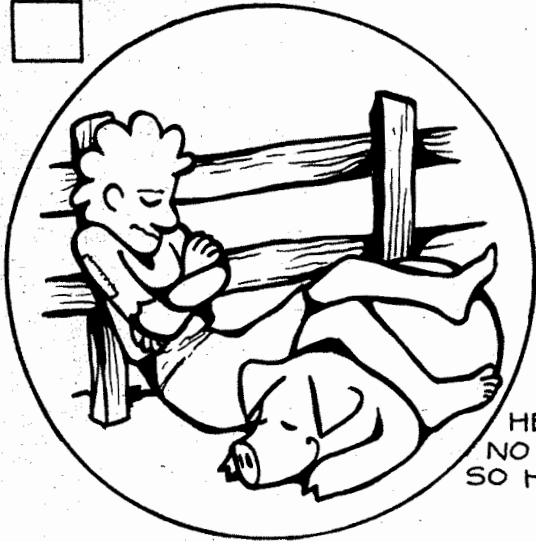

HE COULD FIND  
NO WHERE TO LIVE  
SO HE ATE AND SLEPT  
WITH PIGS.

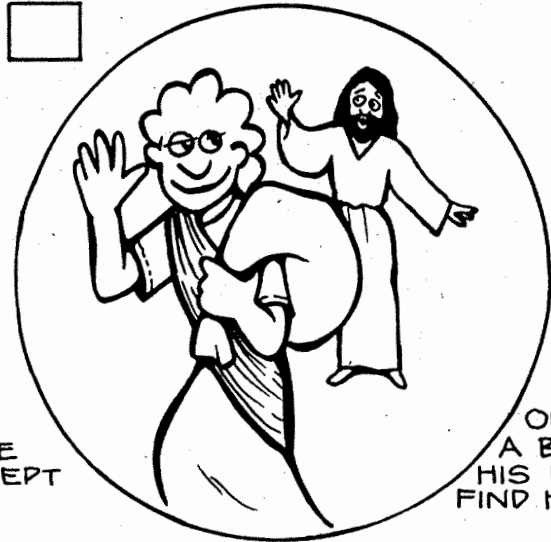

ONE DAY  
A BOY LEFT  
HIS FATHER TO  
FIND HIS FORTUNE



BUT SOON THE  
BOY RAN OUT OF  
MONEY AND ALL  
OF HIS FRIENDS  
DESERTED HIM.

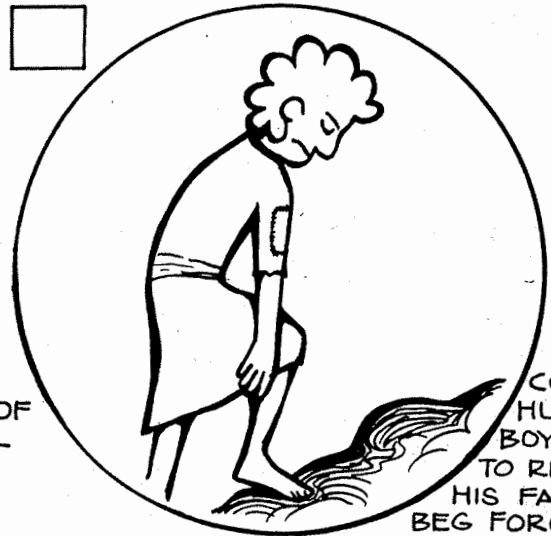

COLD AND  
HUNGRY, THE  
BOY DECIDED  
TO RETURN TO  
HIS FATHER AND  
BEG FORGIVENESS.



WHEN HE GOT  
HOME, HIS FATHER  
HUGGED HIM AND SAID,  
"YOU ARE MY SON, I HAVE  
ALREADY FORGIVEN YOU!"

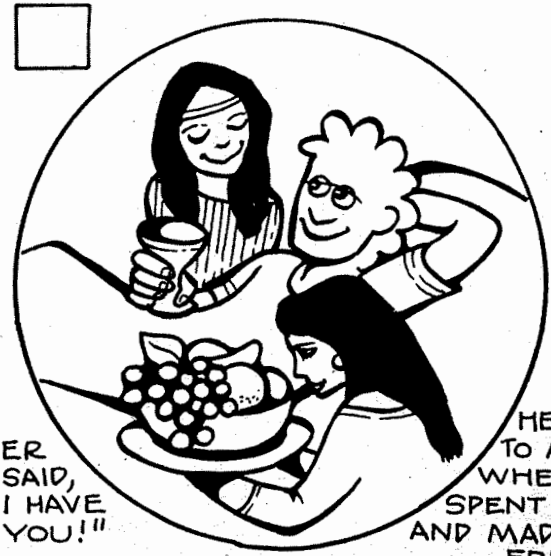

HE TRAVELED  
TO A BIG CITY  
WHERE HE  
SPENT HIS MONEY  
AND MADE LOTS OF  
FRIENDS.

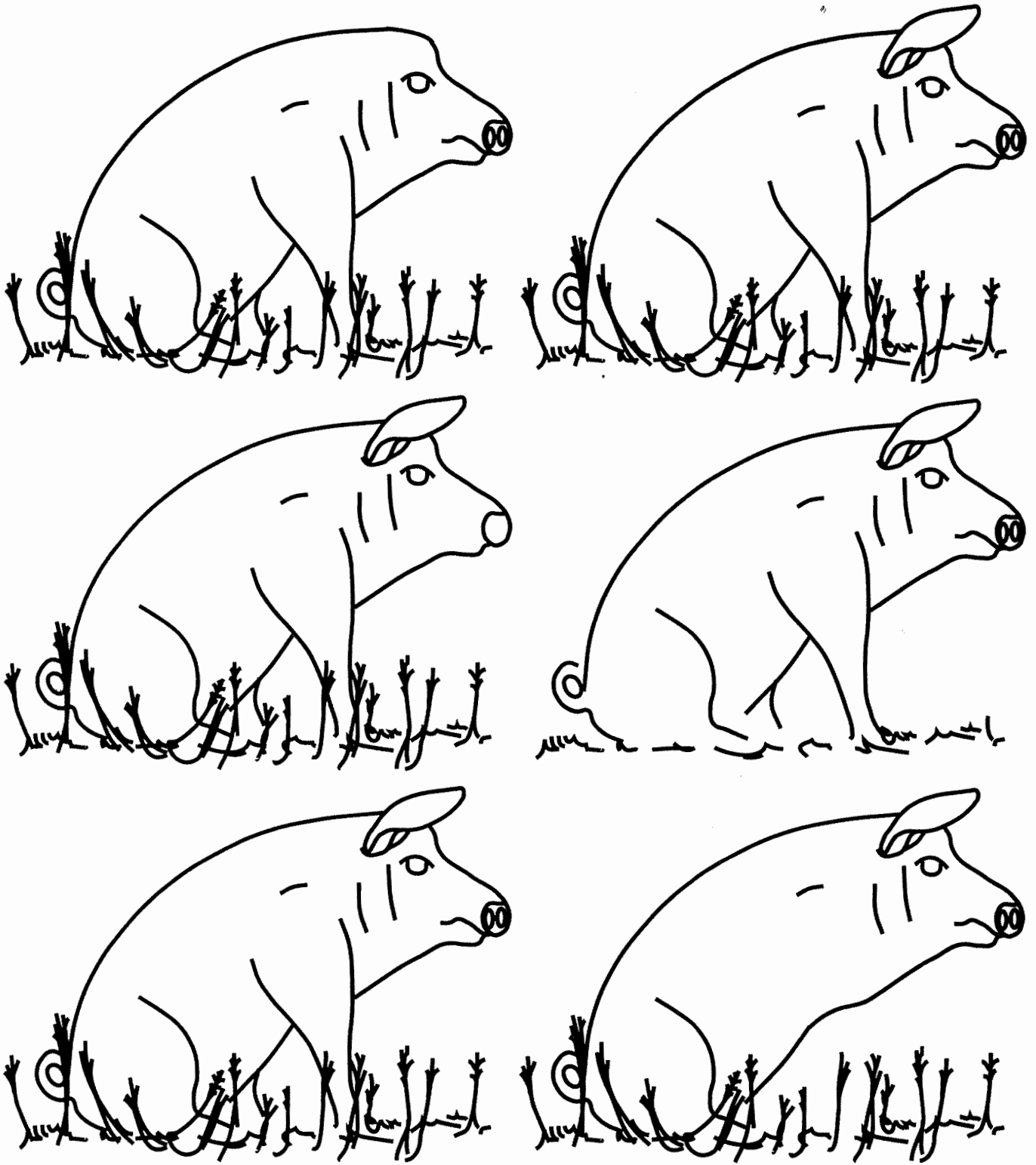

A young man left home. He took all his money. He spent his money. Soon he was hungry. He got a job. His job was to feed pigs. He was so hungry he would eat pig food. He said, "I will go home." Luke 15:15

# Lost and Found

Identify the pictures below. Starting with picture #1, write the first and last letters of the words you filled in on the blanks below to find what the father did when his lost son came home. Read Luke 15:11-32 to find out more.

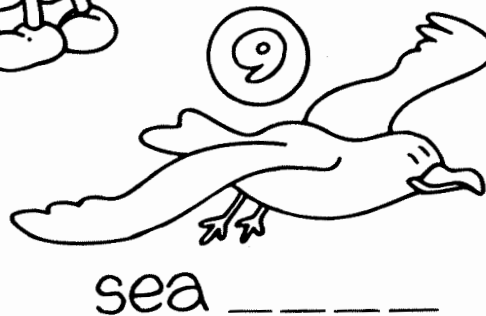
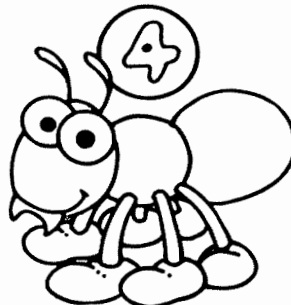
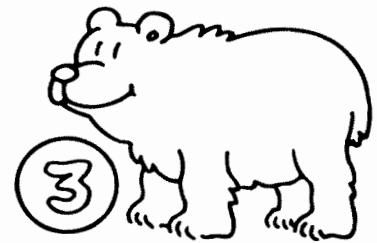
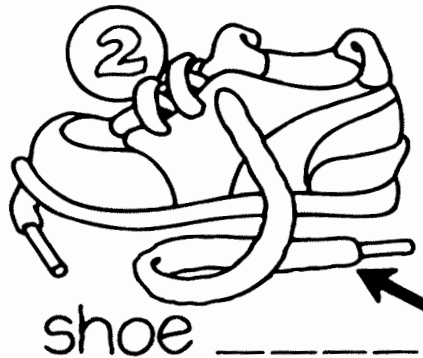
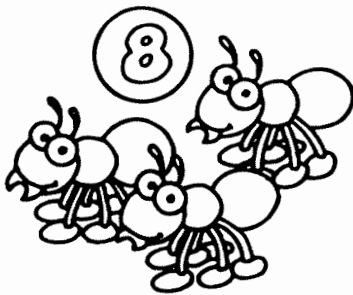
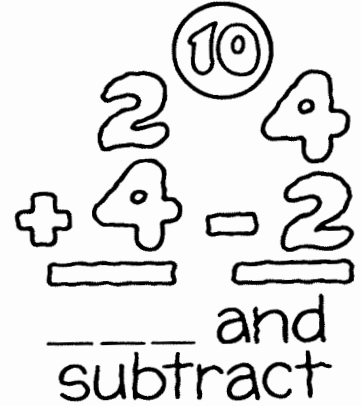
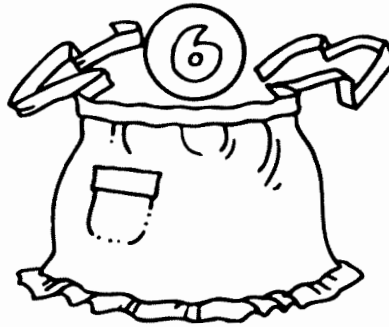

\_\_\_\_\_

\_\_\_\_\_

# THE PRODIGAL SON

(LUKE 15:11-32)

C H O K C H M E W F H U E U W  
P Y B Y Z Q I Z B A U P Z A W  
Q O Y A R U O S Y B S W S D Y  
B F N B D D A E D R Y C A W Z  
V D D Z N W B Q L B J P N E U  
L G S M Y I K V N E N R D E G  
I Q I U Y F A L D F O R L B F  
J C H F Q U E G C W D O I D Y  
C F T J Q M Y S A G S F I V I  
J C G S H N E R V T F O U N D  
I S I U E H V S O F Y M D N F  
N J C B F V I B S Z I E Z P B  
H O B K O S L B K A B T P Y L  
L K S B I L A Z L N L L Z G A  
Q V E D H B T F D S O M V N E

FIND THE WORDS OF THE VERSE BELOW IN THE PUZZLE ABOVE

***"For this my son was dead and is alive again; he was lost and is found."***

**LUKE 15:24**

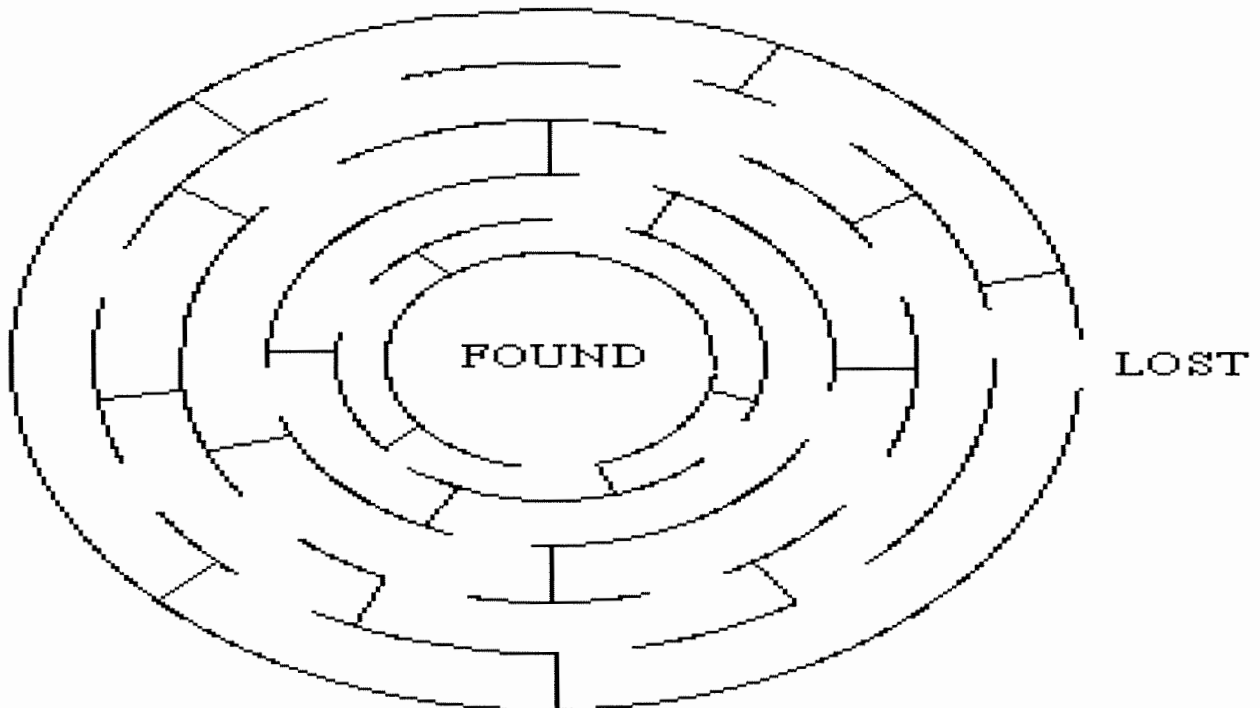



# THE PRODIGAL SON

## (LUKE 15:11-32)

### MEMORY VERSE:

"...for this my son was dead and is alive again; he was lost and is found..." LUKE 15:24

*A certain man had two sons...*

### TRUE OR FALSE:

1. "And the younger of them said to his father, 'Father, give me the portion of goods that fall to me.' So he divided to them his livelihood." LUKE 15:12

TRUE OR FALSE

2. "...the younger son gathered all together, journeyed to a far country, and there wasted his possessions with prodigal living." LUKE 15:13

TRUE OR FALSE

### FILL IN THE BLANKS:

3. "But when he had spent \_\_\_\_\_, there arose a severe famine in that land, and he began to be in want." LUKE 15:14

4. "Then he went and joined himself to a citizen of that country, and he sent him into his fields to feed \_\_\_\_\_." LUKE 15:15

### TRUE OR FALSE:

5. "...no one gave him anything." LUKE 15:16

TRUE OR FALSE

### FILL IN THE BLANKS:

6. "I will arise and go to my father, and will say to him, 'Father, I have sinned against heaven and before you, and I am no longer worthy to be called your \_\_\_\_\_. Make me like one of your hired servants.'" LUKE 15:18-19

7. "And he arose and came to his father. But when he was still a great way off, his father saw him and had compassion, and \_\_\_\_\_ and fell on his neck and kissed him." LUKE 15:20

8. "But the father said to his servants, 'Bring out the best robe and put it on him, and put a ring on his hand and sandals on his feet. And bring the fatted calf here and kill it, and let us eat and be merry; for this my son was \_\_\_\_\_ and is \_\_\_\_\_ again; he was lost and is found.'..." LUKE 15:22-24

### TRUE OR FALSE:

9. "Now his older son was in the field. And as he came and drew near to the house, he heard music and dancing. So he called one of the servants and asked what these things meant." LUKE 15:25-26

TRUE OR FALSE

10. And he was excited and went in. LUKE 15:28

TRUE OR FALSE

### FILL IN THE BLANKS:

11. "And he said to him, 'Son, you are always with me, and all that I have is yours. It was right that we should make merry and be glad, for your brother was dead and is alive again, and was \_\_\_\_\_ and is \_\_\_\_\_.'" LUKE 15:31-32

# THE PRODIGAL SON

## (LUKE 15:11-32)

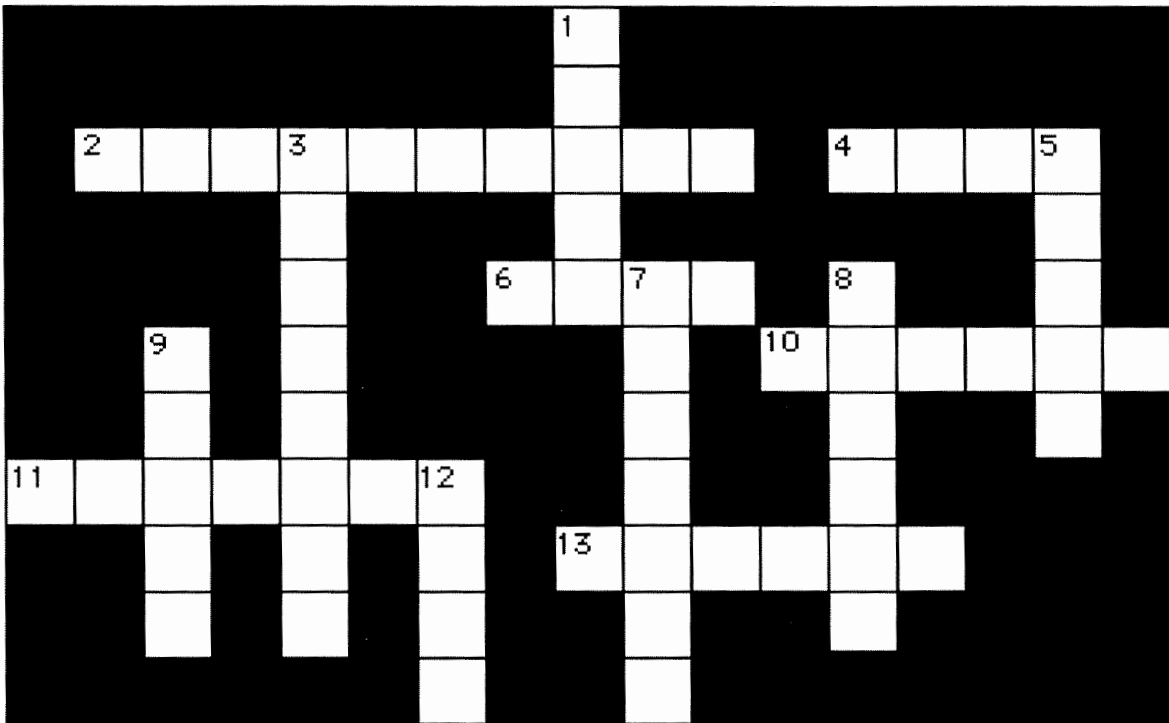

- 4 ACROSS "A certain man had two \_\_\_\_." **LUKE 15:11**
- 11 ACROSS The \_\_\_\_ son gathered all together and journeyed to a far country. **LUKE 15:13**
- 3 DOWN There he wasted his possessions with \_\_\_\_ living. **LUKE 15:13**
- 10 ACROSS "But when he had spent all, there arose a severe \_\_\_\_ in that land." **LUKE 15:14**
- 5 DOWN He was sent to the fields to feed \_\_\_\_\_. **LUKE 15:15**
- 13 ACROSS He said to himself, "I will arise and go to my \_\_\_\_\_." **LUKE 15:18**
- 2 ACROSS "When he was still a great way off, his father saw him and had \_\_\_\_\_." **LUKE 15:20**
- 6 ACROSS "The father said to his servants, 'Bring out the \_\_\_\_\_ robe and put it on him.'" **LUKE 15:22**
- 12 DOWN "Put a \_\_\_\_\_ on his hand." **LUKE 15:22**
- 7 DOWN "And \_\_\_\_\_ on his feet." **LUKE 15:22**
- 8 DOWN "Bring the \_\_\_\_\_ calf here and kill it, and let us eat and be merry." **LUKE 15:23**
- 1 DOWN "For this my son was dead and is \_\_\_\_\_ again." **LUKE 15:24**
- 9 DOWN "He was lost and is \_\_\_\_\_." **LUKE 15:24**

# THE PRODIGAL SON

WORD ON WORD PUZZLE

LUKE 15:11-32

- 1) A MAN HAD TWO \_\_\_\_\_.
- 2) THE YOUNGER SON WANTED HIS \_\_\_\_\_ OF THE INHERITANCE.
- 3) HIS FATHER GAVE HIM \_\_\_\_\_ HE ASKED FOR.
- 4) HE \_\_\_\_\_ TIRED OF HIS HOME AND MOVED TO ANOTHER COUNTRY.
- 5) THE YOUNG MAN SOON \_\_\_\_\_ HIS MONEY IN A SINFUL LIFE.
- 6) HE WAS HUNGRY AND IN GREAT \_\_\_\_\_.
- 7) HE HAD TO TAKE A JOB FEEDING THE \_\_\_\_\_.
- 8) THE YOUNG MAN WANTED TO \_\_\_\_\_ HIS SINFUL WAYS.
- 9) HE \_\_\_\_\_ TO RETURN HOME.
- 10) THE YOUNGER SON LEFT WITHOUT \_\_\_\_\_.
- 11) "I HAVE SINNED AGAINST \_\_\_\_\_," HE TOLD HIS FATHER.
- 12) "I AM \_\_\_\_\_ TO BE YOUR SON," HE ADDED.
- 13) " \_\_\_\_\_ ARE ALIVE, LET US CELEBRATE," REJOICED HIS FATHER.
- 14) "LET \_\_\_\_\_ EAT AND MAKE MERRY."
- 15) THE YOUNGER SON WAS GIVEN NEW \_\_\_\_\_ AND A ROBE.
- 16) THE \_\_\_\_\_ PREPARED A WONDERFUL FEAST.

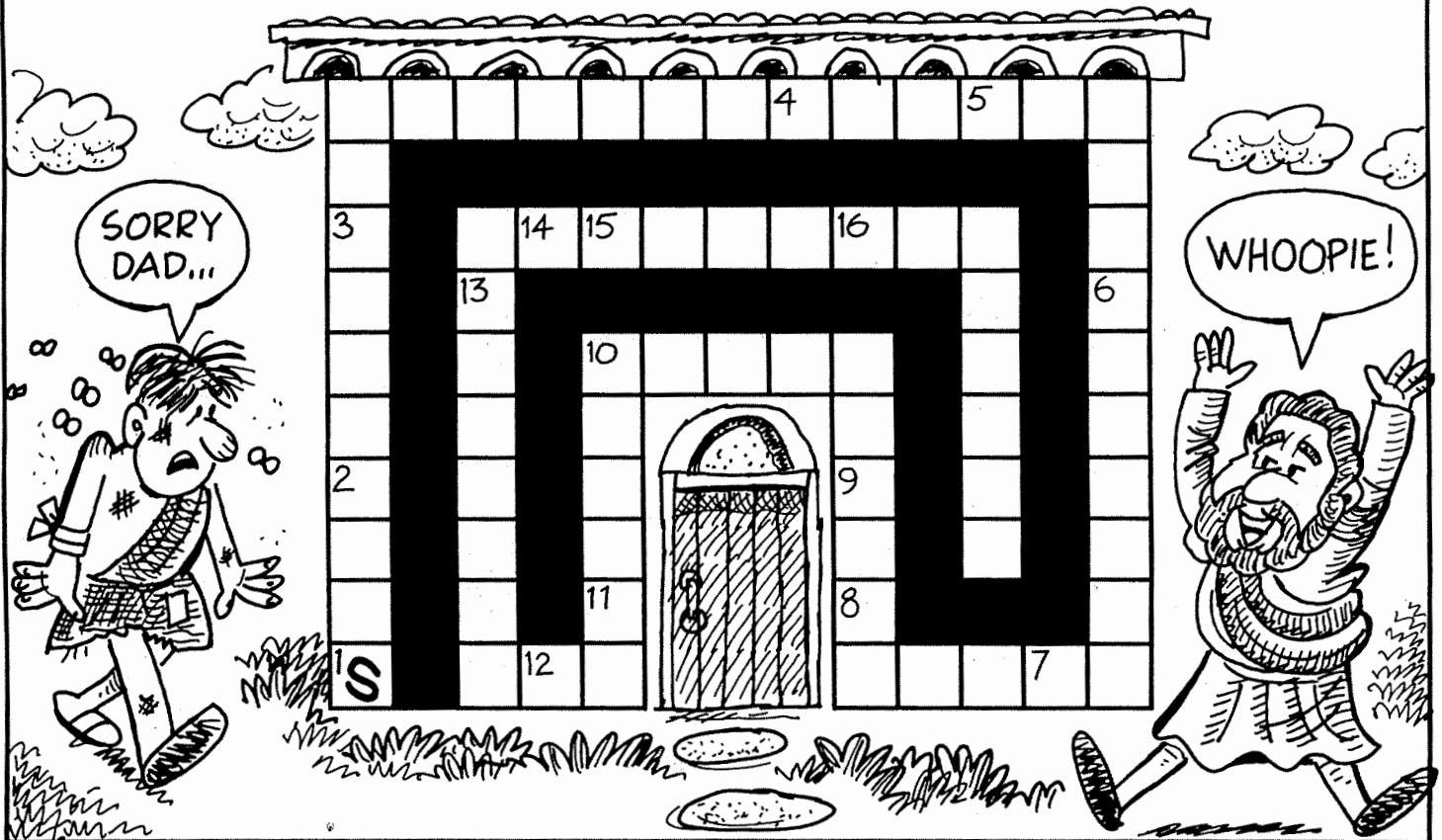

# Memory Verse...

First and Second Grade

"...for this my  
son...was lost and is  
found."

Third Grade and Above

"for this my son was  
dead and is alive  
again; he was lost  
and is found."

Luke 15:24

**Year 3**

**Week 134**

## **The Rich Man and Lazarus**

**Scriptures: Luke 16:19-31**

**Key Verse: John 14:2: “In my Father’s house are many mansions; if it were not so, I would have told you so. I go to prepare a place for you.”**

### **Key Points:**

1. There was a rich man who lived luxuriously, and a beggar named Lazarus who lived at his gates, longing for the crumbs from the rich man’s table while the dogs licked at his sores.
2. Lazarus died and was carried to Abraham’s bosom. The rich man also died. He could see Lazarus from his place in torments.
3. The rich man asks Abraham to send Lazarus to drop cool water on his tongue.
4. When Abraham tells him that there is a great gulf between them and it is impossible, the rich man asks Abraham to send Lazarus to his brothers to serve God.
5. Abraham also denies this request, telling the rich man that his brothers have the law and the prophets and they should believe them.



© 2010 Free Christ Images

# The Rich Man and Lazarus

Luke 16:1-31

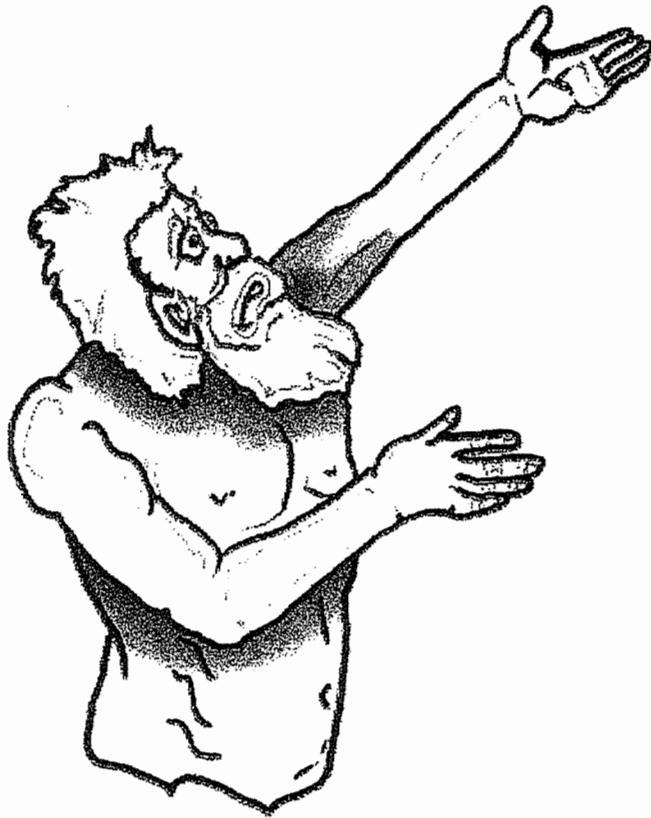





Send  
Lazarus  
For I Am  
Suffering  
In These  
Flames



# THE RICH MAN AND LAZARUS

(LUKE 16:19-31)

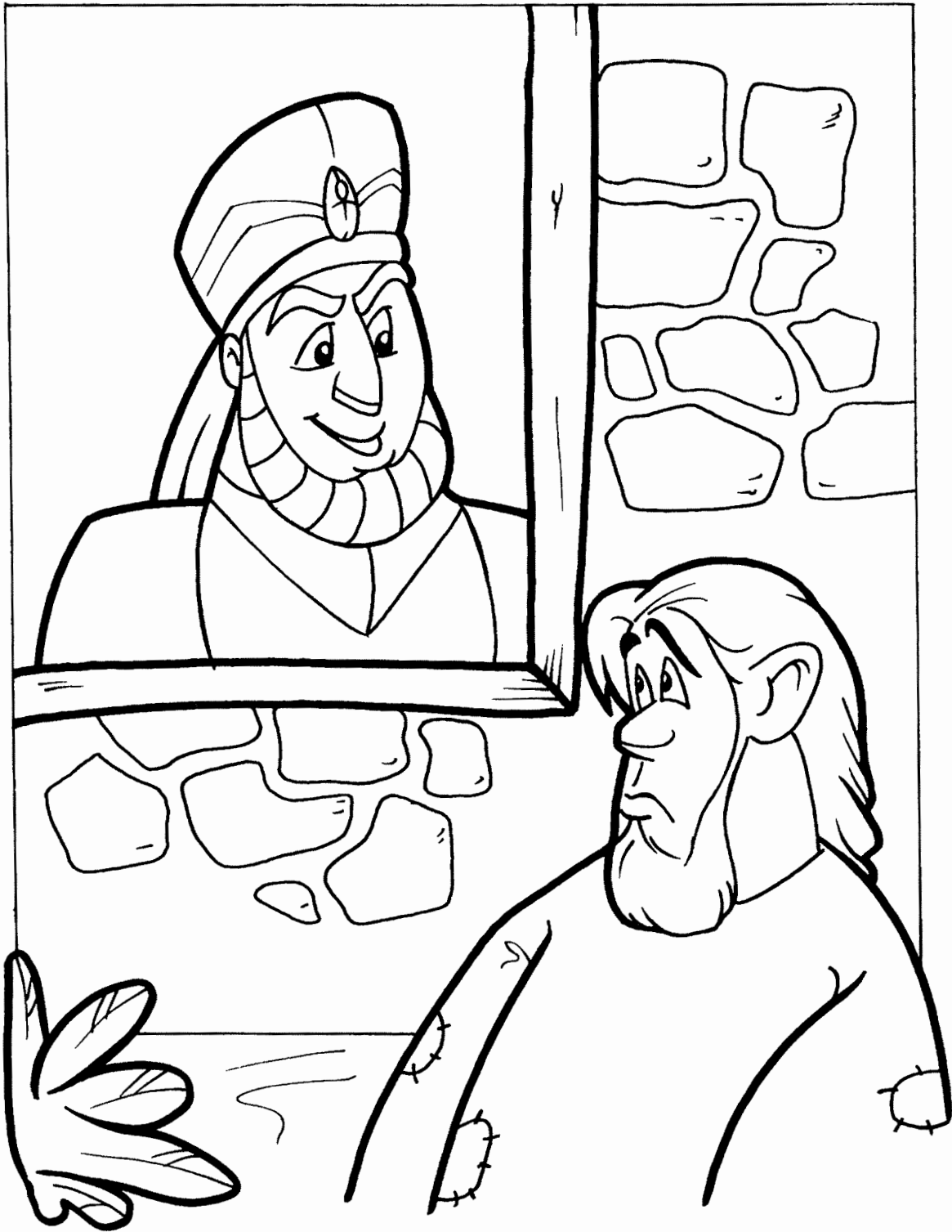

“There was a certain rich man, which was clothed in purple and fine linen, and fared sumptuously every day: And there was a certain beggar named Lazarus, which was laid at his gate, full of sores,”

**LUKE 16:19-20**

# THE RICH MAN AND LAZARUS

(LUKE 16:19-31)

## MEMORY VERSE:

**"But he said to him, 'If they do not hear Moses and the prophets, neither will they be persuaded though one rise from the dead.' " LUKE 16:31**

## TRUE OR FALSE:

1. "There was a certain rich man who was clothed in purple and fine linen and fared sumptuously every day." **LUKE 16:19**

**TRUE OR FALSE**

2. "But there was a certain beggar named Lazarus, full of sores, who was laid at his gate." **LUKE 16:20**

**TRUE OR FALSE**

## FILL IN THE BLANKS:

3. "...desiring to be fed with the \_\_\_\_\_ which fell from the rich man's table. Moreover the dogs came and licked his \_\_\_\_\_." **LUKE 16:21**

## TRUE OR FALSE:

4. "So it was that the beggar died, and was carried by the angels to Abraham's bosom. The rich man also died and was buried." **LUKE 16:22**

**TRUE OR FALSE**

**"And being in torments in Hades..." LUKE 16:23**

## CIRCLE T FOR TRUE OR F FOR FALSE:

5. "...he lifted up his eyes and saw Abraham afar off..." (v23) **T F**
- "...and Lazarus in his bosom" (v23) **T F**
- "Then he cried out, 'Father Abraham, have mercy on me, and send Lazarus that he may dip the tip of his finger in the water and cool my tongue; for I am tormented in this flame.'" (v24) **T F**
- But Abraham said, "Lazarus to do what the man asks." (v25) **T F**
- "...between us and you there is a great gulf fixed..."(v26) **T F**

## FILL IN THE BLANKS:

6. "Then he said, 'I beg you therefore, father, that you would send him to my father's house, for I have five brothers, that he may \_\_\_\_\_ to them, lest they also come to this place of torment.'" **LUKE 16:27-28**
7. "But he said to him, 'If they do not hear Moses and the prophets, neither will they be persuaded though one rise from the \_\_\_\_\_.'" **LUKE 16:31**

# THE RICH MAN AND LAZARUS

(LUKE 16:19-31)

D C O M F O R T E D M B P Q H  
 L E B E E B N A T S E Q T I I  
 A W T G C D J N I G S E D A H  
 Z N S N J D M L G R Z W D G Q  
 A D E M E I P A O E K J P J K  
 R F L S U M R B Y A J T S D L  
 U A T R D D R Y M T Y B U W Z  
 S W U I W O Y O B G M U T Y M  
 R A D C S G K E T U S B Q H M  
 E M J H R S W B R L B P L S N  
 B S I O N A M C W F D D Y M E  
 N L I K F I N E L I N E N K M  
 P G U T R N Y R M A H A R B A  
 V J G A V B E A S I N T I Y L  
 W B Z S B F U G N M D V G O F

ABRAHAM  
 BEGGAR  
 COMFORTED  
 CRUMBS  
 DOGS  
 FINE LINEN  
 FLAME

GREAT GULF  
 HADES  
 LAZARUS  
 MAN  
 RICH  
 TORMENTED

WHICH MAN WILL BE COMFORTED?

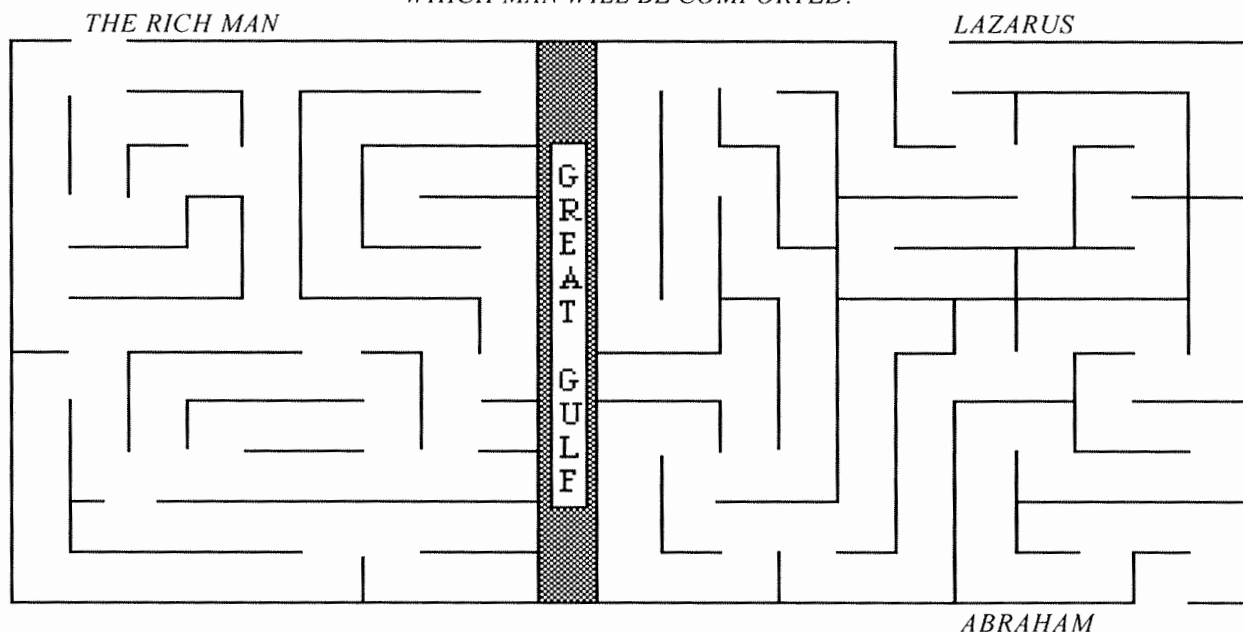

# THE RICH MAN AND LAZARUS

## (LUKE 16:19-31)

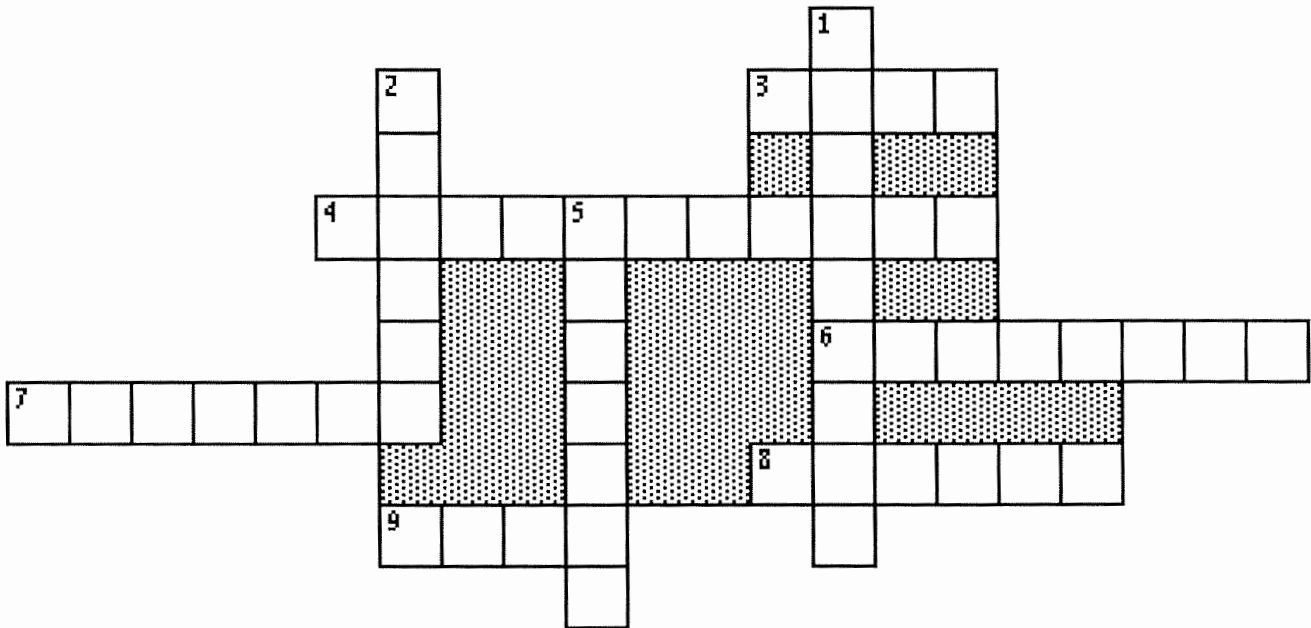

- 4 ACROSS "There was a certain rich man who was clothed in purple and fine linen and fared \_\_\_\_\_ every day." **LUKE 16:19**
- 8 ACROSS "But there was a certain \_\_\_\_\_ named Lazarus, full of sores, who was laid at his gate." **LUKE 16:20**
- 2 DOWN "...desiring to be fed with the \_\_\_\_\_ which fell from the rich man's table. Moreover the dogs came and licked his sores." **LUKE 16:21**
- 6 ACROSS "So it was that the beggar died, and was carried by the angels to \_\_\_\_\_ bosom. The rich man also died and was buried." **LUKE 16:22**
- 7 ACROSS "...he lifted up his eyes and saw Abraham afar off and \_\_\_\_\_ in his bosom." **LUKE 16:23**
- 3 ACROSS "Then he cried out, 'Father Abraham, have mercy on me, and \_\_\_\_\_ Lazarus that he may dip the tip of his finger in the water and cool my tongue; for I am tormented in this flame.'" **LUKE 16:24**
- 9 ACROSS "...between us and you there is a great \_\_\_\_\_ fixed..." **LUKE 16:26**
- 5 DOWN "Then he said, 'I beg you therefore, father, that you would send him to my father's house, for I have five brothers, that he may \_\_\_\_\_ to them, lest they also come to this place of torment.'" **LUKE 16:27-28**
- 1 DOWN "But he said to him, 'If they do not hear Moses and the prophets, neither will they be \_\_\_\_\_ though one rise from the dead.'" **LUKE 16:31**

# The Rich Man and Lazarus

Read Luke 16:19-31. Use the clues to unscramble the words. Then write the circled letters in order in the spaces at the bottom of the page to find the rich man's request.

(v. 24) the rich man called to \_\_\_\_\_

**MAAHBAR** \_\_\_\_\_  \_\_\_\_\_

(v. 20) a beggar named \_\_\_\_\_

**ZARALUS** \_\_\_\_\_  \_\_\_\_\_

(v. 28) number of rich man's brothers \_\_\_\_\_

**IFEV** \_\_\_\_\_  

(v. 19) rich man dressed in \_\_\_\_\_

**ELURPP**  \_\_\_\_\_

(v. 31) \_\_\_\_\_ to Moses and the Prophets

**TINSEL** \_\_\_\_\_  \_\_\_\_\_  \_\_\_\_\_

(v. 19) rich man lived in \_\_\_\_\_

**RXULUY** \_\_\_\_\_ 

(v. 20) Lazarus was covered with \_\_\_\_\_

**ROESS** \_\_\_\_\_ 

(v. 31) they will not be \_\_\_\_\_

**CDCNNVIOE** \_\_\_\_\_ 

(v. 28) this place of \_\_\_\_\_

**TTREMON** \_\_\_\_\_  

\_\_\_\_\_

# MATTHEW 27:11-26

PLITEA

STSPRIE

NOEWHER

LEASEER

TSICHR



HOW PILATE THOUGHT HE COULD  
CLEAN HIS CONSCIENCE:

WITH A

# LUKE 16:19-31

REGGBA

GUENOT

HERTAF

TNEPER

ZALRAUS



THE TEMPERATURE WHERE THE RICH  
MAN WENT WHEN HE DIED:

THAN

# Memory Verse...

First and Second Grade

**"If they will not listen to Moses, then they will not believe someone who has risen from the dead."**

Third Grade and Above

**"But he said to him, 'If they do not hear Moses and the prophets, neither will they be persuaded through one rise from the dead.'"**

**Luke 16:31**



**Year 3**

**Week 135**

## **Lazarus is Raised from the Dead**

**Scriptures: John 11:1-46**

**Key Verse: John 11:35: “Jesus wept.”**

### **Key Points:**

1. Mary and Martha, the sisters of Lazarus, sent word to Jesus that Lazarus was very sick. Jesus waited two days after he received the news to travel to Judea.

2. Jesus told His followers that Lazarus had fallen asleep, and they assumed He meant he had actually fallen asleep and Jesus was going to wake him up. Jesus explains to them that Lazarus is dead, and that He was glad they were not there, so they could believe.

3. When they arrived, Lazarus had been in the grave four days. Martha ran out to meet Jesus, and she told Him that she believed if Jesus had been there, her brother would not have died, but that Jesus had the power to ask God and receive resurrection for Lazarus. Jesus commends her on her faith.

4. Jesus arrived at their home, and found Mary weeping there. Jesus weeps with her, and then asks to be taken to the grave.

5. At the grave, Jesus commands Martha to move the stone aside. He prays to God, then in a loud voice, Jesus commands Lazarus to come forth.

6. Lazarus comes out of the grave, bound hand and foot. Jesus directs them to loose Lazarus, and many Jews believed on Jesus.

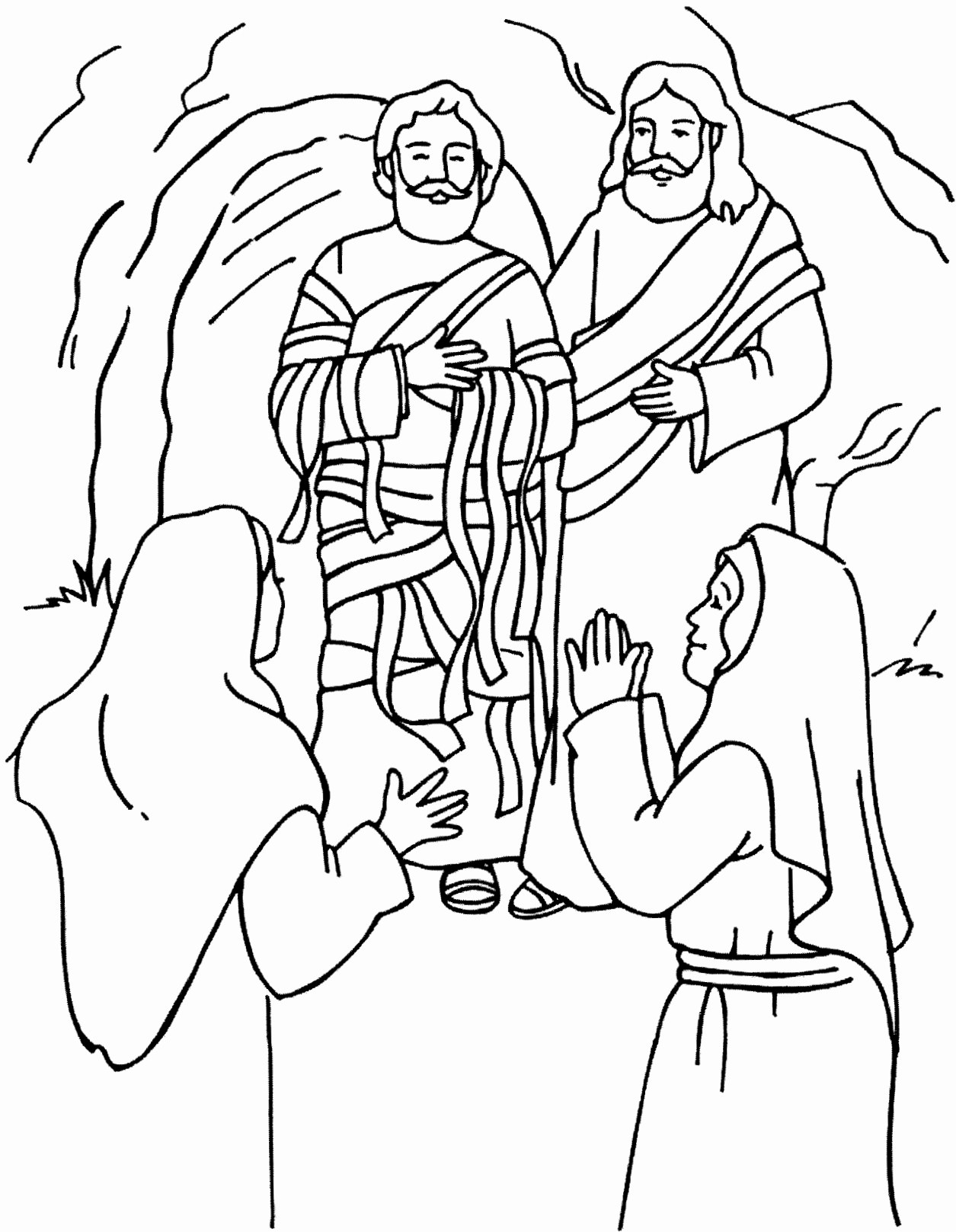

# JESUS RAISES LAZARUS

## (JOHN 11:1-44)

### MEMORY VERSE:

"Jesus said to her, 'I am the resurrection and the life. He who believes in Me, though he may die, he shall live.'" JOHN 11:25

### TRUE OR FALSE:

1. "Now a certain man was sick, Lazarus of Bethany, the town of Mary and her sister Martha." JOHN 11:1  
TRUE OR FALSE
2. "When Jesus heard that, He said, 'This sickness is not unto death, but for the glory of God, that the Son of God may be glorified through it.'" JOHN 11:4  
TRUE OR FALSE
3. But Jesus did not like Martha or her sister or Lazarus. JOHN 11:5  
TRUE OR FALSE

### FILL IN THE BLANKS:

4. "So, when He heard that he was sick, He stayed two more \_\_\_\_\_ in the place where He was." JOHN 11:6
5. "...He said to them, 'Our friend Lazarus \_\_\_\_\_, but I go that I may wake him up.'" JOHN 11:11
6. "Then His disciples said, 'Lord, if he sleeps he will get well.' However, Jesus spoke of his \_\_\_\_\_, but they thought He was speaking about taking rest in sleep." JOHN 11:12-13

### TRUE OR FALSE:

7. "So when Jesus came, He found that he had already been in the tomb four days." JOHN 11:17  
TRUE OR FALSE
8. "Then Martha said to Jesus, 'Lord, if You had been here, my brother would not have died. But even now I know that whatever You ask of God, God will give You.'" JOHN 11:21-22  
TRUE OR FALSE
9. "Jesus said to her, 'Your brother will rise again.'" JOHN 11:23  
TRUE OR FALSE

### FILL IN THE BLANKS:

10. "Then when \_\_\_\_\_ came where Jesus was, and saw Him, she fell down at His feet, saying to Him, 'Lord, if You had been here, my brother would not have died.'" JOHN 11:32
11. "Jesus \_\_\_\_\_." JOHN 11:35
12. "Then they took away the stone from the place where the dead man was lying. And Jesus lifted up His eyes and said, 'Father, I thank You that You have \_\_\_\_\_ Me.'" JOHN 11:41

### TRUE OR FALSE:

13. "Now when He had said these things, He cried with a loud voice, 'Lazarus, come forth!' And he who had died came out bound hand and foot with graveclothes, and his face was wrapped with a cloth. Jesus said to them, 'Loose him, and let him go.'" JOHN 11:43-44  
TRUE OR FALSE

**Year 3**

**Week 136**

## **Triumphal Entry, Clearing of the Temple**

**Scriptures: Luke 19:28-48, Matt 21:1-17, Mark 11:1-19, John 12:12-25**

**Key Verse: Matthew 21:13: “And He said to them, ‘It is written, My house shall be called the house of prayer, but you have made it a den of thieves.’”**

### **Key Points:**

1. Jesus and His disciples were traveling into Jerusalem, and Jesus sent the disciples ahead to find a donkey colt, and to bring it to Him. They did so.

2. They covered the colt with their blankets, and the Lord sat on it, and rode into Jerusalem on it, while the multitudes spread their garments and palm branches on the road ahead of him. They also shouted “Hosanna in the highest!” All of the city of Jerusalem was moved by this.

3. When Jesus came into the temple, he saw the moneychangers there, and the sellers of doves, and he was very angry.

4. He overturned the tables of these men, and threw them out of the temple, accusing them of turning the house of God into a den of thieves.

Jesus Enters  
Jerusalem  
John 12:12-19

# Jesus Deserves Our Praise!

When Jesus rode into Jerusalem on a young colt, the people shouted praises. They said, "Praise God!" and "God bless the One who comes in the name of the Lord!" They shouted another praise word, too. Write the first letter of each item pictured in the box below it to see what that word was.

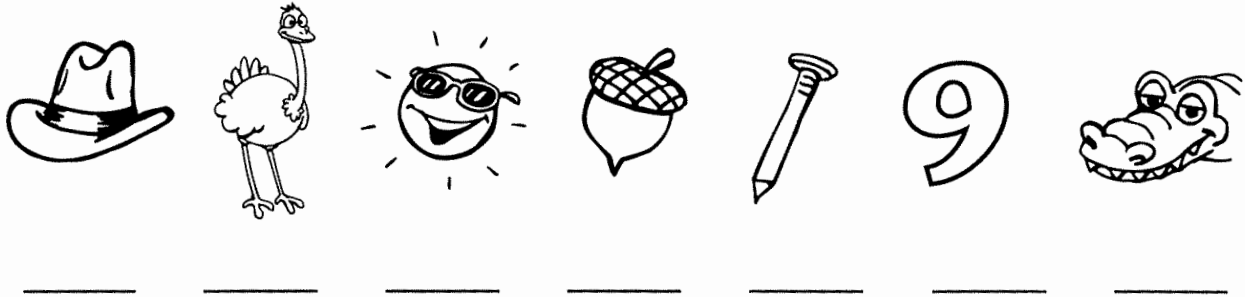

This is a Hebrew expression that means, "Save now!"

What are some words that we can use to praise Jesus? Circle all the sentences below that are praise sentences. Then color the picture of Jesus.



I thank God for sending you to save me.  
Thank you for showing me how to live.  
I love you, Jesus.  
Nothing is too hard for you.  
You are always patient with me.  
Jesus, you are special to me.  
Your miracles are awesome!  
You are my best friend.  
I love to sing about you.  
I will tell others about you.  
Thank you for loving me.  
Thank you for listening to my prayers.  
I feel safe knowing you are with me.

# THE TRIUMPHAL ENTRY INTO JERUSALEM

(MATTHEW 21:1-11)



“And the multitudes that went before, and that followed, cried, saying, Hosanna to the Son of David: Blessed is he that cometh in the name of the Lord; Hosanna in the highest.”

**MATTHEW 21:9**



# The Triumphant Entry

(Luke 19:29-40, John 12:12-19)

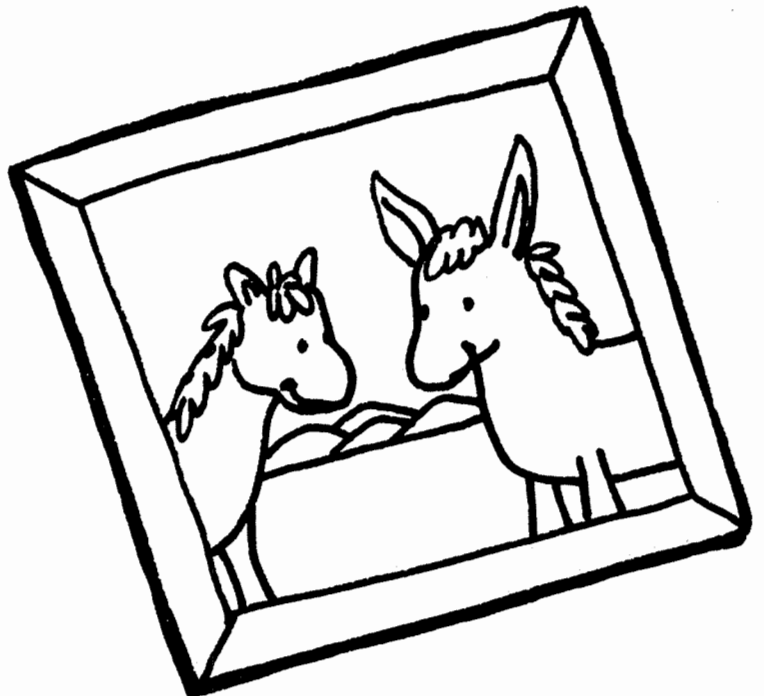
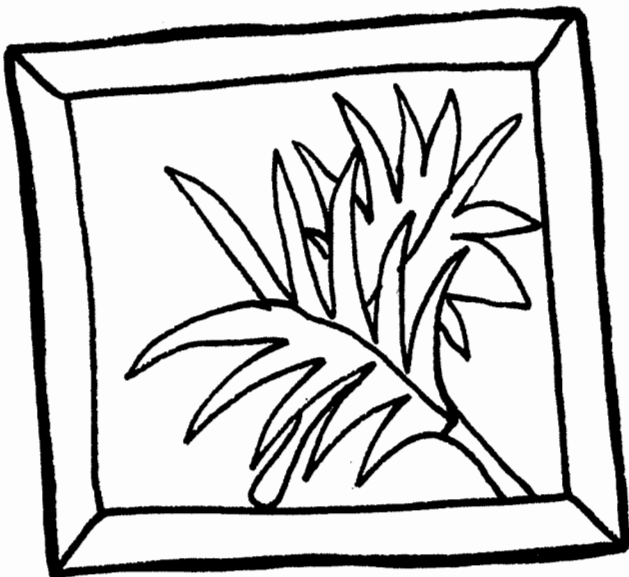
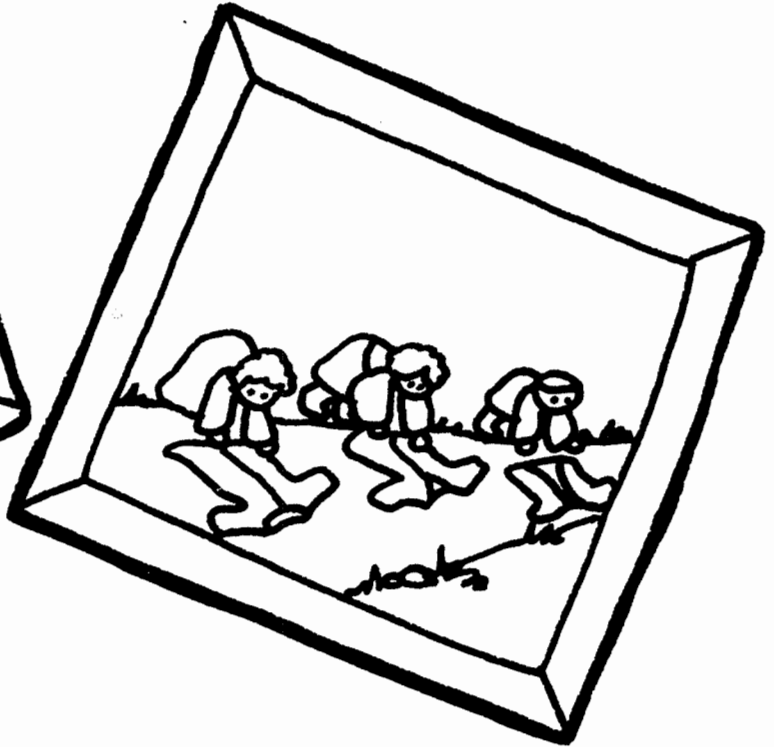
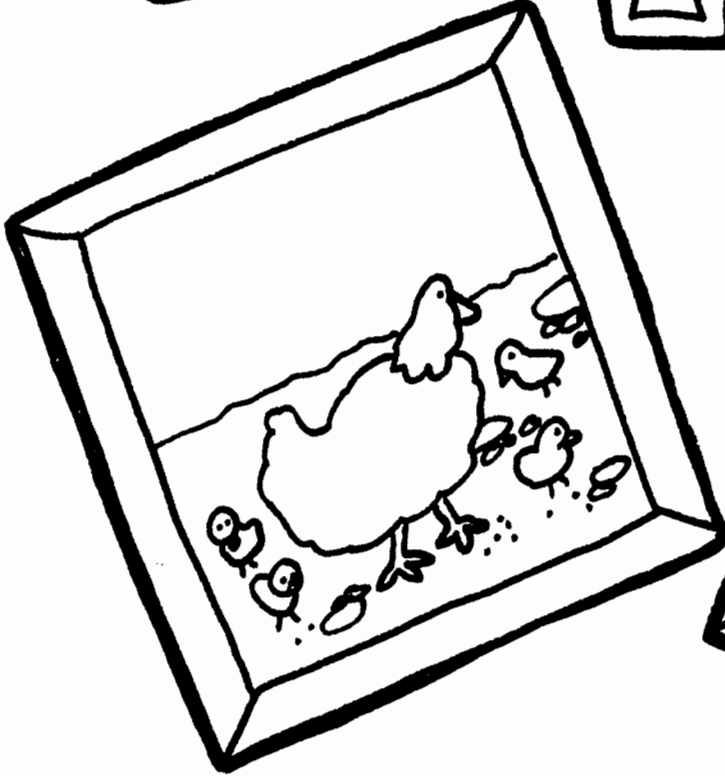

Circle the picture that does not belong.



FOLLOW THE DOTS TO FIND  
OUT WHAT KIND OF ANIMAL  
JESUS IS RIDING.



**PALM  
SUNDAY**

READ THIS  
BIBLE VERSE:  
MATTHEW 21:6-9

# Jesus Goes to Jerusalem

Matthew 21:1-11 (NIV)

Jesus had been ministering to the people for 3 1/2 years now. During that time he preached to the people that they should seek God and His Kingdom, performed many miracles and healed many people. Now he realized the time had come to lay down his life for the world as their Savior. He wished to go to Jerusalem for the Passover and he knew that if he did he put himself in danger. You can read in Matthew 18:17-19 what he prophesied would happen to him.

The people loved Jesus, and as he approached Jerusalem on the back of a donkey colt, they rejoiced to see him. Read Matthew 21:6-9 (NIV) to see what they did and said and fill in the blanks below.

"Hosanna to the \_\_\_\_\_ of \_\_\_\_\_!"  
 \_\_\_\_\_ is he who comes in the \_\_\_\_\_ of the \_\_\_\_\_!  
 " \_\_\_\_\_ in the highest!"

When Jesus arrived at Jerusalem he went to the Temple. Lead him there through the maze.

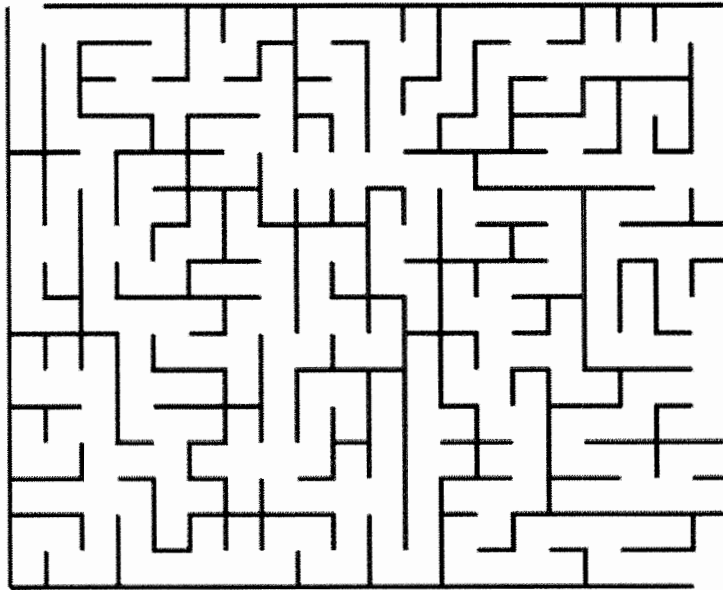

copyright 1999 Sharon Whittaker  
<http://sewhttkr.home.comcast.net>

# The People Praise Jesus

Mark 11:1-11

# 5

## MEMORY VERSE

*Those who followed shouted, "Hosanna!"*  
~ Mark 11:9



## WHAT YOU NEED

- page 80, duplicated
- crayons
- tape
- hole punch
- yarn



## BEFORE CLASS

Duplicate a pattern page for each child. Cut three 1" x 8" strips of paper for each child. Cut a 20" length of yarn for each child. Make a sample craft to show the children.

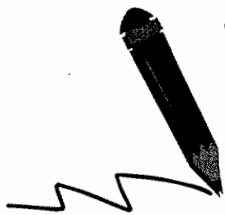
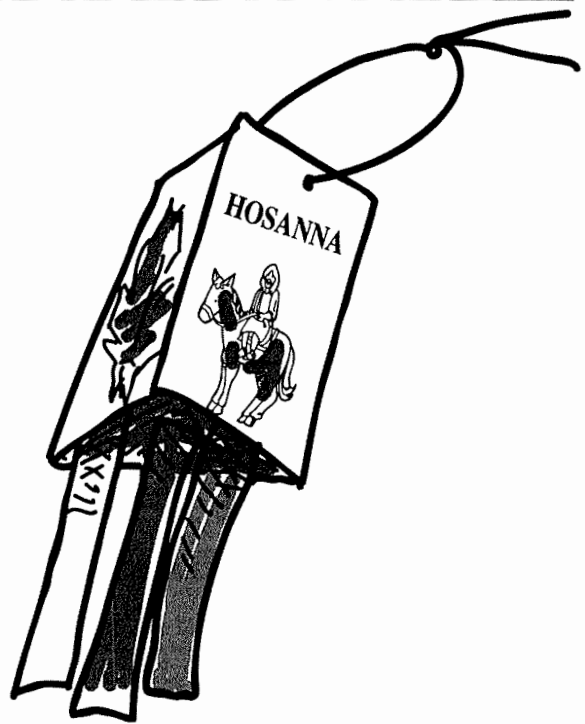

## WHAT TO DO

1. Introduce the lesson by telling the story from Mark 11:1-11. Say, **The people were happy to see Jesus. They loudly praised Jesus. We can praise Jesus, too.**
2. Show the children the sample craft.
3. Distribute a pattern page to each child.
4. Say the memory verse.
5. Have the children tape the three paper strips to the back of the page at the bottom.
6. Have the students color the page.
7. Help the children fold the page into a triangle shape and tape the edge.
8. Punch two holes along the top edge and thread yarn through for a hanger. Say, **When you hang up your windsock at home, remember to praise Jesus.**



## EXTRA TIME

Instead of paper strips, have the children tape yarn, ribbon or crepe paper to the bottom edge of the windsock. Then have the children glue glitter inside the words **THEY** and **HOSANNA**, and inside the palm leaf.

**J**esus rode a donkey in Jerusalem.  
People waved palms and  
shouted, "Hosanna!"

**5**

Those who followed  
shouted, "Hosanna!"  
Mark 11:9

**HOSANNA**

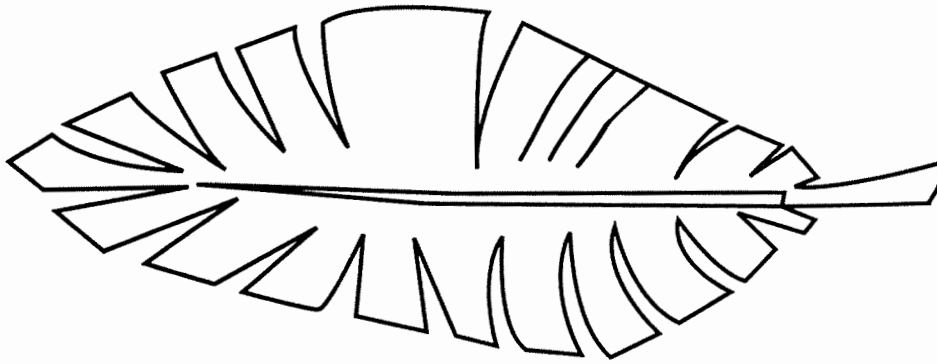
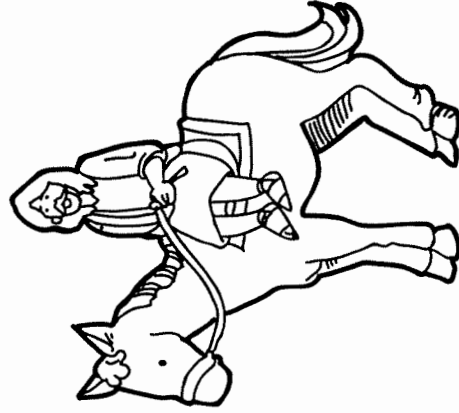

**SHOUTED**

**THEY**



# Praise God!

Read Luke 19:28-40 about Jesus' ride into Jerusalem. Then solve the code to find out what the crowd said.

○ ⊕ ⊗ ⊗ ⊕ ⊕ □ ⊗ △ ⊕

□ ⊕ ⊗ △ ⊗ ⊗ ⊕ ⊗ ⊗ ⊕ ⊗

□ ⊕ △ ⊗ ⊕ ⊗ ⊕ ⊗ ⊕ ⊗ ⊗

△ ⊗ ⊕ ⊗ ⊗ ⊗ ⊕! ⊗ ⊕ ⊕ ⊕ ⊕

□ ⊕ ⊗ ⊕ ⊕ ⊕ ⊕ ⊕ ⊕ ⊕ ⊕

⊗ ⊗ ⊗ ⊗ ⊕ ⊕ ⊕ ⊕ ⊕

⊗ ⊕ ⊗ ⊕ ⊗ ⊕ ⊕ ⊕!

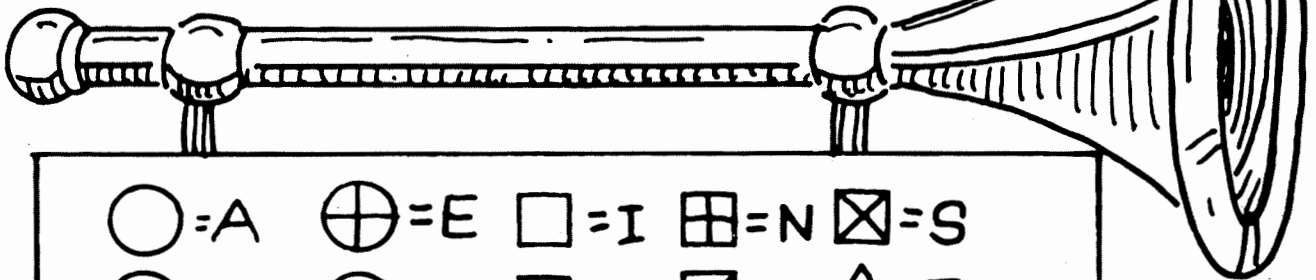

○ = A	⊕ = E	□ = I	⊕ = N	⊗ = S
⊙ = B	⊗ = F	⊙ = K	⊗ = O	△ = T
⊖ = C	⊗ = G	⊕ = L	⊙ = P	△ = V
⊕ = D	⊗ = H	⊕ = M	⊗ = R	△ = W
				△ = Y

# THE TRIUMPHAL ENTRY INTO JERUSALEM

## (MATTHEW 21:1-11)

### MEMORY VERSE:

"...Hosanna to the Son of David! 'Blessed is He who comes in the name of the LORD!' Hosanna in the highest!" MATTHEW 21:9

### FILL IN THE BLANKS:

1. "Now when they drew near to Jerusalem, and came to Bethphage, at the Mount of Olives, then Jesus sent two disciples, saying to them, 'Go into the village opposite you, and immediately you will find a \_\_\_\_\_ tied, and a \_\_\_\_\_ with her. Loose them and bring them to Me.' "  
**MATTHEW 21:1-2**

### TRUE OR FALSE:

2. "And if anyone says anything to you, you shall say, 'The Lord has need of them,' and immediately he will send them." **MATTHEW 21:3**  
**TRUE OR FALSE**

3. "All this was done that it might be fulfilled which was spoken by the prophet, saying: 'Tell the daughter of Zion, "Behold, your King is coming to you, lowly, and sitting on a donkey, a colt, the foal of a donkey." ' " **MATTHEW 21:4-5**  
**TRUE OR FALSE**

### FILL IN THE BLANKS:

4. "They brought the donkey and the colt, laid their \_\_\_\_\_ on them, and set Him on them." **MATTHEW 21:7**
5. "And a very great multitude spread their garments on the road; others cut down \_\_\_\_\_ from the trees and spread them on the road." **MATTHEW 21:8**
6. "Then the multitudes who went before and those who followed cried out, saying: ' \_\_\_\_\_ to the Son of David! "Blessed is He who comes in the name of the LORD!" \_\_\_\_\_ in the highest!" **MATTHEW 21:9**

### TRUE OR FALSE:

7. "So the multitudes said, 'This is Jesus, the prophet from Nazareth of Galilee.' " **MATTHEW 21:11**  
**TRUE OR FALSE**

# THE TRIUMPHAL ENTRY INTO JERUSALEM

## (MATTHEW 21:1-11)



T T Z P D V B P D N A D B J M B D E F H V I C M F W V Y J B  
 K Y A I I W L H R M Z A E L O C Y B D H C B P D J H L Y D W  
 G L L S Q Q D M K Q S R J G E W V B H O B N T P E I M N T W  
 Z W B T N A F O E R B I I S M H Y L L E T Y O M M B Z O N C  
 M O Y E C O B A A U Q S T G D O Z T H K W Z L E L L A B M H  
 I L R H G V I N W K Q J P T U E F B P Y C C E G A J L R A L  
 N J L T R H D Z D B M I E R I F P O A J H M E B K A G M O S  
 V Q W E C P M I I P B D U G P N T N D G D R B J P P F D O B  
 B J N D L Y L O S S K D B C N H G B M Y L B E H O L D B C Y  
 H B E O H C F S M J S V Y J B B A I T N E N T P A J J I A S  
 Q B C B Z B F B E D Y D S H U I M W N L W K D L U F Z P D R  
 C S J D C U E B C J Q Y B A I H V F Q R F A N F Q B L A K C  
 Y F B T G O A L V B M D V N Z D O G C V A A F O K V U S D G  
 B V C V O O A Y O C S S Z O E U L Z A Q O L B Z D G U W N V  
 U K L I R J U Y O U B T J L F L B Y F B J U O Q H Y K J B K  
 Y Y J Y Q C Q M R A H L U W F B Y Y H K T C P T V P P F L Z  
 B M Y I B A I K P K V I F T E C W F Z H Z S E H E B L E O R  
 H I D B B N W Q E D N A B W M J M B I A D R E E A Q P E I Y  
 T H B M G Y L I G I C O L T F N T Q D N M D Z H O M J B H C  
 R R T T Y R O I T G N I K Y G M C P E F D A E T B T D S F Q  
 T Q R B K G D Z K H E P K A Q P P V J B B Q R W Z D I O U H  
 A M B B Q U U Y V V D K O F P D B Y F C T R J B Q Q G B H Z  
 F O Y J G Q U Q N T C Y D D O C S M B L B I U H V C T G D B  
 V K T W V A C Y A D I F S B S F W C G Y T Q I O Q F E K A H  
 L A O F O B T T B A U M A U L A Y B B R M T Z M Y S D Y V O  
 I S H E L A I F Q C N T W E R E W F A A I O M O W P R T Q S  
 V B N J F G N H Y Q J W F I K V D W J T R I T L M Y H C R F  
 O P B M D F F N N C J F T N M I D B M D T T P Q J O R L L Z  
 C V L I H P I N O R B K O A B L S D S V Q B L N R R V R I S  
 E R F N F P P J D H C D D T D R I C P S A G M U J D O F Z H

FIND THE WORDS OF THE SCRIPTURE BELOW IN THE PUZZLE ABOVE

***"Tell the daughter of Zion, 'Behold, your King is coming to you,  
 Lowly, and sitting on a donkey, A colt, the foal of a donkey.'" MATTHEW 21:5***

# JESUS CLEANSSES THE TEMPLE AGAIN

(LUKE 19:45-48)

## MEMORY VERSE:

"...It is written, "My house is a house of prayer," but you have made it a "den of thieves." ' ' "

LUKE 19:46

## FILL IN THE BLANKS:

1. "Then He went into the \_\_\_\_\_ and began to \_\_\_\_\_ those who bought and sold in it." **LUKE 19:45**

## TRUE OR FALSE:

2. "...It is written, "My house is a house of prayer," but you have made it a "den of thieves." ' ' "

**LUKE 19:46**

**TRUE OR FALSE**

## FILL IN THE BLANKS:

3. "And He was \_\_\_\_\_ in the temple..." **LUKE 19:47**

## UNDERLINE THE CORRECT ANSWER:

4. "...But the chief priests, the scribes, and leaders of the people sought to \_\_\_\_ Him." **LUKE 19:47**
  - a. crown
  - b. destroy
  - c. help

## FILL IN THE BLANK:

5. "... and were \_\_\_\_\_ to do anything; for all the people were very attentive to hear Him." **LUKE 19:48**



# JESUS CLEANSSES THE TEMPLE AGAIN

(LUKE 19:45-48)

E R M B J I L L N B J G B F O  
D P U H Q P X J Y M W R B V J  
A T I O I H R Y B D E C Y W C  
M I N S Y U Y A F T J L K Q A  
O Y V T J Q R O Y V H O U S E  
Y Q B B B M L D L E M H Q A T  
B Y H T H K W B F I R Z G H Y  
L F Q O B S N T P Y I C I V X  
L M U V S B E R I I N E V H G  
C S C I E V A H S B V A O P U  
E T Y V F P F B T E N G L Y Q  
A K B O V V C O S M D E F C A  
T U B C K R J Y E T I O D K B  
A G U E Y Z B T D B Q R D U A  
S Z Y T M A C H O B C Q H O G

FIND THE WORDS OF THE SCRIPTURE BELOW IN THE PUZZLE ABOVE

***"...My house is a house of prayer', but you have made it a 'den of thieves.' "***

**LUKE 19:46**

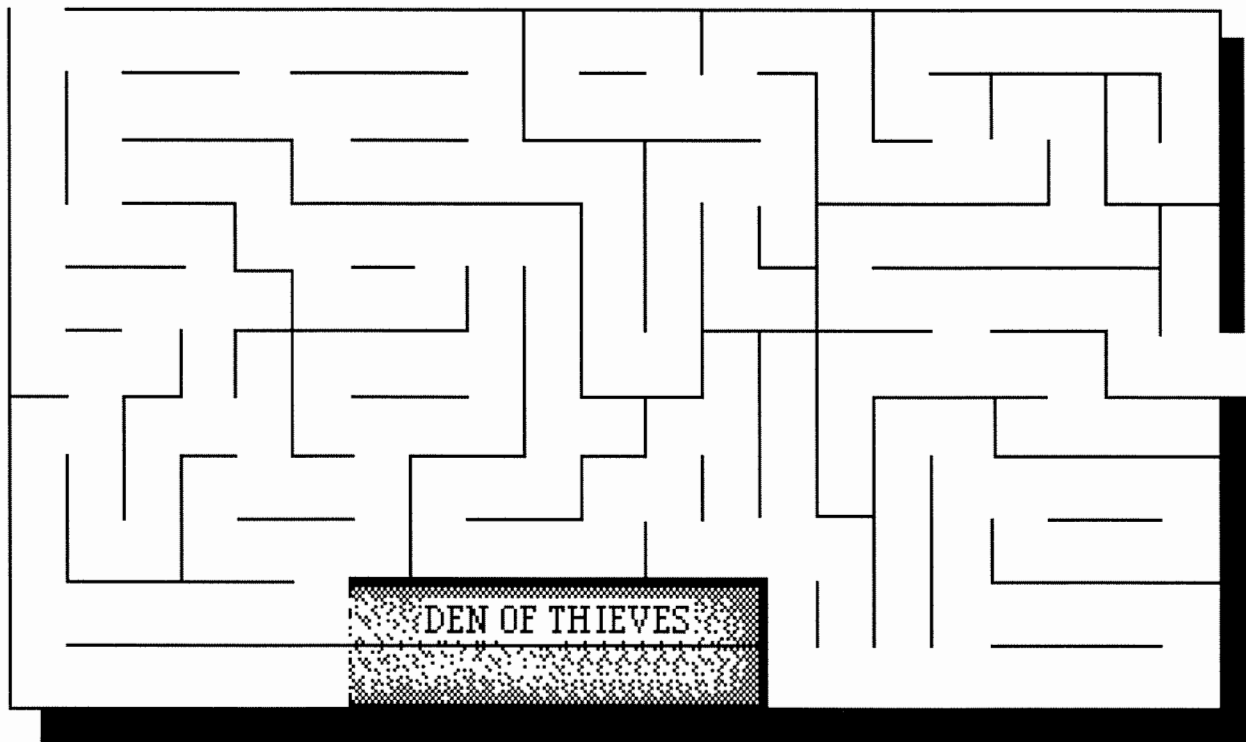



## Cleansing the Temple

From BibleStoryCard Learning System(tm) Coloring Book © 1996 Wesleyan Publishing House  
Used by permission. Additional BibleStoryCard resources available by calling 1-800-493-7539 or visiting online  
<http://www.parable.com/wph/group...1052.htm>

# Jesus' Triumphal Entry

Matthew 21:1-3, 6-11

As they \_\_\_\_\_ Jerusalem and came to \_\_\_\_\_ on the Mount of \_\_\_\_\_, Jesus sent two \_\_\_\_\_, saying to them, "Go to the \_\_\_\_\_ ahead of you, and at \_\_\_\_\_ you will find a \_\_\_\_\_ tied there, with her \_\_\_\_\_ by her. \_\_\_\_\_ them and \_\_\_\_\_ them to me. If anyone says \_\_\_\_\_ to you, tell him that the Lord \_\_\_\_\_ them, and he will \_\_\_\_\_ them right away." ... The disciples \_\_\_\_\_ and did as Jesus had \_\_\_\_\_ them. They \_\_\_\_\_ the donkey and the colt, \_\_\_\_\_ their \_\_\_\_\_ on them, and \_\_\_\_\_ sat on them. A very large \_\_\_\_\_ spread their cloaks on the \_\_\_\_\_, while others cut \_\_\_\_\_ from the \_\_\_\_\_ and \_\_\_\_\_ them on the road. The crowds that went \_\_\_\_\_ of him and those that followed \_\_\_\_\_, "\_\_\_\_\_ to the Son of \_\_\_\_\_!" "\_\_\_\_\_ is he who \_\_\_\_\_ in the \_\_\_\_\_ of the Lord!" "Hosanna in the \_\_\_\_\_!" When Jesus entered \_\_\_\_\_, the whole \_\_\_\_\_ was stirred and asked, "Who is this?" The crowds answered, "This is Jesus, the \_\_\_\_\_ from Nazareth in Galilee."

A N Y T H I N G S E R G A N D I N S P O C A X L H C A T R H S V I P  
 B P K J I H S T R O C A P I Z S S C  
 R F P I N S P O C A X L H C A T R H S V I P  
 O G T R A O B A D C A T R H S V I P  
 U N R A O B A D C A T R H S V I P  
 G I E C D N G H O E W S O L L  
 H R E C D N G H O E W S O L L  
 T B S H T N G H O E W S O L L  
 S U S E J E S W S K D T U O E  
 E R B S Q S W S K D T U O E  
 G P L A C E D A N C I T Y S  
 A U E P N O D N O L N E M D  
 L N S T L I K N D O J D N E  
 L T S E V I D A H A N C A E  
 I I E A H E A D G K B C M N  
 V E D K A M E L A S U R E J



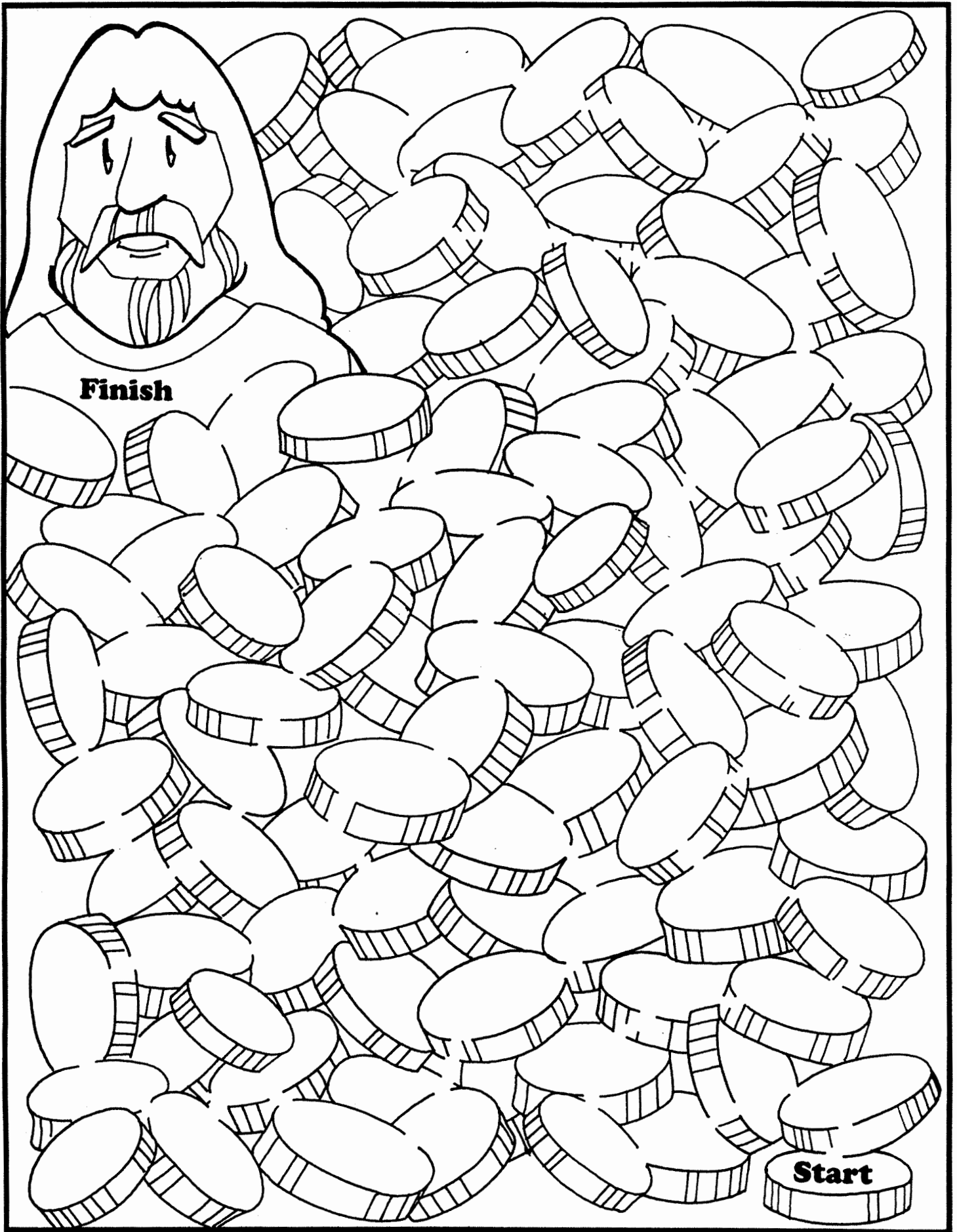

# Clearing the Temple

Mark 11:15-19, 27-33

As Jesus and His disciples entered Jerusalem, Jesus headed for the temple. When He entered the temple, He began to clear out the buyers and sellers, turning over the tables of the money exchangers. Jesus said to them, "My house will be called a house of prayer for all nations, but you have made it a den of robbers."

The chief priests and teachers of the law heard this, and they were afraid of Him. From that day on, they began plotting to murder Jesus.

Days later, as Jesus was entering the temple, the chief priests and teachers questioned Him. "Who gave you authority to do this?"

Jesus told them to answer one question: "John's baptism—was it from heaven, or from men?"

They discussed it among themselves and answered, "We don't know."

Jesus replied, "Neither will I tell you by what authority I am doing these things."

## **Challenge:**

Find your way through the coins to Jesus.

# Memory Verse...

First and Second Grade

**"My house is a house of  
prayer."**

Third Grade and Above

**"...It is written, 'My  
house is a house of  
prayer,' but you have  
made it a 'den of  
thieves.'"**

**Luke 19:46**

## Year 3

### Week 137      A Widow, Wise and Foolish Virgins, and Wise and Foolish Servants

**Scriptures:** Luke 21:1-4, Matt 25:1-30

**Key Verse: Matt 25:23:** “And his lord said unto him, ‘Well done, good and faithful servant, you were faithful over a few things, I will make you ruler over many things. Enter thou into the joy of your Lord.’”

#### **Key Points:**

1. Jesus saw a widow in the temple putting her two mites into the offering, after all of the rich men bestowing all their gifts. Jesus told those around him that the widow had given much more than all of the others, because she gave all that she had.

2. Jesus also told a parable, comparing the kingdom of heaven to ten virgins, who took their lamps to go meet the bridegroom. Five were wise, and five were foolish.

3. The five foolish virgins ran out of oil when the bridegroom was coming, and asked the five wise virgins to give them oil. The five wise virgins refused, and told them to go buy some for themselves. While the five foolish virgins were gone, the bridegroom came, and they were shut out.

4. Jesus spoke again and said the kingdom of heaven was like a man who, when he was traveling to a far country, divided his goods among his three servants. He gave one five talents, one two talents, and to one servant he gave one talent, according to their abilities.

5. The servants that had five and two talents went and traded them, and doubled what they had before. The servant with one talent went and buried it until the master returned. When he returned, he complimented the first two servants on their faithfulness.

6. The master scolded the last servant, calling him lazy and wicked. He took the one talent from him and gave it to the one that had ten talents. The wicked servant was cast out to the outer darkness.

# The Widow's Offering

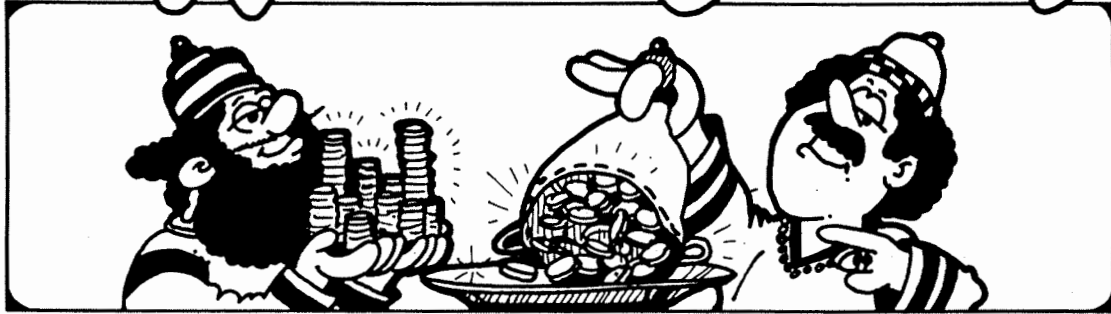

Find out what the widow put in the offering by placing the correct letter in the blank. Check your answer by reading Mark 12:41-44.

1. \_\_\_\_ You'll find me once in snake and twice in elephant.
2. \_\_\_\_ You'll find me in vanilla, but not in chocolate or lemon lime.
3. \_\_\_\_ I'm once in ears and twice in eyes.
4. \_\_\_\_ I'm a consonant in treasure but not in stadium.
5. \_\_\_\_ You'll see me in yard, but not in lard.
6. \_\_\_\_ Look for me twice in tight and little.
7. \_\_\_\_ I'm a consonant in house and also in heart.
8. \_\_\_\_ I'm a vowel in Illinois but not in Oregon.
9. \_\_\_\_ I'm a consonant found once in bean and twice in banana.
10. \_\_\_\_ I'm a consonant in green, but not in brown.

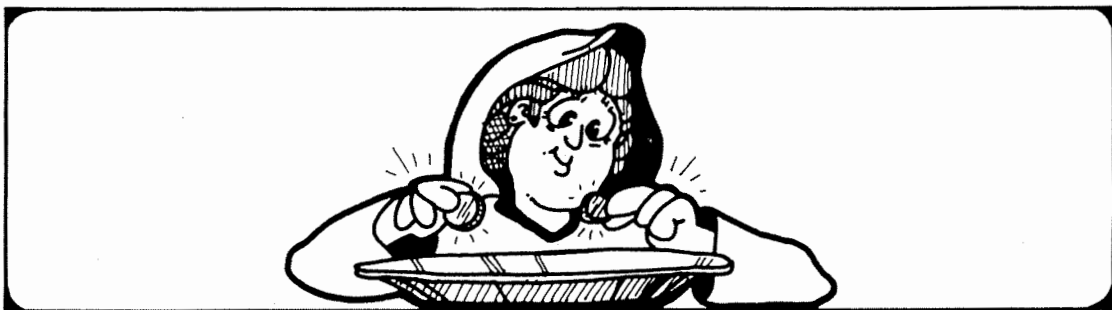

The widow put in \_\_\_\_\_.



**Parable of the  
Ten Virgins  
Matthew 25**

# He Will Return

Use the flag code in  
the box to figure out  
the message.

	A		B		C		D		E		F
	H		K		N		O		P		R
	S		T		U		W		Y		

Jesus promised  
that he would return  
for us some day.  
He told us to be  
prepared for his  
second coming.  
But when is that  
wonderful day  
going to  
happen?



# When Will Jesus Come?

Follow the lines from the lanterns to the blank spaces and put the same letters in the spaces that are on the lanterns. You will find out what we know about when Jesus will return. Read Matthew 25:1-13 to find out more.

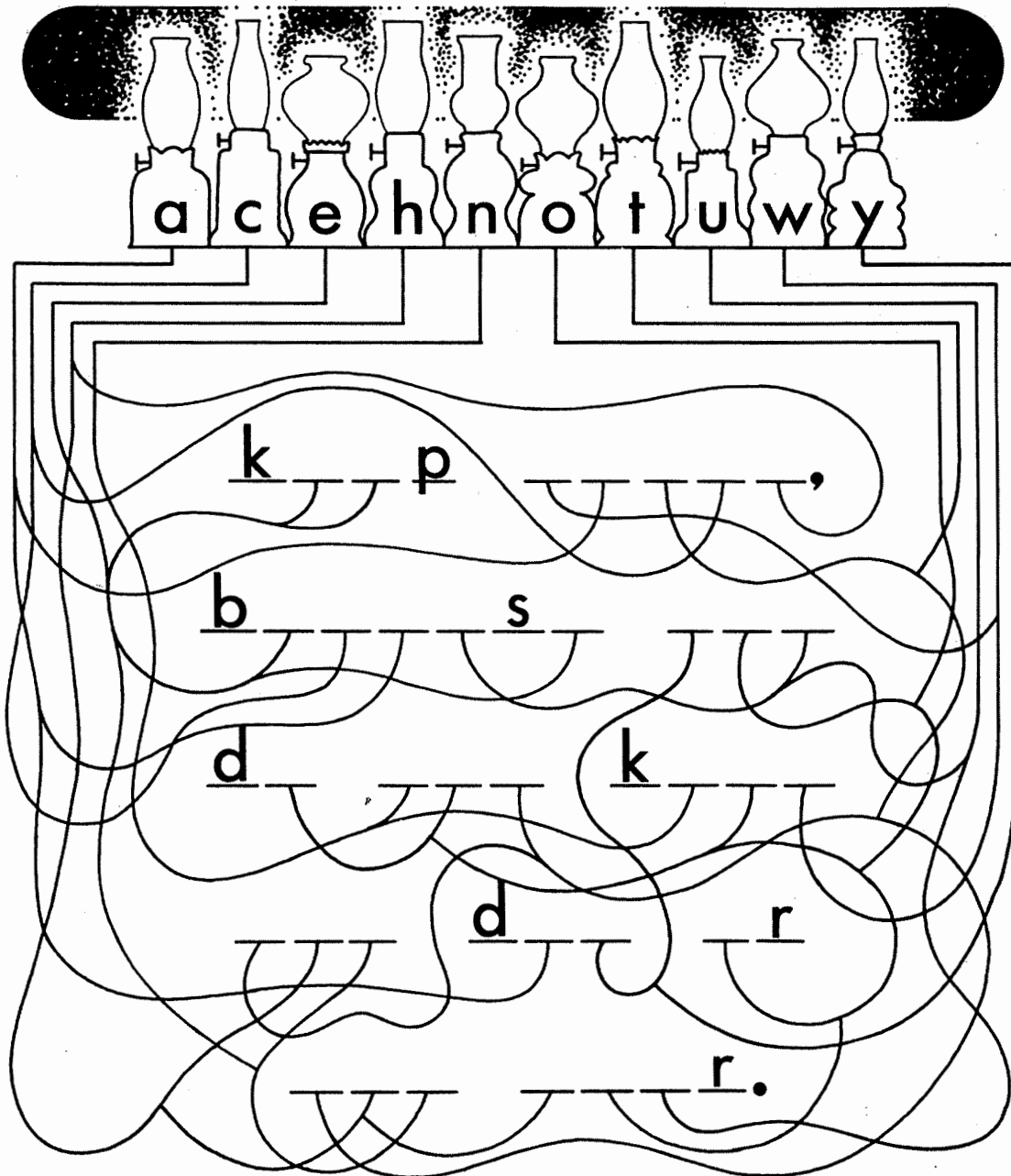

# WHAT'S MISSING?

Can you name the 10 items missing from illustration #2 and list them below?



# 71. A Parable

Five wise virgins with lamps and oil

Five foolish virgins with lamps and no oil

The bridegroom comes!

The wise ones are ready and go

The foolish ones are left behind

Watch! Be ready!

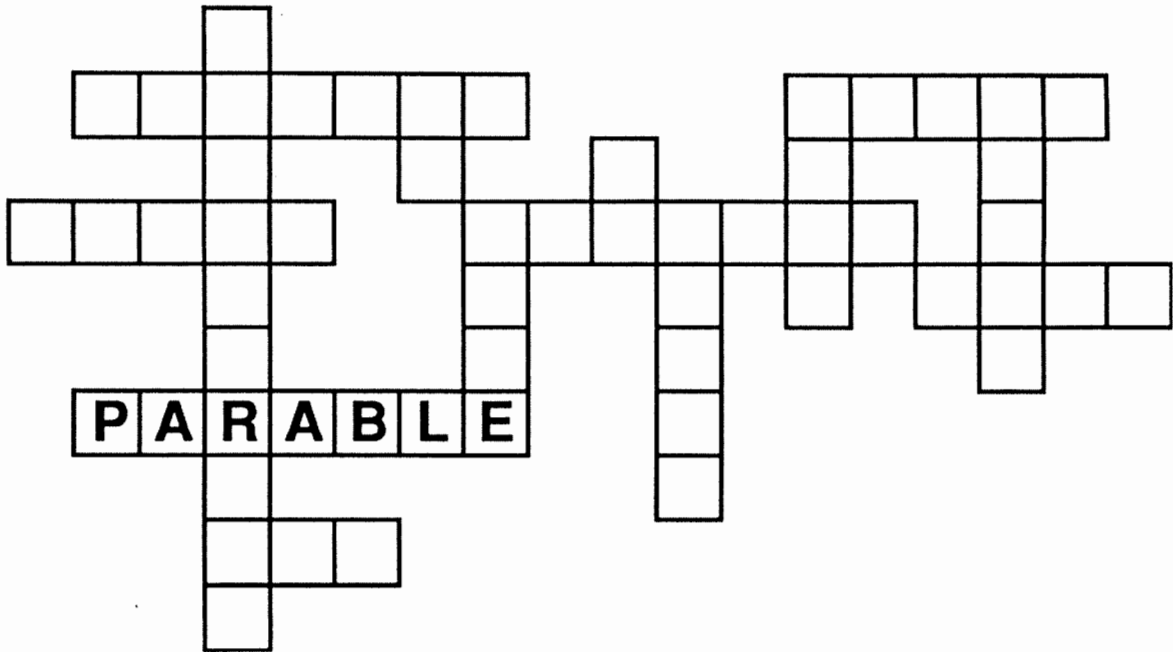
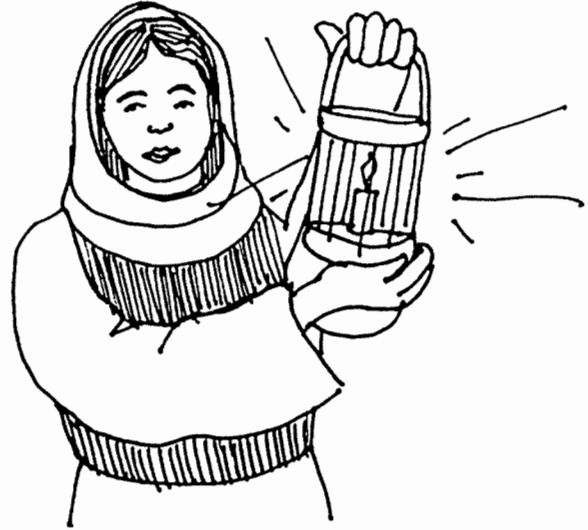

Fit the underlined words in the puzzle.

# THE PARABLE OF THE TEN MAIDENS

(MATTHEW 25:1-13)

## MEMORY VERSE:

*"Watch therefore, for you know neither the day nor the hour in which the Son of Man is coming."* MATTHEW 25:13

## TRUE OR FALSE:

1. "Then the kingdom of heaven shall be likened to ten virgins who took their lamps and went out to meet the bridegroom." MATTHEW 25:1

TRUE OR FALSE

## FILL IN THE BLANKS:

2. "Now five of them were \_\_\_\_\_, and five were \_\_\_\_\_." MATTHEW 25:2
3. "Those who were foolish took their lamps and took \_\_\_\_\_ oil with them..." MATTHEW 25:3
4. "...but the wise took oil in their vessels with their \_\_\_\_\_." MATTHEW 25:4

## TRUE OR FALSE:

5. "But while the bridegroom was delayed, they all slumbered and slept." MATTHEW. 25:5

TRUE OR FALSE

6. And at noontime a cry was heard, "Behold, the bridegroom is coming; go out to meet him!" MATTHEW 25:6

TRUE OR FALSE

## FILL IN THE BLANKS:

7. "...the foolish said to the wise, 'Give us some of your \_\_\_\_\_, for our lamps are going out.' " MATTHEW 25:8
8. "But the wise answered, saying, ' \_\_\_\_\_, lest there should not be enough for us and you...' " MATTHEW 25:9
9. "...the bridegroom came, those who were ready went in with him to the wedding; and the door was \_\_\_\_\_." MATTHEW 25:10

## CIRCLE THE CORRECT ANSWER:

10. "Afterward, the other virgins came also, saying, 'Lord, Lord, open to us!' But he answered and said, 'Assuredly, I say to you, I (DO, DO NOT) know you.' " MATTHEW 25:11-12

# THE WISE & FOOLISH WOMEN

WHAT IS THE LESSON OF THIS PARABLE?

**MATTHEW 25:1-13**

- 1) FIVE WERE WISE AND FIVE WERE \_\_\_\_\_, V.2
- 2) THE FOOLISH TOOK THEIR \_\_\_\_\_ BUT NO OIL. V.3
- 3) THEY ALL BECAME DROWSY AND FELL \_\_\_\_\_, V.5
- 4) THEY ALL WOKE UP AND \_\_\_\_\_ THEIR LAMPS, V.7
- 5) WHILE THE FOOLISH WOMEN WERE BUYING OIL, THE BRIDEGROOM \_\_\_\_\_, V.10
- 6) THE WOMEN WHO WERE \_\_\_\_\_ WENT INTO THE WEDDING BANQUET. V.10
- 7) THEREFORE KEEP \_\_\_\_\_, V.13



1	F	O	O	L	Y	I	S	H
2	L	O	A	M	U	P	S	M
3	A	S	U	L	S	E	E	P
4	T	R	T	I	M	M	E	D
5	A	R	R	B	I	V	E	D
6	R	E	E	A	D	R	Y	E
7	W	A	A	T	D	C	H	Y

-----  
-----!



**Parable of the Talents**  
**Matthew 25**

# Talents

.....  
 God has given all of us various degrees of talent. What does he expect us to do with these wonderful gifts? Finish each word with its correct ending to find out.  
 .....

- AS
- ACE
- HERS
- SE
- D'S
- TS
- NE
- IOUS
- N
- FT
- RVE
- RMS
- EIVED
- EVER
- FULLY
- ULD
- E
- TERING
- CH
- O

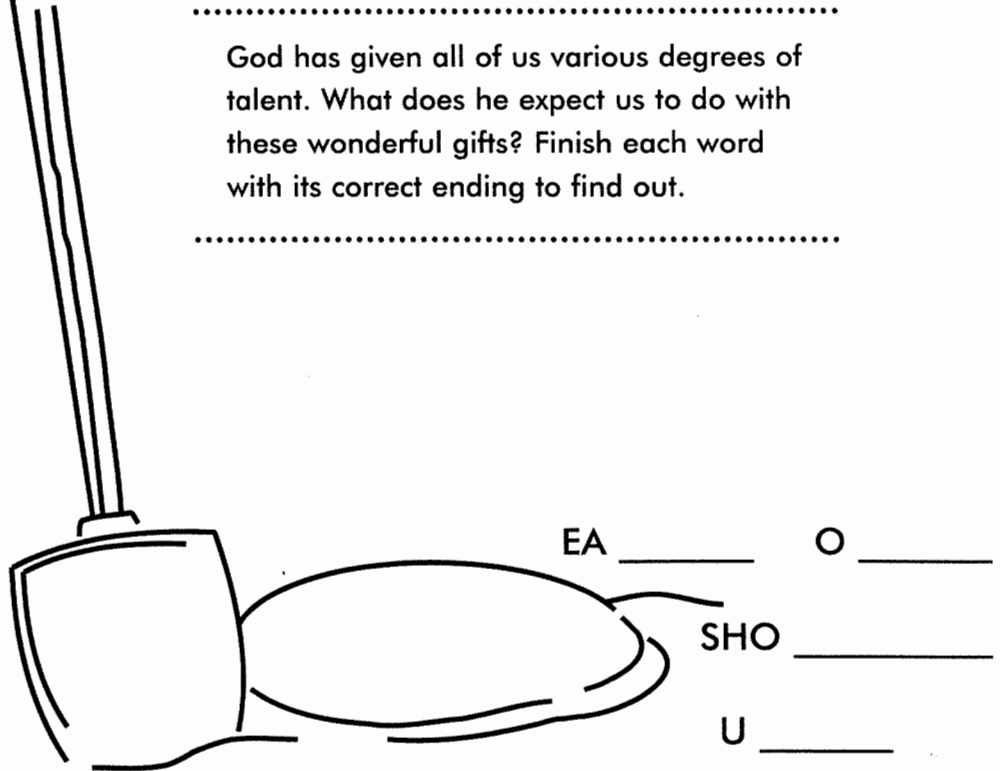

EA \_\_\_\_\_ O \_\_\_\_\_  
 SHO \_\_\_\_\_  
 U \_\_\_\_\_  
 WHAT \_\_\_\_\_ GI \_\_\_\_\_  
 H \_\_\_\_ H \_\_\_\_\_ REC \_\_\_\_\_  
 T \_\_\_\_ SE \_\_\_\_\_ OT \_\_\_\_\_,  
 FAITH \_\_\_\_\_  
 ADMINIS \_\_\_\_\_  
 GO \_\_\_\_\_ GR \_\_\_\_\_ I \_\_\_\_  
 I \_\_\_\_\_ VAR \_\_\_\_\_ FO \_\_\_\_\_.

# One Talent

1. Subtract box C from box F. Place the answer in workbook A.
2. Subtract box D from box A. Place the answer in workbook B.
3. Add boxes C and D. Place the total in workbook C.
4. Add boxes E and F. Place the total in workbook D.
5. Subtract box D from box E. Place the answer in workbook E.
6. Add boxes C, D, and F. Place the total in workbook F.
7. Subtract box A from box G. Place the answer in workbook G.
8. Add boxes B and F. Place the total in workbook H.

Boxes

A	B	C	D	E	F	G	H
25	10	5	15	40	20	30	60
he	di	ou	hi	gr	ti	nd	nt

In the circles below each workbook, write the letters that appear below the same number at the top of the page. Read Matthew 25:24-30 to find out more.

Workboxes

A	B	C	D	E	F	G	H
○	○	○	○	○	○	○	○

What did the servant with one talent do with his money?



# Memory Verse...

First and Second Grade

“...the Son of Man is  
coming.”

Third Grade and Above

“Watch therefore, for  
you know neither the day  
nor the hour in which  
the Son of Man is  
coming.”

**Matthew 25:13**

## **Year 3**

### **Week 138**

#### **Last Supper and Lord's Supper Established**

**Scriptures: Luke 22:1-20, Matt 26:14-29**

**Key Verse: Luke 22:19: And He took bread, gave thanks and broke it, and gave it to them saying, "This is My body which is given for you. Do this in remembrance of me."**

#### **Key Points:**

1. Jesus sends His disciples into Jerusalem to prepare a place to partake of the Passover.
2. Judas goes to the chief priests and makes a covenant with them to betray Christ for 30 pieces of silver. Later, while they are eating the Passover feast, Jesus identifies Judas as the one that will betray Him.
3. Later, while they are eating the Passover feast, Jesus identifies Judas as the one that will betray Him.
4. Jesus blesses and breaks the bread, giving it to His disciples, and tells them to take and eat, for it is His body.
5. He does the same with the cup, telling them to drink, that it is His blood, shed for the remission of sins.
6. Jesus then tells His disciples that He will not drink this again until He does so with them in the kingdom of heaven.

# The Last Supper

(Matthew 26:17-29,  
Mark 14:13-25,  
Luke 22:7-23)

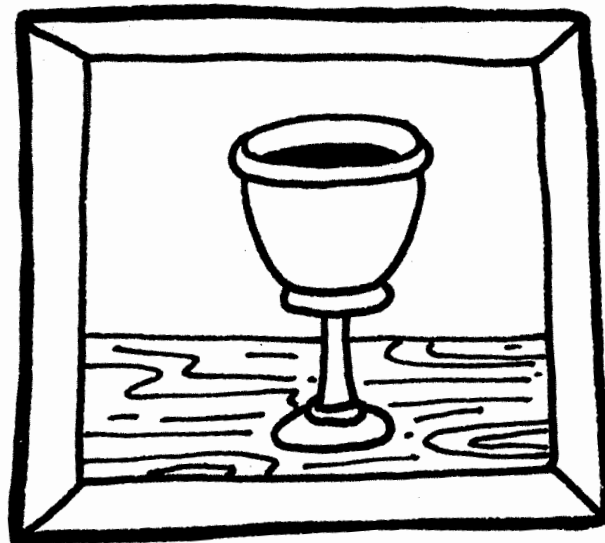
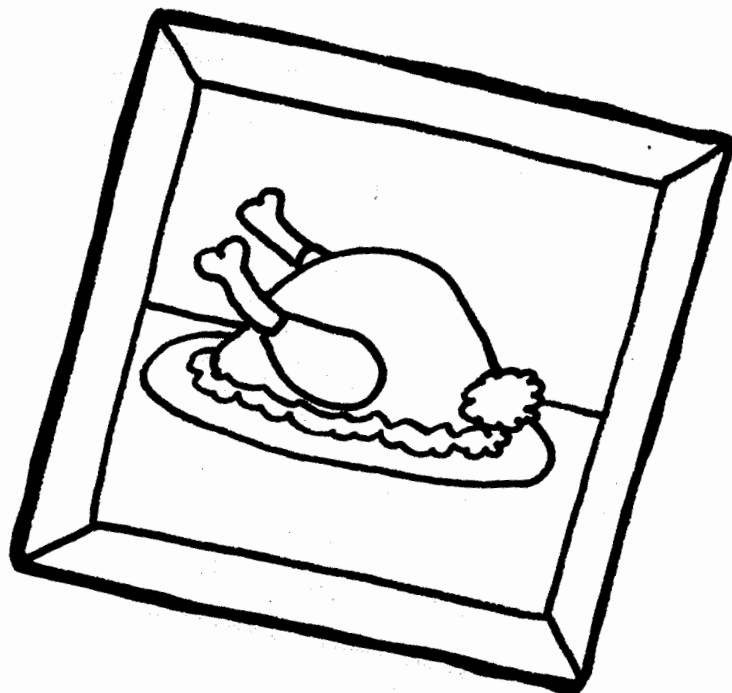
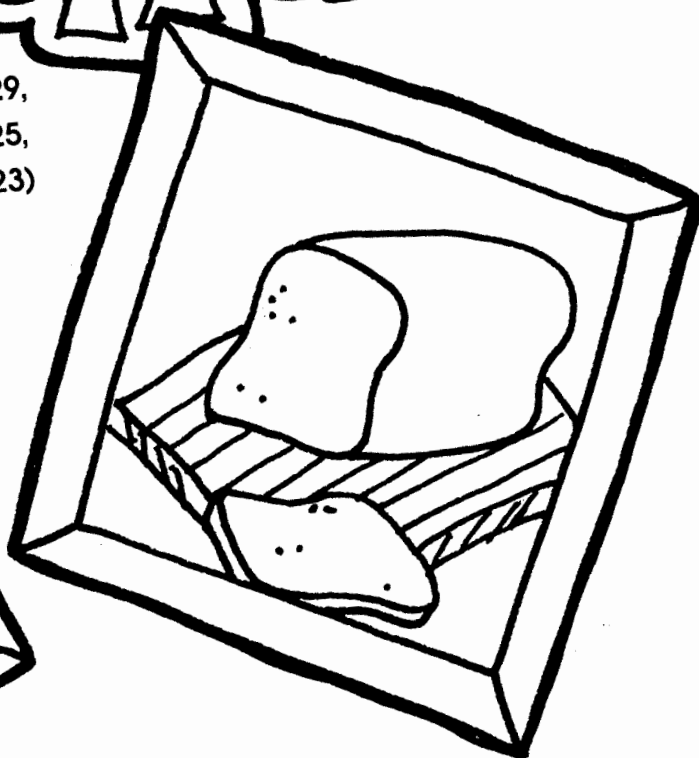
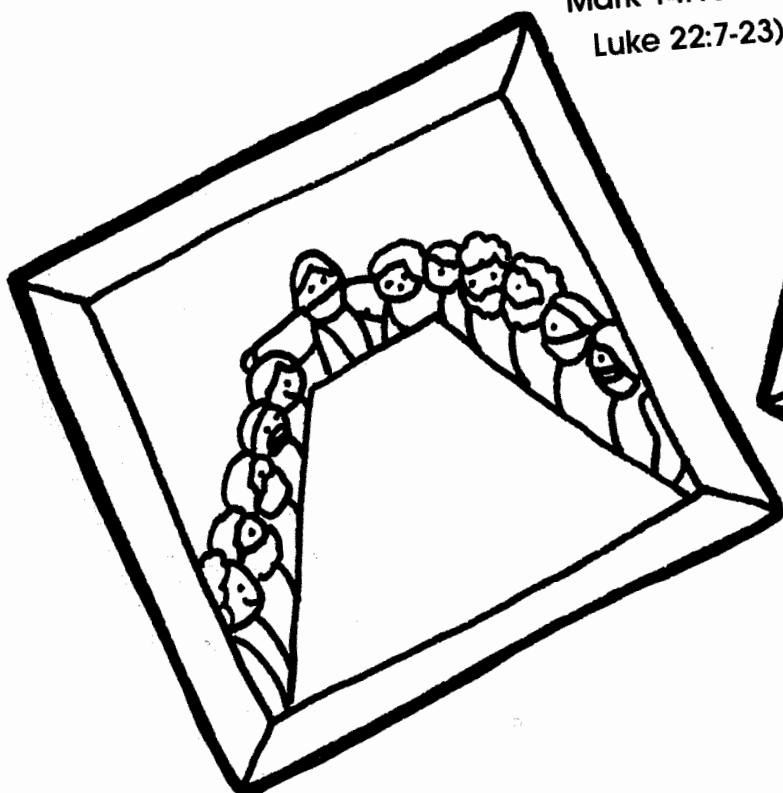

Circle the picture  
that does not belong.

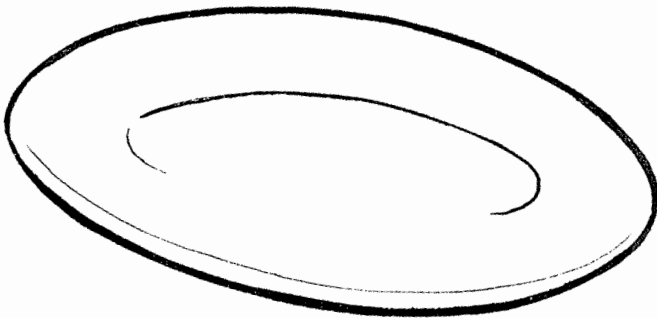
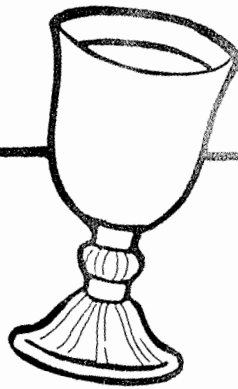



The Last Supper  
*Luke 22*

# Dot-to-Dot

Follow the dots from 1 to 80. Color the picture.  
Would you like to have one? What does this picture have to do with Jesus' last meal?

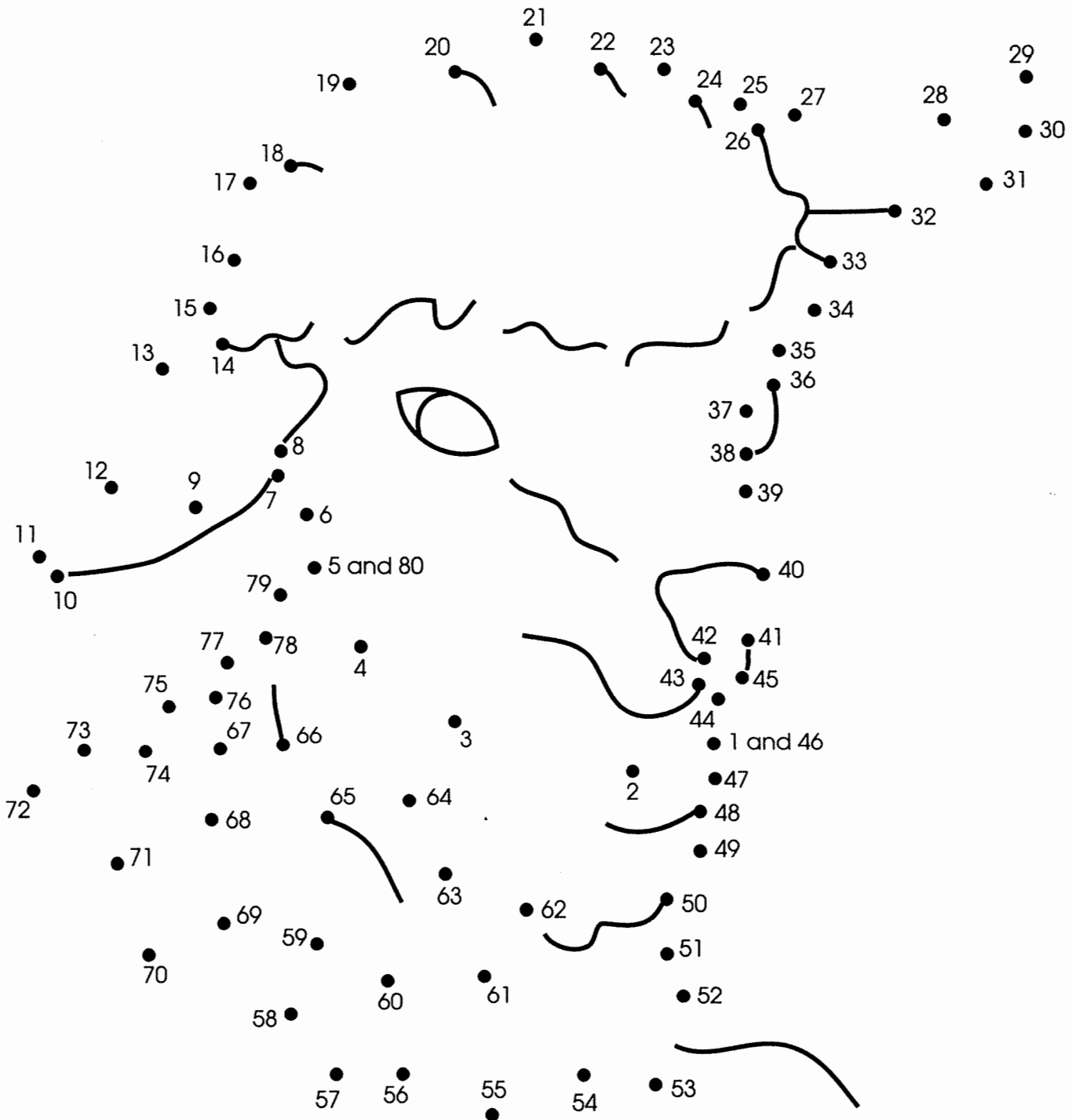

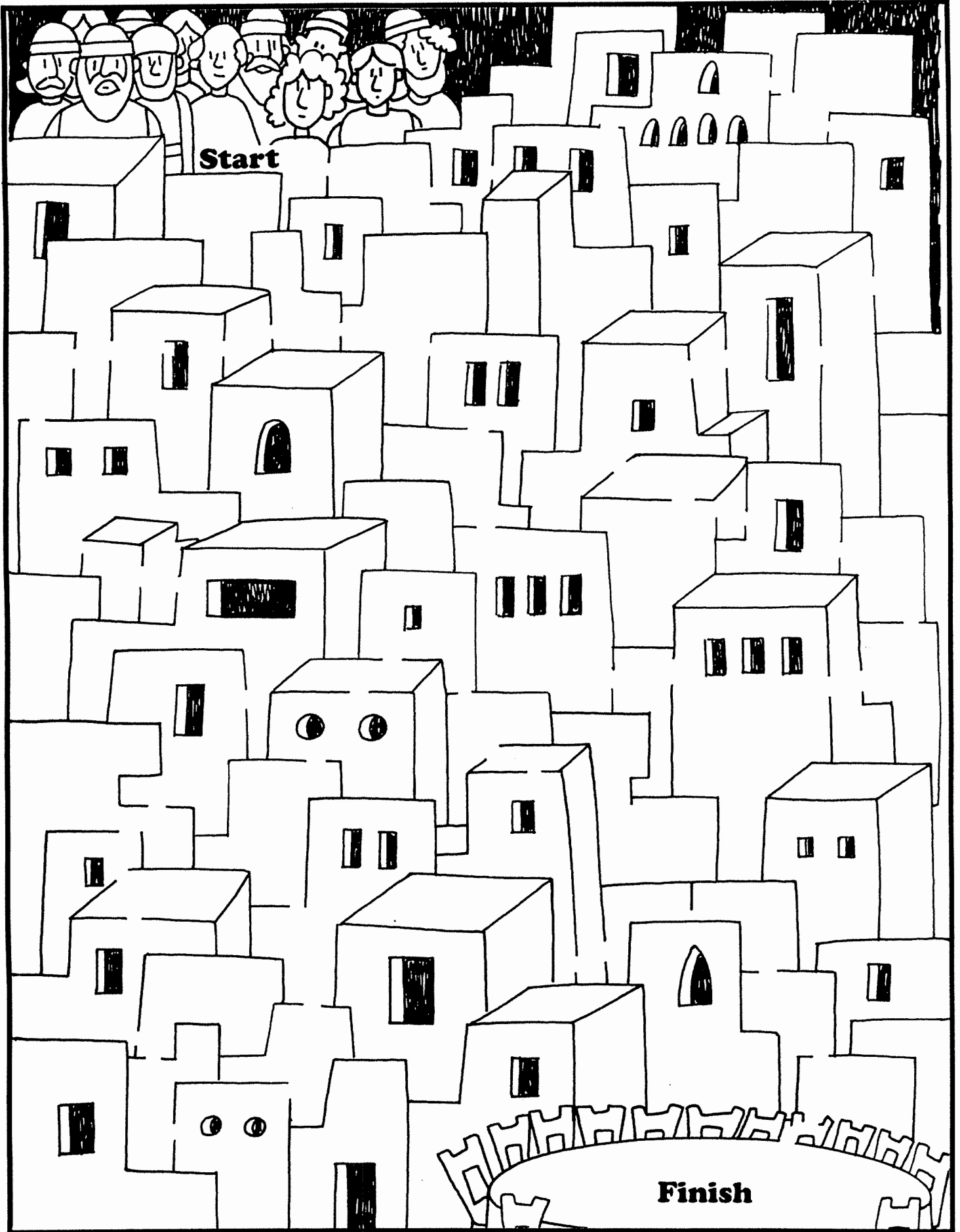

# One Last Meal



night



Jew



lamb



wine



Jesus



die

























meal



said



rooster

It was Passover . That is a special  for s. s cook  and herbs. They serve  and bread.  knew He would  soon. He wanted to eat one last  with His followers. That  was the Passover . Peter and John found an upstairs room to have the . They got the  ready. Then ' followers came to the .   to Peter, "Do not lose your faith. Before the  crows tonight, you will say you don't know me." Then   to his followers, "One of you will give me to my enemies." It was true. Judas sold  to His enemies. Later Peter , "I never knew Him." The  crowed, and Peter was sorry he had lied.



# The Lord's Supper

Mark 14:12-26; John 13:18-38

It was the time of the Feast of the Passover, a Jewish festival commemorating the time when the angel of the Lord passed over the homes of the Hebrews in Egypt rather than killing their firstborn sons.

When evening came, the twelve disciples sat down to eat with Jesus. He said to them, "I tell you the truth, one of you will betray me—one who is eating with me."

They were all upset at this news and one by one said to Jesus, "Surely not I?" Judas was the betrayer, but none of the others knew it.

Jesus broke the bread and gave some to His disciples. He said, "Take it; this is my body." Then He took the cup, gave thanks, and gave it to His disciples saying, "This is my blood of the covenant, which is poured out for many. I tell you the truth, I will not drink again of the fruit of the vine until that day when I drink it anew in the kingdom of God."

Simon Peter said to Jesus, "Lord, I will lay down my life for you." But Jesus knew that His disciples were not as strong as they thought.

"I tell you the truth," Jesus told Peter, "before the rooster crows, you will disown me three times."

Jesus spoke to His disciples with comforting words. He wanted to encourage them for the rough days ahead. Then they sang a hymn and went out together. Judas had already left to betray his master.

## Challenge:

Help the twelve disciples find their way to the Lord's Supper.

# The Lord's Supper

Read 1 Corinthians 11:23-29, 31, 32. Solve the math problems in each box. Circle the words in the box if the math solution is 15. Write the circled words in order at the bottom of the page to learn why Jesus asked us to observe the Lord's Supper.

$8+4+4=$	$4+3+8=$	$10-4+2=$	$15-1+2=$
JESUS	DO	BREAD	BODY
$10-2+7=$	$1+10+3=$	$14-5+4=$	$5+5+5=$
THIS	DRINK	NIGHT	IN
$6+10-1=$	$6+8+2=$	$4+3+7=$	$9-2+6=$
REMEM- BRANCE	PROCLAIM	EAT	BLOOD
$15-5+5=$	$16-2+3=$	$2+3+4=$	$9+9-3=$
OF	CUP	THANKS	ME

---



---

# THE LAST SUPPER

## (LUKE 22:7-20)

### MEMORY VERSE:

*"Then He said to them, 'With fervent desire I have desired to eat this Passover with you before I suffer; for I say to you, I will no longer eat of it until it is fulfilled in the kingdom of God.' "* LUKE 22:15-16

### FILL IN THE BLANKS:

1. "And He sent Peter and John saying, 'Go and prepare the \_\_\_\_\_ for us, that we may eat.' " LUKE 22:8
2. "And He said to them, 'Behold, when you have entered the city, a man will meet you carrying a \_\_\_\_\_ of water; follow him into the house which he enters." LUKE 22:10

### TRUE OR FALSE:

3. "Then you shall say to the master of the house, 'The Teacher says to you, "Where is the guest room in which I may eat the Passover with My disciples?" ' " LUKE 22:11  
TRUE OR FALSE

### FILL IN THE BLANKS:

4. "Then he will show you a large, furnished \_\_\_\_\_; there make ready." LUKE 22:12
5. "And when the hour had come, He sat down, and the twelve \_\_\_\_\_ with Him." LUKE 22:14

### TRUE OR FALSE:

6. "He took the cup and gave thanks, and said, 'Take this and divide it among yourselves.' " LUKE 22:17  
TRUE OR FALSE
7. "And He took bread, gave thanks and broke it, and gave it to them, saying, 'This is my body which is given for you; do this in remembrance of Me.' " LUKE 22:19  
TRUE OR FALSE

### FILL IN THE BLANKS:

8. "Likewise He took the cup after supper, saying, 'This cup is the \_\_\_\_\_  
\_\_\_\_\_ in My blood, which is shed for you.' " LUKE 22:20

# Jesus' Last Supper

Matthew 26:20-30

When \_\_\_\_\_ came, Jesus was \_\_\_\_\_ at the table with the \_\_\_\_\_. And while they were \_\_\_\_\_, he said, "I tell you the \_\_\_\_\_, one of you will \_\_\_\_\_ me."

They were very \_\_\_\_\_ and began to say to him one after the other, "\_\_\_\_\_ not I, Lord?"

Jesus \_\_\_\_\_, "The one who has \_\_\_\_\_ his hand into the \_\_\_\_\_ with me will betray me. The \_\_\_\_\_ of Man will go just as it is \_\_\_\_\_ about him. But \_\_\_\_\_ to that man who betrays the Son of \_\_\_\_\_! It would be \_\_\_\_\_ for him if he had not been \_\_\_\_\_."

Then \_\_\_\_\_, the one who \_\_\_\_\_ betray him, said, "\_\_\_\_\_ not I, Rabbi?"

Jesus \_\_\_\_\_, "Yes, it is you."

While they were eating, \_\_\_\_\_ took bread, gave \_\_\_\_\_ and \_\_\_\_\_ it, and gave it to his \_\_\_\_\_, saying, "Take and \_\_\_\_\_; this is my \_\_\_\_\_."

Then he took the \_\_\_\_\_, gave thanks and \_\_\_\_\_ it to them, saying, "\_\_\_\_\_ from it, all of you. This is my \_\_\_\_\_ of the \_\_\_\_\_, which is poured out for many for the \_\_\_\_\_ of sins. I tell you, I will not drink of this \_\_\_\_\_ of the \_\_\_\_\_ from now on until that day when I drink it \_\_\_\_\_ with you in my Father's \_\_\_\_\_."

When they had sung a \_\_\_\_\_, they went out to the \_\_\_\_\_ of Olives.

E A J B B A B E T R A Y B F  
 A C E D O E N A M E F O O R  
 T G S R R D H E D C W R F U  
 I S U Q E M Y E W L G D F I  
 N U S W P T P I J I K L E T  
 G R L O L P T M V N T U R S  
 E E N E I O Q E R I N O E O  
 K L D D E P N S B N A W D N  
 O Y R I D E M O D W X E H T N  
 R T I U S V C N I T N U O M A N  
 B H N S Y C N I T P C P O D K V  
 J U B D O T F A B L O O H E S E  
 D R D B T F A B L O O H E S E  
 A T W E L V E E R E W S N A L  
 S J N I K D E R E W S N A L



**The Last  
Supper  
Luke 22:7-20**

# The Most Important Meal

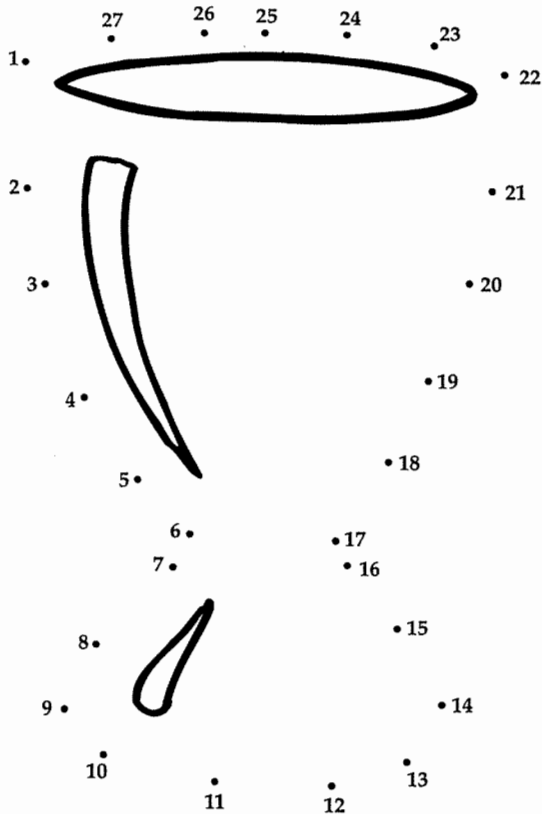

Jesus ate the Passover meal with his followers just before he died. He took two things from the table and told the followers that these two things would forever after be used to remember his death. What were these two things? To find out, complete the two dot-to-dots.

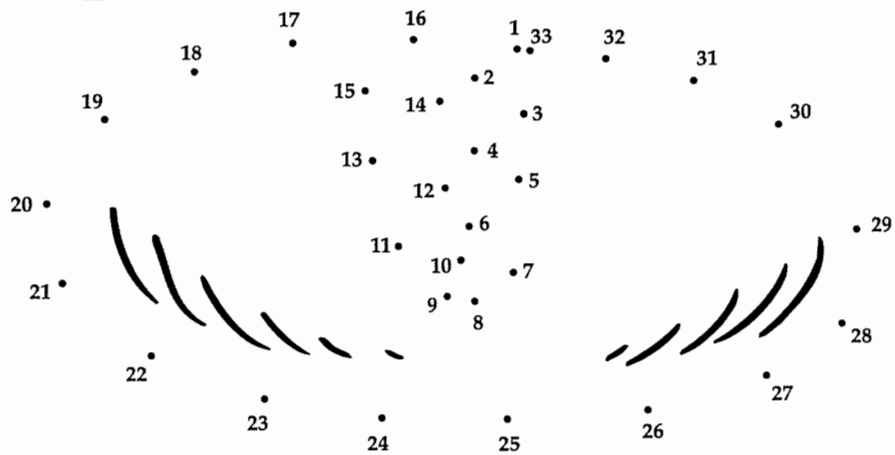

# 73. The Last Supper

Below are some sentences taken from Matthew 26:17–30. Fill in the blanks to find the answers for the crossword puzzle.

I will keep the (5) \_\_\_\_\_ at thy house with my disciples.

One of you shall (1) \_\_\_\_\_ me.

Take, eat; this is my (6) \_\_\_\_\_.

(4) \_\_\_\_\_ ye all of it.

For this is my (3) \_\_\_\_\_ of the new testament, which is

(2) \_\_\_\_\_ for many for the remission of sins.

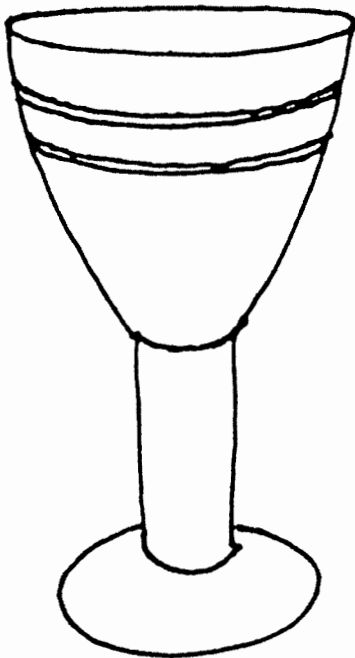
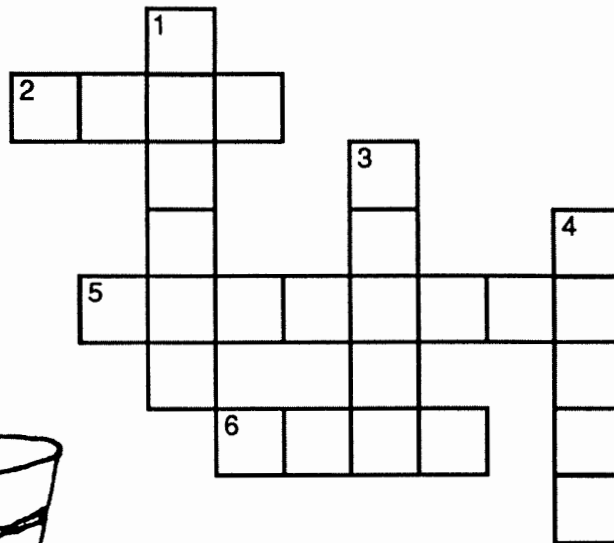

**The Lord's  
Supper  
Mark 14**

# What a Meal!

Jesus was eating the Passover meal on the night before he died. At this time he instituted a special meal called The Lord's Supper. Decipher the code below to find out what special ingredients are included in this meal and what each one represents.

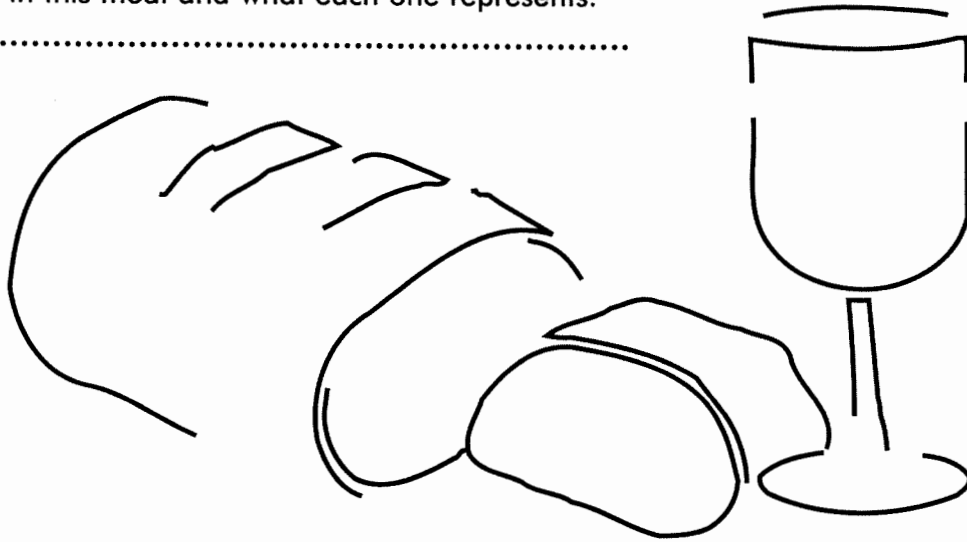

A=26, E=22, I=18, O=12, U=6

07 19 22

25 09 22 26 23

04 19 18 24 19

09 22 11 09 22 08 22 13 07 08

19 18 08

25 12 23 02

07 19 22

24 06 11

04 19 18 24 19

09 22 11 09 22 08 22 13 07 08

19 18 08

25 15 12 12 23

# THE LAST SUPPER

## (LUKE 22:7-20)

S U D D J T J M L D U U S O K P B C Y S Y T A V U D B I S V  
 Q K V C H P Y S S K B L Z J W E S E B Z B L V B O I H L O S  
 A N V B G S G O N B R Y R S W I M B C R F N T W B O Q N K D  
 N R L O B J H A P S J L O Z B P H Z M L P J P M T B A D S R  
 W F C P A V S L M H Z H J N L L V B B B N O G V L E E G J F  
 V J L O B D E K N P F B L W R E Y E A C I I F Z R O D W F N  
 V L V R H T Q N S P J K L I Q P B Q K R D M K Q F N B Z R V  
 W F N J P T M M I R F E A O B B L A I S I B K B F R I M C V  
 K Z M Y T Q B G H B E K C V R S M L L K L Z O U Z L Y F O B  
 U V D Y Q F B G T N O B G N H N E B O G G D C W R B Z A R W  
 O O J M B N C T Q G R D E M A U J F Z W R C T D F I S K L J  
 B B C G O F B E Q B I V H G N R L H I T A A N Y M D F Z S B  
 O C M B N T B L H L I O G D N W B V J D F B B N C V A E P E  
 Q D Y U B H Y S V G Y F N O V S D M Z C W F B B R Z K A E D  
 J Q S O B D U V Z L S B N T G C Z E E V V L Q P I R Q H F C  
 V L O V B T W P U N Y I W C R T P L T M B I D H P K S V Z V  
 O O J V I N D Z D B D Q B B B P D C T S E H Y Q Z E W L L H  
 I J I R F Y O S F Z Y R W V Z M E O I B Q R C O V G Y V V H  
 Z W M F A B K M H S B K B N L S B J J B J V Z Z Q I U R O A  
 E Z O W W P J B G V O D V V B D L I I Y B M Y F Q V F E L H  
 B N Y P B B Q A U M J F B M I Q I T J U O Y S L U M I R Z B  
 S Z D W B U B B Q O C H H U V H A B B F A E V Q S V E T J E  
 W C V V Y M Z I J N V L C O V E I I B D S Y B P D O O Q P U  
 Q U U G H L E Y V G G D R B T N R U R Q B Y T S E V Z S E D  
 O Z B J C N P T Q I W I O M L P O K B N W S G B B O E W N J  
 R H S T I Z Q F D C H P F G C T N B Q N D Q H U B F R S R T  
 G Z S F H H L Z D N H M O Q M L T T B F I B Q D U B I J B Q  
 C M O G W R A B D E B W Y O G Z V B H Y A Y Z Z Q J Y R I B  
 I U V J K A L C V B B L K T K T B F L I J J T O J Y M Q R U  
 G D Z W Y A L S V P B G E H M T K A E V S P W B A T S U B V

FIND THE WORDS FROM THE SCRIPTURE BELOW IN THE PUZZLE ABOVE

***"This is My body which is given for you; do this in remembrance of Me."***  
**LUKE 22:19**





# The Week Before Jesus Died

Jesus knew it was almost time for Him to die so all people could receive salvation. So Jesus went to Jerusalem. Many people were very happy to see Jesus and they sang praises as He rode into Jerusalem. During the week before He died, Jesus taught in the temple and He had a special meal with His disciples.

The clues and Bible verses will help you write the correct words in the crossword puzzle about the week before Jesus died.

## ACROSS

2. Jesus sent two disciples from here to bring Him a donkey. (*Matthew 21:1-2*)
5. Jesus said \_\_\_\_\_ would come "out of the mouth of babes and sucklings." (*Matthew 21:16*)
6. The disciples went to \_\_\_\_\_ a donkey for Jesus to ride.
7. Jesus was NOT an \_\_\_\_\_ king; He is the Heavenly King.
10. The last meal Jesus ate with the disciples before He died. (*Luke 22:17-20*)
11. As Jesus rode into Jerusalem, people used branches from this tree to praise Him. (*John 12:13*)

## DOWN

1. When Jesus got to Jerusalem, He went into the \_\_\_\_\_. (*Matthew 21:12*)
3. As Jesus rode into Jerusalem, the people called "\_\_\_\_\_ to the Son of David." (*Matthew 21:9*)
4. Jesus rode into Jerusalem on this animal. (The Bible calls this animal an ass.) (*John 12:12-14*)
6. Clothing; the disciples spread these on the back of the donkey. (*Luke 19:35*)
8. Number of pieces of silver Judas Iscariot received for betraying Jesus. (*Matthew 26:14-16*)
9. Satan entered into this man and he betrayed Jesus. (*Luke 22:3-6*)

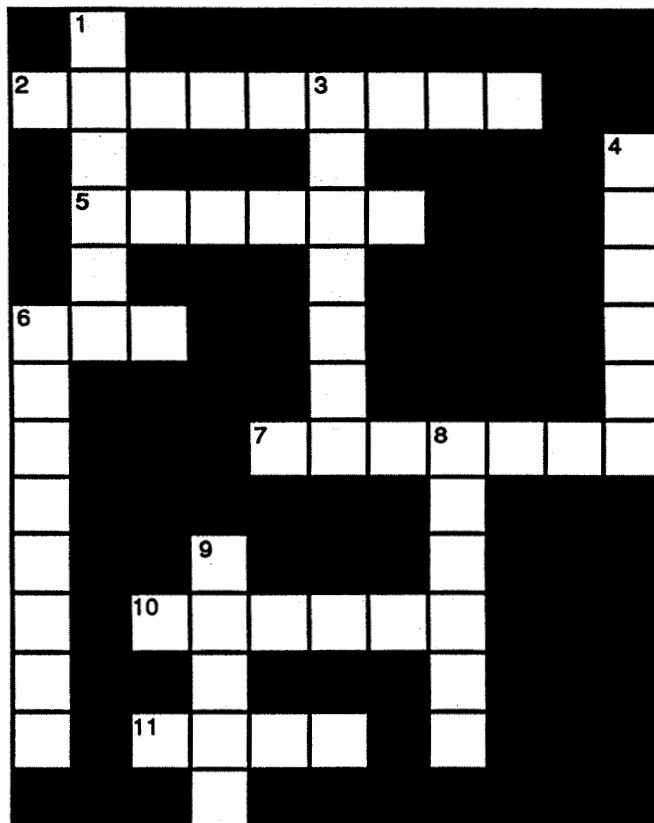

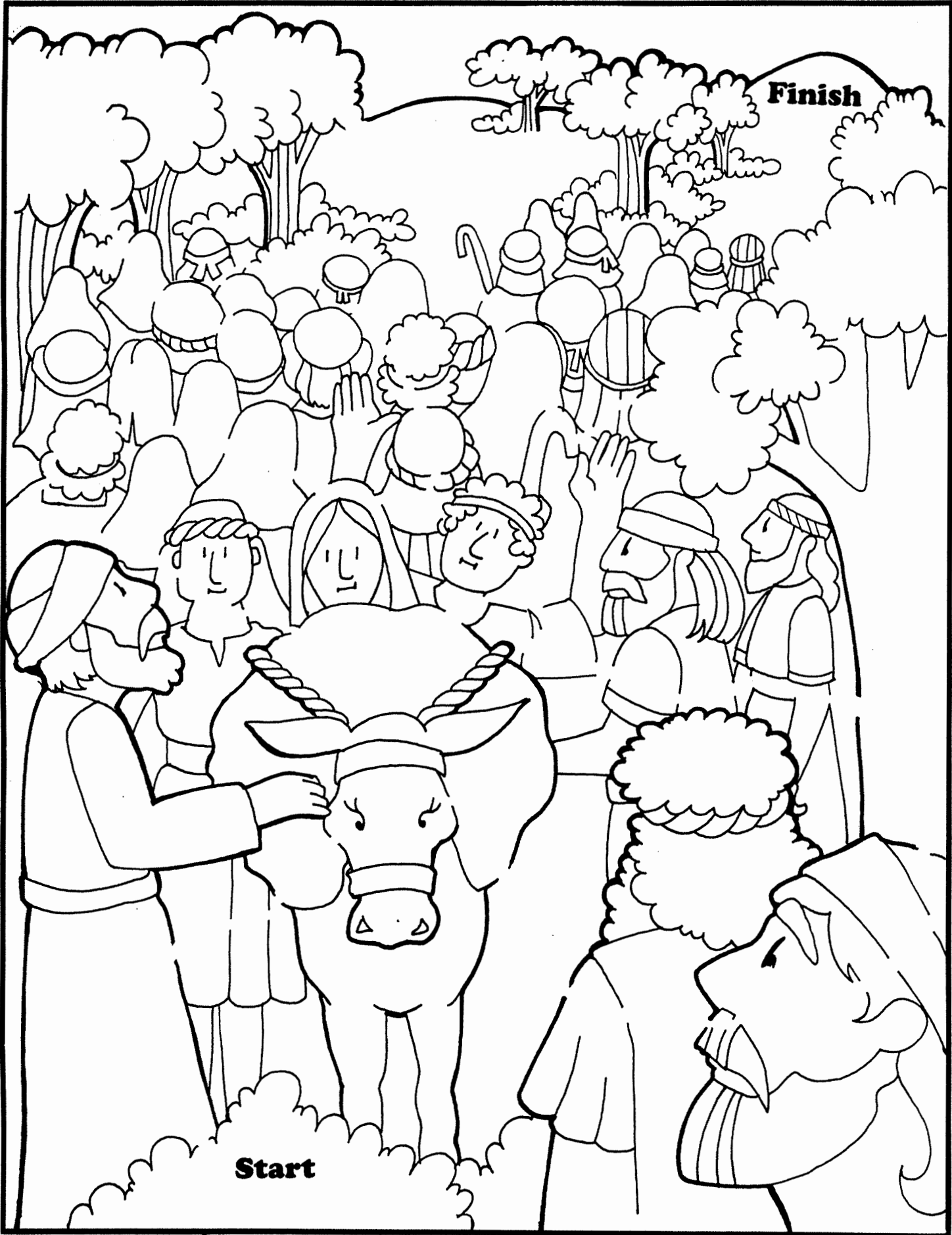

# Jesus Comforts His Disciples

John 14:18, 27

On the night before He died, at the Passover supper, Jesus taught His disciples many things. Jesus told His followers to love each other just like He loved them and to stay close to God after His death, and He promised that He would send the Holy Spirit to comfort them and give them strength and peace.

To find out two important things Jesus told His disciples, change the letters and numbers according to the code in the rectangle and write the correct words on the lines. Do not change letters which are not listed in the rectangle.

<b>Code:</b>	Change every	G	to	I	Change every	J	to	A
		Z	to	O		3	to	L
		Q	to	E		5	to	T

\_\_\_\_\_      \_\_\_\_\_      \_\_\_\_\_      \_\_\_\_\_  
G      W G 3 3      N Z 5      3 Q J V Q

\_\_\_\_\_      \_\_\_\_\_ : \_\_\_\_\_  
Y Z U      C Z M F Z R 5 3 Q S S      G

\_\_\_\_\_      \_\_\_\_\_      \_\_\_\_\_      \_\_\_\_\_  
W G 3 3      C Z M Q      T Z      Y Z U

John 14:18

\_\_\_\_\_      \_\_\_\_\_      \_\_\_\_\_      \_\_\_\_\_  
P Q J C Q      G      3 Q J V Q      W G 5 H

\_\_\_\_\_ , . . . .      \_\_\_\_\_      \_\_\_\_\_      \_\_\_\_\_  
Y Z U      3 Q 5      N Z 5      Y Z U R

\_\_\_\_\_      \_\_\_\_\_      \_\_\_\_\_ ,  
H Q J R 5      B Q      5 R Z U B 3 Q D

\_\_\_\_\_      \_\_\_\_\_      \_\_\_\_\_      \_\_\_\_\_  
N Q G 5 H Q R      3 Q 5      G 5      B Q

\_\_\_\_\_ .  
J F R J G D      John 14:27

# Jesus Tells Where He is Going

On the night before Jesus was to die, Jesus' friends were sad because Jesus would soon die. So Jesus comforted them by telling them He would be going to prepare a special place where His friends and all people who love Him can live with Him forever.

Unscramble the words on the signs and write them on the corresponding lines to find out where Jesus was going, what is there, and what Jesus was going to do. This is a good Bible verse to memorize too.

1      2      3      4      5

6      7      8      9      10

11      12      13      14

15      16      17      18

19      20      21      22

23      24      25

26

14:2

Signs along the road:

- 1: I (18)
- 2: TNO (11)
- 3: VAEH (FI 8, 15)
- 4: OS (12)
- 5: REA (5)
- 6: YAMN (6)
- 7: SAMNNOIS (26, 7)
- 8: FI (8)
- 9: TI (9)
- 10: WREE (10)
- 11: TNO (11)
- 12: OS (12)
- 13: I (13)
- 14: LOWUD (14)
- 15: VAEH (15)
- 16: DLOT (16)
- 17: UYO (17)
- 18: I (18)
- 19: OG (19)
- 20: OT (20)
- 21: RAREPPE (21)
- 22: A (22)
- 23: LACEP (23), SHOUE (4)
- 24: ROF (24)
- 25: UOY (25)
- 26: NJOH (26), SAMNNOIS (7)
- SRATEFH (3)
- NI (1)

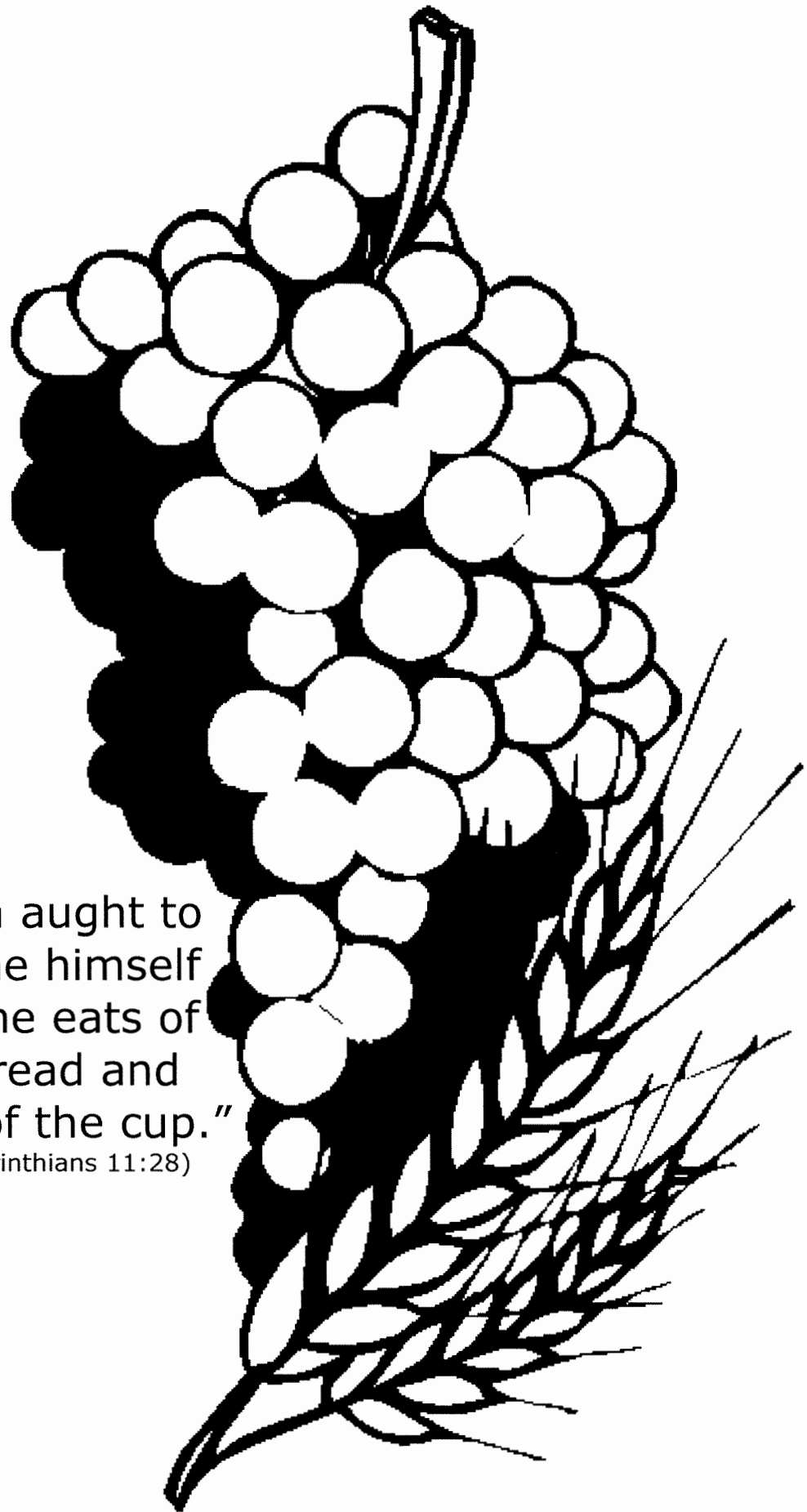

"A man ought to  
examine himself  
before he eats of  
the bread and  
takes of the cup."

(I Corinthians 11:28)

**Year 3**

**Week 139**

## **Jesus in the Garden**

**Scriptures: Luke 22:21-62, Matt 26:30-56**

**Key Verse: Matt 26:39** He went a little farther and fell on His face and prayed, saying, "O, my Father, if it be possible, let this cup pass from me; nevertheless, not as I will, but as You will"

### **Key Points:**

1. Jesus and His disciples go to the Mount of Olives after the Passover feast. Jesus tells Peter that he will betray Him, but Peter says that he would never do that.
2. They come to the Garden of Gethsemane, and Jesus asks the disciples to wait while He goes to pray. He takes Peter, James and John with Him to wait with Him.
3. Jesus goes off to pray 3 times, asking God to keep this thing from happening to him, but that God's will be done. After each time He prays, He goes back to find His disciples sleeping. After the last time, Jesus tells them to rise, for His betrayers are at hand.
4. A band of soldiers come with Judas and the chief priests. Judas kisses Jesus, the sign of betrayal that had been agreed upon, and the soldiers laid hands on Jesus. Peter draws his sword and cuts off the ear of the high priest's servant. Jesus scolds Peter and heals the servant's ear.
5. The soldiers take Jesus away, and Peter follows a ways behind.
6. Peter is asked three times if he is with Jesus and if he was one of the Lord's followers. Three times Peter denies Him, and after the third time the rooster crowed and Peter wept bitterly, remembering everything that Jesus had told him.



**"Now my heart is troubled, and what shall I say?  
'Father, save me from this hour'? No, it was for  
this very reason I came to this hour."**

# THE GARDEN OF GETHSEMANE

(LUKE 22:39-53)

S K I S S Q J T O D T D N U W  
L J E B J U D V U B W V Z L T  
E U C Q D E W I L L L S L D A  
E O N A S N Y A R T E B B E E  
P E S E L P I C S I D P T L W  
I E Q K U R J R S R U O Y A S  
N P A P R A Y F G C A M M E B  
G T L R E Y I Y N O G A O H K  
E S E V I L O F O T N U O M S  
V C K L A T L E N K P R E P M  
A S D O O L B E B B P E M M S  
R C D W V Y P J B K A H B C W  
T E M P T A T I O N B T N C O  
L H D K D L E G N A V A O V R  
W U O I S U S E J A Q F B Z D

AGONY  
ANGEL  
BETRAY  
BLOOD  
CUP  
DISCIPLES

EAR  
FATHER  
HEALED  
JESUS  
JUDAS

KISS  
KNELT  
MOUNT OF OLIVES  
PRAY  
SLEEPING

SWEAT  
SWORD  
TEMPTATION  
WILL  
YOURS





# 74. Peter's Denial

Write down every other letter starting with the "L" to find two things Peter said on the night Jesus was arrested.

-----, -----

-----

-----

-----

-----, -----

-----

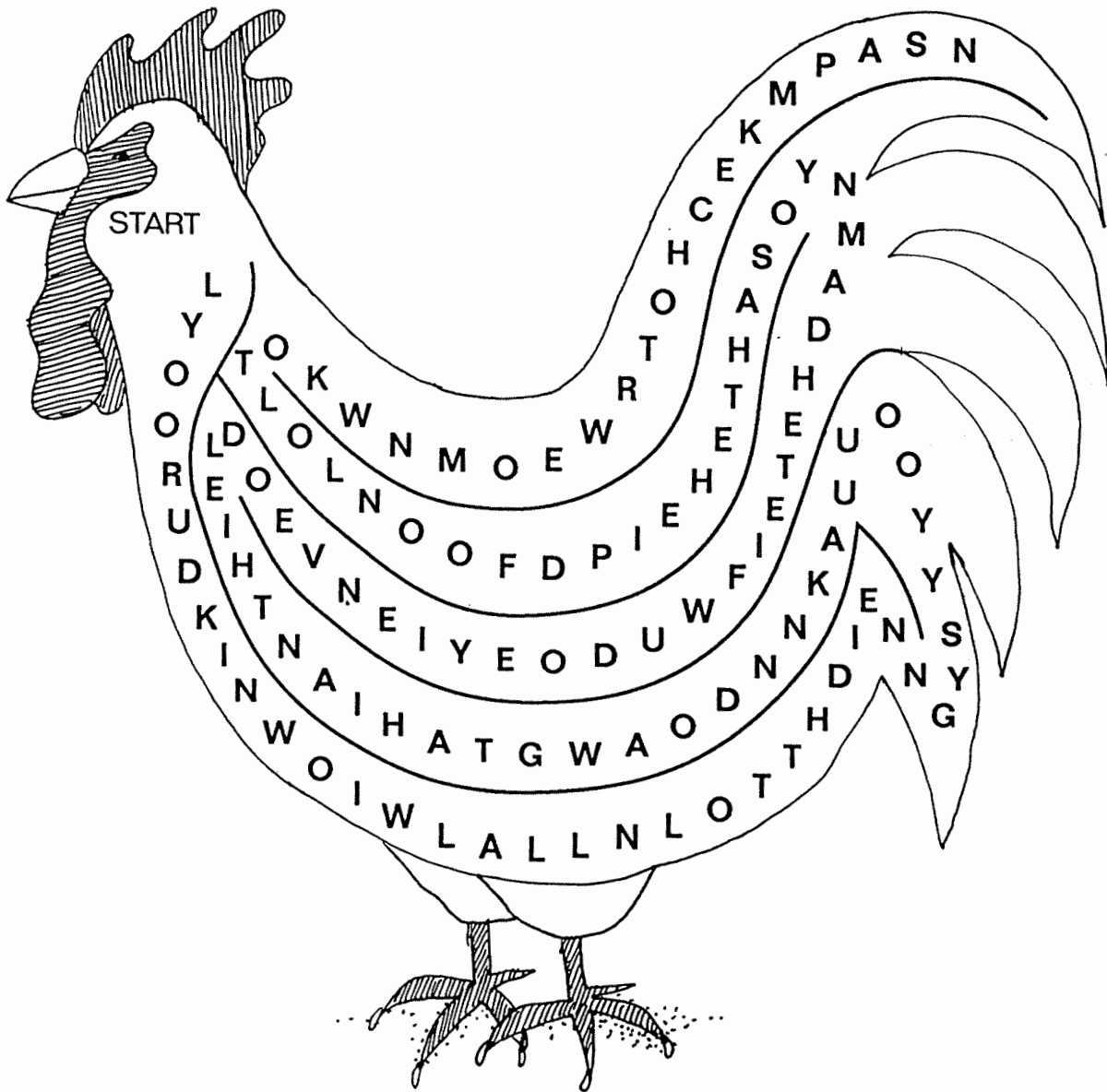

# THE GARDEN OF GETHSEMANE

## (LUKE 22:39-53)

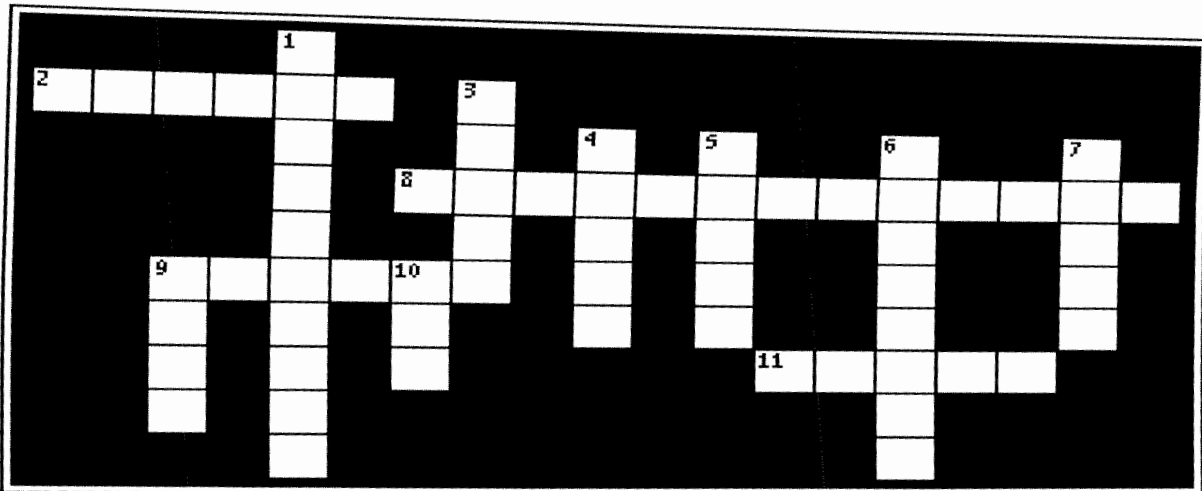

- 8 ACROSS "Coming out, He went to the \_\_\_\_\_, as He was accustomed, and His disciples also followed Him." **LUKE 22:39**
- 9 DOWN "When He came to the place, He said to them, '\_\_\_\_\_ that you may not enter into temptation.'" **LUKE 22:40**
- 9 ACROSS "And He was withdrawn from them about a stone's throw, and He knelt down and \_\_\_\_\_." **LUKE 22:41**
- 5 DOWN "...Father, if it is Your will, take this cup away from Me. Nevertheless not My will, but \_\_\_\_\_, be done.'" **LUKE 22:42**
- 4 DOWN "Then an \_\_\_\_\_ appeared to Him from heaven, strengthening Him." **LUKE 22:43**
- 3 DOWN "...His sweat became like great drops of \_\_\_\_\_ falling to the ground." **LUKE 22:44**
- 6 DOWN "When He rose up from prayer, and had come to His disciples, He found them \_\_\_\_\_ from sorrow." **LUKE 22:45**
- 1 DOWN "Then He said to them, 'Why do you sleep? Rise and pray, lest you enter into \_\_\_\_\_.'" **LUKE 22:46**
- 7 DOWN "And while He was still speaking, behold, a multitude; and he who was called Judas, one of the twelve, went before them and drew near to \_\_\_\_\_ to kiss Him." **LUKE 22:47**
- 10 DOWN "...one of them struck the servant of the high priest and cut off his right \_\_\_\_\_." **LUKE 22:50**
- 2 ACROSS "But Jesus answered and said, 'Permit even this.' And He touched his ear and \_\_\_\_\_ him." **LUKE 22:51**
- 11 ACROSS "Then Jesus said to the chief priests, captains of the temple, and the elders who had come to Him, 'Have you come out, as against a robber, with swords and clubs? When I was with you daily in the temple, you did not try to \_\_\_\_\_ Me. But this is your hour, and the power of darkness.'" **LUKE 22:52-53**

# THE GARDEN OF GETHSEMANE

## (LUKE 22:39-53)

### MEMORY VERSE:

"Pray that you may not enter into temptation." LUKE 22:40

### TRUE OR FALSE:

1. "Coming out, He went to the Mount of Olives, as He was accustomed, and His disciples also followed Him." LUKE 22:39

TRUE OR FALSE

2. "When He came to the place, He said to them, 'Pray that you may not enter into temptation.'" LUKE 22:40

TRUE OR FALSE

### FILL IN THE BLANK:

3. "And He was withdrawn from them about a stone's throw, and He knelt down and \_\_\_\_\_." LUKE 22:41

### TRUE OR FALSE:

4. "...Father, if it is Your will, take this cup away from Me. Nevertheless not My will, but Yours, be done.'" LUKE 22:42

TRUE OR FALSE

### FILL IN THE BLANKS:

5. "Then an \_\_\_\_\_ appeared to Him from heaven, strengthening Him." LUKE 22:43

6. "...His sweat became like great drops of \_\_\_\_\_ falling to the ground." LUKE 22:44

7. "When He rose up from prayer, and had come to His disciples, He found them \_\_\_\_\_ from sorrow." LUKE 22:45

8. "Then He said to them, 'Why do you sleep? Rise and pray, lest you enter into \_\_\_\_\_.'" LUKE 22:46

### TRUE OR FALSE:

9. "And while He was still speaking, behold, a multitude; and he who was called Judas, one of the twelve, went before them and drew near to Jesus to kiss Him." LUKE 22:47

TRUE OR FALSE

### FILL IN THE BLANKS:

10. "...one of them struck the servant of the high priest and cut off his right \_\_\_\_\_." LUKE 22:50

11. "But Jesus answered and said, 'Permit even this.' And He touched his ear and \_\_\_\_\_ him." LUKE 22:51

### TRUE OR FALSE:

12. "Then Jesus said to the chief priests, captains of the temple, and the elders who had come to Him, 'Have you come out, as against a robber, with swords and clubs? When I was with you daily in the temple, you did not try to seize Me. But this is your hour, and the power of darkness.'" LUKE 22:52-53

TRUE OR FALSE

# JESUS ARRESTED

WORD SEARCH PUZZLE

FIND THE BOLD WORDS FROM MATTHEW 26:47-56 THAT ARE HIDDEN IN THIS PUZZLE. THEY MAY BE SPELLED IN A FORWARD, BACKWARD, VERTICAL, HORIZONTAL, OR DIAGONAL WAY.

"THIS HAS ALL TAKEN PLACE THAT THE WRITINGS OF THE \_\_\_\_\_ MIGHT BE FULFILLED" (MATTHEW 26:56).

AFTER YOU HAVE CIRCLED ALL THE HIDDEN WORDS, USE THE REMAINING LETTERS TO SPELL THE WORD THAT COMPLETES THE SCRIPTURE VERSE ABOVE.

SRJIBBAR  
SEMUPRRE  
DHIIDORV  
RTPZHAEL  
OANGELSE  
WFNAMDTW  
SHDWORCT  
PRIESTSE  
TSDNEIRF

- Vs. 47. WHILE HE WAS STILL SPEAKING, **JUDAS**, ONE OF THE **TWELVE**, ARRIVED. WITH HIM WAS A LARGE **CROWD** ARMED WITH **SWORDS** AND CLUBS, SENT FROM THE CHIEF **PRIESTS** AND THE ELDERS OF THE PEOPLE.
- Vs. 48. NOW THE BETRAYER HAD ARRANGED A SIGNAL WITH THEM: "THE ONE I KISS IS THE **MAN; ARREST HIM.**"
- Vs. 49. GOING AT ONCE TO JESUS, **JUDAS** SAID, "GREETINGS, **RABBI!**" AND KISSED HIM.
- Vs. 50. JESUS REPLIED, "**FRIEND**, DO WHAT YOU CAME FOR." THEN THE MEN STEPPED FORWARD, **SEIZED** JESUS AND ARRESTED HIM.
- Vs. 53. "DO YOU THINK I CANNOT CALL ON MY **FATHER**, AND HE WILL AT ONCE PUT AT MY DISPOSAL MORE THAN TWELVE LEGIONS OF **ANGELS?**"
- Vs. 54. BUT HOW THEN WOULD THE SCRIPTURES BE FULFILLED THAT SAY IT MUST HAPPEN IN THIS WAY?"

# Important Places in Jesus' Last Week

---

Many important events happened in the week just before Jesus died. Unscramble where these important events happened and write the location on the line after the scrambled word. Then write the number of the event that happened at the location on the line in front of the scrambled word. The first one is done for you. The first letter of each scrambled word is underlined.

\_\_\_ BOIM \_\_\_\_\_

\_\_\_ CHERIJO \_\_\_\_\_

1 HGEEAHTBP BETHPHAGE \_\_\_\_\_

\_\_\_ HTGGLOAO \_\_\_\_\_

\_\_\_ SMEEAENTHG \_\_\_\_\_

\_\_\_ MPIEEL \_\_\_\_\_

\_\_\_ NMTUO FQ VIQELS \_\_\_\_\_

\_\_\_ RPEUP OOMR \_\_\_\_\_

\_\_\_ RSLEMEJUA \_\_\_\_\_

1. When Jesus and the disciples reached this place east of Jerusalem, Jesus sent two disciples to get a donkey. (*Matthew 21:1-3*)
2. Jesus and His disciples ate the Passover meal or Last Supper here. (*Mark 14:12-16*)
3. After the Last Supper, Jesus prayed here, while some of the disciples slept. (*Mark 14:32-42*)
4. Jesus was nailed to the cross on this hill outside the walls of Jerusalem. (*Mark 15:22-25*)
5. After Jesus and His disciples sang a hymn, they went to this hill. (*Mark 14:26*)
6. This was the last city Jesus visited before going to Jerusalem to die. Jesus healed blind Bartimaeus here. (*Mark 10:46-52*)
7. People praised Jesus as He rode a donkey into this city. (*Mark 11:7-11*)
8. A great stone was rolled across the door while Jesus' body was inside. (*Matthew 27:59-60*)
9. Jesus went here and cast out the people who were selling and conducting business. (*Matthew 21:12-15*)

# MATTHEW 19:13-15

YRAP

NIS

RNEDIH

MEAN

NEVHEA



THE DISCIPLES DIDN'T THINK THE LITTLE CHILDREN SHOULD BE...

OR

# MARK 14:54-72

SEFAL

LIRG

WOFELL

ENTCCA

REUBILD

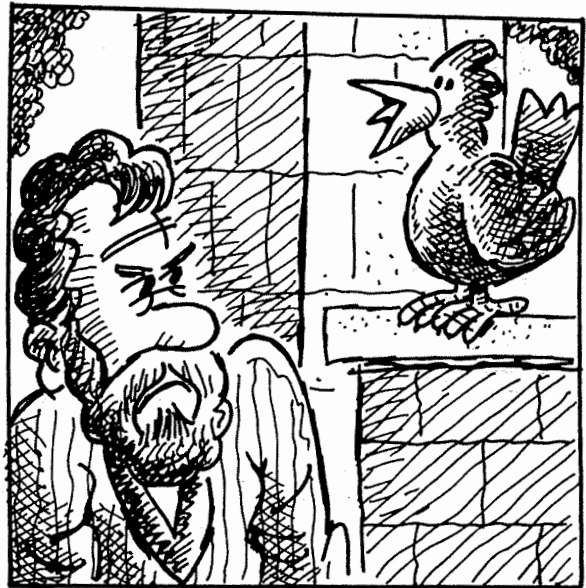

WHAT PETER DIDN'T WANT TO HEAR IN THE COURTYARD OF THE HIGH PRIEST:

# Jesus' Death

Mark 14:43-50; John 18:1—19:18

After the Lord's Supper, Jesus and His disciples went to the Garden of Gethsemane to pray.

Judas knew where Jesus was. He took soldiers and guards there. With a kiss, Judas signaled the guards that this man was the one called Jesus. They arrested Jesus and led Him to the high priest where He was questioned.

Meanwhile Simon Peter stood warming his hands by a fire in the courtyard. One of the high priest's servants asked Peter if he had been in the garden with Jesus. Peter denied it. He was asked two more times if he was one of the disciples with Jesus. Peter denied even knowing Jesus. At that moment a rooster crowed.

The high priest sent Jesus to Pilate, the Roman governor. Pilate questioned Jesus. Then he said to the Jews, "Look, I am bringing him out to you to let you know that I find no basis for a charge against him. What shall I do with him?"

"Crucify him!" the people shouted. So Jesus was condemned to die on a cross.

The soldiers made Jesus carry His own cross to Golgotha, where they crucified Him with two thieves, one on each side.

## Challenge:

Find a way through the crowds to the place where Jesus was crucified.

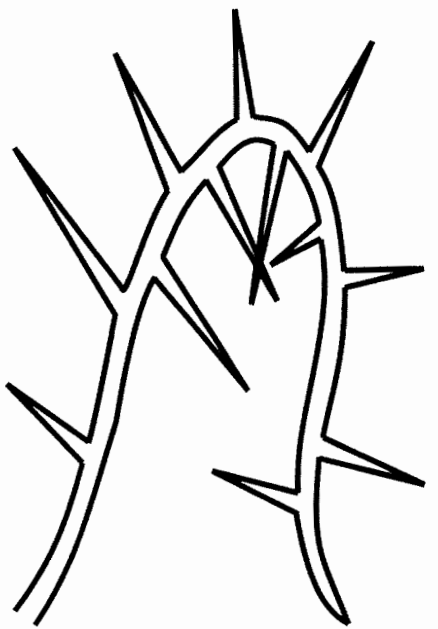
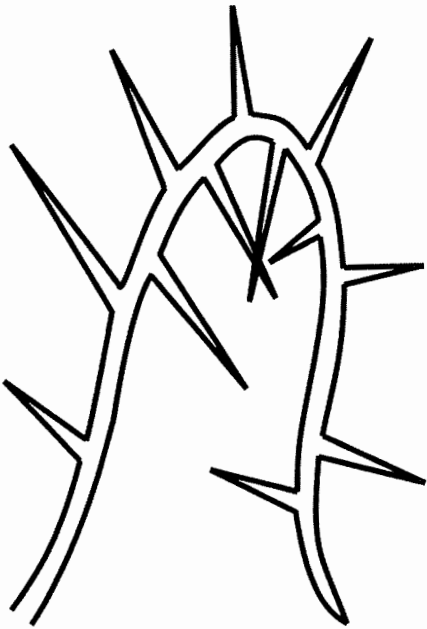
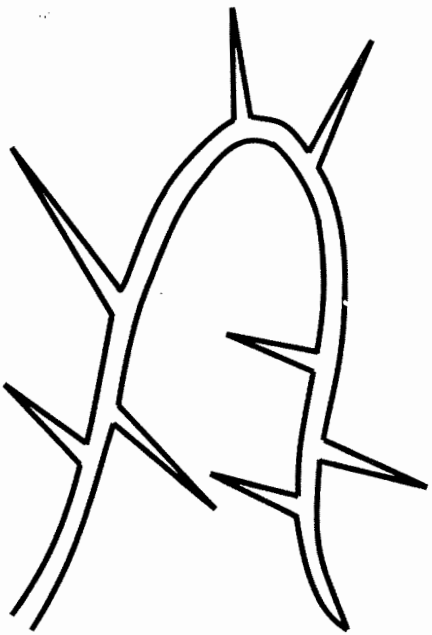
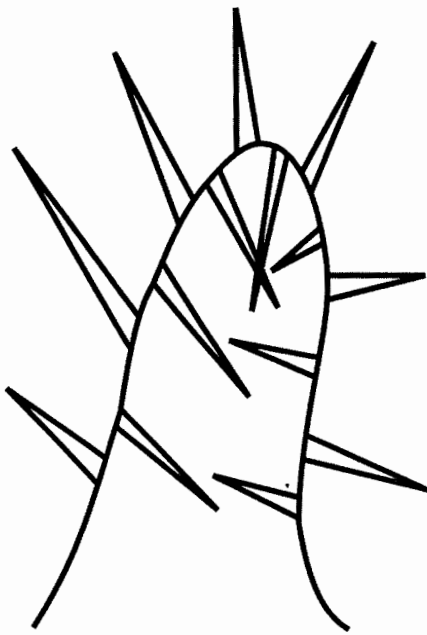
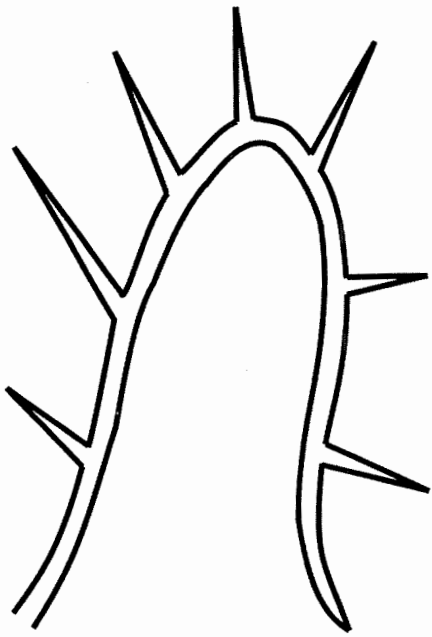

Jesus was king. Some people hated Him. They made a crown. It was not a beautiful crown. It was made of thorns. They put the crown on Jesus' head. The thorns hurt Jesus.  
John 19:2



# THE PASSION STORY

THE "PASSION" STORY DESCRIBES THE FINAL DAYS OF CHRIST'S LIFE, INCLUDING HIS BETRAYAL, ARREST, SUFFERINGS AND CRUCIFIXION, USE THE PICTURE CLUES TO IDENTIFY SOME OF THE EVENTS OF THE PASSION STORY, AND PUT THEM IN THE ORDER THEY OCCURRED.

(MATTHEW 26-28:10)

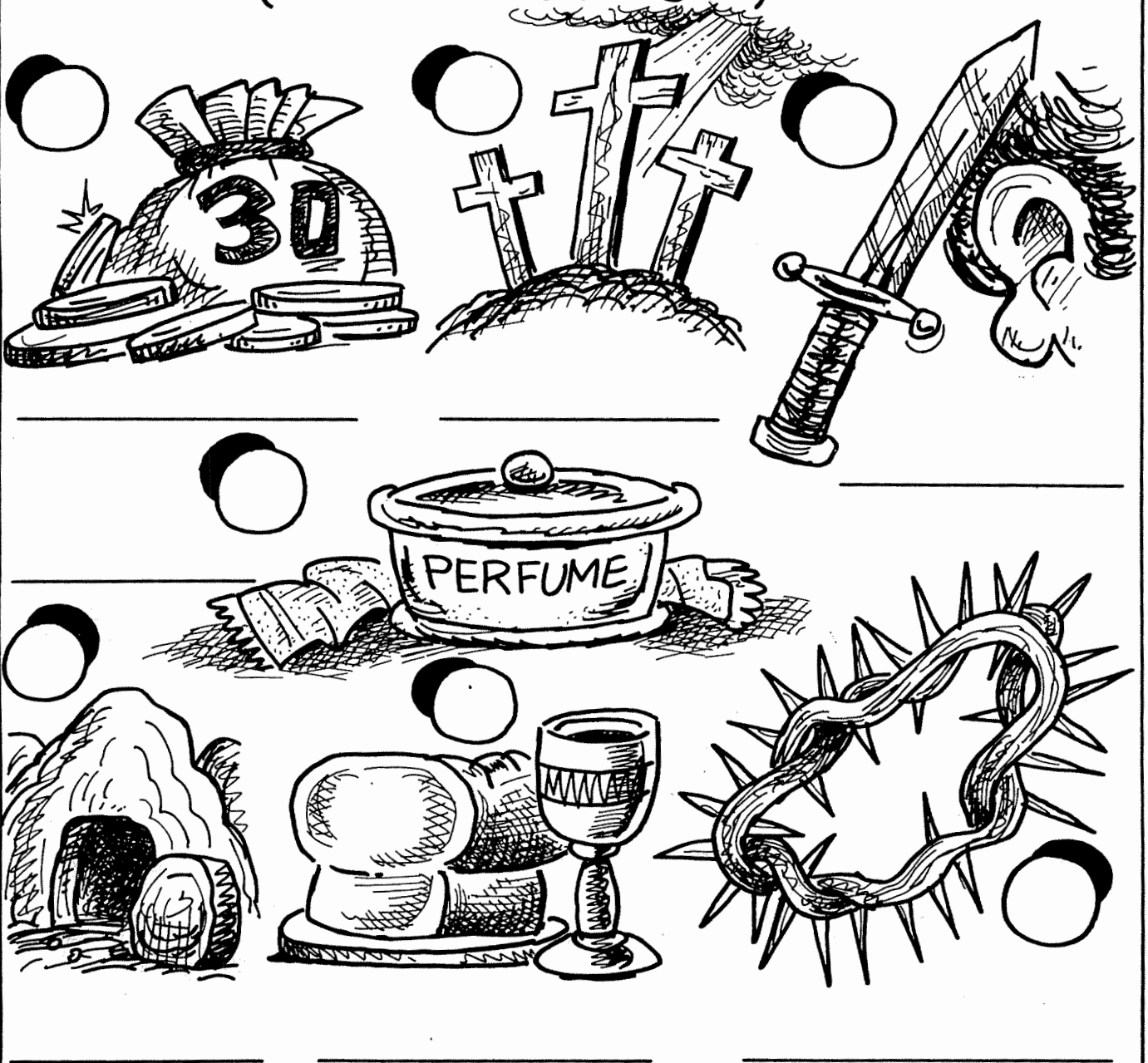

# Jesus Forgives a Thief

When Jesus died on the cross, two criminals were crucified beside Him. They deserved to die for their crimes, but Jesus had done no wrong. Jesus died to take the punishment for our sins. One of the thieves made fun of Jesus, but the other one realized that Jesus could forgive him and provide the way to heaven. Jesus said to him, "Today shalt thou be with Me in paradise."

The hidden words come from this story in Luke 23:38-43. The code following each word tells the coordinate where one of the letters of the word is found in the puzzle. After you have found and circled all the hidden words, start at the upper left and use all the leftover letters to fill in the blanks at the bottom of the page with the words of a Bible verse which says that anyone who comes to Jesus will be saved.

		A	B	C	D	E	F	G	H	I	J	K	L	M	N		
AMISS (7D)	1	N	O	I	T	P	I	R	C	S	R	E	P	U	S	1	MAN (2B)
ANSWERING (8E)	2	E	A	A	L	L	T	C	H	E	A	T	V	T	S	2	NOTHING (6J)
CHRIST (3F)	3	T	H	M	S	E	H	F	H	A	T	H	E	A	R	3	OTHER (3H)
DUE (12A)	4	T	G	I	S	R	E	T	T	E	L	V	Y	E	S	4	PARADISE (10B)
FEAR (15F)	5	I	T	H	I	M	O	E	S	H	A	I	L	L	C	5	RAILED (14E)
GREEK (11C)	6	R	O	S	M	N	O	T	H	I	N	G	M	E	T	6	RECEIVE (12E)
INDEED (8G)	7	W	T	O	A	M	E	A	C	G	N	N	D	H	K	7	REMEMBER (16C)
JEWS (9H)	8	I	M	T	H	A	G	I	A	A	T	I	C	O	I	8	SAME (10J)
KING (11F)	9	M	E	G	T	H	N	T	J	O	F	E	M	E	N	9	SAVE (4N)
KINGDOM (8N)	10	P	A	R	A	D	I	S	E	I	M	E	W	Y	G	10	SAYING (5K)
LATIN (13L)	11	I	L	E	E	L	K	I	W	A	N	S	L	N	D	11	SEEING (8K)
LETTERS (4J)	12	D	U	E	O	C	F	W	S	E	I	I	A	A	O	12	SUPERScription (1G)
LORD (16B)	13	S	D	K	E	C	E	A	S	T	R	O	T	U	M	13	VERILY (15H)
MALEFACTORS (12M)	14	T	R	J	O	R	A	I	L	E	D	I	I	H	N	14	WRITTEN (7A)
	15	S	O	I	X	T	R	H	V	I	R	T	N	Y	S	15	
	16	E	L	R	E	B	M	E	M	E	R	V	E	G	N	16	
		A	B	C	D	E	F	G	H	I	J	K	L	M	N		

**HIDDEN VERSE:** \_\_\_\_\_  
 \_\_\_\_\_ ; \_\_\_\_\_  
 \_\_\_\_\_  
 \_\_\_\_\_ . \_\_\_\_\_ :

# Jesus Is Crucified

## Matthew 27:32-61

# 5

### MEMORY VERSE

*They led him away to crucify him.*  
~ Matthew 27:31



### WHAT YOU NEED

- page 84, duplicated
- 9" paper plates
- crayons
- safety scissors
- glue
- hole punch
- yarn

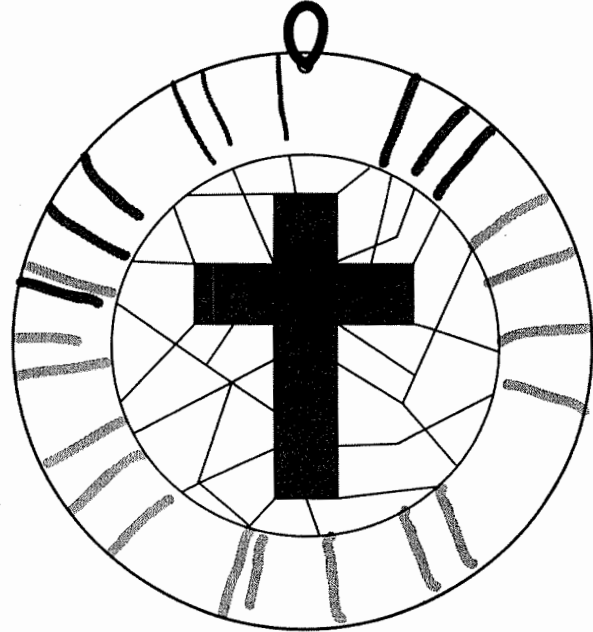

### BEFORE CLASS

Duplicate a pattern page for each child. For younger children, cut the circle from the page. Make a sample craft to show the children.



### WHAT TO DO

1. Introduce the lesson by telling about the arrest, trial and crucifixion of Jesus from Matthew 27:32-61. Say, **Everything Jesus did was to show us how much God loves us.**
2. Show the children the sample craft.
3. Distribute a pattern page to each child.
4. Say the memory verse.
5. Have the children cut out the circle from the page.
6. They should color all shapes with a dot brown.
7. Help the children glue the circle in the center of the plate.
8. Go around and punch a hole in the top of the plaque and thread a length of yarn through it. Tie for a hanger. Say, **When you see your cross, remember that God sent Jesus because He loves us.**



### EXTRA TIME

Have the children color the spaces without a dot yellow. After gluing the circle to the plate, allow the children to decorate the edge of the plate with crayons or markers.



ake a cross plaque to help you remember that Jesus died on a cross for our sins.

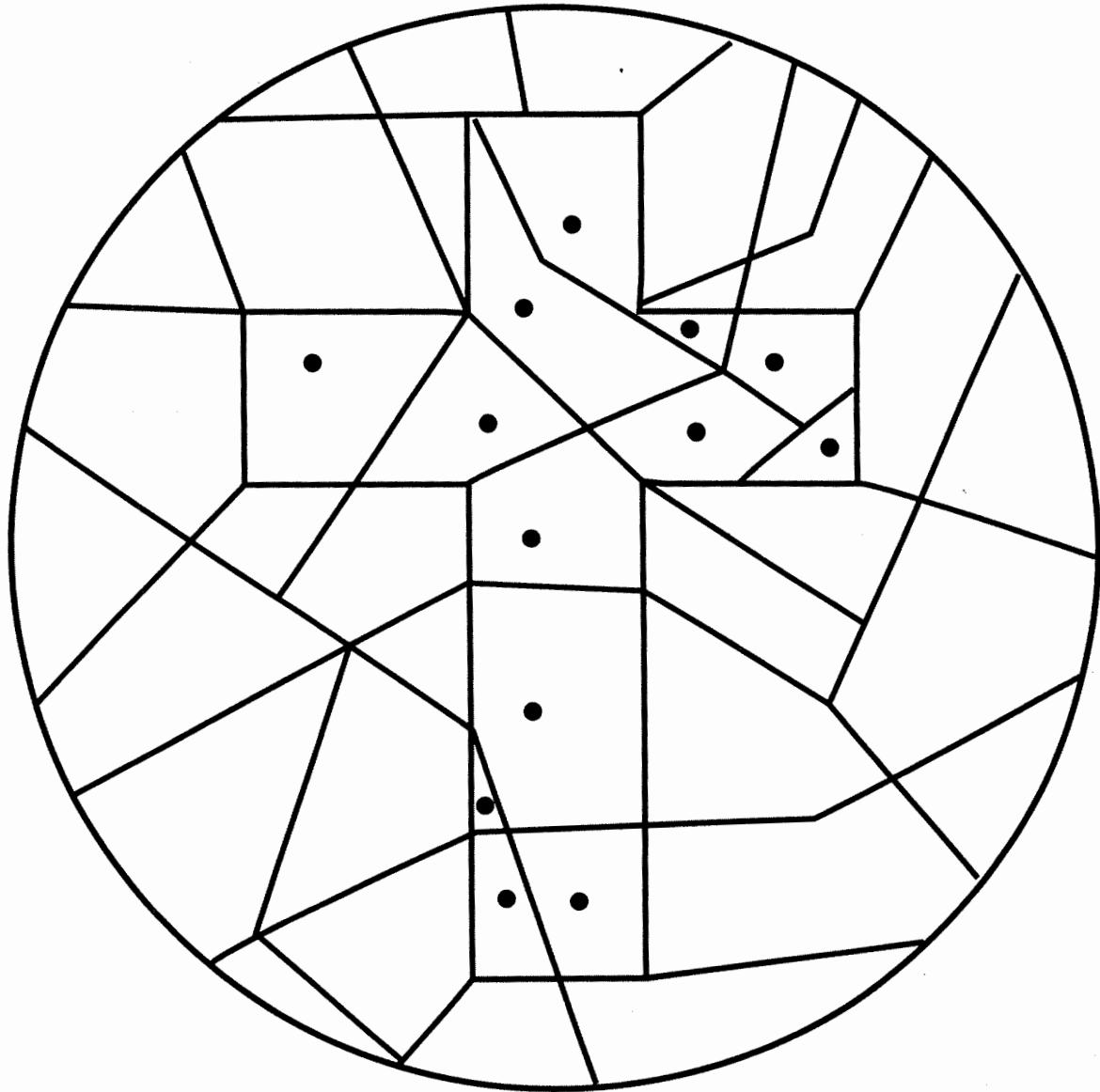

# Where Did Jesus Die?

Jesus died so that we do not need to have the eternal punishment we deserve for the sinful things we do. Jesus took our punishment instead. The way Jesus died is called crucifixion. It is very painful, but Jesus suffered the pain so our sins can be forgiven. All we have to do is ask Jesus to forgive us.

Start at the bottom right corner and connect the dots in counterclockwise order to show where Jesus died. As you connect each dot, write the number beside the dot on the short lines. Then use the code to write the corresponding letters on the long lines to find out what Jesus did so we can be forgiven. Have *you* asked Jesus to forgive you?

35 ● ● 5

45 ● ● 10 ● ● 10 ● ● 15 ● ●

40 ● ● 50 ● ● 10 ● ● 25 ● ●

- A = 5
- D = 10
- E = 15
- G = 20
- I = 25
- J = 30
- N = 35
- O = 40
- R = 45
- S = 50
- U = 55

\_\_\_\_\_

-----

\_\_\_\_\_

-----

\_\_\_\_\_

-----

\_\_\_\_\_

-----

\_\_\_\_\_

-----

5 ● ● 15 ● ●

20 ● ● 50 ● ● 55 ● ●

50 ● ● 50 ● ● 15 ● ●

25 ● ● 35 ● ● 30 ● ●

START HERE

# People at the Crucifixion

Jesus' crucifixion and death were important events to the people of Jerusalem. In fact, the Bible says there was darkness during the time Jesus was on the cross, and when He died there was an earthquake, so most people probably knew something important was happening. The Bible tells us about many people who were part of these important events.

Most of the clues in this puzzle identify people the Bible tells about. Write their names correctly in the puzzle. If you need help, look up the Bible verses.

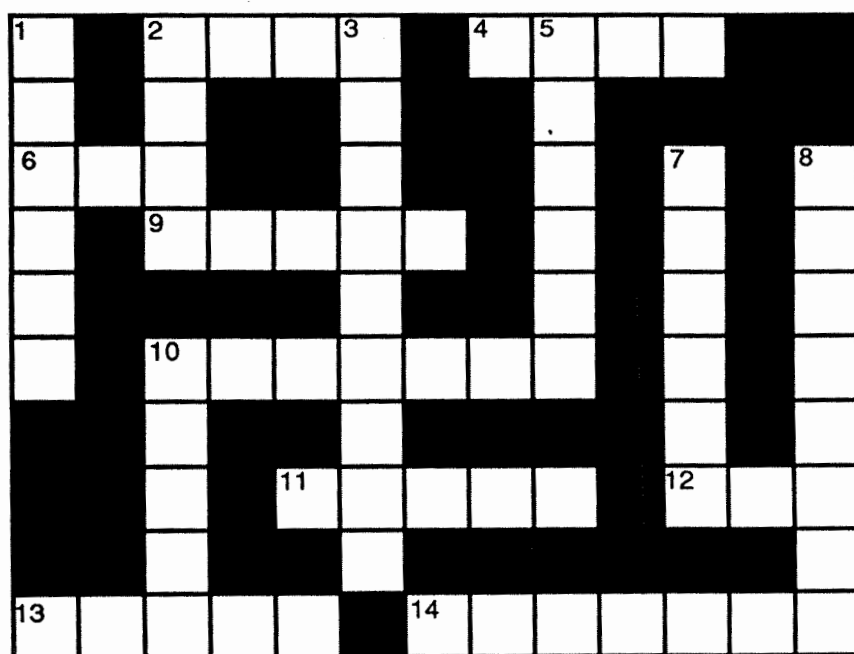

## ACROSS

2. Peter and this man prepared the Passover. *(Luke 22:8)*
4. From the cross, Jesus said to her, "Woman, behold thy Son." *(John 19:25-26; Acts 1:14)*
6. To stitch together with needle and thread.
9. He was from Cyrene and carried the cross for Jesus. *(Luke 23:26)*
10. Annas and Caiaphas were High \_\_\_\_\_ . *(Luke 3:2)*
11. He betrayed Jesus for 30 pieces of silver. *(Matthew 26:14-16)*
12. A female sheep.
13. This wicked ruler who wanted to see a miracle. *(Luke 23:8)*
14. Two of these were crucified with Jesus. *(Matthew 27:38)*

## DOWN

1. He provided his own tomb for the Savior. *(Matthew 27:57-60)*
2. They said Jesus should die because He said He was the Son of God. *(John 19:7)*
3. Believer who helped to bury Jesus. *(John 19:39-42)*
5. Mary Magdalene saw two of these at Jesus' tomb. *(John 20:11-12)*
7. He condemned Jesus to please the Jews. *(Luke 23:13-25)*
8. They crucified Jesus and divided up His clothing. *(John 19:23-24)*
10. He denied He knew Jesus. *(John 18:25-27)*

# Jesus Dies for Us

For about three years, Jesus traveled around His country, healing the sick and teaching about God. Many people loved Jesus, but His enemies were determined to kill Him. Finally one of Jesus' own disciples betrayed Him and Jesus was killed on a cross. Jesus let Himself be killed to pay for our sins because this is what God wanted. After Jesus had been dead three days, He came back to life again! Jesus is alive today.

Complete the crossword about Jesus' death and resurrection by using the clues to fill in the correct words. Look up the Bible verses if you need help.

## ACROSS

1. He betrayed Jesus with a kiss. *(Matthew 26:47-49)*
5. Abbreviation for street.
7. Jesus said, "This is My blood. . .which is \_\_\_\_\_ for many." *(Matthew 26:28)*
9. God's Son.
12. When a bill is due, a person \_\_\_\_\_ money.
14. The angel said, "He is risen from the dead; and... goeth before you into \_\_\_\_\_." *(Matthew 28:7)*
19. Disciple who ran to tomb and entered first. *(John 20:4-6)*
20. At this time.
23. Peter's action after he denied Jesus. *(Matthew 26:75)*
26. Familiar greeting.
27. Jesus healed this after one of the disciples cut it off. *(Luke 22:50-51)*
30. High priest who prophesied that Jesus should die for that nation. *(John 11:47-51)*
34. To question; she \_\_\_\_\_ed for a new dress.
36. Washed his hands and said: "I am innocent of the blood of this just person." *(Matthew 27:24)*
37. A long period of time.
39. Jesus: "Blessed are they that have not \_\_\_\_\_, and yet have believed." *(John 20:29)*
41. Many came to seize Jesus. *(John 18:3)*
42. Barabbas was a \_\_\_\_\_ber. *(John 18:40)*
45. Joseph put Jesus' body in his own \_\_\_\_\_. *(Matthew 27:59-60)*
46. Jesus said, "Nevertheless not My \_\_\_\_\_, but Thine, be done." *(Luke 22:42)*
49. Thought; he had a good \_\_\_\_\_.
53. Jesus said, "Father, forgive them; for they know not what they \_\_\_\_\_." *(Luke 23:34)*
54. The Jews decided not to take Jesus on the feast day "lest there be an up \_\_\_\_\_ among the people." *(Matthew 26:5)*
57. Who said: "He is not here: for He is risen,?" *(Matthew 28:5-6)*
59. Soldiers hit Jesus on His head with this. *(Matthew 27:30)*
60. Require; I \_\_\_\_\_ new shoes.

## DOWN

1. The soldiers jeered, "Hail, King of the \_\_\_\_\_s!" *(Matthew 27:29)*
2. Utilize; she \_\_\_\_\_d the pencil to write a note.
3. Darkness at early evening.
4. Like; he fixed the toy so it is \_\_\_\_\_ good as new.
7. People hit Jesus and \_\_\_\_\_ in His face. *(Matthew 26:67)*
8. What Jesus was willing to do for the world.
9. He wrote the fourth book of the New Testament.

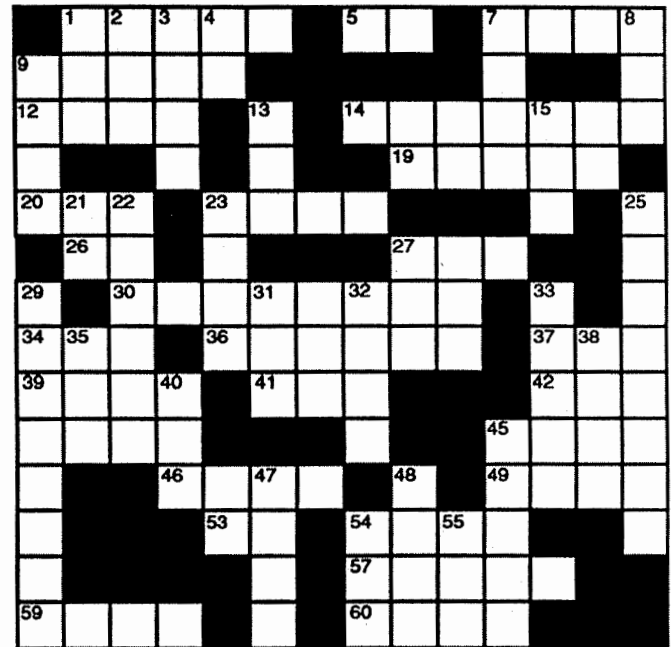

13. What Peter did when he said he didn't know Jesus; \_\_\_\_\_d.
15. "They took the robe off. . .and \_\_\_\_\_ Him away to crucify Him." *(Matthew 27:31)*
21. Mild exclamation.
22. An evil person is said to be \_\_\_\_\_.
23. Jesus was beaten with a scourge or \_\_\_\_\_.
25. Was released instead of Jesus. *(Matthew 27:26)*
27. Jesus said, "Take, \_\_\_\_\_; this is My body." *(Matthew 26:26)*
29. Jesus ate the \_\_\_\_\_ with His disciples. *(Luke 22:8)*
31. Goal; his \_\_\_\_\_ is to get all A's.
32. "He was received up into heaven, and sat on the right \_\_\_\_\_ of God." *(Mark 16:19)*
33. Ruler of Galilee to whom Pilate sent Jesus. *(Luke 23:7)*
35. Jesus said, "It is I Myself: handle Me, and \_\_\_\_\_." *(Luke 24:39)*
38. Soldiers from here crucified Jesus.
40. Jesus said, "This cup is the \_\_\_\_\_ testament in My blood." *(Luke 22:20)*
45. Weary.
47. Jesus said, "Greater \_\_\_\_\_ hath no man than this, that a man lay down his life for his friends." *(John 15:13)*
48. "A \_\_\_\_\_ of Him shall not be broken." *(John 19:36)*
54. Peter \_\_\_\_\_ unto the sepulchre. *(Luke 24:12)*
55. Her \_\_\_\_\_ is ten years old.

# 96. God's Love

Put the words in the hearts in order to find a verse about God's love.

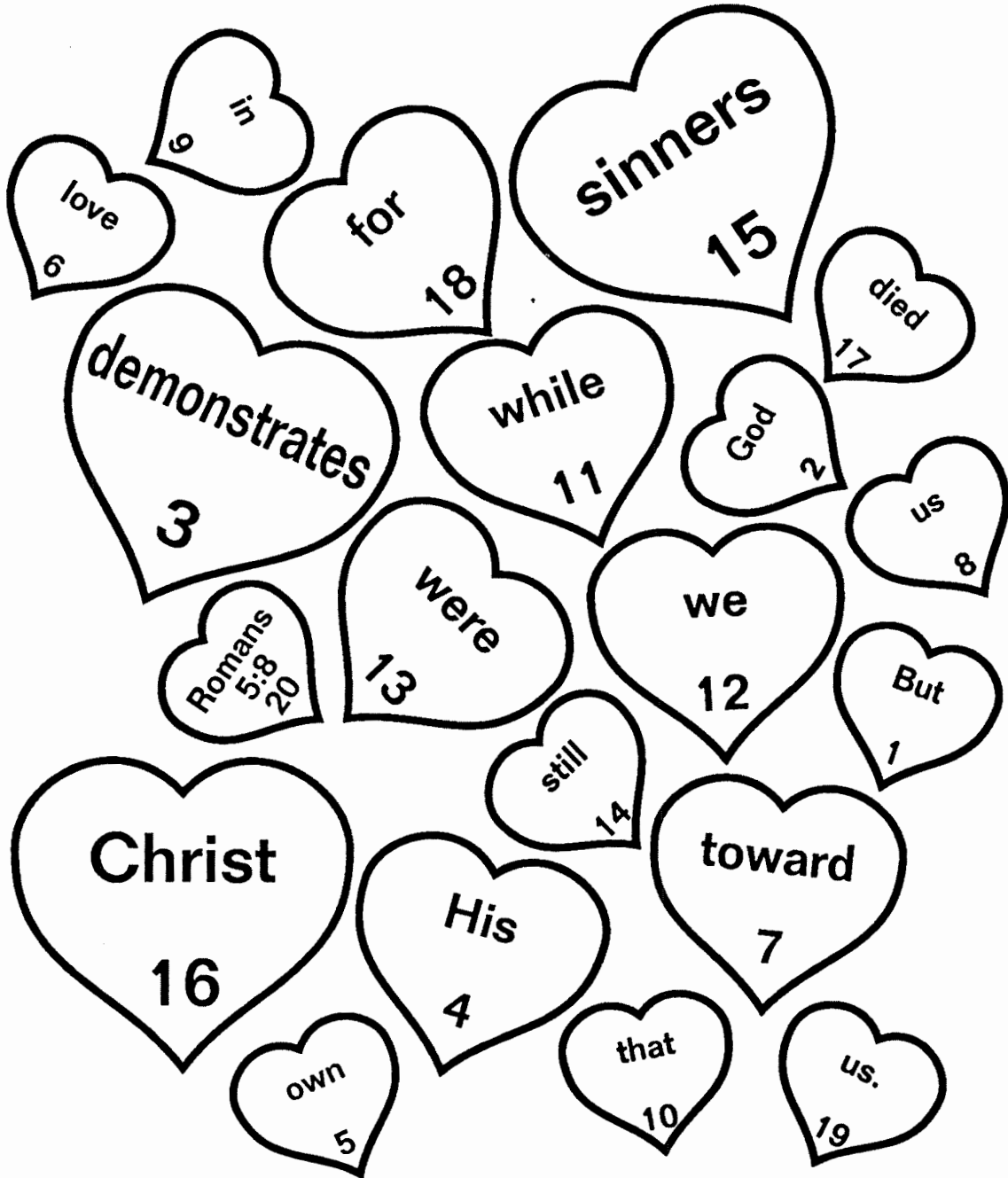

---

---

---



# Memory Verse...

First and Second Grade

**“Pray that you may not enter into temptation.”**

Third Grade and Above

**“When He came to the place, He said to them, ‘Pray that you may not enter into temptation.’”**

**Luke 22:40b**

## Year 3

### Week 140

### Jesus Nailed to the Cross

**Scriptures: Matt 27:1-38, Luke 23:1-38**

**Key Verse: Luke 23:34 Then Jesus said, “Father, forgive them, for they do not know what they do.”**

#### **Key Points:**

1. The chief priests and elders bound Jesus and the Jews led him to Pontius Pilate, the governor of Judea. Pilate asked him, “Are you the king of the Jews?” He answered, “It is as you say.” But Jesus did not say anything in response to the accusations by the chief priests and elders.
2. When Judas saw that Jesus was condemned, he was remorseful and tried to return the money he had received to betray Jesus. Judas threw the money on the floor of the temple, and went out and hanged himself. The priests used the money to buy the potter’s field as was prophesied in Jeremiah 32:6-9.
3. When Pilate discovered Jesus was from Galilee, he sent Jesus to Herod. Herod wanted to question Jesus and witness a miracle, but Jesus remained silent. Herod’s men mocked Jesus and sent Him back to Pilate.
4. Pilate wanted to release Jesus because he had done nothing wrong. It was usual to release a Jewish prisoner during the Passover feast, and Pilate suggested that Jesus should go free. The people protested, and shouted for Barabbas, a murderer, to be freed and for Jesus to be crucified. Pilate washed his hands, and said he was innocent of the death of Jesus.
5. The soldiers dressed Jesus in a scarlet robe and crown of thorns, and mocked Him, saying “Hail, king of the Jews”. They spat on Him and struck His head. Then, they dressed Him in his own clothes and took him away. A man named Simon was forced to help Jesus carry the cross.
6. At Golgotha, Jesus was crucified between two robbers, and his garments were divided. The charge against Jesus was written above His head; THIS IS JESUS THE KING OF THE JEWS. Some of the people and soldiers challenged Him to save Himself.

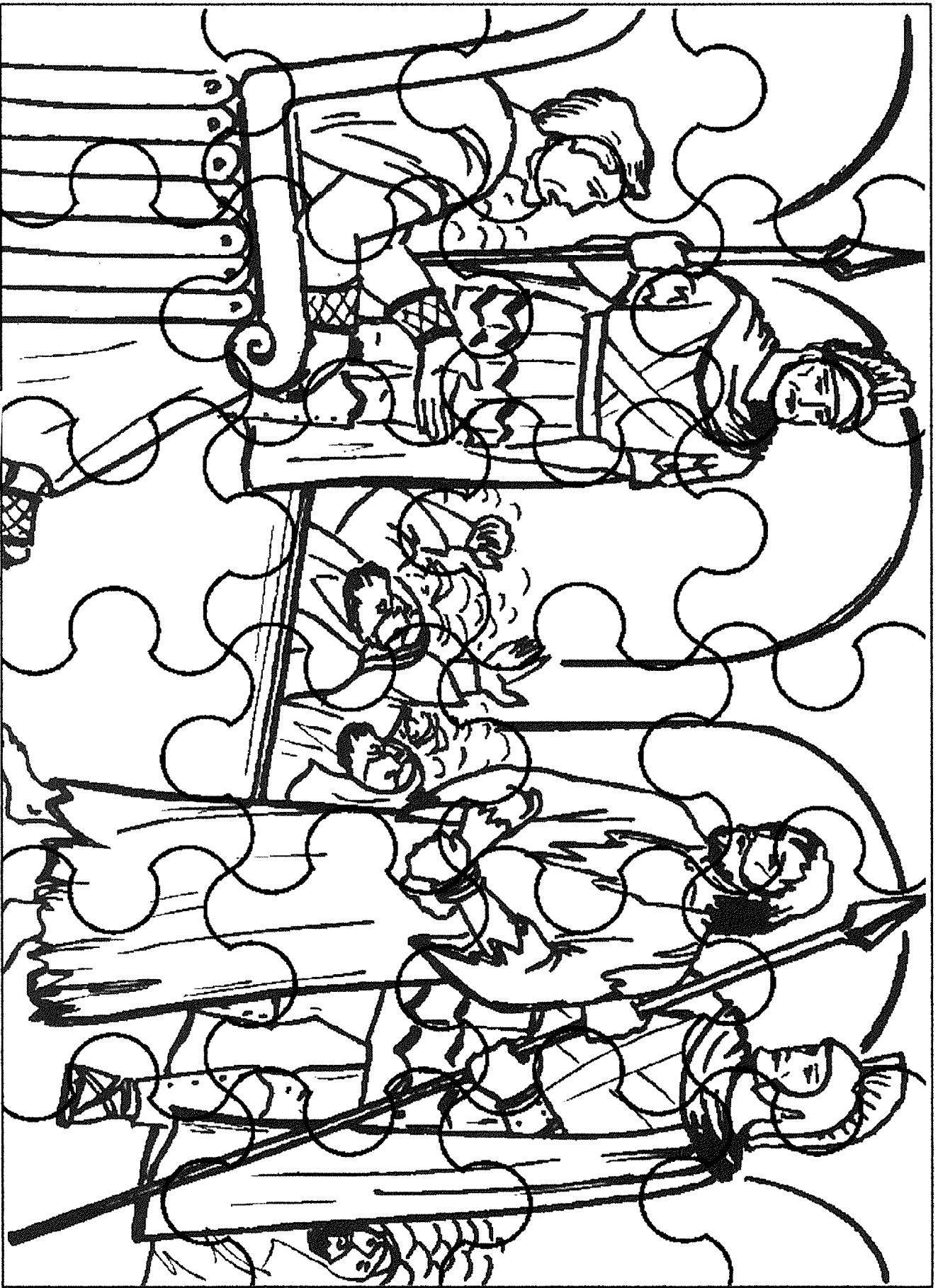

Have children color the picture, cut it out for a puzzle.

(Best to use cardstock)

CONNECT THE DOTS

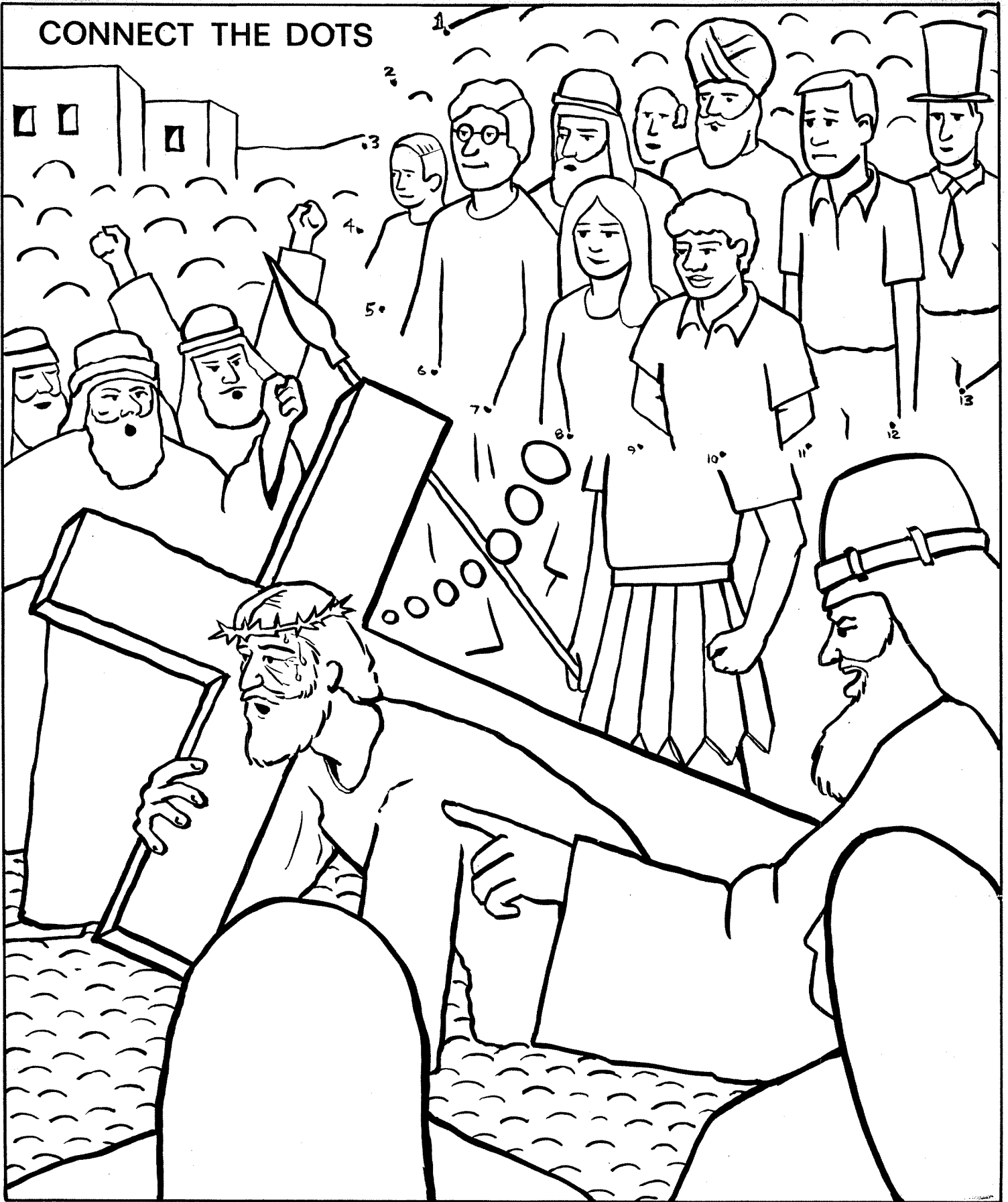

We can love God because He loved us first and sent Jesus to pay for our sin.

## Crown of Thorns

And when they had platted a crown of thorns, they put it upon his head, and a reed in his right hand: and they bowed the knee before him, and mocked him, saying, Hail, King of the Jews!



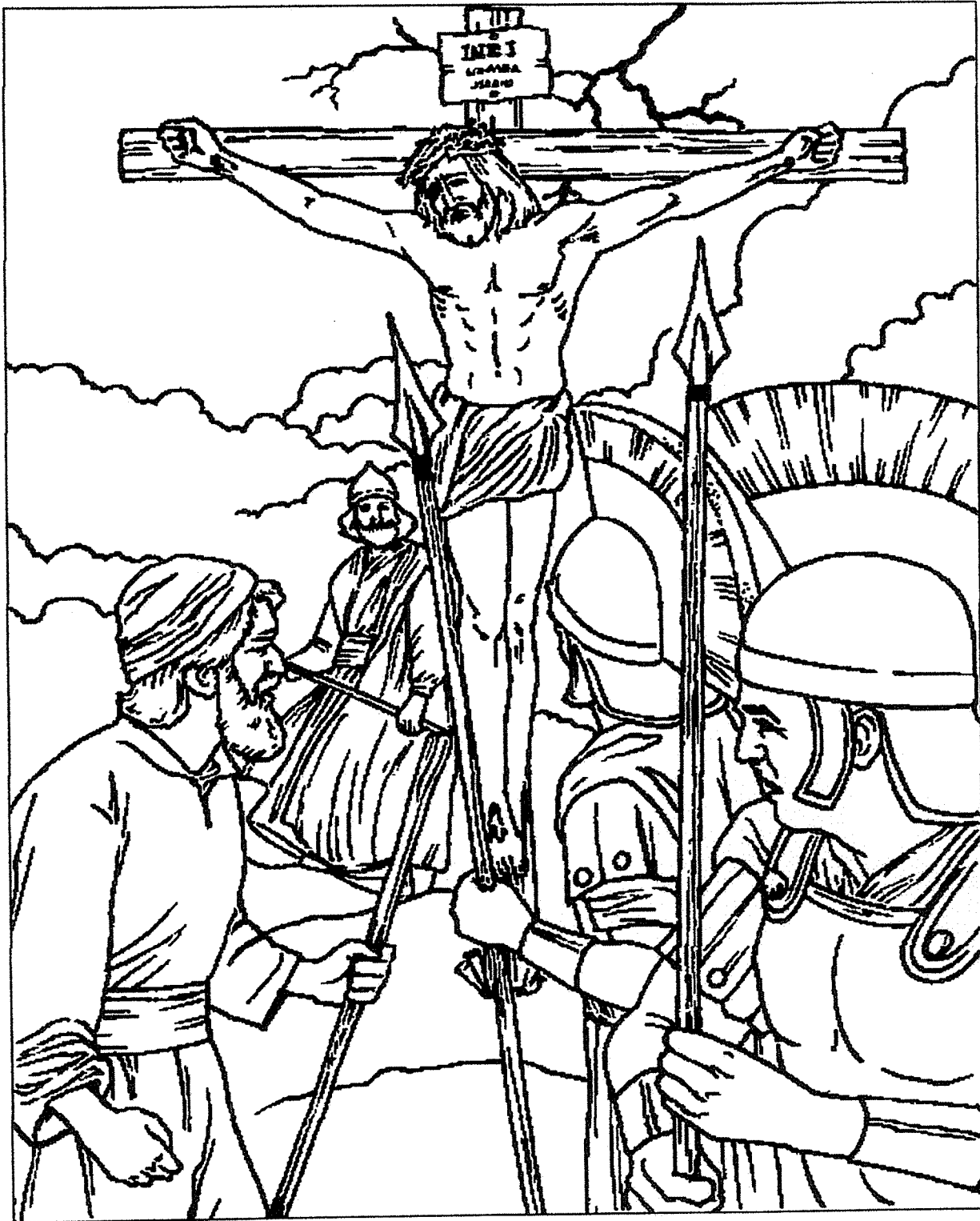

When they came to the place called the Skull, there they crucified him, along with the criminals--one on his right, the other on his left.  
Luke 23:33

From BibleStoryCard Learning System(tm) Coloring Book © 1996 Wesleyan Publishing House. Used by permission.  
Additional BibleStoryCard resources are available by calling 1-800-493-7539 or by visiting the WPH web site.  
[http://www.parable.com/wph/group\\_1052.htm](http://www.parable.com/wph/group_1052.htm)

Sermons4Kids.com

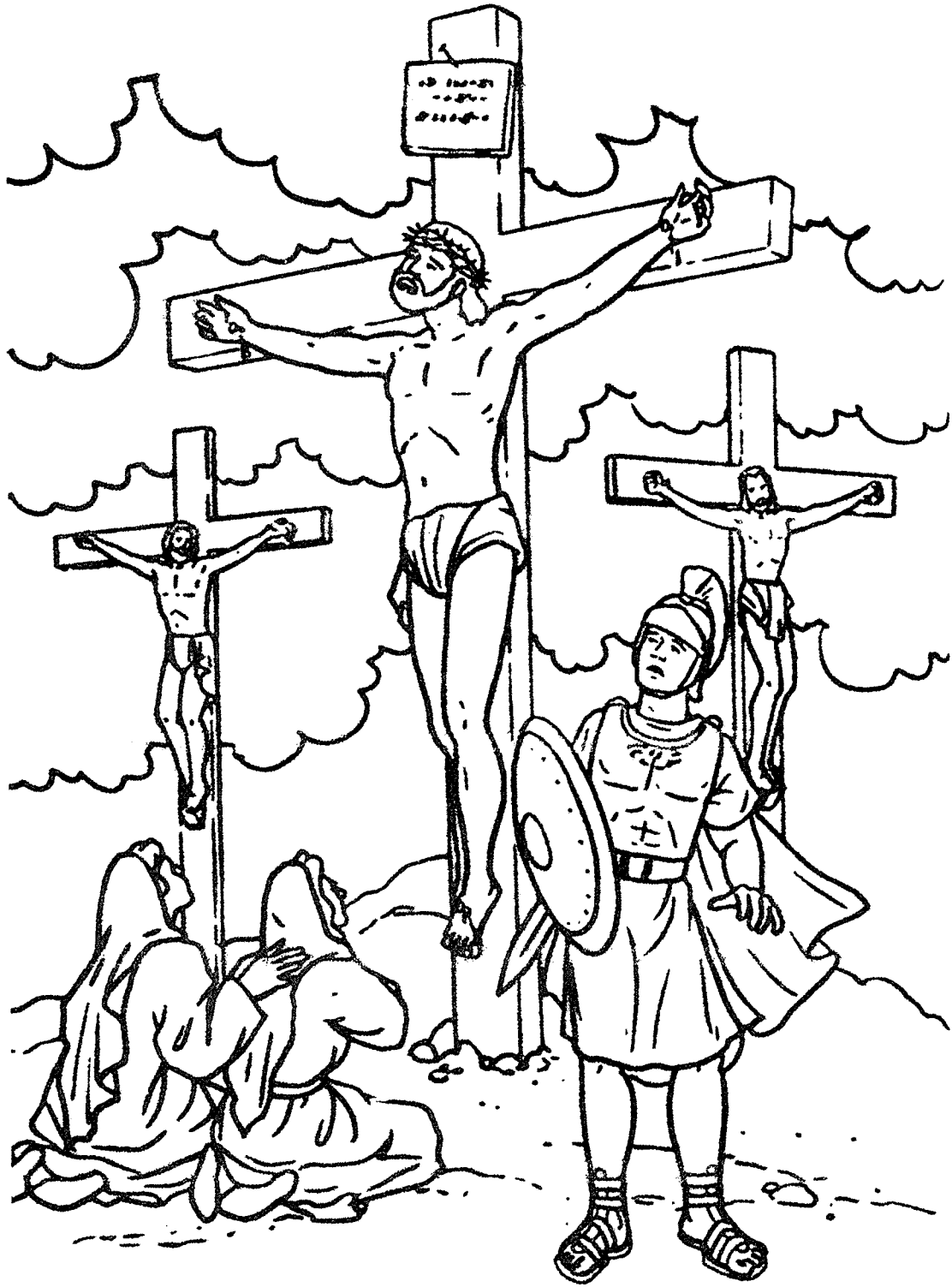

# Pontius Pilot

Pilate saith unto them, What shall I do then with Jesus which is called Christ?  
They all say unto him, Let him be crucified.





# Christ the King Puzzle

Can you find the way to King Jesus?

**Start Here**

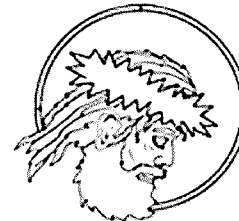
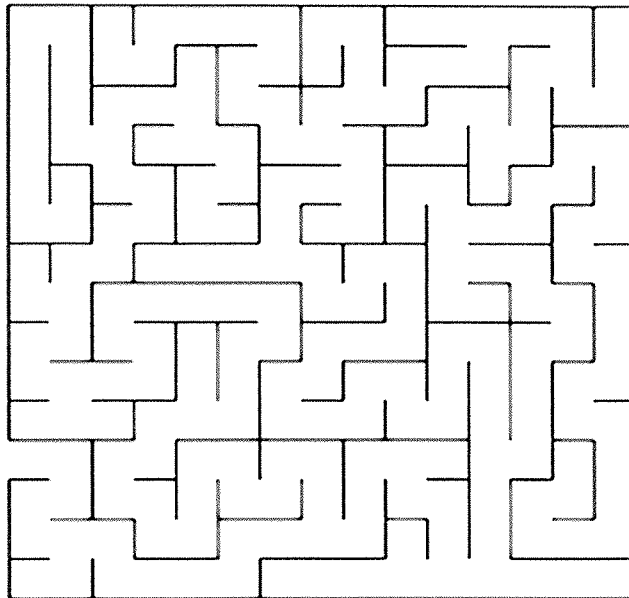
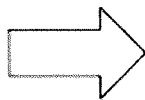

Above him was a sign that said,  
"This is the King of the Jews."  
**Luke 23:38**

Puzzle created by Puzzlemaker  
[DiscoverySchool.com](http://DiscoverySchool.com)

[Sermons4Kids.com](http://Sermons4Kids.com)



## Bible Quiz - Crown of Thorns

27 Then the \_\_\_\_\_ of the governor took \_\_\_\_\_ into the common hall, and gathered unto him the whole band of soldiers. 28 And they \_\_\_\_\_ him, and put on him a scarlet robe. 29 And when they had platted a \_\_\_\_\_ of \_\_\_\_\_, they put it upon his head, and a \_\_\_\_\_ in his right hand: and they bowed the knee before him, and \_\_\_\_\_ him, saying, Hail, King of the Jews! 30 And they \_\_\_\_\_ upon him, and took the reed, and \_\_\_\_\_ him on the head. 31 And after that they had mocked him, they took the robe off from him, and put his own raiment on him, and led him away to \_\_\_\_\_ him.

---

### Memory Verse - Matthew 27:30

And they spit upon him,  
and took the reed, and smote him on the head.

# Christ the King Wordsearch

F I C M S G J F J E  
 O S X R L S A Q S L  
 R R A H U T O I H L  
 G E F V H C D R F U  
 I I U E E A I E C K  
 V D R L R Z I F V S  
 E L E A T H W X Y C  
 C O P W T K I N G X  
 X S C R I M I N A L  
 D R J L F S U S E J

CRIMINAL

FATHER

KING

SKULL

CROSS

FORGIVE

PARADISE

SOLDIERS

CRUCIFY

JESUS

SAVE

THIEF

Created by [Puzzlemaker](#) at [DiscoverySchool.com](#)

[Sermons4Kids.com](#)

# Crown of Thorns

R	V	N	D	M	C	R	U	C	I	F	Y	E	L	E	T	C	T
D	G	E	L	O	E	D	O	L	H	C	R	J	N	H	M	O	N
Y	G	E	J	M	C	R	O	W	N	S	W	E	J	L	E	M	C
E	E	N	T	G	G	O	V	E	R	N	O	R	J	S	R	M	R
M	G	L	O	E	S	T	O	V	M	I	N	E	T	R	I	O	C
N	D	I	O	R	E	E	J	S	T	O	S	R	S	P	M	N	J
T	S	A	N	S	K	E	G	S	N	U	I	H	G	C	H	L	D
E	T	H	R	H	I	N	R	T	S	P	D	R	T	M	A	E	Y
L	I	D	I	O	I	E	O	N	P	E	E	I	E	N	L	S	L
R	P	R	O	K	I	H	V	E	K	T	R	D	O	E	L	S	N
A	S	L	E	D	G	J	D	C	H	R	L	D	M	T	D	M	H
C	O	D	L	E	O	R	O	O	D	A	N	H	D	R	A	O	E
S	O	O	D	C	L	M	R	A	N	D	E	M	E	A	D	T	T
H	S	R	M	E	R	N	R	P	E	H	I	H	J	U	N	E	E
L	H	T	T	E	S	S	P	E	L	R	R	O	J	G	O	H	V
J	P	S	N	E	R	J	L	R	N	E	R	C	T	T	J	L	G
E	O	D	T	G	A	T	H	E	R	E	D	T	O	O	I	J	R
R	C	L	S	O	M	T	R	N	O	O	M	N	N	J	D	T	L

## 4 Letters

HAIL  
HALL  
JEWS  
KING  
REED  
SPIT

## 5 Letters

CROWN  
JESUS  
SMOTE

## 6 Letters

COMMON  
MOCKED  
THORNS

## 7 Letters

CRUCIFY  
SCARLET

## 8 Letters

GATHERED  
GOVERNOR  
SOLDIERS  
STRIPPED

# Crown of Thorns

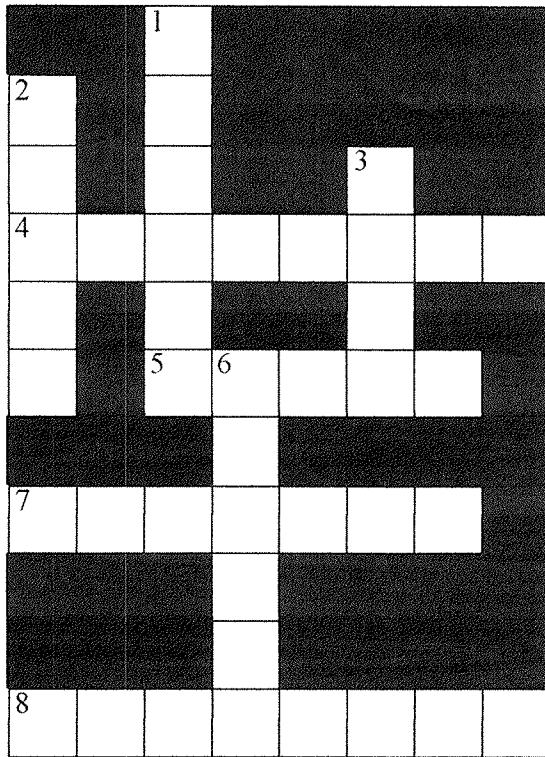

## DOWN

1 And when they had platted a crown of \_\_\_\_\_, they put it upon his head, and a reed in his right hand:

2 He is despised and rejected of men; a man of sorrows, and acquainted with grief: and we hid as it were

## ACROSS

4 And they \_\_\_\_\_ him, and put on him a scarlet robe.

5 and took the reed, and \_\_\_\_\_ him on the head.

7 And after that they had mocked him, they took the robe off from him,

and put his own raiment on him, and led him away to \_\_\_\_\_ him.

8 Then the \_\_\_\_\_ of the governor took Jesus into the common hall, and gathered unto him the whole band of soldiers.

our faces from him; he was despised, and we esteemed him not. Isa 53:3

3 And they \_\_\_\_\_ upon him, . . .

6 and they bowed the knee before him, and \_\_\_\_\_ him, saying, Hail, King of the Jews!

**Year 3**

**Week 141**

## **The Death and Burial of Jesus**

**Scriptures: Matt 27:39-66, Luke 23:34-56**

**Key Verse: Matt 27:54 " So when the centurion and those with him, who were guarding Jesus, saw the earthquake and the things that had happened, they feared greatly, saying, 'Truly, this was the Son of God!'"**

### **Key Points:**

1. One of the criminals next to Jesus mocked Him, saying, "If you are Christ, save yourself and us." The other criminal rebuked the first, saying that they were guilty and deserved crucifixion, but Jesus was innocent. He asked Jesus to remember him in the heavenly kingdom. Jesus promised the thief that he would be with Him in Paradise.
2. It was very dark during the crucifixion. About the ninth hour (3 pm), Jesus cried, "My God, my God, why have you forsaken me?" Someone offered Jesus sour wine to drink. Jesus cried out "Father, into your hands, I commit my spirit" and He died. Immediately there was an earthquake, the veil in the temple was torn, graves were opened. Many women who had followed Jesus were there, watching from a distance.
3. Joseph, a rich man from Arimathea, asked Pilate for the body of Jesus. He wrapped the body in a linen cloth and laid it in a new tomb. The women followed and saw the tomb. They returned to their places and prepared spices and oils.
4. Meanwhile, Pilate sent guards, and the priests and Pharisees sealed the tomb to make it secure.



They wanted him to save himself, but he couldn't.  
He was caught and crucified, as he said he would be.

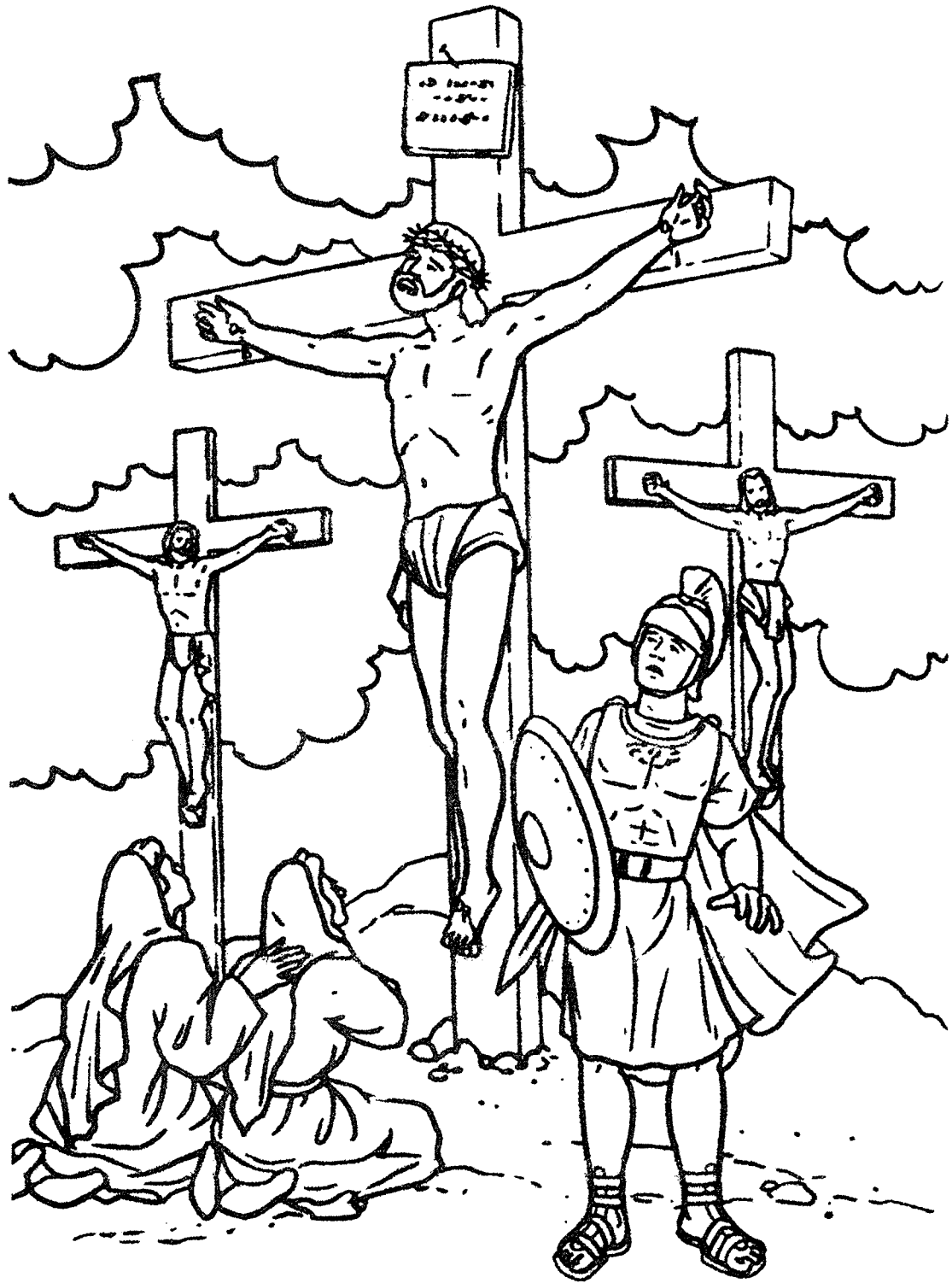



# Golgotha

For these things were done, that the scripture should be fulfilled, A bone of him shall not be broken. And again another scripture saith, They shall look on him whom they pierced.

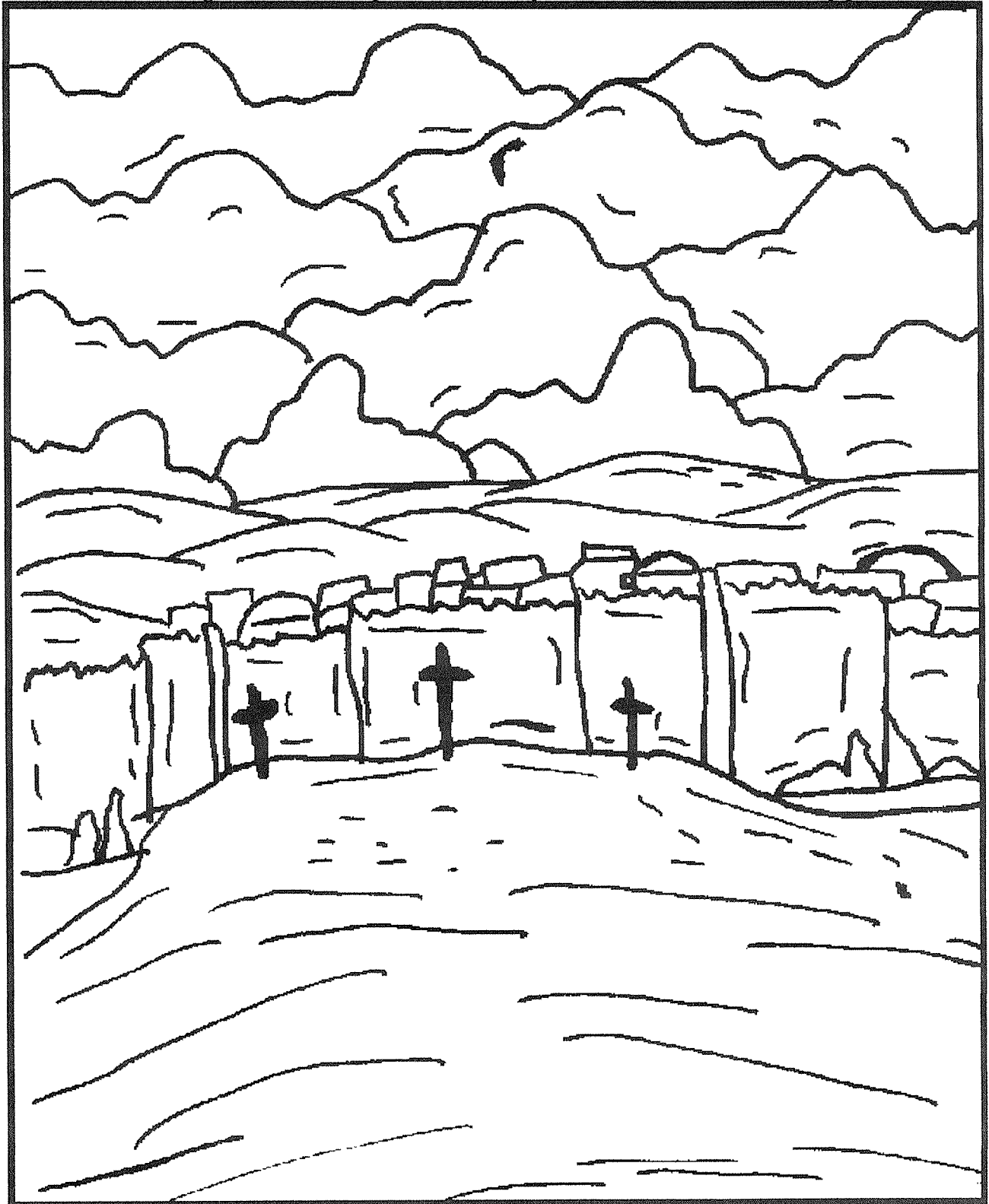

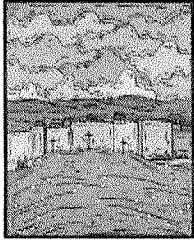

# Bible Quiz - Golgotha

1. Where is our scripture found in the bible?
2. The Jews wanted the bodies removed from the Cross because of a special day. What was that day?
3. What did they ask Pilate to do to their legs before they took their bodies off the cross?
4. Did the soldiers break Jesus' legs?
5. What did one of the soldiers do to Jesus?
6. What came out of Jesus' side?
7. Who is the man who watched all these things happen and wrote it all down?
8. Read John 19:36. Why did the soldiers not break Jesus' legs?
9. Why did John write all these things down?
10. John 19:37 tells us, they shall look at Jesus who they pierced. Who is the bible talking about when it says They ?

---

## Memory Verse - John 19:34

But one of the soldiers with a spear pierced his side,  
and forthwith came there out blood and water.

# It Is Finished

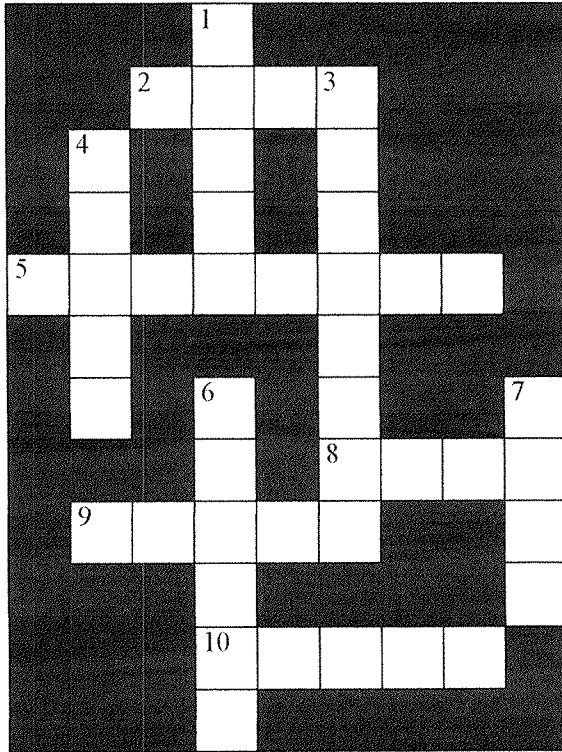

## ACROSS

- 2** And straightway one of them ran, and took a sponge, and filled it with vinegar, and put it on a \_\_\_\_\_, and gave him to drink.
- 5** And about the ninth hour Jesus cried with a loud voice, saying, Eli, Eli, lama sabachthani? that is to say, My God, my God, why hast thou \_\_\_\_\_ me?
- 8** The rest said, Let be, let us see whether

- Elias will come to \_\_\_\_\_ him.
- 9** Some of them that stood there, when they heard that, said, This man calleth for \_\_\_\_\_.
- 10** Now when the centurion, and they that were with him, watching Jesus, saw the earthquake, and those things that were done, they feared greatly, saying, \_\_\_\_\_ this was the Son of God.

## DOWN

- 1** All we like sheep have gone astray; we have turned every one to his own way; and the LORD hath laid on (him ?) the iniquity of us all. Isa. 53:6
- 3** Now from the sixth hour there was \_\_\_\_\_ over all the land unto the ninth hour.
- 4** Jesus, when he had cried again with a loud voice, yielded up the \_\_\_\_\_.
- 6** And the graves were opened; and many bodies of the \_\_\_\_\_ which slept arose and came out of the graves after his resurrection, and went into the holy city, and appeared unto many.
- 7** And, behold, the \_\_\_\_\_ of the temple was rent in twain from the top to the bottom; and the earth did quake, and the rocks rent;

# Jesus' Burial

R U E U W T O E S U M E D O C I N E  
M M L A E E K Y R U B P D B O T R K  
Y Y D H L E R A E F O S E R T O A A  
S R R E S L U C E R Y W U O A B S T  
E R A I I W O W O E S A J M T I E H  
C H P C U C H O B S H E E N L O O T  
I A C E I N P U L L I V R O E T A U  
P S Y A Y A E N T H A G Y E R N J E  
S U P R A U R D E G E A M E B D I A  
O E O I R G H R B R W H A J A I S L  
A R E M L C D P H A E P U E P S G S  
I L S A E A P S T P B S A S S C G W  
D S D T C D T I U R H L E U J I E E  
O G Y H T A P E O L O D O S U P O J  
H Y O A B Y S U A E A L L E Y L P D  
A M R E P O G A S C O G J O S E P H  
M I Y A U H D J N U O P T H G I N O  
R J Y Y T L P Y E W O T J Y Y T O I

## 4 Letters

AWAY  
BODY  
BURY  
FEAR  
GAVE  
JEWS  
TAKE

## 5 Letters

ALOES

## JESUS

LINEN  
MYRRH  
NIGHT  
WOUND

## 6 Letters

JOSEPH  
PILATE  
SPICES

## 7 Letters

BROUGHT

## 8 Letters

DISCIPLE

## 9 Letters

NICODEMUS

## 10 Letters

ARIMATHAEA

**Year 3**  
**Week 142**

## **Resurrection**

**Scriptures: John 20**

**Key Verse: John 20:30-31** "And truly Jesus did many other signs in the presence of His disciples, which are not written in this book; but these are written that you may believe that Jesus is the Christ, the Son of God, and that believing you may have life in His name."

### **Key Points:**

1. Mary Magdalene went to the tomb on the first day of the week before daybreak. She saw the stone had been taken away, and she ran to Peter and John, saying, "They have taken the Lord, and we don't know where they laid Him."
2. Peter and John came to the empty tomb, saw the linen cloths, and believed that He had risen. They returned home.
3. Mary saw two angels inside the tomb. They asked why she was weeping, and she said that she didn't know where to find Jesus' body. She turned around and faced Jesus, but she didn't realize it was Him. She clung to Jesus when she recognized Him and then went to tell the disciples that she had seen and spoken to the Lord.
4. At evening the same day, the disciples were together, hiding from the Jews. Although the doors were shut, Jesus appeared and showed them the wounds on His hands and His side. They were glad to see the Lord. He breathed on them and said, "Receive the Holy Spirit." But Thomas was not in the room when this happened.
5. Eight days later, the disciples and Thomas were shut inside a room. Jesus came and said, "Peace to you." He challenged Thomas to touch his hands and side, and Thomas said, "My Lord and my God!" Thomas believed because he saw, but Jesus said "Blessed are those who have not seen and yet have believed."
6. Jesus did many more things to teach his disciples, but John wrote the things that are recorded in this book for us, so that we might believe that Jesus is the Christ. Because we believe this, we may have eternal life.

When Jesus' friends came to visit the grave, they found it empty! Where was Jesus? The angel who had frightened the soldiers, came to them and said . . .

To read the following, use this chart to decode it.

A	B	C	D	E	F	G	H	I	J	K	L	M
15	4	20	24	8	26	14	18	11	6	3	21	25
N	O	P	Q	R	S	T	U	V	W	X	Y	Z
13	16	22	1	19	9	17	10	2	12	5	23	7

" 6 8 9 10 9 11 9 13 16 17 18 8 19 8  
 18 8 18 15 9 19 11 9 8 13  
 14 16 1 10 11 20 3 21 23 15 13 24  
 17 8 21 21 18 11 9 24 11 9 20 11 22 21 8 9 ! "

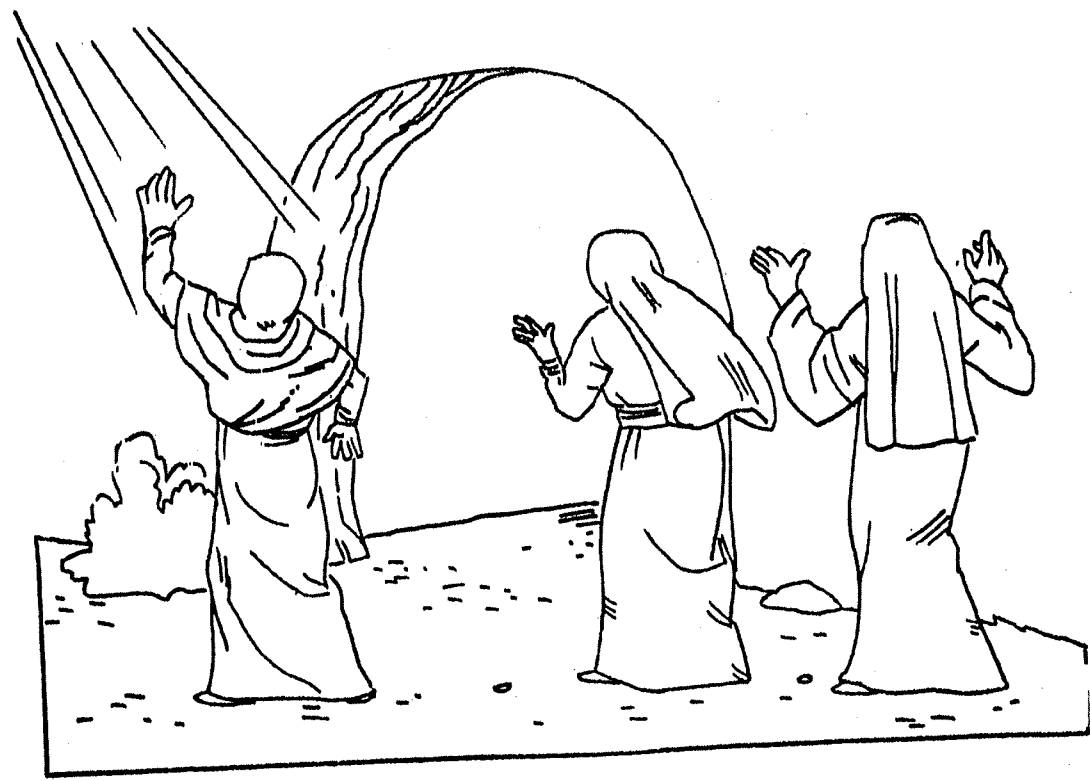

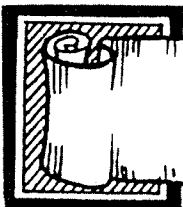
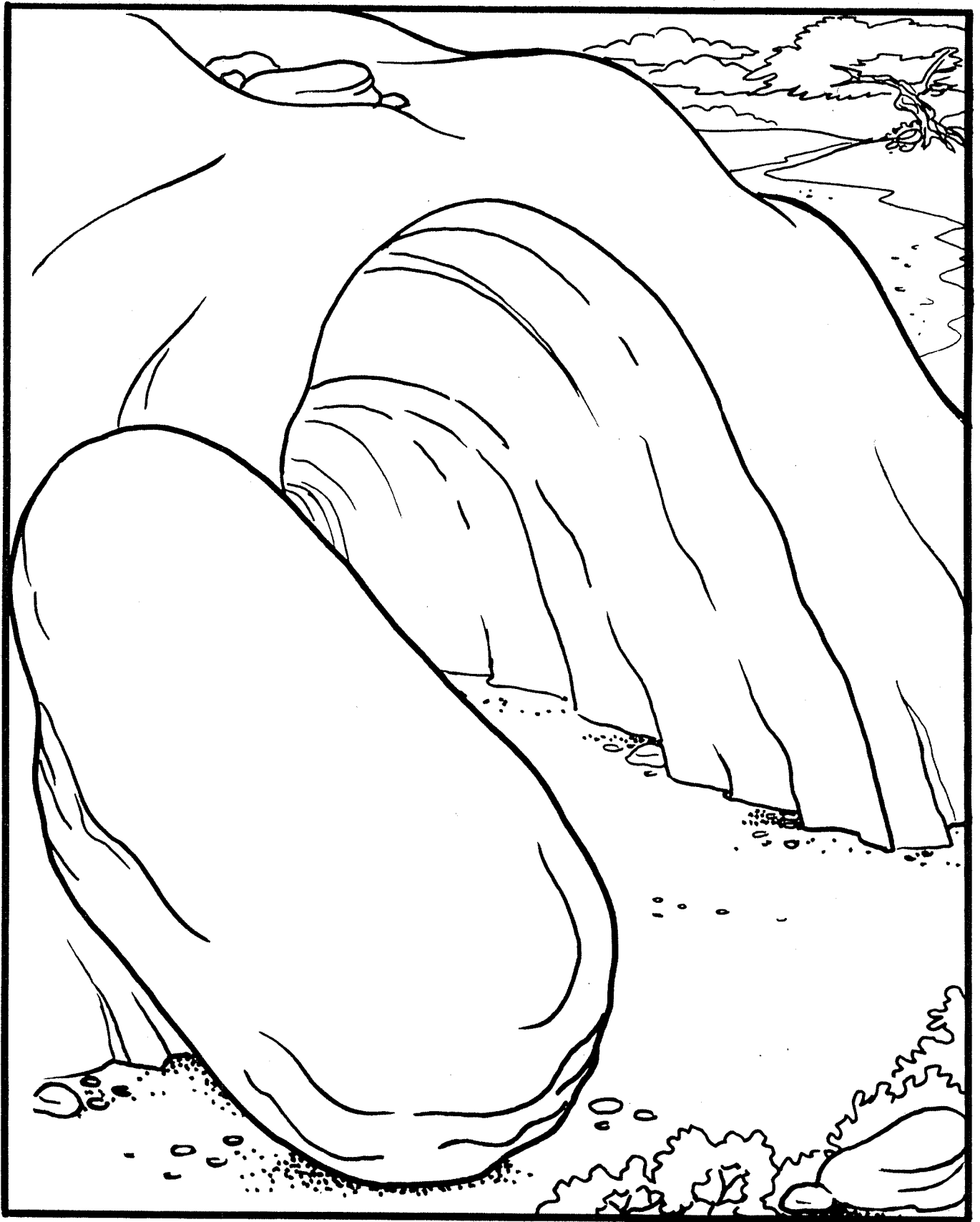

But the stone in front of his tomb had rolled away.

Make a rock out of construction paper and cut out.

Use a brad to attach rock to picture. The rock will "roll away."

# Roll the Stone Away

E	R	D	M	E	T	E	C	I	D	A	W	N	I	D	E	D	I
C	E	D	E	O	E	C	E	V	I	L	A	E	I	E	C	R	R
N	R	R	E	D	C	P	A	E	L	C	K	C	R	L	A	A	D
A	E	L	M	E	D	D	A	I	Q	A	A	C	M	L	S	O	D
N	B	E	A	E	R	E	R	M	U	N	E	W	A	O	D	R	C
E	M	C	L	E	D	C	O	Q	B	R	W	O	H	R	S	I	I
T	E	O	I	L	C	C	H	C	E	E	E	D	U	A	W	E	W
N	M	M	L	C	C	T	E	R	C	P	V	W	E	S	D	A	S
U	E	M	I	A	R	R	O	O	B	E	L	R	S	M	T	S	E
O	R	A	I	A	H	C	A	M	R	C	A	E	I	C	E	C	L
C	E	N	E	M	C	S	R	E	A	C	A	C	H	P	Y	N	P
E	L	D	L	T	T	E	V	E	D	L	L	E	U	A	E	T	I
C	C	E	B	E	A	I	W	C	E	W	E	L	W	M	A	L	C
C	A	E	A	R	E	N	O	E	W	H	C	A	E	T	S	E	S
D	M	L	I	C	E	M	A	O	E	H	O	D	E	E	D	A	I
I	E	S	E	E	E	R	R	E	R	S	R	N	T	A	D	D	D
C	A	D	R	W	P	S	D	E	D	E	I	U	M	S	W	M	D
C	R	O	R	R	E	E	N	I	Y	A	S	R	C	W	E	W	E

**4 Letters**

AWAY  
CAME  
COME  
DAWN  
MADE  
RISE

**5 Letters**

ALIVE  
ERROR  
SAYIN

STEAL  
WATCH  
WORSE

**6 Letters**  
ROLLED

**7 Letters**  
COMMAND

**8 Letters**  
DECEIVER

REMEMBER

**9 Letters**  
DISCIPLES  
SEPULCHRE

**10 Letters**  
EARTHQUAKE

**11 Letters**  
COUNTENANCE



# Roll the Stone Away

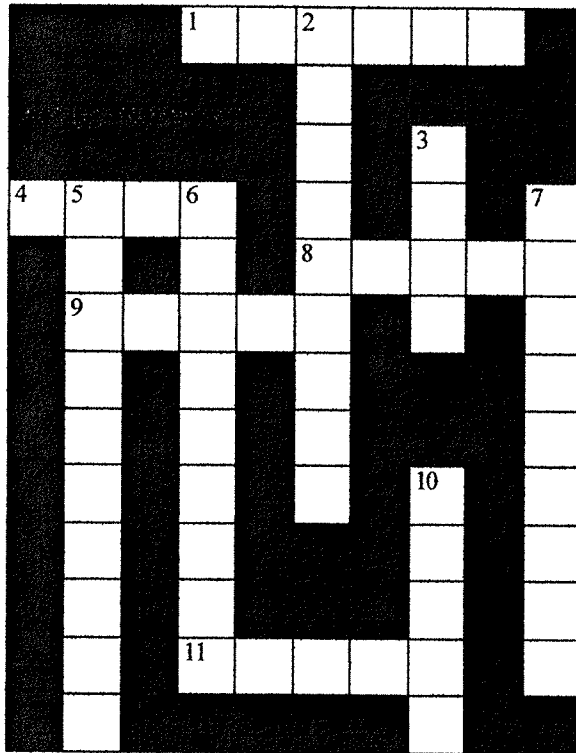

## ACROSS

- 1 Now the next day, that followed the day of the preparation, the chief priests and Pharisees came together unto \_\_\_\_\_, ...
- 4 And go quickly, and tell his disciples that he is risen from the \_\_\_\_\_; and, behold, he goeth before you into Galilee; there shall ye see him: lo, I have told you.
- 8 Sir, we remember that that deceiver said,

while he was yet alive, After \_\_\_\_\_ days I will rise again.

- 9 He is not here: for he is \_\_\_\_\_, as he said. Come, see the place where the Lord lay.
- 11 And for fear of him the keepers did \_\_\_\_\_, and became as dead men.

## DOWN

- 2 His countenance was like \_\_\_\_\_, and his raiment white as snow:

3 In the end of the sabbath, as it began to dawn toward the first day of the week, came \_\_\_\_\_ Magdalene and the other Mary to see the sepulchre.

5 And, behold, there was a great \_\_\_\_\_: for the angel of the Lord descended from heaven, and came and rolled back the stone from the door, and sat upon it.

6 Command therefore that the sepulchre be made sure until the third day, lest his \_\_\_\_\_

come by night, and steal him away, and say unto the people, He is risen from the dead:

7 Pilate said unto them, Ye have a watch: go your way, make it as sure as ye can. 66 So they went, and made the \_\_\_\_\_ sure, sealing the stone, and setting a watch.

10 And the \_\_\_\_\_ answered and said unto the women, Fear not ye: for I know that ye seek Jesus, which was crucified.



My Lord and

My God.

Color the picture of Thomas and Jesus. Trace the words.  
God wants us to believe in His Son Jesus, too.

Name \_\_\_\_\_

Jesus Is Alive

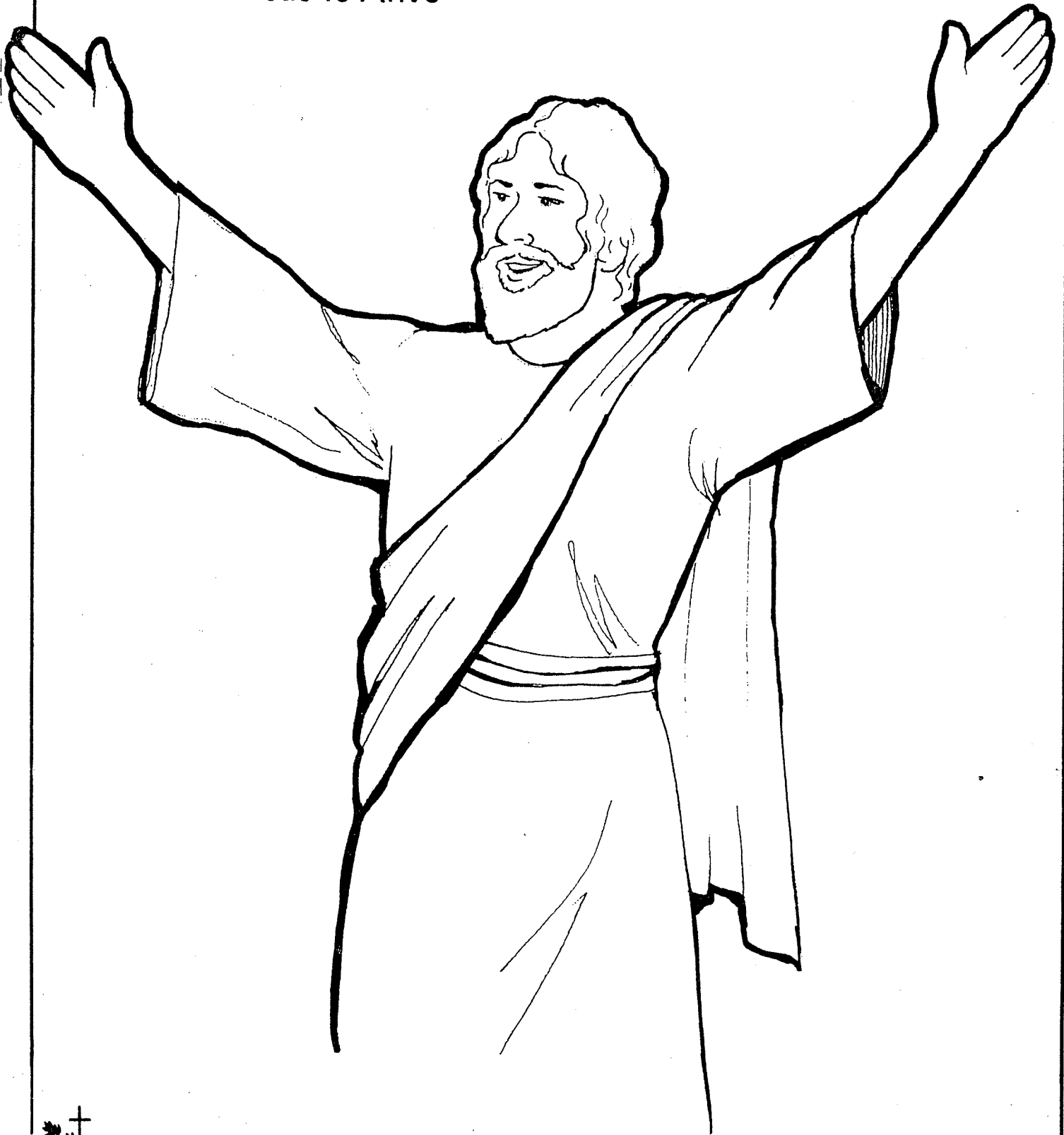

**Year 3**

**Week 143**

## **Sea of Galilee and the Ascension**

**Scriptures: John 21, Acts 1:1-14**

**Key Verse: Acts 1:8 “But you shall receive power when the Holy Spirit has come upon you; and you shall be witnesses to Me in Jerusalem, and in all Judea and Samaria, and to the end of the earth.”**

### **Key Points:**

- 1.** Peter and some of the disciples went fishing. By morning, they had not caught anything. A man (Jesus, but the disciples did not know who it was) called from the shore, asking if they had food. He told them to cast the net on the right side of the boat to find some.
- 2.** They did so, and the net was filled with so many fish that they were unable to draw it in. John said to Peter, “It is the Lord!” and Peter dove into the water. The other disciples brought the boat to shore, dragging the net with fish. At the shore, there was a fire with fish and bread. Jesus fed them a breakfast of bread and fish.
- 3.** After breakfast, Jesus asked Peter, “Do you love me more than these?” Peter answered, “Yes Lord, you know that I love you.” Jesus said, “Feed my lambs.” Jesus repeated this two more times. Then Jesus told Peter that his death would glorify God and to follow Him until death.
- 4.** John testifies that the events recorded in his book are true, and that if all the things that Jesus did were written, the world could not contain all the books.
- 5.** Jesus taught the believers about the kingdom of God for forty days after the resurrection. He commanded them to stay in Jerusalem until they had received the Promise of the Father, that is the power of the Holy Spirit.
- 6.** While they watched, Jesus was taken up into the sky, and a cloud hid Him from their sight. Two men in white appeared and told them that Jesus would return from the heavens the same way they had seen him taken away.

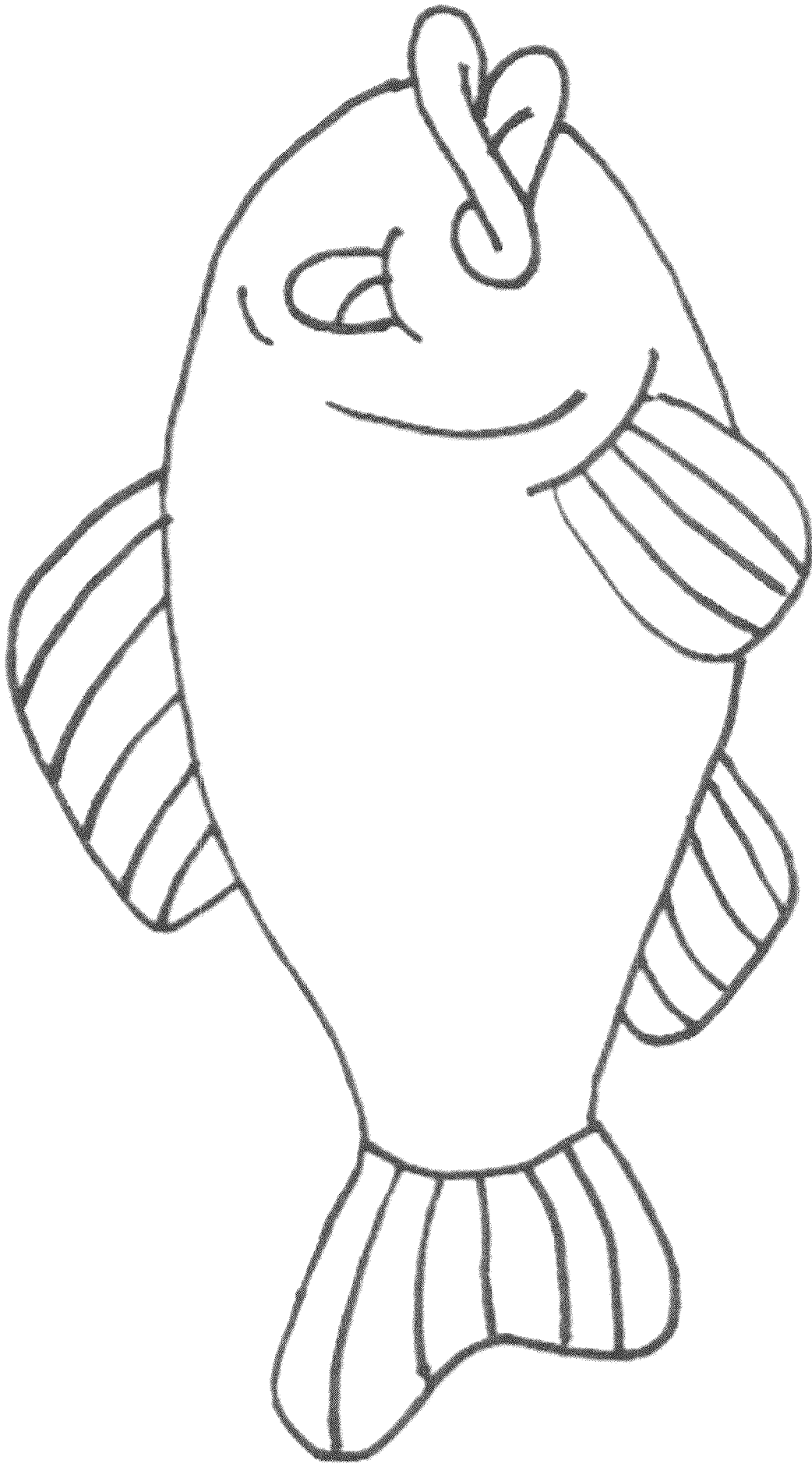

Put eyes on fish and use sequins on fish scales. Use cardstock for best results.

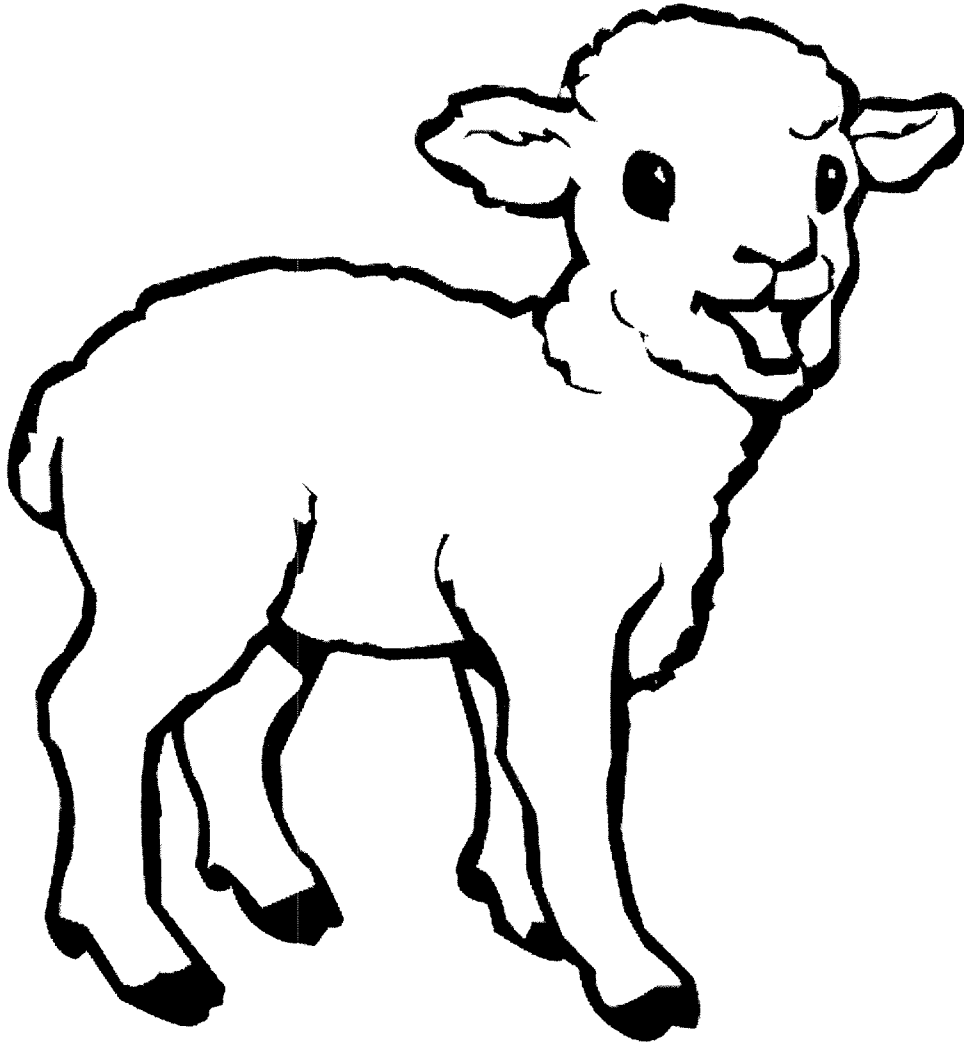

Glue cottonballs on lamb.

Jesus is alive today. He arose from the grave and went up into heaven.

Complete this dot-to-dot picture.

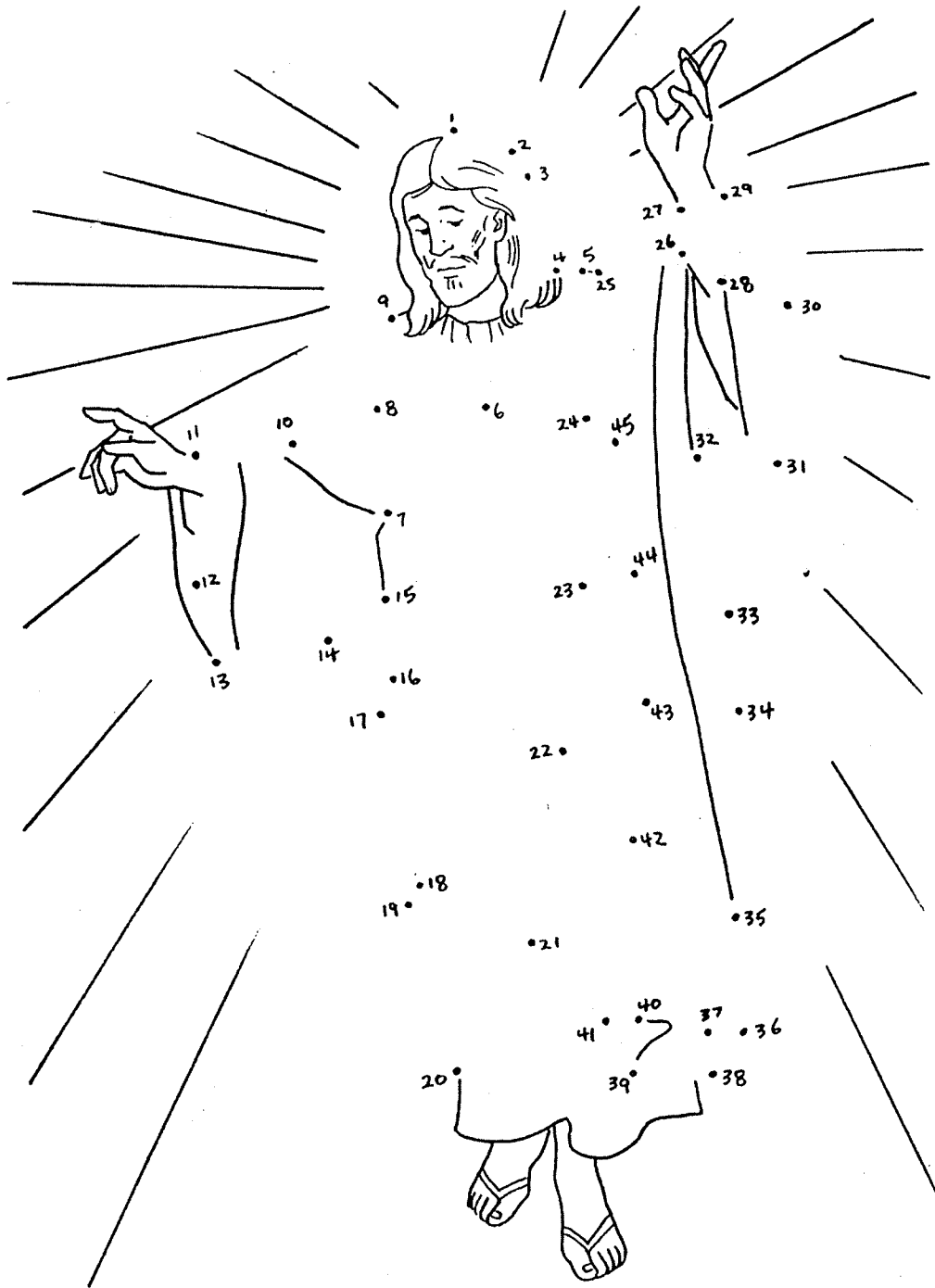

**Jesus' Parting Words**

*Matthew 28:1-10; Mark 16:9-20; Luke 24:44-53; Acts 1:1-11*



**Go and teach.**

Color the picture of Jesus going back to Heaven. Glue on cotton-ball clouds.  
Trace the words below.





## **Bible Quiz - Peter Restored**

- 1. Where in the Bible do we find the story of Peter restored?**
- 2. What did Peter say he was going to do?**
- 3. How many people went with him?**
- 4. What was the name of the sea that Peter was fishing?**
- 5. What side of the boat did Jesus tell Peter to cast the net?**
- 6. Who said to Peter “It is the Lord”?**
- 7. When Peter jumped into the sea, how far did he swim?**
- 8. How many fish were in the net when they dragged it to shore?**
- 9. What question did Jesus ask Peter three times?**
- 10. What was Jesus talking about in verse 18? [John 21:18]**

---

### **Memory Verse - John 21:14**

**This is now the third time that Jesus shewed himself to his disciples,  
after that he was risen from the dead.**

# The Ascension

T	E	Y	I	S	R	T	T	I	E	R	P	W	P	F	E	C	O
T	C	R	D	N	S	T	O	R	R	T	E	T	I	L	N	E	G
T	N	R	S	P	R	E	A	C	H	E	D	S	I	U	S	I	U
E	A	A	R	E	M	I	S	S	I	O	N	F	E	D	O	O	S
R	T	T	P	U	N	Y	O	Y	R	C	T	W	S	E	I	I	O
I	N	U	B	D	S	D	D	R	D	E	T	R	A	P	S	R	B
I	E	E	N	D	T	F	U	R	D	T	S	N	R	P	U	R	E
I	P	N	S	D	O	N	G	E	A	G	E	E	I	I	F	O	H
N	E	G	N	U	E	N	R	S	D	P	N	E	S	H	F	E	O
S	R	R	N	J	T	R	Y	D	S	E	I	T	E	S	E	B	V
E	R	R	R	O	R	E	S	N	P	O	G	I	P	R	R	P	E
S	W	I	F	Y	E	D	I	T	A	I	R	R	E	O	E	C	D
S	R	P	N	P	R	I	D	R	A	R	D	T	C	W	S	A	C
E	I	R	D	E	S	S	E	L	B	N	U	D	H	C	I	R	O
N	T	C	R	I	D	S	I	S	T	R	D	G	D	R	M	R	L
T	T	O	R	S	T	T	T	L	N	R	E	I	S	E	O	I	S
I	E	O	P	E	N	E	D	E	O	O	E	S	N	F	R	E	R
W	N	E	R	P	S	T	D	S	D	P	R	O	O	G	P	D	R

**3 Letters**

JOY

**4 Letters**

RISE

**5 Letters**

TARRY

**6 Letters**

ENDUED

LIFTED

OPENED

PARTED

SUFFER

**7 Letters**

BEHOVED

BLESSED

CARRIED

PROMISE

WRITTEN

**8 Letters**

PREACHED

RETURNED

**9 Letters**

REMISSION

WITNESSES

**10 Letters**

REPENTANCE

WORSHIPPED

**13 Letters**

UNDERSTANDING

# The Ascension

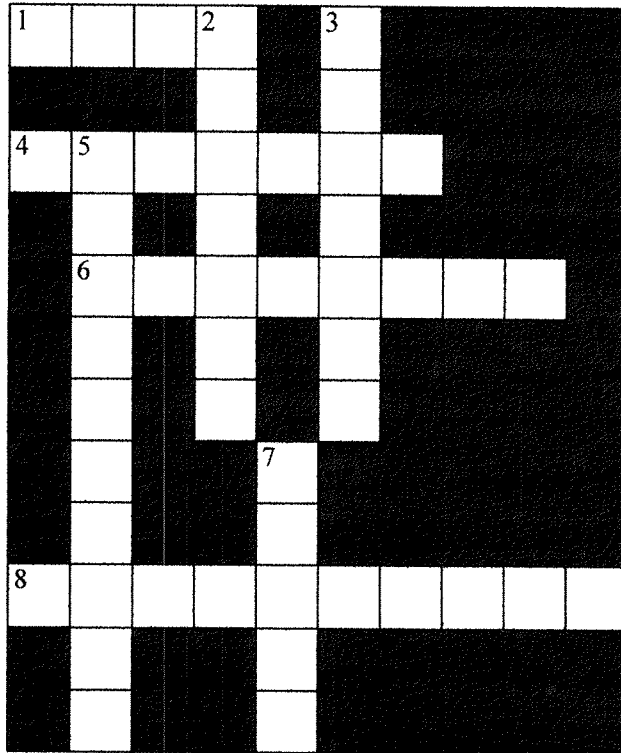

## ACROSS

**1** After this I beheld, and, lo, a great multitude, which no man could number, of all nations, and kindreds, and people, and tongues, stood before the throne, and before the \_\_\_\_\_, clothed with white robes, and palms in their hands;

**4** Jesus said unto them,

Thus it is \_\_\_\_\_, and thus it behoved Christ to suffer, and to rise from the dead the third day:

**6** And they worshipped him, and returned to Jerusalem with great joy: And were continually in the temple, \_\_\_\_\_ and blessing God. Amen.

**8** Then opened he their understanding, that they

might \_\_\_\_\_ the scriptures,

## DOWN

**2** And he led them out as far as to \_\_\_\_\_, and he lifted up his hands, and blessed them.

**3** And it came to pass, while he \_\_\_\_\_ them, he was parted from them, and carried up into heaven.

**5** And that \_\_\_\_\_ and remission of sins should be preached in his name among all nations, beginning at Jerusalem.

**7** And ye are witnesses of these things. And, behold, I send the promise of my Father upon you: but \_\_\_\_\_ ye in the city of Jerusalem, until ye be endued with power from on high.

**Year 3**  
**Week 144**

## **The Day of Pentecost**

**Scriptures: Acts 1:15-26, Acts 2**

**Key Verse: Acts 2:38 “Then Peter said to them, 'Repent, and let every one of you be baptized in the name of Jesus Christ for the remission of sins; and you shall receive the gift of the Holy Spirit.'”**

### **Key Points:**

1. Peter and the other disciples chose Matthias to take Judas' place as an apostle. The disciples numbered 120.
2. They were gathered together on the Day of Pentecost. The sound of a rushing wind came from heaven, and a divided tongue of fire sat upon each of them.
3. They were filled with the Holy Spirit and began to speak in tongues.
4. Jews from every nation heard the disciples speak in their own language, and they wondered what this could mean. But some men mocked the disciples, saying they were drunk.
5. Peter stood and delivered a sermon, explaining how Jesus fulfilled prophecies in the scriptures. Although Jesus was crucified and died, God raised Him up, and He is Lord and Christ.
6. The people were cut to the heart, and said “What shall we do?” They were told to repent and be baptized to receive the gift of the Holy Spirit. About three thousand souls were added to the church.
7. They followed the apostles' doctrine and fellowship, breaking the bread, and prayer. They divided their possessions so that no one was in need. And more souls were added to the church each day.





Fifty days after Jesus' death, and after his ascension, was the day of the Pentecost. There was a great noise and tongues of fire became visible.

# Pentecost

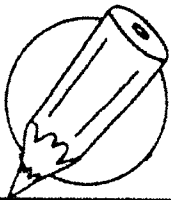

Find the hidden words

Then there appeared to them tongues as of fire, which parted and came to rest on each one of them.

Acts 2:3

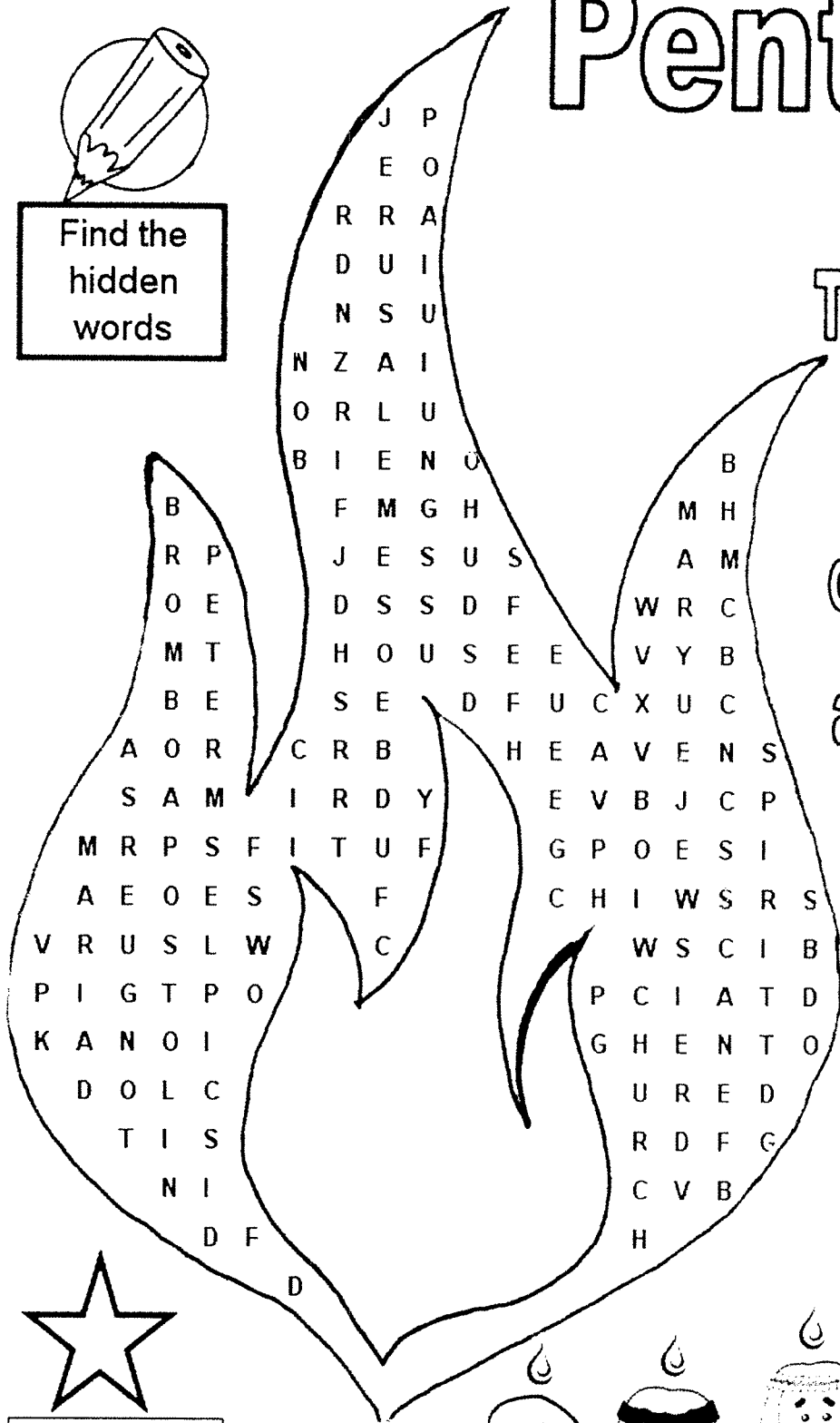

Wind  
Heaven  
House  
Tongues  
Fire  
Spirit  
Jews  
Jerusalem



B  
I  
B  
L  
E  
K  
I  
D  
S

# Day of Pentecost

And there appeared unto them cloven tongues like as of fire, and it sat upon each of them. And they were all filled with the Holy Ghost, and began to speak with other tongues, as the Spirit gave them utterance.

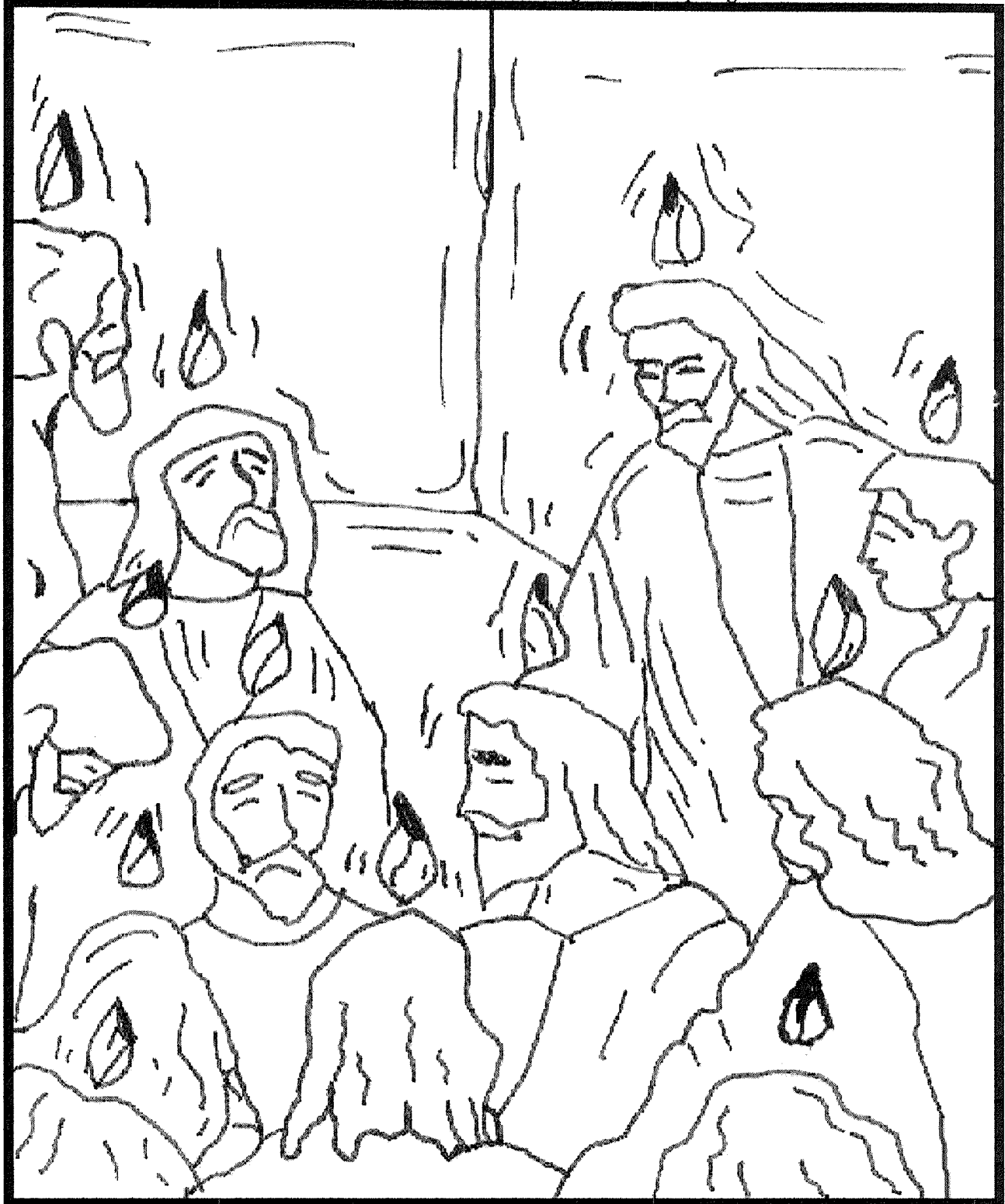



Name \_\_\_\_\_

The Disciples Receive the Holy Spirit

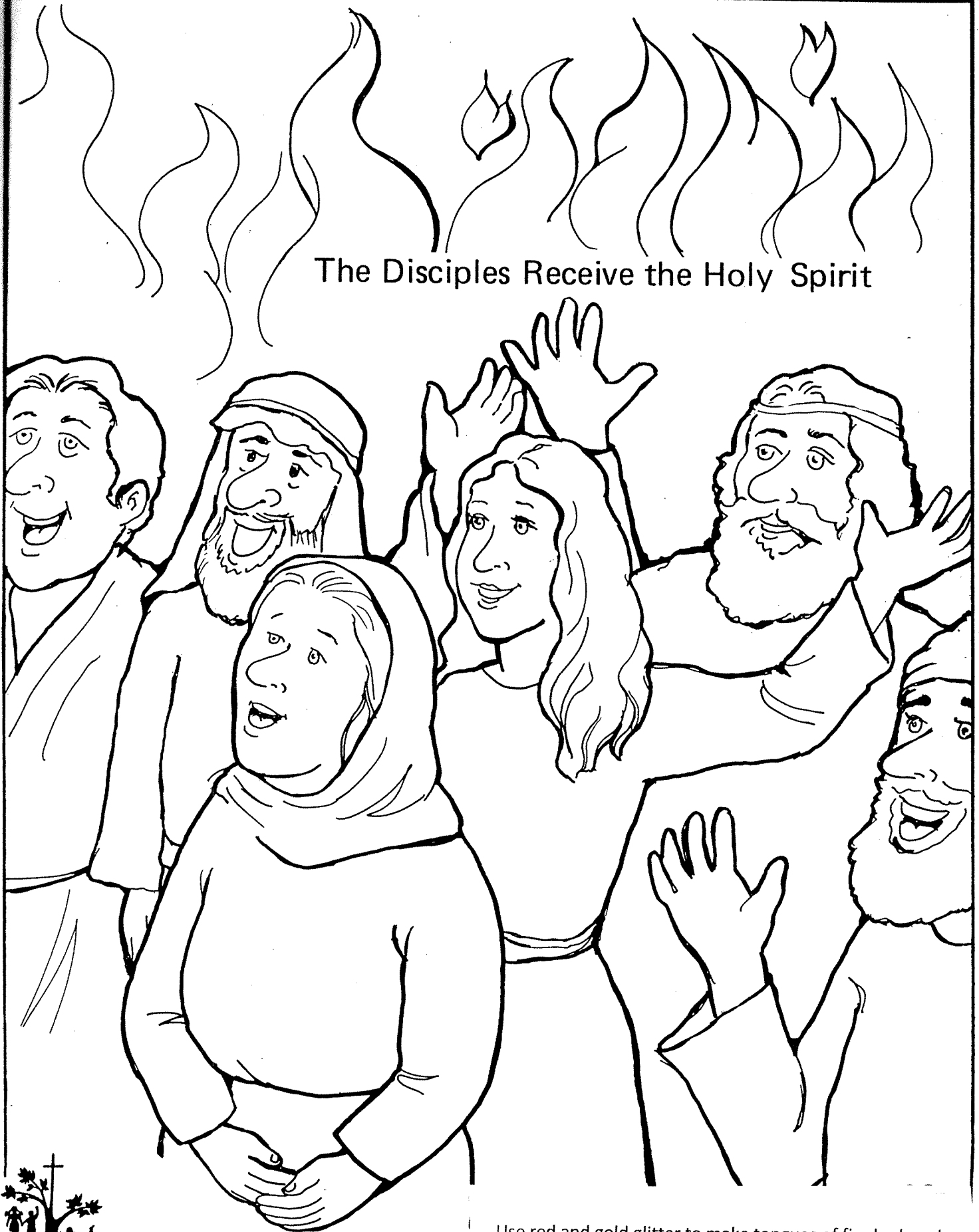

Use red and gold glitter to make tongues of fire look real.

## The Day of Pentecost

- 1 Took Judas' place as an apostle  
Acts 1:26 \_\_\_\_\_ Pierced
- 2 On the Day of Pentecost this came  
rushing in and filled the whole  
house where they were sitting.  
Acts 2:2 \_\_\_\_\_ Jews
- 3 The Apostles were filled with this  
and began to speak in this.  
Acts 2:4 \_\_\_\_\_ Baptized
- 4 They were from every nation and  
heard the disciples speak in their  
own language.  
Acts 2: 5,6 \_\_\_\_\_ Matthias
- 5 Taking his stand with the eleven  
he spoke to the men of Judea, and  
all who lived in Jerusalem.  
Acts 2: 14 \_\_\_\_\_ Wind
- 6 After Peter spoke to them this  
happened to their hearts.  
Acts 2:37 \_\_\_\_\_ Holy Spirit  
Tongues
- 7 They were told to repent and be....  
Acts 2:38 \_\_\_\_\_ Peter
- 8 They sold and divided these so no  
one was in need.  
Acts 2:45 \_\_\_\_\_ Possessions

# Day of Pentecost



**4 Letters**

WIND

**5 Letters**

DOUBT

SOUND

SPEAK

**6 Letters**

ACCORD

AMAZED

DEVOUT

FILLED

MIGHTY

NOISED

**7 Letters**

RUSHING

SITTING

TONQUES

**8 Letters**

APPEARED

CONFOUND

DWELLING

LANGUAGE

SUDDENLY

**9 Letters**

PENTECOST

STRANGERS

# Day of Pentecost

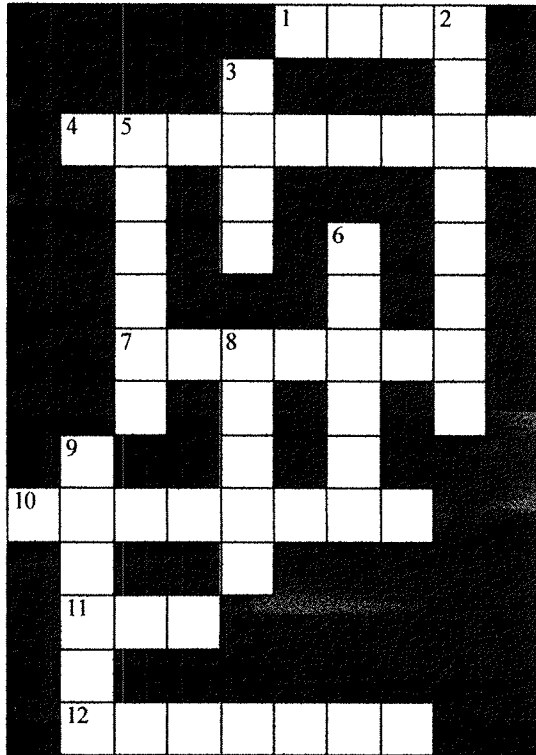

## ACROSS

- 1 For these are not drunken, as ye suppose, seeing it is but the third hour of the day. But this is that which was spoken by the prophet \_\_\_\_\_;
- 4 And they were all amazed and marvelled, saying one to another, Behold, are not all these which speak \_\_\_\_\_? And how hear we every man in our own tongue, wherein we were born.
- 7 And suddenly there came a sound from heaven as of a \_\_\_\_\_

mighty wind, and it filled all the house where they were sitting.

- 10 And on my \_\_\_\_\_ and on my handmaidens I will pour out in those days of my Spirit; and they shall prophesy:
- 11 . . . in Egypt, and in the parts of Libya about Cyrene, and strangers of Rome, Jews and proselytes, 11 Cretes and Arabians, we do hear them speak in \_\_\_\_\_ tongues the wonderful works of God.
- 12 And there appeared unto them cloven \_\_\_\_\_

like as of fire, and it sat upon each of them.

## DOWN

- 2 Now when this was noised abroad, the multitude came together, and were confounded, because that every man heard them speak in his own \_\_\_\_\_.
- 3 And they were all amazed, and were in doubt, saying one to another, What meaneth this? Others mocking said, These men are full of new \_\_\_\_\_.
- 5 And when the day of Pentecost was fully come, they were all with one \_\_\_\_\_ in one place.
- 6 And it shall come to pass in the last days, saith God, I will pour out of my \_\_\_\_\_ upon all flesh: and your sons and your daughters shall prophesy, and your young men shall see visions, and your old men shall dream dreams:
- 8 And they were all filled with the Holy Ghost, and began to \_\_\_\_\_ with other tongues, as the Spirit gave them utterance.
- 9 And there were dwelling at Jerusalem Jews, \_\_\_\_\_ men, out of every nation under heaven.

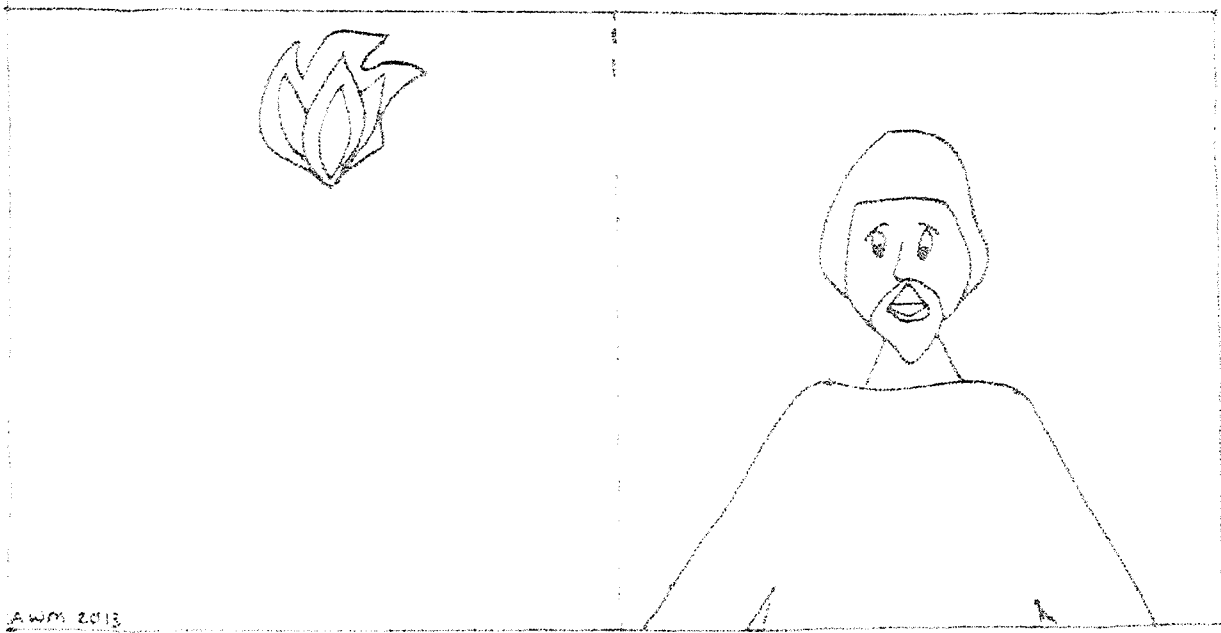

# Pentecost Spinner

1. Cut out the rectangle above and colour it in
2. Fold along the dotted line
3. Turn the rectangle face down

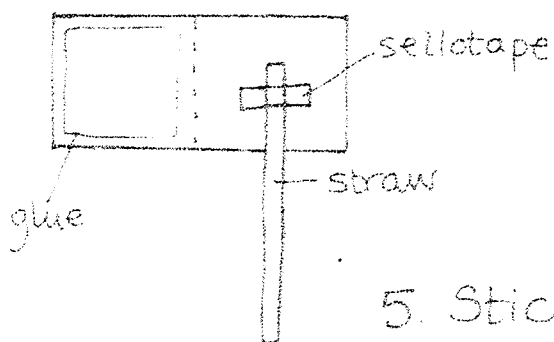

4. Stick a straw to the middle of one half and glue all round the other half

5. Stick the glued side on top of the straw side

6. Twizzle the straw between your hands to make the sound of the wind

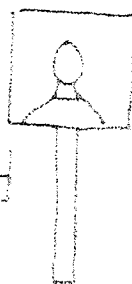

7. Watch the flame appear above the disciple's head!

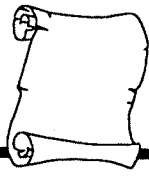

# Jesus

## Dying and Rising Again

I Corinthians 15:1-8; I Timothy 1:15

### Memory Verse

*He that believeth on the Son hath everlasting life.*

John 3:36

### For the Teacher

Provide a Bible, a pencil or marker, and a duplicated copy of the puzzle for each child. The verses quoted are from the KJV, but the words in the puzzle are also in the NIV. To solve the puzzle as a group, place the crossword on a wall, using one sheet of paper for each square. Divide the children into two teams. Give each team a different color marker. Choose a team to begin. Read the first sentence. The team must say the correct answer aloud and choose a player to fill in the blanks (with the team's help). If the team answers incorrectly, the other team may answer. If neither team answers correctly, the first team to find the correct answer in the Bible may write it in the puzzle. Give each team 1000 points for a correct answer. The first team to unscramble the circled words receives an additional 2000 points. Answers are on page 62.

### Introduction

Why did the Son of God become a Man? Was it to teach us about God? Was it to heal the sick? He did those things and much more. But the real reason He came was to die. As Man, He could die for our sins. Because He is God, He rose again. He came to save sinners and take them to heaven one day, if they believe in Him.

### Good News Crossword Puzzle

Are you saved from your sins? If you are, can you tell someone else the Good News of salvation? Here are the steps to salvation (the verses that go with them are in the puzzle): 1) I have sinned. 2) Jesus died for my sins and rose again. 3) I repent (turn away from my sins). 4) I believe in Jesus as my Savior and receive Him into my heart. Look up the verses, find the missing word, and print it in the puzzle. Then, print the circled letters in the blanks and unscramble them to discover what the Good News of salvation is called.

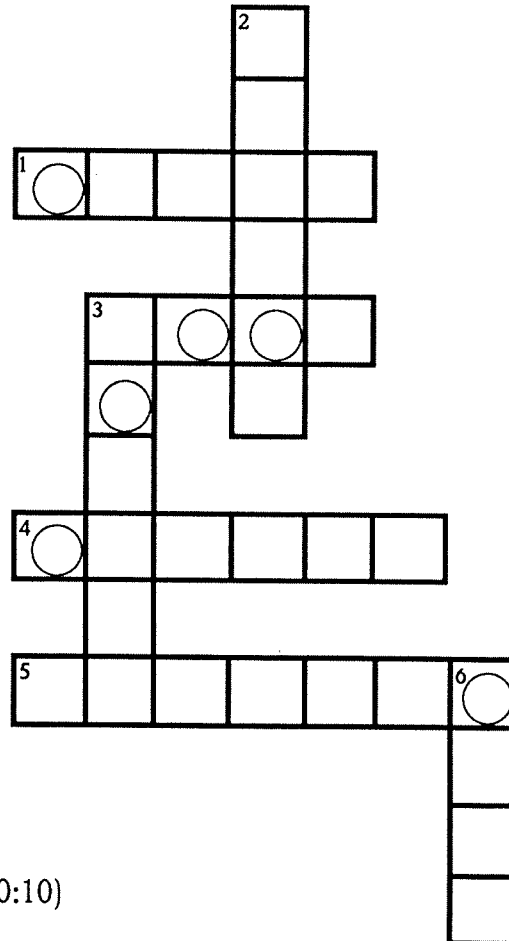

### Across

- All have sinned and come short of the \_\_\_\_\_ of God. (Romans 3:23)
- We believe that Jesus died and \_\_\_\_\_ again. (I Thessalonians 4:14)
- Whosoever believeth in Him should not \_\_\_\_\_. (John 3:16)
- I give unto them \_\_\_\_\_ life. (John 10:28)

### Down

- \_\_\_\_\_ died for our sins. (I Corinthians 15:3)
- \_\_\_\_\_ and turn to God. (Acts 26:20)
- I am come that they might have \_\_\_\_\_. (John 10:10)

What is the Good News of salvation called? The \_\_\_\_\_

## Steps of Salvation

1. **Hear** the gospel
  - a. Romans 10:8-15
2. **Believe/ Have Faith** that Jesus Christ is the son of God
  - a. John 6:28-29
  - b. Hebrews 11:6
3. **Repent** of your sins (turn away)
  - a. Luke 13:3
  - b. Acts 17:30
  - c. Acts 26:20
  - d. 2 Peter 3:9
4. **Confess** that you believe that Jesus is the son of God
  - a. Matthew 10:32
  - b. Acts 8:37
5. **Baptism**
  - a. Matthew 28:19 “in the name of the Father, Son & Holy Spirit”
  - b. Mark 16:16
  - c. John 3:5
  - d. Acts 2:38-39
  - e. Acts 10:47-48
  - f. Acts 22:16
  - g. Romans 6:4
  - h. Galatians 3:27
  - i. 1 Peter 3:20-21
6. **Live Faithfully**
  - a. Matthew 6:33
  - b. John 14:15
  - c. Romans 12:1-2
  - d. 1 Corinthians 6:19-20
  - e. Revelation 22:14

**Year 3**  
**Week 145**

## **A Lame Man Healed--Ananias and Sapphira**

**Scriptures: Acts 3:1-11, Acts 5:1-11**

**Key Verse: Acts 5:4 "... 'Why have you conceived this thing in your heart? You have not lied to men but to God.'"**

### **Key Points:**

- 1.** Peter and John went to the temple to pray. They saw a lame man by the gate who asked them for money. Peter said "I do not have silver or gold, but what I do have I give you. In the name of Jesus Christ of Nazareth, rise up and walk." Peter took his hand and lifted the man, and his legs became strong.
- 2.** The man entered the temple with Peter and John, leaping, walking and praising God. The people who saw them were amazed because they knew this was the man who sat begging for charity.
- 3.** A man named Ananias and his wife, Sapphira, sold some property. With his wife's knowledge, Ananias brought a portion of the money from the sale to the apostles. He wanted people to think that he was giving all the money they made from the sale.
- 4.** Peter told him that the land and the money were his to control, but he could not lie to God. Ananias fell dead at his feet. The young men carried him out and buried him.
- 5.** Three hours later, Sapphira came in, not knowing what had happened to her husband. Peter asked if she had sold the land for the price Ananias had said. She answered yes. Peter said, "How is it that you have agreed together to test the Spirit of the Lord? Look, the feet of those who have buried your husband are at the door, and they will carry you out."
- 6.** Immediately, she fell dead and was buried near her husband.
- 7.** The people in the church and all others who heard what had happened were very fearful.



# The Lame Man Healed

## Acts 3: 1-11

1. Who went up to the temple at the ninth hour to pray?  
\_\_\_\_\_ and \_\_\_\_\_
2. A certain man who had been lame since birth was placed every day at the temple gate called Beautiful, in order to beg for \_\_\_\_\_.
3. When he saw Peter and John going into the \_\_\_\_\_, he began asking to receive alms.
4. And Peter, along with John, fixed his gaze upon him and said,  
“ \_\_\_\_\_ ”!
5. And he began to give them his attention, expecting to receive \_\_\_\_\_ from them.
6. But Peter said, “I do not have \_\_\_\_\_ and \_\_\_\_\_, but what I do have I give to you: “In the name of Jesus Christ the Nazarene \_\_\_\_\_!”
7. And seizing him by the right hand, he raised him up; and immediately his \_\_\_\_\_ and his \_\_\_\_\_ were strengthened.
8. And with a \_\_\_\_\_, he stood upright and began to walk, and he entered the temple, walking and leaping, and praising \_\_\_\_\_;
9. And all the \_\_\_\_\_ saw him walking and praising \_\_\_\_\_.

# PETER

## JESUS MAKES A DIFFERENCE

### MEMORY VERSE

*In the name of Jesus Christ...walk. ~ Acts 3:6*

Acts 3:1-10

**INTRODUCTION** Peter and John walked toward the temple. A man saw them. This man had never been able to walk. He asked the disciples for money. Peter looked at the man and said, "I don't have silver or gold, but I will give you something. In the name of Jesus, walk." Peter took the man's hand and the man stood up and walked! Everyone was happy and rejoiced. They knew that they had seen another miracle.

**WHAT'S THE DIFFERENCE?** In this story, we learn that Jesus makes a difference in people's lives. Jesus healed the man's legs when Peter prayed for him. Look at the two pictures below. There are things that are different in the two pictures. Can you find them? Color the differences when you find them. Think about how Jesus can make a difference in your life.



*In the name of Jesus Christ...walk. ~ Acts 3:6*



**FOR THE TEACHER** Duplicate this page for each child. Encourage each child to locate the five differences and color them (taller tree, stripes on coat, sitting/standing man, basket/pot, dog/cat). Talk about the positive impact Jesus can have on each person's life. Share examples of how Jesus can comfort us when we are afraid and help us make the right choice in a difficult situation.

## The Healing of the Disabled Beggar at the Temple Acts 3: 1-13



Calvary Kids Pages [www.calvarywilliamsport.com/kids-index](http://www.calvarywilliamsport.com/kids-index)



# Heaven Herald



By Grace Through Faith Ephesians 2:8-9

All the News That's Fit to Live By

## Ananias and Sapphira Caught In Their Lie

Ex. 20:16 You shall not bear false witness  
Name of Artist: \_\_\_\_\_ Age: \_\_\_\_\_  
against your neighbor.



# T is for

# Tell the truth

Write tell the truth above.

Put On The Belt Of Truth  
Ephesians 6:14a

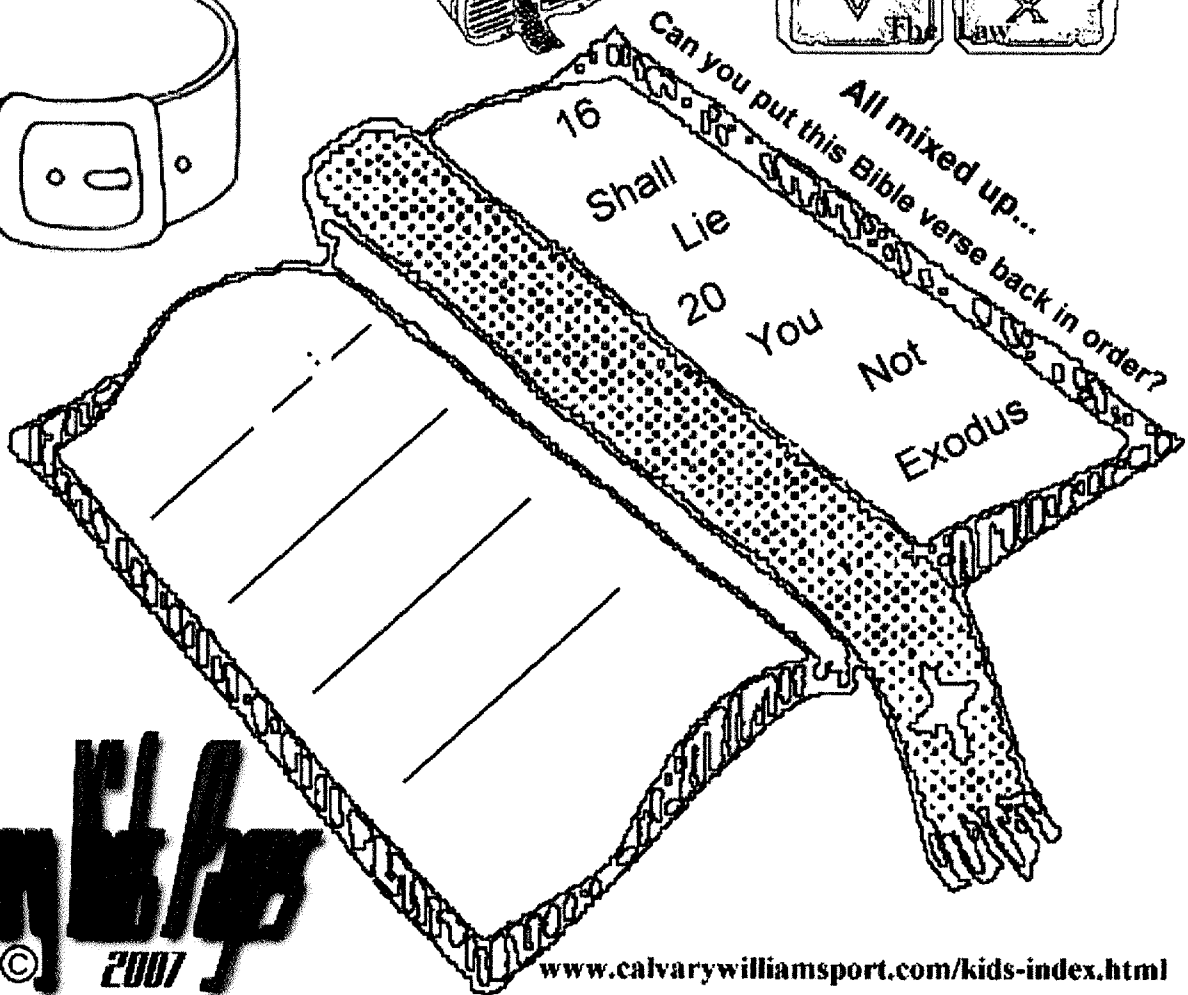
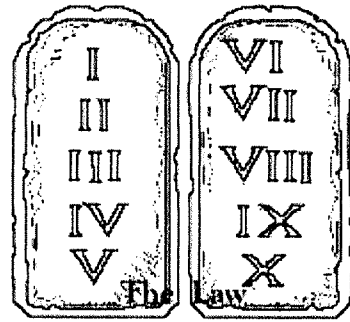
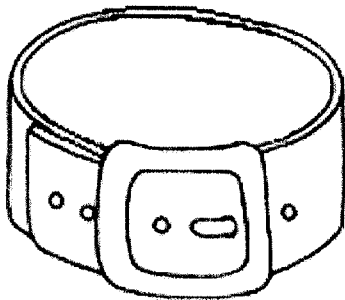

[www.calvarywilliamsport.com/kids-index.html](http://www.calvarywilliamsport.com/kids-index.html)

Calvary Kids Pages [www.calvarywilliamsport.com/kids-index](http://www.calvarywilliamsport.com/kids-index)

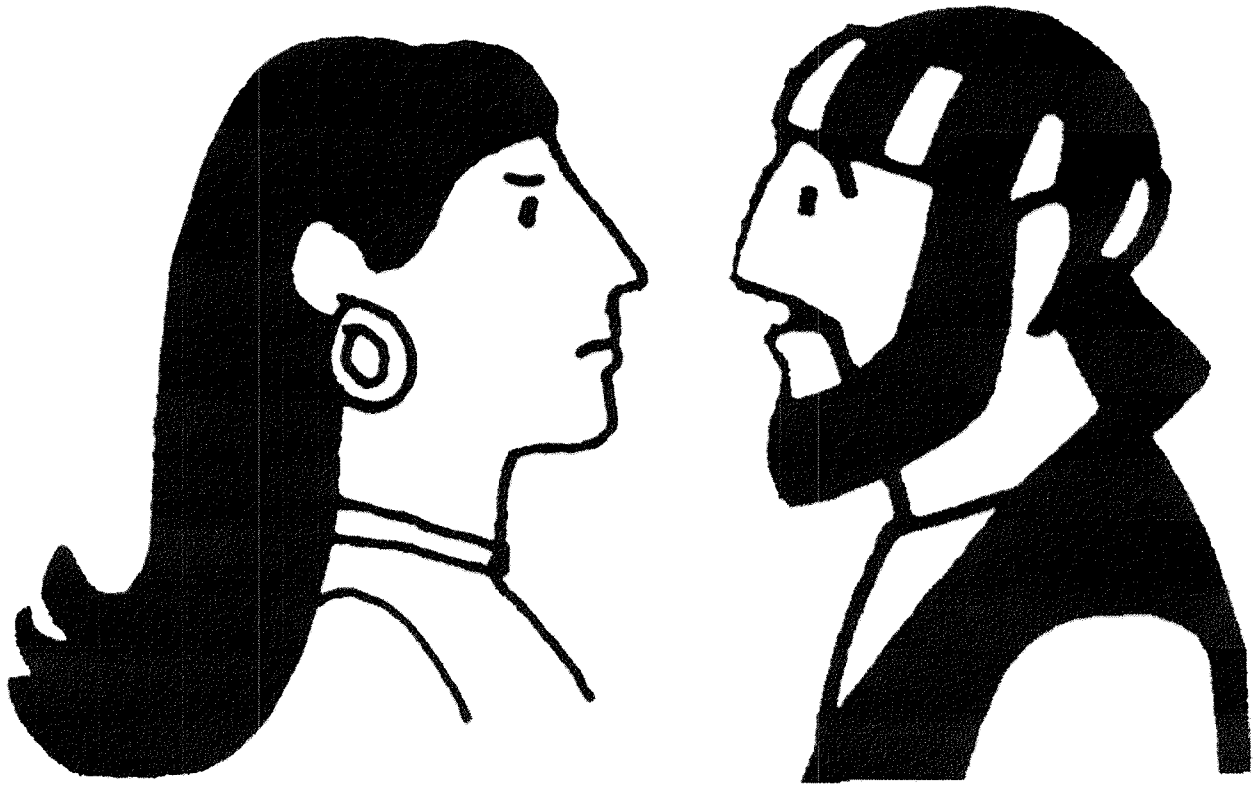

From *The Complete Bible Story Clip Art Book*. ©Gospel Light. Used by permission.

ACTS 5:1-10

Ananias and Sapphira

Lie to the Holy Spirit  
and Apostles

# 249. ANANIAS AND SAPPHIRA

(ACTS 5:1-11)



"But a certain man named Ananias, with Sapphira his wife, sold a possession, and kept back *part* of the price, his wife also being privy *to it*, and brought a certain part, and laid *it* at the apostles' feet."

**ACTS 5:1-2**





## ANANIAS & SAPPHIRA

Story: Acts 5:1-11



Memory Verse: Colossians 3:9a

# Ananias and Sapphira Word Puzzle

<http://SundaySchoolResources.co.uk>

Fill in the missing words. Transfer the highlighted letter to the bottom of the page to find out the answers to the questions. Some letters have been filled in to help you out.

- 1) Ananias and Sapphira did not tell the \_ \_ \_ \_ \_
- 2) Peter and John were A \_ \_ \_ \_ \_
- 3) The believers shared their \_ \_ \_ \_ Y with each other
- 4) The believers met together to break \_ \_ \_ \_ D
- 5) Ananias had a wife called \_ \_ \_ \_ \_
- 6) Peter knew Ananias was lying because the Holy \_ \_ \_ \_ \_ told him
- 7) Some \_ \_ \_ NG men carried Ananias out and buried him
- 8) Ananias and Sapphira \_ \_ \_ \_ down dead
- 9) Ananias and Sapphira kept back part of the \_ R \_ C \_
- 10) God loves a cheerful \_ \_ V \_ \_
- 11) The believers were \_ C A \_ \_ \_ when they saw what happened to Ananias and Sapphira

What does God love? \_ \_ \_ \_ \_

What does God hate? \_ \_ \_ \_ \_

Answers to word puzzle:

---

TRUTH

APOSTLES

MONEY

BREAD

SAPPHIRA

SPIRIT

YOUNG

FELL

PRICE

GIVER

SCARED

Questions:

HONESTY

LIES

**Year 3**

**Week 146**

## **The Disciples Are Persecuted**

**Scriptures: Acts 5: 12-42**

**Key Verse: Acts 5:29 "But Peter and the other apostles answered and said: 'We ought to obey God rather than men.'"**

### **Key Points:**

- 1.** Signs and wonders and healing were done through the hands of the apostles. Many believers were added to the church.
- 2.** The high priest and the Sadducees had the apostles put in prison. During the night, an angel freed them from prison and told them to teach in the temple.
- 3.** When the council met the next morning, they sent for the apostles. The officers returned and reported that although the prison was securely shut and guarded, the prisoners were gone.
- 4.** Someone told them the men who had been imprisoned were teaching the people in the temple. The captain was sent to bring the apostles to the council. The high priest rebuked them, saying, "Did we not strictly command you not to teach in this name?" But they answered him, "We must obey God rather than men."
- 5.** The council decided to kill the apostles. But Gamaliel, a Pharisee, sent the apostles outside and advised the council to leave the apostles alone and wait and see if their work was of men, in which case it would come to nothing, or if it was of God, then it could not be stopped. They agreed, then had the apostles beaten, commanded them to not speak of Jesus, and let them go.
- 6.** The apostles rejoiced that they were counted worthy to suffer for Jesus' name, and they continued to teach and preach the gospel.

# The Twelve Disciples

## Matthew 10:2-4

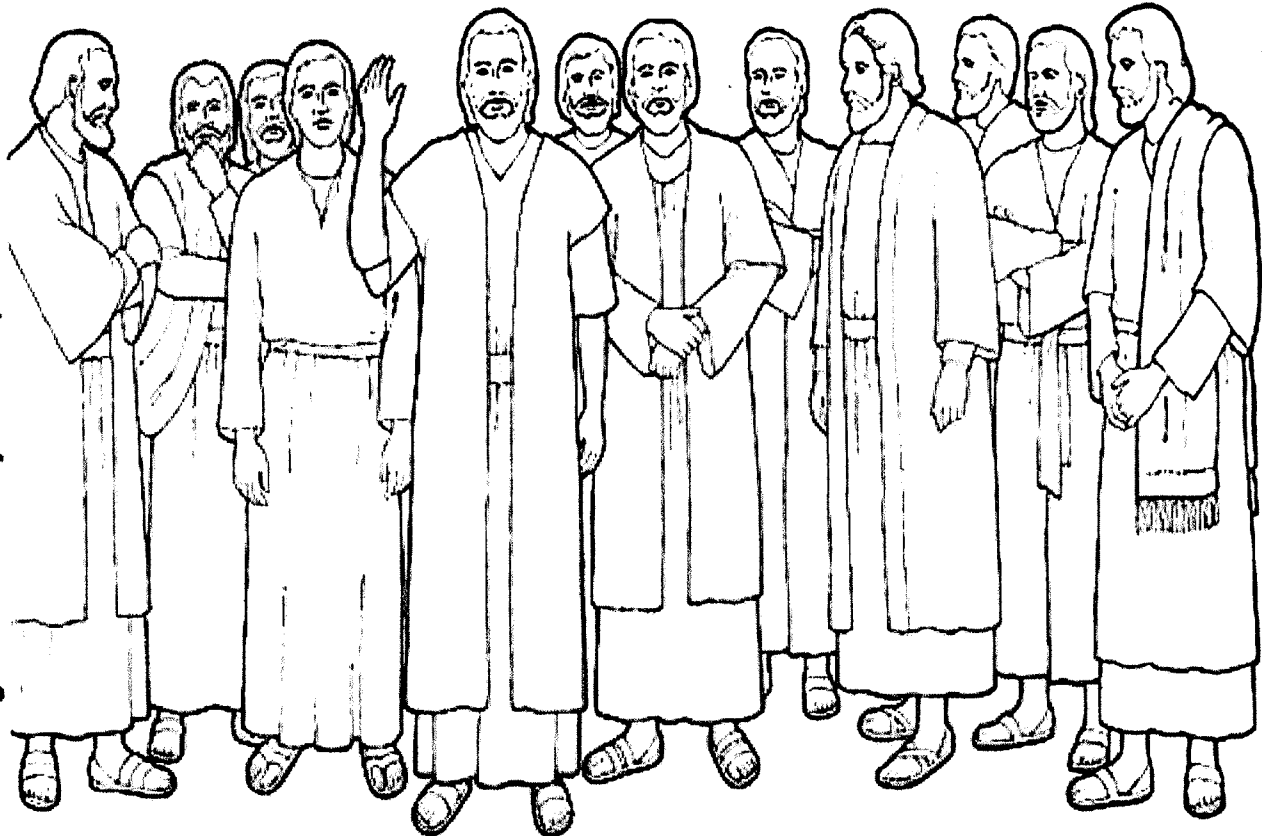

**ANDREW - BARTHOLOMEW - JAMES -  
JAMES son of ALPHAEUS - JOHN -  
JUDAS - MATTHEW - PETER - PHILIP -  
SIMON - THADDAEUS - THOMAS**

Calvary Kids Pages [www.calvarywilliamsport.com/kid-index.html](http://www.calvarywilliamsport.com/kid-index.html)

Calvary Kids Pages [www.calvarywilliamsport.com/kid-index.html](http://www.calvarywilliamsport.com/kid-index.html)

The Twelve Disciples

Calvary Kids Pages [www.calvarywilliamsport.com/kids-index](http://www.calvarywilliamsport.com/kids-index)

# The Twelve Disciples

Matthew 10:2 - 4

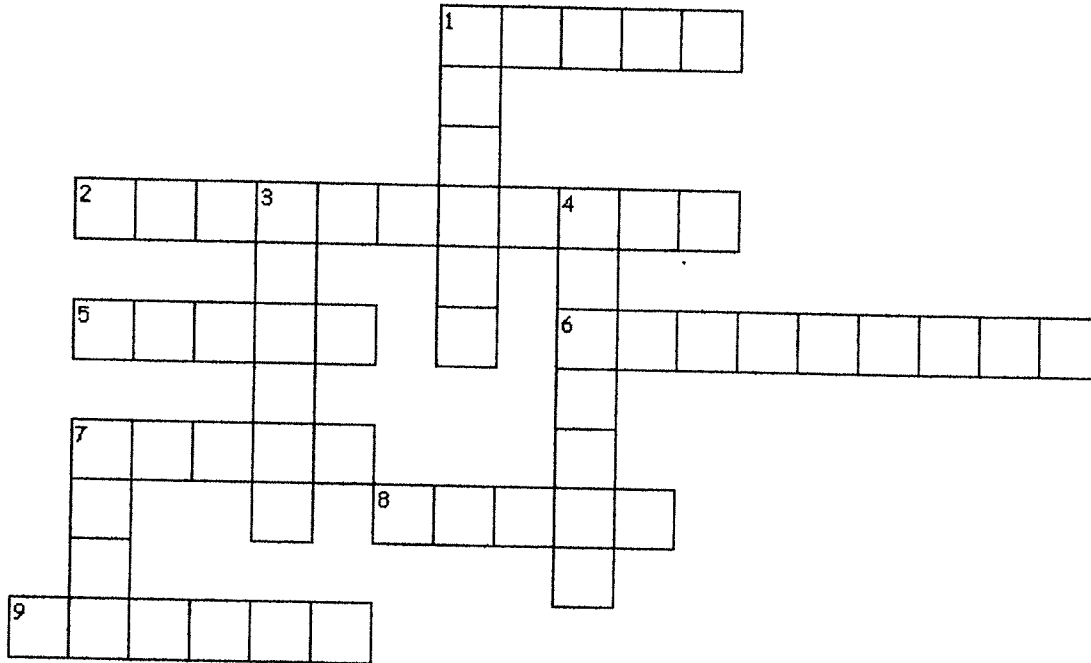

## Across

1. Simon
2. Listed after Philip
5. The Zealot
6. Listed tenth (Matthew chapter 10)
7. The one who betrayed Jesus (Matt.26:14 - 25)
8. Son of Zebedee
9. Peter's brother

## Down

1. Told an Ethiopian the good news (Acts 8:25 - 39)
3. Unless I see, I will not believe (John 20:24 - 29)
4. Tax collector
7. Brother of James

Calvary Kids Pages [www.calvarywilliamsport.com/kids-index](http://www.calvarywilliamsport.com/kids-index)

# THE DISCIPLES

L	N	H	O	J	W	M	S	J
U	S	F	Y	E	Q	A	I	U
K	K	M	R	R	E	R	M	D
E	W	D	A	J	G	K	O	A
D	N	B	P	T	A	W	N	S
A	L	U	A	P	T	M	K	C
P	E	T	E	R	U	H	E	U
W	S	A	M	O	H	T	E	S
M	V	P	I	L	I	H	P	W

# THE DISCIPLES

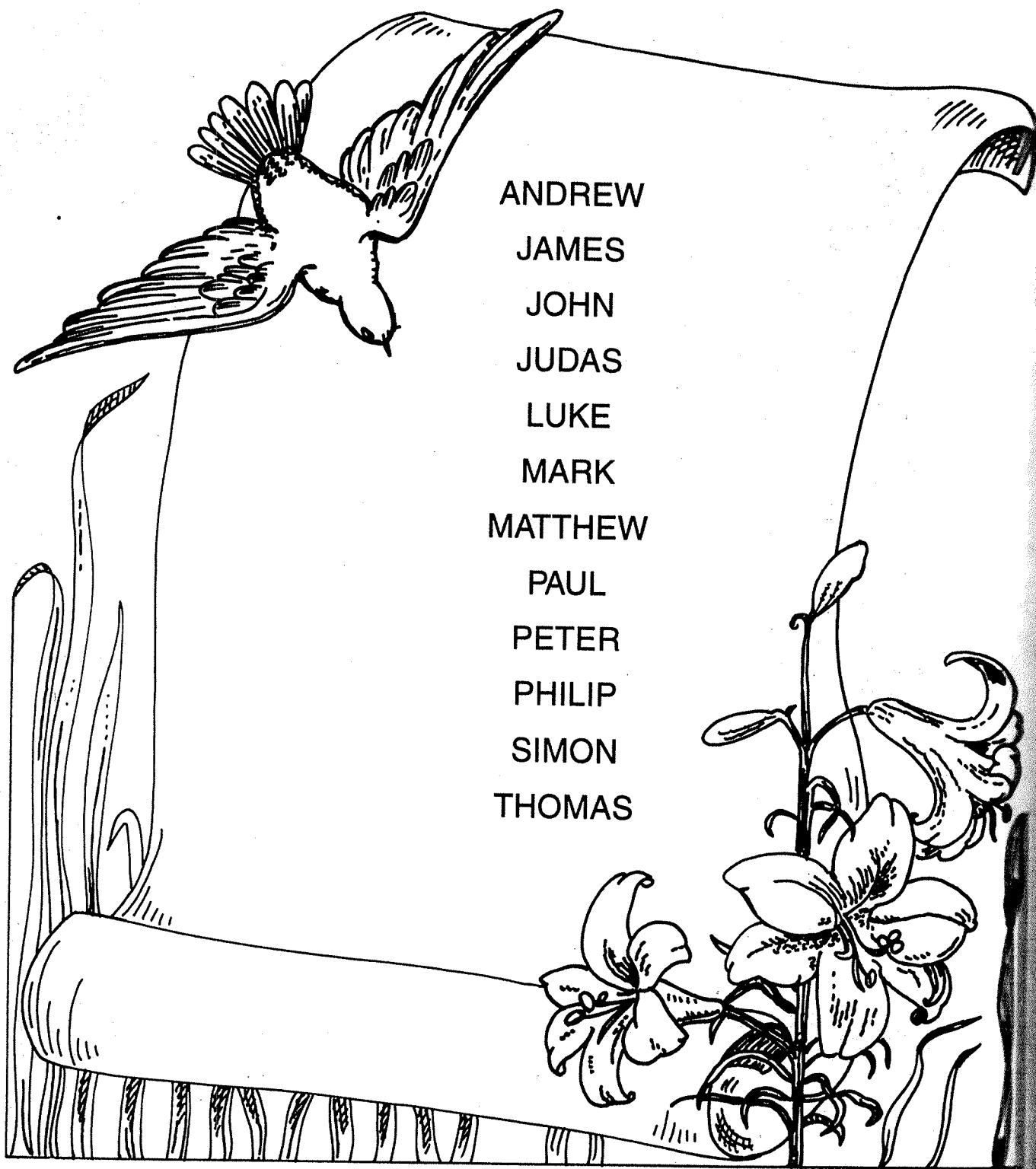

ANDREW

JAMES

JOHN

JUDAS

LUKE

MARK

MATTHEW

PAUL

PETER

PHILIP

SIMON

THOMAS

Find the words in the word list on the facing page. Look across, down, forwards and backwards. Circle the words you find.



apostles in prison  
facing card

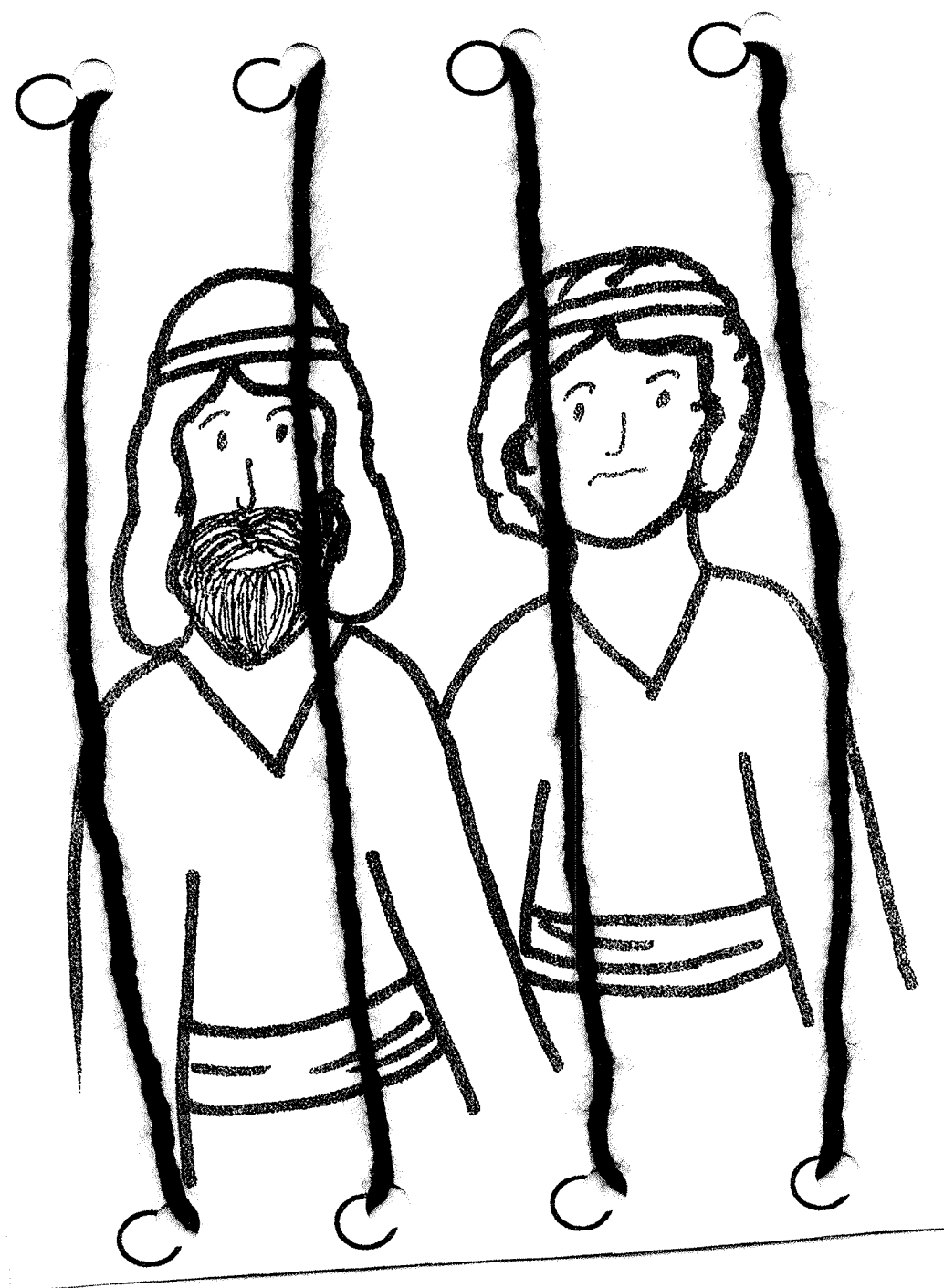

**Year 3**  
**Week 147**

## **Stoning of Stephen**

**Scriptures: Acts 6:5-15, Acts 7:1-60**

**Key Verse: Acts 7:55 "But he [Stephen], being full of the Holy Spirit, gazed into heaven and saw the glory of God, and Jesus standing at the right hand of God . . ."**

### **Key Points:**

1. Stephen was appointed a deacon in the church. He was full of faith and power and did great signs and wonders among the people.
2. Some of the Jews accused him of blasphemy and stirred up the people, the elders, and the scribes against Stephen. They seized him and brought him before the council to answer the charges.
3. Stephen addressed the council, reminding them of Jewish history beginning with the call of Abraham, the patriarchs, and Joseph in Egypt. He continued with Moses--the deliverance from slavery, the golden calf, the giving of the law, and forty years in the wilderness.
4. Stephen accused the council of being like their forefathers who persecuted the prophets and rebelled against the Holy Spirit, even to the murder of Jesus, the Just One.
5. The men became so angry that they took Stephen out of the city and stoned him. As he was dying, Stephen called on God to receive his spirit and to not charge this sin against those who killed him.
6. A young man named Saul witnessed the stoning of Stephen.



**Forgive them.**

Color the picture. Add Styrofoam chips for stones. What did Stephen say as he was dying?  
The words tell you.

# STEPHEN

---

## Word List

DRAG	FILLED	FACE	MARTYR
ANGEL	PRAYED	FAITH	SPEECH
FALSE	SPIRIT	FIRST	STONED
GRACE	WISDOM	POWER	FURIOUS
SEIZE	WITNESS	SANHEDRIN	



They chose Stephen, a man \_\_\_\_\_

\_\_\_\_\_ and of \_\_\_\_\_

\_\_\_\_\_. —Acts 6:5

## Stoning of Stephen

1. Wherefore, brethren, look ye out among you \_\_\_\_\_ men of honest report, full of the \_\_\_\_\_ and \_\_\_\_\_, whom we may appoint over this business. *Acts 6:3*
2. And Stephen, full of \_\_\_\_\_ and \_\_\_\_\_, did great wonders and miracles among the people. *Acts 6:8*
3. And they were not able to resist the wisdom and the spirit by which he \_\_\_\_\_. *Acts 6:10*
4. And set up \_\_\_\_\_ witnesses, which said, This man ceaseth not to speak blasphemous words against this holy place, and the \_\_\_\_\_. *Acts 6:13*
5. And all that sat in the \_\_\_\_\_, looking stedfastly on him, saw his face as it had been the face of an \_\_\_\_\_. *Acts 6:15*
6. Ye stiff-necked and uncircumcised in \_\_\_\_\_ and \_\_\_\_\_, ye do always resist the Holy Ghost: as your fathers did, so do ye. *Acts 7:51*
7. When they heard these things, they were \_\_\_\_\_ to the heart, and they gnashed on him with their \_\_\_\_\_. *Acts 7:54*
8. And \_\_\_\_\_ him out of the city, and stoned him: and the witnesses laid down their clothes at a young man's feet, whose name was \_\_\_\_\_. *Acts 7:58*
9. And he kneeled down, and cried with a loud voice, Lord, lay not this \_\_\_\_\_ to their charge. And when he had said this, he fell \_\_\_\_\_.  
*Acts 7:60*

Word choices for Stoning of Stephen sheet:

seven	Holy Ghost	wisdom	faith
wisdom	spake	false	law
council	angel	heart	ears
cut	teeth	cast	Saul
sin	asleep		

**Year 3**  
**Week 148**

## **The Magician and the Ethiopian-- The Teachings of Philip**

**Scriptures: Acts 8**

**Key Verse: Acts 8:37** "Then Philip said, 'If you believe with all your heart, you may [be baptized].' And he answered and said, 'I believe that Jesus Christ is the Son of God.'"

### **Key Points:**

1. Saul agreed with the death of Stephen. He persecuted the church, and sent many Christians to prison.
2. Many fled Jerusalem and continued to preach the gospel in other cities. Philip preached Christ in Samaria. There was a sorcerer named Simon who had amazed the people with his magic. Many people in Samaria were baptized, including Simon. Simon followed Philip and was astonished by the signs and miracles he witnessed.
3. Peter and John were sent to Samaria, where they prayed and laid hands on the people to receive the Holy Spirit. Simon offered them money to have the power to lay his hands on others to receive the Holy Spirit. Peter rebuked him for trying to buy the gift of God. Simon was told to repent of his sin and pray for forgiveness because his heart was not right with God. He asked Peter to pray for him also.
4. An angel told Philip to go to a desert road. He saw an Ethiopian, the treasurer of the queen, reading the book of Isaiah as he traveled by chariot. The Spirit told Philip to run to this man.
5. Philip asked if he understood what he was reading, and he replied that he needed help. He was reading prophecy about Jesus, so Philip explained the scripture and preached Jesus to him. As they went down the road, they passed some water, and the Ethiopian asked if he could be baptized. Philip answered, "If you believe with all your heart, you may." He answered rightly, and they both went into the water, and the eunuch was baptized. When they came out of the water, the Spirit took Philip away, and the Ethiopian continued on his journey rejoicing.

# Acts 8:25 - 39

## Philip And The Ethiopian Eunuch

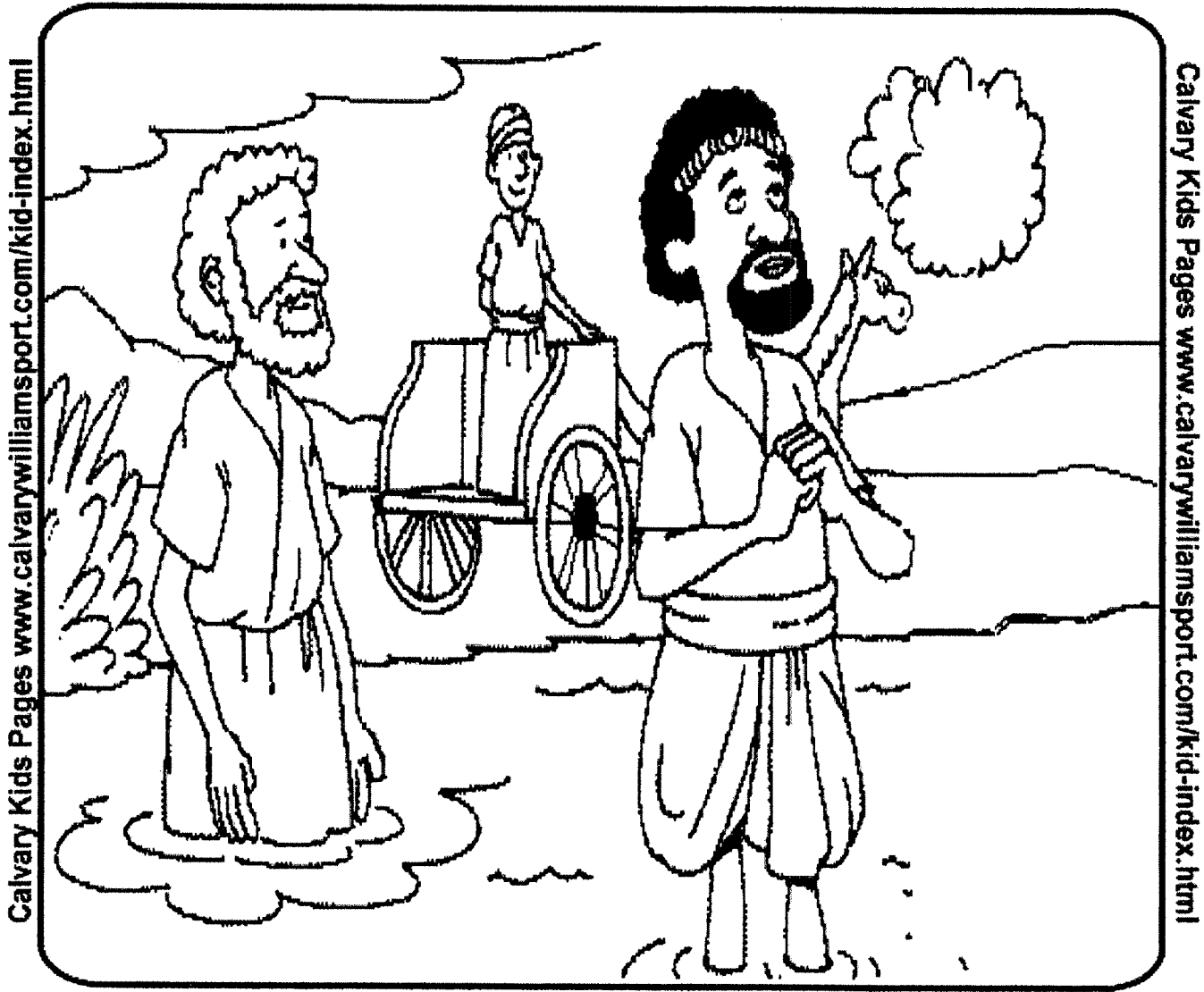

Calvary Kids Pages [www.calvarywilliamsport.com/kid-index.html](http://www.calvarywilliamsport.com/kid-index.html)

Calvary Kids Pages [www.calvarywilliamsport.com/kid-index.html](http://www.calvarywilliamsport.com/kid-index.html)

Calvary Kids Pages [www.calvarywilliamsport.com/kids-index](http://www.calvarywilliamsport.com/kids-index)



## Philip & the Ethiopian eunuch

Cut out figures and place on a wooden stick, then place into water for the baptism



Cut open below where the water is represented in dark. Place figures of Philip and the Ethiopian in the water to represent the baptism.

*cut open  
for figures*

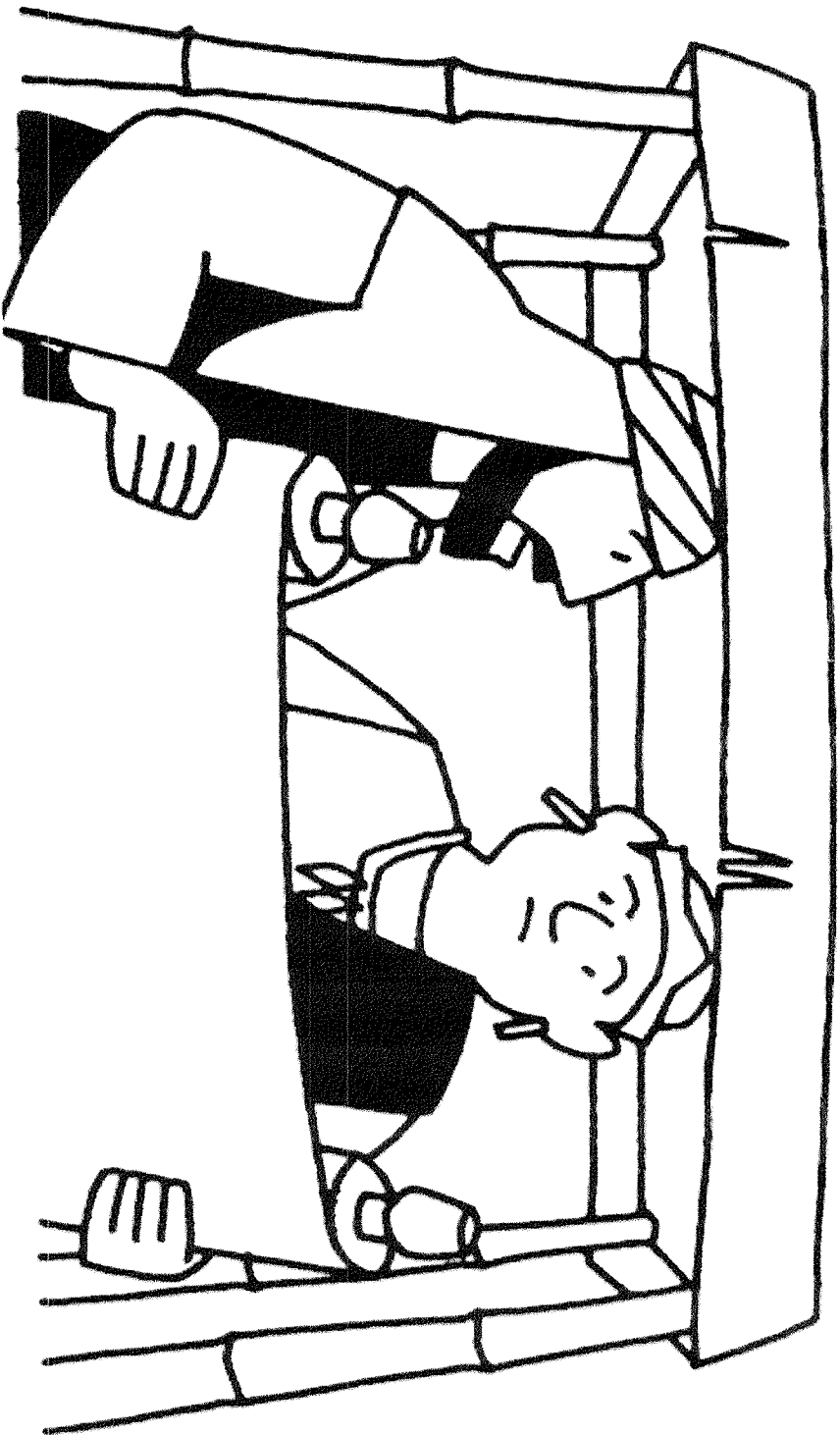

*From The Complete Bible Story Clip Art Book. ©Gospel Light. Used by permission.*

# Philip And The Ethiopian Eunuch

Acts 8:25 - 39



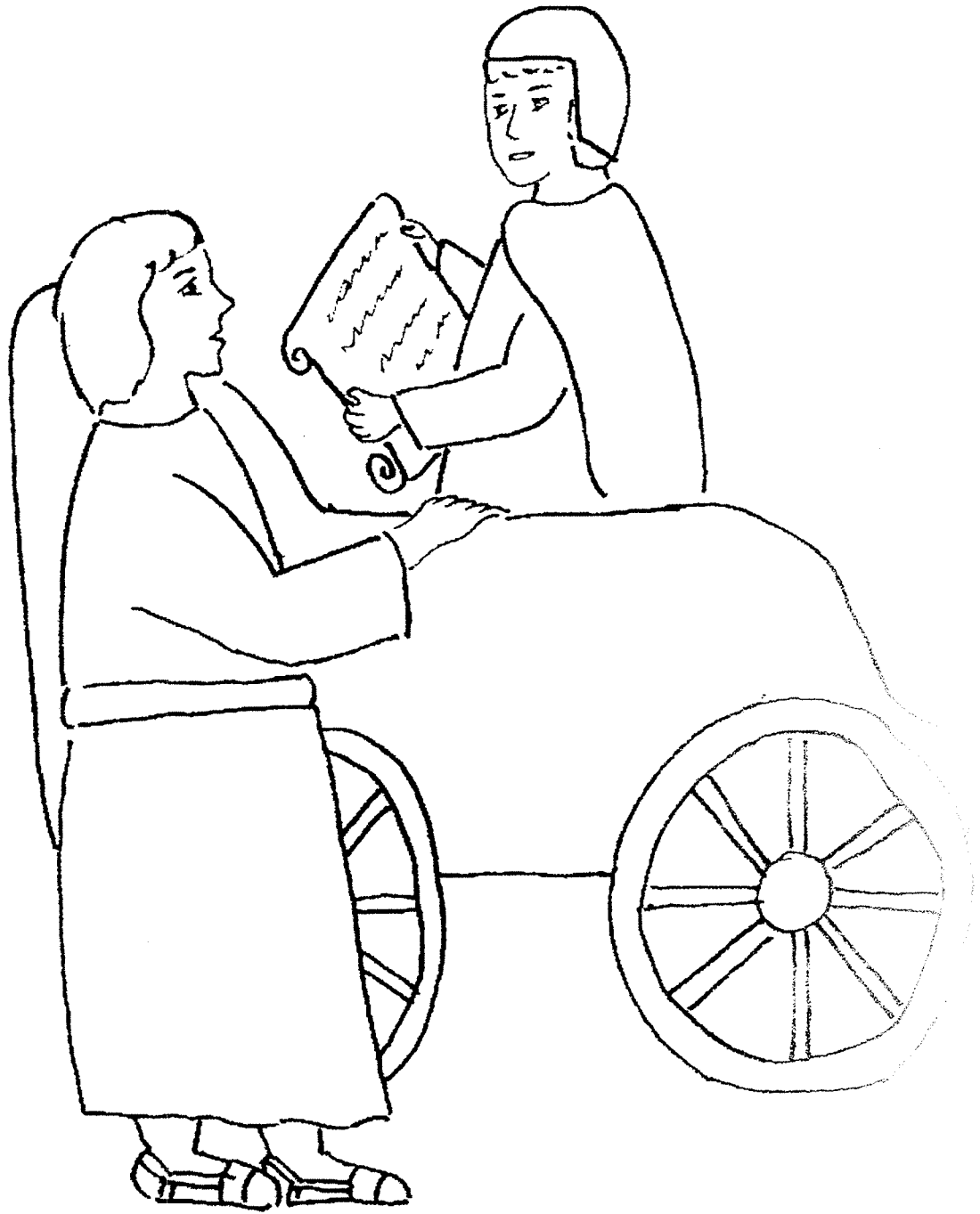

# Philip the Evangelist

Read the Bible story at <http://gardenofpraise.com/bibl56s.htm>

						1								
2										3	4			
5														
	6													
									7					
8														
								9						
		10												

## Across

## Down

- |                                                             |                                           |
|-------------------------------------------------------------|-------------------------------------------|
| 2. Upon his confession Philip _____ the Ethiopian.          | 1. He was near the _____ Sea.             |
| 3. Philip was one of the _____ chosen to care for widows.   | 4. The man in the chariot was from _____. |
| 5. what the man was reading                                 |                                           |
| 6. Philip preached to him the _____ about Christ.           |                                           |
| 7. how the man felt as he went on his way                   |                                           |
| 8. The man was in charge of the queen's _____.              |                                           |
| 9. the district to which Philip fled when he left Jerusalem |                                           |
| 10. Christians were killed due to a great _____.            |                                           |

WORD BANK: PERSECUTION, SAMARIA, MEDITERRANEAN, ETHIOPIA, TREASURY, BOOK OF ISAIAH, GOOD NEWS, BAPTIZED, HAPPY, SEVEN

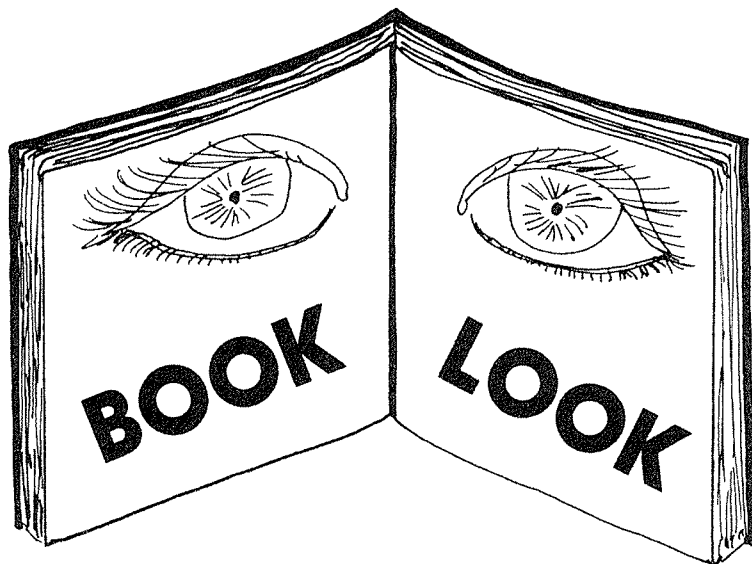

Read up, down, forward, backward, or diagonally to find these New Testament books:

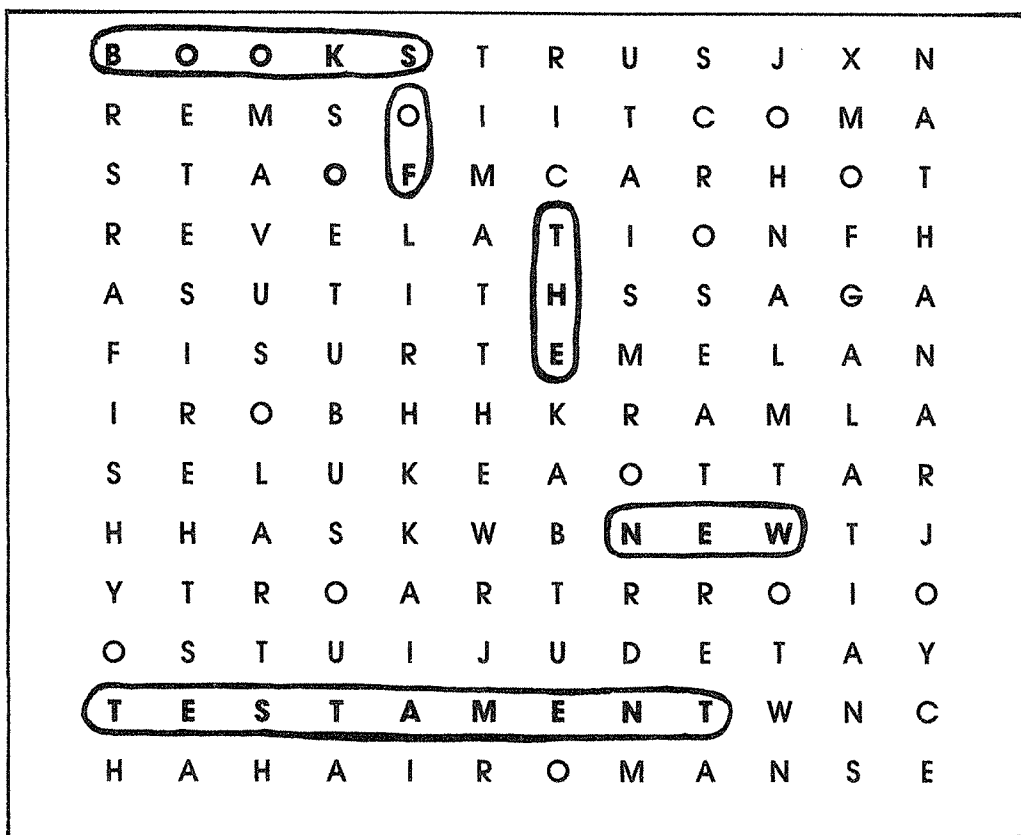

Acts  
Galatians  
Revelation  
Titus

John  
Matthew  
Luke  
Mark

Jude  
Hebrews  
James  
Romans

# Baptism



Copyright © Calvary Kids Pages. All rights reserved.



**Scriptures: Acts 9:1-31 and Acts 22:6-21**

**Key Verse: Acts 9:15** But the Lord said to him “Go, for he is a chosen vessel of Mine to bear My name before the Gentiles, kings, and the children of Israel.”

### **Key Points:**

1. Saul was persecuting the Christians, asking the high priest to be able to throw them into jail in Jerusalem. As he journeyed to Damascus, a bright light shone down on him. He heard a voice, “Saul, why are you persecuting me?” Saul asked who it was talking to him and the voice said it was the Lord whom he was persecuting. He then asked what the Lord wanted him to do. The Lord told him to get up, go into the city and he would receive instructions. Saul arose from the ground and when he got up he was blind. Those who had journeyed with him saw no one but took him by the hand into Damascus.

2. Saul was without sight for 3 days. He neither ate nor drank. A disciple named Ananias had a vision from the Lord. He was told to go to Saul and put his hand on him so that he would regain his sight. Saul was at the home of Judas, on a street called Straight. Ananias was afraid to go there because he had heard how Saul persecuted the Christians. The Lord told him to go anyway, that Saul was his chosen vessel to do his work. So he went to Saul, as he laid hands on him, something like scales fell from his eyes.

3. After Saul received his sight, he immediately got up and was baptized. He ate, was strengthened and spent his days with the disciples in Damascus. He preached about Christ in the synagogues. All who heard were amazed that this could be the same man who had been persecuting the Christians. But Saul worked even harder preaching that Jesus was the Christ.

4. The Jews heard of this and conspired to kill Saul. The disciples took Saul and let him down in a large basket through the wall so he could escape the city. He went to Jerusalem, but they were all afraid of him and did not believe he was a disciple. But, Barnabas brought him to the disciples and told them Saul’s story of how he had spoken to the Lord on the road to Damascus. So he stayed there preaching but there were still threats on his life so he was sent on to Tarsus.

## 252. SAUL IS CONVERTED

(ACTS 8:1-4, 9:1-22)



"And as he journeyed, he came near Damascus: and suddenly there shined round about him a light from heaven: And he fell to the earth, and heard a voice saying unto him, Saul, Saul, why persecutest thou me?"

**ACTS 9:3-4**

# 252. SAUL IS CONVERTED

(ACTS 8:1-4; 9:1-22)

J V E S S E L O R D G S D L A  
 C E E T T E M U Z C A U G P P  
 L T S P Z S L M P B B F N O L  
 P E I U E E E A J U R F I L E  
 P Y Y R S R D I C S B E R T C  
 R A Q A I D S A R S N R A L I  
 A Q D P W P N E M P Y Q E U O  
 Y A U E R E S E C A H P H A V  
 I O T K Z E H Y H U S G R S S  
 N Y V N A I A T L Y T C I P A  
 G E S B B K T C D O N I U H I  
 A D E Z A M A P H J H L N S N  
 B L I N D G Q S A E M J M G A  
 D I S C I P L E S B D D J N N  
 I A E Y U C R H E A V E N R A

AMAZED  
 ANANIAS  
 BAPTIZED  
 BLIND  
 DAMASCUS  
 DISCIPLES

HEARING  
 HEAVEN  
 HIGH PRIEST  
 HOLY SPIRIT  
 JESUS

LORD  
 PERSECUTING  
 PRAYING  
 PREACHED  
 SAUL

SCALES  
 SUFFER  
 THE WAY  
 VESSEL  
 VOICE

**THE ROAD BEGINS HERE**

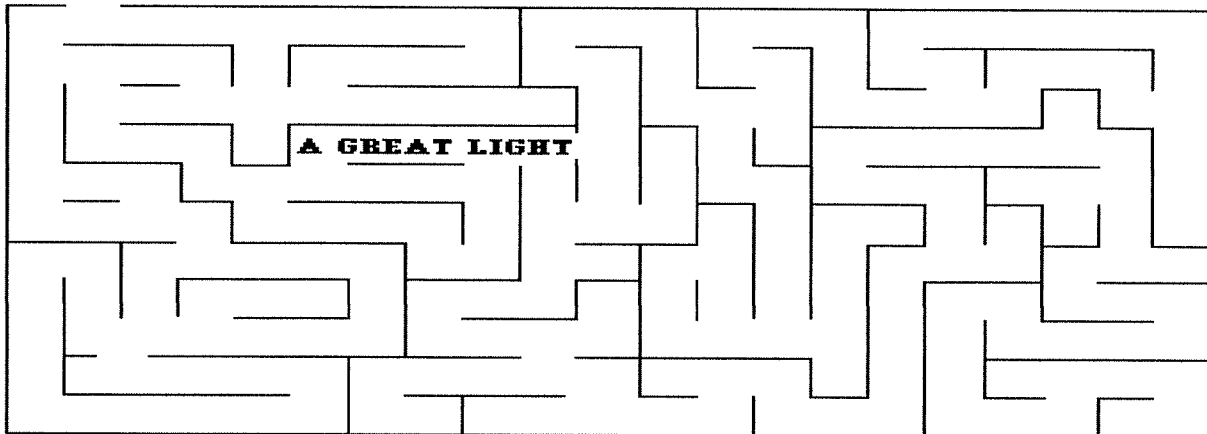

**DAMASCUS**

## 252. SAUL IS CONVERTED

(ACTS 8:1-4, 9:1-22)

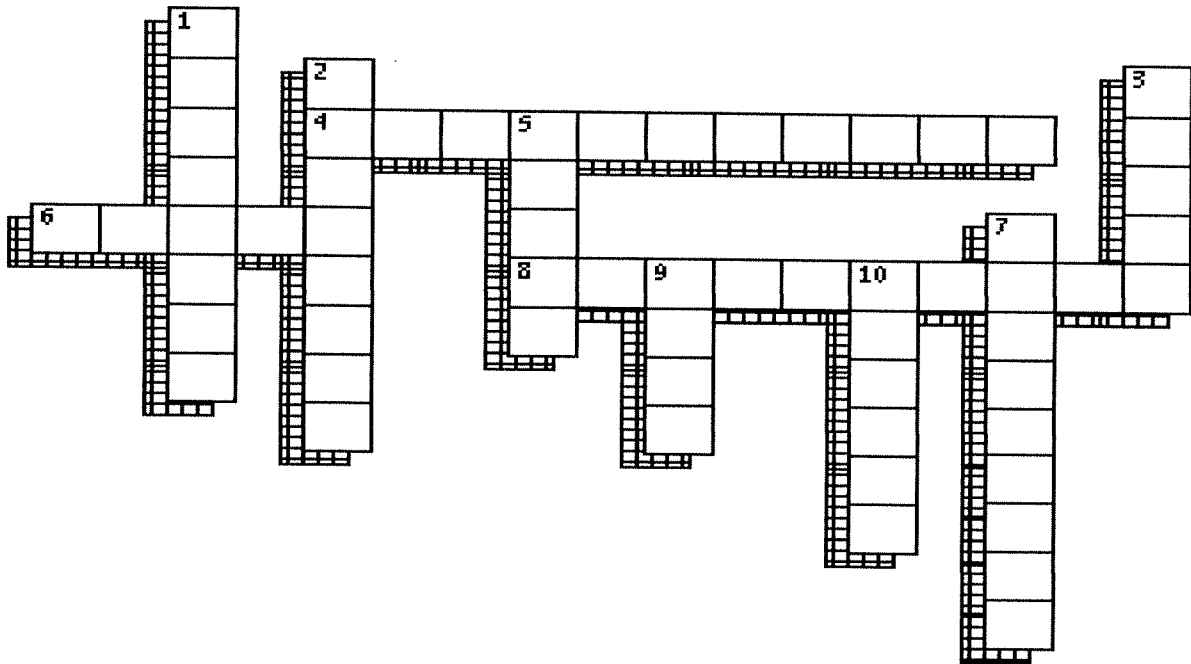

- 2 DOWN "...At that time a great persecution arose against the church which was at Jerusalem; and they were all scattered throughout the regions of Judea and Samaria, except the \_\_\_\_\_." **ACTS 8:1**
- 10 DOWN "As for Saul, he made havoc of the church, entering every house, and dragging off men and women, committing them to \_\_\_\_\_." **ACTS 8:3**
- 7 DOWN "Therefore those who were scattered went everywhere \_\_\_\_\_ the word." **ACTS 8:4**
- 3 DOWN "And as he journeyed he came near Damascus, and suddenly a \_\_\_\_\_ shone around him from heaven." **ACTS 9:3**
- 4 ACROSS "Then he fell to the ground, and heard a voice saying to him, 'Saul, Saul, why are you \_\_\_\_\_ Me?' " **ACTS 9:4**
- 9 DOWN "So he, trembling and astonished, said, '\_\_\_\_\_, what do You want me to do?' And the Lord said to him, 'Arise and go into the city, and you will be told what you must do.'" **ACTS 9:6**
- 1 DOWN "Then Saul arose from the ground, and when his eyes were opened he saw no one. But they led him by the hand and brought him into \_\_\_\_\_." **ACTS 9:8**
- 5 DOWN "And he was three days without \_\_\_\_\_, and neither ate nor drank." **ACTS 9:9**
- 8 ACROSS "And Ananias went his way and entered the house; and laying his hands on him he said, 'Brother Saul, the Lord Jesus, who appeared to you on the road as you came, has sent me that you may receive your sight and be filled with the \_\_\_\_\_ \_\_\_\_\_.'" **ACTS 9:17**
- 6 ACROSS "But Saul increased all the more in strength, and confounded the Jews who dwelt in Damascus, proving that this \_\_\_\_\_ is the Christ." **ACTS 9:22**

# 252. SAUL IS CONVERTED

## (ACTS 8:1-4, 9:1-22)

### MEMORY VERSE:

*"But Saul increased all the more in strength, and confounded the Jews who dwelt in Damascus, proving that this Jesus is the Christ." ACTS 9:22*

### FILL IN THE BLANK:

1. "...At that time a great persecution arose against the church which was at Jerusalem; and they were all scattered throughout the regions of Judea and Samaria, except the \_\_\_\_\_." ACTS 8:1

### TRUE OR FALSE:

2. "As for Saul, he made havoc of the church, entering every house, and dragging off men and women, committing them to prison." ACTS 8:3

TRUE OR FALSE

3. Therefore those who were scattered went everywhere hiding. ACTS 8:4

TRUE OR FALSE

### FILL IN THE BLANKS:

4. "And as he journeyed he came near Damascus, and suddenly a \_\_\_\_\_ shone around him from heaven." ACTS 9:3

5. "Then he fell to the ground, and heard a voice saying to him, 'Saul, Saul, why are you \_\_\_\_\_ Me?' " ACTS 9:4

### TRUE OR FALSE:

6. "So he, trembling and astonished, said, 'Lord, what do You want me to do?' And the Lord said to him, 'Arise and go into the city, and you will be told what you must do.' " ACTS 9:6

TRUE OR FALSE

### FILL IN THE BLANK:

7. "Then Saul arose from the ground, and when his eyes were opened he saw no one. But they led him by the hand and brought him into Damascus. And he was three days \_\_\_\_\_ sight, and neither ate nor drank." ACTS 9:8-9

### TRUE OR FALSE:

8. "And Ananias went his way and entered the house; and laying his hands on him he said, 'Brother Saul, the Lord Jesus, who appeared to you on the road as you came, has sent me that you may receive your sight and be filled with the Holy Spirit.' " ACTS 9:17

TRUE OR FALSE

9. "But Saul increased all the more in strength, and confounded the Jews who dwelt in Damascus, proving that this Jesus is the Christ." ACTS 9:22

TRUE OR FALSE

# BibleWise

## Discussion Questions – Saul's Conversion

Read Acts 9:1-22

- Who consented to Stephen's death?
- Where was Saul going and what was he going to do?
- What happened as he traveled?
- Who talked with Saul?
- Why was Saul blinded?
- Which disciple was told to go and heal Saul?
- Why didn't he want to see Saul?
- Would you have trusted God and visited Saul, a killer of those who followed Jesus?
- How did Ananias greet Saul?
- What did Saul do after his healing?
- Why was Saul so important to the Christian church?
- What name is he best known by?



**Paul Learns  
About Jesus**

—Acts 9, 22

# Saul Hears About Jesus

Saul (who later became known as Paul) was traveling to Damascus to arrest followers of Jesus. As he came near the city, a bright light from Heaven flashed around him. Saul heard someone speak to him. Then Saul said, "Who are you?"

To find out what the voice said, read the first column below. To find out who was speaking, cross out all the letters in the second column that are used in the words in the first column. For example, if there is one "a" in the first column, cross out one "a" in the second column.

When you are finished, copy the letters left onto the lines below.

"Saul,  
Saul,  
why do  
you  
persecute me?"

S l a u a l m  
J S e a s u u s l  
w h w y h o d m y o o u  
y a o r u e  
p p e e r s r s e c e c u u t e t i n g e m

\_\_\_\_\_  
\_\_\_\_\_  
\_\_\_\_\_



# Saul's Conversion

Remember Paul was called Saul before his conversion. Saul was blinded by a light during his conversion. Use the braille chart to decode the missing words. (See Acts 9:1-19.)

⠠	⠠	⠠	⠠	⠠	⠠	⠠	⠠	⠠	⠠
A	B	C	D	E	G	H	I	L	N
⠠	⠠	⠠	⠠	⠠	⠠	⠠	⠠	⠠	⠠
O	P	R	S	T	U	V	W	Z	

Saul was a  of

Christians. He became a  when

Jesus came to him in a . The light

Saul. So, Jesus worked through

to restore Saul's ,

and to let Saul know that he, Saul, had been

to be a  for

Christ. Then Saul was .

Saul became a .





**Paul went to the Street called Straight in Damascus where his eyes were healed by a disciple called Ananias. Paul then began to preach the gospel.**

# Follow That Trail

## ACTS 9, 13 – PAUL'S CALL

Follow the trail to find out the answers to these facts about Saul's amazing conversion. (You can read the entire story about Saul's conversion in Acts 9:1-31.)

- |                                                                       |          |
|-----------------------------------------------------------------------|----------|
| 1. Number of days Saul was blind (9:9)                                | Barnabas |
| 2. Name of the man who helped Saul see again (9:10-11, 17-18)         | Straight |
| 3. Name of the street where the Lord sent Ananias (9:11)              | three    |
| 4. People to whom Saul was to "carry" the Lord's name (9:15)          | Paul     |
| 5. What Saul's followers used to help him escape from Damascus (9:25) | Tarsus   |
| 6. The man who helped Saul join the disciples in Jerusalem (9:26-27)  | Ananias  |
| 7. Place where the disciples next sent Saul (9:30).                   | Gentiles |
| 8. Saul's other name (13:9)                                           | basket   |

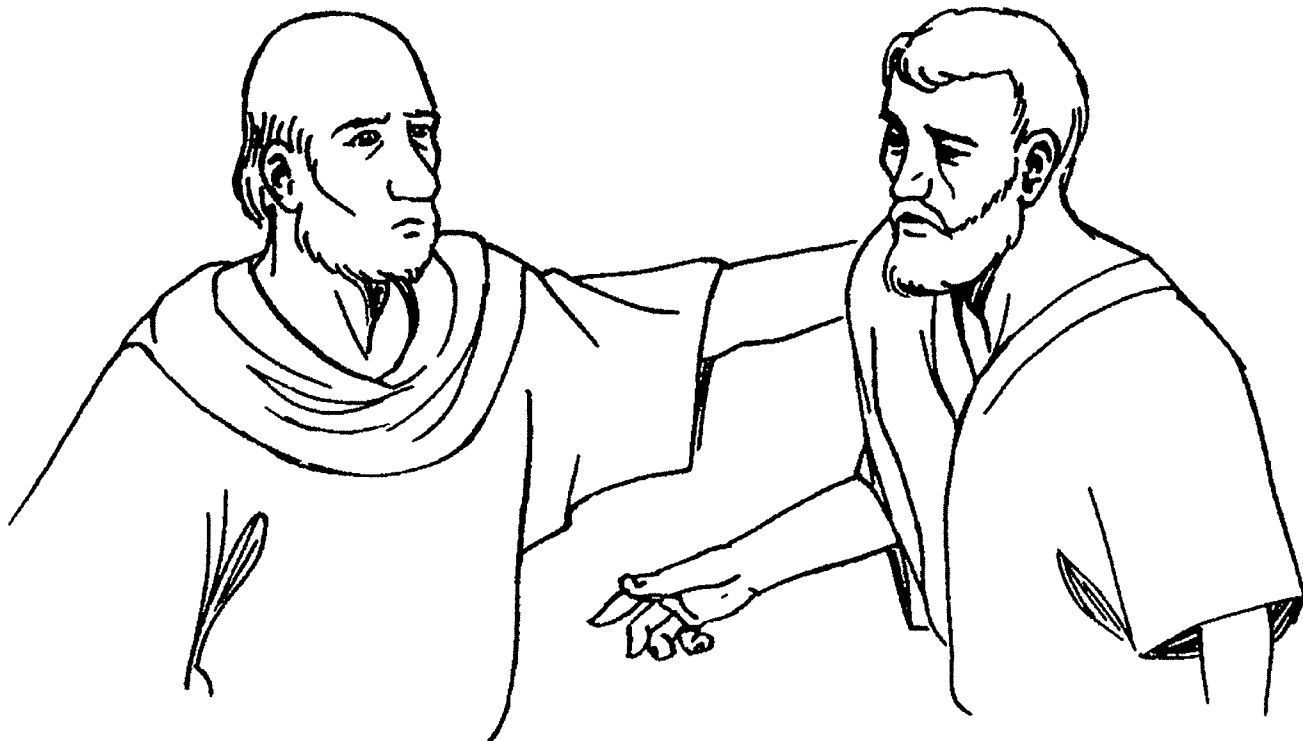

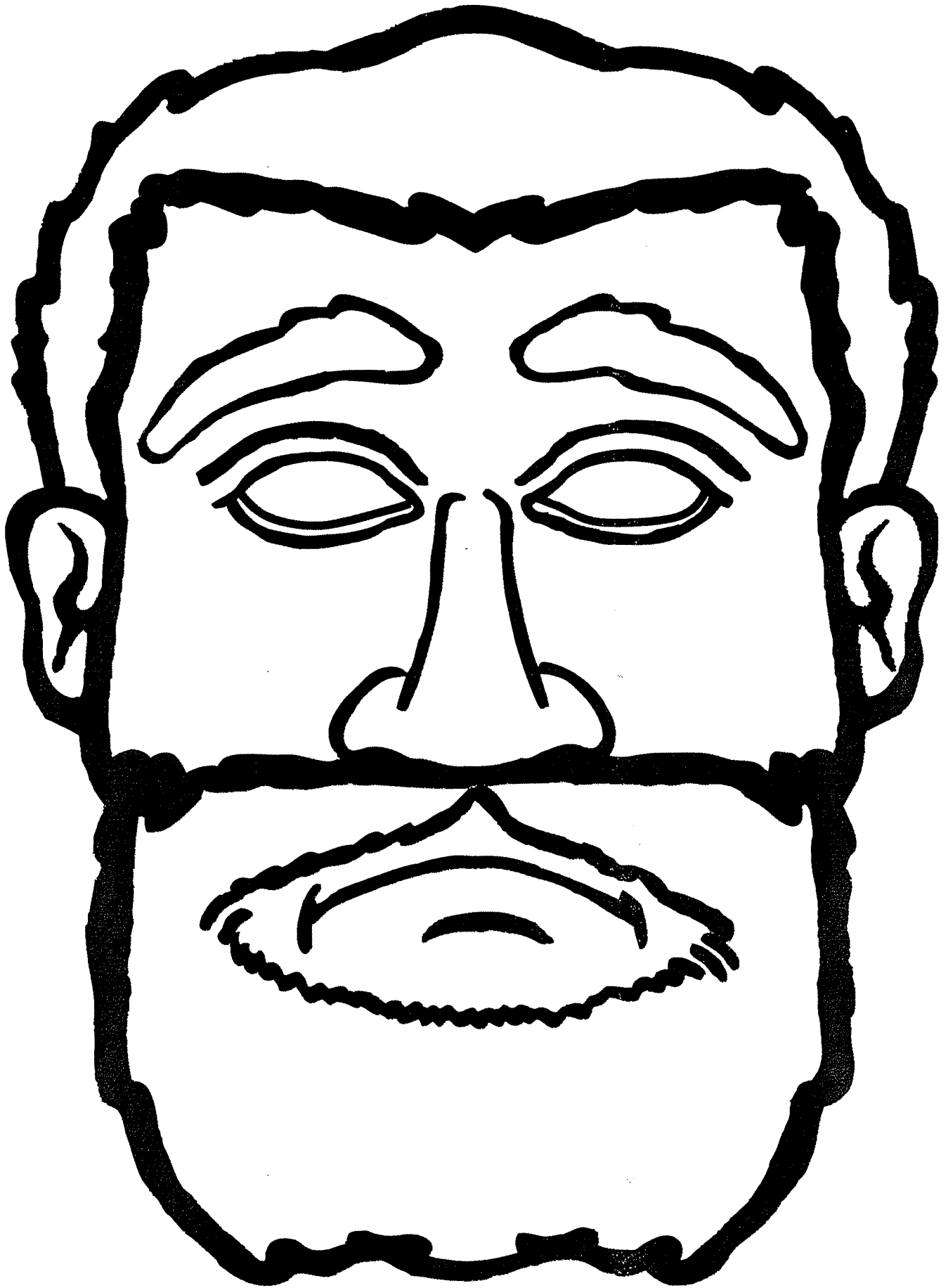

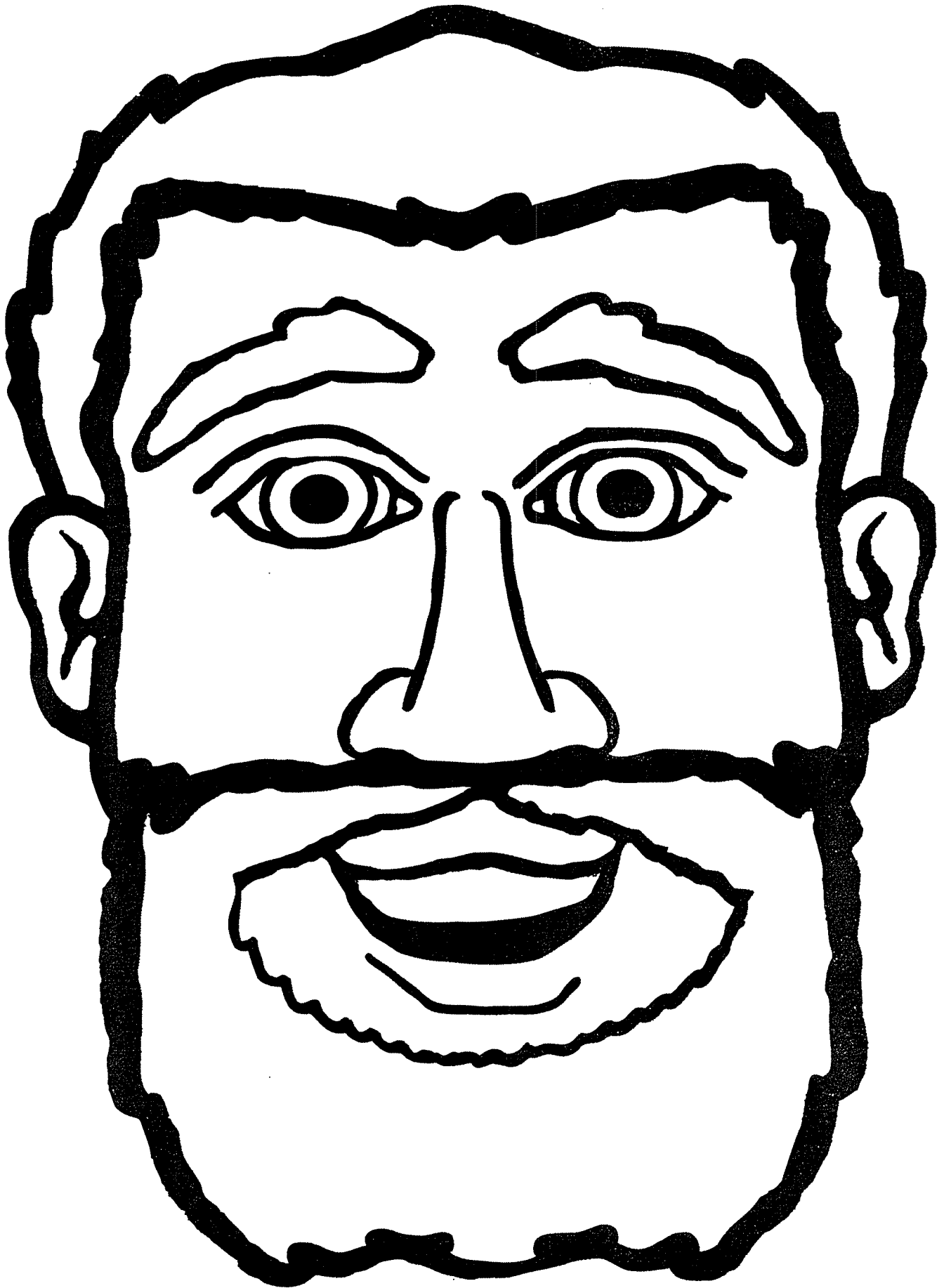

Glitter beam of  
light

Make a "blindfold" of  
scales that can be  
attached over his  
eyes and moved up &  
down.



Paul Begins to Tell About Jesus

Acts 9, 22

## **Year 3**

### **Week 150**

### **Peter Works for God**

**Scriptures: Acts 9:32-43 and Acts 10**

**Key Verse: Acts 10:34** Then Peter opened his mouth and said, “In truth I perceive that God shows no partiality.”

#### **Key Points:**

- 1.** There was a woman named Tabitha (Dorcas), full of good deeds and charity, in a town called Lydda which was close to Joppa. She became sick and died. They washed her and put her in an upper room. Disciples heard that Peter was near by so they sent for him, telling him not to delay. When Peter got there, many of the widows stood by her weeping, showing him all the garments that she had sewn for them. Peter sent them all out, then turned to her and knelt down to pray. He called out her name and she opened her eyes, then saw Peter and stood up. He presented Tabitha to her friends alive! It became known throughout Joppa and many believed.
- 2.** A man named Cornelius was a centurion, a devout man who prayed and feared God. He saw a vision of God coming to speak to him. God told Cornelius that he had heard his prayers. God told him to send men to Joppa and ask for Peter to come.
- 3.** Peter had gone up to the housetop to pray. He became very hungry and wanted to eat but fell into a trance. He saw heaven open and something like a great sheet bound on four corners come down from heaven. In it were all kinds of animals, beasts and birds. A voice told Peter to rise and eat. Peter refuses, saying they are unclean animals. However, God tells him that whatever He had cleansed was ok for him to eat. This happens three times before the sheet was taken up to heaven.
- 4.** While Peter wondered what the sheet meant, he was told that Cornelius waited for him, Cornelius fell down and worshiped him. Peter told him not to worship him for he was just a man. He told him that God had heard his prayers. Peter preached to Cornelius and those who had gathered. Peter witnessed the Holy Spirit coming upon Cornelius and the other Gentiles. He commanded them to be baptized in the name of the Lord. Peter realized his vision indicated that Jesus was to be preached to Gentiles as well.



Peter Raises Tabitha to Life

*Acts 9*



Name \_\_\_\_\_ Date \_\_\_\_\_

Lesson 57 - Peter and Dorcas  
Act 9:36-43

1. Dorcas, meaning "gazelle", was sometimes called \_\_\_\_\_.
2. She spent her time caring for the \_\_\_\_\_ in the town of \_\_\_\_\_.
3. When a woman's husband died, the land went to her \_\_\_\_\_.
4. Jewish farmers could not harvest the \_\_\_\_\_ of their fields, and they could not pick up \_\_\_\_\_ that dropped. It was left for the \_\_\_\_\_.
5. Every \_\_\_\_\_ year a tenth of the crop was given to the \_\_\_\_\_, and every \_\_\_\_\_ year debts were forgiven.
6. Why were her friends sad? \_\_\_\_\_.
7. Why did they send for Peter? \_\_\_\_\_  
\_\_\_\_\_.
8. When Peter went to the upper room the widows were \_\_\_\_\_ and showing the \_\_\_\_\_ Dorcas had made for them.
9. After he prayed he said, " \_\_\_\_\_, \_\_\_\_\_."
10. Dorcas was \_\_\_\_\_ again!
11. When people heard about the miracle, many \_\_\_\_\_ on the \_\_\_\_\_.

Word Box - Some words will be used more than once.

Lord	believed	widows	crying
seventh	oldest	edges	Tabitha
Joppa	grain	poor	third
get up	coats	son	alive

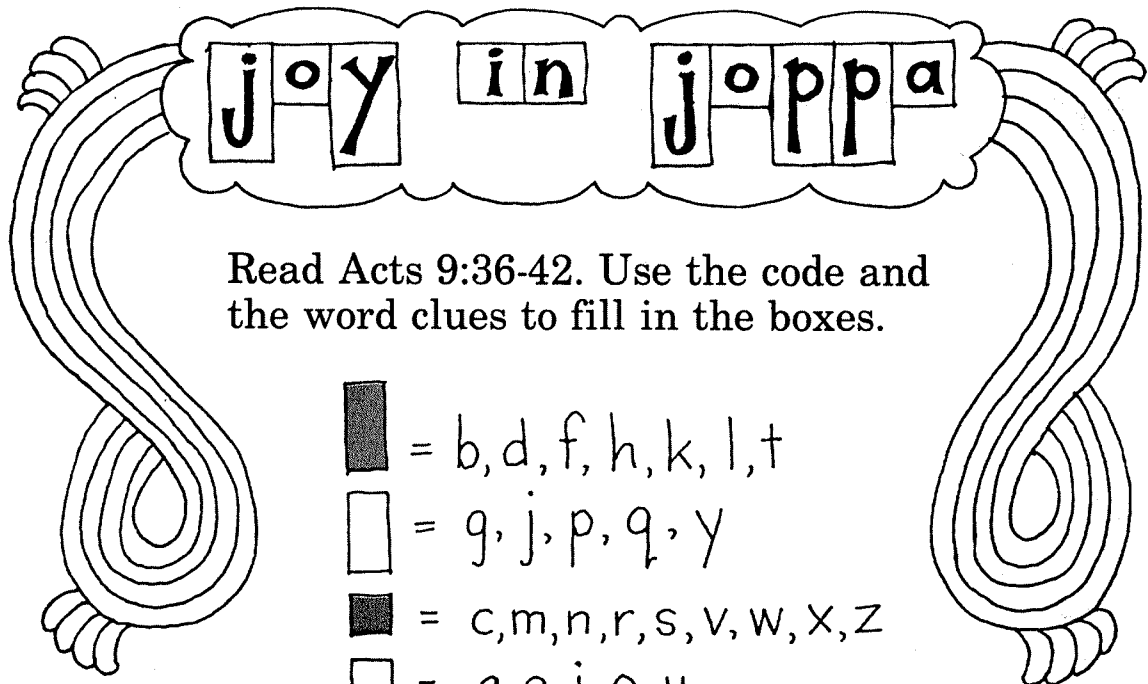

Read Acts 9:36-42. Use the code and the word clues to fill in the boxes.

- = b, d, f, h, k, l, t
- = g, j, p, q, y
- = c, m, n, r, s, v, w, x, z
- = a, e, i, o, u

1. a town ...
2. a woman .....
3. another name for #2 ...
4. a town..
5. an apostle .....
6. Jesus' followers...
7. two males..
8. women whose husbands .....  
have died
9. people who believed .....  
in Jesus
10. who believed .....

Read Acts 9:42. Use the code to learn the result of God's miracle in Joppa.

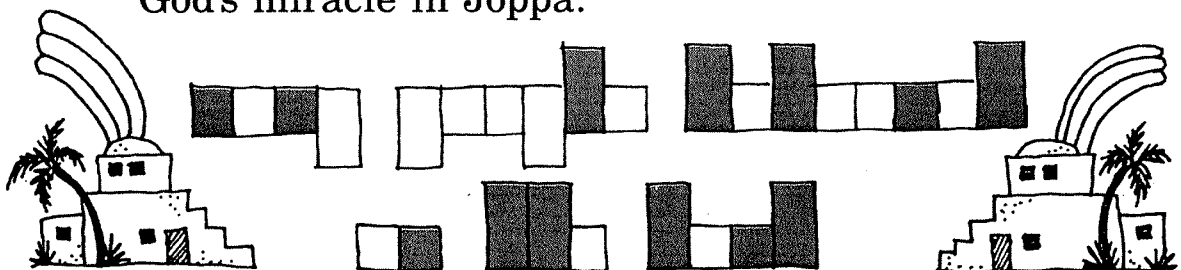

NURSERY -- YEAR 2, BOOK 1 -- LESSON 11 -- Ephesians 4:32  
**Dorcas Was Kind To Others -- Part 1**

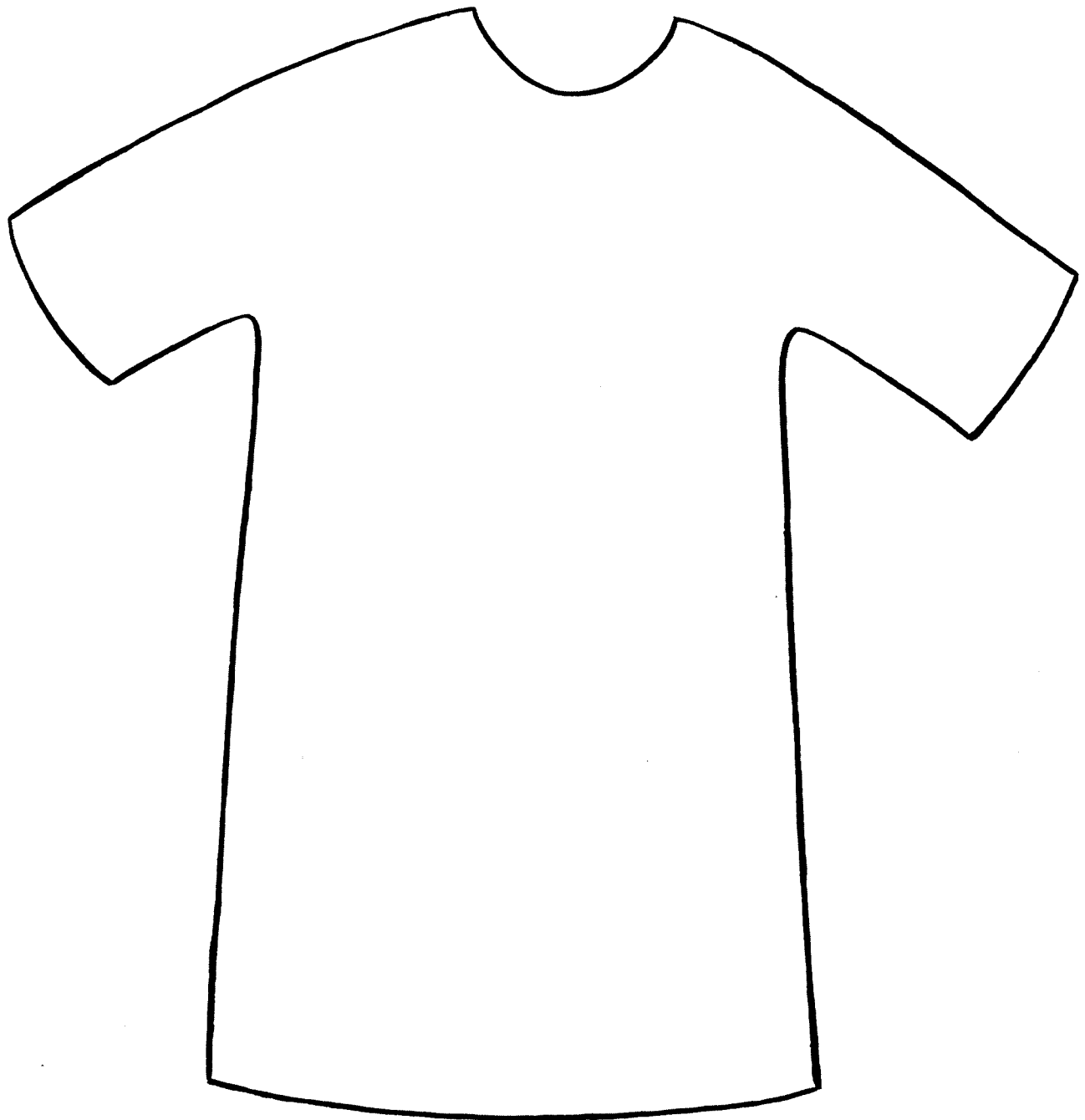

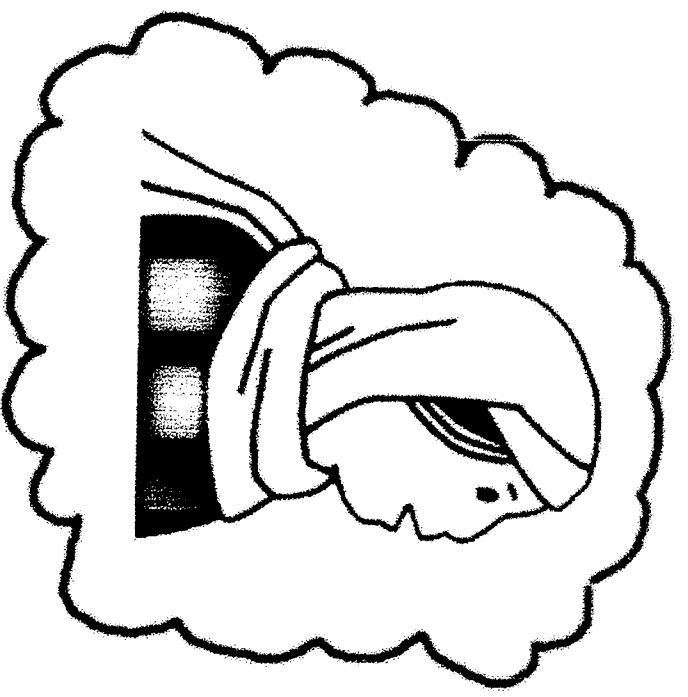
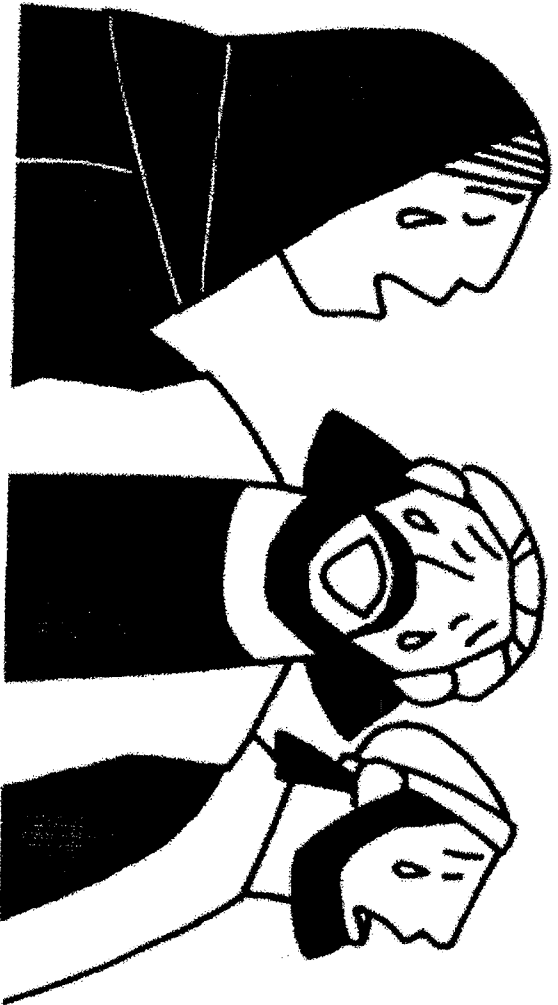

***From The Complete Bible Story Clip Art Book. ©Gospel Light. Used by permission.***

# Peter Prays for Dorcas

1. Who did Dorcas help?

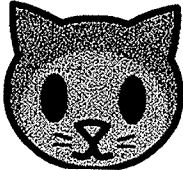
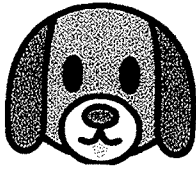

2. What did Dorcas do to help the widows?

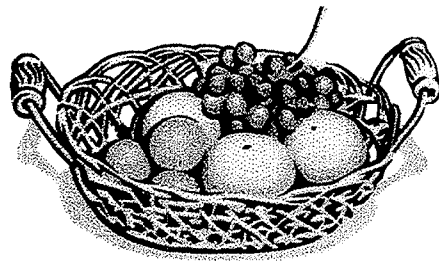
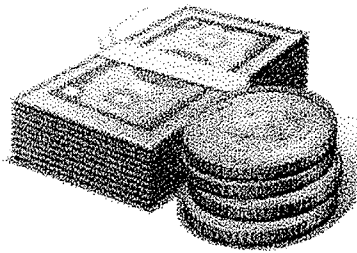

3. How did they feel when Dorcas died?

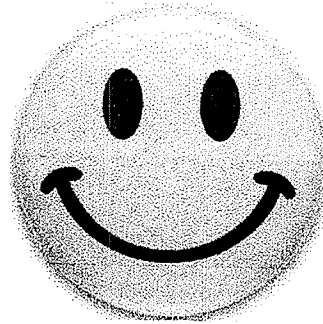
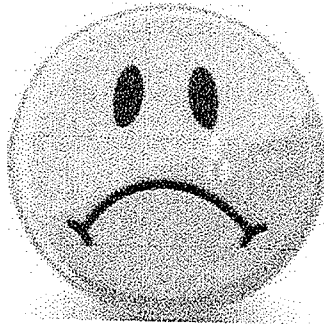
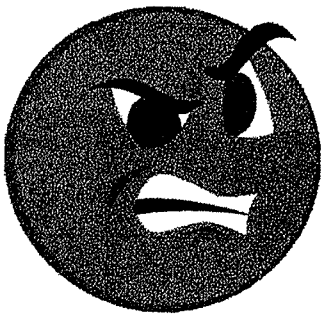

4. How did Peter talk to God about Dorcas?

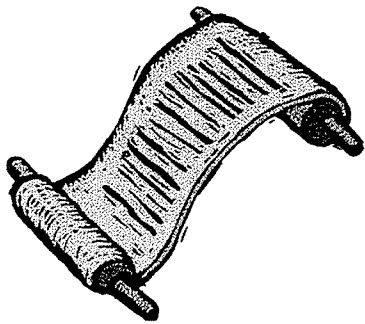

# 253. PETER RAISES TABITHA

## (ACTS 9:36-43)

### MEMORY VERSE:

*"Then he gave her his hand and lifted her up; and when he called the saints and widows, he presented her alive. And it became known throughout all Joppa, and many believed on the Lord." ACTS 9:41-42*

### UNDERLINE THE CORRECT ANSWER:

1. "At Joppa, there was a certain disciple named Tabitha, which is translated Dorcas. This woman was \_\_\_\_\_." ACTS 9:36
- very mean
  - full of good works and charitable deeds which she did

### TRUE OR FALSE:

2. "But it happened in those days that she became sick and died..." ACTS 9:37  
TRUE OR FALSE

### FILL IN THE BLANK:

3. "And since Lydda was near Joppa, and the disciples had heard that \_\_\_\_\_ was there, they sent two men to him, imploring him not to delay in coming to them." ACTS 9:38

### TRUE OR FALSE:

4. Then Peter arose but would not go with them... ACTS 9:39  
TRUE OR FALSE

### FILL IN THE BLANKS:

5. "...they brought him to the upper room. And all the widows stood by him weeping, showing the \_\_\_\_\_ and garments which Dorcas had made while she was with them." ACTS 9:39
6. "But Peter put them all out, and knelt down and \_\_\_\_\_..." ACTS 9:40
7. "...And turning to the body he said, 'Tabitha, arise.' And she \_\_\_\_\_ her eyes, and when she saw Peter she sat up." ACTS 9:40

### TRUE OR FALSE:

8. "And it became known throughout all Joppa, and many believed on the Lord." ACTS 9:42  
TRUE OR FALSE

# 253. PETER RAISES TABITHA

(ACTS 9:36-43)

U	L	I	D	E	E	D	S	S	I	C	K	B	H	V
V	D	F	E	A	N	T	A	B	I	T	H	A	J	B
C	O	J	R	N	Y	F	E	V	I	L	A	B	B	B
G	H	I	P	J	M	O	O	R	R	E	P	P	U	G
O	S	Q	G	E	G	A	R	M	E	N	T	S	Z	P
E	Y	S	B	E	L	I	E	V	E	D	M	D	W	E
Q	Q	K	G	P	W	B	T	J	A	A	S	I	W	I
A	K	R	L	E	C	T	A	F	O	T	H	E	V	A
E	G	O	Y	T	N	S	G	T	U	P	J	D	H	D
G	O	W	T	E	R	T	N	I	I	Z	P	N	W	D
A	J	D	P	R	G	O	O	D	O	R	C	A	S	Y
T	M	O	V	A	I	Y	M	Y	V	V	A	P	S	L
N	N	O	W	E	E	P	I	N	G	K	L	H	R	N
B	R	G	E	H	K	T	S	M	W	B	B	F	C	A
K	M	S	C	I	N	U	T	R	D	E	Y	A	R	P

ALIVE  
ARISE  
BELIEVED  
CHARITABLE  
DEEDS  
DIED  
DORCAS

GARMENTS  
GOOD WORKS  
JOPPA  
LYDDA  
PETER  
PRAYED

SICK  
SIMON  
TABITHA  
TUNICS  
UPPER ROOM  
WEEPING

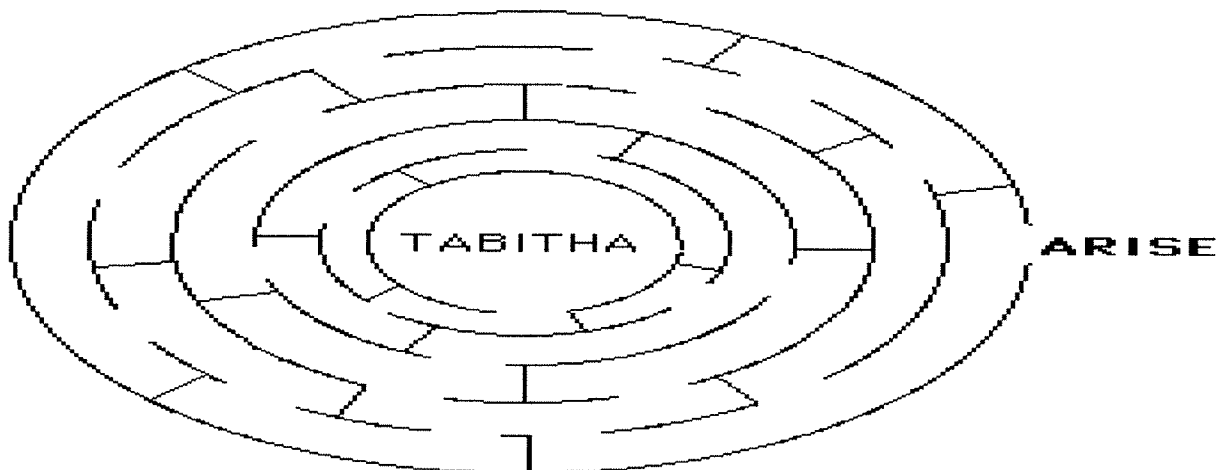

## Peter and Dorcas

Read the Bible story at <http://gardenofpraise.com/bibl57s.htm>

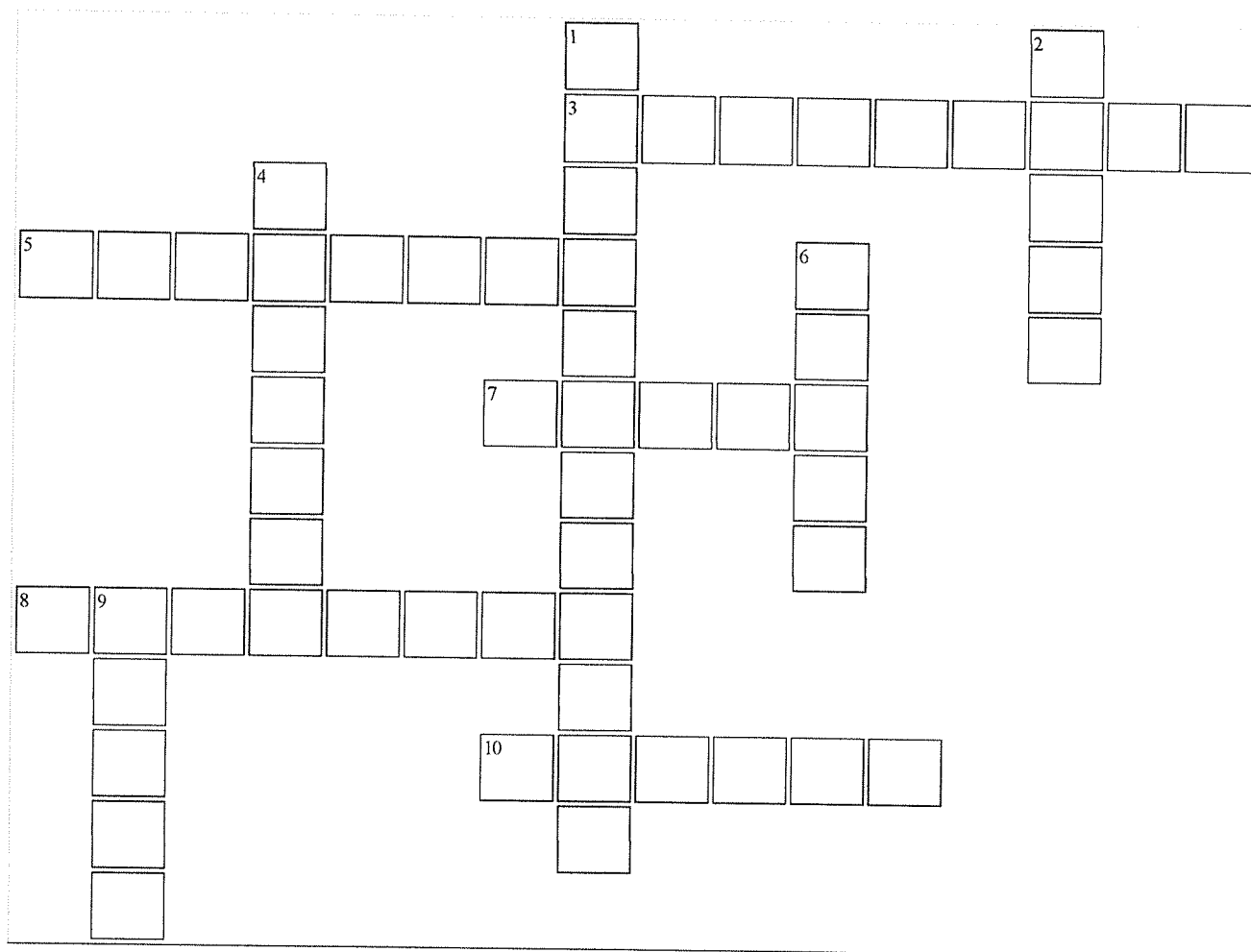

### Across

3. Peter found the body of Dorcas in an \_\_\_\_\_.
5. A widow could regain property if her husband's \_\_\_\_\_ married her.
7. Peter said to her, "Tabitha, \_\_\_\_\_".
8. picking up grain left in the field for the poor
10. how the people felt when Dorcas was alive again

### Down

1. To care for widows and orphans is called \_\_\_\_\_.
2. The widows showed Peter \_\_\_\_\_ Dorcas had made.
4. another name for Dorcas
6. the seaport town where Dorcas lived
9. where Peter was staying when he heard of Dorcas' death

WORD BANK: TABITHA, RELATIVE, GLEANING, PURE RELIGION,  
LYDDA, UPPER ROOM, GET UP, COATS, JOYFUL, JOPPA



## 253. PETER RAISES TABITHA (ACTS 9:36-43)

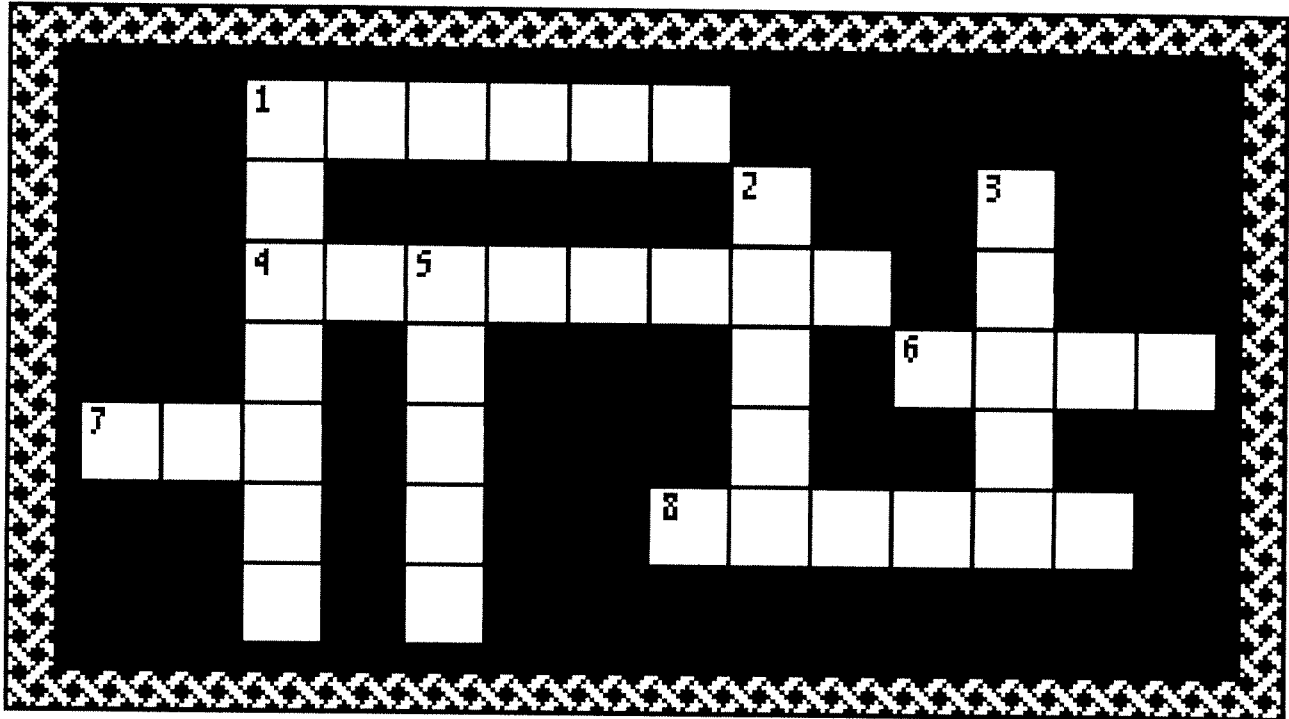

- 1 DOWN "At Joppa, there was a certain disciple named \_\_\_\_\_, which is translated Dorcas. This woman was full of good works and charitable deeds which she did." **ACTS 9:36**
- 6 ACROSS "But it happened in those days that she became sick and \_\_\_\_\_." **ACTS 9:37**
- 5 DOWN "And since \_\_\_\_\_ was near Joppa, and the disciples had heard that Peter was there, they sent two men to him, imploring him not to delay in coming to them." **ACTS 9:38**
- 2 DOWN "Then \_\_\_\_\_ arose and went with them..." **ACTS 9:39**
- 1 ACROSS "...they brought him to the upper room. And all the widows stood by him weeping, showing the \_\_\_\_\_ and garments which Dorcas had made while she was with them." **ACTS 9:39**
- 8 ACROSS "But Peter put them all out, and knelt down and \_\_\_\_\_." **ACTS 9:40**
- 7 ACROSS "...And turning to the body he said, 'Tabitha, arise.' And she opened her eyes, and when she saw Peter she \_\_\_\_\_ up." **ACTS 9:40**
- 3 DOWN "Then he gave her his hand and lifted her up; and when he called the saints and widows, he presented her \_\_\_\_\_." **ACTS 9:41**
- 4 ACROSS "And it became known throughout all Joppa, and many \_\_\_\_\_ on the Lord." **ACTS 9:42**



# Right or Wrong?



Read Acts 10:9-20, 24-28. Read the sentences. If the sentence is true, circle the word in the "right" column. If the sentence is false, circle the word in the "wrong" column. Then write the circled words in order at the bottom of the page to learn what God taught Peter.

- |                                                                              | <b>Right</b> | <b>Wrong</b> |
|------------------------------------------------------------------------------|--------------|--------------|
| 1. Peter went down in the basement to pray.                                  | Simon        | Peter        |
| 2. Peter fell into a trance and saw Heaven open.                             | learned      | taught       |
| 3. Peter saw a large sheet full of four-footed animals, reptiles, and birds. | not          | people       |
| 4. A voice told Peter to get up and look at the animals.                     | about        | to           |
| 5. After the vision, four men came looking for Peter.                        | names        | call         |
| 6. The men came from Simon the soldier.                                      | and          | any          |
| 7. Peter went with the men to Caesarea to meet Cornelius.                    | man          | sang         |
| 8. Cornelius saw Peter and bowed before him.                                 | sad          | impure       |
| 9. Peter talked with Cornelius and a large group of people in his house.     | or           | songs        |
| 10. It was against the Jewish law for Peter to visit a Gentile.              | unclean      | always       |



Name \_\_\_\_\_ Date \_\_\_\_\_

Lesson 58 - Peter's Vision  
Acts 10:1-23

1. Cornelius was a \_\_\_\_\_ soldier in charge of \_\_\_\_\_ men.
2. Name three things that show that Cornelius was a devout man who loved God. (Make sentences.)  
\_\_\_\_\_  
\_\_\_\_\_  
\_\_\_\_\_
3. Cornelius saw an \_\_\_\_\_ who told him to send someone to the city of \_\_\_\_\_ to get a man named \_\_\_\_\_ who was staying at the house of \_\_\_\_\_, the tanner.
4. Cornelius sent two \_\_\_\_\_ and one \_\_\_\_\_.
5. Peter was on the rooftop \_\_\_\_\_ when he saw a large \_\_\_\_\_ let down from heaven.
6. A voice told him to " \_\_\_\_\_ and \_\_\_\_\_."
7. How did Peter react to this message? \_\_\_\_\_  
\_\_\_\_\_
8. When the men arrived, Peter \_\_\_\_\_ them into the house to be his \_\_\_\_\_.
9. No longer would Peter consider the Gentiles to be " \_\_\_\_\_".

Word Box

100	praying	angel	Kill
invited	servants	Roman	guests
unclean	Peter	Simon	soldier
Joppa	1000	eat	sheet

## 255. PETER'S VISION (ACTS 10:9-16)



“And saw heaven opened, and a certain vessel descending unto him,  
as it had been a great sheet knit at the four corners, and let down to the earth:”

**ACTS 10:11**

# 255. PETER'S VISION

(ACTS 10:9-16)

B E A S T S D H Y P A K Q C K  
K C P V D J T E E H S E R V I  
G D L B N O C T Y K V E A T L  
W Q N E I O E C S Y E O D T L  
T N I Q A R I V O P T C Y S B  
D N D J A N A S I R P T L G W  
H E A V E N S N I J N A C H M  
C Y L C J I G E Q V M E Z Q V  
V F A A T T B M D I G N R Z Z  
S Y G R H M F E N P F B Y S Q  
B V R I P U L A U N C L E A N  
K Y N T H R E E T I M E S I R  
Y G A S L Z I S D R I B S T B  
S B F B A S L E E P K U V W U  
F F W W N H O U S E T O P V W

ANIMALS  
ASLEEP  
BEASTS  
BIRDS  
CLEANSED  
CORNERS

CREEPING THINGS  
EAT  
HEAVEN  
HOUSETOP  
KILL  
PETER

PRAY  
RISE  
SHEET  
THREE TIMES  
UNCLEAN  
VISION

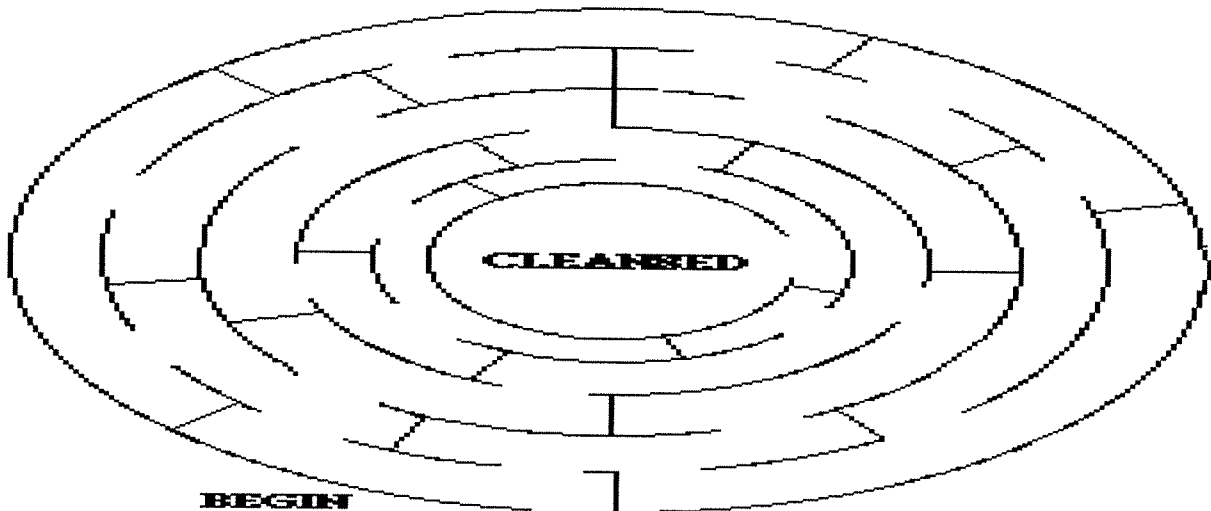

## 255. PETER'S VISION (ACTS 10:9-16)

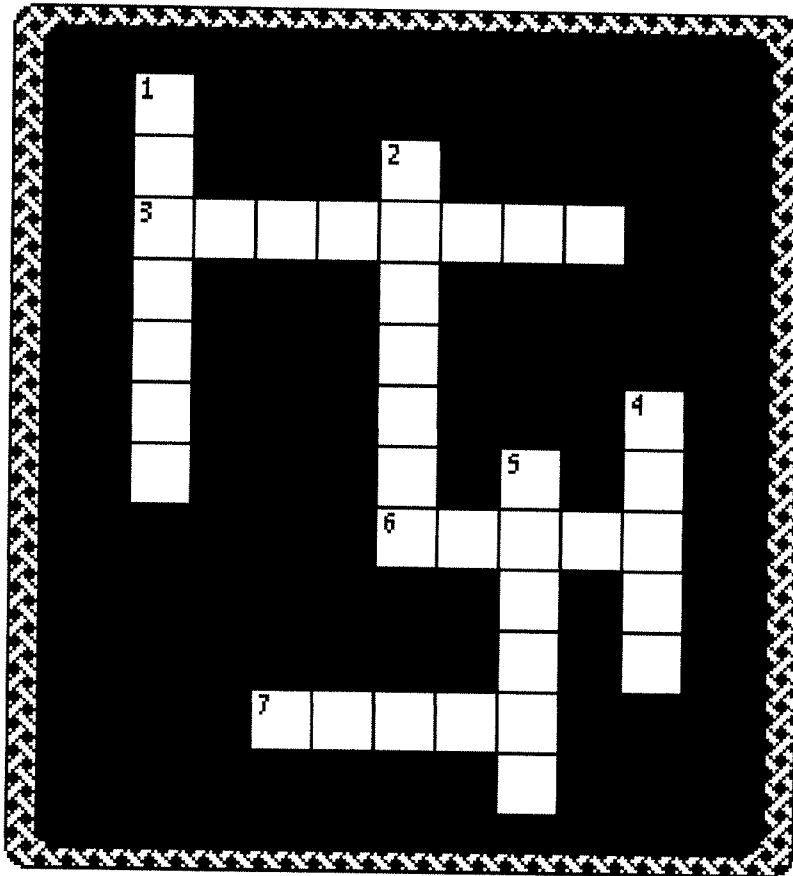

- 4 DOWN "The next day, as they went on their journey and drew near to the city, \_\_\_\_\_ went up on the housetop to pray, about the sixth hour." **ACTS 10:9**
- 6 ACROSS "Then he became very hungry and wanted to eat; but while they made ready, he fell into a trance and saw an object like a great \_\_\_\_\_ bound at the four corners, descending to him and let down to the earth." **ACTS 10:10-11**
- 2 DOWN "In it were all kinds of four-footed \_\_\_\_\_ of the earth, wild beasts, creeping things, and birds of the air." **ACTS 10:12**
- 1 DOWN "And a voice came to Peter saying, 'Rise, Peter; kill and eat.' But Peter said, 'Not so, Lord! For I have never eaten anything common or \_\_\_\_\_.'" **ACTS 10:13-14**
- 3 ACROSS "And a voice spoke to him again the second time, 'What God has \_\_\_\_\_ you must not call common.'" **ACTS 10:15**
- 7 ACROSS "This was done \_\_\_\_\_ times..." **ACTS 10:16**
- 5 DOWN "...And the object was taken up into \_\_\_\_\_ again." **ACTS 10:16**

# Peter Sees a Vision

Peter saw a vision one day. He saw a sheet coming down from Heaven. There were all kinds of animals in the sheet. A voice from Heaven said, "Rise, Peter, kill and eat." Peter said, "No. I've never eaten what was unclean." The voice said, "What God has cleansed, you must not call common." The sheet went back up into Heaven.

This happened 2 more times. Finally, Peter realized that God was telling Peter that all men, even Gentiles could be saved. That day, Peter was sent to teach Cornelius about Jesus. Cornelius and all his household were saved. The good news about Jesus was for everyone.

Acts 10



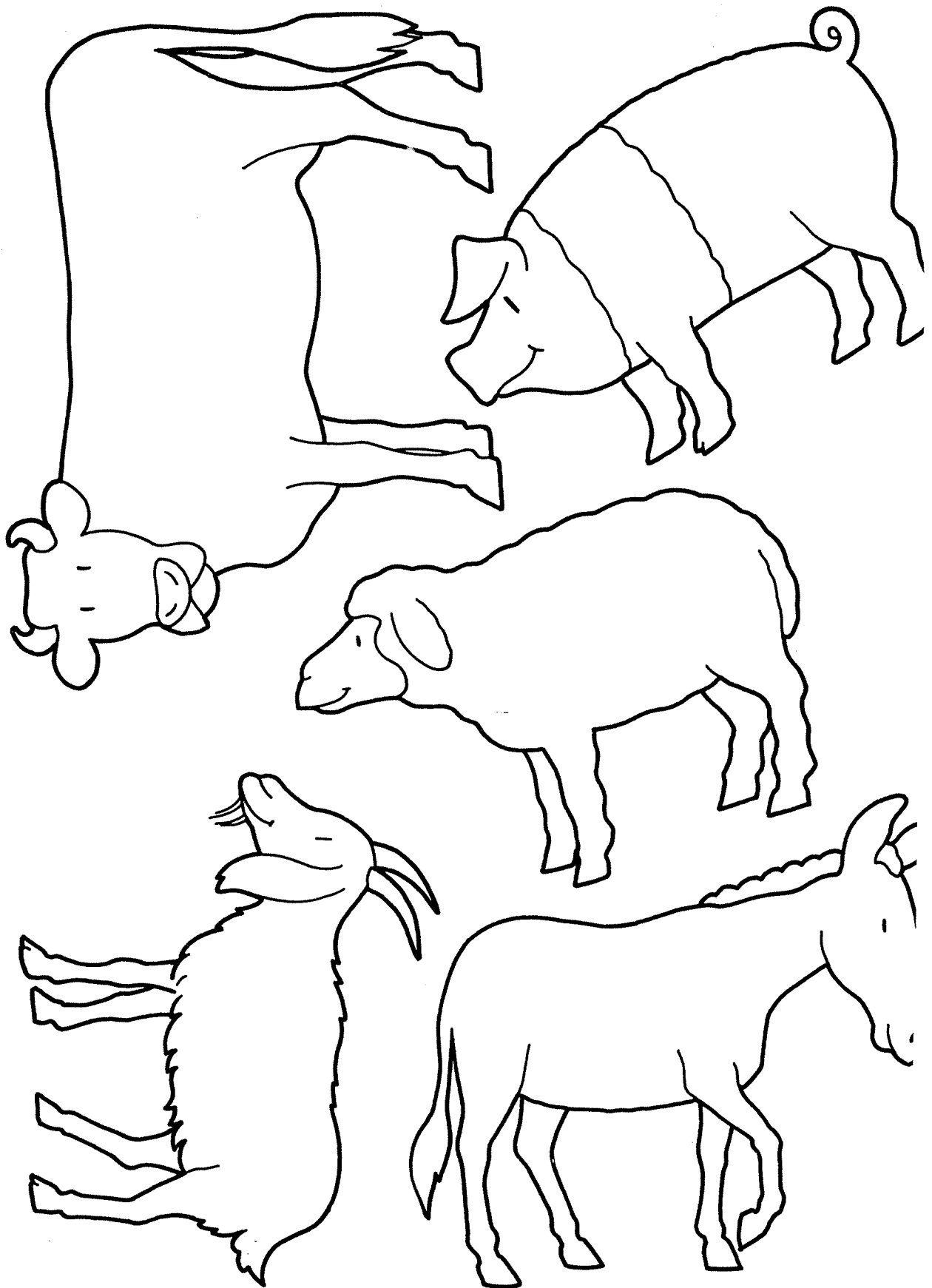



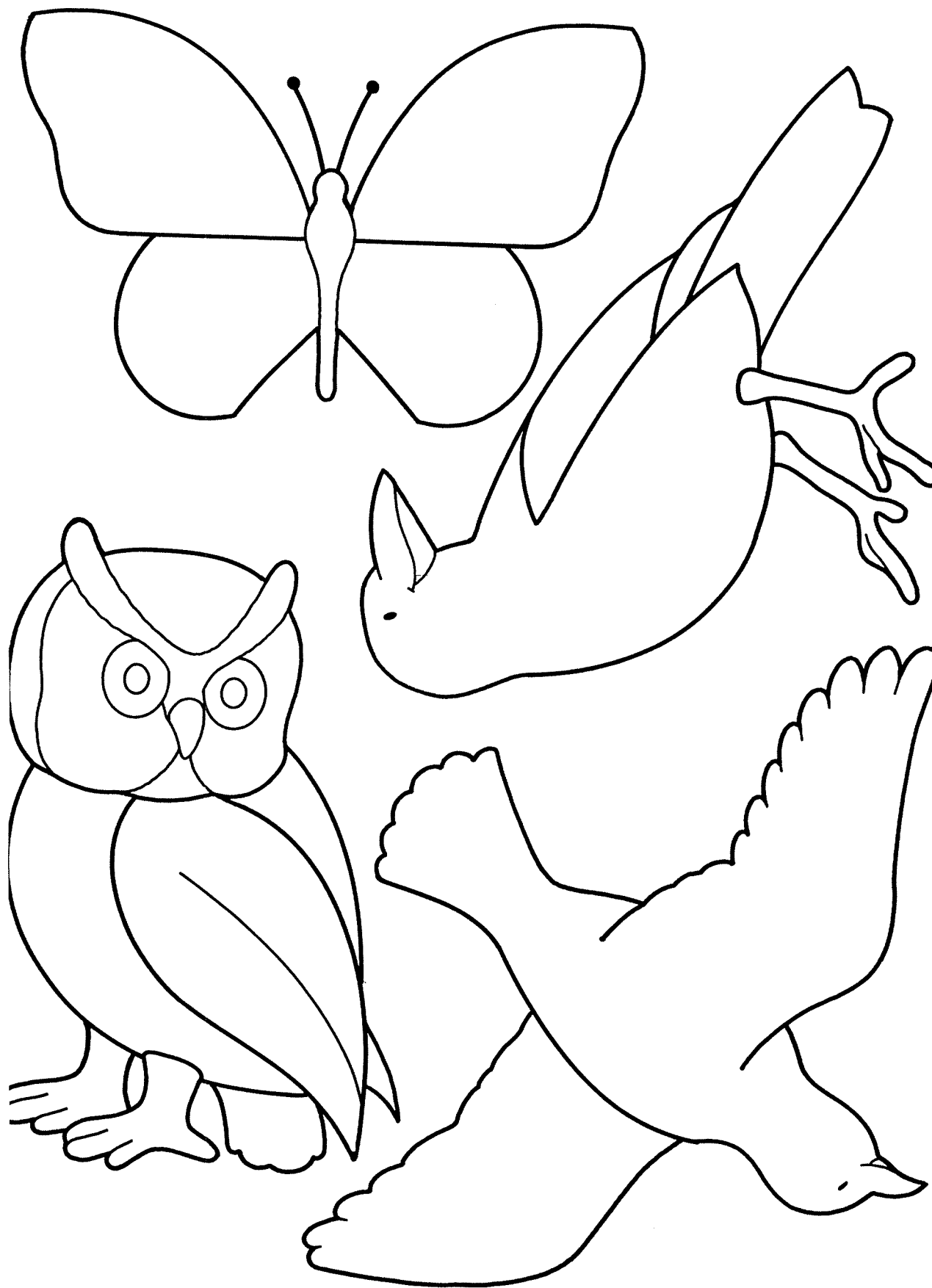

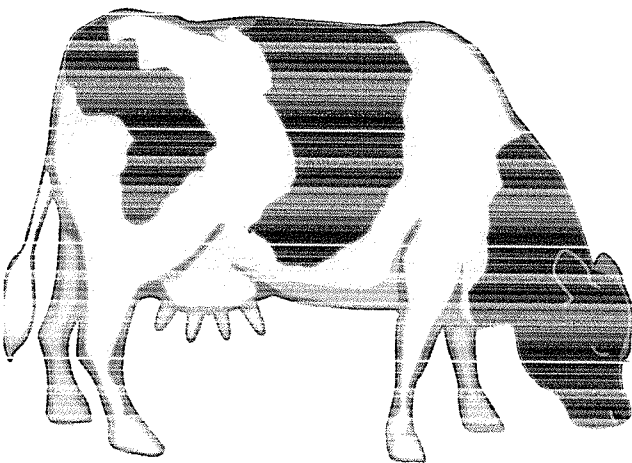
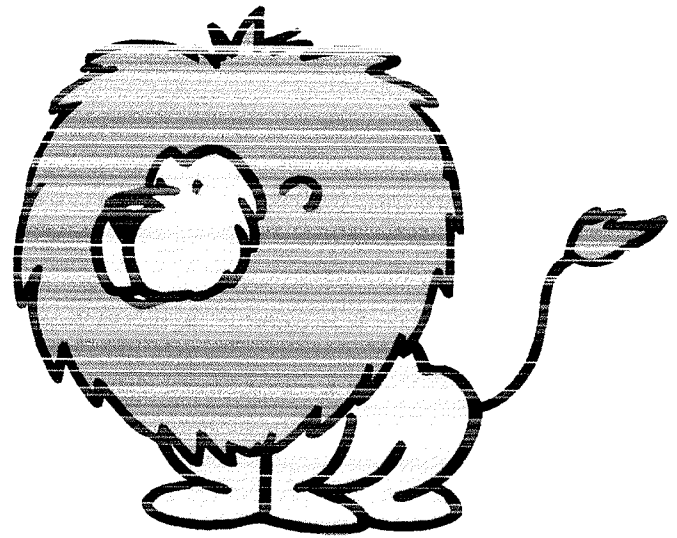
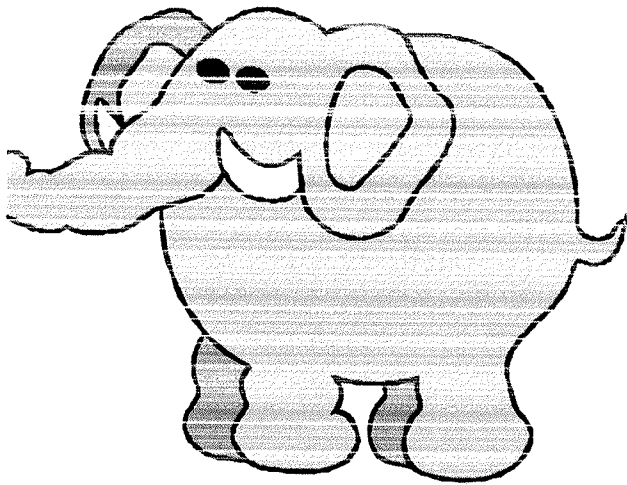
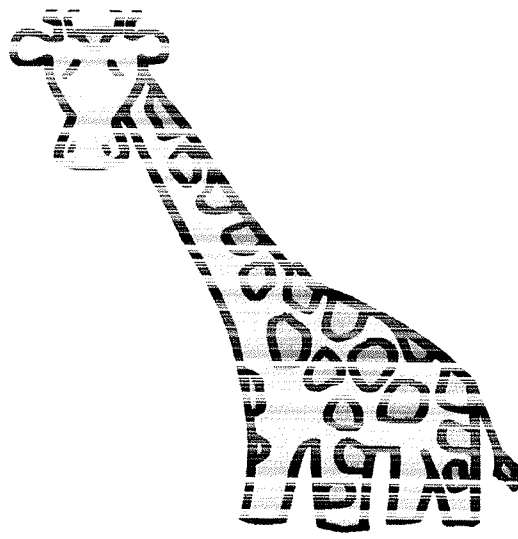
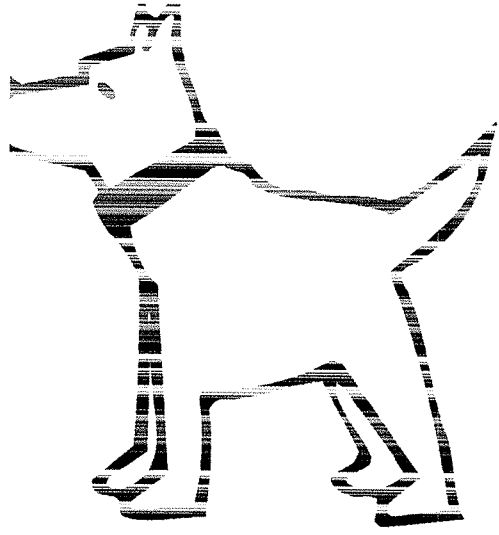

Copy 1 page for each child on cardstock and cutout. Cut around loosely so pieces are not so hard to cut out and take care of. Let each child put their animals in the "sheet" for Peter's vision.

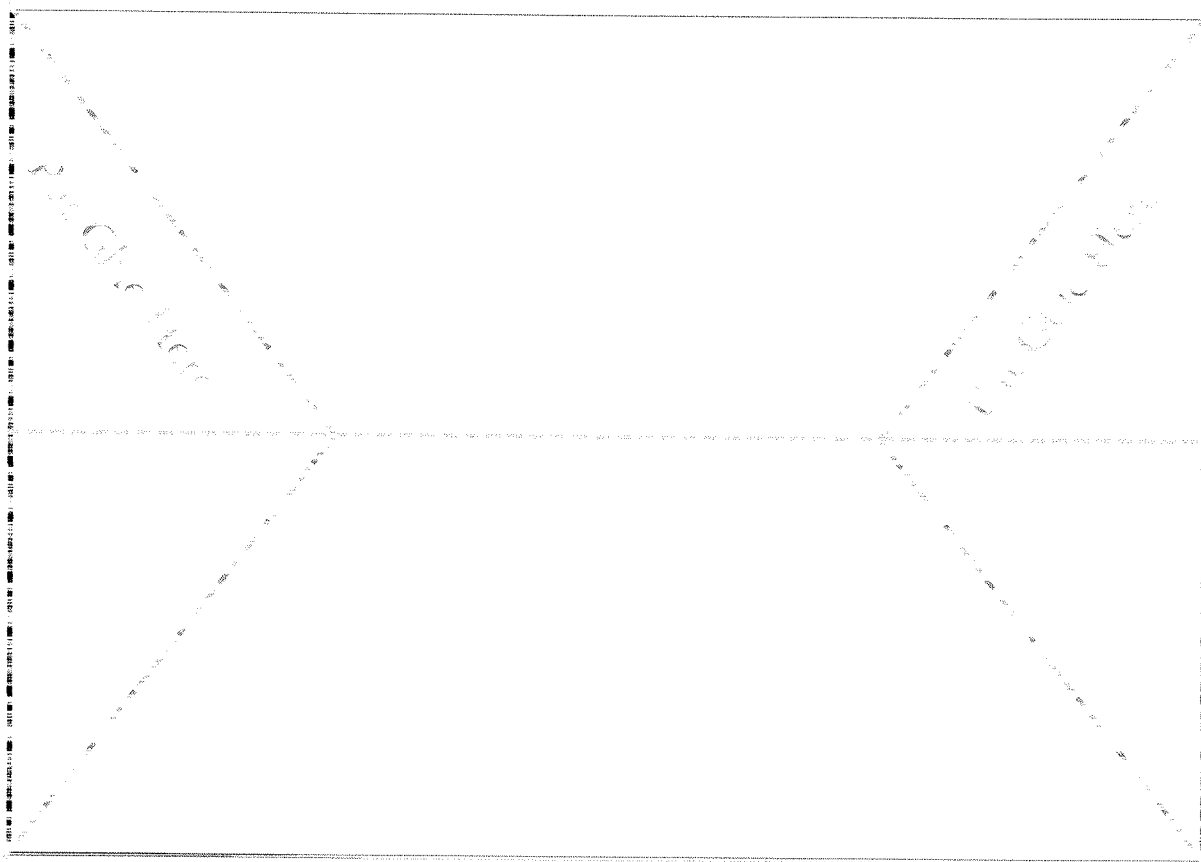

Now take the top of the cardstock. Cut the page from cardstock for  
trace range above and cut out.

Fold back with a top vertical line. Fold on diagonal lines to form  
triangles on ends. A open up rectangle. Push triangles to the inside.  
You'll now have a trapezoid (bet you never thought you'd use that  
word after you get out of school).

Glue side of triangle that says put glue here. Glue trapezoid again.  
This will make a pocket for the animals. Glue the pocket to the  
background page of Meter Bees a Vision. Place assorted animals  
inside.

**Year 3**

**Week 151**

**Paul and Barnabas Journey for Jesus  
(1<sup>st</sup> Journey)**

**Scriptures: Acts 13, 14:8-20 (also cover some background information on Barnabas: Acts 4:36, 9:27, 11:22-30, and 12:25)**

**Key Verse: As they ministered to the Lord and fasted, the Holy Spirit said, "Now separate to Me Barnabas and Saul for the work to which I have called them."**

**Key Points:**

1. At the church that was at Antioch, Paul and Barnabas were teaching. While they were fasting and ministering, the Holy Spirit spoke to them saying to separate themselves for the Lord's work. Having hands laid on them, they were sent out from Antioch to preach the Word of God, with John Mark as their assistant.
2. On the island of Paphos, a sorcerer named Elymas, was with the governor of the island, who came to hear Paul and Barnabas preach. Elymas resisted their words in an effort to turn the governor away from God. But Paul, filled with the Holy Spirit, confronts him for perverting the Word of the Lord. Elymas is then struck blind. The governor, seeing these things, was astonished and believed. John Mark left them after these things and returned to Jerusalem.
3. Paul and Barnabas went throughout the area, stirring people up with their preaching. Many believed, others were angry and threw them out of their region, even desiring to abuse and stone them.
4. In the city of Lystra, a man who had been crippled from birth came to hear Paul preach. Paul seeing he had faith to be healed, told him in a loud voice to stand straight up on his feet. The man jumped up, leaped and walked.
5. When the people saw this miracle, they thought Paul and Barnabas were gods, wanting to sacrifice to them. This was very distressing to them and Paul tried to make them understand that they were just regular men. The Jews in the area whipped up the multitudes against Paul and stoned him. They drug him out of the city, supposing him to be dead. When disciples gathered around him, he rose up and went into the city and left with Barnabas the next day.

# BibleWise

## Discussion Questions – Paul Heals a Lame Man

Read Acts 14:6-18

- How do we know that Paul is a follower of Christ Jesus?
- How do we know that Paul is a follower of Christ Jesus?
- What was Paul doing before he noticed the lame man?
- How did Paul know the lame man had faith to be healed?
- What was the lame man's reaction?
- How would you have reacted if you saw that happen?
- Why do you think the people thought they were Jupiter and Mercury?
- How would you react if people thought you were a god?
- Why did the people from Iconium spread lies about Paul and Barnabas?
- What kind of lies could they have told that would make the people change from thinking they were gods who could heal to wanting to kill Paul?
- How do lies turn people against each other?
- How do we stop lies?

# Amazing Paul and Barnabas

Paul took four missionary journeys. On the first journey listed in Acts 13:1-14:28 he traveled to all the cities listed in the maze below. Using the information in Acts find each city in the maze in the order that Paul and Barnabas visited them. You may not cross or retrace the path. Have fun following the first missionary journey.

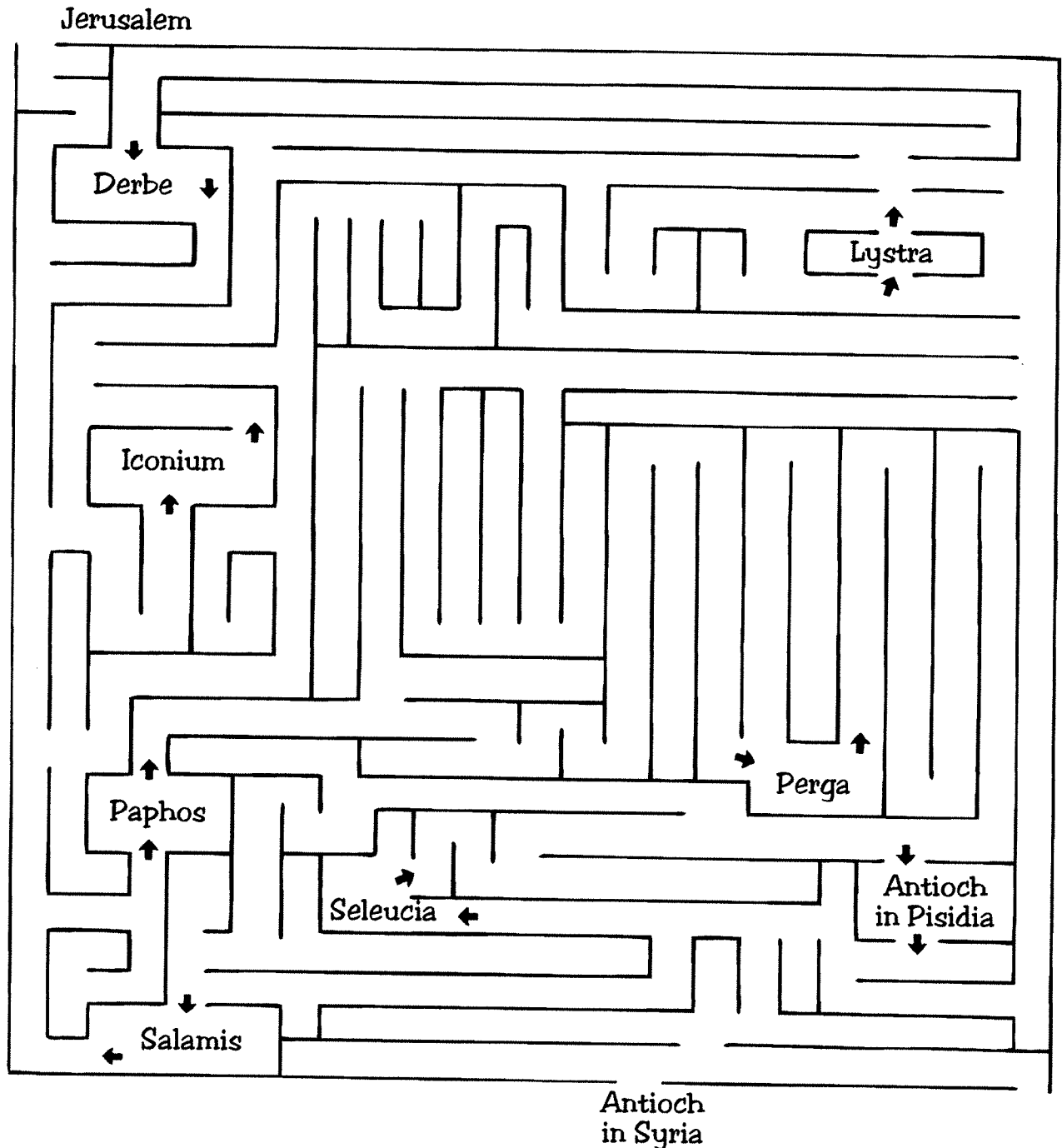

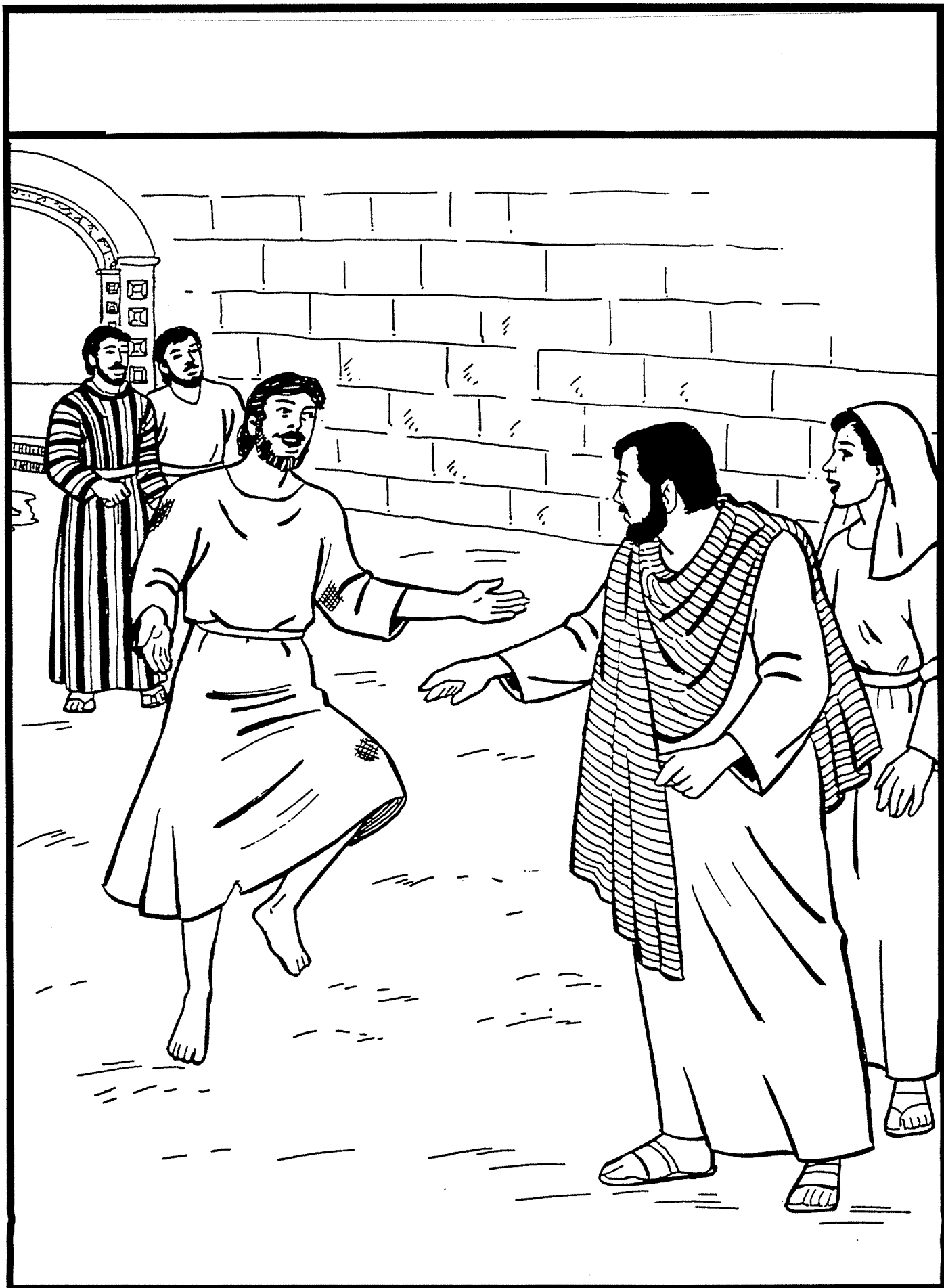

# Paul and Barnabas

Read Acts 14:8-20. Go through the maze and put the letters from the path on the line provided. Then use the code to find out what Paul and Barnabas told the people.

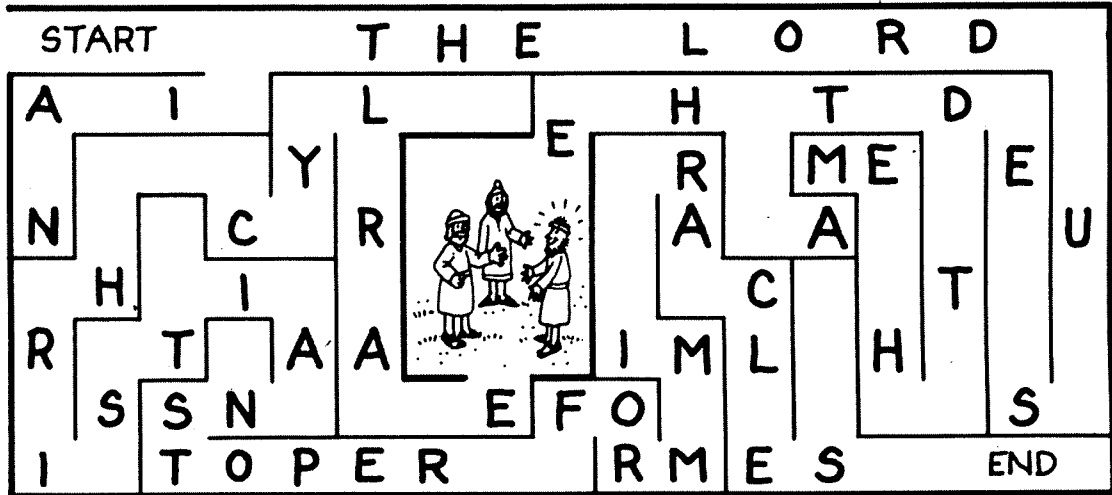

J U J O C T N T > < J U L C T N T V <  
 A B D E F G H I L M N O R S T U V W Y  
 V O J O U T N T N T < U N  
 T U U C J O V C , T O > > T N  
 < U N T U T N L C U <  
 T N O C U U V U T N > O C C  
 T N T N C T N T N T N  
 > T T T N T N T N



# Find it on the MAP

From the list below, put the cities in order and then draw the route to each city on the map.

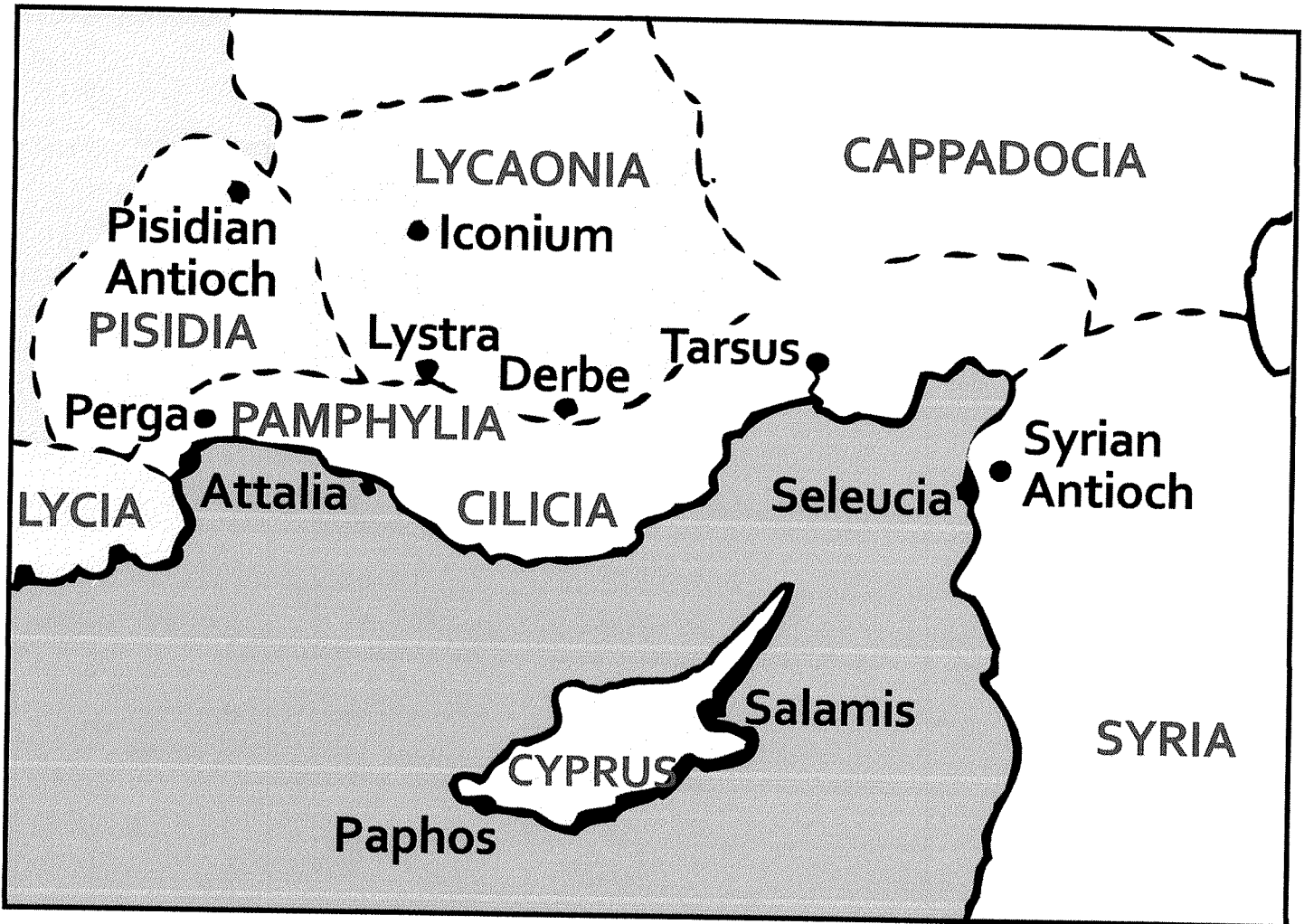

Syrian Antioch

1. \_\_\_\_\_

Pisidian Antioch

2. \_\_\_\_\_

Derbe

3. \_\_\_\_\_

Tarsus

4. \_\_\_\_\_

Seleucia

5. \_\_\_\_\_

Iconium

6. \_\_\_\_\_

Lystra

7. \_\_\_\_\_

## Find the Cities of Paul's First Missionary Journey

Open the [map](#) and get your Bible. Follow Paul's first journey:  
Acts 13:1-14; 14:1, 6, 20-21, 25-26.

Put a ☆ around the cities Paul visited.

Draw a line starting with Antioch (Syria) and connect to each city Paul traveled. He traveled back to some of the cities before returning to Antioch. There are two Antiochs so be careful to start at the right place.

*Click on the map for a larger print version.*

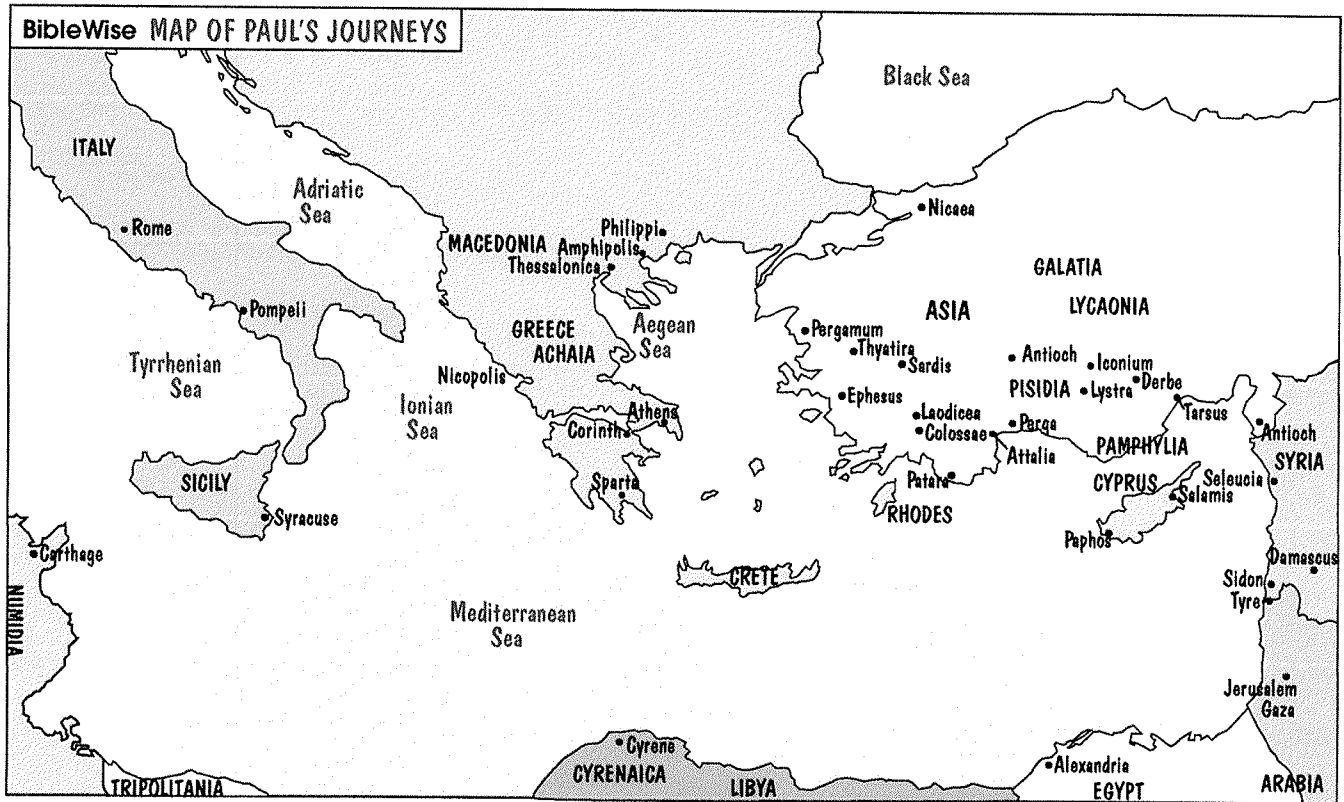

**BibleWise MAP OF PAUL'S JOURNEYS**

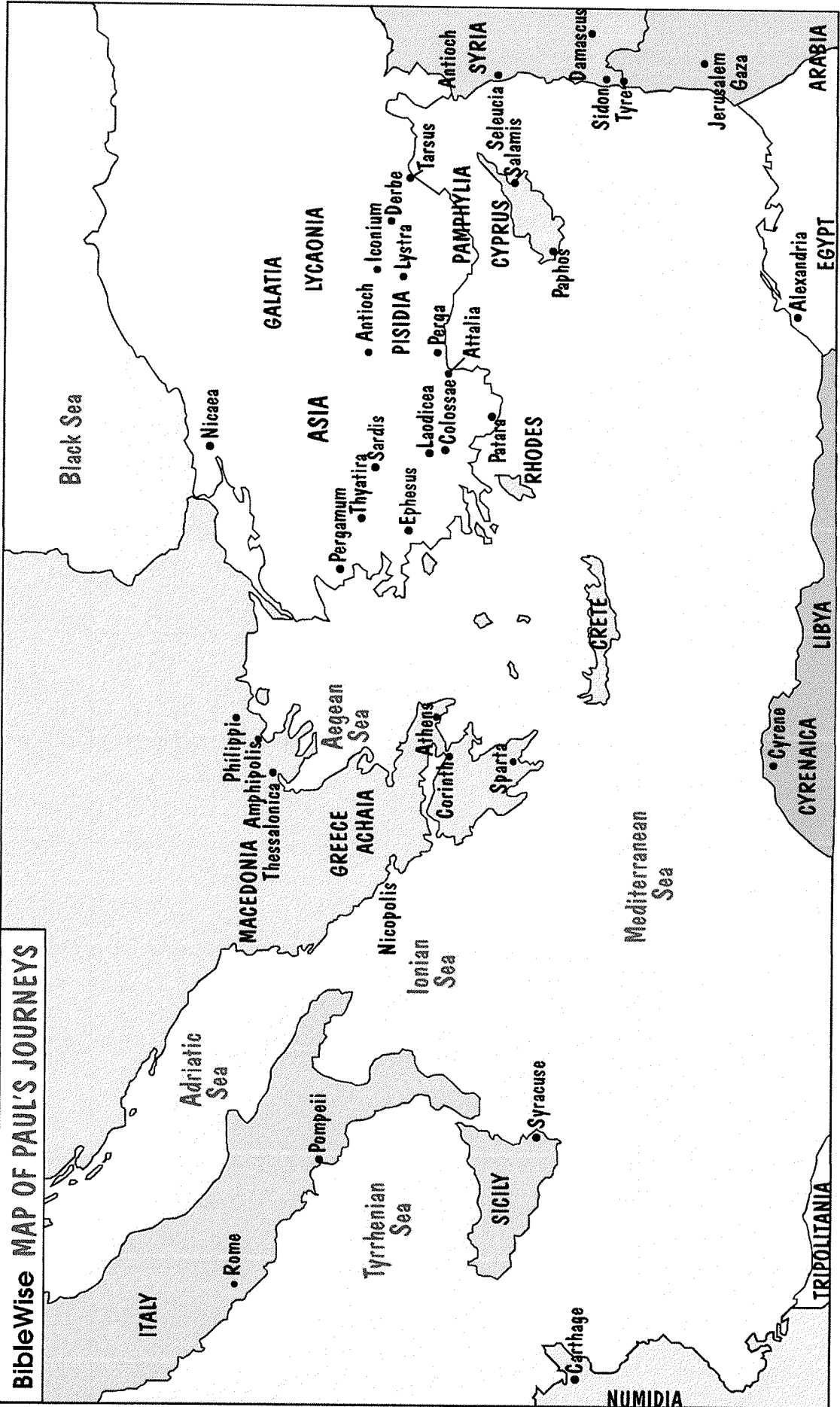

# 258. PAUL'S FIRST MISSIONARY JOURNEY

## (ACTS 12:25-13:52)

### MEMORY VERSE:

"For so the Lord has commanded us: 'I have set you to be a light to the Gentiles, that you should be for salvation to the ends of the earth.' " ACTS 13:47

### FILL IN THE BLANKS:

1. "Now in the church that was at Antioch there were certain \_\_\_\_\_ and \_\_\_\_\_: Barnabas, Simeon who was called Niger, Lucius of Cyrene, Manaen who had been brought up with Herod the tetrarch, and Saul." ACTS 13:1
2. "As they ministered to the Lord and fasted, the \_\_\_\_\_ said, 'Now separate to Me Barnabas and Saul for the work to which I have called them.' " ACTS 13:2

### TRUE OR FALSE:

3. "So, being sent out by the Holy Spirit, they went down to Seleucia, and from there they sailed to Cyprus." ACTS 13:4  
TRUE OR FALSE
4. "And when they arrived in Salamis, they preached the word of God in the synagogues of the Jews. They also had John as their assistant." ACTS 13:5  
TRUE OR FALSE

### FILL IN THE BLANKS:

5. "Now when Paul and his party set sail from Paphos, they came to Perga in Pamphylia; and John \_\_\_\_\_ from them, returned to Jerusalem." ACTS 13:13
6. "But when they departed from Perga, they came to Antioch in Pisidia, and went into the \_\_\_\_\_ on the Sabbath Day and sat down."

### TRUE OR FALSE:

7. "And after the reading of the Law and the Prophets, the rulers of the synagogue sent to them, saying, 'Men and brethren, if you have any word of exhortation for the people, say on.' " ACTS 13:15  
TRUE OR FALSE
8. "Then Paul stood up, and motioning with his hand said, Men of Israel, and you who fear God, listen." ACTS 13:16  
TRUE OR FALSE

### FILL IN THE BLANKS:

9. "And when the Jews went out of the synagogue, the \_\_\_\_\_ begged that these words might be preached to them the next Sabbath." ACTS 13:42
10. "And the next Sabbath almost the whole city came together to hear the word of God. But when the Jews saw the multitudes, they were filled with \_\_\_\_\_; and contradicting and blaspheming, they opposed the things spoken by Paul." ACTS 13:45
11. "But the Jews stirred up the devout and prominent women and chief men of the city, raised up persecution against Barnabas and Paul, and \_\_\_\_\_ them from their region." ACTS 13:50
12. "And the \_\_\_\_\_ were filled with joy and the Holy Spirit." ACTS 13:52

## 258. PAUL'S FIRST MISSIONARY JOURNEY (ACTS 12:25-13:52)



"As they ministered to the Lord, and fasted, the Holy Ghost said, Separate me Barnabas and Saul for the work whereunto I have called them." **ACTS 13:2**

"So they, being sent forth by the Holy Ghost, departed unto Seleucia; and from thence they sailed to Cyprus." **ACTS 13:4**

# 258. PAUL'S FIRST MISSIONARY JOURNEY

## (ACTS 12:25-13:52)

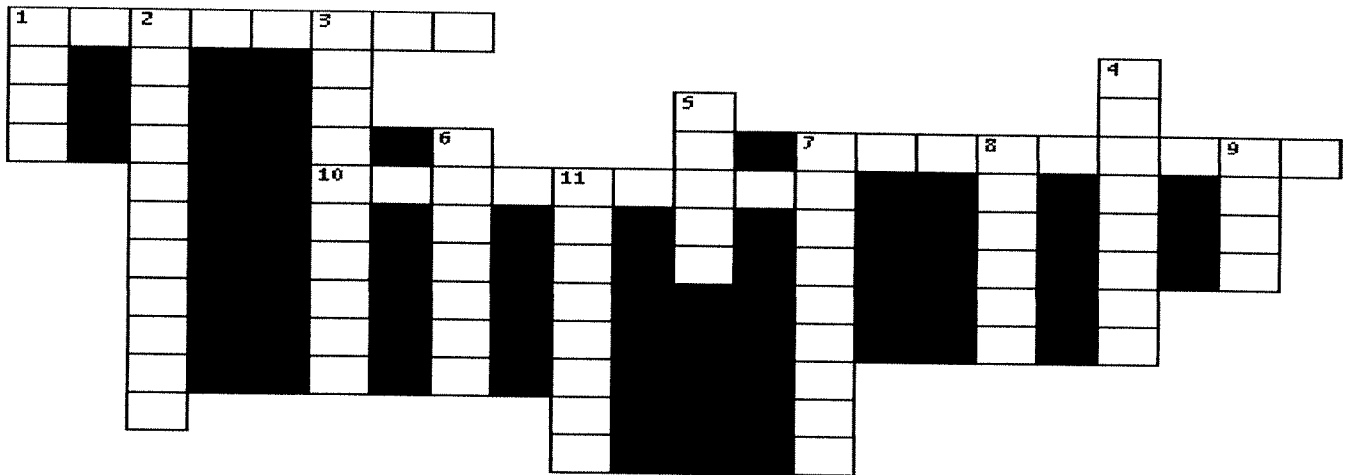

- 6 DOWN "Now in the church that was at \_\_\_\_\_ there were certain prophets and teachers..." **ACTS 13:1**
- 3 DOWN "As they ministered to the Lord and fasted, the \_\_\_\_\_ said, 'Now separate to Me Barnabas and Saul for the work to which I have called them.'" **ACTS 13:2**
- 8 DOWN "So, being sent out by the Holy Spirit, they went down to Seleucia, and from there they sailed to \_\_\_\_\_." **ACTS 13:4**
- 1 ACROSS "And when they arrived in Salamis, they \_\_\_\_\_ the word of God in the synagogues of the Jews. They also had John as their assistant." **ACTS 13:5**
- 7 DOWN "Now when Paul and his party set sail from Paphos, they came to Perga in Pamphylia; and John \_\_\_\_\_ from them, returned to Jerusalem." **ACTS 13:13**
- 10 ACROSS "But when they departed from Perga, they came to Antioch in Pisidia, and went into the \_\_\_\_\_ on the Sabbath Day and sat down." **ACTS 13:14**
- 2 DOWN "...the rulers of the synagogue sent to them, saying, 'Men and brethren, if you have any word of \_\_\_\_\_ for the people, say on.'" **ACTS 13:15**
- 1 DOWN "Then \_\_\_\_\_ stood up, and motioning with his hand said, 'Men of Israel, and you who fear God, listen.'" **ACTS 13:16**
- 11 DOWN "And when the Jews went out of the synagogue, the \_\_\_\_\_ begged that these words might be preached to them the next Sabbath." **ACTS 13:42**
- 9 DOWN "...But when the Jews saw the multitudes, they were filled with \_\_\_\_\_; and contradicting and blaspheming, they opposed the things spoken by Paul." **ACTS 13:45**
- 5 DOWN "...I have set you to be a \_\_\_\_\_ to the Gentiles,..." **ACTS 13:47**
- 4 DOWN "But the Jews stirred up the devout and prominent women and chief men of the city, raised up persecution against Barnabas and Paul, and \_\_\_\_\_ them from their region." **ACTS 13:50**
- 7 ACROSS "And the \_\_\_\_\_ were filled with joy and the Holy Spirit." **ACTS 13:52**

# 258. PAUL'S FIRST MISSIONARY JOURNEY (ACTS 12:25-13:52)

G N B L D M P M I L U A S B C Y I S U Y  
 O E L X I E T E J O H N M A R K D S Z S  
 J V N I P S Y J R E T A I R R F I B D D  
 S M R T L D L A O Q S Y J X K M L W U Q  
 Z U S U I C U L R A D B Z Q E D G S C B  
 N O Q V E L Z N N P N C T O G Q T D G Y  
 W X C V P Q E L O T A M N K W N R L A J  
 I M R T K E T S I I H U T L T N O I J P  
 M A N A E N T R T L T A I E D R A A O A  
 O G H L S H I A Y B B U J S I F F J Y V  
 V P A U L P T R R F I P C F C Y W T B T  
 M Q N C S E T D V A B P I E V V V L F P  
 G O N Y N S B Z B H P E R Z S Y B N L G  
 D T L M I D S P K V D E L E S R Q J I F  
 O O V N U E M E C E U I S I A B E O H K  
 H H I G W T H B E L K D I R E C J P V K  
 T M G K S S V L U C B L R L U V H I M O  
 C K R M C A Y I Z J B O J O K F E E E C  
 U W K P T F B A B I F Z X U L P C D D T  
 V W Z E P N L B A R N A B A S N A M Y N

BARNABAS  
 BELIEVED  
 DUST  
 FASTED  
 GENTILES  
 GLORIFIED  
 HANDS

HOLY SPIRIT  
 JOHN MARK  
 JOY  
 LORD  
 LUCIUS  
 MANAEN  
 MINISTRY

PAUL  
 PERSECUTION  
 PRAYED  
 PREACHED  
 SAUL  
 SEPARATE  
 SIMEON

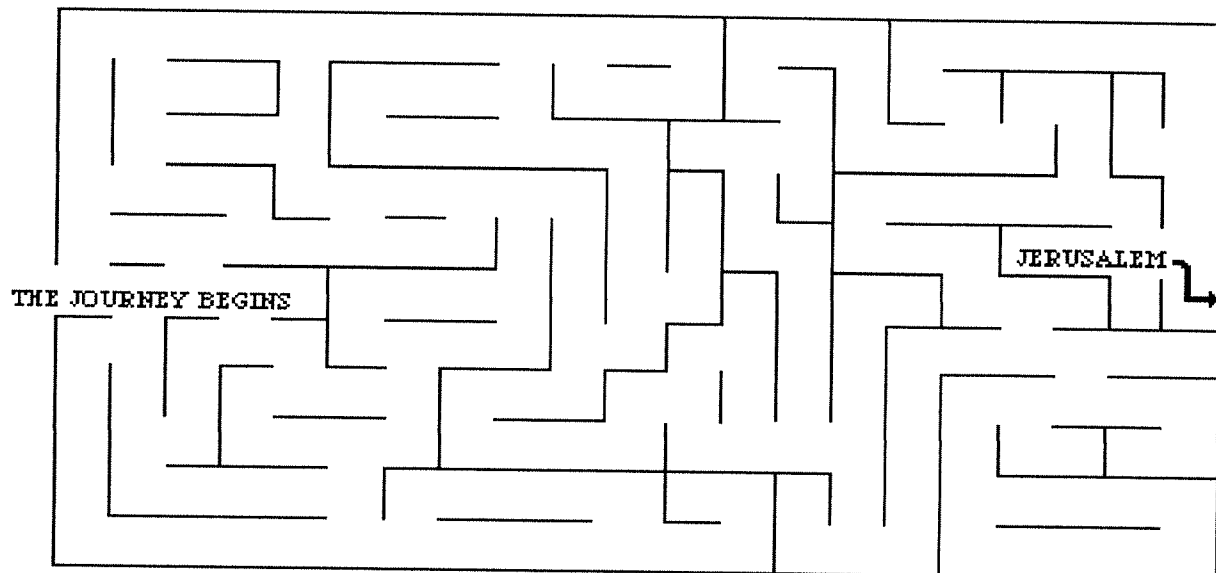

## Quiz for the Bus

Use the material on the Holy Land tour of Turkey, Bible stories on BibleWise, and Acts 13-14:5 to answer the following questions.

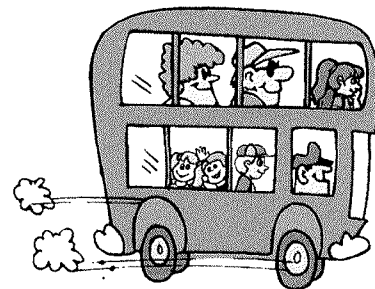

How well do you know Paul?

1. Paul's name was originally \_\_\_\_\_.
2. Who did Paul meet on the road to Damascus? \_\_\_\_\_
3. What happened to Paul after he saw a bright light from heaven? \_\_\_\_\_
4. Who was sent to heal Saul? \_\_\_\_\_
5. Who taught and mentored Paul? \_\_\_\_\_
6. Barnabas invited Paul to help him at a church in \_\_\_\_\_?
7. Barnabas and Paul left together on the first missionary trip to \_\_\_\_\_.
8. In Seleucia they caught a ship sailing to \_\_\_\_\_.
9. They met a sorcerer named \_\_\_\_\_ or \_\_\_\_\_.
10. Who became a Christian after Elymas was blinded? \_\_\_\_\_
11. When Paul and Barnabus left Perga they traveled to \_\_\_\_\_ where Paul preached in the synagogues.
12. The Jews stirred up the Gentiles in \_\_\_\_\_.
13. What do you like most about Paul? \_\_\_\_\_



## **Year 3**

### **Week 152**

### **Paul's Second Journey**

**Scriptures: Acts 15:30-41 and 16**

**Key Verse: Acts 16:31** So they said, "Believe on the Lord Jesus Christ, and you will be saved, you and your household."

#### **Key Points:**

- 1.** After returning to Antioch and preaching there awhile, Paul desired to go back and encourage the churches they had founded on their first journey. Barnabas was determined to take John Mark but Paul refused because he had left them on their first journey to return to Jerusalem. They argued quite severely over this so that they left one another. Paul chose Silas to go with him and Barnabas took John Mark. They went throughout Syria and Cilicia, strengthening the churches.
- 2.** In Lystra and Derbe Paul and Silas met Timothy. He was a young man well spoken of by the brethren. He went with them on their journey.
- 3.** In Philippi, they went to the river to pray. They sat down with women who were meeting there. A woman named Lydia heard them and she opened her heart to the Word of the Lord. She and her household here baptized. Paul and Silas went to her home and stayed for awhile.
- 4.** A young slave girl was possessed with an evil spirit. Her masters made money from her fortune telling. She followed Paul, crying out things about God to them. This annoyed Paul and he commanded the spirit to come out. The masters were angry about this and brought Paul and Silas before the magistrates, telling lies about them. A multitude rose up against them, tore off their clothes and beat them with rods. They then threw them into jail.
- 5.** Paul and Silas were singing about midnight and the prisoners were listening. There was a great earthquake and the door of the jail opened and the prisoners' chains were loosed. The jailer came awake from his sleep thinking all the prisoners had fled. Then, he drew his sword to kill himself. Paul with a loud voice, told him to do no harm to himself, that they were all there. The jailer ran in and asked what he must do to be saved. They spoke the Word of the Lord to him and he and his house were baptized.

# BibleWise

## Discussion Questions – Paul and Silas

Read Acts 16:25-40

- Who was Silas?
- What makes a good friend?
- What kind of a friend was Silas?
- Why did Paul need friends to travel with him?
- What kind of a friend did Paul need as he traveled?
- Name some of Paul's other friends from this story.
- Would you have volunteered to travel with Paul? Why or why not?

### Paul's Second Missionary Journey

Read the Bible story at <http://gardenofpraise.com/bib166s.htm>

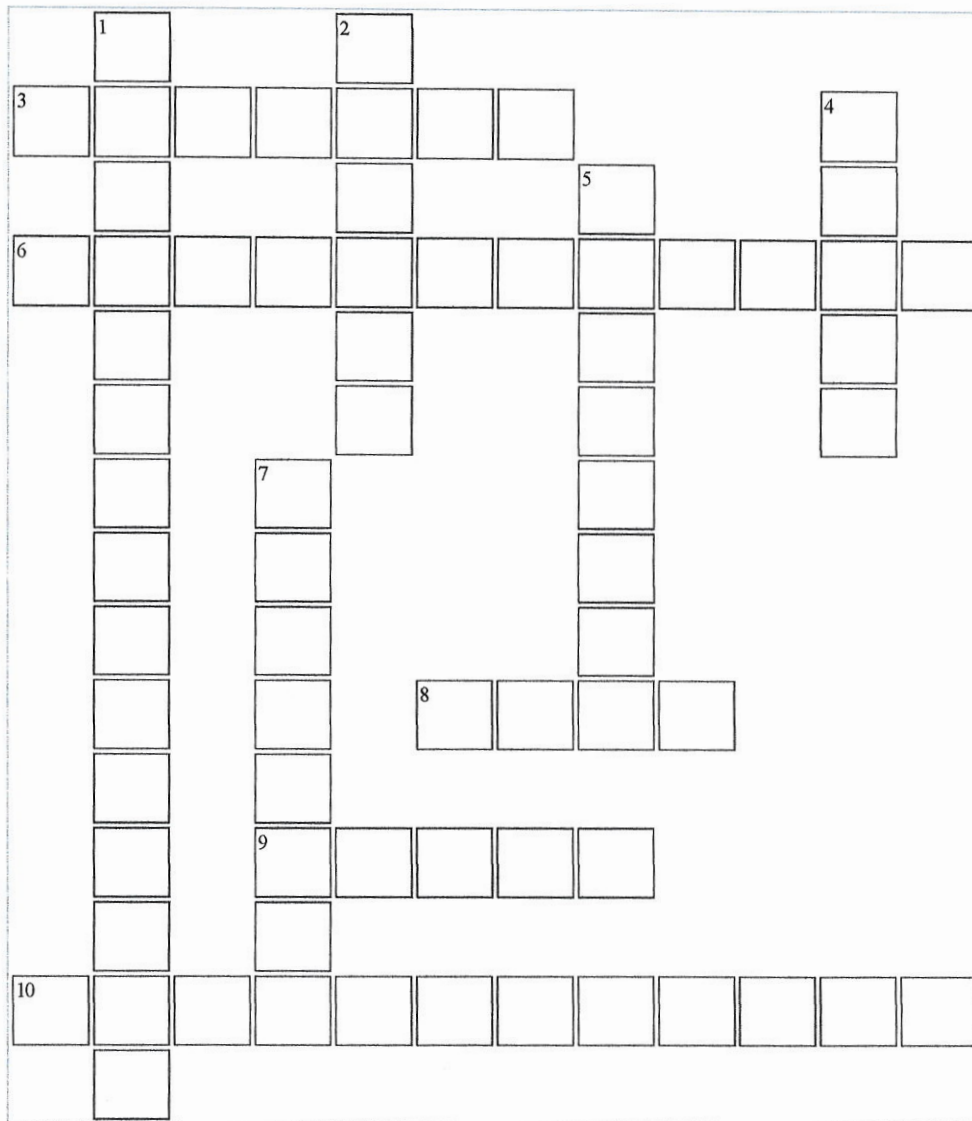

**Across**

**Down**

- 3. a young preacher
- 6. Some Jews came to Berea to \_\_\_\_ for Paul.
- 8. a physician who accompanied them
- 9. The Christians in \_\_\_\_ searched the scriptures.
- 10. Paul preached there three Sabbaths
- 1. They stayed behind in Berea.
- 2. Paul left Berea and went to \_\_\_\_.
- 4. Paul's new traveling companion
- 5. left the missionaries and returned home
- 7. John Mark's uncle

WORD BANK: JOHN MARK, SILAS, LUKE, TIMOTHY, THESSALONICA, BEREA, CAUSE TROUBLE, ATHENS, SILAS AND TIMOTHY, BARNABAS



Paul Told Others About Jesus -- Part 2

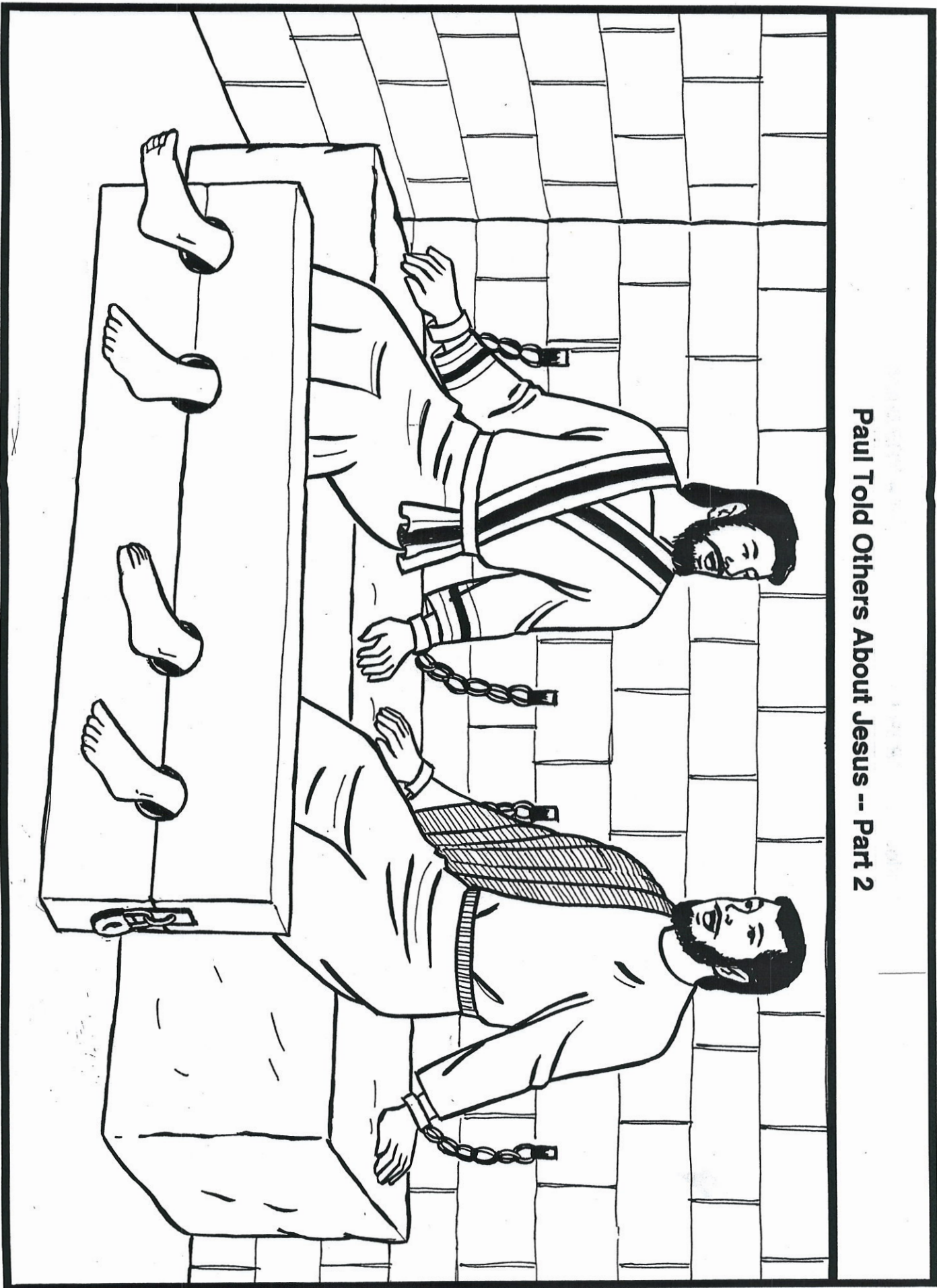

**262. PAUL AND SILAS ARE IMPRISONED  
(ACTS 16:16-40)**



“And when they had laid many stripes upon them, they cast  
*them* into prison, charging the jailor to keep them safely.”  
**ACTS 16:23**



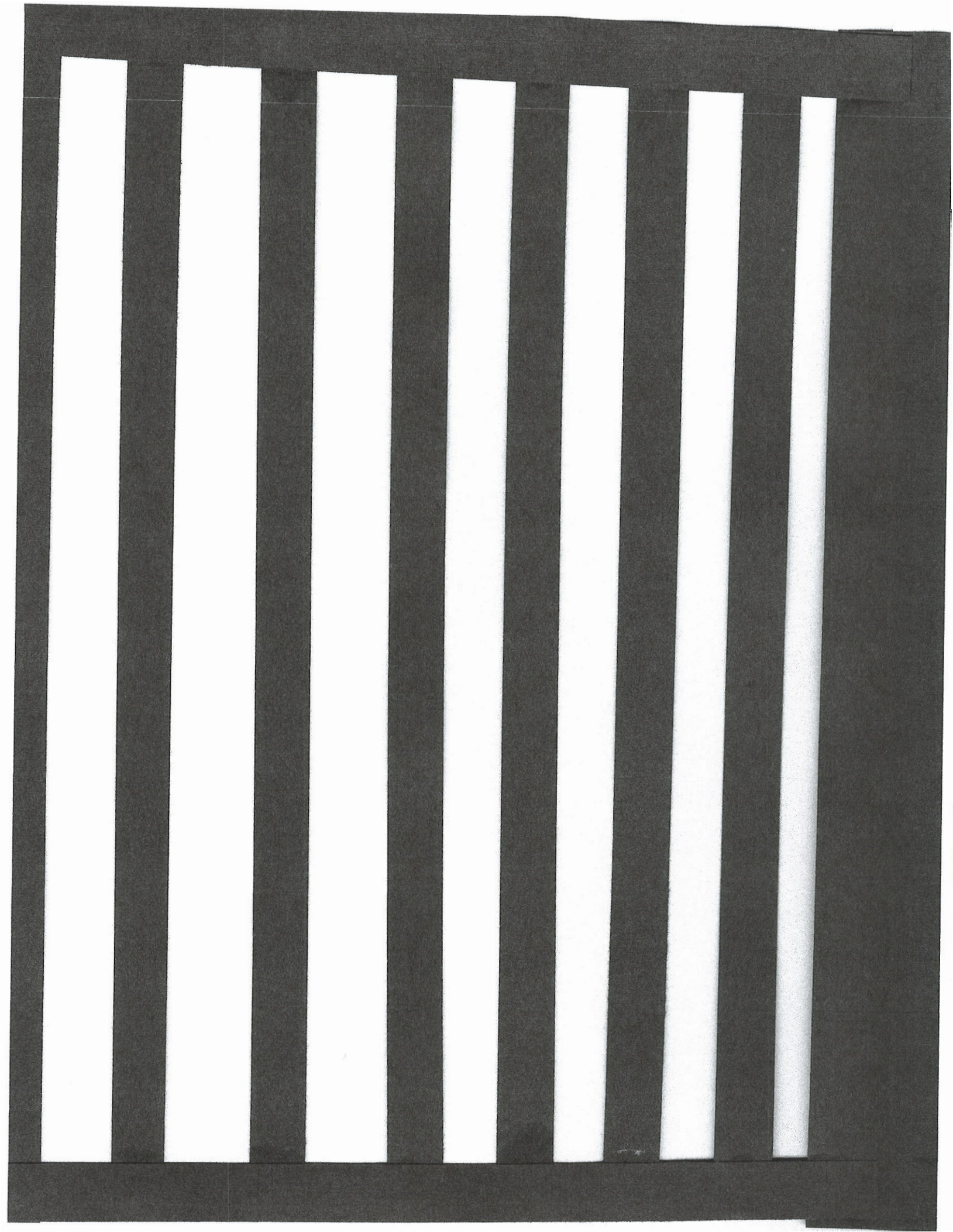



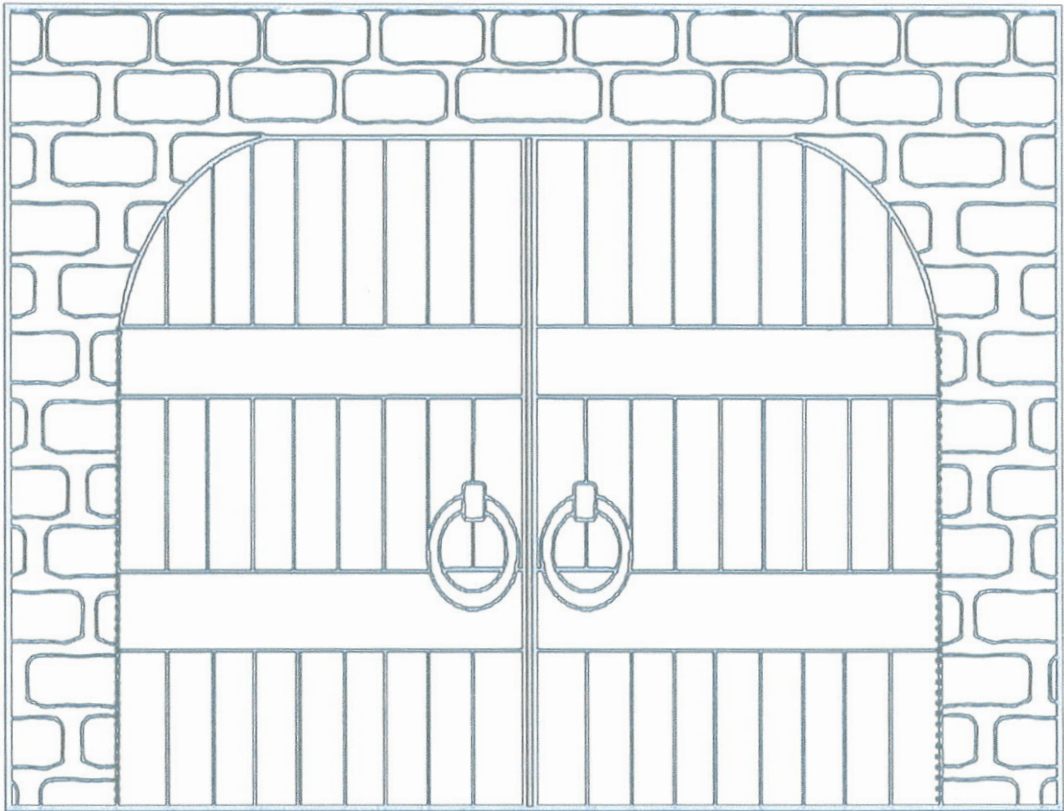

Help Paul and Silas get out of the stocks and go through the maze to where the jailer is being baptized.

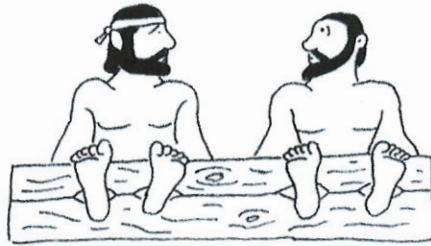



## 262. PAUL AND SILAS ARE IMPRISONED (ACTS 16:16-40)

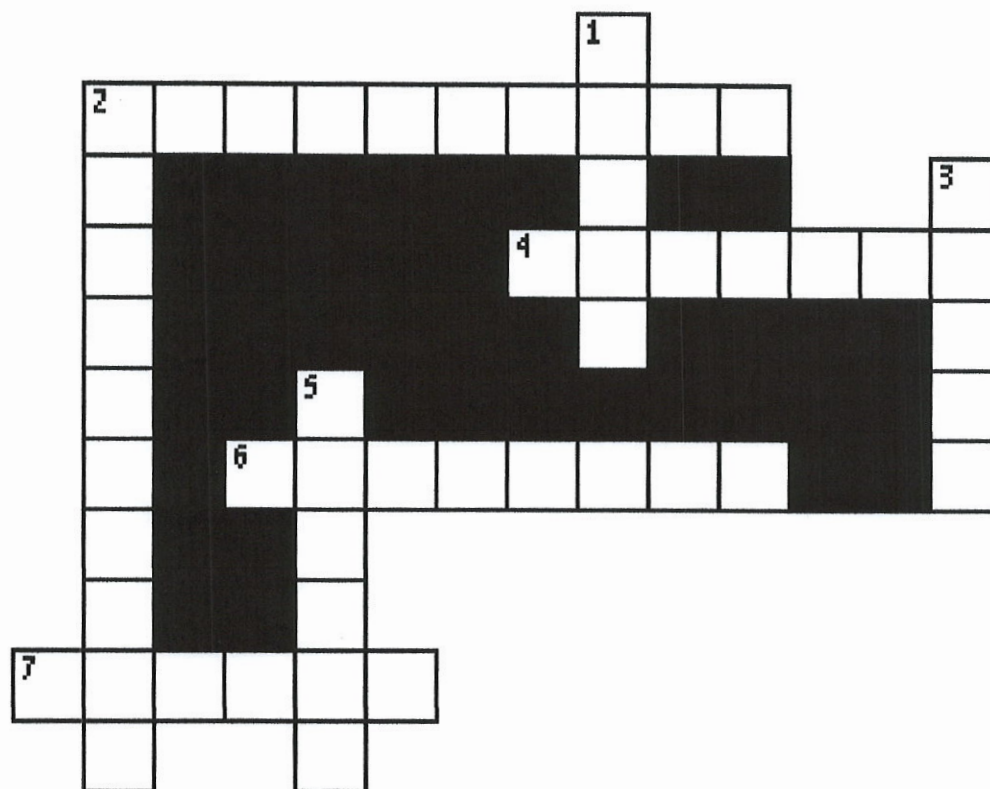

- 6 ACROSS "This girl followed Paul and us, and cried out, saying, 'These men are the \_\_\_\_\_ of the the Most High God, who proclaim to us the way of salvation.'" **ACTS 16:17**
- 7 ACROSS "When her masters saw that their hope for profit was gone, they \_\_\_\_\_ Paul and Silas and dragged them into the marketplace to the authorities." **ACTS 16:19**
- 5 DOWN "Then the multitude rose up together against them; and the magistrates tore off their clothes and commanded them to be \_\_\_\_\_ with rods." **ACTS 16:22**
- 2 ACROSS "Suddenly there was a great \_\_\_\_\_, so that the foundations of the prison were shaken; and immediately all the doors were opened and everyone's chains were loosed." **ACTS 16:26**
- 1 DOWN "And he brought them out and said, 'Sirs, what must I do to be \_\_\_\_\_?'" **ACTS 16:30**
- 4 ACROSS "So they said, '\_\_\_\_\_ on the Lord Jesus Christ, and you will be saved, you and your household.'" **ACTS 16:31**
- 3 DOWN "So the keeper of the prison reported the words to Paul, saying, 'The magistrates have sent to let you go. Now therefore depart, and go in \_\_\_\_\_.'" **ACTS 16:36**
- 2 DOWN "So they went out of the prison and entered the house of Lydia; and when they had seen the brethren, they \_\_\_\_\_ them and departed." **ACTS 16:40**

# 262. PAUL AND SILAS ARE IMPRISONED

(ACTS 16:16-40)

C J N O I T A V L A S V B U X  
G A H Y B P G A L R L W Y R H  
J P B V G O D U E R Y B D B A  
O N J F V B A T C G F P E M R  
B C D D W P S K C N B F V K O  
F H E Q Z A E J T I O A A S M  
O A Y D M E A A B G W B S I A  
B I O P F A R I W N B E B L N  
V N N R O Q T L R I C G A A S  
E S N A J T H O S S W G P S S  
H E A Y L S Q R P R I S O N N  
C P A E N C U E B E A T E N M  
K B L R A T A N Q G A H E N Y  
Z U C I Y B K C P R O F I T H  
M U Q D O H E B U E V A L S G

ANNOYED  
BEATEN  
CHAINS  
EARTHQUAKE  
GOD  
HYMNS

JAILOR  
MASTERS  
PAUL  
PRAYER  
PRISON  
PROFIT

ROMANS  
SALVATION  
SAVED  
SILAS  
SINGING  
SLAVE



Start  
Here  
→  
Help the  
key find the  
keyhole.

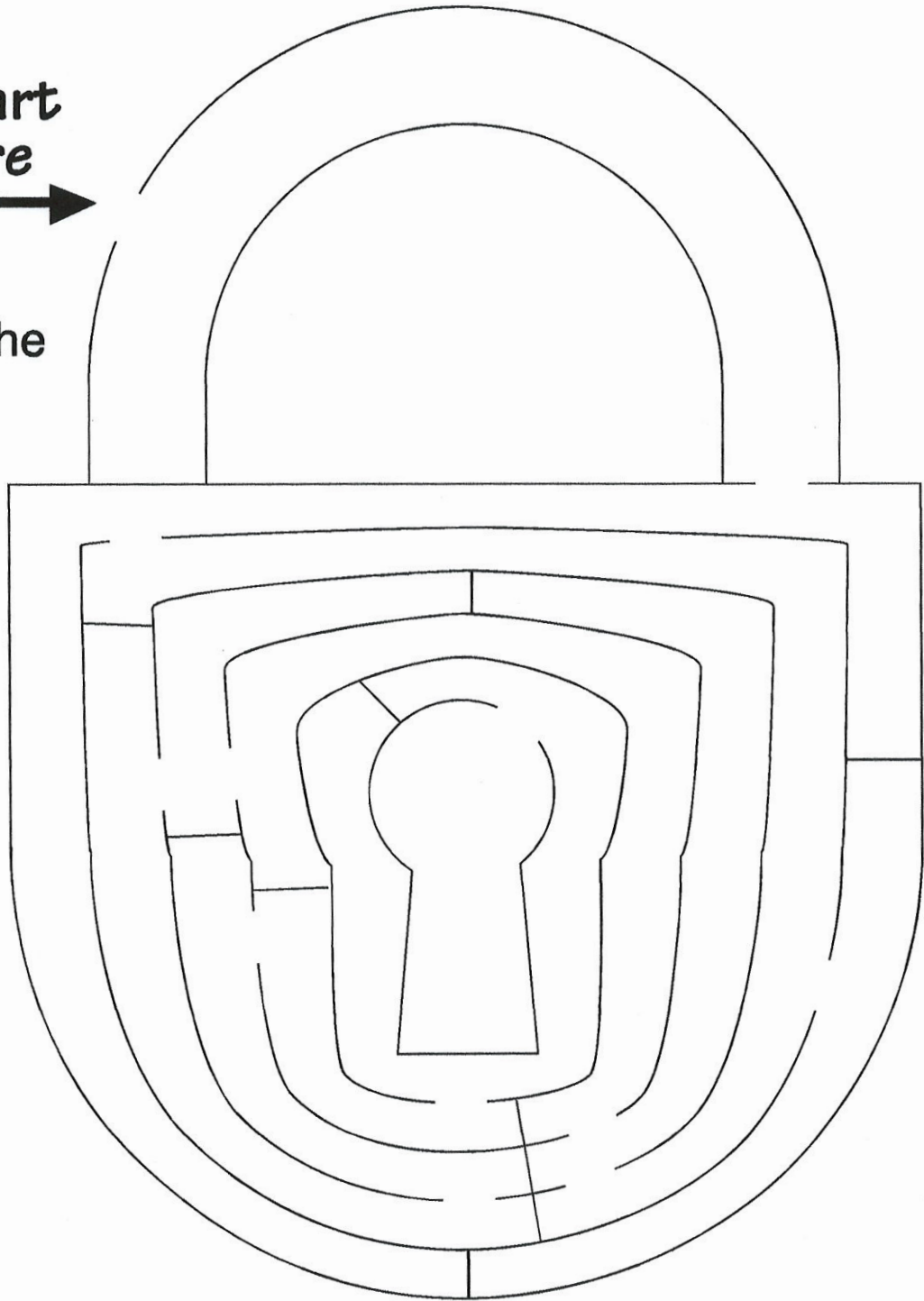

Paul and Silas did not need a key to open the prison doors. God caused an earthquake to open the doors and to make the chains fall away.



What did Paul and Silas do while they were in the jail?

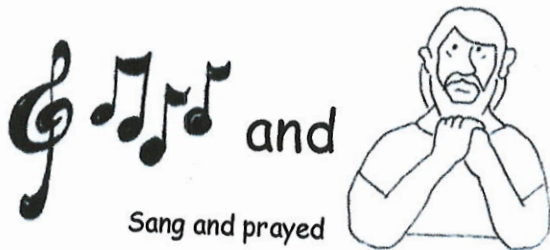

Sang and prayed

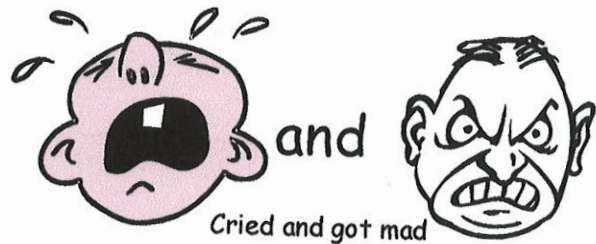

Cried and got mad

How did the doors come open?



A key was used



A tornado blew them open



An earthquake opened the doors

After the earthquake, did the jailor believe and want to be baptized?

Yes

No

What did the jailor do for Paul and Silas after he believed?

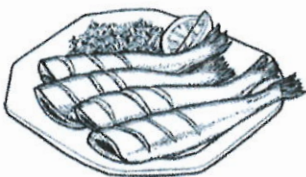

Gave them food



Washed them

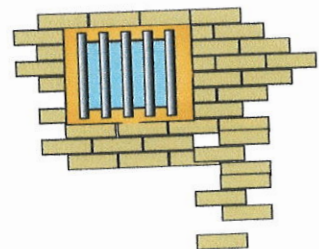

Put them back in jail



The jailor asked Paul what he should do to be saved.



The earthquake



The jailor was baptized.

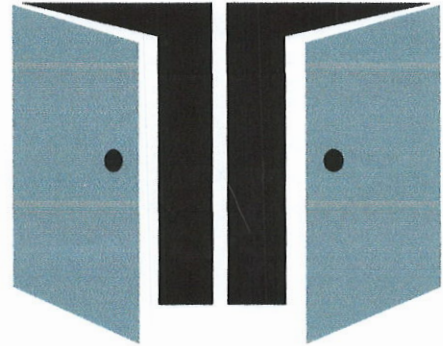

The prison doors were opened.

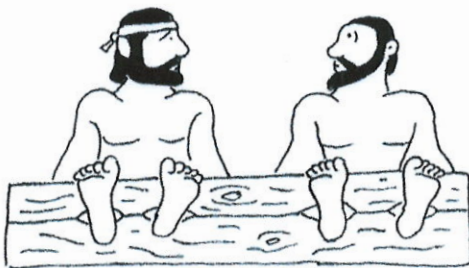

Paul and Silas were thrown into prison.



Paul and Silas sang and prayed to God.

Paul's Second Missionary Journey – Test

1. Paul and Barnabas parted over a disagreement about \_\_\_\_\_.
  - A. Timothy
  - B. John Mark
  - C. Silas
2. Paul and \_\_\_\_\_ went on the second missionary journey.
  - A. two more preachers
  - B. one more preacher
  - C. three more preachers
3. In Thessalonica Paul preached \_\_\_\_\_.
  - A. in the Jewish synagogue
  - B. in the temple
  - C. by the riverside
4. Paul and Silas had to leave Thessalonica because \_\_\_\_\_.
  - A. of unbelieving Jews
  - B. the Greeks were after them
  - C. Paul didn't want to stay there
5. They left the town \_\_\_\_\_.
  - A. at noon
  - B. at night
  - C. in the early morning
6. In the city of Berea \_\_\_\_\_.
  - A. the Jews persecuted them
  - B. Paul and Peter parted
  - C. the people searched the scriptures
7. The people of Berea wanted \_\_\_\_\_.
  - A. to make sure Paul was preaching the truth
  - B. to show off their knowledge of the scripture
  - C. order more scriptures
8. The Christians in Berea sent Paul to Athens because \_\_\_\_\_.
  - A. they didn't want to hear him anymore
  - B. the Jews started causing trouble
  - C. he was unwilling to support himself
9. \_\_\_\_\_ stayed in Berea after Paul left.
  - A. Silas and Timothy
  - B. Barnabas and John Mark
  - C. Peter and Luke
10. If my friend and I have a disagreement we should \_\_\_\_\_.
  - A. not be friends anymore
  - B. talk badly about each other
  - C. settle our differences and remain friends



Name \_\_\_\_\_ Date \_\_\_\_\_

Lesson 63 - The Philippian Jailer  
Acts 16:16-40

1. Paul cast a \_\_\_\_\_ out of a slave girl. Her \_\_\_\_\_ became very angry because they could no longer use her to make money for them.
2. Because of this incident, Paul and Silas were \_\_\_\_\_ and taken before the \_\_\_\_\_.
3. As punishment they were \_\_\_\_\_ and put in \_\_\_\_\_.
4. At midnight they were \_\_\_\_\_ and singing \_\_\_\_\_.
5. An \_\_\_\_\_ caused the prison doors to open and the \_\_\_\_\_ fell off the prisoners.
6. What was the jailer's question and what was Paul's answer? \_\_\_\_\_  
\_\_\_\_\_  
\_\_\_\_\_
7. After Paul preached about the Lord to them, the jailer and his whole family were \_\_\_\_\_.
8. The judges became afraid because \_\_\_\_\_  
\_\_\_\_\_  
\_\_\_\_\_
9. When Paul and Silas left the prison they went to \_\_\_\_\_ house.
10. Why didn't the prisoners didn't leave when the doors were opened? \_\_\_\_\_  
\_\_\_\_\_

Use the words in the box to help you with spelling.

Paul and  
Silas in Jail  
Acts 16:16-34

# Trusting God

Paul and Silas were beaten by the Roman officers and thrown into jail. Instead of complaining, Paul and Silas did something very strange.

Color in all the solid bars of the jail. Don't color the bars with broken lines. When you are finished, you'll see what Paul and Silas did.

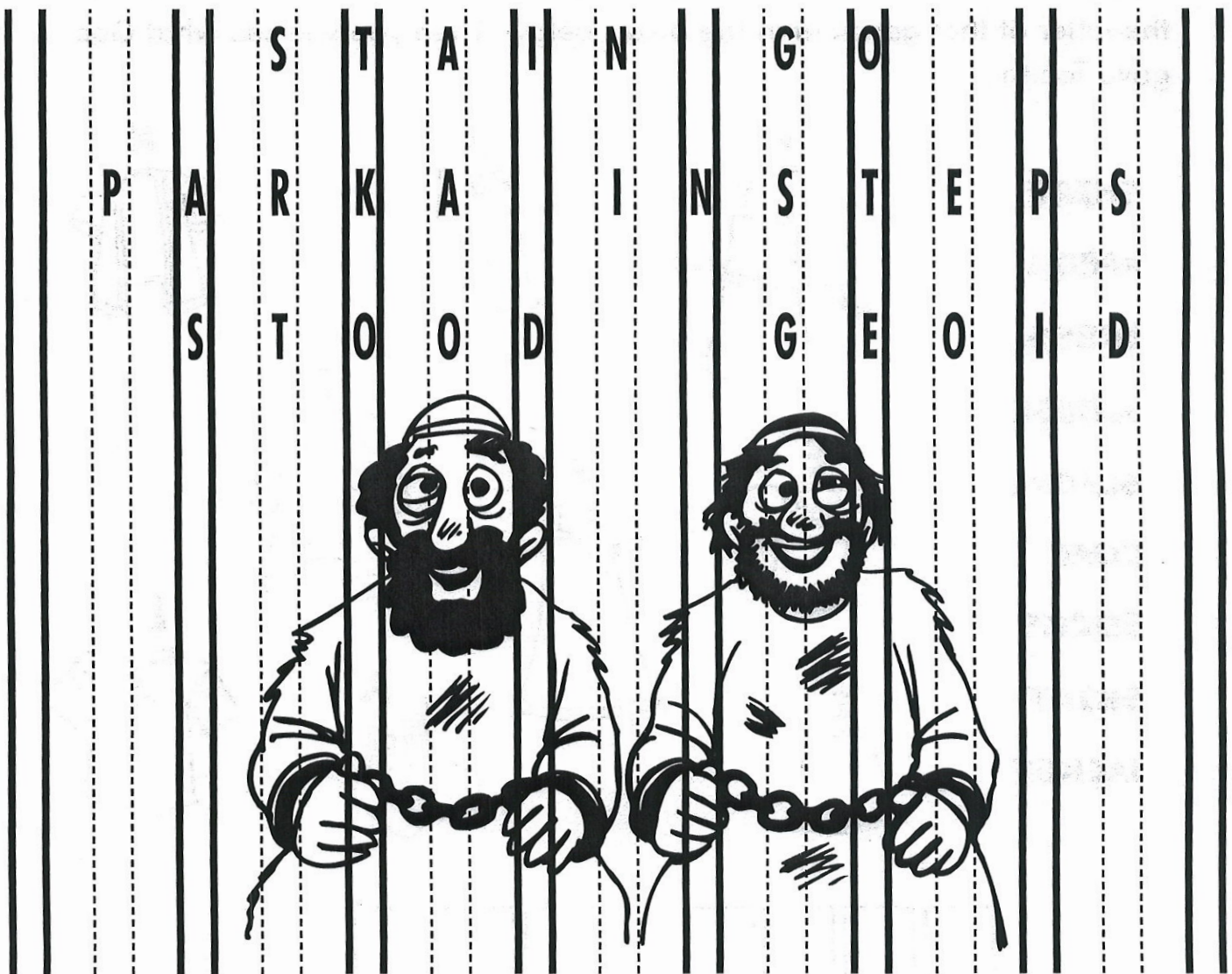





Paul Tells a Jailer About Jesus  
Acts 16



Paul Tells Lydia About Jesus  
Acts 16

**Year 3**

**Week 153**

## **Paul and Silas in Athens/Paul in Ephesus**

**Scriptures: Acts:17:16-34, 18, and 19: 1-21**

**Key Verse: Acts 17:24 God, who made the world and everything in it, since He is Lord of heaven and earth, does not dwell in temples made with hands.**

### **Key Points:**

Paul was brought to Athens and was waiting for Silas and Timothy. He was greatly distressed to find the city full of idols, even one to the “Unknown God”, the people being fearful of not giving attention to any “god”. Paul had discussions in the synagogue and marketplace with the Jews and Greeks in Athens. They were not familiar with the gospel of Jesus and thought it was strange.

They took him to a meeting at the Areopagus which was a hill in the middle of the city, where Athenians held court. He taught them that God is not worshiped with temples made with hands or like any being of gold or silver. Some of those listening made fun of Paul but others wanted to hear more and became believers.

Paul traveled on to the city of Corinth where he met fellow tentmakers Aquilla and Priscilla and worked with them there. Silas and Timothy came from Macedonia after being in Athens, (1Thes 3:1) so Paul devoted himself to preaching. From Corinth he set sail to Ephesus, going through the cities of Antioch, Galatia, and Phrygia where he strengthened disciples throughout the region.

Paul came to Ephesus where the people worshiped the goddess Dianna. He spoke against idols in their synagogues and halls. God did extraordinary miracles there through Paul. Many believed, confessed their evil deeds and were baptized. Paul was in Ephesus over 2 years. He then travels to Jerusalem by way of Macedonia and Achaia.

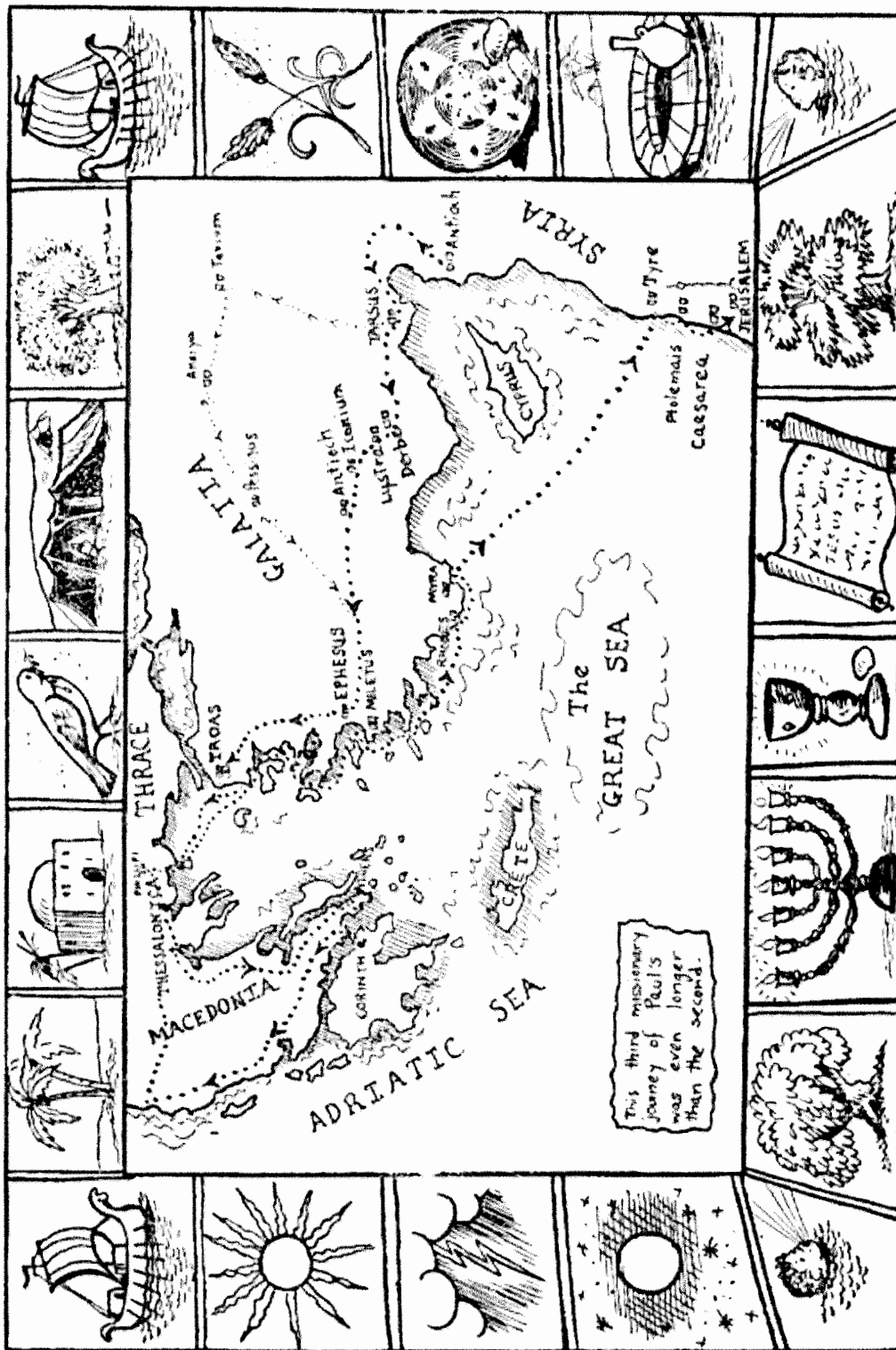

This is a map of some of Paul's journeys.

# PAUL THE MISSIONARY



Paul was a great missionary in New Testament times. He went on many long journeys, preaching the good news of Jesus Christ and starting churches. We can read his letters to those churches in the Bible books of Romans, 1 & 2 Corinthians, Galatians, Ephesians, Philippians, Colossians and others.

**Which path will bring Paul to the city of Rome?**

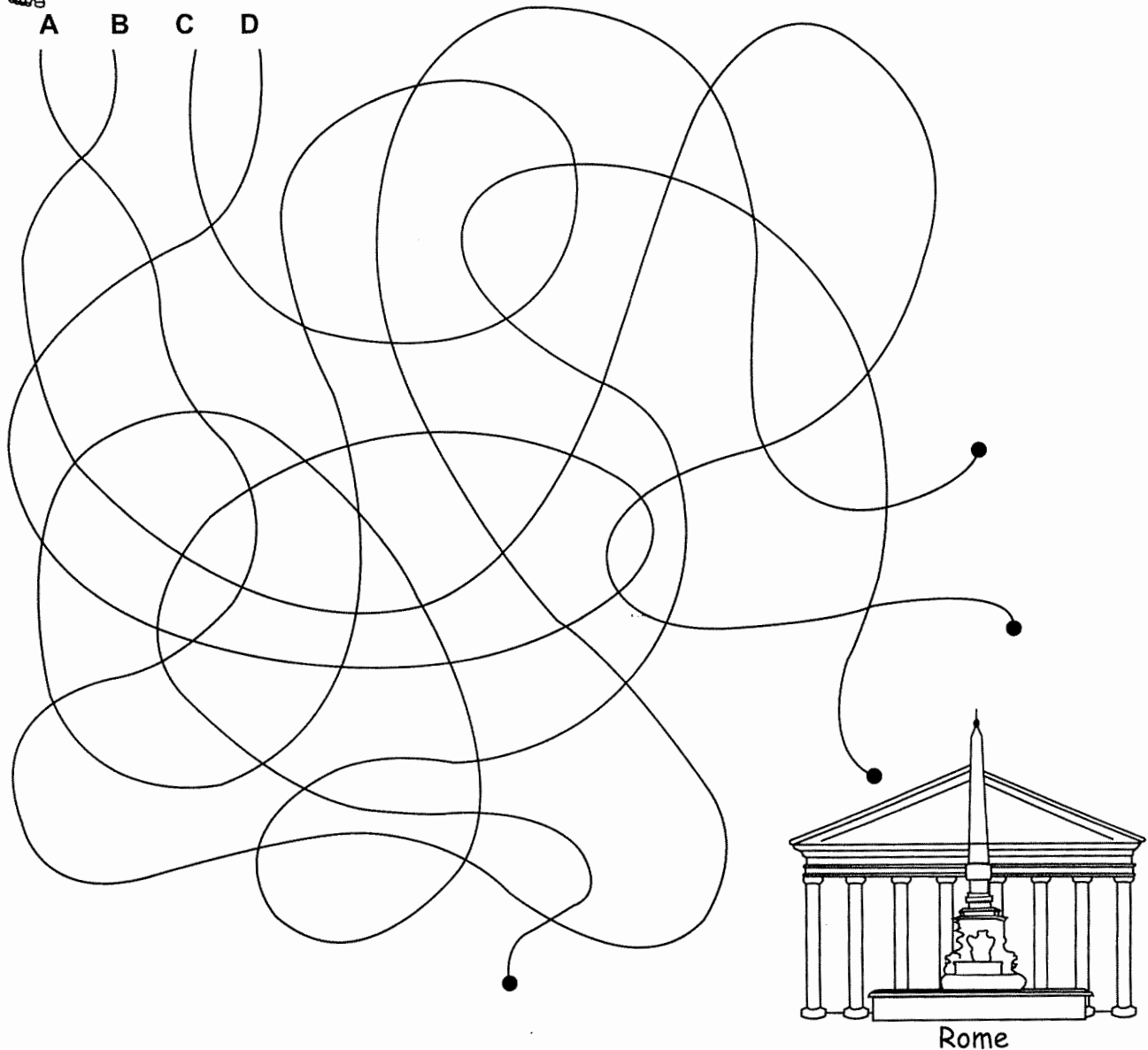



# Trusting God

Paul and Silas were beaten by the Roman officers and thrown into jail. Instead of complaining, Paul and Silas did something very strange.

Color in all the solid bars of the jail. Don't color the bars with broken lines. When you are finished, you'll see what Paul and Silas did.

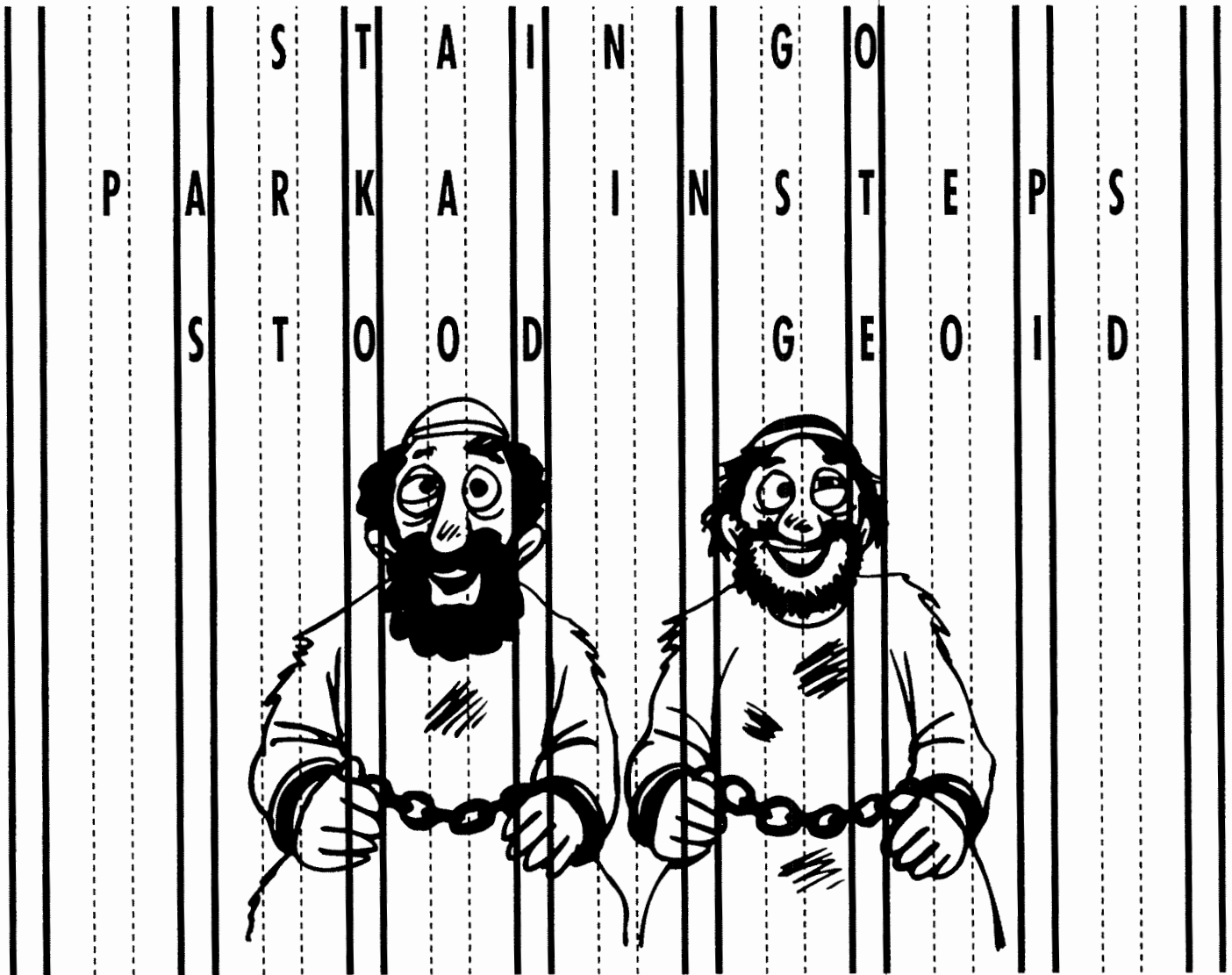

## Acts 17:24-25

Fill in the blanks using the New King James Version of the Bible.

God, who made the \_\_\_\_\_ and \_\_\_\_\_  
in it, since He is \_\_\_\_\_ of \_\_\_\_\_  
and \_\_\_\_\_, does not dwell in \_\_\_\_\_  
made with \_\_\_\_\_. Nor is He \_\_\_\_\_  
with men's \_\_\_\_\_, as though He  
\_\_\_\_\_ anything, since He gives to all  
\_\_\_\_\_, \_\_\_\_\_, and \_\_\_\_\_ things.

"Scripture taken from the New King James Version. Copyright © 1982 by Thomas Nelson, Inc. Used by permission. All rights reserved."





# Paul's Third Missionary Journey

D P P W D O A R K H E C N  
 S R C T H E K Q C C I N J  
 U I O G E Z Z O U T H E T  
 S S U K P N I I I I R I I  
 E C P J B T T E T U L H R  
 H I L A N D S M S P O A I  
 P L E A U K N A A L A V P  
 E L N J G L L V Y K Y B S  
 H A N D K E R C H I E F S  
 K C I S M S T N E V E R F  
 T S O C E T N E P R W N S  
 U T O U C H E D L J M Q V  
 H E A L E D S I S C S E U

ANTIOCH  
 CITIES  
 EVENTS  
 HOLY  
 PENTECOST  
 SPIRIT

AQUILA  
 COUPLE  
 HANDKERCHIEFS  
 JERUSALEM  
 PRISCILLA  
 TENTMAKERS

BAPTIZED  
 EPHESUS  
 HEALED  
 PAUL  
 SICK  
 TOUCHED

Created by [Puzzlemaker](http://Puzzlemaker) at [DiscoverySchool.com](http://DiscoverySchool.com)  
 Use the words to tell or write a story about Paul's Third Missionary Journey.

### Paul's Third Missionary Journey

Read the Bible story at <http://gardenofpraise.com/bibl69s.htm>

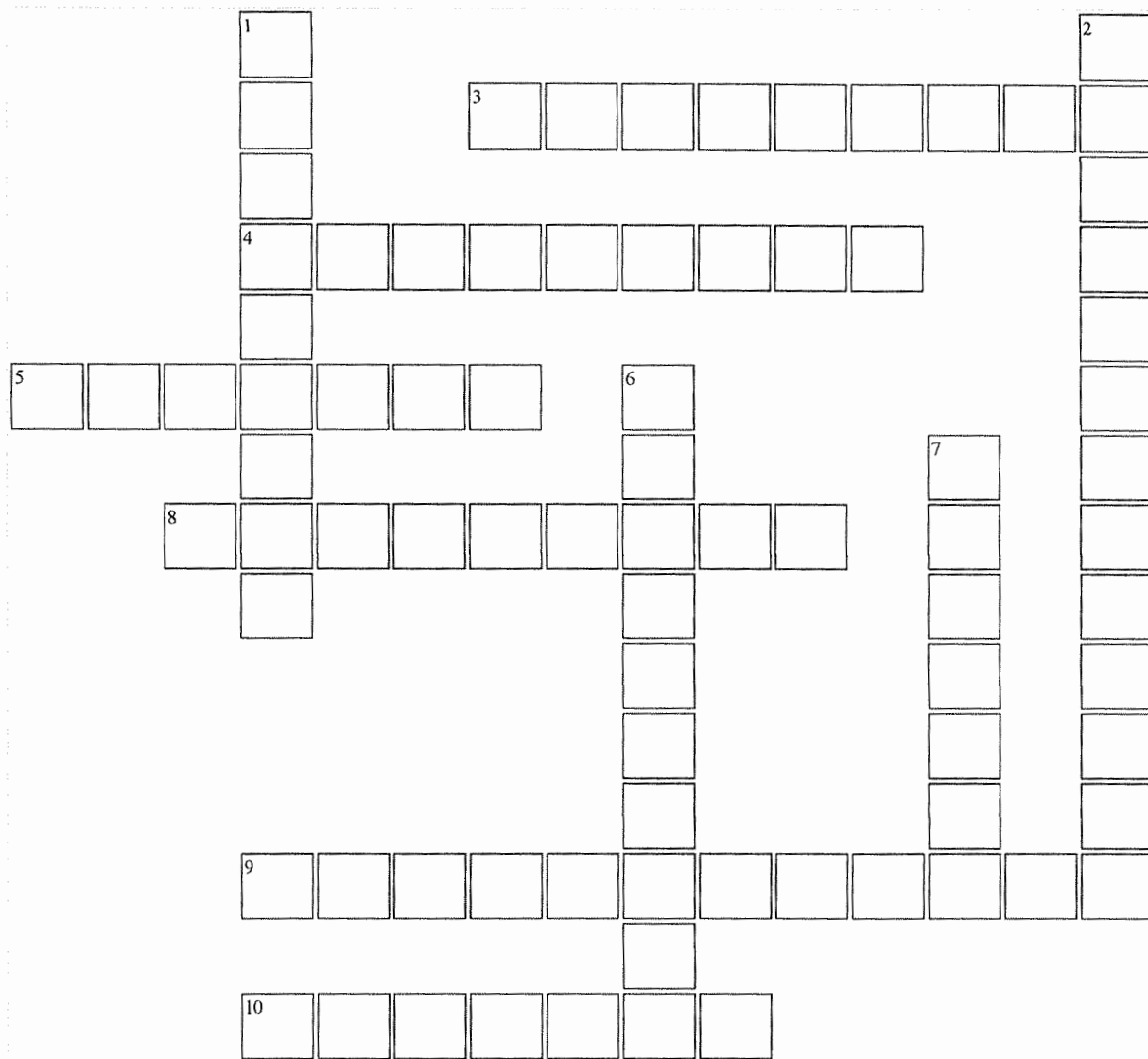

**Across**

**Down**

- |                                                                                                                                                                                                                                                                                                                                                      |                                                                                                                                                                                                 |
|------------------------------------------------------------------------------------------------------------------------------------------------------------------------------------------------------------------------------------------------------------------------------------------------------------------------------------------------------|-------------------------------------------------------------------------------------------------------------------------------------------------------------------------------------------------|
| <ul style="list-style-type: none"> <li>3. wife of Aquila</li> <li>4. In Ephesus Paul found ____ who had been baptized by John.</li> <li>5. supernatural healing</li> <li>8. This city was the site of the temple.</li> <li>9. The men were told to be baptized again in the name of ____.</li> <li>10. where Paul met Aquila and his wife</li> </ul> | <ul style="list-style-type: none"> <li>1. Aquila's occupation</li> <li>2. used in healing the sick</li> <li>6. The ____ came on the men.</li> <li>7. From Corinth Paul went to ____.</li> </ul> |
|------------------------------------------------------------------------------------------------------------------------------------------------------------------------------------------------------------------------------------------------------------------------------------------------------------------------------------------------------|-------------------------------------------------------------------------------------------------------------------------------------------------------------------------------------------------|

WORD BANK: HOLY SPIRIT, MIRACLE, HANDKERCHIEFS, THE LORD JESUS, TWELVE MEN, EPHESUS, TENTMAKER, CORINTH, PRISCILLA, JERUSALEM

# The Unknown God

Read Acts 17:22-31. To find out what Paul told the people in Athens, write the letter of the alphabet that comes before the letter shown in the box above each letter.

Paul told the people about these things:

1. How God raised Jesus

G	S	P	N

U	I	F

E	F	B	E

2. How God made the whole

X	P	S	M	E

3. How God is Lord of

I	F	B	W	F	O

and

F	B	S	U	I

4. How God made every

O	B	U	J	P	O

from one

N	B	O

5. How in God we live and move and

I	B	W	F

P	V	S

C	F	J	O	H

# Paul in Athens

B B T U Y N V S E D T H A  
P U U S X G T C E H I C T  
I S I V N A U T H S M A I  
M D N L T E S O I T O E N  
F V O U D E H D F O T R Z  
A Y E L R I E T O N H P E  
A S N E S A N L A E Y I S  
N C T Y S H I G U W M N D  
, I N W O N K N U S A E M O  
I S I L A S G O D T P D G  
F O L L O W E R S T O A Q  
E V R A C Z H I U O J A Y  
N E A Z Q L L J W K A N T

ATHENS  
FOLLOWERS  
IDEAS  
LISTEN  
SILAS  
TIMOTHY

BUILDINGS  
GOD  
IDOLS  
PAUL  
STATUES  
UNKNOWN

CARVE  
GODS  
INTERESTED  
PREACH  
STONE  
WOOD

Created by [Puzzlemaker](#) at [DiscoverySchool.com](#)  
Use the words to tell or write a story about Paul in Athens.

Paul in Athens – Test

1. Paul was waiting for \_\_\_\_\_ in Athens.
  - A. Barnabas and John Mark
  - B. Silas and Timothy
  - C. Luke and Silas
2. Around the city he saw many beautiful buildings and \_\_\_\_\_.
  - A. idols
  - B. fountains
  - C. monuments
3. Men carved gods out of \_\_\_\_\_.
  - A. soap or marble
  - B. stone or wood
  - C. wood or wax
4. People bowed down to these gods because they \_\_\_\_\_.
  - A. did not like them
  - B. wanted their friends to like them
  - C. thought the statues had power
5. They even made an idol “\_\_\_\_\_.”
  - A. to the all-seeing god
  - B. to the unknown god
  - C. to the god known by all
6. When Paul saw this idol he said \_\_\_\_\_.
  - A. he wanted to tell them about this god
  - B. it was not a god at all
  - C. they should tear it down
7. Paul told them there was a true God who \_\_\_\_\_.
  - A. hated their idols
  - B. made the world
  - C. was displeased with them
8. He also told them about \_\_\_\_\_.
  - A. the Old Testament
  - B. Moses
  - C. Jesus
9. The people of Athens \_\_\_\_\_.
  - A. wanted to stone Paul
  - B. were interested in what Paul said
  - C. listened and then all walked away
10. We can make an idol out of anything \_\_\_\_\_.
  - A. that takes the place of God in our lives
  - B. that is good for us
  - C. in which we are slightly interested



RaisingOurKids.com

Paul traveled to many places telling about Jesus.

### Paul in Athens

Read the Bible story at <http://gardenofpraise.com/bibl67s.htm>

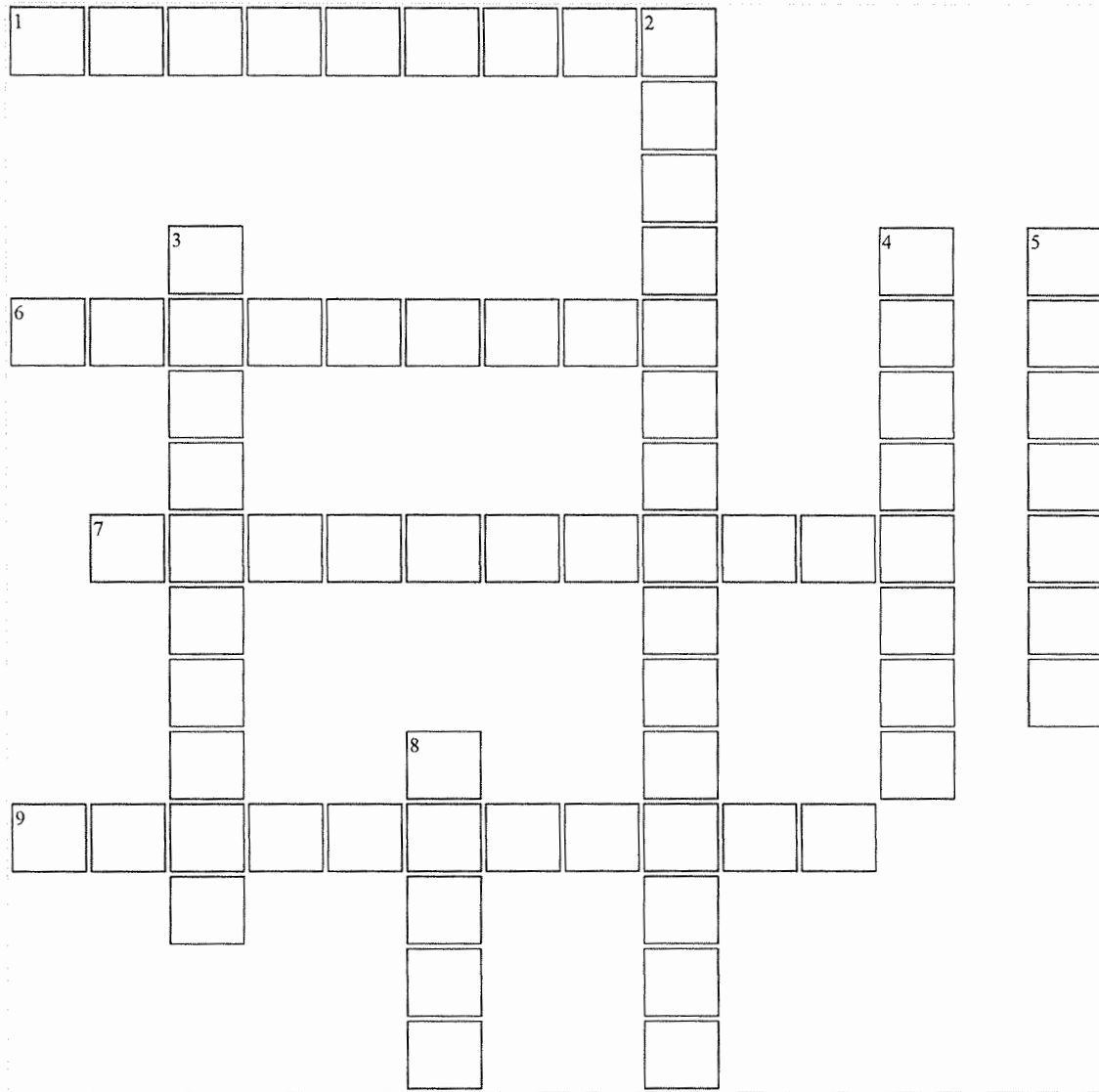

**Across**

- 1. The \_\_\_\_ stands on a high hill in Athens.
- 6. In Athens Paul saw \_\_\_\_.
- 7. In Paul's time the buildings there were \_\_\_\_ years old.
- 9. material used for carving statues

**Down**

- 2. Paul was waiting for \_\_\_\_.
- 3. One of the idols was designated "To an \_\_\_\_".
- 4. what the Athenians loved to hear
- 5. Paul told them about the \_\_\_\_.
- 8. The Athenians thought the statues had \_\_\_\_.

WORD BANK: MANY IDOLS, STONE OR WOOD, SILAS AND TIMOTHY, POWER, UNKNOWN GOD, NEW IDEAS, TRUE GOD, ACROPOLIS, FOUR HUNDRED



"Paul explains, ' God, who made the world and everything in it, since He is Lord of heaven and earth, does not dwell in temples made with hands"

Acts 17:24



## 263. TO THE UNKNOWN GOD (ACTS 17:16-34)

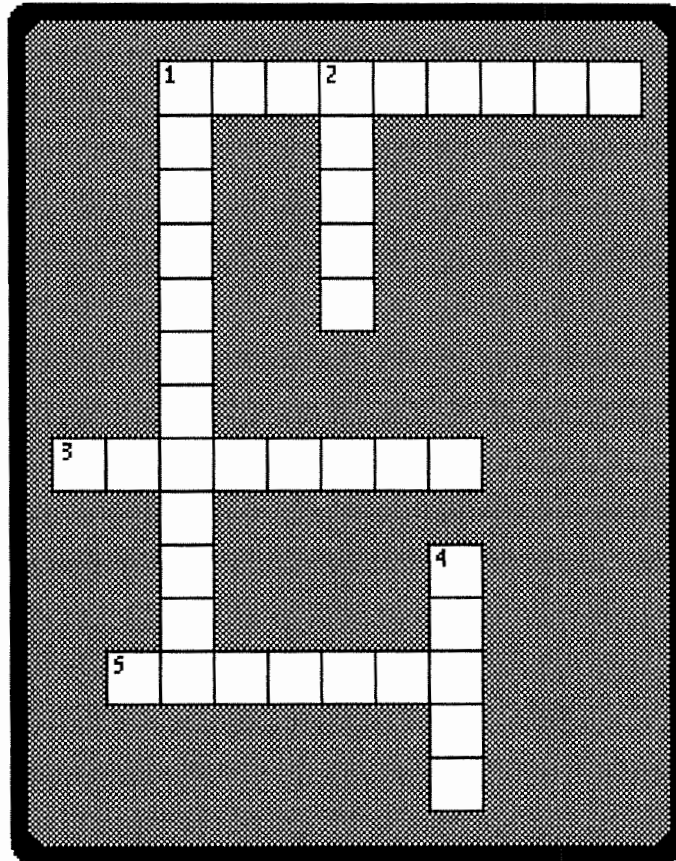

- 2 DOWN "Now while Paul waited for them at Athens, his spirit was provoked within him when he saw that the city was given over to \_\_\_\_." **ACTS 17:16**
- 3 ACROSS "And they took him and brought him to the Areopagus, saying, 'May we know what this new \_\_\_\_ is of which you speak?'" **ACTS 17:19**
- 1 ACROSS "Then Paul stood in the midst of the Areopagus and said, 'Men of Athens, I perceive that in all things you are very \_\_\_\_.'" **ACTS 17:22**
- 5 ACROSS "For as I was passing through and considering the objects of your worship, I even found an altar with this inscription: TO THE \_\_\_\_ GOD." **ACTS 17:22**
- 4 DOWN "God, who made the world, and everything in it, since He is Lord of heaven and earth, does not dwell in temples made with \_\_\_\_." **ACTS 17:24**
- 1 DOWN "And when they heard of the \_\_\_\_ of the dead, some mocked, others said, 'We will hear you again on this matter.'" **ACTS 17:32**

# 263. TO THE UNKNOWN GOD

(ACTS 17:16-34)

B T E M P L E S L O R D M C K  
 E V C Q K E Y R B W V U B B B  
 L A S L L A Y B K L S T D P K  
 I R N E V A E H D A A B O I S  
 E L S E L I T N E G T A G H M  
 V W C K W V D E B P H B N S O  
 E J H D K D J E W S E B O R A  
 D U U D I Q J J K P N L B O T  
 K N O I T C E R R U S E R W M  
 S O E O J E I O K A M R M V Z  
 U E N W O N K N U B C O U Z J  
 H S L O D I P U A V C M L L S  
 R E L I G I O U S K J E S U S  
 P P C K S N T G E Q Z O P A M  
 E T N Q U R V D T D L E M P B

ATHENS  
 BABBLER  
 BELIEVED  
 GENTILES  
 GOD  
 HEAVEN

IDOLS  
 JESUS  
 JEWS  
 LORD  
 MOCKED  
 PAUL

RELIGIOUS  
 RESURRECTION  
 TEMPLES  
 UNKNOWN  
 WORSHIP

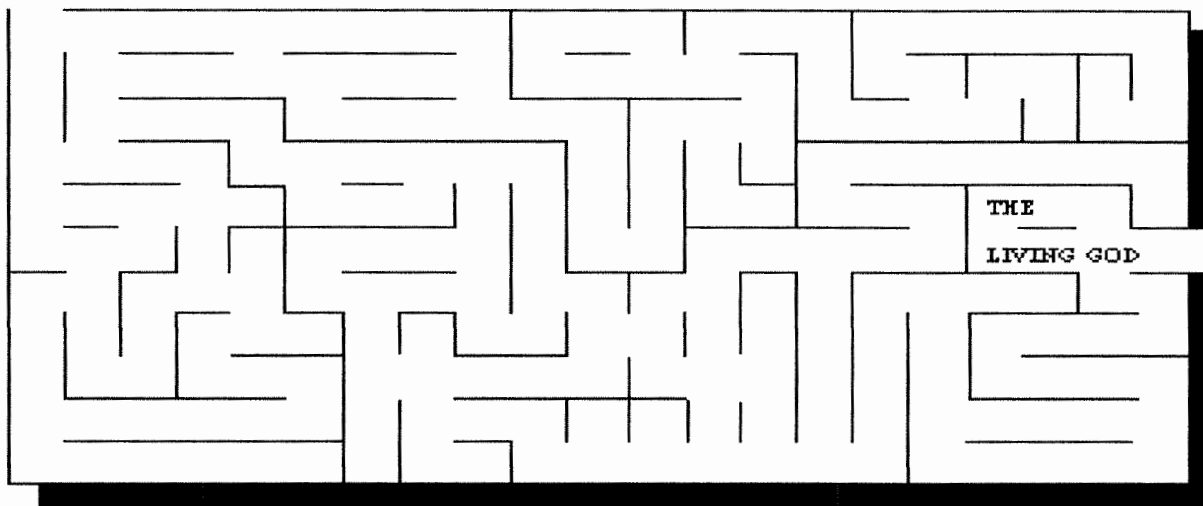

## 264. THE RIOT AT EPHESUS

(ACTS 19:11-41)



"And when they heard *these sayings*, they were full of wrath, and cried out, saying, Great is Diana of the Ephesians. And the whole city was filled with confusion: and having caught Gaius and Aristarchus, men of Macedonia, Paul's companions in travel, they rushed with one accord into the theatre."

**ACTS 19:28-29**

### The Riot in Ephesus

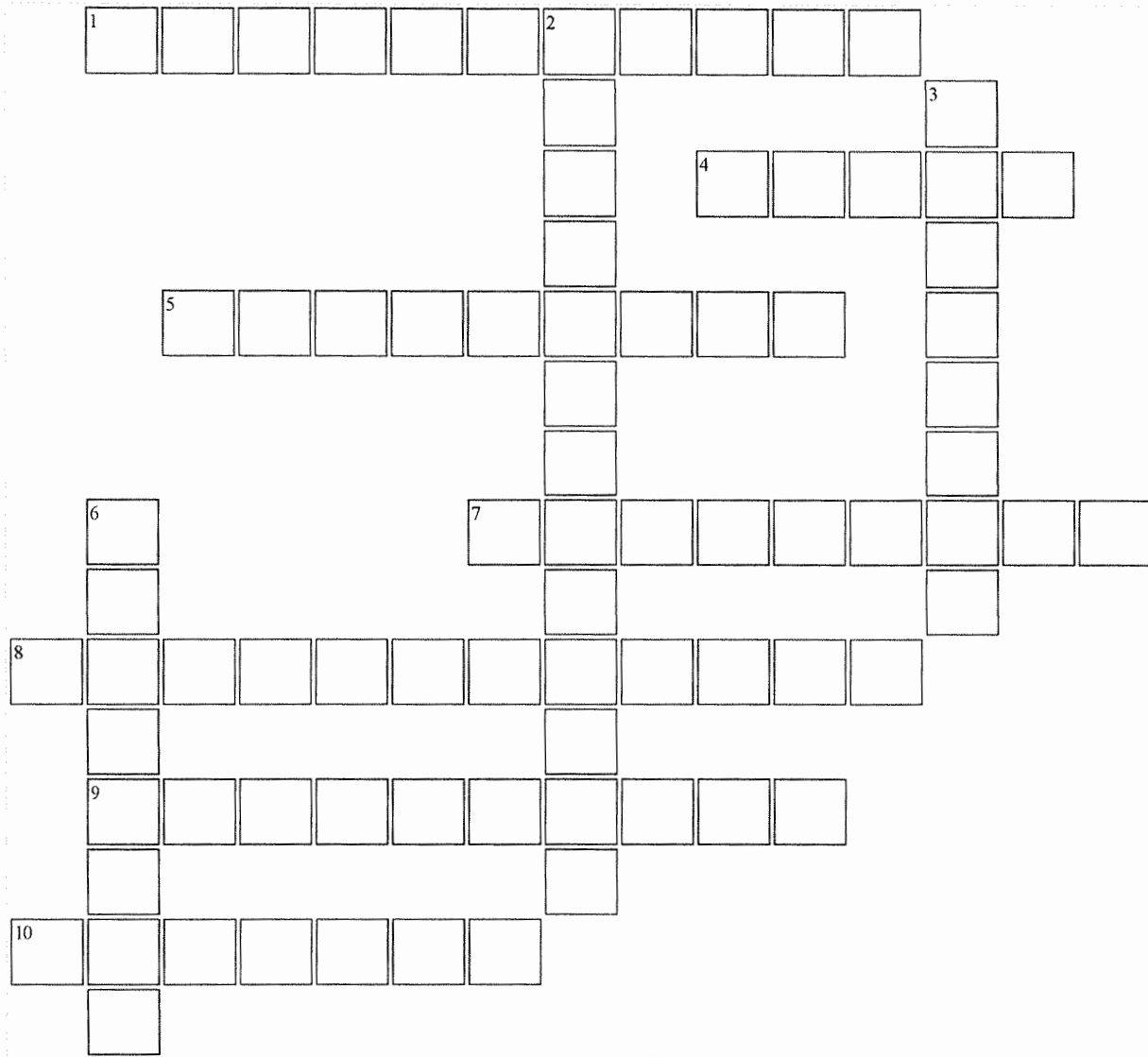

**Across**

**Down**

- |                                                      |                                      |
|------------------------------------------------------|--------------------------------------|
| 1. Demetrius was a ____.                             | 2. Demetrius made ____.              |
| 4. The people in Ephesus worshiped the goddess ____. | 3. The crowd left and Paul was ____. |
| 5. Demetrius ____ the people against Paul.           | 6. The shouting lasted for ____.     |
| 7. The ____ got the crowd to be quiet.               |                                      |
| 8. Paul said idols were ____.                        |                                      |
| 9. Paul preached there was only ____.                |                                      |
| 10. the Greek name for the goddess                   |                                      |

WORD BANK: ONE TRUE GOD, NOT GODS AT ALL, ARTEMIS, SILVERSMITH, SILVER IMAGES, STIRRED UP, TWO HOURS, CITY CLERK, UNHARMED, DIANA

# The Riot in Ephesus

D E D M L A B Y S S T A G  
 E P U E A E E U T H T N O  
 M H O L M N S A S T C A D  
 R E M T O E T Q E O L I D  
 A S O M H U T N G P E D E  
 H I Q P E P T R C X R X S  
 N A E S A I R T I R K E S  
 U N W U O G N I T U O H S  
 X S L N G R E A T T S W G  
 S I L V E R S M I T H O D  
 I L J S T O I R P U I G Z  
 O F C Y M N S T R U O C H  
 J K D J T A R T E M I S Y

ARTEMIS

COURTS

DIANA

GODDESS

PAUL

SILVERSMITH

ATTENTION

CROWD

EPHESIANS

GREAT

RIOT

STATUES

CLERK

DEMETRIUS

EPHESUS

MONEY

SHOUTING

UNHARMED

Created by [Puzzlemaker](http://Puzzlemaker) at [DiscoverySchool.com](http://DiscoverySchool.com)

Use the words to tell or write a story about The Riot in Ephesus.

### Paul Leaves Ephesus

Read the Bible story at <http://gardenofpraise.com/bib171s.htm>

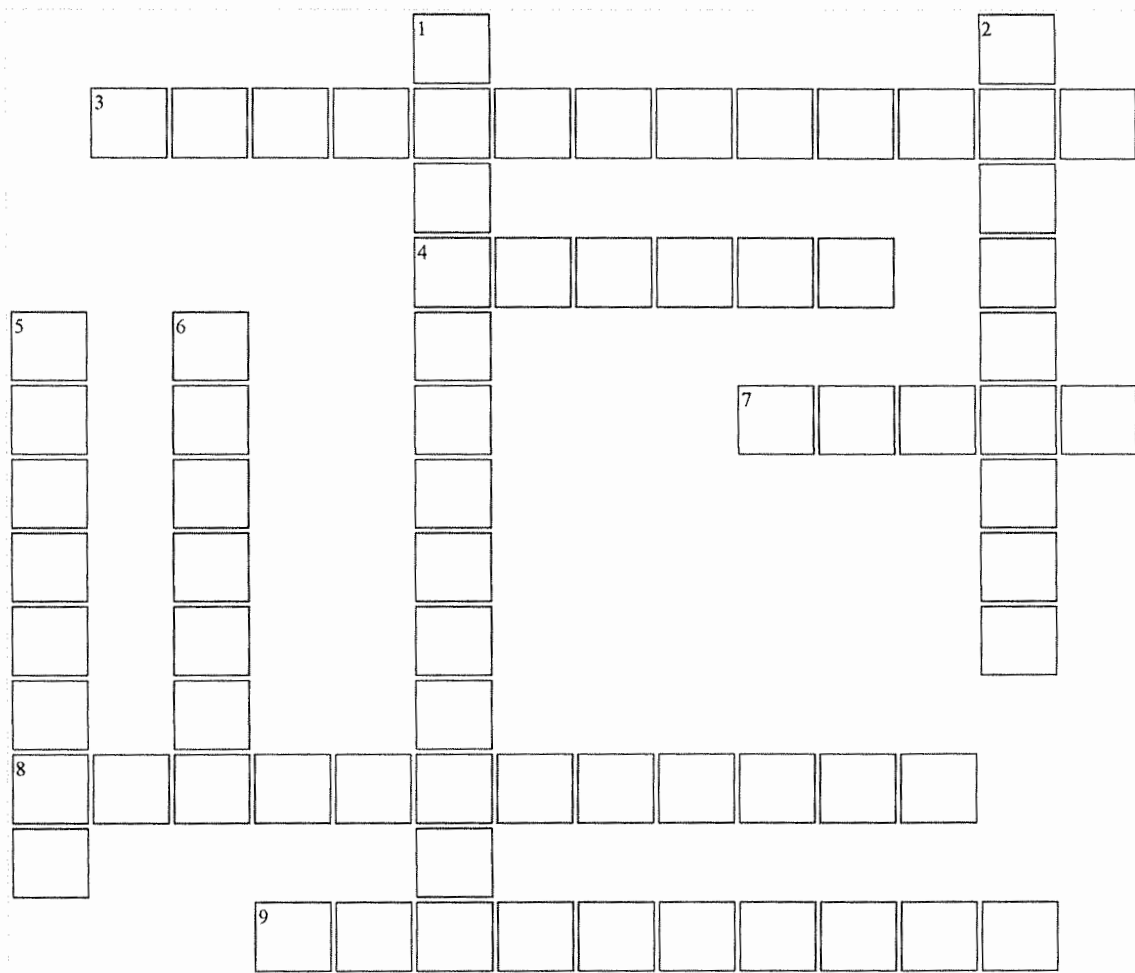

#### Across

- 3. Paul talked \_\_\_\_\_.
- 4. In Troas Paul met with the disciples on \_\_\_\_\_.
- 7. The young man went to \_\_\_\_\_.
- 8. The meeting was in an \_\_\_\_\_.
- 9. The lad fell from an \_\_\_\_\_.

#### Down

- 1. It is more \_\_\_\_\_ than to receive.
- 2. He urged the elders to be good \_\_\_\_\_.
- 5. the name of a young man who was at the meeting
- 6. the place where Paul met the Ephesian elders

WORD BANK: SUNDAY, UPSTAIRS ROOM, UNTIL MIDNIGHT, SLEEP,  
 OPEN WINDOW, MILETUS, SHEPHERDS, BLESSED TO GIVE, EUTYCHUS

# Paul Leaves Ephesus

Z J H Q S A C K R A G R D  
 K S Y D L U S R E D L E E  
 M I E W A I H M I L C T H  
 R A T U X B M C J E H F C  
 D E L E V A R T Y G D R A  
 P B G B L R D R I T W E E  
 M I L E T U S N G I U C R  
 D R H E V R D B N S P E P  
 A E Z S S I U D P A A I C  
 K E G J M S O E T O U V W  
 E V I G F W E Y S R L E V  
 W O K R U L A D M T U G O  
 G O E H S H Y A L I V E H

ALIVE  
 DEAD  
 GIVE  
 MILETUS  
 RECEIVE  
 TRAVELED

BLESSED  
 ELDERS  
 HUGGED  
 PAUL  
 SHIP  
 TROAS

CRIED  
 EUTYCHUS  
 MIDNIGHT  
 PREACHED  
 SLEEP  
 WINDOW

Created by [Puzzlemaker](http://Puzzlemaker) at [DiscoverySchool.com](http://DiscoverySchool.com)  
 Use the words to tell or write a story about Paul Leaves Ephesus.

## **Year 3**

### **Week 154**

#### **Paul Saves Eutychus and Paul is Imprisoned**

**Scriptures: Acts 20:7-12, 21:30-40, 22:1- 30**

**Key Verse: Acts 20:24** However, I consider my life worth nothing to me, if only I may finish the race, complete the task the Lord Jesus has given me-the task of testifying to the gospel of God's grace.

#### **Key Points:**

1. On his way to Jerusalem, Paul stayed 7 days in Troas. There he met several of his traveling companions. On the first day of the week, he met with the Christians to observe the Lord's Supper. Paul preached until midnight. The room was very warm because there were so many lamps burning. A young man named Eutychus went into a deep sleep and fell out of the window where he was sitting.
2. Eutychus was taken up for dead but Paul, putting his arms around him, raised Eutychus from the dead. Paul broke bread with them and they were greatly comforted.
3. Paul left Troas and set sail from Assos. From there he went to Kios, Samos and Miletus. From Miletus, Paul met with the elders from Ephesus. He encouraged them, committed them to God, and prayed with them-knowing he may never see them again.
4. Agabus, a prophet, foretold Paul's imprisonment. When he reached Jerusalem, he preached in the temple. His teachings were not popular and this created quite an uproar. He was beaten and put in chains. On the steps of the prison he got permission to speak to the crowd. He told them of his background and how Jesus spoke to him to go the Gentiles. This made the crowd angry again and they prepared to beat him. Paul told the centurion he was a Roman citizen and this alarmed him. So he released him until he would stand before the Sanhedrin council. It was illegal to beat a Roman citizen without a trial.

**(There is a lot of information in this lesson. Please highlight what is appropriate for your age level. Tracing this journey on the map might be interesting for the children)**



# BibleWise

## Discussion Questions – Paul Raises Eutychus

Read Acts 20:7-12

- What words indicate that Paul talked a long, long time?
- Where was Eutychus sitting? Was this a good spot?
- What happened to Eutychus?
- What did Paul do?
- What did Paul say to his friends about Eutychus?
- Did Paul then continue to preach?

**Acts 21:17-23:11  
Paul in Jerusalem**

When did the Lord tell Paul to leave Jerusalem? (Acts 22:18)

The commander ordered Paul to be flogged and \_\_\_\_\_. (Acts 22:24)

What about the light blinded Paul on the road to Damascus? (Acts 22:11)

The Jewish sect that did not believe in the resurrection. (Acts 23:8)

Who was the Ephesian who came to Jerusalem with Paul? (Acts 21:29)

The Apostles decided the gentiles should abstain from food sacrificed to \_\_\_\_\_. (Acts 21:25)

What did the rioters stop when they saw the Commander? (Acts 21:32)

Who's death did Paul witness? (Acts 22:20)

What Jewish leader trained Paul? (Acts 22:3)

What did the people fling into the air because they were mad? (Acts 22:23)

What believers did the apostles write a decision to? (Acts 21:25)

b i w o g a m a l i e l  
 l f m t r o p h i m u s  
 d i x m n a s r d y p a  
 u v q u e s t i o n e d  
 s b g d o d t c l h f d  
 t w e q u g i b s e m u  
 v b n a c s e a k g l c  
 r u t s t x r o t z k e  
 b r i l l i a n c e i e  
 f d l y j g n e s u l s  
 s t e p h e n g m w a y

Copyright 2000 by Don Crowover

# Paul Speaks to a Noisy Crowd

Paul wanted to share the Good News with the people in Jerusalem.

But they were angry with him. Everyone was yelling. Men were trying to hurt Paul so the Roman soldiers started to carry him up the steps. Then Paul asked the commander for permission to speak to the men.

Right now, there is too much noise to be able to hear Paul. Help the crowd quiet down by crossing out all the Cs, Gs, Ks, Qs and Ws on the steps. Then put the leftover letters on the spaces below. Then you will see how Paul started his speech.

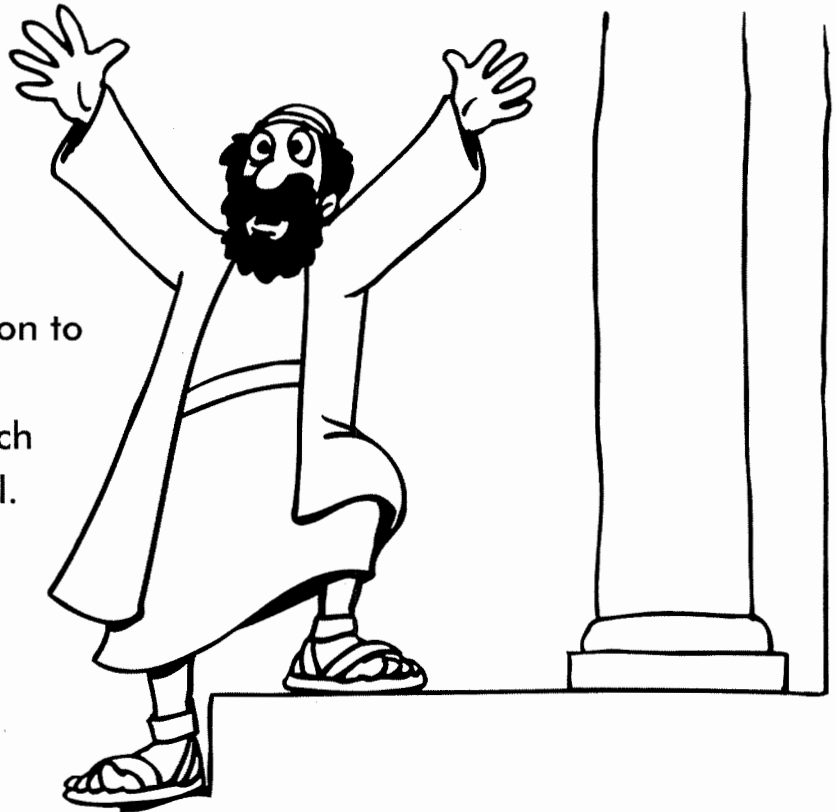

C B G R K O Q T W H W E Q R K S  
A C N C D G K F Q A W T Q H K E G R S  
C L G I K S Q T W E W N Q K T G O C M G E K

-----'

Paul Told Others About Jesus -- Part 1

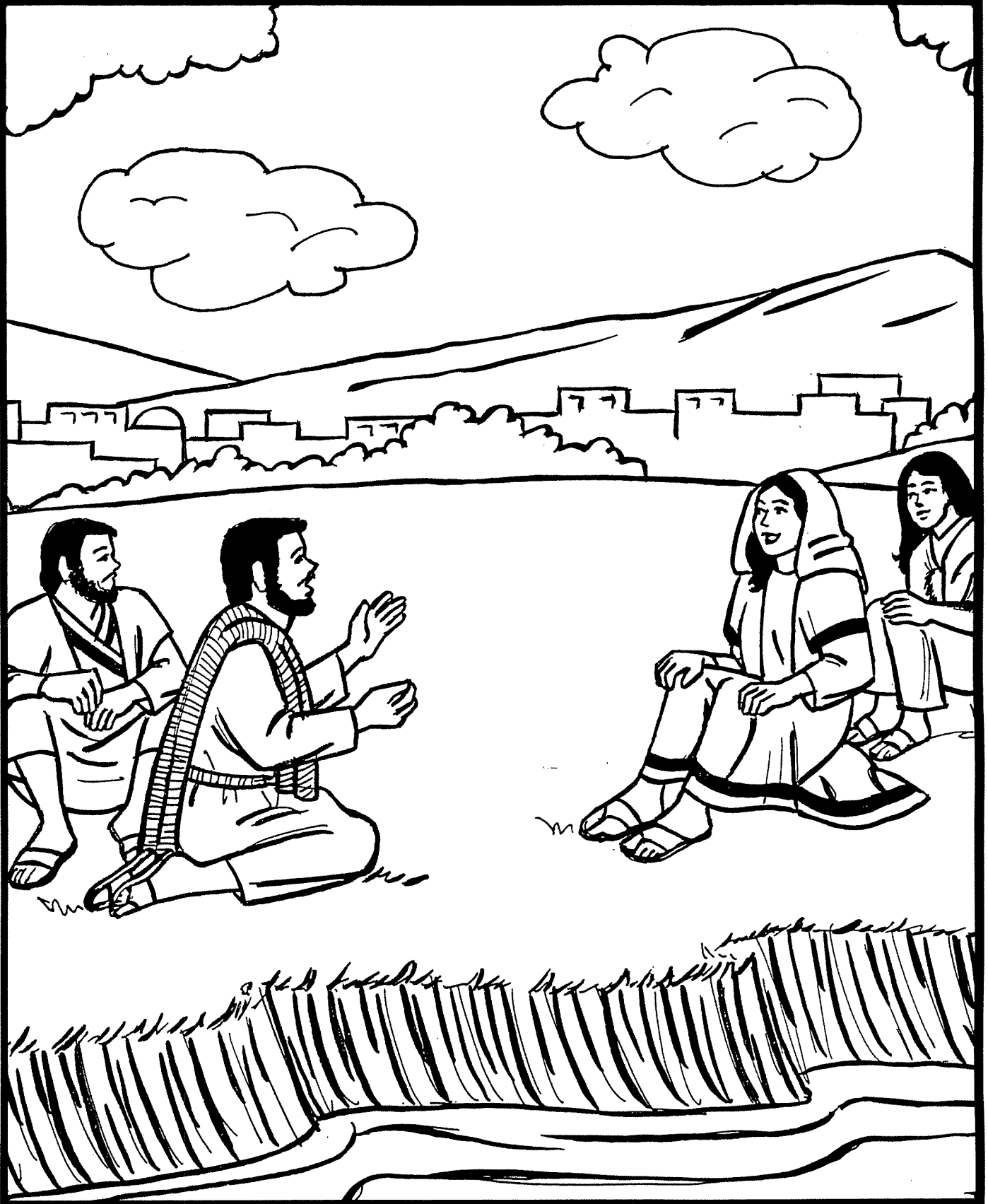

## 265. PAUL IS ARRESTED IN THE TEMPLE (ACTS 21:26-22:29)

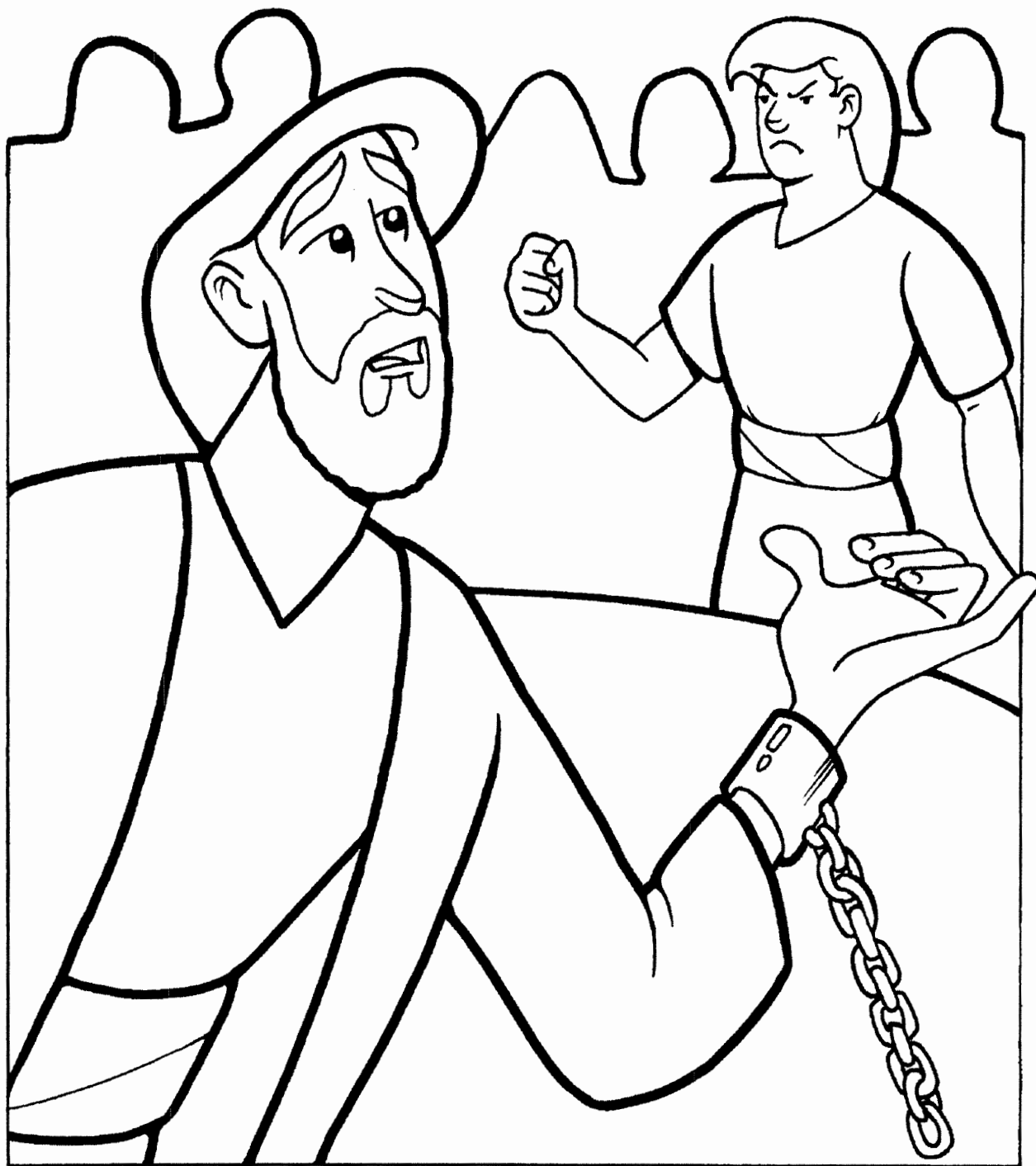

"And all the city was moved, and the people ran together: and they took Paul, and drew him out of the temple: and forthwith the doors were shut."

**ACTS 21:30**

# 265. PAUL IS ARRESTED IN THE TEMPLE

(ACTS 21:26-22:29)

T B E A T I N G G L S N C K O  
 E G R E E K S T F A M O I F A  
 S L H D W A J E W S C B T S T  
 T W U D K V Y V K P Z O I R M  
 I J R E D N A M M O C F Z E Z  
 M U E O I D Y R D P L F E I J  
 O O C J E S U S B A U E N D E  
 N E N K J Q D F K B T R P L L  
 Y D E T U C E S R E P I M O P  
 P P N A M O R E K V M N C S M  
 E T D E I F I R U P O G C K E  
 V C Q Q S E J J A Q L U A S T  
 C E N T U R I O N S E U V S S  
 A S L K U N I O T D M L U A P  
 R C K L E R P U W V B L Z M M

BEATING  
 CENTURIONS  
 CITIZEN  
 COMMANDER  
 GREEKS  
 JESUS

JEWS  
 OFFERING  
 PAUL  
 PERSECUTED  
 PURIFIED

ROMAN  
 SAUL  
 SOLDIERS  
 TEMPLE  
 TESTIMONY

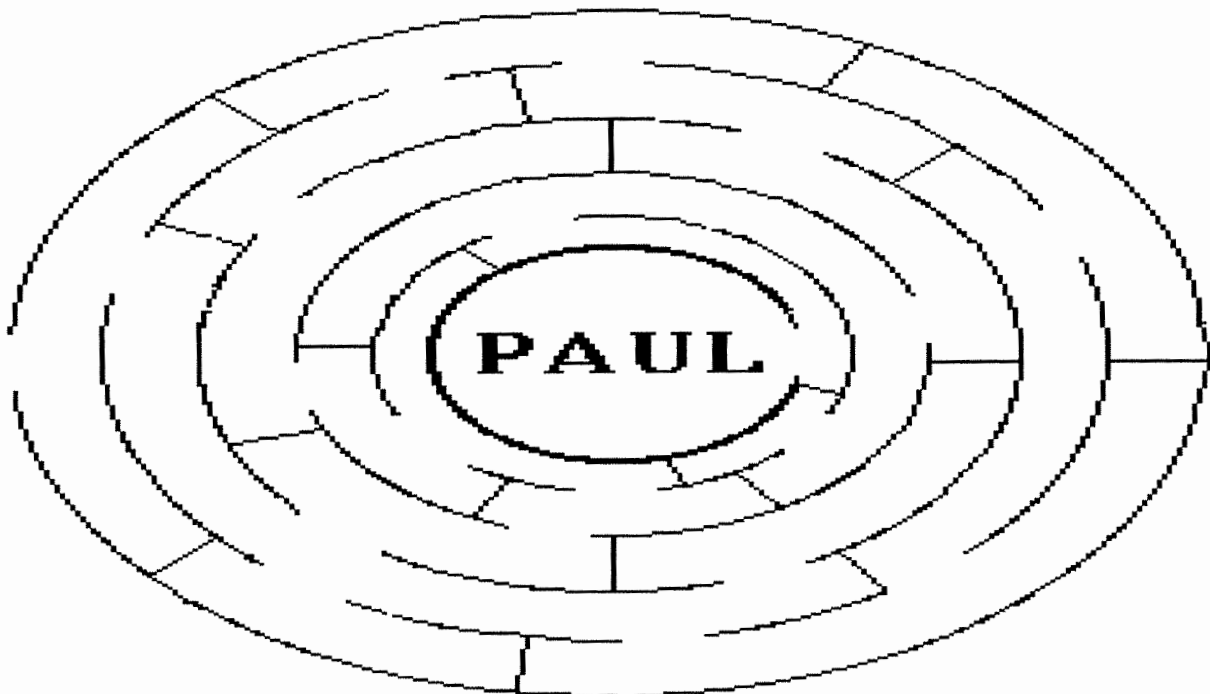

# 265. PAUL IS ARRESTED IN THE TEMPLE

## (ACTS 21:26-22:29)

### MEMORY VERSE:

*"Blessed are you when they revile and persecute you, and say all kinds of evil against you falsely for My sake. Rejoice and be exceedingly glad, for great is your reward in heaven, for so they persecuted the prophets who were before you."* MATTHEW 5:10-11

### FILL IN THE BLANK:

1. "Paul took the men, and the next day, having been purified with them, entered the \_\_\_\_\_."  
ACTS 21:26

### TRUE OR FALSE:

2. "The Jews from Asia, seeing him in the temple, stirred up the whole crowd and laid hands on him." ACTS 21:27  
TRUE OR FALSE
3. And all the city was happy; and the people ran to welcome Paul to the temple. ACTS 21:30  
TRUE OR FALSE

### FILL IN THE BLANKS:

4. "Now as they were seeking to \_\_\_\_\_ him, news came to the commander of the garrison that all Jerusalem was in an uproar." ACTS 21:31
5. "He immediately took soldiers and centurions, and ran down to them. And when they saw the commander and the soldiers, they stopped \_\_\_\_\_ Paul." ACTS 21:32
6. "Paul said, 'I am a Jew from Tarsus, in Cilicia, a citizen of no mean city; and I implore you, permit me to \_\_\_\_\_ to the people.'" ACTS 21:39

### TRUE OR FALSE:

7. "And they listened to him until this word, and then they raised their voices and said, 'Away with such a fellow from the earth, for he is not fit to live!' " ACTS 22:22  
TRUE OR FALSE
8. "As they bound him with thongs, Paul said to the centurion who stood by, 'Is it lawful for you to scourge a man who is a Roman, and uncondemned?' " ACTS 22:25  
TRUE OR FALSE

### FILL IN THE BLANKS:

9. "Then immediately those who were about to examine him withdrew from him; and the commander was also \_\_\_\_\_ after he found out that he was a Roman, and because he had \_\_\_\_\_ him."  
ACTS 22:29

# 265. PAUL IS ARRESTED IN THE TEMPLE

## (ACTS 21:26-22:29)

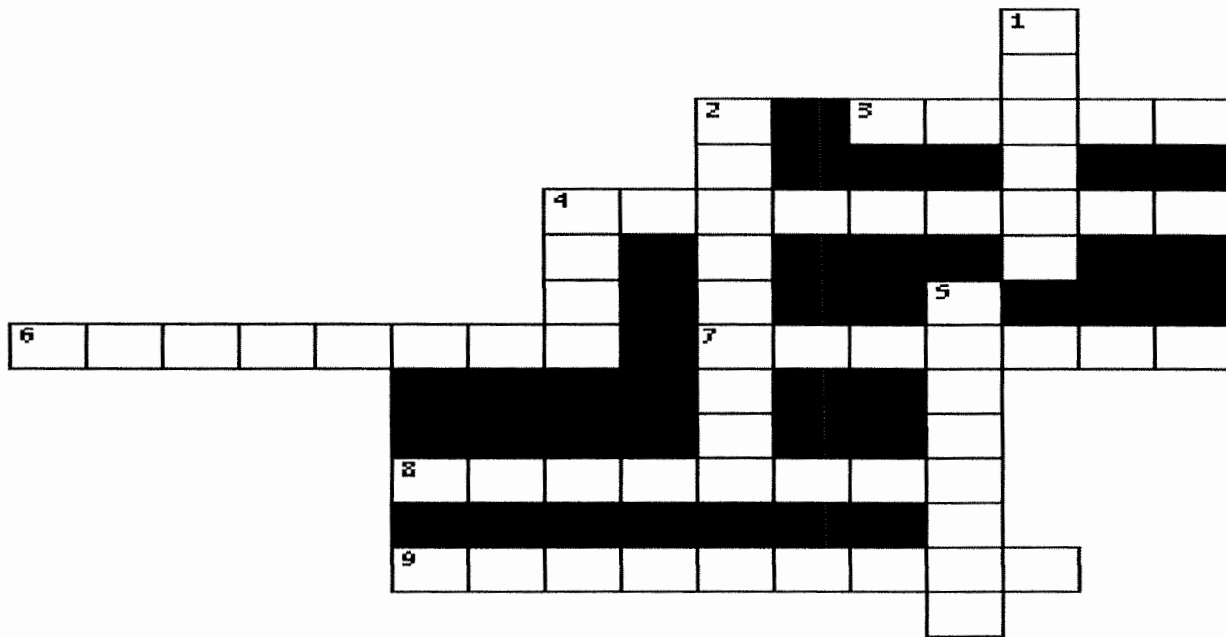

- 2 DOWN "Blessed are you when they revile and \_\_\_\_\_ you, and say all kinds of evil against you falsely for My sake." **MATTHEW 5:10**
- 1 DOWN "Paul took the men, and the next day, having been purified with them, entered the \_\_\_\_\_." **ACTS 21:26**
- 4 DOWN "The \_\_\_\_\_ from Asia, seeing him in the temple, stirred up the whole crowd and laid hands on him." **ACTS 21:27**
- 9 ACROSS "And all the city was \_\_\_\_\_." **ACTS 21:30**
- 4 ACROSS "Now as they were seeking to kill him, news came to the commander of the garrison that all \_\_\_\_\_ was in an uproar." **ACTS 21:31**
- 6 ACROSS "He immediately took soldiers and centurions, and ran down to them. And when they saw the commander and the \_\_\_\_\_, they stopped beating Paul." **ACTS 21:32**
- 7 ACROSS "Paul said, 'I am a Jew from Tarsus, in Cilicia, a \_\_\_\_\_ of no mean city; and I implore you, permit me to speak to the people.'" **ACTS 21:39**
- 8 ACROSS "And they \_\_\_\_\_ to him until this word, and then they raised their voices and said, 'Away with such a fellow from the earth, for he is not fit to live!'" **ACTS 22:22**
- 3 ACROSS "As they bound him with thongs, Paul said to the centurion who stood by, 'Is it lawful for you to scourge a man who is a \_\_\_\_\_, and uncondemned?'" **ACTS 22:25**
- 5 DOWN "Then immediately those who were about to examine him \_\_\_\_\_ from him; and the commander was also afraid after he found out that he was a Roman, and because he had bound him." **ACTS 22:29**



## Year 3

### Week 155

#### Paul's Trial, Shipped to Rome

**Scriptures:** Acts 24:1-23, 25:1-12, 26: 1-32

**Key Verse:** Acts 27:23,24 "For there stood by me this night an angel of the God to whom I belong and whom I serve, "saying, 'Do not be afraid, Paul; you must be brought before Caesar; and indeed God has granted you all those who sail with you.'

**Key Points:**

1. Paul speaks before the Sanhedrin to defend himself. There was an uproar again, many arguing vigorously. It became so violent they took Paul to the barracks for fear he would be torn to pieces. They were angry because of Paul's teaching of the resurrection of the dead.
2. Forty men formed a plot to kill Paul. They vowed not to eat until he was dead. The son of Paul's sister heard about the plot and told the commander. The commander told him to keep it silent then sent 200 soldiers to take Paul safely to the Governor.
3. Paul was put on trial before Felix, the governor. After listening to Paul he adjourned the trial but he and his wife Drusilla met with Paul again. They listened to his faith in Jesus but it frightened Felix. He left Paul in prison for 2 years until his successor, Festus, came into power
4. Paul appears before Governor Festus and King Agrippa. He was happy to be able to speak for himself concerning the things he was accused of. He testifies how the Lord came to him on the road to Damascus and sent him out to teach to the Gentiles. When he spoke about Christ's resurrection, it made them angry again. Festus accused him of being mad. Paul told him he was not mad, but speaking truth and reason. He knew he had made an impression on King Agrippa and Paul ask him if he believed. Agrippa said that Paul almost persuaded him to be a Christian. They all got up and left, talking among themselves that Paul had done nothing worthy of death. Agrippa grants his request to appeal to Ceasar and Paul is shipped to Rome.

# BibleWise

## Discussion Questions – Paul’s Trials

Read Acts 23:12-33; 25; 26

- Who were the three individuals that tried Paul at different times?
- Who was Felix?
- What was the charge against Paul?
- Did Felix free Paul?
- Who was Festus?
- What was Paul accused of this time?
- Who was the king who visited Festus?
- Who was Bernice?
- What events of his life does Paul recount to King Agrippa?
- What was King Agrippa’s response?



"Paul is sent to Felix."  
Acts 23:23-24:27

## Paul Before the Governors

Read the Bible story at <http://gardenofpraise.com/bibl73s.htm>

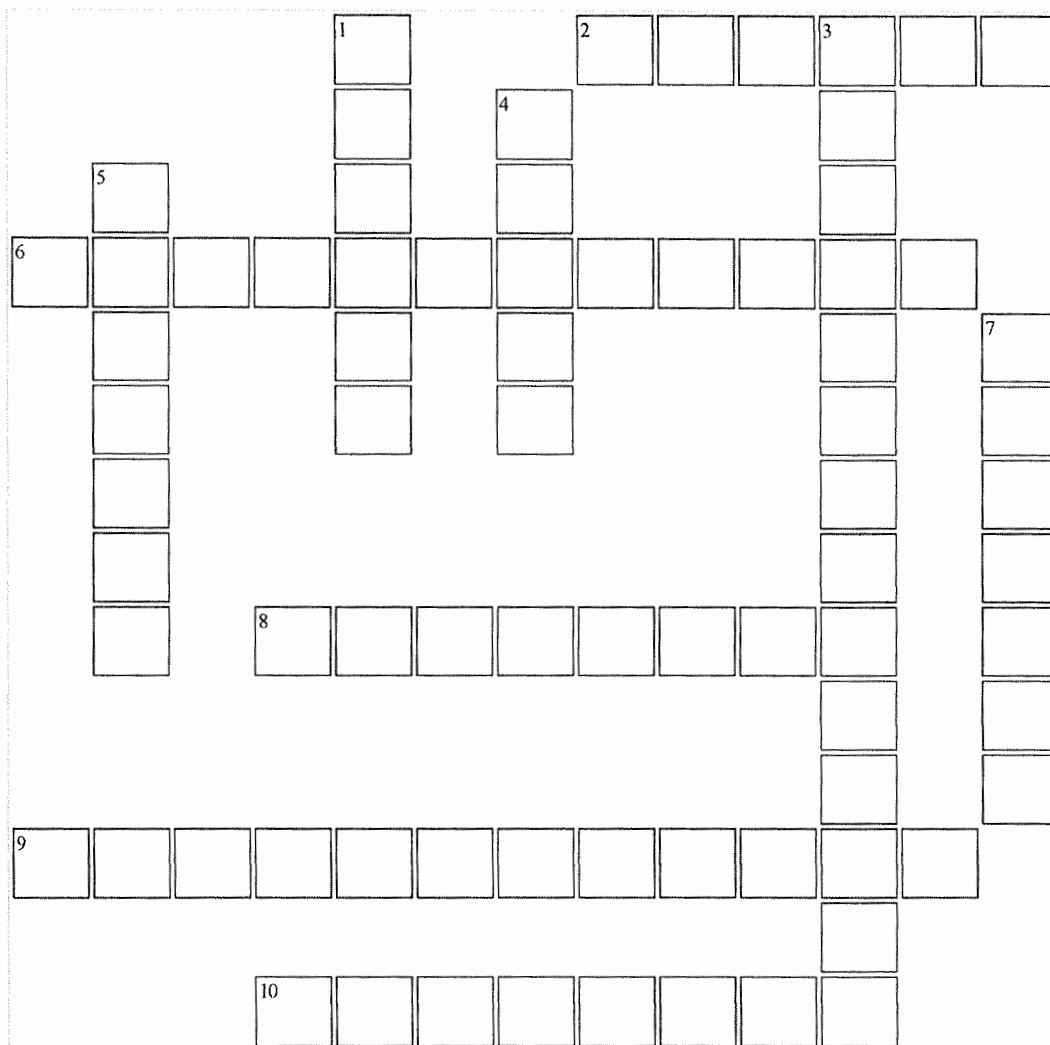

### Across

- 2. the Roman governor after Felix
- 6. Tertullus was a \_\_\_\_.
- 8. It was God's plan for Paul to \_\_\_\_.
- 9. Festus accused Paul of talking like an \_\_\_\_.
- 10. the length of Paul's prison term

### Down

- 1. Paul appealed to \_\_\_\_.
- 3. Paul appeared before \_\_\_\_.
- 4. a Roman governor
- 5. wife of King Agrippa
- 7. If Paul had not appealed he would have been \_\_\_\_.

WORD BANK: THREE GOVERNORS, FELIX, JEWISH LAWYER, TWO YEARS, FESTUS, CAESAR, BERNICE, INSANE PERSON, SET FREE, GO TO ROME

# 266. PAUL IS SENT TO FELIX

(ACTS 23:23-24:27)

S	A	C	C	U	S	E	R	S	E	T	G	A	B	F
P	H	S	K	R	T	C	D	K	N	W	F	T	V	E
E	Q	J	S	L	C	N	D	I	R	O	K	W	A	L
A	O	H	U	W	S	Q	O	J	Y	Y	P	L	I	I
R	A	N	E	M	E	S	R	O	H	E	R	A	R	X
M	W	P	A	U	L	W	K	S	Y	A	O	P	A	C
E	V	Q	H	J	C	A	Q	U	D	R	P	S	S	A
N	M	O	P	U	H	L	K	E	J	S	H	A	E	L
V	S	N	O	I	R	U	T	N	E	C	E	I	A	L
T	F	E	E	O	U	L	L	A	I	R	T	N	C	I
W	S	R	O	N	R	E	V	O	G	F	S	A	Q	S
H	W	W	V	E	F	A	I	T	H	E	D	N	D	U
S	O	L	D	I	E	R	S	V	P	J	B	A	V	R
P	U	E	A	P	E	K	W	D	T	O	K	P	S	D
J	D	B	D	N	U	O	B	Q	V	U	K	A	M	Z

ACCUSERS  
ANANIAS  
BOUND  
CAESARIA  
CENTURIONS  
DRUSILLA

FAITH  
FELIX  
GOVERNOR  
HORSEMEN  
LAW

PAUL  
PROPHETS  
SOLDIERS  
SPEARMEN  
TWO YEARS

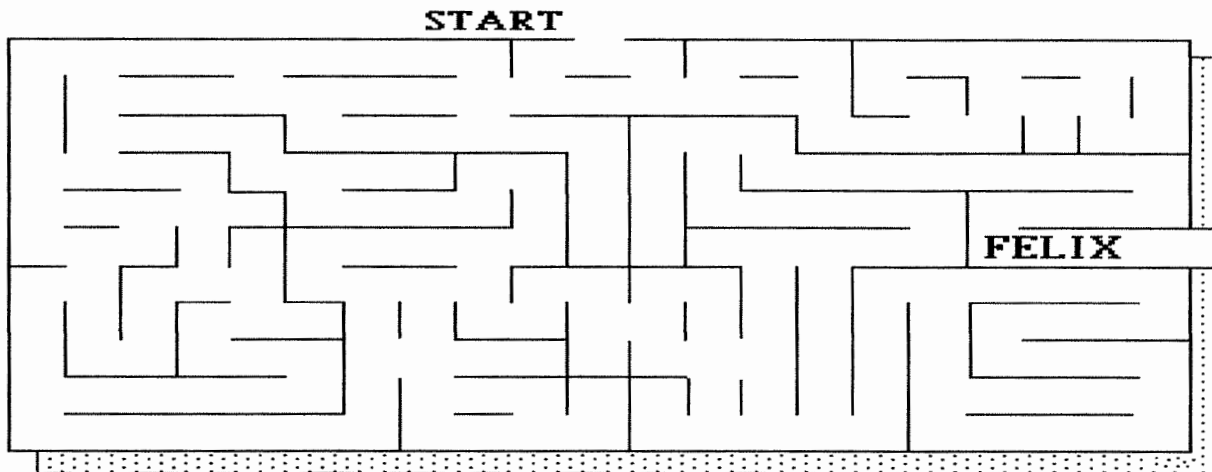

## 266. PAUL IS SENT TO FELIX (ACTS 23:23-24:27)

### MEMORY VERSE:

*"But watch out for yourselves, for they will deliver you up to councils, and you will be beaten in the synagogues. And you will be brought before rulers and kings for My sake, for a testimony to them."* MARK 13:9

### TRUE OR FALSE:

1. "Then the soldiers, as they were commanded, took Paul and brought him by night to Antipatris." ACTS 23:31  
TRUE OR FALSE
2. "When they came to Caesarea and had delivered the letter to the governor, they also presented Paul to him." ACTS 23:33  
TRUE OR FALSE

### FILL IN THE BLANKS:

3. "Now after five days Ananias the high priest came down with the elders and a certain orator named Tertullus. These gave \_\_\_\_\_ to the governor against Paul." ACTS 24:1
4. "For we have found this man a \_\_\_\_\_, a creator of dissension among all the Jews throughout the world, and a ringleader of the sect of the Nazarenes." ACTS 24:5
5. "For this I confess to you, that according to the Way which they call a sect, so I worship the God of my fathers, believing \_\_\_\_\_ things which are written in the Law and the Prophets." ACTS 24:14

### TRUE OR FALSE:

6. "Now as he reasoned about righteousness, self-control, and the judgment to come, Felix was afraid and answered, 'Go away for now; when I have a convenient time I will call for you.'" ACTS 24:25  
TRUE OR FALSE
7. But after two years Porcius Festus succeeded Felix; and Felix, wanting to do the Jews a favor, let Paul go. ACTS 24:27  
TRUE OR FALSE

## 266. PAUL IS SENT TO FELIX (ACTS 23:23-24:27)

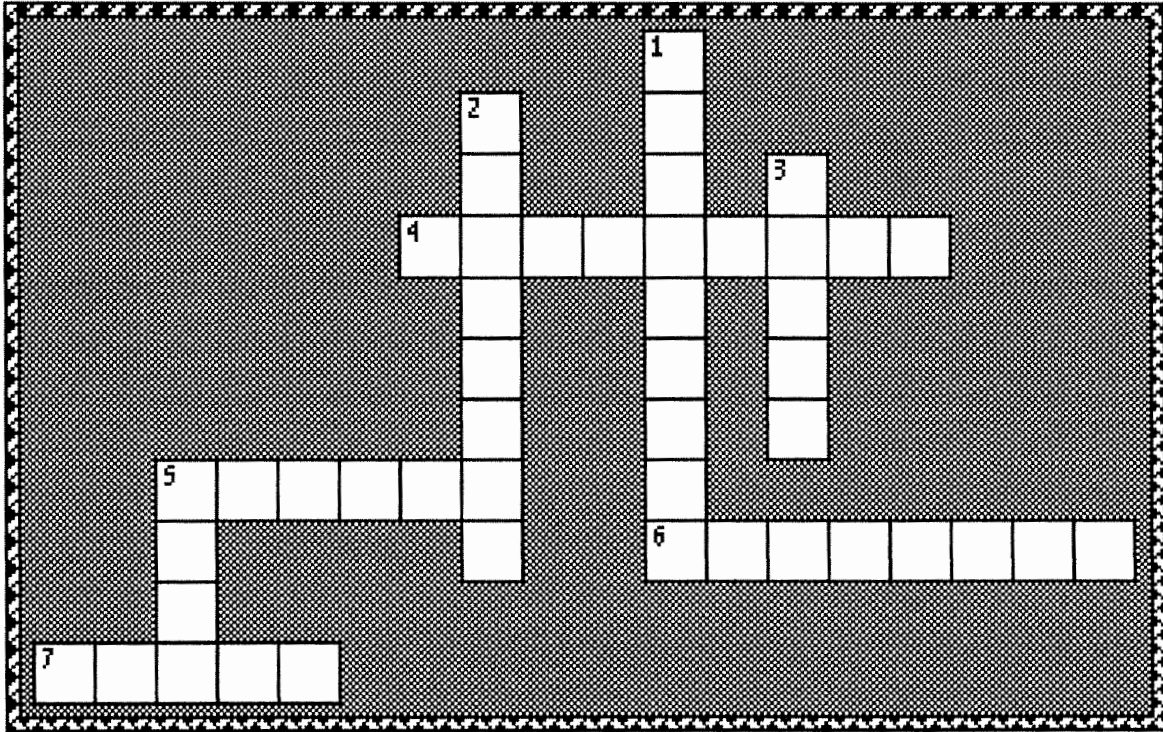

- 4 ACROSS "But watch out for yourselves, for they will deliver you up to councils, and you will be beaten in the synagogues. And you will be brought before rulers and kings for My sake, for a \_\_\_\_\_ to them." **MARK 13:9**
- 5 DOWN "Then the soldiers, as they were commanded, took \_\_\_\_\_ and brought him by night to Antipatris." **ACTS 23:31**
- 2 DOWN "When they came to \_\_\_\_\_ and had delivered the letter to the governor, they also presented Paul to him." **ACTS 23:33**
- 6 ACROSS "Now after five days Ananias the high priest came down with the elders and a certain orator named Tertullus. These gave evidence to the \_\_\_\_\_ against Paul." **ACTS 24:1**
- 5 ACROSS "For we have found this man a \_\_\_\_\_, a creator of dissension among all the Jews throughout the world, and a ringleader of the sect of the Nazarenes." **ACTS 24:5**
- 1 DOWN "For this I confess to you, that according to the Way which they call a sect, so I worship the God of my fathers, \_\_\_\_\_ all things which are written in the Law and the Prophets." **ACTS 24:14**
- 7 ACROSS "Now as he reasoned about righteousness, self-control, and the judgment to come, \_\_\_\_\_ was afraid and answered, 'Go away for now; when I have a convenient time I will call for you.'" **ACTS 24:25**
- 3 DOWN "But after two years Porcius Festus succeeded Felix; and Felix, wanting to do the Jews a favor, left Paul \_\_\_\_\_." **ACTS 24:27**



"Paul is brought before King Agrippa."  
Acts 25:13-26:32



## 267. PAUL GOES BEFORE AGRIPPA (ACTS 25:13-26:32)

### MEMORY VERSE:

*"Then Agrippa said to Paul, 'You almost persuade me to become a Christian.' "*  
ACTS 26:28

### TRUE OR FALSE:

1. "And after some days King Agrippa and Bernice came to Caesarea to greet Festus."  
ACTS 25:13

TRUE OR FALSE

2. "So the next day, when Agrippa and Bernice had come with great pomp, and had entered the auditorium with the commanders and the prominent men of the city, at Festus' command Paul was brought in." ACTS 25:23

TRUE OR FALSE

### FILL IN THE BLANKS:

3. "Then Agrippa said to Paul, 'You are permitted to speak for \_\_\_\_\_.' So Paul stretched out his hand and answered for himself." ACTS 26:1
4. "Now as he thus made his defense, Festus said with a loud voice, 'Paul, you are beside yourself! Much learning is driving you \_\_\_\_\_!' " ACTS 26:24
5. "But he said, 'I am not mad, most noble Festus, but speak the words of \_\_\_\_\_ and reason.' " ACTS 26:25

### TRUE OR FALSE:

6. "Then Agrippa said to Paul, 'You almost persuade me to become a Christian.' " ACTS 26:28

TRUE OR FALSE

### FILL IN THE BLANKS:

7. "And Paul said, 'I would to God that not only you, but also all who hear me today, might become both almost and altogether such as I am, except for these \_\_\_\_\_.' " ACTS 26:29
8. "Then Agrippa said to Festus, 'This man might have been set \_\_\_\_\_ if he had not appealed to Caesar.' " ACTS 26:32

# 267. PAUL GOES BEFORE AGRIPPA

## (ACTS 25:13-26:32)

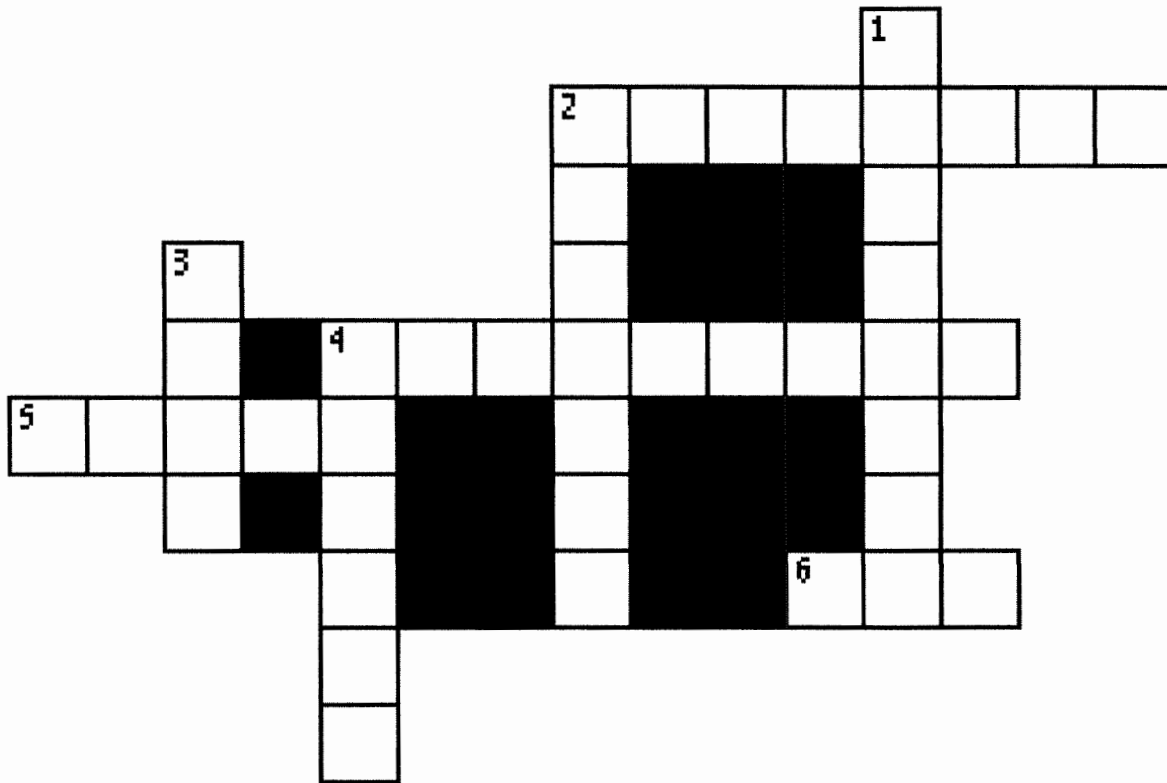

- 1 DOWN "And after some days King Agrippa and Bernice came to \_\_\_\_\_ to greet Festus." **ACTS 25:13**
- 3 DOWN "So the next day, when Agrippa and Bernice had come with great pomp, and had entered the auditorium with the commanders and the prominent men of the city, at Festus' command \_\_\_\_\_ was brought in." **ACTS 25:23**
- 2 DOWN "Then \_\_\_\_\_ said to Paul, 'You are permitted to speak for yourself.' So Paul stretched out his hand and answered for himself." **ACTS 26:1**
- 6 ACROSS "Now as he thus made his defense, Festus said with a loud voice, 'Paul, you are beside yourself! Much learning is driving you \_\_\_\_\_!'" **ACTS 26:24**
- 5 ACROSS "But he said, 'I am not mad, most noble Festus, but speak the words of \_\_\_\_\_ and reason.'" **ACTS 26:25**
- 4 ACROSS "Then Agrippa said to Paul, 'You almost persuade me to become a \_\_\_\_\_.'" **ACTS 26:28**
- 4 DOWN "And Paul said, 'I would to God that not only you, but also all who hear me today, might become both almost and altogether such as I am, except for these \_\_\_\_\_.'" **ACTS 26:29**
- 2 ACROSS "Then Agrippa said to Festus, 'This man might have been set free if he had not \_\_\_\_\_ to Caesar.'" **ACTS 26:32**

**Scriptures: Acts 27**

**Key Verse: Acts 27:23, 24**

**"For there stood by me this night an angel of the God to whom I belong and whom I serve, saying, 'Do not be afraid, Paul; you must be brought before Caesar; and indeed God has granted you all those who sail with you.'"**

**Key Points:**

1. Paul sent sail to Rome under guard along with several other prisoners. At their first stop at Myra, Paul was allowed to go to friends there who ministered to him.
2. Setting sail again on another ship, they sailed slowly for many days. The weather became very difficult and dangerous. They came to the harbor of Fair Havens and rested there. After days of fasting, Paul advised them that disaster would come to them with much loss to the cargo if they went on, but they did not listen to him. They set sail again, not wanting to spend the winter there.
3. The weather again became very dangerous and the ship was difficult to manage. For fear of running aground, they had to lighten the ship by throwing the tackle overboard.
4. The ship was caught by a ferocious storm and there was no sight of sun or stars for many days. The crew gave up hope that they would be saved, but Paul spoke to them again, telling them that an angel appeared to him, promising him he would make it to Rome and appear before Caesar.
5. Coming close to land they dropped anchors fearing the ship would be broken up by the rocks. The sailors planned to escape from the ship but Paul warned them unless they stayed on the ship they would not be saved.
6. On day fourteen, Paul urges the soldiers to eat for they had not eaten. He promises them that not a hair on their head would be harmed. They ate and when morning came the ship ran aground. The soldiers planned to kill all the prisoners before they escape. But the centurion wanted to save Paul's life and he kept them from carrying out their plan. Everyone reached land safely.

# BibleWise

## Discussion Questions – Paul’s Shipwreck

Read Acts 27

- Why did Paul tell his fellow passengers to be of good cheer?
- What happened to the ship?
- Why did the soldiers think they should kill Paul and the other prisoners?
- How did everyone escape?
- What was the name of the island to which they escaped?
- What happened when they built a fire?
- Why did the people think Paul was a god?
- Where was Paul headed when his ship broke apart?
- Why was he a prisoner?
- What did he recommend the guards do instead of kill everyone?
- What kind of respect did the guard have for Paul?
- Why was Paul so confident?
- After reading these stories, describe Paul’s character.
  - What stands out to you about Paul?
  - Would you want Paul for a friend? Why or why not?
- Think about Paul’s transformation.
  - When Jesus called the sinners to repent, he was asking them to change their thinking and the way they lived their lives. Paul appeared to take a U-Turn with his life.
  - Describe Paul’s transformation.
  - What does his transformation say to us?

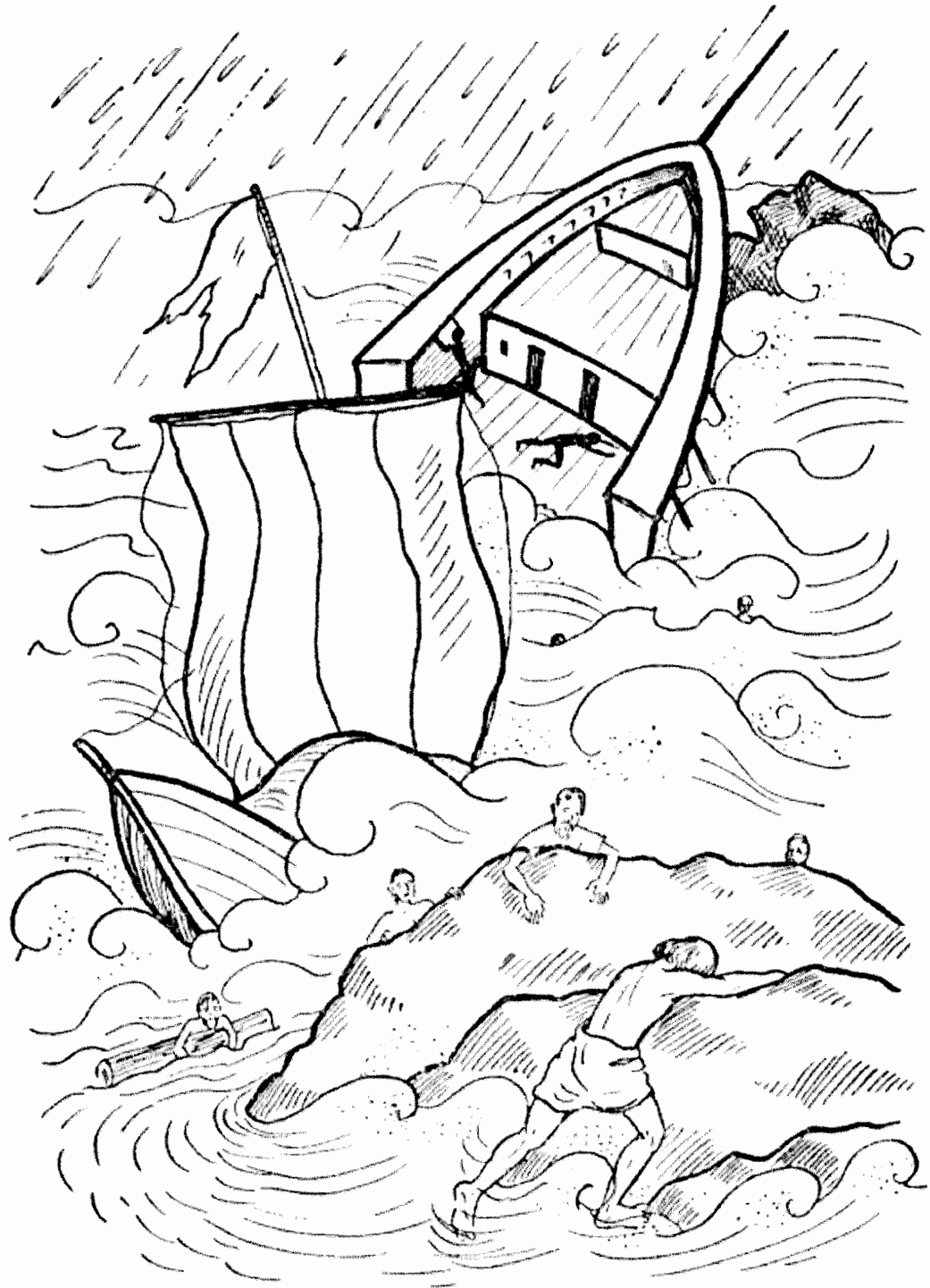

**They had to endure many hardships. Paul was shipwrecked on Malta during one of his missionary journeys.**

# Ship- wrecked!

Paul was a prisoner on a ship going to Rome. He was going to be judged by Caesar, the top man in the Roman government. Paul told the ship captain that he should not sail because it was the time of year for storms, but the captain did not listen to him. Sure enough, the ship got caught in a terrible storm. All 276 people on the ship thought they were going to die. But an angel of the Lord came to Paul in a dream and gave him a message for all the sailors and prisoners on the ship.

What was the message? To find out, untangle the pieces of the wrecked ship. Match each shape with the shapes at the bottom of the page to put the words in order.

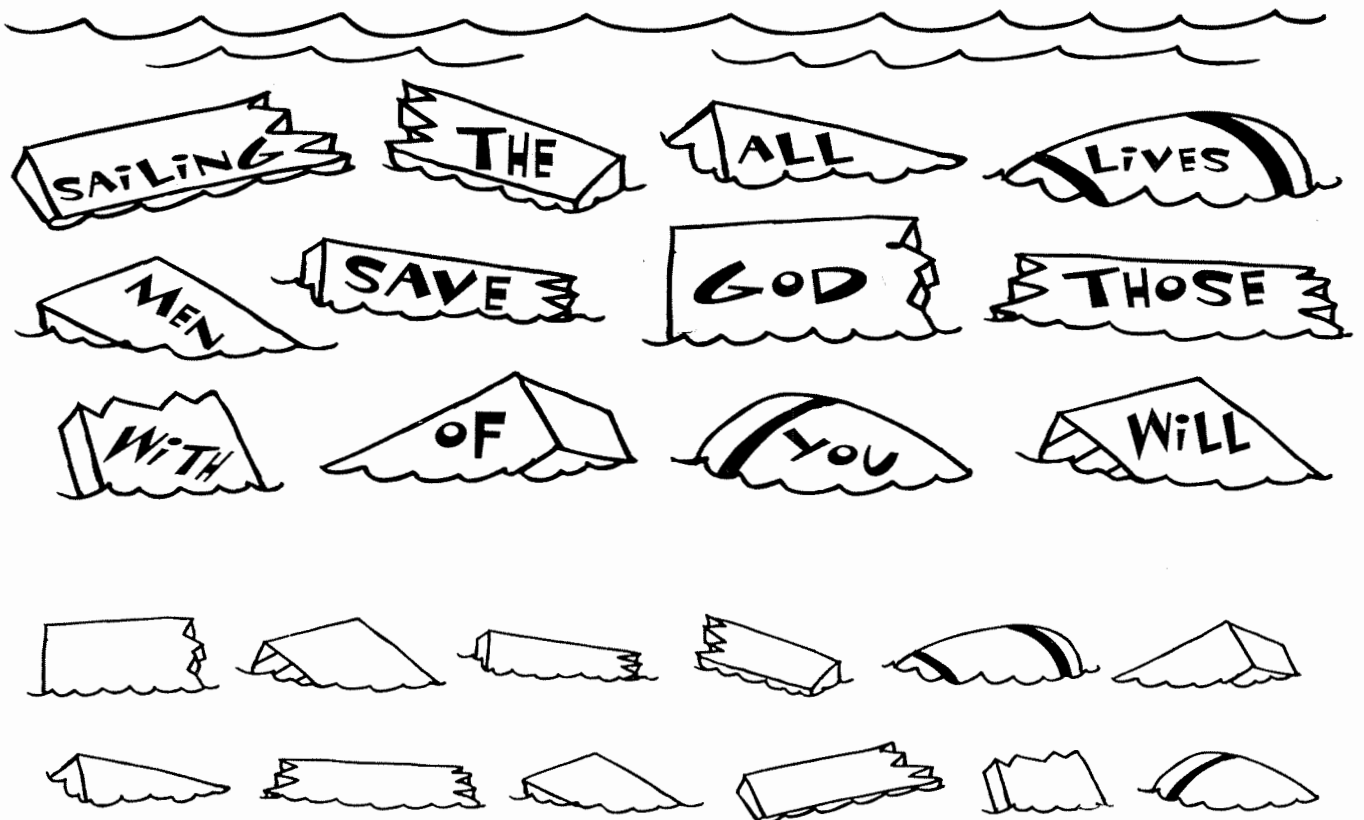

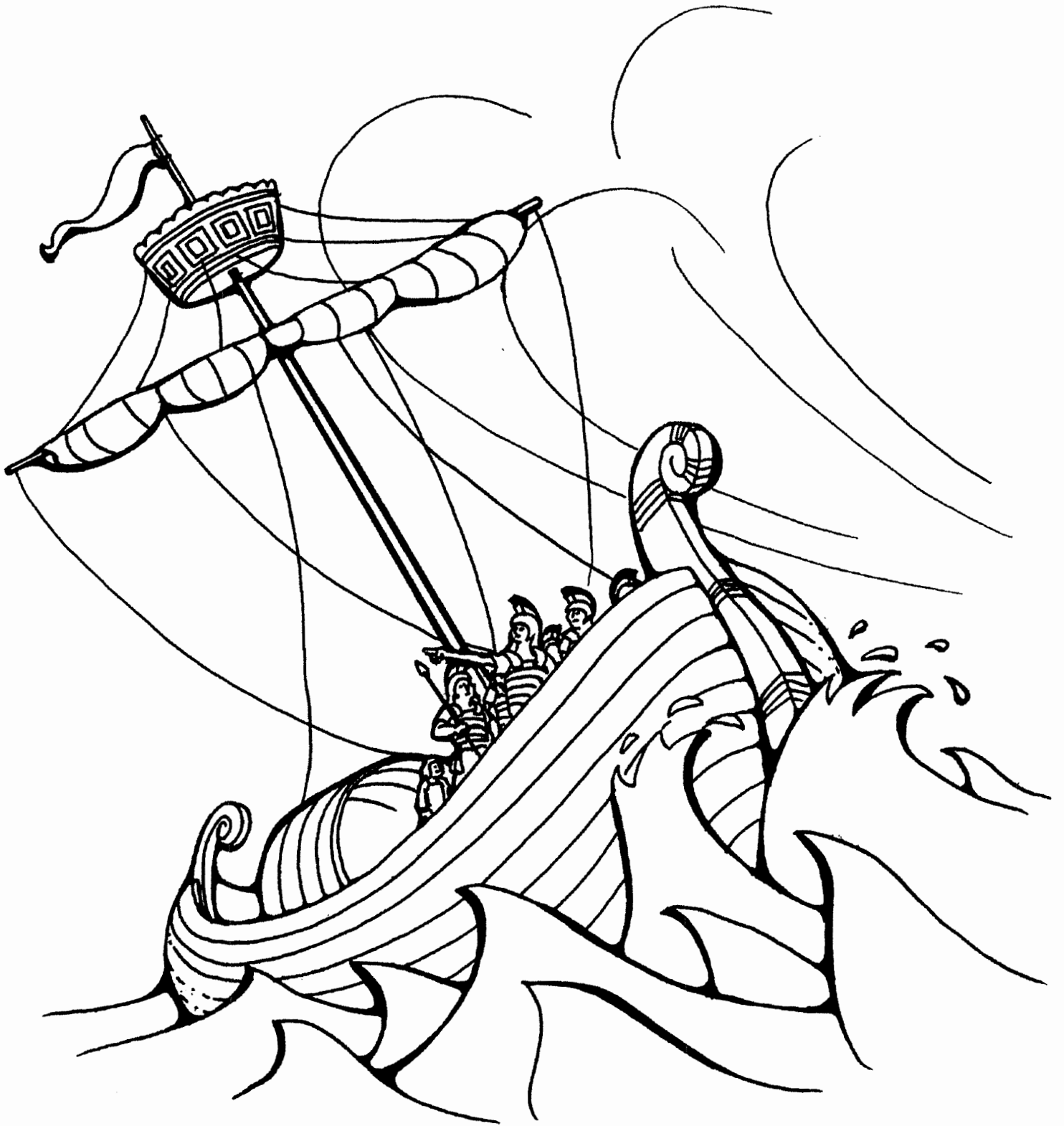

"Paul begins his voyage aboard a ship bound for Rome."  
*Acts 27:1-12*

# 268. VOYAGE TO ROME

(ACTS 27:1-12)

D	P	Y	S	W	W	W	Y	G	F	P	R	L	K	A
I	I	Y	H	L	D	S	B	N	L	G	C	B	P	E
S	Q	O	M	Z	W	U	E	G	L	K	M	B	Y	R
A	D	F	B	B	Y	F	D	A	R	B	S	A	T	A
S	J	S	U	O	R	E	G	N	A	D	A	C	R	C
T	Q	V	S	P	P	I	R	Z	S	U	I	W	E	H
E	R	B	V	J	Z	B	C	J	Z	K	L	J	B	A
R	I	S	O	H	W	G	P	I	H	S	E	U	I	H
I	N	O	I	R	U	T	N	E	C	C	D	K	L	Z
O	L	V	J	G	Y	L	A	T	I	U	Y	O	Z	Y
T	S	S	U	I	L	U	J	P	F	B	L	I	Y	S
A	T	M	J	E	B	Y	G	N	D	D	D	T	Y	I
P	R	I	S	O	N	E	R	S	N	L	N	E	O	D
N	F	A	E	U	M	P	R	U	I	S	I	J	J	O
R	A	Z	A	L	U	A	P	O	W	V	K	K	F	N

CARE  
CENTURION  
DANGEROUS  
DISASTER  
ITALY

JULIUS  
KINDLY  
LIBERTY  
PAUL  
PRISONERS

SAILED  
SEA  
SHIP  
SIDON  
WIND

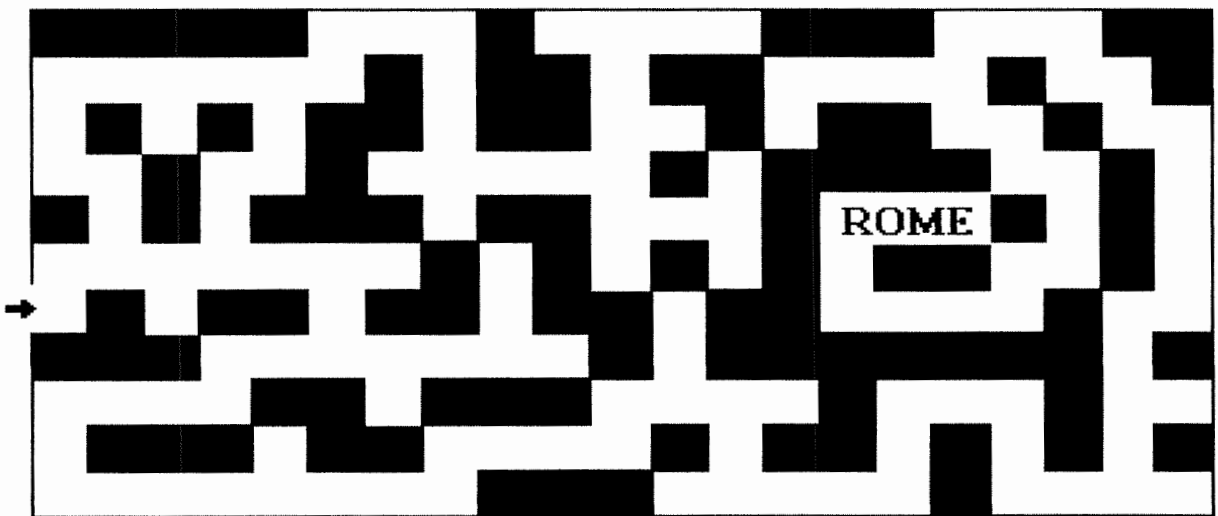



## 268. VOYAGE TO ROME

### (ACTS 27:1-12)

#### MEMORY VERSE:

*"But none of these things move me; nor do I count my life dear to myself, so that I may finish my race with joy, and the ministry which I received from the Lord Jesus, to testify to the gospel of the grace of God."* ACTS 20:24

#### TRUE OR FALSE:

1. "And when it was decided that we should sail to Italy, they delivered Paul and some other prisoners to one named Julius, a centurion of the Augustan Regiment." ACTS 27:1  
TRUE OR FALSE
2. Julius treated Paul without kindness and gave him no liberty to go to his friends and receive care. ACTS 27:3  
TRUE OR FALSE
3. "There the centurion found an Alexandrian ship sailing to Italy, and he put us on board." ACTS 27:6  
TRUE OR FALSE

#### FILL IN THE BLANKS:

4. "Now when much time had been spent, and sailing was now \_\_\_\_\_ because the Fast was already over, Paul advised them." ACTS 27:9
5. "...saying, 'Men, I perceive that this voyage will end with \_\_\_\_\_ and much loss, not only of the cargo and ship, but also our lives.'" ACTS 27:10

#### TRUE OR FALSE:

6. Nevertheless the centurion was more persuaded by Paul than by the things spoken by the helmsman and the owner of the ship. ACTS 27:11  
TRUE OR FALSE

#### FILL IN THE BLANK:

7. "And because the \_\_\_\_\_ was not suitable to winter in, the majority advised to set sail from there also, if by any means they could reach Phoenix, a harbor of Crete opening toward the southwest and northwest, and winter there." ACTS 27:12

## 268. VOYAGE TO ROME

(ACTS 27:1-12)

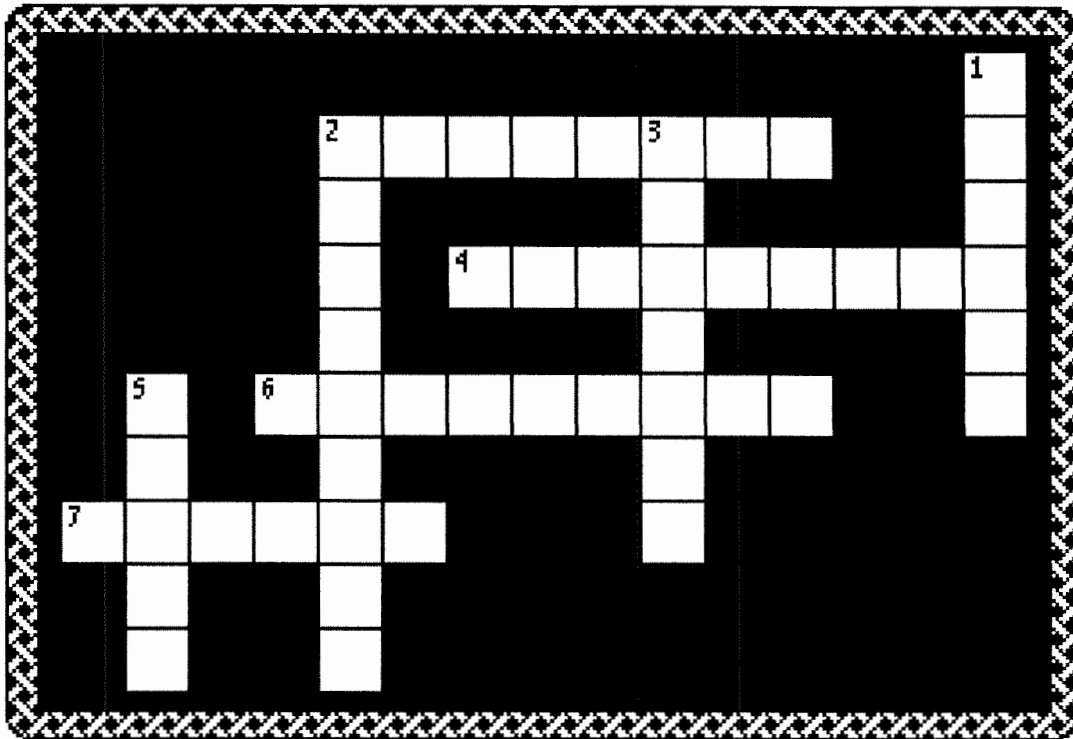

- 3 DOWN "But none of these things move me; nor do I count my life dear to myself, so that I may finish my race with joy, and the ministry which I received from the Lord Jesus, to \_\_\_\_\_ to the gospel of the grace of God." **ACTS 20:24**
- 6 ACROSS "And when it was decided that we should sail to Italy, they delivered Paul and some other prisoners to one named Julius, a \_\_\_\_\_ of the Augustan Regiment." **ACTS 27:1**
- 1 DOWN "...Julius treated Paul \_\_\_\_\_ and gave him liberty to go to his friends and receive care." **ACTS 27:3**
- 5 DOWN "There the centurion found an Alexandrian ship sailing to \_\_\_\_\_, and he put us on board." **ACTS 27:6**
- 2 DOWN "Now when much time had been spent, and sailing was now \_\_\_\_\_ because the Fast was already over, Paul advised them..." **ACTS 27:9**
- 2 ACROSS "...saying, 'Men, I perceive that this voyage will end with \_\_\_\_\_ and much loss, not only of the cargo and ship, but also our lives.'" **ACTS 27:10**
- 4 ACROSS "Nevertheless the centurion was more \_\_\_\_\_ by the helmsman and the owner of the ship than by the things spoken by Paul." **ACTS 27:11**
- 7 ACROSS "And because the \_\_\_\_\_ was not suitable to winter in, the majority advised to set sail from there also, if by any means they could reach Phoenix, a harbor of Crete opening toward the southwest and northwest, and winter there." **ACTS 27:12**

# Paul's Shipwreck

(Craft Page)

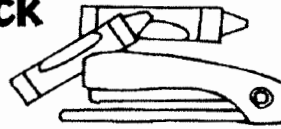

## Put Paul in the Ship

The children can place Paul aboard and carry this ship home to retell the story.

**Materials needed:** photocopies of this craft page, crayons, scissors, staples

**Directions:** Let the children color the ship and Paul and cut them out along the bold lines. Then they fold their ships on the dotted lines and staple them as shown. Last, they can insert Paul.

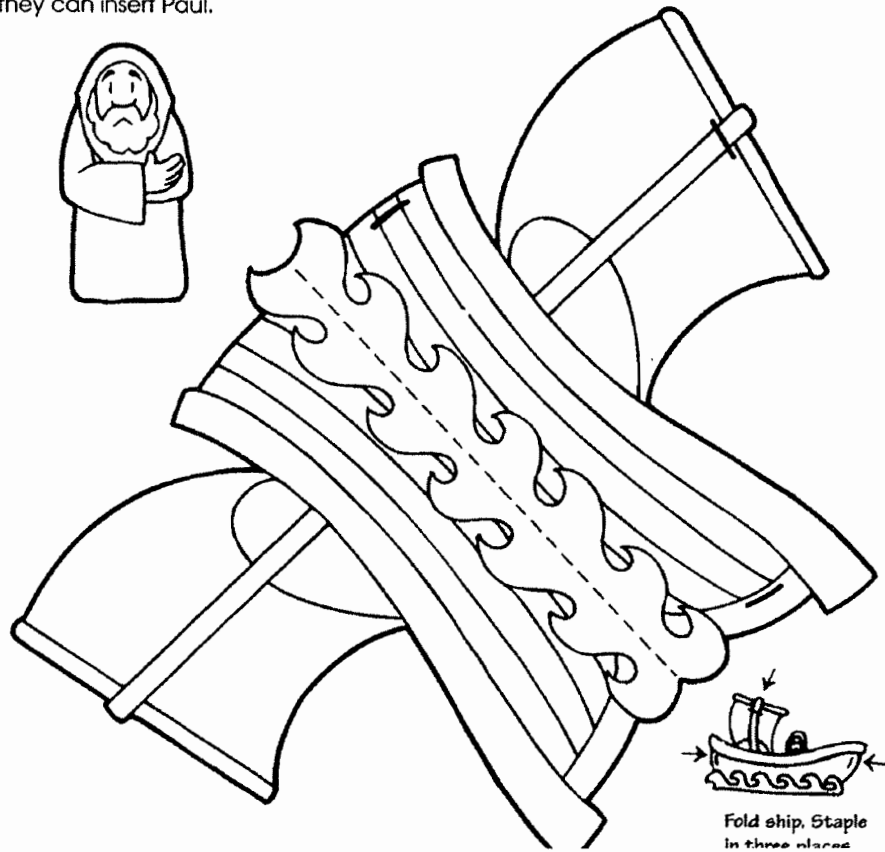

Fold ship. Staple  
in three places

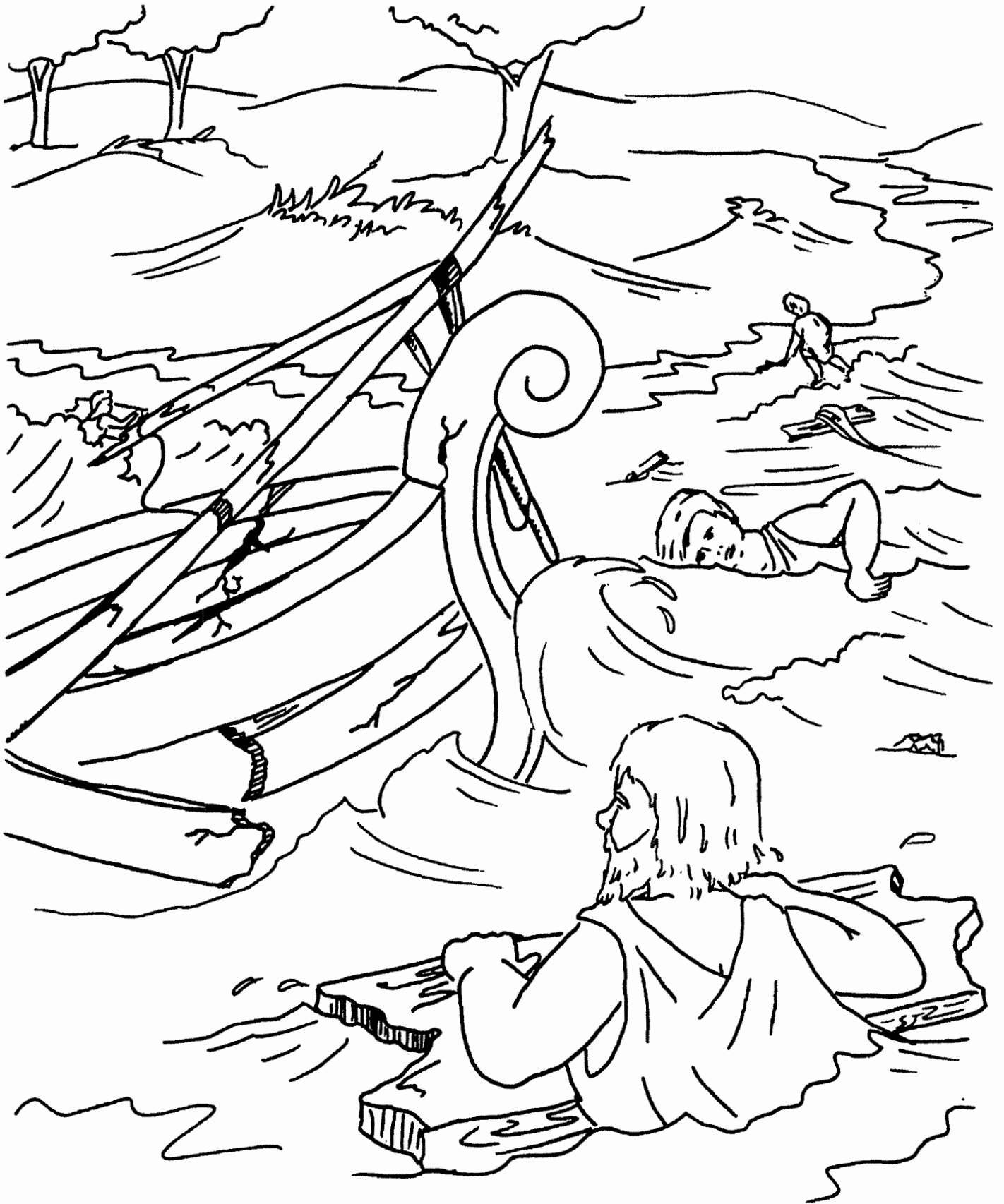

"While on the way to Rome, a great storm arose, and Paul and the other prisoners were commanded to jump overboard and swim to land."  
Acts 27:13-28:16

**Scriptures: Acts 28**

**Key Verse: Ac 28:25, 26** So when they did not agree among themselves, they departed after Paul had said one word: "The Holy Spirit spoke rightly through Isaiah the prophet to our fathers "saying, 'Go to this people and say: "Hearing you will hear, and shall not understand; And seeing you will see, and not perceive,"

**Key Points:**

1. Paul reaches land safely. They were on the island of Malta. The islanders there showed much kindness and built a fire for those shipwrecked to warm themselves. Paul was bitten by a viper that came out of from the fire. It fastened itself on his hand. When the islanders saw this, they expected him to die. When he did not, they thought he must be some kind of a god.
2. The chief of the island invited those shipwrecked to his estate. His father was sick. Paul went to see him, laid his hands on him then prayed over him. The man was cured and other sick and afflicted came to Paul and were healed as well. The islanders treated Paul and the others well, providing their supplies when they left.
3. After 3 months on the island, they left on a ship that had wintered on the island. Brethren heard they were coming and came to meet them. At the sight of these men, Paul was encouraged. Paul was allowed to live under house arrest.
4. After 3 days in Rome, Paul gathered the Jewish leaders together. He wished to speak to them about why he was imprisoned and how he appealed to Caesar. He also wanted them to know that he had done nothing against the Jews and his own people. Others met Paul even in larger numbers. He tried to convince them about Jesus. Some believed, but others would not listen.
5. Paul stayed in Rome for 2 years. He was able to stay in his own rented home while waiting for trial. He welcomed many into his house and preached the Lord to all who came.

## 270. PAUL'S MINISTRY IN ROME (ACTS 28:17-31)



"And when they had appointed him a day, there came many to him into *his* lodging; to whom he expounded and testified the kingdom of God, persuading them concerning Jesus, both out of the law of Moses, and *out of* the prophets, from morning till evening."

**ACTS 28:23**

**Paul's Journey  
to Rome  
Acts 27, 28**

# Safe From the Storms

.....

Paul was on a ship sailing for Rome when a terrible storm hit. Find your way through the maze to find out what happened to Paul.

.....

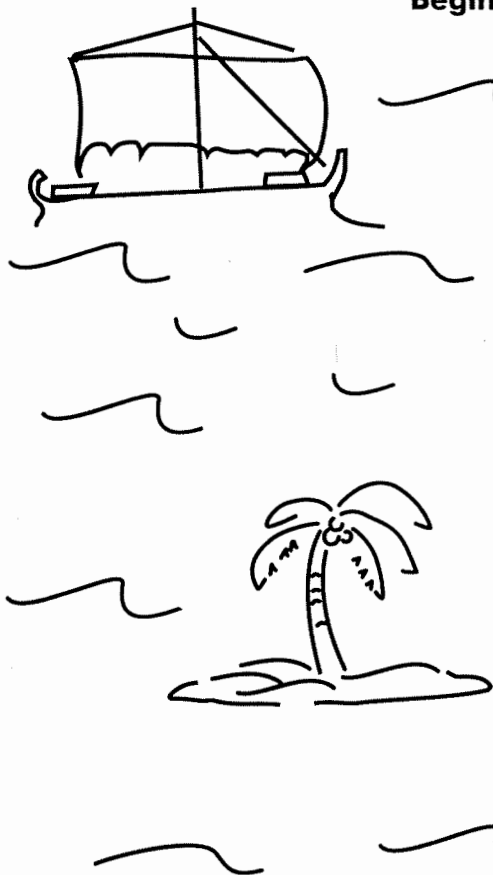

**Begin**

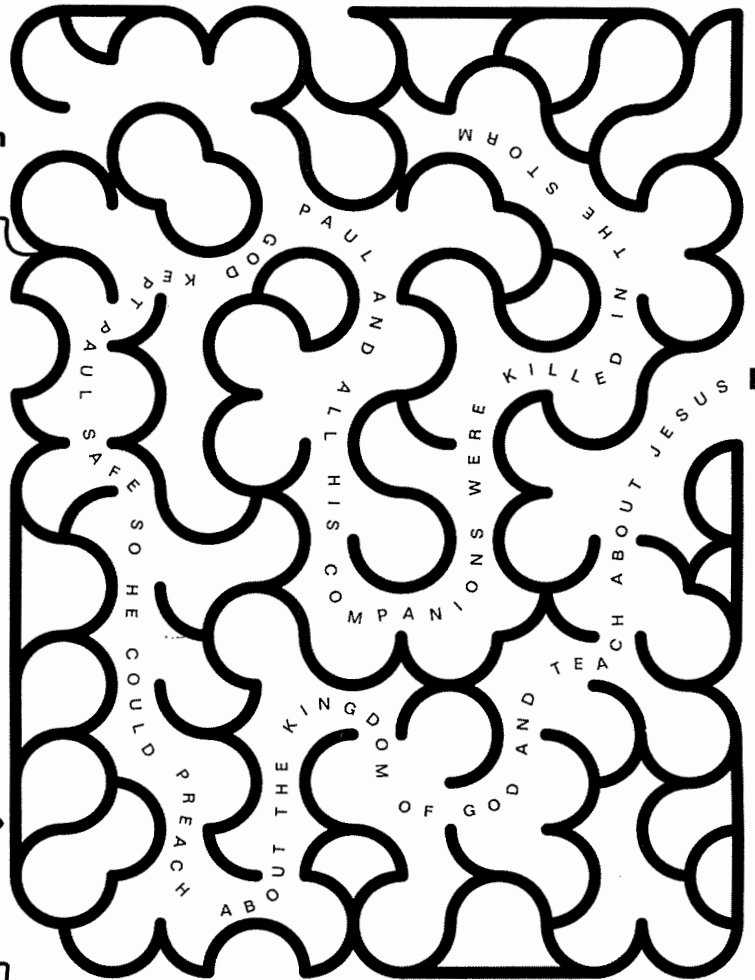

**Rome!**

# 270. PAUL'S MINISTRY IN ROME

(ACTS 28:17-31)

S U S J U D K A D C J K B L M  
A D U U E D I V A O O K V U S  
L S H O C O J E Y T G A Q G E  
V J P E N K S D Y C H A I N L  
A H D E D A U S R E P T D I I  
T Q E P R Q W Q D V U W V H T  
I O V T Q A I S A I A H S C N  
O E A C L K S E J R G L M A E  
N D E V E I L E B S I D C E G  
V W R S L R E N O S I R P R B  
M E S T E H P O R P F A E P N  
F P A U L L U N I F K P M T O  
H O L Y S P I R I T D P O M B  
S B L C K W E R P E B A R O U  
W K W H G N I H C A E T Z E L

CAESAR  
CHAIN  
DISBELIEVED  
GENTILES  
GOD  
HOLY SPIRIT

ISAIAH  
LAW  
PAUL  
PERSUADED  
PREACHING

PRISONER  
PROPHETS  
ROME  
SALVATION  
TEACHING

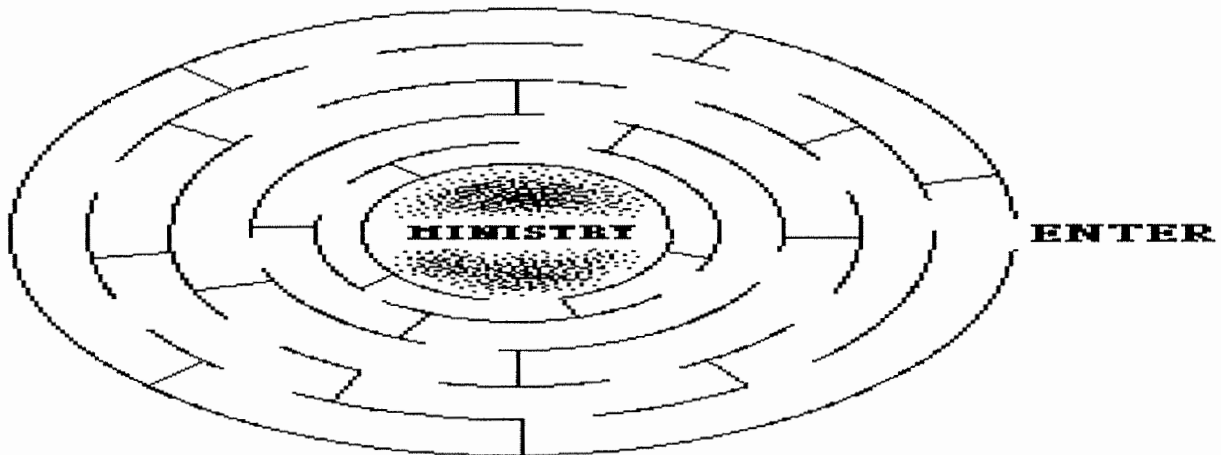



## 270. PAUL'S MINISTRY IN ROME (ACTS 28:17-31)

### MEMORY VERSE:

*"Therefore let it be known to you that the salvation of God has been sent to the Gentiles, and they will hear it."* ACTS 28:28

### TRUE OR FALSE:

1. "It came to pass after three days that Paul called the leaders of the Jews together..."  
ACTS 28:17

TRUE OR FALSE

### FILL IN THE BLANK:

2. "For this reason therefore I have called for you, to see you and speak with you, because for the hope of Israel I am bound with this \_\_\_\_\_." ACTS 28:20

### TRUE OR FALSE:

3. "They said to him, 'We neither received letters from Judea concerning you, nor have any of the brethren who came reported or spoken evil of you.'" ACTS 28:21

TRUE OR FALSE

### FILL IN THE BLANK:

4. "So when they had appointed him a day, many came to him at his lodging, to whom he explained and solemnly \_\_\_\_\_ of the kingdom of God, persuading them concerning Jesus from both the Law of Moses and the Prophets, from morning till evening." ACTS 28:23

### TRUE OR FALSE:

5. "And some were persuaded by the things which were spoken, and some disbelieved."  
ACTS 28:24

TRUE OR FALSE

### FILL IN THE BLANK:

6. "Therefore let it be known you that the \_\_\_\_\_ of God has been sent to the Gentiles, and they will hear it!" ACTS 28:28

### TRUE OR FALSE:

7. "Then Paul dwelt two whole years in his own rented house, and received all who came to him, preaching the kingdom of God and teaching the things which concern the Lord Jesus Christ with all confidence, no one forbidding him." ACTS 28:30-31

TRUE OR FALSE

# Unstoppable Paul!

Roman officials kept Paul under house arrest for two years. But being under arrest didn't stop Paul! He taught his visitors, he preached to his guards, he wrote letters that we are still reading today!

Copy all the capital letters from the guards uniforms onto the spaces below. Start on the left and read from bottom to top. Then move to the next panel and do the same thing. Then you will have a message about Paul.



-----

-----

-----

-----

## 270. PAUL'S MINISTRY IN ROME (ACTS 28:17-31)

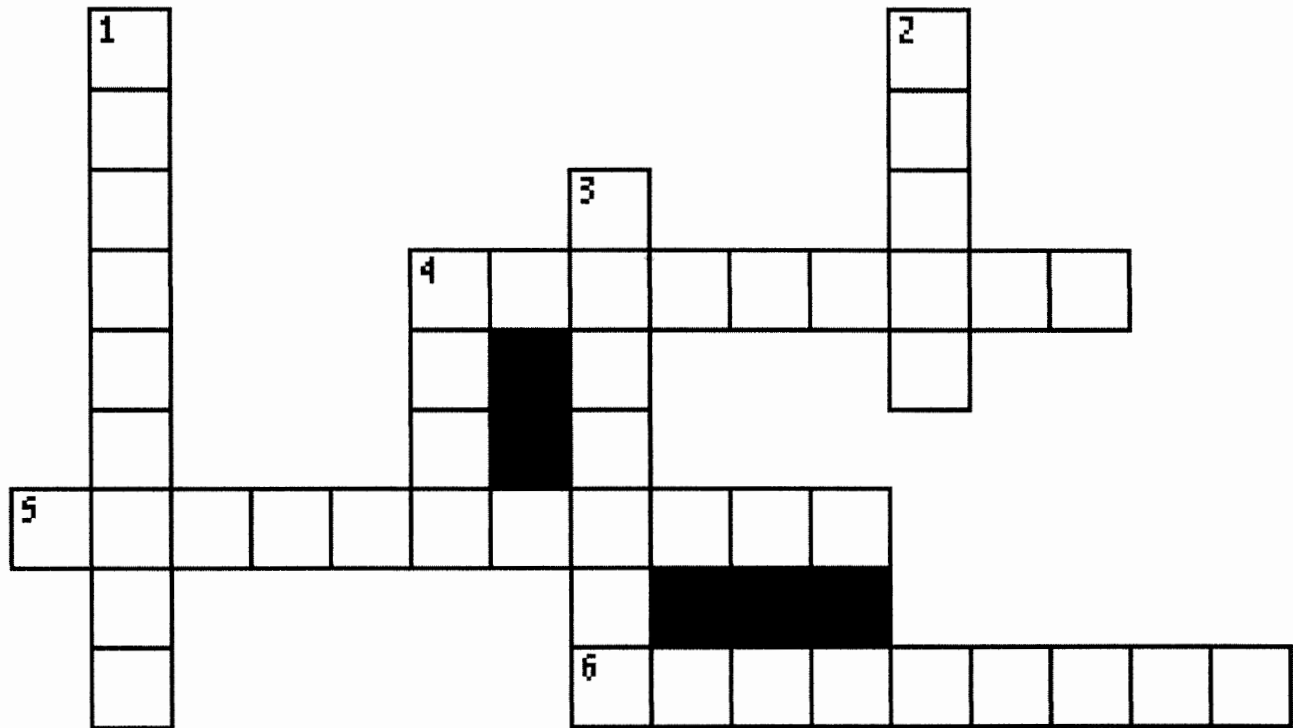

- 4 DOWN "It came to pass after three days that \_\_\_\_\_ called the leaders of the Jews together..." **ACTS 28:17**
- 2 DOWN "For this reason therefore I have called for you, to see you and speak with you, because for the hope of Israel I am bound with this \_\_\_\_\_." **ACTS 28:20**
- 3 DOWN "They said to him, 'We neither received \_\_\_\_\_ from Judea concerning you, nor have any of the brethren who came reported or spoken evil of you.'" **ACTS 28:21**
- 1 DOWN "So when they had appointed him a day, many came to him at his lodging, to whom he explained and solemnly \_\_\_\_\_ of the kingdom of God, persuading them concerning Jesus from both the Law of Moses and the Prophets, from morning till evening." **ACTS 28:23**
- 5 ACROSS "And some were persuaded by the things which were spoken, and some \_\_\_\_\_." **ACTS 28:24**
- 6 ACROSS "Therefore let it be known you that the \_\_\_\_\_ of God has been sent to the Gentiles, and they will hear it!" **ACTS 28:28**
- 4 ACROSS "Then Paul dwelt two whole years in his own rented house, and received all who came to him, \_\_\_\_\_ the kingdom of God and teaching the things which concern the Lord Jesus Christ with all confidence, no one forbidding him." **ACTS 28:30-31**

### Paul a Prisoner in Rome

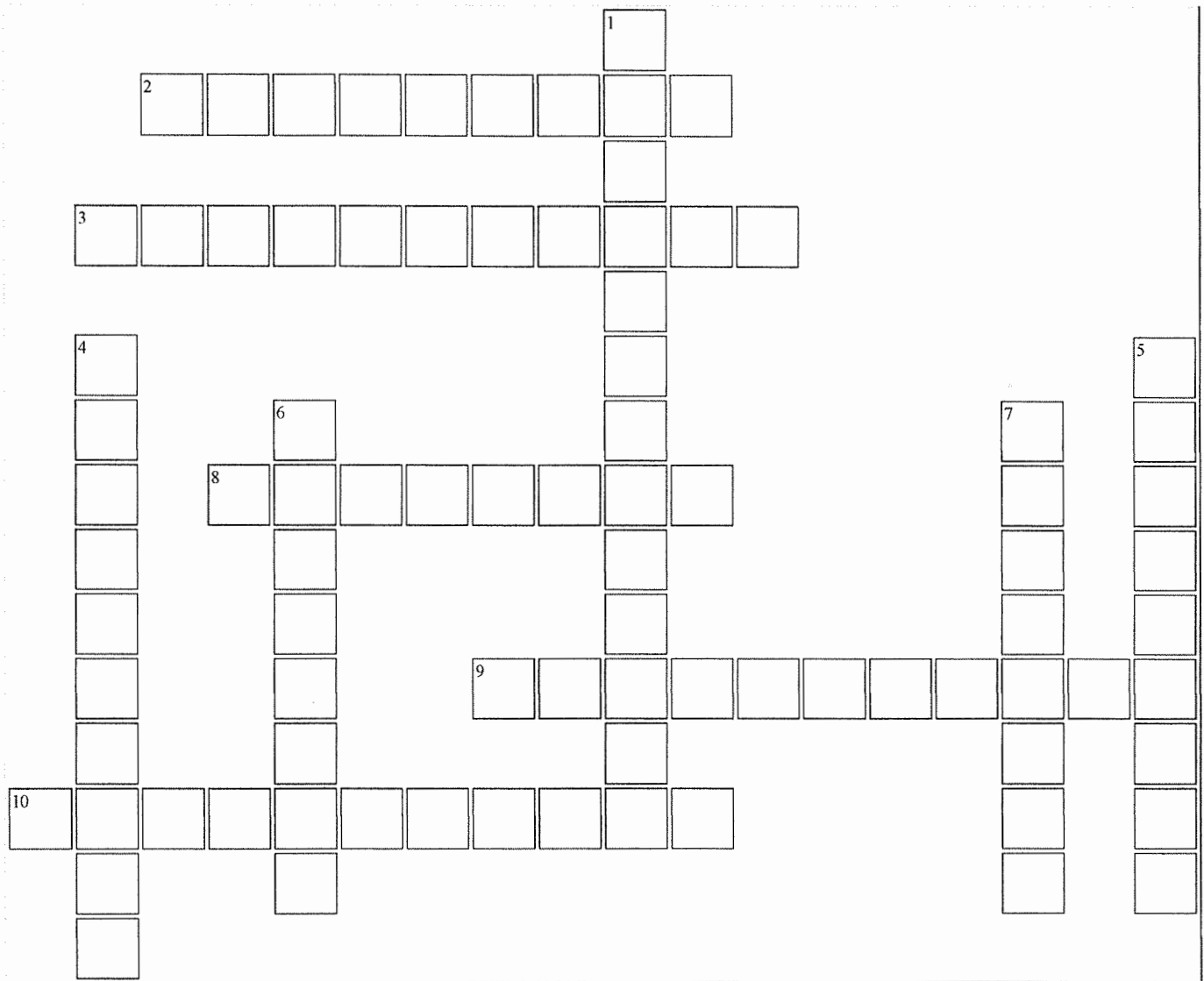

**Across**

- 2. Some of the people were \_\_\_\_\_, but others did not believe.
- 3. The Christians suffered \_\_\_\_\_ in Rome.
- 8. According to history Paul was \_\_\_\_\_.
- 9. \_\_\_\_\_ had written about Jesus years before.
- 10. In Rome Paul was put under \_\_\_\_\_.

**Down**

- 1. He called for the \_\_\_\_\_ and told them his story.
- 4. Paul talked to the people \_\_\_\_\_.
- 5. a large structure in Rome
- 6. The leaders \_\_\_\_\_ a chance to talk to him.
- 7. the length of Paul's stay in Rome

WORD BANK: HOUSE ARREST, JEWISH LEADERS, THE PROPHETS, CONVINCED, TWO YEARS, BEHEADED, COLOSSEUM, PERSECUTION, ALL DAY LONG, WELCOMED

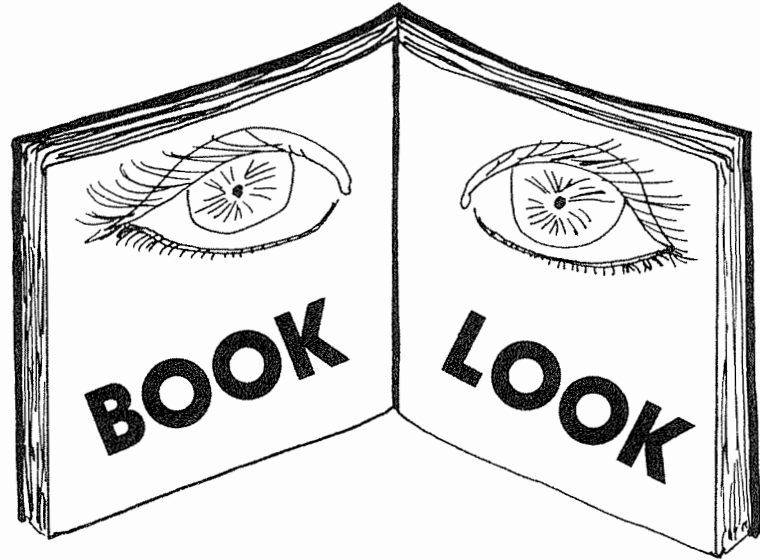

Read up, down, forward, backward, or diagonally to find these New Testament books:

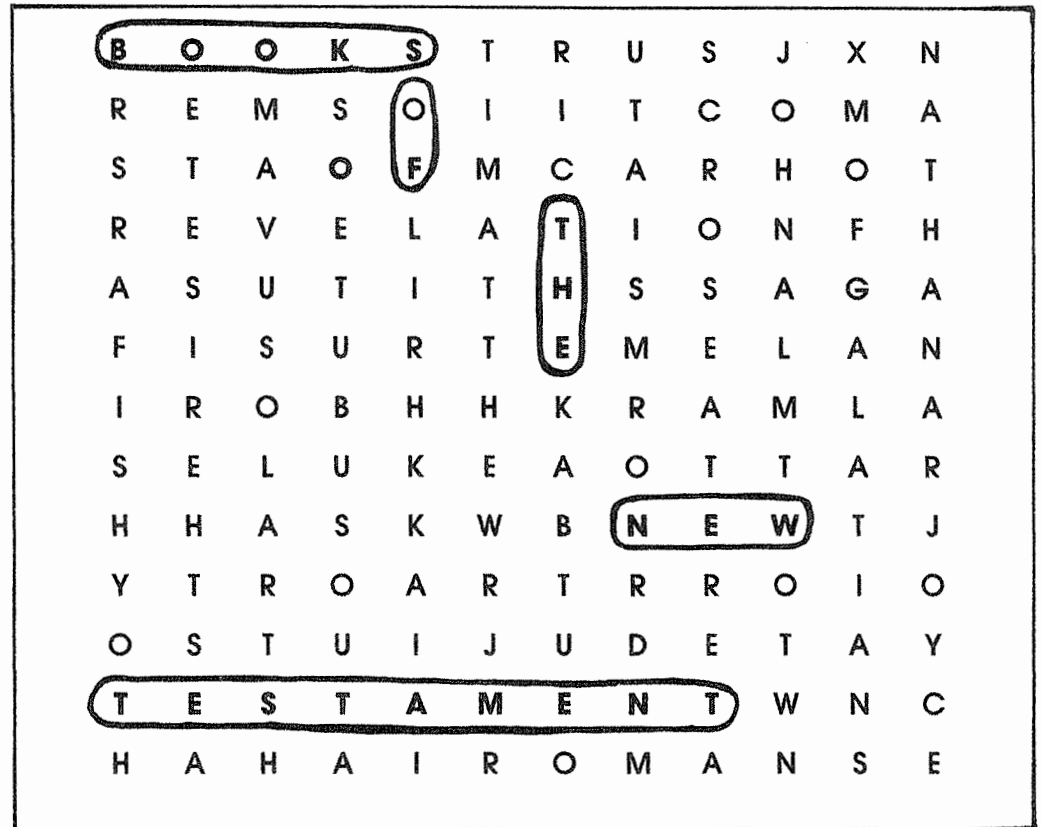

Acts  
Galatians  
Revelation  
Titus

John  
Matthew  
Luke  
Mark

Jude  
Hebrews  
James  
Romans