

Year 1

Week 42

The First Priest

Scriptures: Exodus 28, 39 also Leviticus 8-10

Key Verse: Leviticus 10:3 “By those who come near Me I must be regarded as holy; And before all the people I must be glorified.”

Key Points:

1. The high priest was to perform the sacred duties in the tabernacle. They were to perform sacrifices and offerings for the sins of the people. He was a mediator between God and the children of Israel.

2. God gave Moses very specific instructions for the anointing of the high priests as well as for making of the holy garments they were to wear. Aaron, Moses brother, and his sons were to do these tasks. Priesthood was set in the tribe of Levi from which Aaron descended.

3. Artisans made the holy garments. Explain the details of the breastplate, ephod, robe, woven tunic, turban and sash-what they were made from and how they were made. The materials for these were also free-will gifts brought from the Israelites, as for the tabernacle.

4. Sons of Aaron, Nadab and Abihu, were killed by fire for their sins for offering profane fire. God’s commandments concerning the high priests and the sacredness of the tabernacle were to be followed strictly. We also should worship in the way God has asked.

5. Christ is our high priest. He offered his own blood, once for all. He became the mediator between us and God.



'High Priest' ©Terry Tavlör Illustrated by Brian W.

THE HIGH PRIEST AND HIS GARMENTS

Mitre

Breastplate

Girdle

Ephod

Robe

Embroidered
Coat

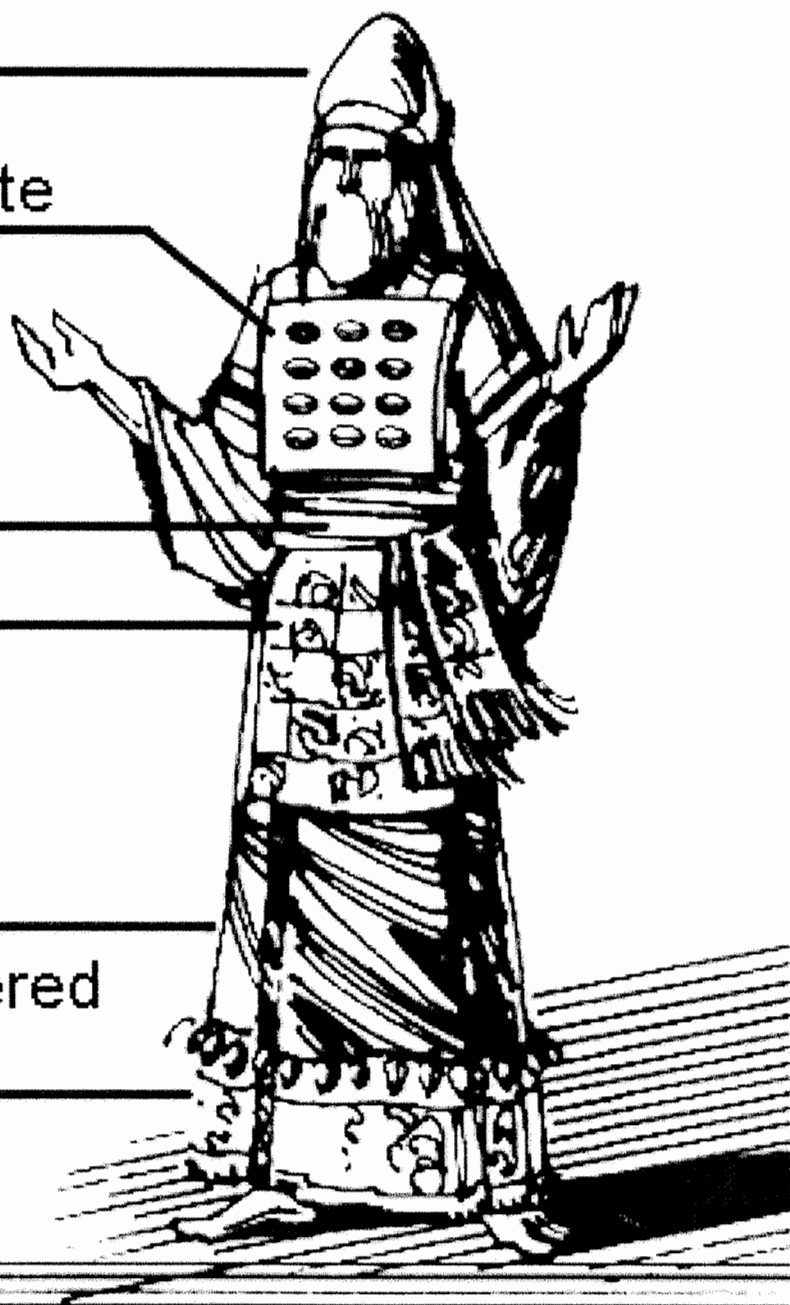

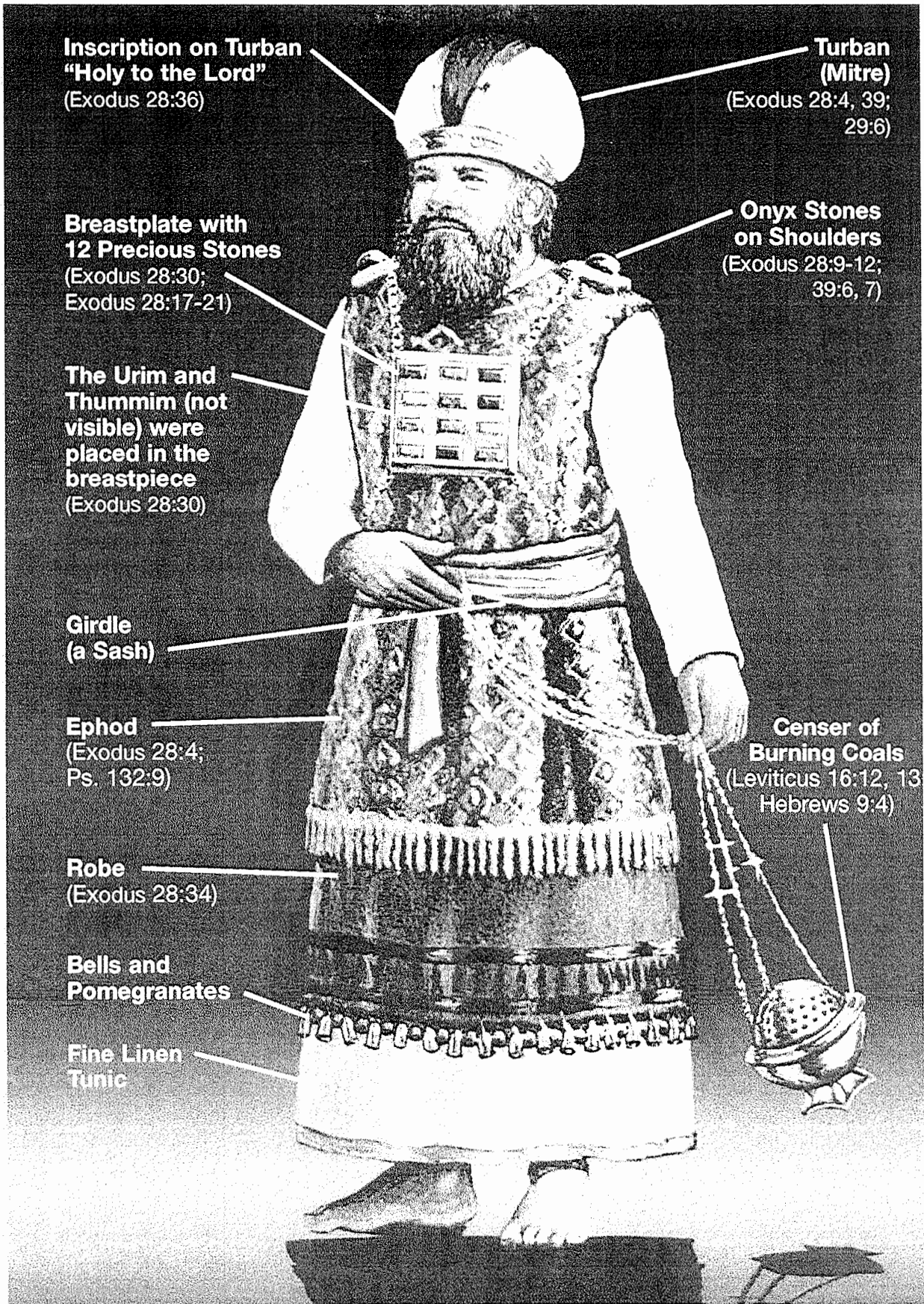

**Inscription on Turban
"Holy to the Lord"**
(Exodus 28:36)

**Turban
(Mitre)**
(Exodus 28:4, 39;
29:6)

**Breastplate with
12 Precious Stones**
(Exodus 28:30;
Exodus 28:17-21)

**Onyx Stones
on Shoulders**
(Exodus 28:9-12;
39:6, 7)

**The Urim and
Thummim (not
visible) were
placed in the
breastpiece**
(Exodus 28:30)

**Girdle
(a Sash)**

Ephod
(Exodus 28:4;
Ps. 132:9)

**Censer of
Burning Coals**
(Leviticus 16:12, 13
Hebrews 9:4)

Robe
(Exodus 28:34)

**Bells and
Pomegranates**

**Fine Linen
Tunic**

High Priest, and his garments of glory and beauty.

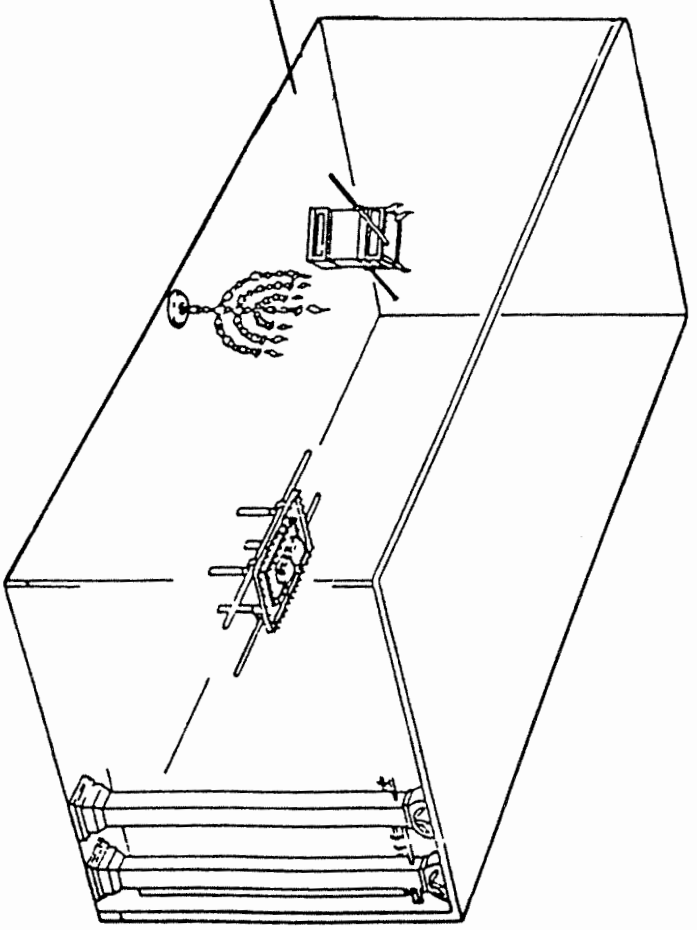
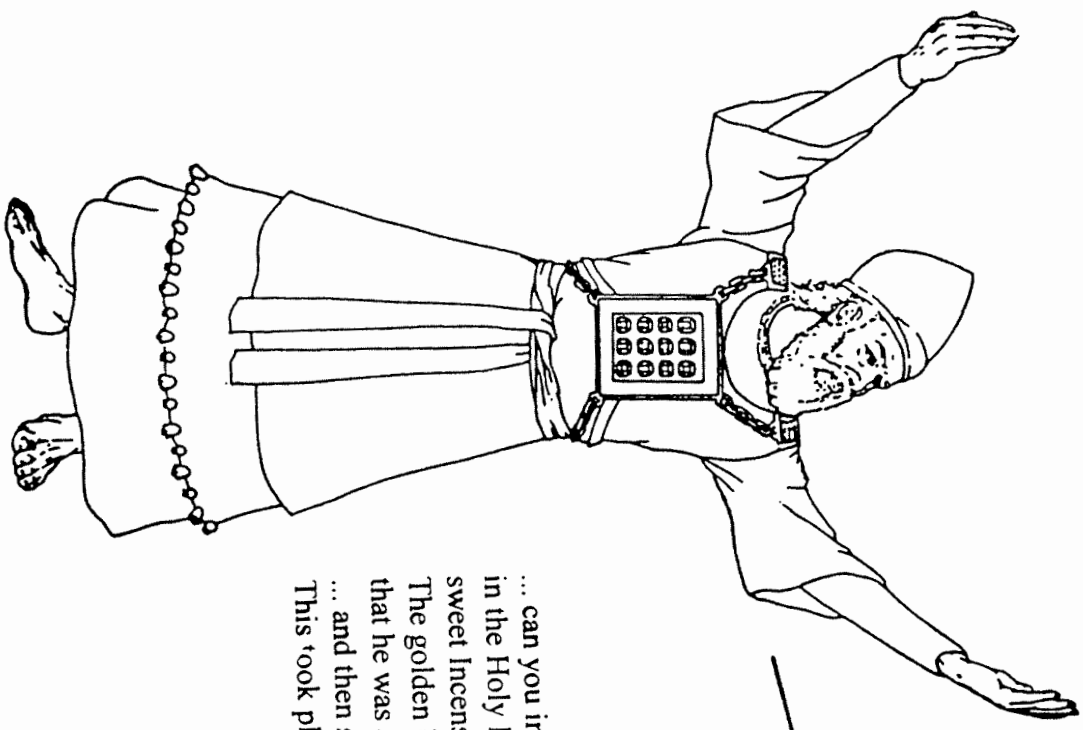

... can you imagine the high priest going about his daily service in the Holy Place, arranging the bread on the Table, burning the sweet Incense, and dressing the Lamps. The golden bells on the hem of his robe, sent up a glorious sound that he was about his Father's business! ... and then **suddenly! God, Himself rent the veil in two!** This took place in the temple. Jn.2:20-22; Mt.27:51,52

Heb.8:1

“We have such an high priest, who is set on the right hand of the throne of the Majesty in the heavens;”

Heb.10:12; 12:2; Eph.1:20; Col.3:1

Locate the high priest in the Holy Place on pg. 14

High Priest and His Garments of Glory and Beauty is a type of Christ
our Great High Priest High and Exalted
Seven articles of clothing,
seven speak of Divine Perfection.

1. Breeches, (White Linen) speak of The Perfect Provision God has made for us in Christ.
 – with the Girdle, (Plain) speaks of Service.
2. Coat, (White linen) speaks of The Righteousness and Spotless Purity of Christ.
3. Robe, (blue) speaks of The Divinity of Christ.
 – Pomegranates, (Blue, purple and scarlet) speak of Fruitfulness.
 – Bells, (Golden) speak of Testimony and Praise.
4. Ephod, (Gold, blue, purple and scarlet) speaks of The Position, Office and Character of Jesus Christ.
5. Breastplate, (Gold, blue, purple, scarlet) speaks of Jesus the Loving One.
 – Stones, are a type of believers.
 – Urim and Thummim, speak of Jesus the Light, Perfection, Illumination and Truth.
 – Shoulder Stones.
 – Shoulders, speak of Strength (or Power).
6. Curious Girdle, (Gold, blue, purple, scarlet) speak of A Gathering (Binding) Together.
7. Miter, (Fine white linen) speaks of The Authority of Jesus Christ.
 – Golden Plate, with the inscription upon it **“Holiness unto the Lord”**

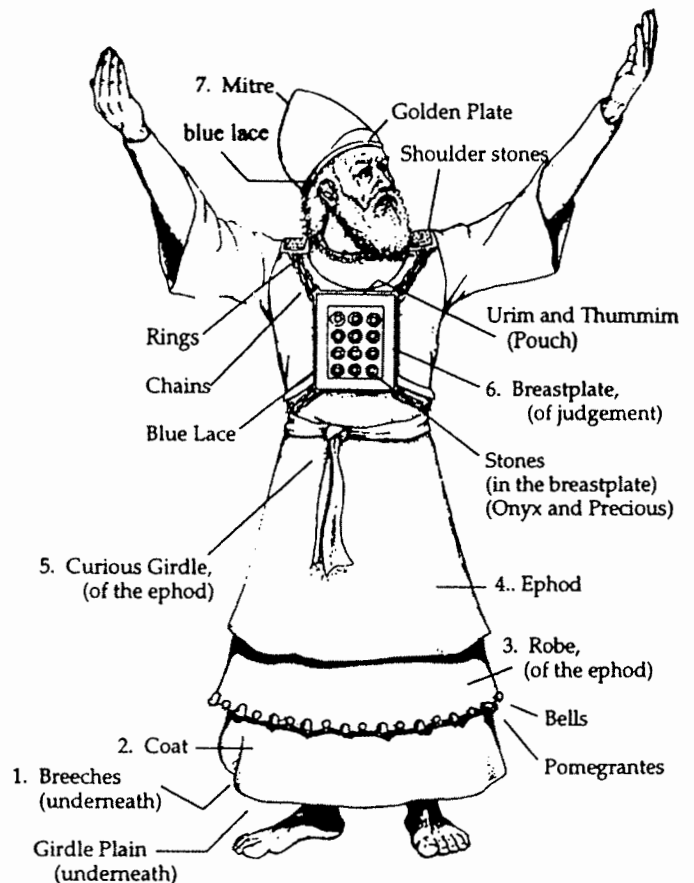

Locate the **only place** in the Tabernacle Proper where the **high priest** served when he wore his **seven piece garments of glory and beauty** on Pg.14

Name: _____

Date _____

The Priests and the Tabernacle

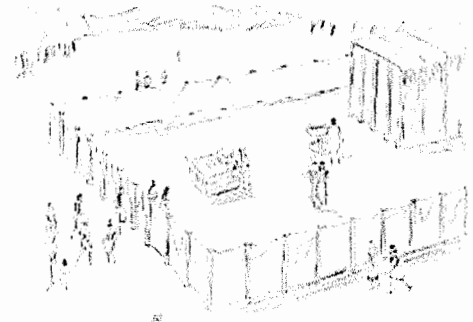

sweetpublishing.com (CC BY-SA 3.0)

1. _____ the priestly garments were made from blue, purple and _____ yarn
2. _____ box with golden cherubim on the lid
3. _____ how many lamps did the lampstand have?
4. _____ the number of precious stones in the priest's breastpiece
5. _____ the inscription on the plate on the priest's turban: _____ to the Lord
6. _____ one of the colors of the tabernacle curtains
7. _____ attached to the hem of the priest's tunic
8. _____ the _____ of the Lord filled the tabernacle
9. _____ what were the utensils for the altar made from?
10. _____ a type of tent

1. tabernacle
2. purple
3. ark

4. seven
5. bronze
6. scarlet

7. twelve
8. pomegranates
9. holy

10. glory

Name: _____

Date: _____

The Priests and the Tabernacle



sweetpublishing.com (CC BY-SA 3.0)

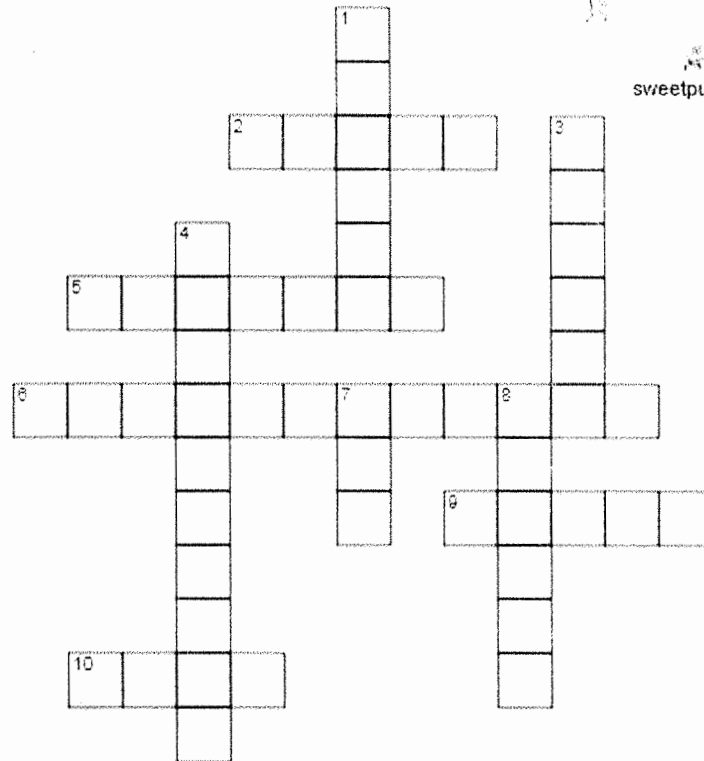

ACROSS

2. the ___ of the Lord filled the tabernacle
5. the priestly garments were made from blue, purple and ___ yarn
6. attached to the hem of the priest's tunic
9. how many lamps did the lampstand have?
10. the inscription on the plate on the priest's turban: ___ to the Lord

DOWN

1. what were the utensils for the altar made from?
3. one of the colors of the tabernacle curtains
4. a type of tent
7. box with golden cherubim on the lid
8. the number of precious stones in the priest's breastpiece

God Led Them

N	C	H	I	L	D	R	E	N	M	A	C	W	C	L	O	U	D
G	G	T	R	U	F	I	R	E	Y	N	T	F	A	Y	F	C	E
L	M	N	A	A	N	G	T	N	I	O	N	A	F	E	F	A	S
A	S	E	I	L	N	I	C	A	N	M	A	F	A	M	E	N	N
L	R	C	C	T	T	A	C	J	C	A	E	N	L	N	R	D	E
C	F	F	I	A	S	A	C	O	Y	C	D	T	D	D	I	L	C
L	R	H	T	R	S	A	R	L	R	R	L	T	R	E	N	E	N
I	Y	R	L	S	C	Y	L	C	E	C	O	A	L	H	G	S	I
M	S	A	T	T	A	B	E	R	N	A	C	L	E	S	I	T	C
W	O	T	C	H	Y	R	C	N	E	Y	R	M	A	A	R	I	Y
R	T	J	N	Y	R	O	L	G	R	V	F	S	O	W	T	C	G
F	K	W	Y	E	S	A	T	A	C	U	E	I	I	S	G	K	Y
F	N	R	I	N	M	A	O	J	C	A	O	O	T	K	E	N	C
E	N	R	N	R	T	R	G	M	F	R	A	J	R	C	F	S	R
O	I	T	Y	Y	T	F	A	R	L	A	E	A	E	W	N	E	E
D	R	C	O	N	G	R	E	G	A	T	I	O	N	G	O	A	M
O	N	O	R	A	A	Y	E	C	O	L	O	A	N	F	E	R	S
R	T	A	N	M	Y	R	T	A	W	M	Y	R	N	R	T	S	N

3 Letters

ARK

4 Letters

FIRE

5 Letters

AARON
ALTAR
CLOUD
GLORY
MERCY
MOSES

6 Letters

ANOINT
ISRAEL
WASHED

7 Letters

INCENSE

8 Letters

CHILDREN
GARMENTS
JOURNEYS
OFFERING

SANCTIFY

10 Letters

TABERNACLE

11 Letters

CANDLESTICK
EVERLASTING

12 Letters

CONGREGATION